

UNIV. OF
TORONTO
LIBRARY

~~UNIVERSITY OF MICHIGAN~~
~~NOV 4 1916~~
~~MINNESOTA~~

1212

11 2
1 2

Digitized by the Internet Archive
in 2008 with funding from
Microsoft Corporation

<http://www.archive.org/details/miningscientific112sanfuoft>

ech
M.

Mining AND SCIENTIFIC Press

VOLUME 112



JANUARY to JUNE, 1916

40534
30/0/16

MINING AND SCIENTIFIC PRESS

420 MARKET STREET

SAN FRANCISCO, CALIFORNIA

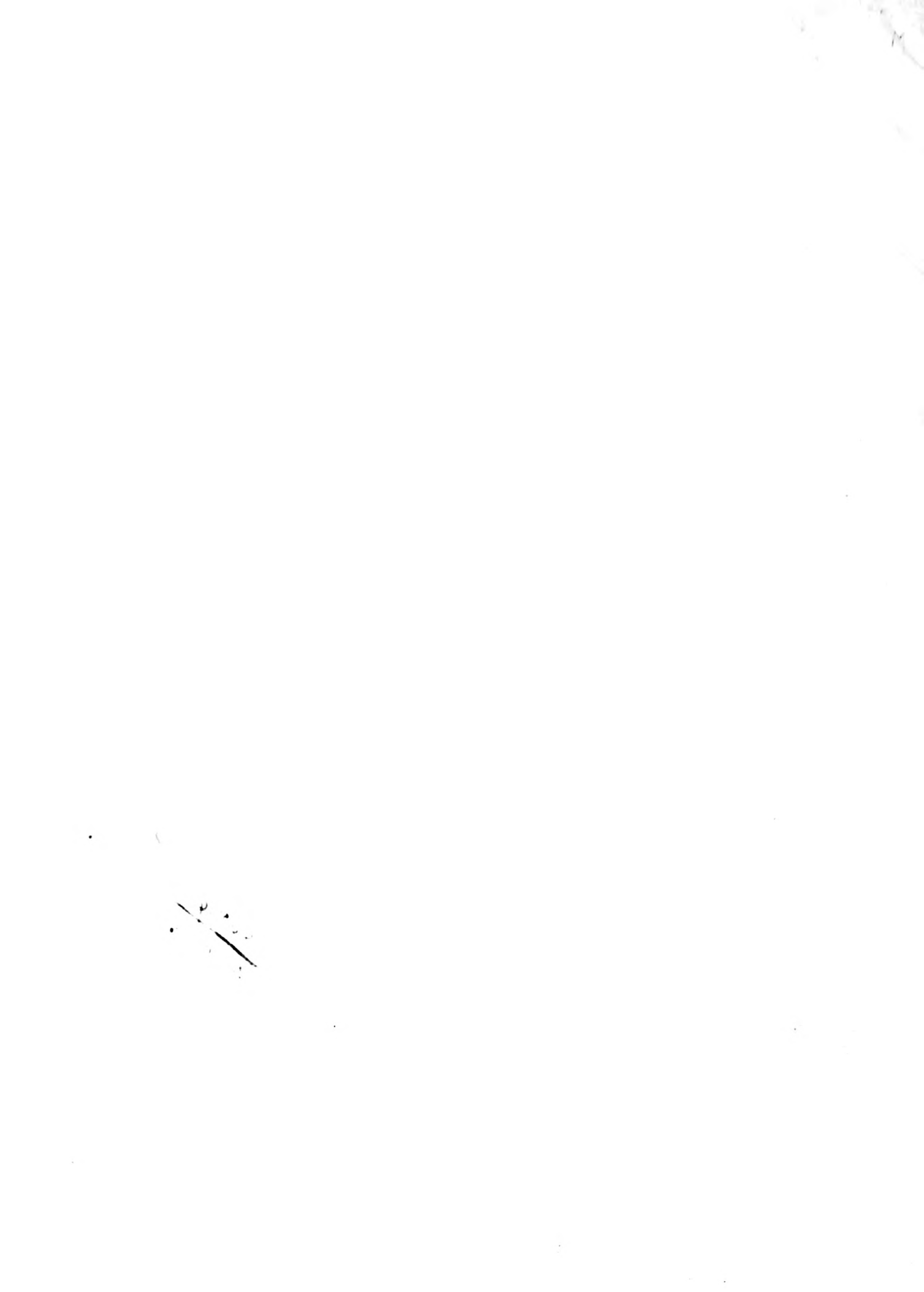

INDEX

| | Page. | | Page. |
|---|---|---|---|
| A | | Amador, Hayward's, Eureka, or Betty Green mine..... | 935 |
| Absentee ownership..... | 845 | Amador Consolidated Co., notes on old results..... | 937 |
| Absorb, definition of..... | 228 | Amalgamation, using cyanide to aid..... | 297 |
| Accident compensation..... | 279 | American boy and the mine..... | Albert Burch, 657 |
| In blasting at Brandy City, California..... | 25 | Ditto..... | Editorial, 656 |
| Insurance, mine..... | 463 | Ditto..... | D. M. Folsom, 813 |
| Ditto..... | Editorial, 541 | Capital on the Rand..... | Editorial, 163 |
| Ditto..... | Will J. French, 623 | Industry in foreign countries..... | 621 |
| Record of Pennsylvania railroad..... | Robert I. Kerr, 942 | Metal, foreign domination of..... | Editorial, 819 |
| Accidents at Anaconda..... | 942 | Patent laws..... | 749 |
| And miners at the Copper Queen mine..... | 450 | Potash..... | Carl Elschner, 155 |
| Artificial arm for..... | 679 | Rock-drills in Italy..... | 309 |
| At mines, law regarding..... | 561 | Youth and mining..... | Editorial, 656 |
| In Arizona in 1915..... | 642 | Americans and world view..... | 659 |
| In Rand mines, sources of..... | 780 | American Association of Engineers..... | Editorial, 774 |
| Mine..... | 300 | American Gold Dredging Co. takes over Oro company's property at Oroville..... | 568 |
| Percentage for various parts of the body..... | S. Adler and P. L. Hoffman, 297 | American Institute of Mining Engineers, copyrighted papers..... | 221 |
| Queer mine..... | P. B. McDonald, 244 | Abstracts from Bulletins..... | Frequent Issues, 773 |
| Account systems for small mines..... | James E. Chapman, 409 | Nevada section..... | Editorial, 799 |
| Acetylene, oxy., a big job with..... | 169 | American International Corporation, objects of..... | 549 |
| Acid flotation process..... | 471 | American Mining Congress..... | 617 |
| Making at Braden, Chile..... | 827 | American Rand Syndicate in the Transvaal..... | Editorial, 162 |
| Plant at Anaconda..... | 552 | And Bunker Hill & Sullivan contract..... | 609 |
| Porphyry, copper in..... | 666 | Company report..... | 574 |
| Production of Tennessee Copper Co..... | 768 | New tin smelter at Perth Amboy..... | 152 |
| Sludge in flotation..... | 869 | Smelter at Tacoma complete..... | 254 |
| Acids + bases form salts..... | 893 | Work in Mexico..... | 145 |
| Acme mine, Porcupine, Ontario..... | 922 | American Telephone & Telegraph Co., company report..... | 614 |
| Acre, area of..... | 173 | American Tungsten Consolidated Co..... | 69 |
| Adjustment of fire losses..... | 933 | American Zinc, Lead & Smelting Co..... | Editorial, 537 |
| Adler, S., and Hoffman, P. L..... | Mine accidents, 297 | Company report..... | 691 |
| Adsorption, definition of..... | 228, 310, 314 | Purchases Granby properties..... | Editorial, 926 |
| Aerial tramways, new..... | 74 | Ammonial..... | 33 |
| After All Mines Co., Tonopah..... | 839 | Composition of..... | 118 |
| After the War—I, II..... | Editorial, 395, 439 | Amparo Mining Co..... | 727 |
| Agitation, definition of..... | 228 | Amxgdaloid, banket, conglomerate..... | 96 |
| Agitator-filter, Bunker Hill..... | 781 | Copper deposits..... | 668 |
| Agitators, notes on..... | 518 | Anaconda Copper Mining Co..... | Editorial, 295, 692 |
| Ahmceek Mining Co., company report..... | 923 | Accidents at..... | 459 |
| Aids to success..... | Editorial, 735 | Company report..... | 767 |
| Ditto..... | P. B. McDonald, 779 | Electrolytic zinc production..... | 139 |
| Air-blasts on the Rand..... | 394 | Progressiveness of..... | 295 |
| Compression of develops heat..... | 173 | Washoe reduction works—I, II, III..... | L. S. Austin, 195, 304, 547 |
| Lift in leaching, the..... | Clarke Sullivan, 117 | Water concentration before flotation at..... | Frederick Laist and Albert E. Wiggin, 446 |
| Lift submergence..... | 564 | Analysis for tungsten, quantitative..... | 592 |
| Lifts, notes on..... | 380, 602 | Of ores at International smelter, Miami..... | 822 |
| Lifts raising oil..... | 679 | Of slaby slag..... | 508 |
| Ajo, Arivaca, Babquivari, Old Hat, Patagonia, and Twin Buttes districts of Arizona..... | 449 | Of Sudbury ore..... | 585 |
| Alaska, copper production of..... | 638 | Of water of Owen's Lake, California..... | 155 |
| In 1915, inspector's report..... | 487 | Andes Copper Co..... | 286 |
| In 1915, mining in..... | Alfred H. Brooks, 51 | Andes Copper Mining Co..... | 186, 286 |
| Metal production to date..... | 912 | Andesites at Oatman..... | 815 |
| Mineral production in 1915..... | 756 | Andrada Mines, Ltd., dredging by..... | 43 |
| Railroad, progress of..... | 876 | Ankylostoma duodenale..... | 511 |
| Requisites for placer location in..... | 964 | Another Mexican outrage..... | Editorial, 56 |
| Surveys in 1916..... | 453 | Anthracite production of U. S. in 1915..... | 671 |
| Trade in 1915..... | 352 | Antimony..... | Editorial, 34 |
| Wireless in..... | 722 | Notes and prices of..... | Every Week, 328 |
| Alaska Gastineau Mining Co., company report..... | 655 | "Crude" and "regulus"..... | 497 |
| Concentrate, metal contents of..... | 506 | Demand and prices..... | 59 |
| Gold yield, once a month..... | 420 | Gold ore, treatment of..... | Wm. Seward Mann, 433 |
| Mine developments..... | 647 | Ditto..... | F. H. Mason, 512 |
| Alaska Gold-Belt and Alaska Taku suit..... | 4 | Ditto..... | F. H. Mason, a correction, 624 |
| Alaska Gold Mines Co..... | 39 | Ditto..... | T. W. Groutter, 582 |
| Ditto..... | John Worden, 39 | Imports in 1915..... | 52 |
| Company report..... | 655 | In Alaska..... | 52 |
| Issues new stock..... | 179 | In California..... | P. L. Cole, 291 |
| Starts monthly reports..... | 141 | In China..... | 142 |
| Alaska Juneau Gold Mining Co., company report..... | 731 | In Nevada..... | 187 |
| Court decision in favor of..... | 964 | In 1915..... | 369, 371, 372 |
| Progress..... | 23 | Meaning of terms applied to metal..... | 35 |
| Alaska Mexican Gold Mining Co., company report..... | 963 | Metallurgy of..... | 337 |
| Alaska Treadwell Gold Mining Co., company report..... | 963 | Mining in Hunan, China..... | Every Week, 101 |
| Alaska Treadwell, Mexican, and United mines to be consolidated..... | 577 | Ore, price of..... | 187 |
| Alaska United Gold Mining Co., company report..... | 963 | Sale of in Alaska..... | 35 |
| Alcohol, use in war..... | 221 | Smelters in U. S..... | 123 |
| Alkalinity, effect on flotation..... | 59 | Smelting..... | 556 |
| Of cyanide solutions..... | Alfred Merritt Smith, 828 | Smelting in London..... | 508 |
| Allen, A. W..... | Clay: Its effect in ore-dressing and cyanidation, 310 | Veins at Bernice, Nevada..... | Willard Malbery, 225 |
| Allen, Glenn L., and Ralston, O. C..... | Testing ores for the flotation process, 44 | Antimonial lead..... | 899 |
| Allingham, John..... | Estimating slime, 504 | Apex dispute, settlement of..... | 593 |
| Allowez Mining Co., company report..... | 923 | Law in Rhodesia..... | Editorial, 774 |
| Alloys..... | 136 | Law of history, of, etc..... | 321 |
| Alluvial ground in Alaska, testing..... | 627 | Rights, waiver of..... | 723 |
| Alta-Cottonwoods district, Utah..... | 27 | Suit between North Star and Empire, Grass Valley..... | 8 |
| Alta Tunnel & Transportation Co..... | 767 | App, Dutch, and Sweeney mines development..... | 156 |
| Alternators, belted..... | 59 | Apparatus for testing ores by flotation..... | B. Read, 466 |
| Altitude, gas-engine power at..... | 312 | Appraisal of mining stock..... | For insurance, 574 |
| Aluminum, notes and prices of..... | Every Week, 641 | Argall, Philip, and metallurgical progress—An interview..... | T. A. Rickard, 119 |
| And copper..... | 118 | Arko mill, Colo., refining at..... | 270 |
| Dust..... | G. H. Clevenger, 602 | Argonaut mine, California, notes on..... | 161 |
| Dust, cost of..... | 190 | Arizona leads in copper production..... | 31 |
| Dust manufacture in Oakland, California..... | 173 | Metal output in 1915..... | Charles F. Willis, 171, 299, 947 |
| Effect of acid on..... | 428 | Mining in southern..... | Charles F. Willis, 556 |
| Imports in 1915..... | 32 | Notes on..... | Recent mine transactions in, 947 |
| Notes on..... | 962 | | |
| Production of U. S. in 1915..... | 468 | | |
| Alunite in Utah..... | L. O. Howard, 468 | | |

| | Page | | Page |
|--|------|---|------|
| Cassel Cyanide Co. | 854 | Collolds | 851 |
| Cassel Gold Extracting Co., notes on | 851 | In flotation work, study of | 851 |
| Cassiterite, test for | 417 | Their behavior | 851 |
| Cattermole, Arthur E., Flotation patent | 472 | Use of term | 851 |
| Caustic soda from salt | 134 | Colloidal clay | 912 |
| Process for antimony-gold ore | 236 | Colombia, platinum output of | 906 |
| Caving in mines | 785 | Colombia, breaking in | 906 |
| Cell, electrolytic | 692 | Metal output in 1915 | 906 |
| Celluloid no good for mine models | 719 | Mining in | 906 |
| Cement and skin troubles | 413 | Notes on | 906 |
| From furnace slag | 902 | Some history of smelting in | 906 |
| Production of the United States | 923 | Timbsten ore treatment in | 906 |
| Centennial Copper Mining Co., company report | 601 | Colorado Consolidated Mining Co., Tinto, Utah | 821 |
| Central America, notes on | 236 | Colorado-Gilpin Gold & Refining Co., Forbes Park | 821 |
| Central mine, Broken Hill, flotation at | 821 | Colorado mine, Philippines, notes on | 821 |
| Central States, metal output of the | 348 | Colorado Scientific Society and flotation | 821 |
| Centrifugal pumps, and dirty water | 389 | Coloradoite and kaolinite | 821 |
| Notes on | 602 | Comacaran mine, Salvador, evaluation at the | 821 |
| On the Rand | 764 | A. B. Beckler | 821 |
| Cerro de Pasco, Peru | 288 | Combustion of coal, spontaneous | 819 |
| Cerro Gordo mines, California, progress at | 719 | Commerce district of Oklahoma | 819 |
| Chains, notes on | 670 | Commercial ore, use of term | 923 |
| Chalcocite | 395 | Company report, Almeck Mining Co. | 923 |
| Ore, flotation of | 364 | Alaska Gastineau Mining Co. | 923 |
| Chalocitization | 903 | Alaska Gold Mines Co. | 923 |
| Champion dry-house, Grass Valley | 109 | Alaska Juneau Gold Mining Co. | 923 |
| Champion Reef Gold Mining Co. of India, company report | 59 | Alaska Mexican Gold Mining Co. | 923 |
| Change-houses, necessity of | 222 | Alaska Treadwell Gold Mining Co. | 923 |
| Changing the mining law | 100 | Alaska United Gold Mining Co. | 923 |
| Chapman, James E., account systems for small mines | 295 | Albion Mining Co. | 923 |
| Chapman, G. A., flotation patent | 35 | American Smelting & Refining Co. | 693 |
| Chapman Smelting Co., San Francisco | 662 | American Zinc, Lead & Smelting Co. | 693 |
| Chapple, A. J., Treatment of slime-residue | 312 | American Telephone & Telegraph Co. | 693 |
| Chart for computing gas-engine horse-power | 225 | Anaconda Copper Mining Co. | 149 |
| Checking fraud | 225 | Arizona Goldfields Corporation | 149 |
| Chemical equations in leaching and enrichment of copper ores | 897 | Aurora Consolidated Mines Co. | 149 |
| Chemistry of cyanidation, notes on | 439 | Barnes-King Development Co. | 149 |
| Of electrolytic zinc | 854 | Bingham Mines Co. | 149 |
| Of the oxidized zone, surficial indications of copper—111 | 854 | Broken Hill Proprietary Co. | 149 |
| Frank H. Probert | 649 | Broken Hill South Silver Mining Co. | 149 |
| Chicago, Milwaukee & St. Paul railroad, electrification of | 324 | Brunswick Consolidated Gold Mining Co. | 149 |
| Chief Consolidated Mining Co., company report | 347 | Bunker Hill & Sullivan Mining & Concentrating Co. | 149 |
| Chihuahua, Mexico, treatment of silver ore in | 475 | Bunker Hill Mines Co. | 149 |
| Chile, mineral industry of | 341 | Burrow Mountain Copper Co. | 149 |
| Notes on | 603 | Butte, Anaconda & Pacific Railway Co. | 149 |
| Physical conditions of | 477 | Butte & Superior Copper Co. | 149 |
| Chile Copper Co., notes on | 891 | Calumet & Hecla Mining Co. | 149 |
| China and foreign enterprises | 369 | Centennial Copper Mining Co. | 149 |
| Antimony in | 790 | Chief Consolidated Mining Co. | 149 |
| Imports of | 337 | Chino Copper Co. | 149 |
| Metalliferous mines of Hunan Province | 393 | Connags Mines, Ltd. | 149 |
| New mining laws to be drafted | 809 | Consolidated Arizona Smelting Co. | 149 |
| Chinese coins, melting of for sale of metal | 337 | Consolidated Mining & Smelting Co. of Canada | 149 |
| Methods of mining | 339 | Consolidated Mining & Smelting Co. of Ontario | 149 |
| Mining regulations | 467 | Copper Range Co. | 149 |
| Ditto | 890 | Copper Range Consolidated Mining Co. | 149 |
| Ditto | 328 | Crown Reserve Mining Co. | 149 |
| Chino Copper Co., company report | 761 | Daily Judge Mining Co. | 149 |
| Mine, old methods at | 23 | Detroit Copper Co. | 149 |
| Chisana gold output | 837 | Flaggon Consolidated Mining Co. | 149 |
| Chloride district, Arizona | 174 | Eagle & Blue Bell Mining Co. | 149 |
| Chlorine | 781 | East Butte Copper Mining Co. | 149 |
| Chlorination of complex ores, the dry | 647 | El Paso Consolidated Mining Co. | 149 |
| Chromic-iron developments in California | 421 | Federal Mining Co. | 149 |
| Chromic-iron ore notes | 134 | Golden Center of Grass Valley Mines Co. | 149 |
| Chuquicamata mine, Chile, the | 642 | Goldfield Consolidated Mines Co. | 149 |
| Large blast at | 627 | Government Gold Mining Areas (Maddertfontein) Cop | 149 |
| Churn-drilling in Alaska | 943 | solidated | 849 |
| Chutes in Miami mine | 888 | Hecla Mining Co. | 149 |
| Cigars, a box of | 317 | Hedley Gold Mining Co. | 149 |
| Cinnabar, amenable to flotation | 541 | Hollinger Gold Mines | 149 |
| Flotation for | 707 | Homestake Mining Co. | 149 |
| Occurrence of | 282 | Inspiration Consolidated Copper Co. | 149 |
| Yield of mercury from | 448 | International Lead Refining Co. | 149 |
| Cinco Minas Co. | 838 | International Nickel Co. | 149 |
| Cisco Mining Co.'s 1,000-ton mill, Joplin | 222 | International Smelting Co. | 149 |
| Claims, area of | 615 | Iron Blossom Mining Co. | 149 |
| Concentration of work on a new one, neglecting old ones | 432 | Isle Royale Copper Co. | 149 |
| Classification and fine grinding | 517 | Ivanhoe Gold Corporation | 149 |
| Classifiers, notes on | 929 | Kerr Lake Mining Co. | 149 |
| And pulp moisture | 929 | Jim Butler Tompah Mining Co. | 149 |
| Clay: Its effect in ore-dressing and cyanidation | 240 | Lakeview Mining Co. | 149 |
| A. W. Allen | 298 | Lower Mammoth Mining Co. | 149 |
| Clayton, Chas. Y., and Peterson, C. E., Oils for flotation | 700 | Magma Copper Co. | 149 |
| Clelland, J. E., Influence of flotation oils on cyanide | 118 | Mary Murphy Gold Mining Co. | 149 |
| Clevenger, G. H., Aluminum dust | 114 | Mass Consolidated Copper Co. | 149 |
| Ditto, and Coe, H. S., Slime-settling | 114 | Miami Copper Co. | 149 |
| Clifton-Morenci-Metcalf district, Arizona, labor agreement | 775 | Moctezuma Copper Co. | 149 |
| Editorial | 679 | Mt. Morgan Gold Mining Co. | 149 |
| Climate and topography | 228 | Mountain King Gold Mining Co. | 149 |
| Coagulation, definition of | 158 | Mysore Gold Mining Co. | 149 |
| Coal-dust fired reverberatories at Anaconda | 568 | National Copper Mining Co. | 149 |
| Coal in Arizona | 597 | Natomas Co. of California | 149 |
| Output of the world | 602 | Nevada-California Power Co. | 149 |
| Coal-pulverizing plant at Anaconda | 586 | Nevada Consolidated Copper Co. | 149 |
| Coal-tar, notes on | 390 | Nevada Hills Mining Co. | 149 |
| Cobalt, Ontario, geological investigations at | 30 | New York & Honduras Rosario Mining Co. | 149 |
| Notes on | 468 | Nyxpassing Mines Co. | 149 |
| Silver production in 1915 | 523 | North Butte Mining Co. | 149 |
| Ore, mercury in | 949 | North Star Mines Co. | 149 |
| Its possible uses | 949 | Nyman Consolidated Mines Co. | 149 |
| Electro-plating with | 414 | old Dominion Copper Mining & Smelting Co. | 149 |
| Coe, H. S., and Clevenger, G. H., Slime-settling | 734 | Opandaga Copper Co. | 149 |
| Coeur d'Alene, Idaho, geology | 67 | Oreochalco Consolidated Copper Co. | 149 |
| Metal production in 1915 | 215 | Philips, Dodge & Co. | 149 |
| Coeur d'Alene Antimony Mining Co., Idaho, notes on mine | 159 | Philips, Dodge, Menapulle Co. | 149 |
| Coghill, Will H., Research problems | 314 | Plumbago Consolidated Gold Mines | 149 |
| Ditto | 314 | European Crown Mines | 149 |
| "Cold short," meaning of term | 436 | Portland Lead Mining Co. | 149 |
| Cold weather, effect of on pipe-lines | 79 | Pratt & Grandville Diamond Mines Co. | 149 |
| Cole, David | 465 | Pratt Consolidated Mining & Smelting Co. | 149 |
| Ditto | 269 | Pratt Mining Co. | 149 |
| Cole, F. L., Washoe reduction works | 617 | Rambler Carbon Mining Co. | 149 |
| Collins, Joseph Henry, death of in Cornwall | 330 | Rand Mines Limited | 149 |
| Collins, William F., on Chinese mining legislation | 330 | Raritan Copper Works | 149 |

Cyanide (continued). Page:
 Solution, precipitating action of carbonaceous shale in Paul W. Avery... 514
 Solutions, alkalinity of... Alfred Merritt Smith... 828
 Solutions, hot... 336
 And ore-dressing, effect of clay on... 319
 At the Comacaran mine, Salvador... A. B. Peckham... 639
 The discovery of... John S. MacArthur... 851
 Early views of in California... 852
 Effect of black slate on... H. Fischer... 743
 Cyanidation of flotation concentrate... E. M. Hamilton... 365
 Ditto... Paul W. Avery... 661
 Ditto... H. R. Layng... 813
 Ditto... M. G. F. Sohnlein... 929
 Machinery for... A. E. Drucker... 517

D

Daly-Judge Mining Co., company report... 495
 Davis-Daly company's results at Butte... 893
 D. C. & E. mill at Joplin... 914
 Deadwood, South Dakota... 350, 485, 526, 606
 Decantation at the Comacaran mine, Salvador... 640
 De Kall, Courtenay... Origin of nitrate... 663
 Delano, L. A... Flotation practice in Missouri... 633
 Delprat, G. D., flotation patent... 471
 Flotation machine... 411
 Dempster, W., and cyanidation... 854
 Denver, Colorado... 21
 Notes on... 749
 Denver Mining & Milling Co., Leadville, work of... 524
 Depreciation of property, rate of... 933
 Dery Ranch Gold Dredging Co.'s results... 249
 Desert sign-posts... 393
 Designation of screen sizes, the... Ernest A. Hersam... 262
 De-silverizing lead... 508
 Desulphurization and flotation... 159
 Detonators, notes on... 788
 Testing... 899
 Detroit Copper Co., company report... 534
 Diamonds in Rand basket... 173
 Diamond-drilling at Juneau, long horizontal hole... 647
 Rifled cores in... 752
 Differential flotation at Broken Hill... 236
 Directors of the porphyry copper companies... 859
 Discovery of cyanidation, the... John S. MacArthur... 851
 Discussion and thought... 850
 Bisminated copper deposits... 669
 Copper mines in 1915... 731
 Dividends from Idaho mines... 962
 Of copper companies... 520
 Paid by American mining companies in 1915... 431
 Does the flag follow the trader?... Editorial... 606
 Dome mine, large lode at No. 7 level... 509
 Dore silver... 576
 Dorr Company, personnel of... 433
 Classifier, notes on... 672
 Double roasting process at East Helena... 252
 Down Town Mines, Leadville, Colorado, pumping at... 611
 Dragon Consolidated Mining Co., company report... 943
 Draw-off levels in Miami mine... 845
 Drawings for publication, suggestions for... 397
 Dredge arranged for re-soiling at Natoma... 630
 Dredges, early types in Alaska... 429
 In Russia, free importation... 602
 Dredging and drilling, comparison of results... 618
 At Bodaibo, Siberia... 51
 In Alaska in 1915... 569
 In California, map of districts... 906
 In Colorado... 329
 In Klondike, late... 43
 In Mozambique... 566
 In Russia in 1914... 802
 In Trinity county, California... 346
 In the United States... H. D. McCaskey... 249
 Near Leadville, Colorado... 421
 Near Redding, California... 627
 On Seward peninsula, Alaska, prospecting before... Corey C. Brayton... 873
 Drift-mining at Magalia, California... 780
 Cost of... J. D. Hubbard... 139
 In California... 317
 Drill-bits improved by hammering... 313
 Drill-holes, sizes of steel for deep holes... 374
 Drill-inspector, work of... P. B. McDonald... 312
 Drill-shanks and bits... 642
 Drill-steel, carbon in... 118
 Cost of... 317
 Fatigue of... 260
 Heating furnace... Lucius Eaton... 741
 Sharpening... P. G. Beckett... 581
 Sharpening at the Old Dominion mine... 795
 Tempering... 15
 Testing efficiency of... William Kitto... 700
 Water-hammer... P. B. McDonald... 14
 In narrow stopes... 959
 Drilling in comfort... 433
 Drucker, A. E., classification and fine grinding... 317
 Ditto, Machinery for cyaniding flotation concentrate... 781
 Dry chlorination of complex ores... S. A. Ionides... 902
 Dry-house, a new... R. E. Tremoureaux... 3
 "Dry" mining... Editorial... 570
 Du Pont Powder Co. to build plant in Montana... 273
 Durell, C. Terry... Flotation principles... 225
 Durham, E. B... Extra-lateral right... 394
 Ditto... Gold mining in Amador, California... 672
 Dwight-Lloyd sintering process... 737
 Dwyer, C. Eustace... Tonnage formulas... 281
 Dynamite-thawer, Simple... 561
 Dynamite, wood-flour used in making...

E

Eagle & Blue Bell Mining Co., company report... 428
 East Butte Copper Mining Co., company report... 768
 East Helena, the double roasting process at... 672
 East Rand Proprietary Mines... Editorial... 773
 Eastern Metal Market... Every Week
 Eaton, Lucius... Drill-steel sharpening... 741
 "Economic Geology" and the mining geologist... 660
 Economics of shoveling... 231
 Of the world's supply of copper... T. T. Read... 93
 Ecuador, interesting notes on... 161
 Mining in... J. W. Mercer... 161
 Education, the influence of technical journalism on mining... 229
 T. A. Rickard... 76
 Mining... Editorial... 581
 Ditto... Frank H. Probert... 581
 Educator, mucking as an... Editorial... 776
 Effect of black slate on cyanidation... H. Fischer... 743
 Efficiency engineer and stop-watches... 718
 In war, cost of... 361
 Of crushing, mechanical... A. O. Gates... 396
 Ditto... H. Stadler... 399
 Of pumps... 117
 Electric centrifugal v. steam pumps... 59
 Electric-furnace, heat loss in... 26
 Quality of steel from... 345
 Electric haulage at Copper Queen mine... 852
 Hoists on the Rand... 178
 Loco, coupling-hook, for... 417
 Ore haulage cost... 26
 Power at Joplin... 462
 Power consumed in electrolytic zinc process... 379
 v. steam mine pumps... 819
 Theory of flotation... James A. Block... 79
 Ditto... David Cole... 375
 Electricity in flotation, advocates of... 375
 Notes on... 785
 Electrolytic cell... P. H. Crawford... 432
 Precipitation, working data on... 432
 v. retort zinc... Editorial... 434
 Zinc... L. S. Austin... 434
 Ditto... W. R. Ingalls... 491
 Ditto... Harry A. B. Motherwell... 564
 Electro-hydraulic shovel, use of... 449
 Metallurgy of zinc... 910
 Electro-plating with cobalt... 347
 Electro-statics, definition... F. A. Fahrenwald... 375
 Of flotation, the... 440
 Electro Zinc Co., electrolytic zinc production... 518
 Elevators, notes on... 851
 Ellis, C. J., and cyanidation... 470
 Elmore, Francis Edward, flotation patent... 331
 Brothers, work in flotation... 44
 Flotation machine... 192
 Elm Orlu v. Butte & Superior... Editorial... 151
 Ditto, suit decision... 209
 Ditto, abstracts from the Judge's remarks... 145
 El Oro, Mexico, conditions at... 651
 El Paso Consolidated Mining Co., company report... 678
 El Paso, Texas, notes on... 153
 Elschner, Carl, American potash... 855
 Elschner's cyanide equation... 185, 762, 954
 Ely, Nevada... 719
 Emeralds in Colombia... 521
 Emergency repairs for rock-drills... W. H. Washburn... 331
 Empire-North Star compromise... Editorial... 645
 Empire Zinc Co. at Leadville... 681
 Operations of in New Mexico... Editorial... 927
 Employer and employee... John P. Irish... 49
 Ditto, relations... A Union Man... 228
 Emulsion, definition of... Mining in Sardinia... 862
 Engelder, O. G... Electrolytic zinc... 141
 Engelhardt, Victor, work on electrolytic zinc... 345
 Engine-house at North Star mine, details of... Editorial... 464
 Engineer, qualities of an... Editorial... 38
 Standard of professional conduct... J. W. Swaren... 932
 Engineer-corps, volunteer... P. B. McDonald... 699
 Engineers and business... Editorial... 629
 And the War, mining... 577
 And preparedness... Editorial... 695
 Preparedness for... E. P. Mathewson... 591
 Training of mining... 537
 "Engineering and Mining Journal," 50th anniversary... Editorial... 887
 Enrichment of copper ore... Editorial... 317
 Of upper parts of veins... 670
 Erosion... 888
 In arid and cold climates... 815
 Notes on... 865
 Erzerum, Armenia, notes on... 594
 Eucalyptus oil, source of... 25
 Eureka mine sold... 251
 Mine, California, notes on... 330
 Mine celebration... 935
 Eureka, Hayward's, Betty Green, or Amador mine... 82
 Everson, Carrie J., and flotation... 657
 Further notes on... 78
 Myth, the... Editorial... 169
 Flotation patent... Editorial... 78
 Value of work in flotation... Editorial... 646
 Exchange in Mexico, rate of... 81
 In South America... 686
 Exploration Co. operations curtailed in Mexico... 912
 Explosives in inflammable bags, danger of... 290
 Into Mexico, permission necessary... 42
 Safety in using... 348
 Storage in mines... 189
 Extraction by flotation at Braden and Butte & Superior... 225
 Extra-lateral right... P. B. Durham... 990
 Eye, C. M... Gold mining in the Philippines...

| | Page. |
|---|---------------------------|
| Gold Circle, Nevada | 839 |
| Gold Extracting Co. of Glasgow | 851 |
| Gold Reef Mining Co. | 569 |
| Golden Center of Grass Valley, company report | 569 |
| Golden Pen mine, Nevada | 61 |
| Goldfield, Nevada | 853 |
| Goldfield Consolidated Mines Co., company report. | 655 |
| Opens exploration office | 362 |
| Goldstone, California, notes on | 916 |
| Gossan, meaning of term | 832 |
| Government Gold Mining Areas (Moldefontein) Consoli- dated, company report | 813 |
| Granby Consolidated Mining, Smelting & Power Co., work of Smelters | 28 |
| Granby Mining & Smelting Co., absorbed by American Zinc Editorial | 926 |
| Granite Gold Mining Co., notes on | 527 |
| Graphite crucibles and lead-slugs | 378 |
| Grease for heavy machinery | 679 |
| In cyanidation | 745 |
| Grass Valley, California, map of | 648 |
| Notes from | P. B. McDonald, 343 |
| Gratitude, definition of | 888 |
| Greased needle, why does it float? | 232 |
| Greater Miami Copper Co. | 836 |
| Green, Edward H., and the old Eureka mine | 937 |
| Green, Hetty Robinson, and the old Eureka mine | 938 |
| Greenwalt, W. E., Patents and the Patent Office | 739 |
| Grinding at Flat River, Missouri | 452 |
| Classification and fine | A. E. Drucker, 433 |
| Machinery, notes on | 517 |
| Pine: stamps and ball-mills | Henry Hanson, 701 |
| Grootvlei mine, Rand, being developed by Americans | 617 |
| Grothe and Carter | Improved stamp-shoes, 467 |
| Gruetter, T. W., Antimonial gold ore | 583 |
| Guadalajara, Mexico | 616, 801, 951 |
| Guatemala, notes on | 7 |
| Guggenheim, Meyer, and sons | 462 |
| Guggenheims purchase ore vessels | 809 |
| Guide-posts in deserts | 393 |
| Gypsum in Arizona | 647 |

H

| | |
|--|---|
| H-bit, plan of | 313 |
| Halecomb patent for molybdenum steel | 812 |
| Haldane, J. S., investigations into mine air | 777 |
| Hall, Edgar, small machinery | 156 |
| Hamilton, E. M., Cyanidation of flotation concentrate | 365 |
| Ditto | Flotation for cinnabar, 541 |
| Hammer-drills, first | 932 |
| Hancock jigs at Anaconda | 465 |
| Hand-jigging tungsten ore | 757 |
| Hanover, New Mexico | 681 |
| Hanson, Henry, Fine-grinding: stamps and ball-mills | 791 |
| Harbaugh, A. G., Precipitation of gold and silver in steel laundry | 698 |
| Harding, W. K., Manitoba mining law | 583 |
| Harding mills, notes on | 146 |
| Hartmann, M. L., Rapid method for tungsten | 563 |
| Ditto | Qualitative test for tungsten, 941 |
| Haynes, William, flotation patent | 469 |
| Hayward, Alvinza | 935 |
| Hayward's, Amador, Eureka, or Hetty Green mine | 935 |
| Head-frame, an unusual | J. R. Cahill, 157 |
| For North Star mine, steel | 213 |
| Steel v. wood | 564 |
| Head-lights for min-locoms | 616 |
| Heard in the bunk-house—I and II | W. H. Storms, 677 |
| Ditto—III and IV | 867 |
| Heat waste from furnaces | 96 |
| Heated cyanide solutions | 336 |
| Heating a mill, cost of | 418 |
| Buildings | 679 |
| Cyanide solution | Alfred Merritt Smith, 889 |
| Pulp for flotation | 679 |
| Hecla Mining Co., company report | 808 |
| Hedley Gold Mining Co., company report | 739 |
| Hematite, notes on | 896 |
| Herrenschmidt antimony furnace, notes on | 337 |
| Hersam, Ernest A., Designation of screen sizes | 262 |
| Hershey, Oscar H., and the Coeur d'Alene of Idaho | 731 |
| Hess, Rush M., Hookworm disease among miners | 511 |
| Higgins, Edwin, Safety in mining | 226 |
| Hill, James J., Editorial | 809 |
| Hill, John A., death of | 151 |
| Hiring, handling, and firing men | E. F. Irwin, 995 |
| Hoffman, F. L. and Adler S., Mine accidents | 297 |
| Hoists, compressed-air, use of | 318 |
| Hoisting ore at Copper Queen mine, cost of | 381 |
| Hollinger Consolidated Gold Mines, Limited, amalgamation at Porcupine | 763, 922 |
| Hollinger Gold Mines, company report | 922 |
| Cost of supplies at | 911 |
| Mine | Editorial, 809 |
| Homestake Mining Co., company report | 495 |
| Mine, deep development | 356 |
| Honduras, new mining law | 161 |
| Hookworm in California, miners | Editorial, 260 |
| Disease among miners | Rush M. Hess, 511 |
| Hoover, T. J., flotation patent | 473 |
| Ditto, work in flotation | 332 |
| Flotation apparatus | 32 |
| Hope district of British Columbia | 651 |
| Horse Mountain Copper Co. | 916 |
| Horse-power of internal combustion engine in U. S. | 118 |
| Houghton, Michigan | 63 |
| Howard, L. O., Alunite in Utah | 468 |
| Ditto | Geology of the Cottonwood district, 537 |
| Ditto | Mining in Utah, 132, 280, 415, 717, 967 |
| Ditto | Ozokerite in Utah, 789 |
| Hubbard, J. D., Cost of drift-mining | 758 |
| Hudson Bay zinc mine, British Columbia | 726 |
| Hunan, China, antimony in | 359 |
| Metaliferous mines of | A. S. Wheeler, 337 |

| | |
|--|-------------------------------|
| Huntington-Herberlein process | 674 |
| Huston, George, Why is flotation? | 6 |
| Hutchinson, Charles T., Fire insurance on mining property | 831 |
| Ditto | Tungsten mines of Atolia, 297 |
| Hyde, James M., Need of a change in the patent law | 517 |
| Ditto, work in flotation | 332 |
| Hydraulic ram | 832 |
| Hydrauhecking at Atlin | 721 |
| Hydro-electric power in British Columbia | 70 |

I

| | |
|---|----------------------------|
| Idaho, capital for central | 528 |
| Central development of | 556 |
| Invidious in 1915 | 26 |
| Metal output in 1915 | 31, 423 |
| Notes on | 594 |
| Pine Creek district of | 529 |
| Railroad for Pine Creek | 619 |
| Improved stamp-shoes | Grothe and Carter, 467 |
| Increase in cost of mine supplies | 911 |
| India, gold production of in 1915 | 281 |
| Melting coins in | 964 |
| Indications of copper, Surficial I, II, III | 893 |
| Frank H. Probert, 665, 815, 893 | Editorial, 77 |
| Individualism and co-operation | 77 |
| Industrial opportunities in Siberia | C. W. Purinton, 237 |
| Conditions and buying | Editorial, 885 |
| Influence of flotation oils on cyanide | J. E. Clemmell, 799 |
| Of technical journalism on mining education | T. A. Rickard, 229 |
| Ingalls, W. R., Electrolytic zinc | 439 |
| Inspiration Consolidated Copper Co., company report | 651 |
| Flotation at the | 676 |
| Mill in full operation | 293 |
| Mine, cost of preparing and equipping | 642 |
| Insurance, mine accident | Will J. French, 541 |
| Ditto | Robert J. Kern, 623 |
| On mining property, fire | Charles T. Hutchinson, 933 |
| International Lead Refining Co., company report | 767 |
| International Nickel Co., company report | 739 |
| Finances | 213 |
| International Smelting Co., company report | 767 |
| Miami plant | 822 |
| Intervention in Mexico, is it? | Editorial, 294 |
| Inventors and their reward | John M. Nicoll, 777 |
| Inventory of a property | 933 |
| Inyo Development Co., potash manufacture by | 155 |
| Ionides, S. A., Dry chlorination of complex ores | 781 |
| Irish, John P., Relations of employer and employee | 40 |
| Iron ore movement | 925 |
| Production of United States | 925 |
| Iron Blossom Mining Co., company report | 391 |
| Irvine, Donald F., Precipitation with zinc | 115 |
| Irwin, E. F., Hiring, handling, and firing men | 995 |
| Is it intervention? | Editorial, 294 |
| Isinglass | 719 |
| Isle Royale Copper Co., company report | 808 |
| Isle Royale (island) in Lake Superior, mining on | 699 |
| Italy, mineral production of | 632 |
| Mining in warfare in | 959 |
| Ivanhoe Gold Corporation, company report | 843 |

J

| | |
|--|-----------------------------|
| Jacobs, E., Gold from Atlin mines | 849 |
| James, Alfred, and cyanidation | 853 |
| Janin, Jr., Louis, and cyanidation | 852 |
| Janney, Frank G., death of | 768 |
| Janney flotation apparatus | 31 |
| Japan and Korea | Editorial, 539 |
| As a copper producer | Editorial, 926 |
| Foreign trade of | 911 |
| Metal mining in | 131 |
| Jennings, Henzen, and cyanidation | 852 |
| Jim Butler Tonopah Mining Co., company report | 328 |
| Joh, getting a | Editorial, 191 |
| Johannesburg, Transvaal | 689, 800 |
| Johnson, Arizona, activity of | 682 |
| Jones, W., and cyanidation | 851 |
| Joplin, Missouri | 97, 247, 383, 566, 689, 914 |
| Electric power at | 26 |
| Report on | 67 |
| Journalism on mining education, the influence of technical | T. A. Rickard, 229 |
| Judge Mining & Smelting Co. (Judge Mining Co.) | 611 |
| Judith mountains, Montana, gold mining in the | O. W. Freeman, 862 |
| Jumbo Extension, gold output in 1915 | 144 |
| Juneau, mining at | Editorial, 34 |

K

| | |
|---|----------------|
| Kahn, Otto H., on finance | 735 |
| Kalgoorlie, Western Australia | 119 |
| Kalgoorlie and Coloradoite | 294 |
| In Ontario | 179 |
| Kansas City Nevada Consolidated Mines Co., new coal plant | 144 |
| Kansas, zinc production in 1915 | 143 |
| Kapsan Mining Concession, Korea | 846 |
| Sale of | 880 |
| Keith, N. S., Another, and earlier, ball-mill | 177 |
| Kemp, James F., medal awarded to | 189 |
| Kennett Copper Co., boom | Editorial, 657 |
| Production of | 248 |
| Kerosene acid-sludge, use of | 869 |
| Kerr, Robert J., Mine accident in finance | 623 |
| Kerr Lake Mining Co., company report | 962 |
| Ketchikan, Alaska, notes from | 65 |
| Progress at | 862 |
| Keystone drill in Alaska | 627 |
| Keystone Mining Co. report | 141 |

| | Page. |
|---|---------------------------------|
| Mexico (continued). | |
| Near point of rupture | Editorial, 925 |
| Notes on conditions | 525, 537 |
| Opinion of United States intervention | 809 |
| Outrage, another | Editorial, 76, 100 |
| Permission necessary to send explosives into | 290 |
| Silver dollar | R. S. Burdette, 932 |
| Trouble with | 462 |
| Mexican Gold & Silver M. Co. | 104 |
| Miami Copper Co., company report | 690 |
| Stopping hard ore | David B. Scott, 913 |
| Mica mining | 866 |
| Notes on | 512 |
| Uses of | 417 |
| Michigan copper mines, output in 1915 | 63 |
| Copper production of | 752 |
| Copper in 1915, average price for | 624 |
| In 1915 | 113 |
| Map of | 609 |
| Michigan College of Mines' Annual 'The Engineer' | Editorial, 925 |
| Midvale smelter, the new bag-house at | L. S. Austin, 746 |
| Mill capacity in various districts | 832 |
| Mill-men's mistakes | W. H. Washburn, 297 |
| Mill-runs, record | 166 |
| Mill-site, abandonment of | 317 |
| In forest reserve | 964 |
| 'Mills,' definition of | 750 |
| Mills in the Missouri-Kansas-Oklahoma region | 247 |
| 'Milling,' definition of | 750 |
| Mine accident insurance | Editorial, 463 |
| Ditto | Will J. French, 541 |
| Ditto | Robt. I. Kerr, 623 |
| Accidents, queer | S. Adler and P. L. Hoffman, 297 |
| Accidents, queer | P. B. McDonald, 244 |
| Cars at Copper Queen, capacity of | 413 |
| Depth of some | 429 |
| Explosions, rock-dust and | 642 |
| Loco head-lights | 616 |
| Mechanic | P. B. McDonald, 513 |
| Models, celluloid no good for | 692 |
| Present value of a | F. Sommer Schmidt, 297 |
| Rescue stations in California | 360 |
| Sales in Missouri | 423 |
| Shares, return on | 39 |
| Supplies, increase in cost of | 911 |
| Timber deterioration, cause of | 317 |
| Transfers in California | 75 |
| Unusual gas in a metal | E. Steidle, 368 |
| Mines, account systems for small | James E. Chapman, 400 |
| Laws of | Franklin Wheaton Smith, 593 |
| Of Hunan, metalliferous | A. S. Wheler, 337 |
| Pumps for | 379 |
| Sunday work at | F. C. Brown, 889 |
| Wet | Editorial, 538 |
| Miners, hookworm disease among | Rush M. Hess, 511 |
| Injuries, treatment of | T. C. Witherspoon, 168 |
| Resume work at Clifton, Arizona | 151, 179 |
| Strike at Clifton, Arizona, progress of | 65, 75, 250 |
| Mineral, definition of | 228 |
| Industry of Chile | Lester W. Strauss, 475 |
| Land leasing bill passes the House | 111 |
| Lands in railroad grants | 523 |
| Production of Alaska in 1915 | 51 |
| Production of British Columbia in 1915 | 211 |
| Production of Canada in 1915 | 363 |
| Production of Eastern or Appalachian states | 712 |
| Production of Italy | 632 |
| Production of Rhodesia | 562 |
| Resources of certain California counties | 24 |
| Mineral Products Co., Utah, potash production | 132, 879 |
| Minerals of Bolivia | 513 |
| In Ecuador | 162 |
| In Oregon, list of | 290 |
| Minerals Separation American Syndicate (1913) Limited, some notes on | 193 |
| Contracts and metallurgists | 193 |
| Ditto | Editorial, 190 |
| Flotation patent | 472 |
| Notes on annual meeting | 211 |
| Process in Missouri | 633 |
| Process, tonnage treated by | 222 |
| Work on flotation | 332 |
| MINING AND SCIENTIFIC PRESS and 'Engineering and Mining Journal,' educative factors in mining education | 229 |
| Ditto, discussion in | Editorial, 462 |
| Mining, American youth and | Editorial, 696 |
| And metal yield of U. S. Steel Corporation | 678 |
| And shares | 540 |
| Antimony in China | 338 |
| At Juneau | Editorial, 4 |
| At the Nevada Consolidated | P. B. McDonald, 858 |
| Claim, area of | 173 |
| Claims in railroad grants, locating | 523 |
| Claims, re-locating by shareholders | 523 |
| Claims, titles to | 299 |
| Companies in America, dividends paid in 1915 | 520 |
| Costs at the Portland | 510 |
| Decisions | 149, 359, 428, 536, 615, 808 |
| Districts of Northern Ontario | Robert Livermore, 89 |
| Dry | Editorial, 3 |
| Education | Editorial, 76 |
| Ditto | Frank H. Probert, 581 |
| Education, influence of technical journalism on | T. A. Rickard, 229 |
| Engineers and the War | Editorial, 620 |
| Engineers, training of | E. P. Mathewson, 501 |
| Engineering on the wane, is? | Editorial, 263 |
| Ditto | Frank A. Ross, 582 |
| Geologist | Editorial, 660 |
| In Alaska in 1915 | Alfred H. Brooks, 51 |
| In Arizona, Charles F. Willis | 171, 299, 449, 625, 824, 947 |
| In Colorado | George J. Baneroff, 603, 821 |
| In Ecuador | George J. W. Mercer, 163 |
| In Japan, metal | 131 |
| In Nevada | R. L. Richie, 829 |
| In the Rocky Mountains in winter | 181 |

| | Page. |
|--|---------------------------------------|
| Mining (continued). | |
| In Sardinia | O. G. Engelder, 862 |
| In Utah | L. O. Howard, 132, 280, 415, 717, 826 |
| In war zones of Europe | 551 |
| In warfare | 959 |
| In western Oregon | E. C. Morse, 169 |
| Ditto | H. S. Reed, Jr., 366 |
| Industry of United States, effect of War on | 430 |
| Last year's | Editorial, 26 |
| Law | Editorial, 579 |
| Ditto | E. B. Bail, 849 |
| Law, changing | Editorial, 222 |
| Law, Colorado view of | 799 |
| Law in Mexico, new | 646 |
| Law, Manitoba | W. K. Harding, 583 |
| Law of Honduras, new | 161 |
| Law of United States, revision of | 2 |
| Law, revision | 99, 330 |
| Ditto | George E. McClelland, 729 |
| Manganese in Brazil | 484 |
| Men read, what | P. B. McDonald, 891 |
| Methods at Copper Queen | 719 |
| Methods in Hunan, China | 379 |
| Methods, safety and efficiency of | 759 |
| Mica | Editorial, 866 |
| Ordinance, Korean | Editorial, 539 |
| Property, fire insurance on | Charles T. Hutchinson, 938 |
| Regulations, Chinese | Editorial, 330 |
| Ditto | K. C. Li, 467 |
| Ditto | M. B. Yung, 899 |
| Representatives in Canadian parliament | 393 |
| Safety in | Edwin Higgins, 226 |
| Stock, appraisal of | B. Read, 466 |
| Stock, why people buy it | 498 |
| Taxation in Mexico | 801 |
| Towns, libraries in | Leroy A. Palmer, 227 |
| 'Mining Magazine,' criticism of | Editorial, 259 |
| Mint, San Francisco, receipts in 1915 | 131 |
| Work in 1915 and to date | 283 |
| Missouri, flotation practice in | L. A. Delano, 633 |
| Zinc production in 1915 | 143 |
| Missouri-Kansas-Oklahoma zinc-lead region in 1915 | 143 |
| Record output of | 649 |
| Missouri School of Mines and Metallurgy, work on flotation | 598 |
| Mizpah trachyte, Tonopah, Nevada | 482 |
| Moctezuma Copper Co., company report | 531 |
| Models, celluloid for mine | 692 |
| Modern blasting practice | P. B. McDonald, 788 |
| Mogollon, New Mexico, notes from | 918 |
| Mohave county, Arizona, frequent issues | 420 |
| Mohave-Oatman Water Co. | 101 |
| Mojave Tungsten Co. | 228 |
| Molecule, definition of | 228 |
| Molecular forces in flotation—Surface compression | Dudley H. Norris, 232 |
| Molybdenite ore in Australia, treatment of | 50 |
| Molybdenum and tungsten steel | Editorial, 812 |
| Concentrating | 82 |
| In Peru | 795 |
| Notes on | 519 |
| Price of ore, 881 and other issues | 380 |
| Qualitative test for | 585 |
| Mond Nickel Co. | 585 |
| Monell, Ambrose | 577 |
| Monel metal | F. H. Mason, 585 |
| Money, value of in Mexico | 646 |
| Montagu & Co., Samuel, annual letter on silver | 220 |
| Montana, metal output in 1915 | 31 |
| Notes on | 39 |
| Zinc production | 752 |
| Monzonite and copper deposits | 666 |
| Morse, E. C. | Mining in Western Oregon, 169 |
| Morton, George, and cyanidation | 834 |
| Mosquitoes and oil | 759 |
| Mother Lode, Cal., ore treatment on the | 743 |
| Prospecting on the | 912 |
| Reopening old mines along the | T. A. Rickard, 955 |
| Motherwell, Harry A. E. | Electrolytic zinc, 401 |
| Motherwell, W. | Flotation residue, 7 |
| Motor burns out at North Butte mine | 174 |
| Mt. Morgan Gold Mining Co., company report | 328 |
| Mountain King Gold Mining Co., company report | 723 |
| New power plant | 352 |
| Mozambique, dredging in | 43 |
| Mucking as an educator | Editorial, 776 |
| Mysore Gold Mining Co., company report | 923 |

N

| | |
|--|---|
| Nahsen electrolytic zinc process | 431 |
| Narrow stops, drilling in | P. B. McDonald, 44 |
| Nascent, definition of | 228 |
| Gas in flotation | Editorial, 621 |
| National City Bank of New York, aid to expansion of American trade | 621 |
| National Copper Mining Co., company report | 649 |
| National Tungsten Co., Arivaca, Arizona | 526 |
| Nation's life, the | Secretary of the Interior F. K. Lane, 133 |
| Natomas Co. of California, company report | 428 |
| And re-rolling | Howard D. Smith, 397 |
| Needle, floating in | 263 |
| Greased, why does it float? | 322 |
| Neihart district of Montana | 529 |
| Nevada, antimony in | 142 |
| Insurance of employees | 947 |
| Metal output in 1915 | 22 |
| Mining in | R. L. Richie, 829 |
| Notes on | 742, 642, 749 |
| Section of A. T. M. E. | Editorial, 772 |
| Nevada-California Power Co., company report | 685 |
| Nevada Consolidated Copper Co., company report | 328, 690 |
| And Calumet & Hecla, ore mined by | Editorial, 885 |
| Mining at the | P. B. McDonald, 858 |
| Nevada Douglas Copper Co., company report | 423 |
| Nevada Hills Mining Co., company report | 574 |
| Nevada Metal-Extraction Co.'s flotation results at Goldfield | 650 |

| | Page. |
|--|--|
| Plumbo-jarosite in the Boss mine, Nevada | 179 |
| Plymouth Consolidated Mines Co., company report | 654 |
| Sociological work | 927 |
| Pocket mining at Joplin, Mo. | 681 |
| Points of view from Lake Superior | 95, 892 |
| P. B. McDonald | 749 |
| Porcupine, Ontario, notes on | 804 |
| Progress at | 726 |
| Porcupine-Crown Mines, company report | 859 |
| Porphyry copper companies, directors of | 666 |
| Copper deposits | 731 |
| Copper mines in 1915 | 949 |
| Portable equipment for prospects | Louis A. Rehfuess |
| Porter, Charles A., Quick method of locating geologic features | 719 |
| Portland Gold Mining Co., company report | 390 |
| Mining costs at the | 510 |
| Possum, use of | 96 |
| Postage, one-cent | 461 |
| On letters, deficient | 885 |
| Potash, American | Carl Elsehner |
| -Bearing brine at Searles Lake | 679 |
| In banana stalks | 759 |
| In leucite | 912 |
| Production of Germany in 1915 | 584 |
| Potreros Railway Co. | 185, 286 |
| Potter, Charles V., flotation patent | 470 |
| Flotation machine | 411 |
| Potter-Delprat apparatus | 9 |
| Power of attorney and location of claims | 964 |
| Used at Joplin, Missouri | 103 |
| Power-reciprocating and rotary engines | 719 |
| Precipitate, refining and melting gold | 442 |
| Refining cupriferosus | Jackson A. Pearce |
| 270 | |
| Precipitating action of carbonaceous shale in cyanide solution | Paul W. Avery |
| 514 | |
| Precipitation of gold and silver in steel launder | A. G. Harbaugh |
| 698 | |
| Of gold, notes on | 518 |
| Of zinc from electrolyte | 401 |
| With zinc | Donald F. Irvin |
| 115 | |
| Working data on electrolytic | P. H. Crawford |
| 634 | |
| 257 | |
| Premier (Transvaal) Diamond Mining Co., company report | 134 |
| Preparation of tungstic metals | Editorial |
| 927 | |
| Preparedness | Editorial |
| 695 | |
| For engineers | E. Sommer Schmidt |
| 207 | |
| Present value of a mine, the | 962 |
| Price of scrap metals | 820 |
| Primary and secondary ores | 894 |
| Copper ores, notes on | 788 |
| Primer, notes on | 685 |
| Prince Consolidated Mining & Smelting Co., company report | 618 |
| Probert, Frank H., appointment to University of California | 581 |
| Mining education | 17 |
| Ditto | 665 |
| Ditto | Oatman, Arizona—A prohibition camp |
| 815 | |
| Ditto | Surficial indications of copper, Part I |
| 893 | |
| Ditto | Surficial indications of copper, Part II |
| 159 | |
| Ditto | Chemistry of the oxidized zone, Part III |
| 190 | |
| Problems, research | Will H. Coghill |
| 524 | |
| Professional matter, a | Editorial |
| 2 | |
| Progress Mining & Milling Co., Leadville, work of | 117 |
| Prohibition in mining camps | P. B. McDonald |
| In the West | 226 |
| Ditto | L. S. Austin, A. T. Parsons |
| 132, 486 | |
| Promontory zinc district, Utah | John B. Simmons |
| 501 | |
| Prospect, how to | Louis A. Rehfuess |
| 949 | |
| Prospects, portable equipment for | Corey C. Brayton |
| 627 | |
| Prospecting before dredging on Seward Peninsula, Alaska | 520 |
| For phosphate rock | 491 |
| For tungsten, hints on | 461 |
| In forest reserves | Patents |
| 398 | |
| Ditto | Scope of a patent, the |
| 692 | |
| Pump-valve facings, materials for | Editorial |
| 331 | |
| Psychology of flotation | 171 |
| Publicity, an aid to Arizona mining | 228 |
| Pulp, definition of | 379 |
| Pumps for mines | 337 |
| In Chinese mines | 518 |
| Notes on | 562 |
| Pumping equipment at Old Dominion mine | Editorial |
| 811 | |
| Purchase of machinery | 237 |
| Purinton, C. W., Industrial opportunities in Siberia | 777 |
| Pyrite, gas from decomposing | Editorial |
| 291 | |
| Pyritic copper deposits | 585 |
| Pyrrhotite at Sudbury, Ontario | |

Q

| | |
|--|--------------------|
| Qualities of an engineer | Editorial |
| 461 | |
| Qualitative test for molybdenum | 380 |
| Test for tungsten | M. L. Hartmann |
| 911 | |
| Quantitative analysis for tungsten | 592 |
| Determination of tungsten | 563 |
| Quartzite, Arizona | 824 |
| Quebec, mining law revision | 287 |
| Queer mine accidents | P. B. McDonald |
| 214 | |
| Quick method of locating geologic features | Charles A. Porter |
| 719 | |
| Ditto | Leon J. Pennerberg |
| 859 | |
| Quicksilver | Editorial |
| 659 | |
| Deposits in California, map of | 282 |
| From alluvial deposits, Oregon | 197 |
| In Cobalt ore | 523 |
| In California, notes on | 353 |
| In Hunan, China | 310 |
| In Nevada | 253 |
| In pan-amalgamation | 151 |
| In Peru | 428 |
| Metallurgy of | 283 |
| Mines in California, re-opening of old | 289 |
| Mining in California | W. H. Landers |
| Notes on | Editorial |
| 528 | |
| Ore, concentration of | 796 |
| Ore, flotation for | 541 |

| | Page. |
|-----------------------------------|--------------|
| Quicksilver (continued) | |
| Prices and uses | 221 |
| Public sale of in San Francisco | 688 |
| Reduction | Herbert Lang |
| In 1915 | 32 |
| Quincy Mining Co., company report | 923 |
| Quinmer-Stebbins dry concentrator | 834 |

| R | |
|--|---|
| Radium and uranium ores | 448 |
| Ore shipment in Colorado | 451 |
| Persistence in slag | 445 |
| Railroad construction in Alaska, progress of | 826 |
| Railroads in South America | 759 |
| Rainbow vein at Butte, controversy over | 209 |
| Raises, stopping by branched | F. W. Sperr |
| 750 | |
| Ralph, Joseph | Metal quotations |
| 468 | |
| Ralston, O. C. | Flotation oils |
| 869 | |
| Ditto | Flotation principles |
| 621 | |
| Ditto, and Allen, Glenn L., Testing ores for the flotation process—I, II | S |
| 41 | |
| Ram, the hydraulic | 832 |
| Rambler-Cariboo Mining Co., company report | 879 |
| Rambler Copper & Platinum Co. | 725 |
| Rand, air-blasts on the | 354 |
| American capital on the | Editorial |
| 462 | |
| Cyanide consumption on | 57 |
| Disappointing results from big consolidations | 173 |
| Gold outputs and shipments | Editorial |
| 925 | |
| Labor problems | 382 |
| Mines, sources of accidents in | 300 |
| Moving broken ore in stopes | 136 |
| Rand Mines, Limited, company report | 883 |
| Rand, Nevada, rich mines at | 64 |
| Randfontein Central | Editorial |
| 772 | |
| Raritan Copper Works, company report | 767 |
| Ray Consolidated Copper Co., company report | 328 |
| Ray Hercules Copper Co., plan of property | 697 |
| Mine, Arizona, progress at | 488 |
| Raymond, Robert M., appointment of | 75 |
| Read, B. | Appraisal of mining stock |
| 466 | |
| Read, T. T., Economics of the world's supply of copper | 92 |
| Real del Monte silver mine, Pachuca, Mexico | 60, 245, 483, 643, 871 |
| Recent patents | Mining in western Oregon |
| 366 | |
| Reed, Jr., H. S. | A. J. Wernig |
| 442 | |
| Refining and melting gold precipitate | Jackson A. Pearce |
| 270 | |
| Reformer, the way of the | Editorial |
| 510 | |
| Regeneration of cyanide | 635 |
| 'Regulus,' antimony meaning of term | 369 |
| Rehfuess, Louis A., Portable equipment for prospects | 949 |
| Relations of employer and employee | John P. Irish |
| 40 | |
| Re-opening gold mines along the Mother Lode, Cal. | T. A. Rickard |
| 935 | |
| Reorganized Booth Mining Co., company report | 144 |
| Reorganized Kewanas Mining Co., company report | 114 |
| Repairing pipe-lines | 438 |
| Repairs for rock-drills, emergency | W. H. Washburn |
| 521 | |
| Report, who owns a? | J. A. Burgess |
| 37 | |
| Republic, Wash., some ore deposits at | 728 |
| Research problems | Will H. Coghill |
| 149 | |
| Reservation, Nevada, mining at | 804 |
| Residue, flotation | W. Motherwell |
| 7 | |
| 'Resin' and 'rosin,' notes on | 367 |
| Re-soiling at Natoma | 397 |
| Retorts, number of zinc in United States | 658 |
| Reverberatory furnace work at Miami, Arizona | 829 |
| Reverberatories at Anaconda, coal-dust fired | 198 |
| Rhodesia, apex disputes in | 809 |
| Mineral production of | 362 |
| Richest stopes | Editorial |
| 774 | |
| Riech, R. L. | Mining in Nevada |
| 829 | |
| Rickard, Forbes | Colorado-Gilpin Gold & Radium Co. |
| 39 | |
| Rickard, T. A. | Flotation process, I—Physics |
| 333 | |
| Ditto | II, Processes |
| 407 | |
| Ditto | III, Patents |
| 469 | |
| Ditto | Influence of technical journalism on mining education |
| 229 | |
| Ditto | Phillip Argall and metallurgical progress—An interview |
| 119 | |
| Ditto | Re-opening of old mines along the Mother Lode, Cal. |
| 935 | |
| Ditto | Selby lead smelter |
| 505 | |
| Ditto | Simple problems in flotation |
| 263 | |
| Ditto | Theoretical considerations governing the persistence of ore |
| 83 | |
| Ricketts, L.D., president of the A. I. M. E. | 293 |
| Ditto | On individualism |
| 77 | |
| Rico Wellington Mining Co., company report | 698 |
| Rifed cores in diamond-drilling | 752 |
| Rig for prospecting gravel, light-power | 628 |
| Rio Tinto Copper Co., company report | 768 |
| Rise in silver | Editorial |
| 694 | |
| Rittinger's law of crushing, notes on | 266 |
| Rittman process of gasoline manufacture | 754 |
| Rivets, notes on | 281 |
| 827 | |
| Roasting and acid-making at Braden, Chile | 297 |
| At Anaconda | 199, 749 |
| Cripple Creek ore, some history of | 126 |
| Process at East Helena, the double | 679 |
| Robert Emmet mine, Leadville | 645 |
| Robson, George, flotation patent | G. F. Weeks |
| 167 | |
| Rock-drill stamp-mill, emergency repairs for | W. H. Washburn |
| 642 | |
| Rock-dust and mine explosions | 75 |
| Rope, tension of wire | 782 |
| Ross, Frank A., Is mining engineering on the wane? | 206 |
| Round tables at Anaconda | 251 |
| Royal Gold Mines Co., California, work of | 105 |
| Runner, J. J., Geology of tungsten deposits | 242 |
| Russia, area and population of | 948 |
| Gold in | 237 |
| Industrial opportunities in Siberia | 237 |
| Russo-Asiatic Corporation, Russian Mining Corporation, results of | 112 |

| | | |
|---|--|-----|
| Storms, W. H. | Page. | 677 |
| Ditto | 657 | |
| Ditto | 295 | |
| Stratton's Independence mill, record of | 128 | |
| Strauss, Lester W. | 475 | |
| Submergence, definition of term | 564 | |
| Success, aids to | 549 | |
| Success Mining Co., company report | 215 | |
| Sudbury, Ontario, ores of | 555 | |
| Sullivan, Clarke | 117 | |
| The air-lift in leaching | 117 | |
| Sulman, H. L., work in flotation | 331 | |
| Sulman-Picard-Ballot flotation patent | 473 | |
| Sulman-Teed process, notes on | 856 | |
| Sulphide Corporation, Broken Hill, results of | 111 | |
| Sulphur in tin plating | 122 | |
| Sulphuric acid from smelters | 865 | |
| Manufacture at Anaconda | 552 | |
| Manufacture, description of | 827 | |
| Production in 1915 | 865 | |
| Sunday work at mines | 889 | |
| Ditto | F. C. Brown | 889 |
| Surface tension, definition of | 228 | |
| On water | 332 | |
| Phenomenon | 407 | |
| Surficial indications of copper, I. | 665 | |
| Ditto | Part II | 815 |
| Ditto | Part III, Chemistry of the oxidized zone | 893 |
| Sutter Creek, notes on | 925 | |
| Swansea, Wales, smelting at | 122 | |
| Swaren, J. W. | 932 | |
| Volunteer engineer corps | 932 | |
| Syndicate mine, Philippines, notes on | 900 | |

T

| | |
|--|---------------|
| Tailing for mine filling in Michigan | 878 |
| Treatment at Calumet & Hecla | 883 |
| Treatment at Joplin | 957 |
| Tamarack Mining Co., company report | 843 |
| Mine, Michigan, notes on | 429 |
| Notes on | 788 |
| Tamping, notes on | 833 |
| Tanberg Oil Co. | 351 |
| Tax on mining profits in Canada | 957 |
| Taxes in Michigan raised | 957 |
| Technical journalism on mining education, the influence of | T. A. Rickard |
| Ditto | 229 |
| Ditto | 642 |
| Ditto | 435 |
| Ditto | 437 |
| Ditto | 139 |
| Ditto | 290 |
| Ditto | 785 |
| Ditto | 582 |
| Ditto | 768 |
| Ditto | 519 |
| Ditto | 899 |
| Ditto | 35 |
| Ditto | 44 |
| Ditto | 8 |
| Ditto | 44 |
| Ditto | 100 |
| Ditto | 32 |
| Ditto | 851 |
| Ditto | 281 |
| Ditto | 83 |
| Ditto | 159 |
| Ditto | 518 |
| Ditto | 878 |
| Ditto | 624 |
| Ditto | 715 |
| Ditto | 832 |
| Ditto | 861 |
| Ditto | 339 |
| Ditto | 180 |
| Ditto | Every Week |
| Ditto | 638 |
| Ditto | 122 |
| Ditto | 152 |
| Ditto | 417 |
| Ditto | 521 |
| Ditto | 152 |
| Ditto | 22 |
| Ditto | 119 |
| Ditto | 737 |
| Ditto | 498 |
| Ditto | 456 |
| Ditto | 221 |
| Ditto | 843 |
| Ditto | 654 |
| Ditto | 922 |
| Ditto | 215 |
| Ditto | 906 |
| Ditto | 797 |
| Ditto | 448 |
| Ditto | 913 |
| Ditto | 964 |
| Ditto | 623 |
| Ditto | 925 |
| Ditto | 482 |
| Ditto | 80 |
| Ditto | 131 |
| Ditto | 255 |
| Ditto | 591 |
| Ditto | 794 |
| Ditto | 189 |
| Ditto | 172 |
| Ditto | 157 |
| Ditto | 512 |
| Ditto | 433 |
| Ditto | 863 |
| Ditto | 168 |
| Ditto | 50 |
| Ditto | 662 |
| Ditto | 586 |
| Ditto | 103 |

| | |
|-----------------------------------|------------|
| Treatment (continued). | Page. |
| Of zinc at Anaconda | 548 |
| Ditto, at Wisconsin | 587 |
| Ditto, at New dry-house | 305 |
| Ditto, at safety | 342 |
| Ditto, notes on | 417 |
| Ditto, use of worn | 36 |
| Ditto, car-wheels for | 381 |
| Ditto, Arizona | 526 |
| Ditto, Arizona | 769 |
| Ditto, Arizona | 847 |
| Ditto, Arizona | 317 |
| Ditto, Arizona | 165 |
| Ditto, Arizona | 485 |
| Ditto, Arizona | 527 |
| Ditto, Arizona | 495 |
| Ditto, Arizona | 106 |
| Ditto, Arizona | 523 |
| Ditto, Arizona | 526 |
| Ditto, Arizona | 489 |
| Ditto, Arizona | 137 |
| Ditto, Arizona | 791 |
| Ditto, Arizona | 361 |
| Ditto, Arizona | 192 |
| Ditto, Arizona | 604 |
| Ditto, Arizona | 831 |
| Ditto, Arizona | 647 |
| Ditto, Arizona | 761 |
| Ditto, Arizona | 526 |
| Ditto, Arizona | 131 |
| Ditto, Arizona | 188 |
| Ditto, Arizona | 173 |
| Ditto, Arizona | 134 |
| Ditto, Arizona | 797 |
| Ditto, Arizona | 681 |
| Ditto, Arizona | 495 |
| Ditto, Arizona | 719 |
| Ditto, Arizona | 825 |
| Ditto, Arizona | 751 |
| Ditto, Arizona | 567 |
| Ditto, Arizona | 33 |
| Ditto, Arizona | 166 |
| Ditto, Arizona | 488 |
| Ditto, Arizona | 21 |
| Ditto, Arizona | 926 |
| Ditto, Arizona | Every Week |
| Ditto, Arizona | 916 |
| Ditto, Arizona | 657 |
| Ditto, Arizona | 941 |
| Ditto, Arizona | 592 |
| Ditto, Arizona | 563 |
| Ditto, Arizona | 136 |
| Ditto, Arizona | 136 |
| Ditto, Arizona | 765 |
| Ditto, Arizona | 884 |
| Ditto, Arizona | 252 |

U

| | |
|---|---------------|
| Union Hill mine, gold and scheelite | 41 |
| United Gold Mining Co. in Oregon | 650 |
| United States Assay Office at New York overflows | 50 |
| Capital invested in Mexico | 431 |
| Dredging in the | H. I. McCasky |
| Exports of products for warlike purposes | 925 |
| Gold and silver production of | 194 |
| Internal trade | 151 |
| Outlook for 1915 | 2 |
| Water power in | 365 |
| United States Bureau of Mines investigations | 1 |
| Safety department, legislation affecting | 259 |
| United States Geological Survey, 1915, statistics | 316 |
| Ditto, cannot make assays | 642 |
| Ditto, number of queries answered | 189 |
| Ditto, San Francisco branch, information available from | 532 |
| United States Manganese Corporation | 648 |
| United States Reduction & Refining Co., Colorado, property sale | 720 |
| United States Smelting, Refining & Mining Co., company report | 285 |
| Ditto, new work in Colorado | 746 |
| Ditto, work at its Midvale smelter | 736 |
| Smelting | Editorial |
| United States Steel Corporation's operations in 1915 | 678 |
| United States Zinc Smelting Corporation | 680 |
| United Verde mine, geology of | 671 |
| United Verde Extension Mining Co., company report | 381 |
| Mime, recent developments in | 625 |
| Uppis, use of word | 129 |
| Uranium and radium ores | 148 |
| In Madagascar | 832 |
| Use of furnace slag | Herbert Lang |
| Utah, metal output in 1915 | 27 |
| Mining in | L. O. Howard |
| Ozokerite in | L. O. Howard |
| Smelters and samplers congested with ore | 95 |
| Utah Consolidated Mining Co., company report | 768 |
| Utah Copper Co., company report | 328 |
| Utah Metal & Tunnel Co., company report | 124 |
| Utica Mining Co., Cal., work of | 174 |

V

| | |
|--|-------------------|
| Valdez Creek Placer Mines Co., progress of | 250 |
| Value of a mine, the present | F. Sommer |
| Valuna, complex ores | A. M. P. |
| Van Amsdale, G. D. | Flotation process |
| Vanadium in Arizona | 697 |
| Metallic, first prepared | 642 |
| Minerals, test for | 117 |
| Mining in Colorado | 404 |
| Mining in Montana | 354 |
| Ore, occurrence of | 602 |
| Price of | 572 |



EDITORIAL



T. A. RICKARD, *Editor*

SELF-SUFFICINGNESS of the mineral resources of this country is emphasized by the Secretary of the Interior in a recent report. He points to the fact that a battleship or an automobile can be built entirely from the products of American mines. The tires of the automobile are excepted, for rubber is not an indigenous product, and will not be until the synthetic article can be manufactured. For the rest, this country produces 55% of the world's copper, 40% of the coal and iron, 32% of the lead and zinc, but no tin or nickel worthy of mention. However, neither need be used in the construction of either the battleship or the automobile, for tungsten, manganese, and vanadium can be substituted for the nickel, and zinc for the tin. Thus Mr. Franklin K. Lane's boast is justified.

THIS PAPER is devoted to the technology of mining and to the advancement of the mining profession, therefore it rejoices in the progress of the one and the prosperity of the other, yet we regret often in these history-making days that the scope of our function restricts us from touching upon wider and more acutely controversial subjects, of far greater importance to the world at large. To dwell upon the prospects of good business in this tragic time does indeed bear the look of gross materialism. We must accept our limitations, otherwise these pages might become filled with non-technical discussion. May we be permitted to quote just this from Mr. E. S. Martin: "Whether there are more people in the world or less, whether they are fat or lean, whether they are Fords or oxen, makes no vital difference; but whether men shall be willing to die for what they believe makes all the difference between a pigsty and Paradise. Not by bread alone, Henry, shall men live." And is it not also true, as the Colonel of Rough Riders has said, that "the man who is too proud to fight is in practice always treated as just proud enough to be kicked." In other words, we wish that our national prosperity were better deserved. It is the old and iterative question that like Banquo's ghost rises to chill the gladness of the feast: can we industrialize our lives without commercializing our souls? That is the problem of American democracy.

AMONG the best features of the recent Exposition was the co-operative metallurgical exhibit made under the management of the U. S. Bureau of Mines. In connection with this exhibit a number of investigations into definite metallurgical problems were started under the auspices of a special committee organized by Mr. Charles E. van Barneveld, the chief of the Mines

and Metallurgy department of the Exposition. By a happy coincidence Mr. van Barneveld was appointed professor of mining in the University of California while still responsible for the work above mentioned, so that he was able, aided by the gentlemen of the Bureau of Mines, to arrange for a continuance of the research at the University. Among the problems to be studied are (1) the chemistry of roasting sulphide ores in the presence of water vapors, (2) the absorption of sulphur dioxide in various absorbents, (3) the distillation of sulphur from sulphide ores, (4) the thiogen process, (5) the loss of copper in reverberatory-furnace slags. The chemical work is being done by Mr. L. H. Duschak and the pyro-metallurgy by Mr. A. E. Wells. Moreover, Mr. G. H. Clevenger will proceed with hydro-metallurgical investigations at Stanford University, among the problems assigned to him being (1) sizing tests, (2) cyanidation of refractory silver minerals, and (3) the standardization of analytical methods in mills. All of this, of course, is much to the point and promises to be of direct benefit to the mining industry.

LABOR will be a determining factor in the prosperity now promised to the United States. It is time for the managers of mining and smelting companies to recognize the grave danger that may shatter their hope of successful effort if they fail to face this basic problem frankly. The higher cost of living will cause a logical demand for a rise in the scale of wages. If labor shares the loss of capital in bad times, it should share the larger profit in good times. The obvious thing to have done was to fix a minimum wage during a period of depression and then to make an increase based upon the relative increment of profit in periods of commercial affluence. It is a mistake to postpone the adjustment until it is extorted by the violence of a strike. We do not follow such a plan in our dealings with members of a staff, whether in the office or at home. An attempt should be made to promote a feeling of reasonableness and mutual consideration. Now is the time to start. If only the suspicious attitude of labor to capital could be modified by genuine fair dealing, it would be possible not only to soothe labor unrest but render nugatory the conspiracies of the anarchistic organizations that thrive on the unthinking antagonism of managers and men. Both employer and employee are destined to prosper exceedingly in the near future if they can agree to be reasonable; both may taste the sour grapes of disappointment if they antagonize each other needlessly. It is useless for the day's pay man, and it is stupid of the captain of industry, to think that either can exorcize this

devil of disquiet by shutting his eyes and mumbling the old platitudes. Let them get together to the good of both and the well being of the community.

REVISION of the mining law will receive the support of the Secretary of the Interior, judging by the remarks in his annual report, in which he says that "the old code is so elaborate and complicated that the best of brains cannot tell what the law is. The truth seems to be that between mining engineers and mining lawyers the rules of the game have been refined into obscurity, and if Congress were to say to the President that he might select three men familiar with mining laws and miners' difficulties to suggest a new mining code to Congress, it would, I believe, be giving in earnest a new freedom to the mining industry." This is of good omen for the success of the steps taken at the recent representative meeting at Washington under the auspices of the Mining and Metallurgical Society of America, on which occasion resolutions were passed recommending thorough revision of the mining law by a Government Commission composed of five members, one representing the legal profession, one representing the Department of the Interior, and three men actively experienced in the mining and acquisition of mineral land. In order to further the best interests of the mining industry in this matter, it was further resolved to create a permanent committee on mining law revision, this committee to consist of five members from the Mining and Metallurgical Society, five from the American Institute, and five from the American Mining Congress. We congratulate Messrs. H. V. Winchell, Curtis H. Lindley, John W. Finch, and our other friends on their successful effort. May it succeed!

The Outlook

Watchman, what of the day? We stand on the threshold of a new year, while the shadows of the dawn are still about us. In the east, whence light should come, we see black darkness riven with lurid lightnings, and through the gloom is heard the sound of a great weeping. In the west, where day should wane, we see a brightening, a growing radiance that presages the sunshine of happier hours.

Indeed, the people of the United States at the beginning of 1916 may well wax rhapsodical when they remember how deep was their dismay and how great their confusion only twelve months ago. Then the stock-markets were closed to prevent hysterical liquidation, finance was disorganized by a break-down of international exchange, mines, mills, and factories were working half-time, a gathering mass of unemployment threatened general distress, and worse than any actual evil was the fear of the future. Now, the stock-markets are pulsating with excitement, industrial activity has been resumed vigorously, business is expanding mightily, there is work for everybody, and a convincing optimism pervades the air. Confidence has been restored. Money is plentiful, because Europe has sent us a plethora of gold

in return for the grain, metals, and other supplies that we are selling at an unprecedented rate. The steel industry, that barometer of business, is booming. Even the railroads are beginning to recover, and in some cases are smothered by traffic. Idle cars are as scarce as idle men. Mining is in the ascendant, for the world is consuming metals of every kind.

For the moment, all is serene; what of the future? Is the astonishing business in munitions to collapse suddenly at the first authentic breath of peace and will the collapse bring down a mere house of cards founded on a fictitious trade? Will the rapid accumulation of gold induce a fever of speculation and an orgy of extravagance just when the rehabilitation of Europe will bring us into keen competition with newly organized masses of relatively cheap labor? It is well to consider these questions and to pause in our jubilation. The happy-go-lucky or *laissez faire* habits of this unorganized democracy may verge at times on the edge of industrial anarchy. A policy of simple drift may bring disaster. It is the part of a wise man or a sagacious community to look ahead and steer a definite course.

So far, so good. Neither a welter of speculation nor a debauch of extravagance has overcome this country, as yet. The public has been warned and has taken the warning to heart. Wall Street is not the United States. The average citizen has not gone drunk with a crazy optimism; on the contrary, he is asking seriously what he is to anticipate. He sees rocks ahead and is willing to be piloted. It is generally realized that the outstanding problem is to shift the intensified activity in the abnormal manufacture of munitions and other exports of war to the up-building of domestic trade and the creation of new channels of peaceful commerce abroad. This is being done. War orders are playing a steadily decreasing part in our prosperity. The profit made by them is being diverted to the renovation of manufactories in need of working capital and to the starting of industries of a less ephemeral nature than the making of shells and howitzers. Purely domestic development is receiving proper attention. Successful efforts have been made to establish commercial relations with South America and other countries hitherto accustomed to do the chief part of their business with Europe. This justifies the expectation that the end of the War will mark the beginning of a new prosperity based upon logical development. The United States will be the only large industrial organism in a condition to supply the wants of the countries devastated and depleted by war. The loss of capital and of men in Europe will be so crippling as to compel an insistent call for the manufacturing, agricultural, and metallic products of this country. Not that it will be all plain sailing, for the adjustment of international exchange, the rise in American wages, the higher cost of living, and other factors will make big perturbations. On the whole, however, the outlook is good, particularly for metal mining.

We see no reason to amend the forecast presented to our readers several months ago in regard to the demand for metals in the near future. Later events have been

confirmatory, as well as the prognostications of sundry authorities eminent in finance and trade. The consumption of the base metals in the making of munitions is anomalous, of course, but it will become a less decisive factor as industrial development gains ground. As against the loss of this market on the declaration of peace we can place the resumption of the usual demand from the countries now entirely closed to American exports. Whatever the decision of the sword, Germany will continue to be a great industrial country. Austria also, whether aggrandized or partitioned at the close of hostilities, will resume dealings with the United States. Of the copper produced in this country, about 30% goes normally to Germany. Besides the normal consumption there will be, when peace supervenes, a replacement of at least a part of the metal taken out of ordinary use by the exigencies of war. The whole of the American lead production is usually required for home consumption. In 1914 exports of domestic lead, amounting to 58,700 short tons, were made to Europe for the first time in many years. The War has interrupted the smelting of foreign ores and concentrates both in Belgium and in Germany, cutting down the output from Australia, more particularly, where domestic smelting is now being stimulated by the State regulation of mineral exports. At the conclusion of hostilities, there should be a demand from Europe for American lead to supply deficiencies created by wastage and destruction. This applies also to zinc, which, like lead, is produced in this country at a rate only slightly in excess of consumption. That excess, however, is increasing. During 1913 and 1914 it was 14%; in 1912 and 1911 consumption and production were just about equal. The War killed the Belgian zinc-smelting industry and interfered with that of Germany. Since hostilities began the successful development of the leaching and electrolytic precipitation process in this country promises to become a big factor in cheapening the production of the metal and in aiding competition with the European smelters. The continued progress being made in the metallurgical reduction of the base metals tends to strengthen the smelting industry of the United States, thereby establishing an increasingly better market for the produce of the mines at home and also abroad. With the growth of domestic consumption consequent upon the expansion of domestic industry and the exceptional demand from Europe resulting from the tremendous work of reconstruction, there should be a splendid market for the metals during the coming years. By that we do not mean that the present prices of the metals will persist undiminished; that would be too much to expect, and would provoke a corrective, in the form of substitutions, likely to be injurious in the long run. The price of zinc, for example, is such as to hurt the galvanized iron trade and cause a demand for a substitute plating. Severe discountings of existing prices for copper and zinc, more particularly, are possible without serious injury to legitimate mining. Copper at 17 cents, and zinc at 8 cents would afford ample margin for handsome profits. Allowing room for such contingencies, the outlook for metal mining is good.

Dry Mining

We are glad to be able to give our readers a timely article on Oatman, the resuscitated goldfield in Arizona. It is being featured in the daily press as a new discovery, but in reality it marks the revival of activity in the desert country around the old Gold Road and Tom Reed mines, brought into fresh prominence by the development of a new rich mine, the United Eastern. The resuscitation or revival has been effected without the aid of alcoholic stimulants, for Oatman is a dry camp. In his happy presentment of the picturesque features of this new rush, Mr. Frank H. Probert lays emphasis on the fact that prohibition renders Oatman wholly unlike the mining excitements of former days. Undoubtedly the result is the loss of a certain kind of pseudo-romantic glow such as glorifies the Outcasts of Poker Flat and the Idyll of Red Gulch, but that is something more essential to frontier poetry than to human progress. It seems strange to the veterans of the West to think of an Arizonan boom devoid of the necessities of exhilaration, and it seems equally strange that in the new year our friends in Colorado should be facing a similar break with all the traditions of the past, for their courts also have decided that prohibition must be absolute. Our correspondent at Denver views the prospect with ill-concealed dismay, while recognizing frankly that the open saloon is an institution not essential to civilization. The West is outgrowing the recklessness of youth and no longer confuses good fellowship with a superabundance of cocktails. So we shall neither sneer at, nor commiserate with, Oatman. The money that would have gone to the mixologists and distilleries will be kept for the more productive purpose of exploring the desert rocks in search of the precious metal. And the painfully sober prospector is doing it vigorously and effectively, according to all accounts. The geological structure offers no short cuts to wealth, as is clear from the preliminary diagnosis of Mr. Probert. Much more investigation is necessary, as he indicates while offering some pertinent suggestions. Hitherto some of the best ore-bodies have been found at a distance below the surface, thus creating the pleasant delusion that enrichment is a consequence of depth. One swallow does not make a summer—nor even a drink—at Oatman; likewise the fact that two shafts did not strike good ore until 300 feet was reached does not constitute evidence on which to build the idea of an ore-bearing horizon at a fixed distance from grass-roots. Of course, we appreciate the fact that, in determining the probable value of a prospect, the postponement of the critical point until the workings have reached a given depth is not without practical value in ensuring a reasonable amount of vertical exploration. In a district where the ore-bodies have a decided pitch and are softer than the enclosing rock, such a supposition tends to promote systematic search. The story of Goldfield proves that a bonanza may fail to poke its head above the cactus. But we do deprecate the assumption, already current in brokerage

literature that a poor showing at surface is not discouraging, nay, almost furnishes proof of the richness of the vein at 300 feet, for that is what happened in the United Eastern, so it is said. However, the humor of the position is evident. We believe that the enforced sobriety of the mining population of Oatman will not be without effect in modifying the imagination of the promoter and in giving legitimate mining a fair chance. Interesting developments may be expected in this part of Arizona during 1916.

Mining at Juneau

We note that our contemporary at New York, the *Mining Journal*, has had something further to say concerning the exploitation of the big lode that traverses the Gastineau and Juneau groups of claims in Alaska. As is stated truly, the subject is one of interest "not only to thousands of investors in the shares of these companies, but also to the engineering profession." We are told that "the problem itself involves the mining and milling at a profit of ore that is expected to average only about \$1.50 per ton." No; the problem is to ascertain whether the expectation of a \$1.50 yield per ton is warranted under given conditions; to determine how small veins of quartz containing \$6 per ton in gold and dispersed over a big width of barren rock can be mined most profitably. The engineer's duty is to find out to what extent selection and sorting can be applied economically. Of course, the small gold-bearing veins traversing the slate lode could be mined and milled selectively at a cost about equal to their assay-value and in excess of their yield; on the other hand, the whole width of lode-matter could be mined indiscriminately and milled unsorted for a cost of about 50 cents per ton and a yield of perhaps 80 cents per ton, a margin sufficient to pay interest on the cost and depreciation of a suitable plant. Somewhere between these extremes is the economic limit that coincides with the maximum of profit. The engineers of the Juneau plan a \$1.20 recovery as best suited to the conditions in that mine; the Gastineau management planned a \$1.50 recovery, which now, by such accidents as are a part of the sport of mining, has been reduced to \$1 per ton. Our learned contemporary says that the one company intends to adopt "bulk mining," while the other applies "selective mining." This comparison is misleading. Both are aiming to restrict their stoping to mill-ore having the average yield that is most profitable, after balancing the three inter-dependent factors of tonnage, yield, and cost. The Juneau is selecting places suitable for bulk mining; the Gastineau is selecting places suitable for preferential mining, or sorting.

Another contemporary, usually well informed, the *Boston News Bureau*, publishes an article on the subject with the sub-title 'An Investment Proposition.' Both the New York and the Boston paper talk about the enterprise as an 'investment,' which, of course, it is not. It is, or may be, a highly attractive speculation, with all the risk inherent to gold mining. The promoters may

call it an 'investment' when addressing an unsophisticated public, but the engineering profession must be well aware that a wasting asset of uncertain life affords no basis for investment. However, we have digressed. The Boston paper asserts further that it is "a minor problem to balance ore mining below a dollar per ton by ore running up to \$3 or \$4 per ton, and make an average of \$1.50 per ton." The problem is one for a miner, not a humor. It constitutes the crux of the whole matter. We are told how "of course, the unexpected happened" and a collapse of ground spoiled some rich stopes. That, my dear Sir, is part of the problem in this kind of mining and it is one of the things that militate against the 'investment' idea. The Boston scribe says that "the ore is disseminated in fine particles through layers of slate, meta-gabbro, and schist," but he has not learned his lesson correctly. The wording smacks too much of a copper deposit in Utah or Arizona, and is not applicable to this Alaskan lode, in which the rock is enriched by gold in irregular veins of quartz, not by chalcocite pervading monzonite-porphry. The gold is not in the slate, schist, or meta-gabbro—nor in Shadrach, Meshach, and Abednego. Meanwhile nothing is said about that horse of schist that proved so destructive to the estimate of a large block of ore-bearing ground. Such happenings are part of the mining adventure and should not be exaggerated, but they inject an element of uncertainty into those approximations on which the exploitation of mines is based. These two big enterprises near Juneau require the most careful study of the most experienced engineers, and they are getting it, as would be better appreciated if the voice of the broker were not so loud.

Reverting to the explanations of the New York periodical, we find a curious blunder. The statement is made, in its issue of December 18, that the engineers of the Juneau "are going to adhere to the conventional stamps" while the Gastineau management has introduced the use of rolls into its mill. Our readers are better informed on this phase of the subject, for we discussed it at length in our issue of October 16. In the Gastineau mill the ore is reduced in a large jaw-crusher, passing thence to a series of gyratory crushers, and then in succession to roughing rolls, finishing rolls, and tube-mills. The Juneau mill has been designed on the same lines, except that ball-mills are substituted for the rolls. No stamps are to be used. Indeed, as we stated three months ago, a series of experiments is being made at Treadwell also with a view to determining whether it would not be advantageous to employ ball-mills, instead of stamps, in case a new central mill is erected to treat the output of the three contiguous mines on Douglas island. In these and other matters this part of Alaska is destined to afford much of interest and instruction to the mining profession. The men in control of the work at the three principal groups of properties—the Treadwell, Gastineau, and Juneau—are among the most experienced and resourceful in this country. If there be any rivalry, as our contemporary takes pains to suggest, we do not doubt that it will simply serve to give zest to the application of technical science on a splendid scale.



DISCUSSION

Our readers are invited to use this department for the discussion of technical and other matters pertaining to mining and metallurgy. The Editor welcomes the expression of views contrary to his own, believing that careful criticism is more valuable than casual compliment.

Valuing Complex Ores

The Editor:

Sir—I have noticed from time to time, articles by many different engineers and metallurgists, on the subject of mine valuation. I do not recall having seen anything in the nature of a discussion of ore valuation. Since my work for the past 13 years has been almost entirely along the lines of valuation of complex ores, especially those containing zinc, I propose to open the discussion, if indeed the subject is deemed worthy of such, by submitting the following:

Having worked out the treatment of several complex ores and having attempted to work a treatment for several hundred others, I have taken a specific case which has come to my personal attention and which, I believe, will serve the purpose of argument, more completely perhaps than a general discussion of the subject.

During the greater part of the present year, owing to increased activity in the zinc industry, engineers have had many occasions to examine and report on mines, the value of which has depended to a large extent upon the zinc content of the ore. The mine is sampled and the ore measured to a point where the engineer finds a certain number of tons carrying a certain amount of gold, silver, copper, lead, zinc, iron, and any other metal that can be recovered and sold. It is at this point in his examination that an understanding of the methods of treatment to be employed that will effect a commercial saving of the metals, the cost of such method, and the marketing of the products, is fully as essential to the correctness of his findings as is the knowledge of methods for sampling and measuring the ore. It is at this point that the assayer has found himself in a most embarrassing position, not on account of his inefficiency as an assayer, but because he has not the facts at hand upon which to base a sound opinion as to the value, in dollars and cents, of the ore upon which he has determined its metal contents. I have seen assay-certificates from reputable assayers which showed fully the metal contents, and, in the space for that purpose, was shown a value, calculated from the analysis. In many cases these 'values' have been found to represent the metal-values, based upon the current quotations for the different metals, and the ounces and pounds of the same metals delivered at New York. It is needless to say that this method is misleading and may result in financial disaster if further investigation is not undertaken.

Many engineers have attempted to estimate such ore-values by allowing 'liberal' losses. By this method

great mistakes may be made, chiefly because the losses allowed have not been sufficiently 'liberal.' It is my intention to show that there is no possible way by which these losses can be estimated. They must be determined accurately, and in most cases, they will be found to be surprisingly large.

Some months ago, I was asked by an engineer who had finished an examination, what percentage of saving could be reasonably expected by the most modern practices. I was told that the ore 'ran' \$12 per ton, allowing \$20 for gold, 50c. for silver, 50c. per unit for lead, and 60c. per unit for zinc. He had not assayed for iron, since it had little value. I was unable to make an estimate, because I did not know, nor did any one know, what grades of products could be made or how much of the gold and silver would be found in the zinc product. These facts, which are absolutely essential, can be determined, and must be determined, before the value of the mine can be definitely fixed.

To illustrate how difficult it would be to make an estimate of this kind, I submit the following table to show what products can be made and what money will actually be received at a certain stage of the metal market, for a certain ore.

| | Weight, % | Gold, oz. | Silver oz. | Lead, % | Zinc, % | Iron, % | Silica, % |
|--------------------|--------------|--------------|---------------|------------|------------|------------|--------------|
| Original ore..... | 100 | 0.07 | 9.00 | 8.00 | 16.00 | 7.00 | 46.00 |
| Lead product..... | 8 | 0.32 | 45.00 | 68.00 | 5.00 | 6.00 | 2.00 |
| Percentage saved.. | | 36.50 | 40.00 | 68.00 | 2.50 | 6.80 | 0.30 |
| Iron product..... | 14 | 0.22 | 17.00 | 8.00 | 11.00 | 32.00 | 6.00 |
| Percentage saved.. | | 44.60 | 26.40 | 14.00 | 9.50 | 64.00 | 1.80 |
| Zinc product..... | 26 | 0.02 | 6.50 | 2.60 | 48.00 | 5.00 | 10.00 |
| Percentage saved.. | | 8.50 | 19.00 | 8.60 | 78.00 | 18.50 | 5.60 |
| Slime | 7 | 0.04 | 11.00 | 7.00 | 12.00 | 6.50 | 49.00 |
| Percentage saved.. | | 4.00 | 8.50 | 6.10 | 5.20 | 6.50 | 7.40 |
| Tailing | 45 | 0.01 | 1.20 | 0.60 | 1.70 | 0.70 | 86.00 |
| Percentage lost... | | 6.40 | 6.00 | 3.30 | 4.70 | 4.20 | 84.90 |

It will be seen that the total concentrate carries 89.6% of the gold, 85.5% of the silver, 90.8% of the lead, and 90.1% of the zinc. This certainly can be called a high saving. The original ore, estimated upon metal contents and quotations, with gold at \$20, silver at 50c., lead at 4½c., and zinc at 5c., has a value of \$29.10. Estimated with gold and silver the same and lead at 50c. per unit and zinc at 60c. per unit, it has a value of \$19.50. When these products are sold, however, they will be sold about as follows: In lead concentrate we receive \$19 for gold, 47½c. for silver, 3¼c. for 90% of the lead (wet, less 1½), and 10c. for excess iron. We pay \$3 freight and no treatment charge. This leaves us \$63.75 per ton net, or \$5.10 per original ton.

Iron concentrate will bring the same prices for gold, silver, lead, and iron. We pay the same freight and about \$5.50 for treatment. This leaves \$11.31 per ton net, or \$1.57 per original ton.

The zinc concentrate, with spelter at 5c., and \$5.50 freight, will net \$19.30 per ton or \$5.02 per original ton.

These net receipts amount to \$11.69 per original ton, which is 31% of the assayer's figure and about 60% of the engineer's.

A careful analysis of the above figures will show that we have received net \$11.38 per ounce for gold, 25.2c. per ounce for silver, 2.09c. per pound for lead, and 1.57c. per pound for zinc, which figures may safely be applied to this particular ore so long as the grade does not change materially. The contracts upon which I have figured settlements may vary to some extent, but the general result will be about the same.

Thus it will be apparent to the investor and to his engineer that the metal contents and market prices of the metals cannot be used as a basis of calculation for valuing ore until it is fully and definitely known where these metals will be recovered and what prices will be received for the various products.

A. M. PLUMB.

Denver, December 18, 1915.

Why Is Flotation?

The Editor:

Sir—Please allow me to contribute to 'Why is Flotation?' for I have worked on the subject more or less since 1903.

In the effort to elucidate flotation, a common error is made of trying to fit one explanation to both film, or skin, and frothing methods. The surface tension theory will fit the skin method, but cuts no figure with frothing. This will be seen as we progress.

To begin, what is a bubble? Webster defines it as "a small body of air surrounded by a liquid." Being lighter, it rises through the liquid, and on reaching the surface presses upward, not against the liquid, but a fluid as light as itself. There is no further bar to its progress, so it escapes and joins the aforesaid fluid, known as the atmosphere.

In this case, differences of specific gravity rule, which is precisely what governs conditions when oil in a finely-divided state is released below a water surface. This strong upward pull of both air and oil, due to gravity differences between them and water, is of prime importance in practical flotation work.

If a close-fitting glass-plate is introduced into a tank, just under the water surface, air and finely divided oil will collect against it, when they are released from below. If a sufficient quantity of each is used and the entire space on the under side is covered, an addition will result in the gradual displacement of the water from the area, and a collecting together of two large separate globules of air and oil. Remove the plate, and the air, having in the large globule the sum of the combined bubble pressures, escapes to the atmosphere, while the

oil tends to diffuse itself over the surface of the water.

Continuing our experiment, we have now an elastic film of oil on the water surface, instead of the glass plate. A further addition from below of both oil and air causes the former to join the film, while the latter, in its effort to unite with the atmosphere, impinges sharply against the lower surface of the oil film, raising it upward in a partly spherical form. If the oil film were now as solid as the glass plate, no doubt the same collection into separate globules would obtain. The point, however, to be noted, is that each factor in the experiment remains separate, namely, oil, air, and water.

We left the bubble slightly above the water surface and against the oil film, but not detached. On renewing the flow of air and oil from below, we find that the pressure of others will lift the bubble completely out of the water into the oil. When the lower part of the sphere is high enough the oil ends will join and we now have a bubble detached from the water, resting in oil and on the water surface. It has no water in its composition, floats easily, and holds its shape and character in the open air, whereas previously it could only exist under water.

Wherefore, with a continuous supply of oil and air, bubble manufacture will proceed until the surface is covered with a thick coherent mass called a 'froth,' and a superficial study will show that surface tension, as commonly defined, plays no part in the phenomena.

In my opinion there is no selective action between oil and certain constituents of an oil pulp. Each particle in the pulp takes its oil coating impartially, but some, like the oxides, carbonates, and silicates, part with it quickly in the presence of water, while others, like the sulphides, cling to it obstinately. A sulphide particle, satisfied as to its oil requirements, gives up no part of its oil coating to feed the surface film, so necessary for the preservation of the air bubble, this factor being furnished by the oil from the oxides, carbonates, and silicates. Consequently, when submerged in water, the upward pull of the oil coating of the sulphide particle keeps it in a state of unstable buoyancy. It should be noted at this time that with frothing methods, the oiling takes place in the advance stages of treatment, and from the above we glean that it is important that all constituents be coated equally.

Agitation in frothing work serves to introduce air into the water, and to a less degree keeps the entering pulp in partial suspension therein. The method employed is unimportant in this discussion.

In the light of the above reasoning, what happens when a froth-flotation machine is started and in operation?

On starting the agitators in clean water, myriads of small bubbles form, due to air beaten in or furnished otherwise. Their natural path is upward, and in clean water they break at the surface.

But a change takes place when the ore pulp, previously oiled, is added. The pulp particles on entering the water, quickly give up the oil from the oxides, carbonates, and silicates, that forms the preserving surface

film. The sulphides, being in a state of unstable buoyancy and clinging obstinately to their oiled coatings, are kept in suspension or driven upward by the agitation. In moving through the water they cross the path of innumerable air bubbles, and find no difficulty in annexing enough to assist the buoyancy. There is drive enough to impinge them violently against the oil film and the pressure of myriads following, gives force enough to elevate them above the water surface into the familiar froth. The gangue minerals, having no buoyancy, sink.

In practical frothing work, the design of the principal factors is of importance. The size of the agitation-boxes should be the smallest possible compatible with the tonnage-capacity desired. Agitators should be so gauged and designed as to form a uniformly sized bubble, large enough to have the maximum transporting power without reducing the number thereof. The oil should be of a nature allowing maximum stretch at the surface, and just tough enough to stand wear and tear. The lower its specific gravity, in combination with the other qualities desired, the greater its pulling or lifting power. Oiling should be done during grinding, if possible, as it gives a better mix.

Heating the water thins the oil and lessens the consumption, but gives a more delicate bubble covering. It has this advantage, that it heats the air inside the bubble, increasing its pulling or lifting power, and should enable the treatment of coarser sizes, but this may be modified by the fact of its tending to rob the sulphide of the oil coating, thus reducing the pull.

I think acid roughens and increases the sulphide area, allowing more oil to adhere, and assisting buoyancy. Possibly it generates a gas that acts like air. The old theory of calcite being necessary in the pulp for bubble-lifting is doubtful. Carbonic acid gas is heavier than air.

A lot of study has been bestowed on oils, but very little on the other factors that are nearly as important. Machines or methods of agitation designed to improve and control the uniform size and number of the bubbles have been little considered.

As to lifting power or pull, I can remember a painful experience of my boyhood days, when the janitor caught us blowing soap bubbles, by holding a soaped spool tightly over a gas-burner tip. Filling the interior of the bubble with illuminating gas sent it out of sight with no effort. When caught, we had the school population gazing heavenward, and the ceiling of the room was one mass of bubbles, some of which lasted for an hour.

In the pneumatic systems of agitation the addition of a small quantity of illuminating gas, may give as good pull as heating.

In 1904, I think, while experimenting at Sandon, B. C., I used a small tank and about 15 Daniels cells for bubble-making purposes. With a weak electrolyte, a copper plate on one side and a bunch of hay-wire on the other, I found that by stirring in an oiled pulp I could get a thick skin of bubbles. My apparatus was limited and soon exhausted the electrolyte, but I got a good flotation after the froth order. I remember the speed

and size was marvelous and under close control. The batteries belonged to the telegraph company. I was an underpaid operator, and the fool superintendent was woefully obstinate, ignorant of research, and painfully insistent on the restoration to service of his 15 cells. The combination floored me.

I recollect detailing the operation to an Elmore representative soon after, but did not know until Hoover's book, 'Principles of Flotation,' came out that the ideas had been patented in Great Britain. However, that method of generating a hydrogen-filled bubble under close control, with electricity, is open for use in this country. It was not patented here. Who knows but what some genius will utilize it, or the illuminating gas, to fill bubbles that will haul the ore direct to the smelter from the flotation-cell?

GEORGE HUSTON.

Mullan, Idaho, November 12, 1915.

Flotation Residue

The Editor:

Sir—I was much interested in reading the article on 'Disposal of Flotation Residue,' by my friend Wilton Shellshear of Broken Hill, but for the honor of Australia I must differ from him regarding the system of spraying slime over sand-dumps. He says "the idea was first originated in South Africa, and has only lately been introduced into Australia." Strictly speaking, he may be correct, as he speaks of pumping or spraying slime. But I would like to say that I saw slime-residue from a Moore filter (the first one successfully used in Australia) spread over the surface of a sand-dump from trucks at the Occidental gold mine, Cobar, New South Wales, in 1905 or 1906. I think A. J. Chapple, who was then the metallurgist there, will corroborate this. When was this system first used in South Africa? I saw it at New Modderfontein in 1911.

W. MOTHERWELL.

Colorado Springs, December 15, 1915.

GUATEMALA, the northernmost of the Central American republics, has an area of 48,290 square miles, which exceeds that of Pennsylvania. The population is 2,119,165, which is nearly as much as Bolivia, whose area is 15 times as great; the capital, Guatemala City, has a population of 125,000; while the bulk of the people lives in the half of the country lying toward the Pacific, the steamship communication on that coast is less frequent than on the Atlantic side. Although in the torrid zone most of the country is at 4000 to 11,000 ft. altitude, and the climate is comparatively healthy and agreeable. About 60% of the imports comes from the United States, but the bulk of the exports has gone to Germany. The monetary system needs re-organization, and a gold standard would benefit finances. The railroads are owned practically entirely in the United States, but in other lines investment of American capital is small as yet. In Guatemala City the tram-line is run with horse and mule power.

Testing Ores for the Flotation Process

By O. C. Ralston and Glenn L. Allen

INTRODUCTION *Although the subject of testing for flotation has been well presented in T. J. Hoover's book on 'Concentrating Ores by Flotation,' there is need of later information on this timely subject. Much testing has been done in laboratories not connected in any way with the Minerals Separation company, with which Mr. Hoover was formerly associated as metallurgical engineer, and there have been developed methods of investigation that may prove suggestive to many experimenters.

On that account we have compiled data on the subject of testing both from the literature available and from our own experience, as well as from what we have seen in other laboratories. This paper is designed to present the results of this compilation, with a critical discussion of the more important methods now in vogue.

On account of the empirical state of the art of flotation a great deal of testing is necessary before large-scale practice can be commenced on any ore; therefore a small laboratory-machine is necessary in which many tests involving many variables can be made in a short time. The machine must be so designed and so operated that a close approximation to the results possible with full-sized flotation machinery will be obtained. In a mill-plant it is a matter of some difficulty to control conditions through a wide range of such variables as temperature, acidity, quantity of oil, percentage of solids in pulp, fineness of grinding, etc., and as the proper treatment of a given ore can be ascertained only through testing it first, a critique of the testing methods in use is in order.

Many people have had the experience of reading the available literature on flotation testing and of failing to get satisfactory results when the described testing was attempted. To actually witness some good test-work and learn thereby the appearance of froth, the exact manipulation of the machine and froth, goes far toward bringing the beginner to a point where he can test efficiently. None of the literature mentions the fact that it is difficult to get a high percentage of extraction and a high grade of flotation concentrate at the same time. The beginner often strives after both of these things in a single test, whereas he should determine how each can be attained before he attempts to obtain both simultaneously. Furthermore, it is difficult to manipulate a small machine to give as good results as a large one, until after consider-

able practice. So the small machine is generally pessimistic, compared with the large one. It is practically essential for the beginner to weigh and assay all of his products in order to see if the extraction and the grade of concentrate are satisfactory, where an experienced manipulator can often tell by aid of past experience and the use of a glass or microscope whether he is getting good results or not.

With these points in view, we shall describe first the satisfactory machines and their operation. Then we shall give a more general exposition on what variables to study and what points to observe.

Flotation test-apparatus must necessarily be classi-

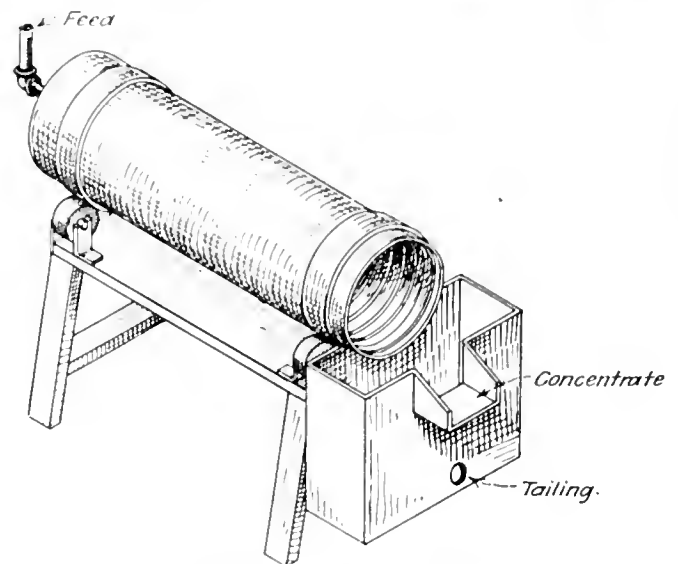

FIG. 1. THE MACQUISTEN TUBE.

fied in the same way as large-scale machines, namely, as film-flotation machines, acid-flotation machines, and froth-machines of both pneumatic and mechanically agitated types. Film-flotation, as exemplified in the Macquisten¹ and in the Wood machines, does not seem to have the same wide application as does froth-flotation; hence little need be said about them.

FILM-FLotation. Macquisten tubes have such small capacity that a single tube is small enough for test-work on a few pounds of ore at a time (see Fig. 1). A small 4-ft. tube is known to give trustworthy results, although a longer one is more desirable. Testing with a Macquisten tube was done for several years in the laboratory of the General Engineering Co., of Salt Lake City, of which company J. M. Callow is president. Since Mr. Callow has begun the exploitation of his own pneumatic frothing-machine this work has been set aside.

*By permission of the Director, U. S. Bureau of Mines. Communicated by D. A. Lyon, metallurgist in charge of the Salt Lake station of the U. S. Bureau of Mines, co-operating with the University of Utah. O. C. Ralston, Assistant Metallurgist of U. S. Bureau of Mines, and Glenn L. Allen, Research Fellow of the University of Utah.

The Wood machine can be built in miniature and for several years a small machine of the type sketched has been used in the plant of the Wood ore-testing works at Denver.² This small machine was about two feet long and one foot wide. The method of operation is the same as that of the full-sized machine. (See Fig. 2.)

As neither of these machines has been much used in practice, they are merely mentioned for the sake of completeness. Hoover³ has recommended a test on a vaning-plaque, so that the sulphides will float off onto

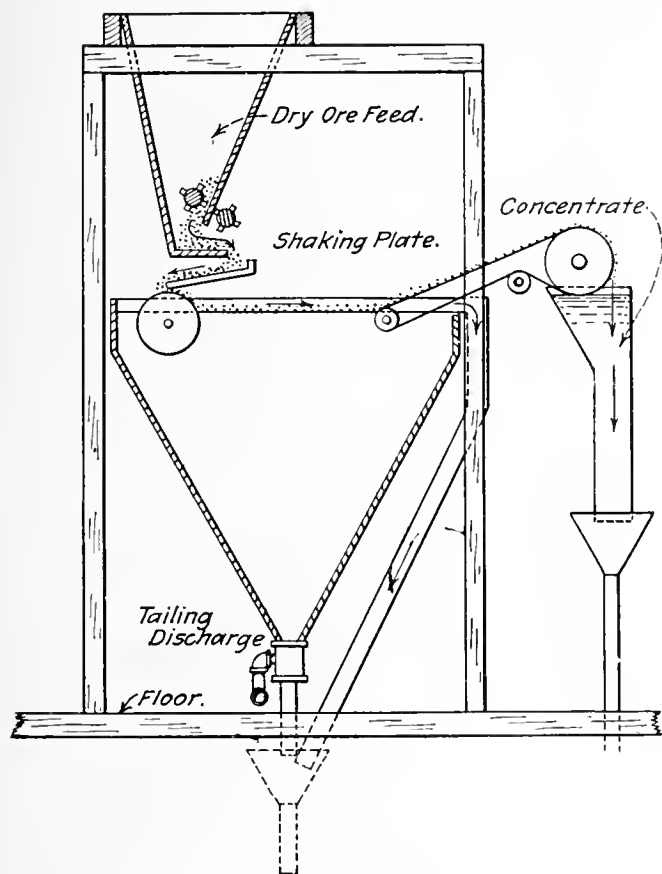

FIG. 2. THE WOOD MACHINE.

the surface of the water, but we consider this test of practically no value. Hoover, however, acknowledges that it is merely a test illustrative of the film processes.

In testing ores for the Potter or the Delprat processes, Hoover's text is again the source of information. An illustrative test-tube experiment is pictured in Fig. 3. In another test a 200-c.c. beaker is used with 100 c.c. of 3% H_2SO_4 and brought to nearly boiling temperature. The ore when introduced into this yields a froth composed of sulphides supported by bubbles of CO_2 . In case the ore is deficient in carbonate, an addition of as much as 3% of calcite or siderite is made. The froth is skimmed with a spoon as fast as it forms. We have noticed that a great deal of mineral is often lifted partly but never reaches the surface. Consequently extractions

are low, although the grade of concentrate obtained is often very good. For practical purposes, however, the test is not of much value. A better test-machine is the small unit shown in Fig. 4. The acid should be allowed to run down through a section of garden-hose to within an inch of the surface of the ore and the ore should be kept stirred with a wooden paddle so that the bubbles

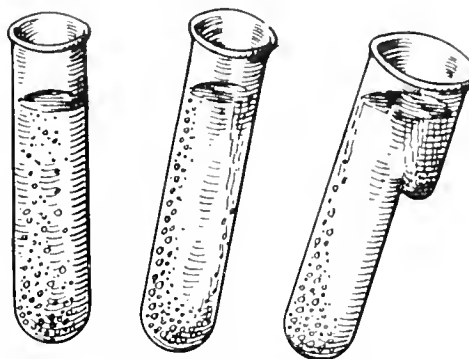

FIG. 3. TEST-TUBES FOR FLOTATION.

of CO_2 generated by the action of the acid can lift the sulphides out of the body of the pulp. The froth formed should be skimmed with the paddle as fast as made, then filtered, dried, weighed, and analyzed. Not many ores yield gracefully to this treatment and slimes give poor extractions. Fines and Wilfley-table middlings are better adapted, and the presence of siderite in the pulp is desirable, as it reacts slowly with dilute acid. From

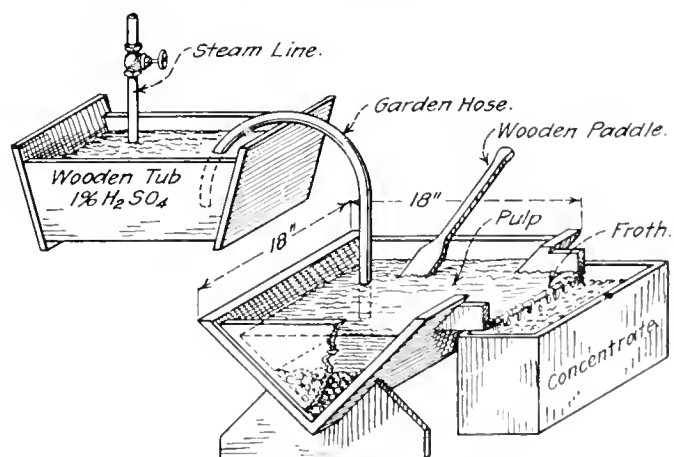

FIG. 4. A POTTER-DELPAT TEST.

1 to 3% H_2SO_4 is best in testing and $\frac{1}{2}$ to 1½% solutions on the large scale will give about the same results. The temperature of the pulp should be maintained at 70°C. by use of a steam jet. Five to ten pounds of ore per test is necessary. The extractions obtained are always lower than in full-sized units. While oil is not necessary in this process it will greatly assist in the flotation, and the addition of a small amount is often of much assistance in test-work.

MECHANICAL FROTHING as developed by the Minerals Separation company in England and Australia, and modified by many others, has been one of the most im-

²H. E. Wood. Trans. A. I. M. E., Vol. XLIV, pp. 684-701 (1912).

³T. J. Hoover. 'Concentrating Ores by Flotation,' 1st edition, page 77.

portant methods of flotation. Therefore the laboratory machinery that has been developed is at as high a state of perfection as any such machinery now in use.

The Janney machine is probably the best designed machine for getting reliable quantitative results on a small quantity of ore. Photographs and sketches are appended (Fig. 5, 6, and 7). It can be seen that the agitation compartment is cylindrical in shape and that its top is surrounded by a froth box, which slopes into a spitzkasten, where the froth can be skimmed. The tailing sinks to a return hole at the bottom, passing into the agitation-compartment again. To provide good agitation, four vertical baffles are attached to the wall of the agitation-compartment, against which the pulp is swirled by the two impellers. Lining the walls with expanded metal lathing or with a coarse-mesh iron screen adds to the thorough mixing that the pulp must receive. The two impellers are on a common shafting, which enters the machine through a stuffing-box in the bottom of the machine. The lower impeller with four vertical vanes is submerged; it agitates and emulsifies the pulp while the upper impeller, likewise with four vertical vanes, acts as a pump to lift the pulp and beat air into it. A pulley and belt connect the shafting with a variable-speed motor.

A dome-shaped lid is used on the machine. A small hole in the top of the dome allows the introduction of oil, acid, water, or other materials without the removal of the lid. The lid is so constructed that it can be turned upside-down with the dome extending down into the froth-box, and in this position it can act as a funnel. The dome rests then on the top of the agitation-compartment and no froth can escape into the froth-box. This allows a period of agitation of the pulp before the dome-top is turned right-side up to allow aerated pulp to overflow into the froth-box and down into the spitzkasten, where the froth can be removed.

A discharge-plug at the bottom of the machine allows the flushing out of tailing after the test has been completed. So careful has been the design of this test-machine that even this discharge-plug is beveled to fit flush with the bottom of the machine and thus afford no dead space in which the solids might settle.

The spitzkasten is long and narrow, in order to permit a deep froth to be formed and to travel over as long a space as possible, before reaching the discharge. This tends to allow more of the entrained gangue to settle out of the mineral froth. The sides of the spitzkasten are of heavy plate-glass, each fastened to a metal-frame by means of screws. The wrought-iron shaft projects through a brass stuffing-box and is supported by a ball-bearing beneath. All the other metal parts are of cast aluminum.

The small variable-speed motor may be of either D. C. or A. C. type. F. G. Janney recommends the use of a General Electric, shunt-wound, direct-current motor, for 230 volts, with a rated speed of 1700 r.p.m. and $\frac{1}{4}$ hp. The impeller-shaft is to be driven at 1900 r.p.m. maximum speed. For speed-control he recommends a Gen-

eral Electric direct-current field-rheostat, with an ampere capacity of 1.25 to 0.063 at 250 volts.

In our own laboratory it was desirable to use the ordinary city lighting circuit of 110 volts, A. C. On that account we have found the following motor satisfactory: $\frac{1}{4}$ hp. General Electric repulsion induction motor, single-phase, 60-cycle, with full speed of 1780 and carrying 4.2 amperes at 110 volts, or 2.1 amperes at 220 volts, depending upon the voltage of the current supplied to the machine, either voltage being acceptable. Speed-control is obtained by the use of an ordinary field-rheostat in series with the motor. Such a motor has a speed varying with the load and with the voltage applied. As the load is practically a constant, the speed will depend upon the amount of resistance in series with the motor. As the majority of laboratories find a city alternating current more convenient to obtain, such a motor is recommended.

The operation of the machine is as follows: It is set up on a bench convenient to the sink and to running water. The motor is set up one foot to the rear with the switch and rheostat placed so that they can be easily reached while standing in front of the machine. A $\frac{1}{4}$ -in. round-leather sewing-machine belt is used for drive. The bearings are well oiled, the stuffing-box is properly packed, and some attention should be given to it occasionally in order to see that it is kept screwed tight enough to avoid leakage.

Enough clear water is run into the machine to barely show in the spitzkasten and the motor is started at its lowest speed. A 500-gm. charge of ore ground to at least 48-mesh is added and the cover placed on the machine in its inverted position. (See Fig. 5.) This is done to allow thorough mixing without circulation of the pulp. All or part of the oil and other reagents are now added and the motor brought up to full speed for 30 seconds. The speed is again lowered to the minimum and the cover is turned over into its upright position. (See Fig. 6.) The speed is then raised and water is added through the hole in the top of the lid until the froth in the spitzkasten is nearly at the overflow lip. The ultimate speed of the agitator will depend somewhat upon the character of this froth, as some oils will give a deep persistent froth, while other froths are thin and brittle and allow of more water being added to the machine, as well as more violent agitation in order to beat more air into the pulp. The froth may either be allowed to flow out of the spitzkasten of its own weight or skimmed with a small wooden paddle. It is a good idea to wet the glass sides of the 'spitz' with water while the froth is rising, so that none of the froth will stick to the glass.

The duration of the test is about five minutes with an ore that floats easily, while other ores will require a considerably longer time to allow the entrained gangue to settle out of the froth before it is discharged from the machine. In such cases it is best to hold back the froth until its appearance shows it to be fairly clean. Beginners are likely to dilute their froth with too much

gangue. In a large-sized machine the froth can travel over from four to eight feet of spitzkasten before it is discharged, while in this test-machine it only has a travel of about 10 inches. Consequently, the small machine is liable to yield concentrate of too low a tenor. The same applies to most other machines for making tests on flotation.

The concentrate may be caught in a pan or on a filter. After the test the machine is brought back to low speed

The small amount of ore necessary for a test is a matter of considerable convenience as fine grinding of the ore in the laboratory is often irksome. The aluminum casting is little corroded by either acid or alkaline electrolytes. The return of pulp from the 'spitz' to the agitating-compartment allows the material to be treated until all mineral has been removed without stopping the machine, so that a single treatment yields a clean tailing. However, a second treatment of this 'rougher-

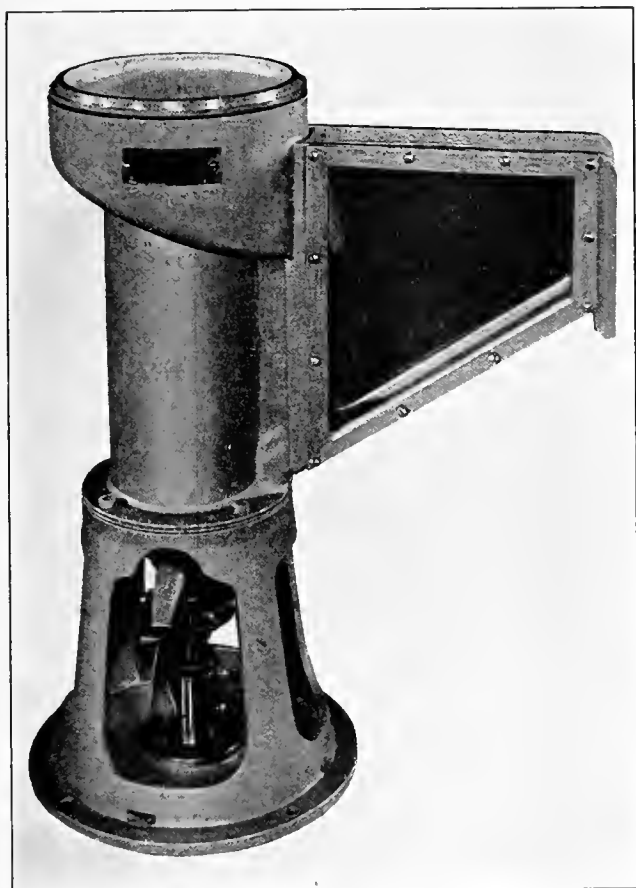

FIG. 5. THE JANNEY MACHINE. COVER INVERTED.

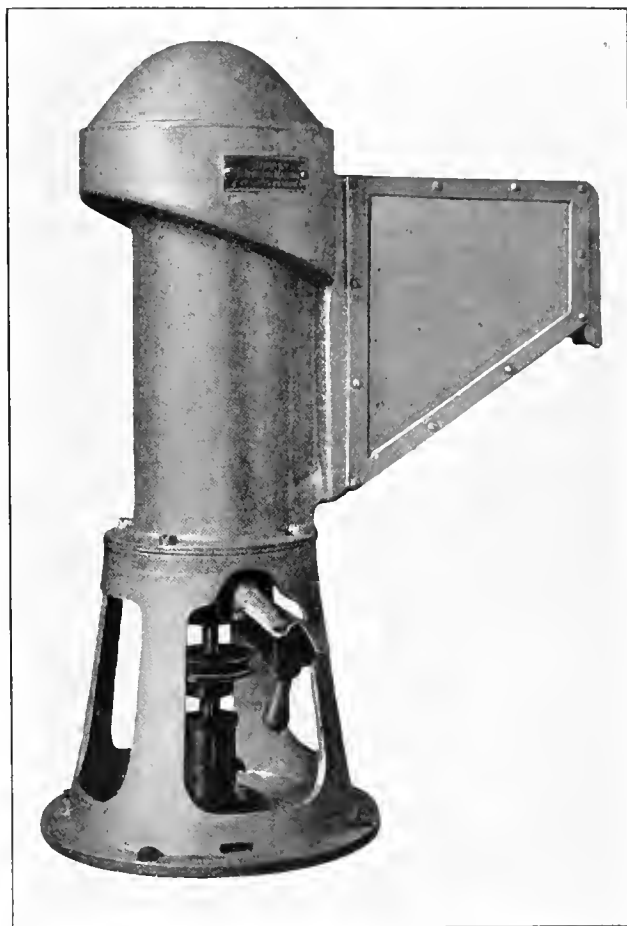

FIG. 6. THE JANNEY MACHINE. COVER UPRIGHT.

and the tailing-plug removed, so that the tailing can be caught in a pan or bucket, or run to waste.

If it is so desired, this rough concentrate can be put back into the machine and treated in the same way as the original sample, or the concentrates from several tests combined to give enough material for re-treatment. If this is done three products are made, namely:

A 'rougher' tailing, to waste.

A clean concentrate, for shipment.

A 'cleaner' tailing or middling, which in actual practice is returned to the head machine.

When these conditions are observed results only slightly lower than those possible with a big machine can be obtained. A test can be run in from 5 to 30 minutes in such a machine with 500 grams of ore in anything from a 3:1 to a 5:1 pulp. The glass sides of the spitzkasten allow close observation of the condition of the froth, and this is a great advantage to the beginner.

foth' is sometimes necessary in order to get a high-grade concentrate. Clean tailings generally mean only medium-grade concentrates due to entrainment of gangue, in the removal of all the mineral.

The stuffing-box in the bottom will probably leak if not watched. However, this driving of the impellers from below, instead of from above, leaves the top of the machine free for the operator and is more convenient in every way. This is of importance in a laboratory-machine, and will excuse the use of a stuffing-box. In large-scale machines a stuffing-box underneath would not be tolerated, and the drive should be from above. We would also suggest a sheet-lead construction as being more easily built. A $\frac{1}{4}$ -inch sheet-lead is sufficiently rigid to stand up well, while it is ductile enough to be worked readily into the desired shape. The joints are easily burned, and it is acid-proof.

THE HOOVER MACHINE, so-called, was designed after a

test machine described in the second edition of Hoover's book, being copied from one of Lyster's patents, and has been much copied by people wishing to make flotation

speed motor is belted to the pulley that drives the stirring mechanism, or a pair of cone pulleys on a constant speed motor is used. This construction has been popular because it can be made of wood, at small expense. The Janney machine will cost about \$100, while the Hoover machine can be built for a small fraction of that amount. Mr. Hoover's original drawing does not show the spitzkasten drawn to a point, as only the front

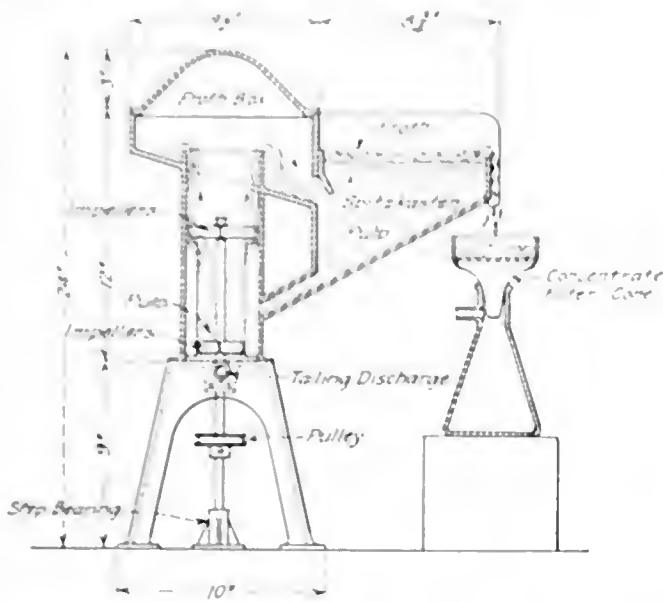

FIG. 7. THE JANNEY TEST MACHINE.

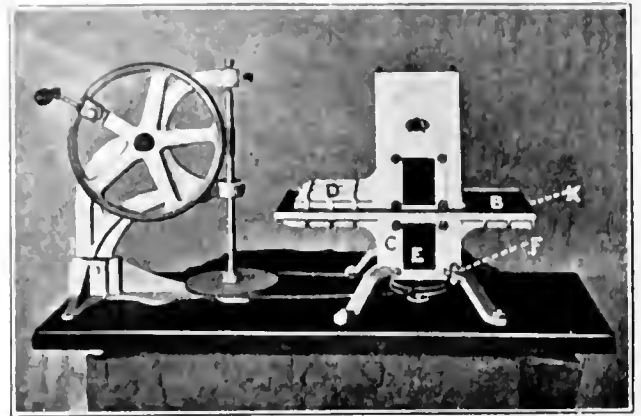

FIG. 11. THE SLIDE MACHINE.

tests. An improvement over this construction was published by Ralph Smith recently (see Fig. 10A), and a modified sketch of the same is shown in Fig. 10B, while

side was beveled. Our sketch shows both sides beveled. This is desirable, as it eliminates space in which fine sand can settle, and tends to minimize the amount of

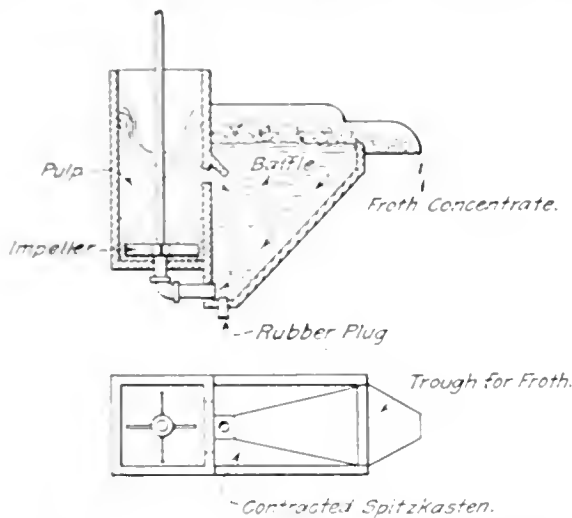

FIG. 10A. SKETCH OF THE LYSTER OR HOOVER MACHINE.

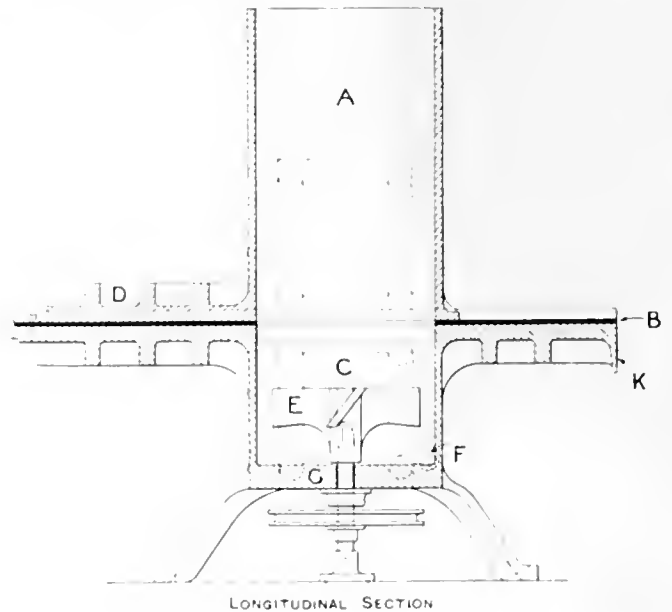

FIG. 12. THE SLIDE MACHINE.

photographs of the machine used for a while in our laboratory are shown in Fig. 8 and 9. Either a variable-

pulp lying inactive in the spitzkasten. In the agitation-compartment the pulp is swirled into the corners, where it is well mixed with air; hence the baffles sketched in the Janney machine are unnecessary. One objection, however, is that unless the agitation-compartment is very tall the pulp being swirled into the corners has a tendency to splash out, and a lid similar to the one on the Janney machine is desirable. However, it is difficult to attach one because the stirrer-shafting is in the way. The operation of this machine is practically the same as that of the Janney, except that without glass sides on

*E. & M. J., Vol. C, page 295 (1915).

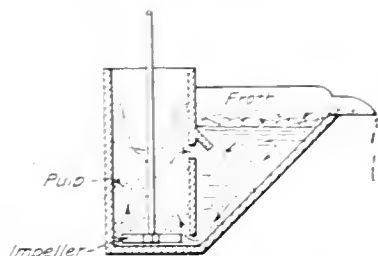

FIG. 10B. ANOTHER FORM OF HOOVER MACHINE.

the spitzkasten it is hard to get as clean a froth. A charge of 1000 to 2000 grams is necessary in this machine.

THE SLIDE MACHINE, as shown in Fig. 11 and 12, was designed by Hoover and perfected by many others. In recent practice it is motor-driven. A number of these machines were given by James M. Hyde to various universities in this country. Many people favor this apparatus for the reason that they have had little opportunity

This element of the machine has made it of some value in testing flotation oils, but in a weak froth much of the sulphide mineral also settles out and is lost, so that the test results with this machine often show unnecessarily low extractions and a high grade of concentrate. On the other hand, when conditions are adjusted to give a froth persistent enough to hold all the sulphide mineral considerable gangue is entrained in the stiff froth. Further, after skimming one froth we find it necessary

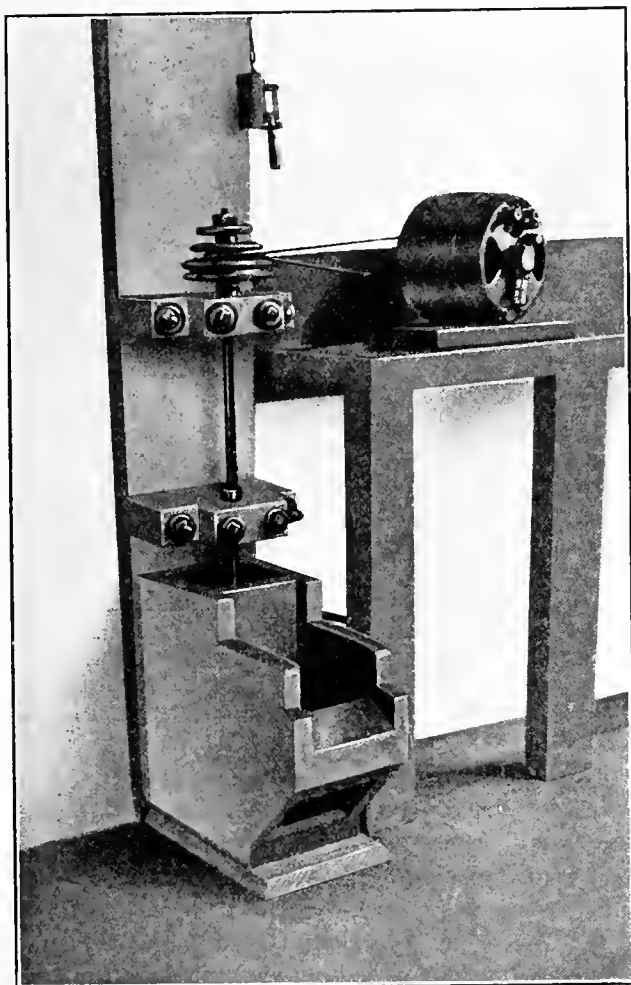

FIG. 8. THE HOOVER MACHINE.

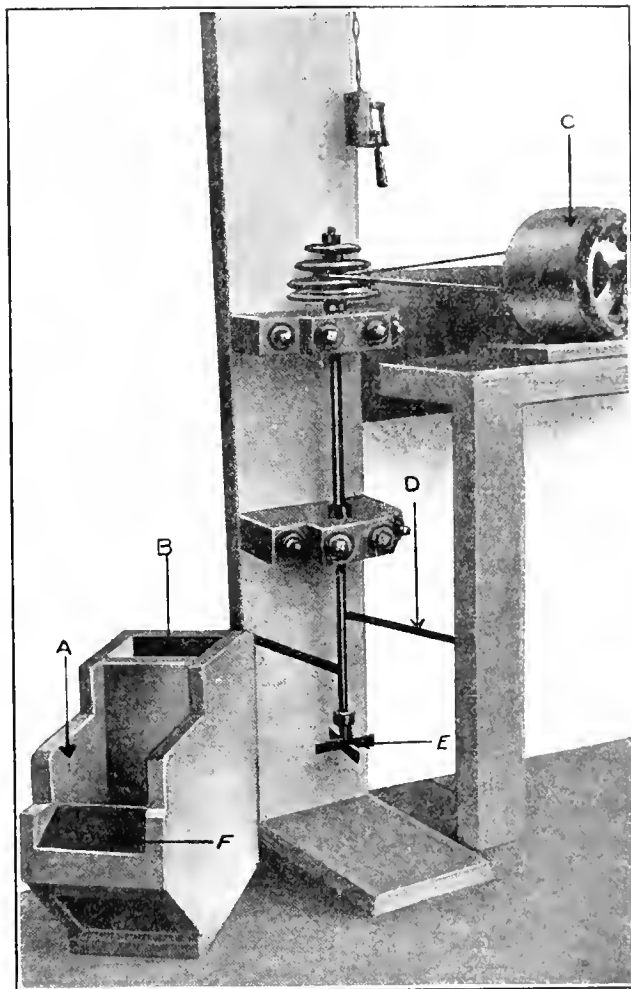

FIG. 9. SAME, SHOWING STIRRER.

to use any other design. In this machine the agitator is driven from below through a stuffing-box, as in the Janney, with the consequent freedom of the top of the machine for the convenience of the operator. The top half of the machine is so constructed that it can be slid to one side, cutting off the froth formed in the agitation from the gangue, which is allowed to settle. The operation consists in agitating with oil and other reagents, then a period of quiet during which the froth collects at the top while the gangue sinks. Two windows in the side enable the observer to see when the gangue has subsided sufficiently to allow the top half to be slid along the rubber gasket, cutting off the froth from the remainder of the pulp. The time necessary for the settling of the gangue is sufficient for much of the gangue to separate from the froth, leaving only clean sulphides in the froth.

to add more water and start the machine again to make more froth. It is hard to make the slide machine give a high extraction with only one agitation. The intermittent character of such work and the time necessary to wait while settling are disadvantages that make the Janney or the Hoover machines of greater utility, in our opinion. The parts are of cast aluminum with a rubber gasket between. A charge of 500 to 1000 grams of ore is used.

(To be Continued)

[The General Engineering Co. at Salt Lake City and the Mine & Smelter Supply Co., at Denver, sell flotation machines. So does the Denver Fire Clay Co., which makes a modified Hoover machine. The Joshua Hendy Iron Works, San Francisco, makes machines for the Minerals Separation company.—EDITOR.]

tendency to recognize the superiority of a high pressure of air for efficient drilling, just as dynamite of higher grade than formerly is becoming popular in mining. Frequent tests are made in the North Star mine underground by an air gauge to determine if the air pressure is up to standard in all stopes and drifts. It has been found that reports by the miners of unusually hard ground encountered, or poor work done by a certain drill, may be due to insufficient air pressure caused by careless piping. It is important that every miner and every drill—both of them expensive items on a cost sheet—shall have air pressure that will enable them to work to the best possible advantage. At this mine the air is taken down the vertical shaft by a 6 in. main from which reductions are made to the stopes until inch pipes each supply two drills.

I found at the North Star mine that Leyner and Waugh drills were the best liked. The old J. George Leyner No. 8 drill (which is not now manufactured) has given good service because it strikes a blow of just the right strength for this particular mine, 45 foot-pounds, and is a fast and satisfactory driller, in spite of its high cost for repairs. In competition with the Leyners there were being tried several of the new Dreadnaught drills of the Denver Rock Drill Co., which were apparently attracting favorable attention. I was told that the first Dreadnaught tested did not seem to strike a blow of sufficient force, but that this was now thought to have been due to the using of a too heavy lubricating oil on the new parts; with a lighter oil the drill had constantly improved its blow. As is more or less well known, the strength of blow depends a good deal on the air-cushioning in the cylinder—that becomes necessary in order to attain a high number of blows per minute. Other things being equal, the machine striking a high number of blows, say 2000 per minute, will be expected to hit a lighter blow than a machine that strikes 1200 blows and cushions less. The Dreadnaught is a mounted hammer-water drill that differs from the Leyner-Ingersoll No. 18 in being a little lighter in weight and in being valveless. The valveless feature makes for simplicity and lessens repairs; the main objection to the valveless drill has been the difficulty of replacing worn parts, but with the increasing use of improved steel for such parts this objection may be much lessened. It is not unlikely that for drilling in flat stopes, such as in the North Star, where the dip is 23°, some such mounted machine as the Leyner or Dreadnaught will ultimately replace stoper drills. The latter are dusty as well as being not particularly suited to flat holes; thus the Calumet & Hecla, with a dip of 38°, has favored mounted Leyners for raising and stoping rather than the typical 'stoppers.' At the North Star a number of Waugh stopers, both the new valveless types and the old 12-A type are in use. There are also a number of baby or 'chippy' Leyners, the light-weight Leyner-Ingersoll No. 26. Although this little machine does not strike so heavy a blow as might be wished, it is popular because of its handiness.

Incidentally I may mention that at the adjacent Empire mine, I found the Leyner-Ingersoll No. 18 and the

Ingersoll Rand 10' 21 stoper to be the standard drills. The Empire is generally spoken of as being somewhat more conservative in the trying of new machinery than is the case at the North Star. Throughout the district I did not notice any new-style drill-bits such as the Carr or H lots, but the old four-point cross-bit appears to remain in favor. There is no particular tendency to drill longer holes in stoping, as is so marked a policy in the wide stopes of the Lake Superior copper mines, for the

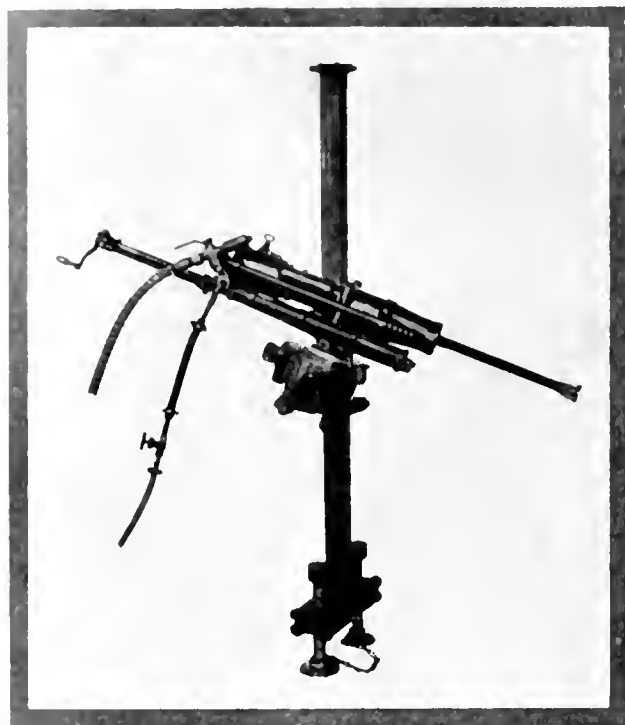

THE DREADNAUGHT DRILL. NOTE THE ABSENCE OF A VALVE CHEST.

reason that the stoping-width is so narrow (3 to 5 ft.) that the holes are drilled only 4½ ft. deep.

While I was at the North Star, Mr. Bedford showed me how they intended to draw one end of the water-tubes, after heating them, in order to reduce the diameter of the inch or two of length that protrudes into the hollow drill-steel. As is well known, there is some trouble from the water-tube of a water-drill becoming caught in the drill-steel and getting its end twisted off, causing much inconvenience in buying and replacing tubes. Considerable difficulty has been experienced at the North Star in reaming out the hole in hollow steel by hand after the sharpening has closed it; a modification of a machine in use at the Copper Queen mines at Bisbee is to be adopted, but using water pressure instead of air and oil cylinders, to ream the holes.

To a miner used to wide stopes the 2 or 3-ft. stopes of the Grass Valley district would appear extraordinarily diminutive and the little columns for mounting the drills would look ludicrous in stature; but the extraction of such a narrow vein of such hard ore from rock that holds it 'back' so that (as the Cornishmen say) "it's like pulling it out by the roots of the hair," is a problem of no mean proportions.



ON THE COLORADO RIVER.



ON THE ROAD TO THE MINES.

Oatman, Arizona—A Prohibition Camp

By Frank H. Probert

“**H**IT the golden trail to Oatman.” “The golden hub of Mohave county’s wheel of fortune.” Let us hope that this joyous dithyrambic will not give place to a dirge of disappointment: let us hope that when the slag of excitement is cleared from this melting pot of men, money, and mines that a golden yield will result. Here’s success to the prohibition camp of Oatman, the first of its kind in the Golden West!

The regular route is by way of Needles, California, on the Santa Fe railroad, where every train discharges many people bent on visiting Oatman, but the muddy Colorado river has to be forded on scows propelled by Indians and a fussy little motor-boat. On the Arizona side a score or more of automobiles are waiting to carry the crowd over one or other of the desert roads that lead to Oatman, 21 miles to the northeast. It is proposed to build a bridge across the river at Needles for the accom-

modation of traffic and there are recurrent rumors of a railroad from Topoe following the route of the dismantled narrow-gauge road built to the Vivian mine and so to the new camp. Most of the freight and many passengers reach Oatman through Kingman, 27 miles north, but the mountain grades are steeper and the road very dusty.

Leaving Needles and the broad expanse of river-bottom, the topography changes abruptly into a rough rock-ribbed section, characterized by the ruggedness of detail rather than by the broader features of mountain uplift. It is a district of igneous rocks and successive lava flows, the result of intermittent vulcanism. Gray erags of andesite, resistant ribs of paler rhyolite, a network of silicified vein outcrops, and on the higher elevations castellated buttes of tuff, the remnants of the mantle that covered and closed the Tertiary period, are con-

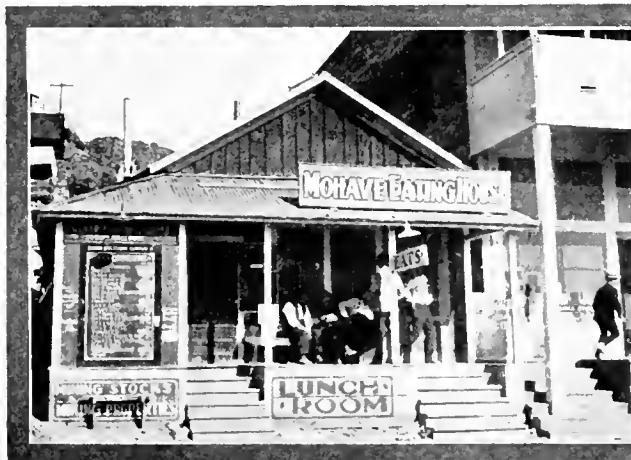

A STOCK-EXCHANGE.



A STREET SCENE.

splendid features of the landscape. There is no running water, no vegetation other than the sage and cactus, the rocks are burnished by the attrition of hot sand, the softer part of the rock mass has weathered, crumbled, and been removed, leaving the bare skeleton of the vein system to bleach in the blazing sun.

Passing Boundary Cone at the western end of the Black range, which guards the gate to this new treasury-vault, there are signs of activity, interest, expectancy, work, hope, and effort. Several townsites have been surveyed, and Old Trails, Ryan Addition, City of Carter, Mazona, Oatman, and others in the making, attract the visitor with promises of water, electric light, telephone, telegraph, good roads, reasonable rents, terms to suit tenants, and so forth.

The automobile stops at the Oasis café, the biggest little gold mine in the district, where the pay-streak is always rich and the bullion ready minted. A busy scene is presented, for this is the heart of Oatman, the end of the trail, a meeting-place for everybody. I counted 58 cars within a stone's throw of the Oasis at the noon-hour. The prospector's faithful friend, the burro, is no more; his place has been taken by the equally reliable and faster Ford car.

The Oasis café is the best place to feed, although the Mojave Eats, and the Mulligan, or 'Mad House,' as it has been dubbed, are well patronized, judging by the bread-line outside at 5 o'clock every evening.

Oatman is a typical boom camp of mushroom growth; houses hastily thrown together, lean-tos of all descriptions, stores, banks, booths—but no saloons. Arizona went dry on January 1, 1915. This subject of prohibition must not be dismissed without comment. Its effect on the standard of work, the *moral** of the community, and the deterrent influence it has against vicious practices is most noticeable. The saloons of former days, the bars, foot-rails, display of glassware, white-vested bartenders—all these outward signs remain; and the tendencies, appetites, and habits of mining men of all classes ring true to bygone days, but thirsts are quenched and success toasted with grape-juice high-balls, or malted milk. The result is obvious: the town is orderly, conversation is clean, competition keen, money is saved, a harmless game of pool or billiards serves as recreation after a full day in the field, and the street is deserted before 10 o'clock at night. I am informed that fully 30% of the monthly pay-roll is invested in local mining-stocks, or put into the ground prospecting. There is a contagious, clean, healthy atmosphere.

Accommodations for the visiting hordes are not of the best, but are improving. Prospect tunnels and the dry arroyos near town are eagerly sought by the wise ones who have brought their blankets. The Oatman Hotel sleeps two and three men in a room, and lucky is he who can find private quarters.

What a motley mixture of humanity, what types are foregathered here! Bankers, brokers, engineers, agents,

those of brawn and those of brain, promoters intent on selling something they haven't got to someone who doesn't want it, newspaper men, State senators, pseudo-politicians, horny-handed miners, yellow-legged experts, all sorts and conditions of men, all there for one purpose, all buoyed by the same hope. Subconsciously one appreciates the motto of the golden eagle: 'In God we Trust.' Everybody of note is addressed by his first name, as uncle John, Frank, Ralph, Lew, Tom, Dick, or Harry, and it is a sign of professional standing if your name is misspelled in the local papers. The number of qualifying adjectives, such as safe, conservative, or prominent, before a name indicates the degree of esteem in which the visitor is held by the enterprising reporter. But good nature prevails and Diamondfield Jack has as many friends as other noted characters.

Business is brisk in Oatman. Transactions involving thousands of dollars and hundreds of thousands of shares are discussed and arranged so airily and so easily and with such dispatch that it is bewildering. The new arrival is button-holed, taken up over the outcrop of the Olla Oatman where the wonders of the world are pointed out to him; here is the vein, there is the United Eastern, the ore lies so deep, this group of claims has a better and bigger showing, all you have to do is to go down, first in your pockets, then in the ground. Groups of claims change hands every day, on paper. Short-lived options, usually five days, are the thing, for and in consideration of x dollars and 1000 x shares of stock. Possibly the claims have not been recorded, maybe the location work has not been done; what matters? Was not the United Western company organized on the Oofy Goofty, Oofy Goofty No. 1, and Oofy Goofty No. 2, three claims a mile or more away from the main group on which the present work is being done.

Already there are over 50 companies organized to explore the district, within a radius of four miles of Oatman. Nearly all have a capitalization of a million shares variously quoted on the Oatman Investment Co.'s board from 10 cents up. A few are inactive, most of them range between 20 and 50 cents, while the United Eastern heads the list at quotations of \$4.50, one hundred times its selling price of a year ago, and fully justified by the value of ore developed. There are many 'wild-cats,' but who has the courage to differentiate between this prospect and that? Could any excuse for an outcrop be less attractive than that of the United Eastern, or any surface showing more inviting than the Olla Oatman, below which little or no ore has been found?

No subject is of greater interest or more engrossing than the psychology of mining, the analysis of the mental attitude of the speculator; and surely there is no better field in which to study it than Oatman. The veins outcrop, either as prominent silicified ribs in the softer andesites or as shallow depressions in the quartz-porphry or rhyolite, all showing more or less brecciated rock fragments cemented by calcite or quartz. There are many of them, trending generally to the north-west. The ore occurs as a series of lenses pinching vertically

*[This is not a typographical error. The word in this sense is commonly spelled *morale*, which is wrong.—EDITOR.]

and horizontally within the vein-filling; owing to the re-opening of fractures, oxidation and leaching are advanced. Gold is seldom found near the surface in paying quantity. The rich ore-shoot of the United Eastern apexed 300 ft. below the surface: the first ore mined in the Tom Reed was even deeper, hence it is axiomatic among owners of claims and promoters of companies that a shaft must be sunk 300 to 500 ft. before cross-cutting to the vein or driving along it. The stock market responds to these conditions; interest increases as the prescribed depth is attained, and the volume of business is directly proportional to distance from surface. Failure to find ore is not discouraging as long as the vein is there. After the first shock of disappointment, speculation is renewed as the drift advances; even 60% Hercules powder cannot shatter the assurance of the manipulators of stock. If the pay-shoot is not on this level, then of a certainty it must be below. There is always the dominating influence of hope, the insatiable desire to gamble.

Already five or six companies have taken their place on the anxious seat

of expectancy and suspense; the United Western is cross-cutting to a vein at the 507-ft. level; the Big Jim at the 400; the Oatman Gold, Black Range, and Telluride are pushing lateral work. Success in any one of these will fan the flame of excitement into the wildest enthusiasm and the whole list will respond. Even the most sanguine of optimists does not expect that all the properties will strike a bonanza, but unquestionably other rich shoots will be exposed by the systematic development in progress throughout the district. That pay-ore extends to considerable depths is evidenced by the Tom Reed and Gold Road mines, where ore of good milling grade is being stoped on the 1075 and 1100-ft. levels, respectively. The Pioneer, Orion, and Vivian properties were opened below the 400-ft. level before the present boom started. Further work is contemplated.

The district is not new; it has been prospected for 40 years, and the Gold Road and Tom Reed properties long ago entered the ranks of dividend-payers. The question naturally arises, why has it languished so long? Why, in

a region of prominent outcrops, has there been so little actual mining development? Is this awakening due to a better understanding of geological problems, to improvements in mining and metallurgical practice, to the chance discovery of another bonanza, or is there a plethora of American money seeking avenues of investment? Widely different views are held on this subject, but the cold fact remains that Oatman is to be thoroughly and systematically explored until its hidden riches are uncovered. History will repeat itself, and when the books are finally balanced it may be found that for every dollar taken out of the ground, three or four have been expended.

The foregoing paragraphs are of human interest. Such reflections are indelibly impressed on the mind

and memory of the nomadic engineer. But there are matters of technical interest, ideas of the genesis, occurrence, mining, and treatment of the ores to be discussed, and still many intricate problems to be solved.

Nearly all of the precious-metal deposits of the Western States have been found in broad metallographic prov-

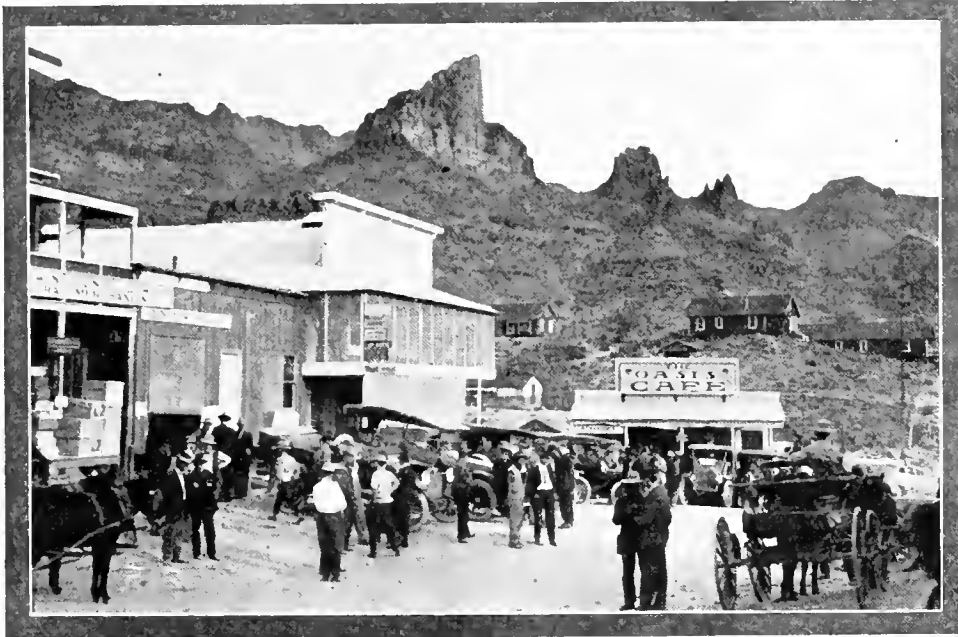

THE NOON HOUR AT OATMAN.

vince of Tertiary lavas, extending from northern Nevada to southern Mexico. Attempts to show that commercial mineralization is confined to one or other of the differentiated flows have led to much controversy and delayed search in proscribed areas. Theories however beautiful are often killed by facts, however ugly. The highly commendable work of J. E. Spurr at Tonopah in 1904 was challenged by J. A. Burgess in the light of later development, although a revision of data led to no serious change of opinion. The discussion of the dacites at Waihi, in New Zealand (Tertiary lavas), is another case in point.† At Tonopah the earlier andesite has been the most productive. At Goldfield the dacite carries the ore, although rich shoots at the Kendall and Sandstorm mines occur in the old effusive rhyolite, while gold prospects were found north of Diamondfield in the younger andesites. The deposits of Bullfrog are in rhyolite with quartz and calcite vein-filling: the Manhattan ore is

†M. & S. P., November 13, 1915, page 729.

associated with intrusive rhyolite, and at Searchlight the orebodies of the Quartette mine are related to the andesite porphyry. At Randsburg, California, older rhyolites carry the ore. In Mexico other examples of the distribution of gold and silver in one or other of the earlier Tertiary flows could be given. From the available data, it is evident that in different localities one member of the series of lavas has played the major part in the formation of primary ore. This may have been enriched, either by addition of mineral from later intrusives, or by concentration due to processes of oxidation and leaching made active by structural features induced by the orogenic disturbances of later times.

No careful geologic work has been done at Oatman. A correct diagnosis of the rock sequence and mineralizing agencies would be of incalculable value. In Bulletin 397 of the U. S. Geological Survey, F. C. Schrader gives the results of his reconnaissance in somewhat ambiguous phraseology, which fortunately was elucidated by Howland Baneroff in the *MINING AND SCIENTIFIC PRESS* of July 3, 1915. W. H. Weed is non-committal in the statement that the dikes (meaning intrusives) have been fissured and mineralized by vein-forming agencies. E. W. Brooks is more positive and limits the area of commercial mineralization to the newer andesite, thus confirming Mr. Schrader, but he refers to it as a flow, being "poured out upon the older andesite." My own hurried observations suggest the importance of studying:

1. The true nature of the younger andesite.
2. The influence of later volcanic disturbances on vein-structure.
3. The relationship between value of ore and replacement of calc spar by secondary quartz.
4. The influence of oxidation on the vertical distribution of ore.
5. The inference that can be drawn as to the nature of deep-seated ore from the character of that now developed.

Seriatim, I am of the opinion that the newer andesite was both intrusive and extrusive, that dikes and sills of this chloritic andesite occur in the older flow, and that the possibilities of mineralization of vein-fissures is dependent upon this association. Veins in both the older and newer andesites may therefore be productive to a considerable depth.

Rhyolite dikes and quartz-porphry intrusions have played an important part in shattering the rock-mass, re-opening spar-filled fissures, causing a brecciation not only of the gangue but of the enclosing wall-rocks, and admitting of active oxidation to great depth, with probable concentration of precious metals at well-defined horizons. Strike-faulting is very noticeable within the vein and probably determined the lenticular form of the ore-shoots. Groovings and striations would indicate both horizontal and vertical movements that may explain the tendency of shoots to pitch, or rake, to the north. The acid intrusives may, too, be the source of the silicious waters that have re-cemented the brecciated material in the veins.

There is a pronounced relationship between high-grade ore and secondary silica; or, conversely, unaltered calc spar, the original vein filling, is generally low-grade, if not barren. This condition can be studied well in the United Eastern mine, where frequent cross-cuts show the erratic distribution of the rich ore. The gold is very finely divided and rarely noticeable to the naked eye. It is always associated with a dull waxy-green variety of quartz of resinous lustre, resembling bees-wax. Under a hand lens the quartz is seen to replace the calcite. Banded structure is not common and veinlets of secondary silica appear penetrating the crystal mass of the spar. As accessory minerals, fluor spar is plentiful in certain localities, as on the Times group, while limonite and manganese oxides are well distributed throughout the district.

The subject of oxidation is important. None of the mines is wet and ground-water level has not been established in any workings on the vein system. The re-opening of fissures and strike-faulting indicated by the included angular fragments of wall-rock, by crushed vein-filling, and by persistent striated polished walls within the vein itself, rendered conditions favorable for the percolation of oxygenated waters to great depth, with the attendant possibilities of enrichment. Manganese is a common constituent of the vein-filling, and, as is now generally recognized, plays a prominent part in the precipitation of gold from migrating solutions. At Oatman I found many examples of free gold in intimate association with blebs of limonite and manganese oxide. This, in my opinion, is not residual gold, it was not left to enrich the specimen by the removal of other more readily soluble minerals, but was precipitated when the descending waters ceased to be acid in character and when ferric and manganic salts predominated. The porosity of the veins at Oatman, the presence of manganese, the advanced oxidation are all contributory causes to the localization of the ore-shoots some distance below the surface.

As a corollary to the above, it is to be inferred that sulphides will be found below the zone of oxidation. Pannings of discarded assay-pulps first caused me to look for sulphides in the more compact portions of the vein underground. Sulphides are not uncommon and will be found in increasing quantity on the lower levels. At the horizon where oxidizing conditions ceased, gold, limonite, and manganese oxides were deposited, and still deeper the primary sulphides may be anticipated.

The chief impression I have, as a result of my visit to this promising district, is that careful, competent, searching study of the geology of the district will prevent the useless expenditure of money in many directions, and lead to intelligent development in others.

The excitement caused by developments at Oatman is spreading to the old Cerbat and Chloride mining districts. The Goleonda zinc mine, the property of the Union Basin Mining Co., after proving the continuity of the ore to the 900-ft. level, is building a 200-ton flotation plant, which should be running early in 1916.

The prospects of Mohave county are promising.

REVIEW OF MINING

As seen at the world's great mining centres by our own correspondents.

DENVER, COLORADO

TUNGSTEN IN THE SAN JUAN.—THE DOWN TOWN AREA OF LEADVILLE.—A 'DRY' STATE, AND PROBABLE EFFECTS.—NEW ROADS.

A recent letter mentioned the deposits of tungsten on or near Cement creek in the San Juan mountains, which have been known for a long time. The increasing price of tungsten has finally resulted in the active development of several veins known to contain tungsten. The Yukon mill, which is on Cement creek a mile or so below the Gold King plant, has been acquired by the tungsten operators, and is now producing concentrates.

With a few of the usual mishaps which attend any large enterprise, the unwatering of the Down Town mines at Leadville progresses steadily. The water is now down to about the 700-ft. level of the Penrose shaft. While some zinc ore has already been shipped from the drained area, results have been small so far. It always takes time to get large operations under way. The draining has made available a large and favorable area for prospecting, but uncovered only a few known orebodies. The known deposits are mostly in the 200 ft. yet to be unwatered. One of the interesting questions that may be solved by this enterprise is whether or not the famous Leadville ore-shoots extend for a considerable distance down toward the Arkansas. Judge Owers, well known in Leadville, assisted in putting down some diamond-drill holes many years ago, the results convincing him that as much or more ore lay on the dip below the Penrose shaft as above it. He acquired a large territory covering the supposed extension of these ore-shoots, and spent a large part of the latter days of his life endeavoring to finance the project of sinking a new shaft to cut the ore horizon on the dip, some distance below the Penrose. Unfortunately the drilling records were not sufficiently conclusive to warrant such a large undertaking, and the project was never consummated. The pumping equipment now installed is far more efficient than the old plant, so it is reasonable to expect that an additional hundred feet or so will not deter the operators from following the ore down on the dip as long as prospects are good.

The Supreme Court of Colorado has decided that not even the home-rule cities of Colorado may dispense liquor after January 1, 1916. So the State will be dry as ashes. There is considerable difference of opinion as to the advisability of this drastic prohibition law as regards the prosperity of the State as a whole. It is thought by many that it simply amounts to transferring the profits of the liquor trade from the hands of Colorado citizens to those of other States. It is pointed out that the consumption of liquor in prohibition territory, both in this State and in others, is nearly as great as in wet territory. The only difference being in the method of distribution. That the present good system of distribution, which includes such magnificent units as the Silver Dollar saloon, the Brown Palace bar, the six Colorado breweries, and other notable works of man, will be ruthlessly destroyed in favor of the mail-order house with headquarters outside the State. On the other hand, the roseate claims of the 'drys' are well known. Phoenix will miraculously arise from the ashes of legal destruction, and a large chunk of the millenium will burst forth upon Colorado like the life giving sunshine of spring after the clouds of winter. However diverse the opinions may be as to the effects of this law on the State as a whole, there is little

difference of opinion as to its effect on the mining centres. The open saloon is an institution that most mining men cherish, but experience has shown that it is not good for us. While the mining towns 'religiously' voted wet, still every miner one meets is of the opinion that dry places will be a good thing. The mail-order route may not be as sociable as the bright lights, the brass rail, and the familiar "This one's on me, boys," but it is a whole lot better for the health. Less pneumonia, more sleep, less hurrah, more work—prosaic, uninteresting, but as long as it was forced on us we know it is going to be beneficial.

The extremely open winter weather has been a good thing

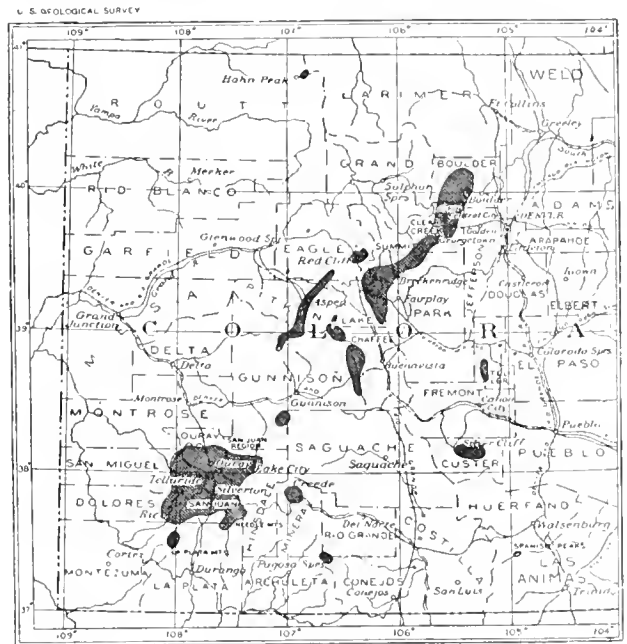

MAP OF COLORADO.

for the mining industry. Money has been tight, as every one knows, and many enterprises were without funds until late in the fall. If the winter snows had come early, an unusually large amount of surface work would have been suspended until spring. Take the single item of roads for instance: I feel sure that there were more miles of wagon-road built in Colorado's mountains during November and the first half of December this year, than in any similar period of its history. The new highway from Durango to Alamosa was finished late in November; the Bear Creek Canyon road was finished on December 13, and the Jarr Canyon road to Cripple Creek was completed about December 1.

The outlook at present is that next year will be one in which the high water run-off will be of short duration. It is the early snows that drift into the big banks and last until August. The spring snows, even though abundant, do not get packed down, and they go off with a rush in June. This condition is bad for the farmer, but favorable for the miner. It means open roads and trails and little water to pump. Some power-plants are feeling the lack of water, but then there is plenty of coal to burn and plenty of auxiliary steam plants available for the larger distributing agents.

FAIRBANKS, ALASKA

ROADS TO TOLOVANA, AND PROSPECTS OF THE NEW DISTRICT

FAIRBANKS LAST SEASON, AND PROSPECTS FOR NEXT—
SCRAPERS—LOVE MINES—FUNGSTEN.

Now that a good trail has been constructed to the Tolovana and Olmes, much travel and freighting has been done between Fairbanks and Livengood. Many criticisms of the trail have been made, as while the route is about the shortest possible, there are several high divides that make heavy hauls difficult. Many people advocate the Happy Creek route. Though at least 15 miles longer, it has no appreciable grades. J. H. Ross, territorial road overseer, is now engaged in cutting out a winter trail by way of that route with the aid of a Holt caterpillar-tractor, intending to do heavy hauling that way later. Good progress has been made so far, the men being at Lake Minto, and one lot of men has left Livengood to meet the others, to assist in the work. If a post-office is finally assigned to the new district, it will be designated Livengood by the Post-Office department, the original name of Brooks not being considered suitable. There is a Brooks in Alabama, and an improper abbreviation for Alaska would result in much confusion. However, commissioner and recorder Atwell was appointed as that officer for Brooks, and the radio-station is also known as Brooks. How the mix-up will be straightened out is yet to be seen. If the pay-streaks are as good as hoped for, however, the matter of names will be incidental.

No extensive prospecting was done last month, all the prospectors being busy arranging for the winter. From now on the 'dirt' will fly, and the camp be developed considerably during the next few months. That there is pay, and good pay on Livengood, has already been proved; but whether it is only in spots, or continuous, is yet to be determined. Pay has also been reported on the Mike Hess side, but no sluicing has been done there to prove this. The general feeling is one of quiet optimism, and it will take a lot of blank holes to discourage anybody.—Plans are already under way to remove the immense log-jam that blocks navigation to the mouth of Livengood creek, so that freight will be much cheaper by water next year than this, when portaging was necessary for the 500 tons of material that was shipped in that way.

The fact that gold production from Fairbanks placer mining in the past season was much greater than last has been a source of great satisfaction to everybody. Merchants report much better business for the fall than a year ago, and the extensive operations planned for next season should keep production up to the mark. Open-cuts on Cleary and Pedro creeks will be as extensive, while the usual amount of drift mining will be carried on on Fairbanks, Chatanika, and Ester creeks. The ground adjoining that on Ester, which gave a fortune to Short and Ray last season, will be worked this winter and next summer by Jack Leach, who has just as good pay in sight. The Al Hilty open-cut on Cleary will also yield well again, unless the option on the greater part of the creek is taken up, in which case production will be delayed till a dredge is erected. This option is held by delegate Wickersham and associates. If taken up, either the Murphy ditch will be completed from the head of Chatanika, and the creek hydraulicked or a dredge constructed. The Hilty ground yielded a large return this year, not only paying off considerable debt, but putting Hilty and Durand on their feet, if reports are authentic. The ground was worked with a large Bagley scraper and American scraping engine.

Hanot Bros. are to erect a much larger patented scraping rig on their Pedro ground. In this machine the scraper is attached rigidly to a carrier that travels on a trolley cable to boxes. As soon as the load is picked up, the slack is pulled out of the trolley cable, and the load is taken to the boxes, with more speed and much less power than is possible with either the slip scraper or Bagley scraper. Aside from the patented features, the rig is similar to the levee machine used

on the Mississippi that was illustrated in the June, 1916, issue of *The World's Work*.

That the quartz properties on Fairbanks creek are gradually emerging from the prospecting to the production stage is shown by the three small steam plants now working there. McGillivray, Nars, and Handberry have recently installed a small hoist, and expect to make regular shipments to the custom mill farther down the hill. This property has long been idle, but the advent of a good custom-plant has made operations much less of a gamble. Considerable ore of milling grade has been blocked out. Ott, McGowan, and Lyden have also erected a small steam plant on their lease, and are taking out ore for shipment to the Heilig mill. Their lease is on a portion of the Gus Hess ground, and adjoins the Mispah claim where Hess, Gels, and Thompson are now operating. While they have been working only a few months, the lessees are well satisfied with results. Hess and partners are also using a steam-hoist, and have been in good ore for some time. They should have a large shipment ready in a few weeks.

Gilmore and Stevens have bought out the last of the lessees on their ground, and are now operating on their own account. Their new five-stamp Allis-Chalmers mill has been started again, and should be kept working steadily from now on with proper management. The lessees extracted only a small part of the 6-ft. lode and could not keep the mill going full time, but the owners think the whole vein can be milled at a profit. Operations so far consist of windlassing from two shafts, but a power hoist will soon be necessary. At the Huddleston-Leyendecker property, in which Gilmore also holds an interest, the vein has been found down the hill from the shaft, and an adit is being driven. The shaft was lost last summer, due to heavy rains, and stopping too near to it and the surface. The adit shows 4 ft. of milling ore.

McCarty and Kellen are now cleaning out the old stopes of the Pioneer claim to get the \$15 to \$20 ore shot down as waste when this grade could not be treated at a profit.

Foss and Farvean have been getting some good ore lately from their lease at the McDonough property. The last 60 tons milled averaged over \$30 per ton, and it is expected that the next shipment will net even better. The lessees use an Ingersoll-Rand stoper with steam, and while it is not always very comfortable to work with, it is better than hand-drilling. Lots of trouble was experienced at this property from water and swelling ground this fall, and practically the whole mine had to be re-timbered, the largest timbers obtainable being used. Everything is in good shape now, and the partners will probably be well repaid for their extra trouble and expense.

Crites and Feldman have had the misfortune lately to get drowned out of their shaft on the top of the hill. The shaft was being sunk for prospecting purposes before the main adit was driven that distance and the flow of water was considered too large to handle economically. A cross-cut adit will now be driven to cut the vein at a depth of 150 ft., and in case the grade continues, the main adit will be driven in from the mill-site.

The mortgage on the Newsboy mine has been foreclosed and the property will pass into private hands. Several calls were made for a stockholders' meeting to consider a plan whereby a foreclosure could be avoided, but as there was no quorum present, this had to be resorted to. At any rate, this property will probably pass into the active list sooner than under private ownership.

Encouraging reports come from the newly discovered scheelite deposit at the head of Gilmore creek, the shoot widening considerably and containing a high percentage of tungsten. Albert Johnson, the owner, is a prospector of wide experience, and says that the deposit has more promise of size and continuity than any he has seen. Placer scheelite has been seen ever since the creek was worked; this vein is probably one of the main sources of the mineral.

THE MINING SUMMARY

The news of the week as told by our special correspondents and compiled from the local press.

ALASKA

CHISANA

Gold output of the Chisana district last season was between \$100,000 and \$150,000. About 50 men will winter there. More work is to be done during the winter than before. Several prospects are reported to be very promising.

JUNEAU

Twenty claims, two mill-sites and water-rights at Windham bay have been sold by G. Jensen and E. J. Dailey to the Alaska Bond & Development Co., H. H. Smith president, for \$232,000. Work will commence in the spring.

During the first 13 days of December the Alaska Gastineau mill treated 51,659 tons of ore averaging \$1.10 per ton; the tailing assayed 23 cents. By the end of 1915 it was hoped to have the heads up to \$1.35 per ton. On No. 6 level of the mine 808 ft. has been driven east, with good ore in the face. The last 300 ft. averaged \$5.36 per ton. The schist had not been entered on December 20. On No. 7 level the east drift was advanced 667 ft., the last 110 ft. assaying \$4 per ton. All stopes are looking better. The Annex Creek power-plant is working.

On December 17 a snow-slide demolished the blacksmith-shop change-house, and dry-house at the Gold Belt mine. The damage is estimated at \$2000. The crew in the adit are temporarily engaged at diamond-drilling.

Eugene Meyer, Jr., & Co. have issued a summary of a report of J. H. MacKenzie, consulting engineer of the Alaska Juneau Gold Mining Co., showing the progress being made in development and equipment of the plant. It says in part: "Practically all contracts have been let for mill and power-plant construction. Grading for power-plant is completed. Mill grading is more than 50% complete. Erection will commence early in the spring, and it is anticipated that the plant will be ready for operation on schedule time. The mill design is believed to embody every desirable known economic feature based upon the most recent experience in mill construction. The ore will move entirely by gravity through the various phases of treatment. Mill screens have been entirely eliminated, with consequent increase in capacity and reduction in milling costs. Ample wharfing facilities have been completed, making it possible to bring the largest ocean-going steamers within a stone's throw of the reduction-plant. There remains one additional warehouse to be erected. Compressors, blacksmith-shops, and general buildings all of ample size were completed before the beginning of the present enlarged program. The original plans for placing the property on an 8000-ton daily basis are going forward absolutely according to expectations and schedule, and there is every reason to believe that the final expenditures to complete the plant will not exceed the present cash resources of the company. It is expected that the plant will be in operation early in 1917."

ARIZONA

COCHISE COUNTY

Prospectors in the Huachuca mountains are active at present. The area has produced a good deal of gold from placers. In Ash canyon a formation has been opened containing a rich but narrow vein. Several copper deposits are producing ore. Snow has fallen in the mountains recently.

GRAHAM COUNTY

In Hooker canyon, on the opposite side of the Gila river from Geronimo, P. Morgan and Owens Bros. have found a wide deposit of gold-bearing decomposed porphyry, with some silver and copper. They reported this at Globe last week.

GREENLEE COUNTY

The Detroit Copper Co. has 140 mining claims on which assessment work has to be done. Men were sent to do this, but they were driven out by the strikers. The company on December 18 filed a complaint with Judge Sawtell of the Federal court against the Western Federation of Miners, asking for an injunction restraining this body from interfering with the work mentioned. An order was issued accordingly. Governor Hunt refused to discuss the matter.

MOHAVE COUNTY

The latest and one of the most important reports from the Oatman district is that the Tom Reed and United Eastern mines are being sampled with a view to consolidation.

Drilling has been started at the Copperfield Porphyry Copper company's ground near Mineral Park. The shaft is 40 ft. deep. Fifteen per cent ore is to be shipped. There is talk of a 100-ton mill. Power can be secured at \$12 per hp. month.

The Golconda Extension shaft has cut high-grade gold-silver stringers at 350 ft. The main orebody is considered to be near.

A new method of concentrating molybdenum ore has been devised by T. D. Walsh, who has been experimenting at the Leviathan mine.—The new mill of the American Molybdenum Co. is in commission.

A new road is being constructed into the tungsten area 12 miles east of Yucca. Forty men are employed.—A new road over Goldroad hill is to be built by the county at a cost of \$33,800. This will cut down the heavy grades on the old road.

At 250 ft. in the Carter Mining & Milling Co.'s mine, 26 miles south-west of Kingman, a cross-cut has passed through 10 ft. of \$30 ore.

At the Lazy Boy a two-drill compressor and machine-drills are at work. The shaft is down 60 ft. A 40-hp. gasoline hoist is to be installed at once.

The United Northern company is constructing a road one-half mile long, and grading for machinery. A two-compartment vertical shaft is to be sunk 500 feet.

The Oatman Amalgamated Gold Mines Co. has been organized by C. A. Jones of Los Angeles and J. T. Burns of Colorado Springs, Colo., for the exploration and development of approximately 400 acres of ground.

Extensive interest is being taken in the Cedar Valley, Union Pass, and Wallapai districts, where are a large number of prospects and properties in the development stages.

In the Aquarius mountains, 56 miles from Oatman, A. C. Parsons of San Francisco has purchased 13 claims, in which is said to be a commercial deposit of bismuth.

CALIFORNIA

The State Mining Bureau, under the direction of Fletcher Hamilton, state mineralogist, is preparing a new, general report on all of the mineral resources of California. Instead of delaying publication until the entire area of the State has been covered, the reports are being issued as advance chapters, by groups of adjacent counties, as soon as completed by the

field men. Competent geologists and mining engineers are engaged in the field gathering data, and it is expected in the next few months to complete this survey of the whole State. All mines, quarries, mineral springs, cement mills, and other plants handling mineral products are listed and described including situation, equipment, extent of development, geological conditions, etc. The reports are well illustrated with photographs and drawings, and contain also tables of the mineral yield of the several counties, showing a wide diversity of products.

The following chapters have just been received from the printer, and are now ready for distribution at the prices indicated, which includes postage. They may be obtained from the main office of the State Mining Bureau Ferry building, San Francisco, or the southern California branch office, at Room 208 Union League building, Los Angeles.

The chapter on Amador, Calaveras, and Tuolumne counties



MAP OF CALIFORNIA, SHOWING COUNTIES

covers the central portion of the Mother Lode gold belt. This district is one of the oldest, and is still the most important quartz gold-producing section of the State. With photographs, charts, and index, the report contains 180 pages and the price is 50c, postpaid. The author is W. B. Fletcher, field assistant. There are three distinct lodes in Amador county, the principal being the Central or Mother Lode belt. The quartz veins of this formation occur in black slate, black slate and diabase, and amphibolite-schist. From 1880 to 1913, inclusive, Amador County mines have yielded a total of \$64,238,755, of which \$62,511,953 was from gold. Fifty pages are devoted to interesting descriptions of the deposits and general development of asbestos, clay, coal, copper, gold (38 pages), lime, marble, and sandstone. Work at Jackson is being done to a depth of 4100 feet.

Notes on Calaveras county cover 78 pages. In 34 years the mineral output was \$49,437,433, of which gold accounted for \$39,926,552, and copper \$8,233,314. The Mother Lode here displays the characteristics of large bodies of low and medium-grade ore, presenting mining propositions now attractive to conservative capital.

Tuolumne county (41 pages), had an output of \$34,744,511

In 34 years gold contributing \$32,983,771, and limestone and marble over \$1,200,000. Some well known mines are operated in this county. Readers of the Press will have noted the revival at Sonoma of late.

The chapter on the 'north of the Bay' (San Francisco) group covers the counties of Colusa, Glenn, Lake, Marin, Napa, Solano, Sonoma, and Yolo. This district contains a greater number and variety of mineral springs than any other similar area in the United States. It has also been an important producer of quicksilver, and is notable for its yield of cement, crushed rock and other building materials. The report contains 208 pages and the price is 50c, postpaid. Walter W. Bradley is the author, who had an extensive area to cover to investigate the varied resources. The value of the mineral production of these counties is as follows: Colusa, (from 1875), \$2,621,123, sandstone amounting to \$1,149,998, and mineral water, \$881,258; Glenn (from 1890), \$244,876, building materials predominating; Lake (from 1873), 247,877 flasks of quicksilver worth \$9,091,501, 6,117,157 gal. of mineral water, \$2,089,745, and \$591,236 of borax; Marin (from 1888), \$3,869,799, brick and stone making over \$3,700,000; Napa (from 1862), \$21,648,719, of which \$14,898,951 is from 331,063 flasks of mercury, and \$1,779,999 from mineral water; Solano (from 1873), \$17,295,665, mostly building materials; Sonoma (from 1873), \$7,662,966, quicksilver contributing \$2,533,228 and stone \$4,277,886; while the mineral resources of Yolo county are now being developed. Copiously illustrated deposits and plants add greatly to the value of this report.

The chapter on Del Norte, Humboldt, and Mendocino covers the three northernmost coast counties. There are important mineral resources in this area, most of them as yet undeveloped owing to lack of transportation facilities. The completion of the Northwestern Pacific railroad to Eureka, and the line now reported under construction from Grant's Pass, Oregon, to Crescent City, will result in increased development of all industries in this district. It is also one of the most important lumbering areas of the State. The report is of 60 pages, and the price is 25c, postpaid. F. L. Lowell is the author, who commences with a brief geologic description of the region. The black sands of this part of the State are frequently discussed among mining men, and under Del Norte and Humboldt counties the author gives some notes on the subject. Chrome iron occurs in several places. The Horse Mountain copper deposits, before the investing public some time ago, are described; so are the placer operations, oil occurrence, magnesite, and manganese.

The chapter on the San Joaquin Valley district covers the counties of Fresno, Kern, Kings, Madera, Mariposa, Merced, San Joaquin, and Stanislaus. While this is one of the most important agricultural sections of California, it also has large and valuable mineral resources, including the Kern County and Coalinga oil fields, and the famous Raymond granite quarries. The report covers 220 pages, the price of which is 50c, postpaid. The authors are Walter W. Bradley, G. Chester Brown, F. L. Lowell, and R. P. McLaughlin. Fresno county has a mineral output of \$66,294,637, petroleum accounting for \$62,139,959, copper \$1,063,957, and stone \$1,167,433. As the oil industry was recently covered in Bulletin 69 of the Mining Bureau, only brief mention is made of the industry in this and Kern county, the latter having produced \$131,441,710 out of a total of \$159,176,273 of all minerals. Interesting reviews are given on the power schemes, quarries, quicksilver deposits, antimony, the Nimaret iron deposit (by F. B. Weeks), in Madera county, gold mining in Mariposa county, dredging in Merced county, and gas wells in San Joaquin county.

The chapter on Shasta, Siskiyou, and Trinity counties covers an area in which is located the State's largest copper and silver-producing area, also the largest yielding hydraulic gold mines of the present day. The western part of this area in particular has great possibilities from a mineral standpoint, but as yet only slightly developed on account of meager trans-

portation facilities. The report is of 192 pages, the price being 50c. postpaid. G. Chester Brown is the author. The mineral yield of these areas is as follows: Shasta (from 1880), \$102,921,076, of which \$66,603,109 is copper, and \$24,528,938 gold; Siskiyou (from 1894), about \$15,000,000, mostly gold; and Trinity, \$150,000,000, mostly gold. Shasta county is busy at present on account of the demand for copper, while the zinc output is increasing at a great rate; the copper belt is fully described. Some of the asbestos deposits are of importance. Sections of gold mines are shown. This county has the only electric iron smelter in the State, now reducing iron and manganese ores. Siskiyou is noted for its many small gold mines and placer workings. Trinity is a mountainous area. Quartz mining is not considered to be on a large scale, but hydraulicking and dredging are. The asbestos deposits are promising.

AMADOR COUNTY

After being reported as sold many times during recent years, the old Eureka mine at Sutter Creek has really been sold to New York people, represented by Walter Beam of Denver. The property was owned by Mrs. Hetty Green, who allowed it to be idle for 31 years.

CALAVERAS COUNTY

Underground work at the Utica mine at Angels was suspended on December 25, when 100 men were paid off. Nothing is known of future plans. The mill is crushing ore from the Goldcliffe mine, owned by the Utica company. J. F. Martin is superintendent.

ELDORADO COUNTY

The Guilford mill, 2½ miles from Placerville, was held up and robbed of \$1200 of amalgam on December 25, the bandits scraping the plates in expert style.

NEVADA COUNTY

Following its usual custom, the North Star Mines Co. on December 24 gave each employee receiving \$3 per day a \$10 coin, and each receiving less than that wage, a \$5 coin.

SHASTA COUNTY

(Special Correspondence.)—The Mammoth Copper Co. has started a lower adit from the Friday-Lowden mine to develop the main orebody 400 ft. below the present lowest workings. It will be 7½ by 8½ ft., and 5000 ft. long. It will form the main working adit, and be known as No. 6 tunnel. Three blast-furnaces are reducing copper ore, including 300 tons received daily from the Balaklala company. Shipments of selected zinc ore are being made to Eastern plants at the rate of 250 tons per day. Arrangements have been made recently for more extensive work at the Sutro, Stowell, and other mines.

Operations have been resumed at the Shasta Belmont, near Copper City, with William Arps in charge of affairs. The property has been developed to a limited extent by short adits and some rich ore exposed. A good wagon-road extends from the mine to Heroult, on the railroad, and small shipments will be made to the Mammoth smelter. A new main adit has been started, designed to open the ore at fair depth. The ore contains copper and zinc, with some gold and silver.

Large quantities of supplies have been shipped to the Midas mine, at Harrison Gulch, and preparations made for more extensive work. Unwatering of the deep levels of the Midas will be pushed, and development of the Gold Hill, Bonanza, and other properties carried forward. More units will be added to the reduction plant in the early spring.

It is estimated by conservative mine operators that the mineral output of Shasta county for 1915 will approximate \$7,000,000. The increase is due largely to the heavy output of zinc, and the higher price of copper. This year marks the first time that the extensive zinc-ore deposits have been turned to profitable account.

Redding, December 20.

The Crown Deep mine between Redding and Shasta is to be

re-opened by the owner James Hulme. The power-line was stolen last year. In the past this mine was a good producer.

SIERRA COUNTY

As was mentioned in the Press last week, a blast of 11 tons of powder was to be set off at the Brandy City gravel mines. The powder, in 25-lb. sacks, was arranged in a drift, tamped, and connected with the outside by fuses. These were lit on December 23 at 3:30 p.m. Eight men then retired to the blacksmith-shop, which is surrounded by high banks 200 yards distant. Some of the powder exploded, the remainder catching fire and blowing out from the mouth of the drift. The flame, smoke, and fume quickly spread over the whole area, enveloping the men. As a result four men were asphyxiated, while the others are still very ill. The fume was smelt as far away as Comptonville, seven miles distant; while at Brandy City, a half-mile from the mine, several people were almost overcome. The cause of the accident is unknown. Previous large blasts at the same property were always successful.

TRINITY COUNTY

Most of the small mines in the Carrville district are closed for the winter, but the Bonanza King has 40 men in its mine and mill, while the Strode is leased, with five stamps dropping.

Hydraulicking has been started at the Paulsen ranch, a half-mile from Lewiston. The property is of considerable extent. An eight-mile canal delivers 600 miner's inches of water with a 200-ft. head. The gravel averages 20 ft. in depth. Seven men are employed. The owner is the Bablou Mining Company.

COLORADO

CLEAR CREEK COUNTY

(Special Correspondence.)—A two-foot body of smelting ore has been cut on the 100-ft. level of the Albro mine situated on Albro mountain. Shipments are at the rate of two carloads per week, returning \$65 gold and silver per ton. Earl Dingle is lessee.—The Wyoming Valley adit in Gilson gulch is being extended steadily. The manager, J. J. Hoban, states that an electric compressor is to be installed at once. Shipments have been started from the White property of the Little Giant Mining Co., on Red Elephant mountain. The ore is being extracted from the vein cut 2000 ft. from the portal of the Commodore adit, and returns averaging \$70 per ton in gold, silver, and lead are being received.—Work will be resumed on January 1 at the Stanley mine. The adit will be driven to intersect a number of cross-veins, while development will also be done on several levels of the shaft workings. H. J. Wolff is manager.—Machine-drills were started this week at the McClelland adit, the portal of which is situated near Dumont. There will be no cessation of work until 3000 ft. has been driven. This will take the heading to the base of the Lamartine mine. L. W. Shaffer is manager.—Jenkins and Johnson, leasing on the Pozo mine, are making an average net earning of \$2000 per month. Operations are above the Newhouse adit.

Idaho Springs, December 19.

GILPIN COUNTY

On every 1000 shares in the Cashier Gold Mining & Reduction Co., which operates the Pittsburg mine in lower Russell gulch, a dividend of \$15 has been paid. The employees were given a 10-lb. turkey each. The shaft is to be sunk to 100 ft. An electric pump has been installed at 1000 ft. Recent shipments were high in gold, silver, and copper. W. Auger is superintendent.

Good settlements are reported from the Senator, Gilpin-Eureka, Ingalls, Powers, New Treasury, and Black Hawk mines.

HINSDALE COUNTY

The Colorado-Utah Mining & Operating Co., which has a lease of the Golden Fleece mine, has erected a concentrating-plant.

TELEB COUNTY (CRIPPLE CREEK)

The Elkton shaft is down 1438 ft. No. 17 level station is to be cut. The main vein will be cut on the dip near the shaft at the bottom level, and ore should be mined early in February. Water is receding at the rate of 2 1/2 ft. per month. As the Roosevelt drainage tunnel approaches the shaft, now less than 500 ft. distant, the water recession is more rapid.

IDAHO

SHOSHONE COUNTY (COUR D'ALENE)

It is considered probable that the Chicago, Milwaukee, and St. Paul railroad will be constructed to this region.

At 900 ft. in the Marsh mine 7 ft. of ore has been opened, 3 ft. being suitable for shipment. The mill is making high recoveries.

A cross-cut in the Patuxent, Nine-Mile district, has passed through 60 ft. of ore, 6 ft. of which contains 30% lead, with some zinc. Another good vein is being developed in this mine, worked mainly by James P. Callahan, well known in Idaho.

For the sum of \$150,000, A. Swan of Burke has secured an option to purchase and lease the Cour d'Alene Mining & Concentrating Co.'s property. A royalty of 15% of the net smelter returns is to be paid the mining company, which will apply on payments falling due.

The first of the regular monthly dividends of 7c. per share, equal to \$7.00, was paid by the Hecla company at Burke on December 20. An extra of 3c. was also paid. The total for 1915 was \$265,000, and \$1,757,000 to date.

Concentrates assaying up to 35% copper and 90 to 100 oz. silver, are being shipped from the National mill at Mullan to the smelter. A good recovery is reported from the plant.

The Anaconda Copper company has secured a three-year hold on the Douglas mine in the Pine Creek district for the sum of \$200,000. An initial payment of \$100,000 has been made. A mill and other machinery is to be ordered at once. The ore contains zinc, which will be treated at the new plant at Great Falls, Montana.

Dividends of Cour d'Alene companies are as follows, according to *The Wallace Miner*:

| | | |
|------------------------|-------|-----------|
| Callahan | | \$ 52,100 |
| Bunker Hill & Sullivan | | 163,500 |
| Interstate-Callahan | | 697,485 |
| Hecla | | 100,000 |
| Federal | | 120,000 |
| Heard's | | 200,000 |
| Success | | 15,000 |

Total\$1,378,085

Total 1915.

| | | |
|------------------------|-------|-------------|
| Bunker Hill & Sullivan | | \$1,062,750 |
| Callahan | | 977,300 |
| Federal | | 180,000 |
| Hecla | | 565,000 |
| Heard's | | 2,250,000 |
| Interstate-Callahan | | 2,557,115 |
| Stewart | | 801,934 |
| Success | | 555,000 |

Total\$8,952,429

MICHIGAN

THE COPPER COUNTRY

Two more stamps are to be added to the Ahmeek mill; they should increase the annual output by 7,000,000 lb. of copper. Four shafts are supplying ore.

A number of additions and improvements are being made at the White Pine mine and mill. The new railroad to the property was completed and opened for traffic last week.

The Franklin mill crushed about 30,000 tons in December. Fifty machine-drills are at work underground.

MISSOURI

JASPER COUNTY

Owing to the rise in prices for concentrate the expected \$25,000,000 output for the region will be exceeded. The yield during the week ended December 17 was 6087 tons blende, 518 tons calamine, and 304 tons lead, averaging \$89.65, \$64.47, and \$69.81 per ton respectively. The total value was \$545,736, and for 51 weeks, \$24,615,953.

In the zinc-lead region there are approximately 300 mines being operated, half of which are using electric power to great advantage. Current for some districts is not yet available, but provision has been made for motors. It is estimated that some time ago motor-driven pumps were lifting 86,000,000 gal. of water per day.

MONTANA

LINCOLN COUNTY

Spokane people, headed by J. E. Wallace, W. W. Wallace, and C. Robinson, have organized the Diamond Hitch Mining Co. to operate the Diamond Hitch and Cabinet Queen lead-zinc claims near Troy. In the Troy mine the Wallace Bros. are opening good lead-zinc ore. An adit from this mine will develop the others.

SILVERBOW COUNTY

In his report for the year ended November 30, 1915, the deputy state mine inspector, Mr. McGrath, considers that conditions in this county were never better, nor the future brighter. There are 14,067 men employed, receiving \$1,595,845 in wages during September. This does not include lessees and prospectors. As has been mentioned in previous issues of the Press, many mines are being re-opened.

Some of the taxpayers of this county are as follows: Anaconda Copper Mining Co., \$272,262; Butte & Superior Copper Co., \$81,264; Butte, Anaconda & Pacific railroad, \$11,644; Elm Orlu Mining Co., \$11,066; and North Butte Mining Co., \$10,879.

The *Butte Miner* of December 19 is a special issue of 56 pages, a number of which are devoted to local mining.

NEVADA

CLARK COUNTY

Little has been heard of the Boss platinum mine of late. It was under option to California people, but has reverted to the original owners, S. E. Yount, F. A. Hale, and O. J. Fisk. Of the purchase price of \$150,000, only \$50,000 was paid. An adit is being driven to cut the rich vein recently opened.

Goodsprings, Platina, and Smithsonite districts are busy.

ELKO COUNTY

Operators in the Dolly Varden district, near Currie, are optimistic as to the future. More work has been done in the last four months than in a previous year.

ESMERALDA COUNTY

The final report of the Goldfield Consolidated for November shows that 32,100 tons of ore gave a net profit of \$52,706. Costs totaled \$4.73 per ton. Development amounted to 2412 ft., at \$5.75 per foot. Lessees mined 219 tons of ore worth \$4394; of this the company received \$2213, less transport and treatment.

NYE COUNTY

Eight companies and several lessees at Tonopah last week produced a total of 10,423 tons of ore, worth \$213,574.

The Belmont shipped 152,100 oz. bullion. On December 19 the refinery at the Tonopah mill of this company was destroyed by fire, caused by an oil-supply pipe breaking.

At 1540 ft. in the Extension, the Murray vein has been opened by a cross-cut from the Victor shaft. So far the metal-value is low. A bullion shipment consisted of 87,165 ounces.

In the Tonopah Mining Co.'s properties development totaled

344 ft., considerably above the average, with encouraging results. The plant at Millers treated 2865 tons of ore.

The Cash Boy, Halifax, and North Star made small shipments to the West End mill.

UTAH

Of the 120 pages in its special issue, of December 18, the *Deseret Evening News* devotes 13 pages to mining. It states that "great as has been the advances in mining in Utah in the past, they have been as nothing in comparison with the progress made in 1915." This was reflected on transactions at the Salt Lake Stock Exchange, where 13,000,000 more shares were sold than in 1914. One of the greatest features was the increased mill capacity of the State, also the important developments in the Alta-Cottonwoods area, and the large increase in the output of Park City. Brief mention is made of the important developing and producing mines. The estimated metal production was as follows:

| Metal. | 1915. | 1914. |
|-----------------------|--------------|--------------|
| Arsenic, pounds | 1,827,200 | 2,051,940 |
| Copper, pounds | 174,864,825 | 152,034,002 |
| Gold, ounces | 170,836 | 157,961 |
| Lead, pounds | 186,030,225 | 171,323,137 |
| Silver, ounces | 12,512,891 | 11,154,916 |
| Zinc, pounds | 27,341,830 | 15,989,267 |
| Value | \$37,336,267 | \$52,229,268 |

trict was sold last week to the U. S. R. & M. Co. It consisted of 21 tons assaying 3.28 oz. gold and 2 oz. silver per ton, from the Davis lease.

JUAB COUNTY

With a capital of \$2,000,000 the Tintic Tunnel Co. was incorporated last week. It will drive a drainage-tunnel about five miles long, that will reach a depth of 2300 ft. below the collar of Iron Blossom No. 2. The grade will be 12 ft. per mile. There will be room for a double-track electric line, and a drainage-ditch. It is thought that the water developed will pay the cost of the work.

SALT LAKE COUNTY

Grading for the first four miles of the Alta-Cottonwood electric tramway is finished; the road is to be eight miles in length. Locomotives and other equipment have been ordered.

SUMMIT COUNTY

The flotation-plant at the Silver King Coalition has been in operation since December 5, and is giving

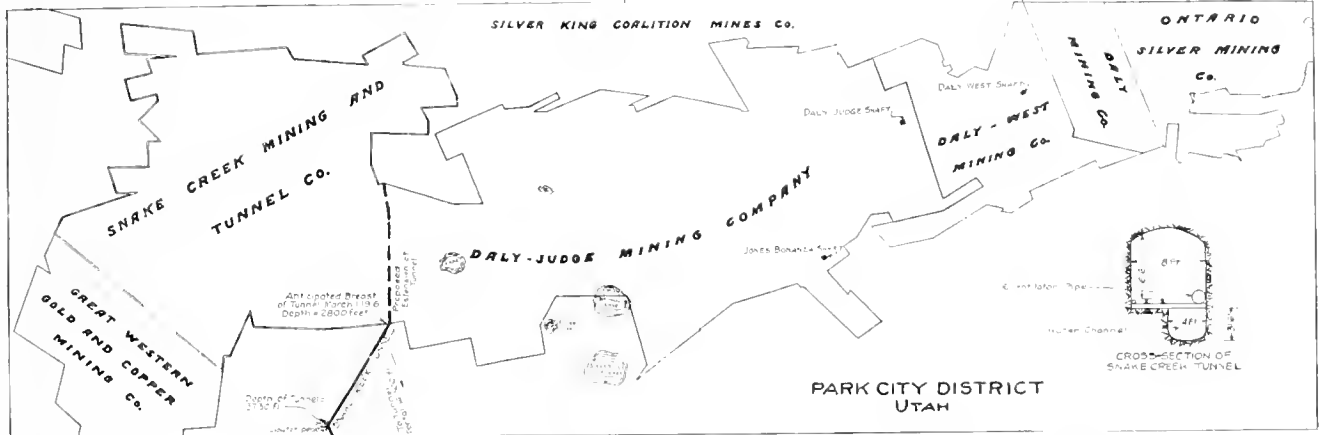
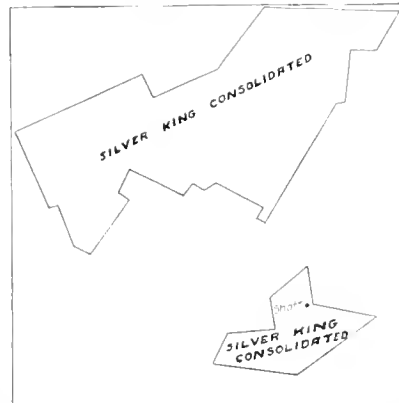

Dividends totaled \$10,136,636, against \$7,107,822 in 1914. The total disbursements are \$128,384,153, from a metal output of \$724,609,605.

The Bingham district made an interesting showing on account of new development, and 33 mines yielded a total of 10,176,984 tons of ore worth \$33,786,250, mostly in copper from the Utah Copper Company.

In the Alta-Cottonwoods a year ago only 17 mines were worked, employing 100 men; now there are 70 and 700, respectively. Ore shipments in the past two years were \$221,000 and \$1,000,000, showing the amount of work done. Good progress is being made on the new electric railroad to serve the region. The U. S. Geological Survey has just published a bulletin, No. 620-J, on this region.

At Park City 12 mines in 1914 shipped 62,606 tons, while in 1915 the figures were 18 and 91,477, respectively. Re-treatment of tailing is a feature of present operations. Much new equipment has been erected. The Snake Creek tunnel is now in over 13,000 feet.

There were seven dividend-payers at Tintic. Ore shipments for 11 months show a fair increase over 1914.

BEAVER COUNTY

Fortuna continues to expand; 75 miners are busy; there are more prospectors; and extensive development is planned by several companies. The first shipment of ore from the dis-

excellent results, the recovery of lead and silver being from 90 to 95 and 90 to 93%, respectively.

UTAH COUNTY

To develop and extract various substances from the oil-shale in Kyune canyon, the Utah Oil Shale Products Co. has been organized with a capital of \$300,000. The John D. Scott process will be used. L. P. Palmer is president and A. H. Northrop vice-president.

WASHINGTON

CHELAN COUNTY

(Special Correspondence.)—A car of antimomial ore from the Gold Creek mine, in the Methow district, has been shipped to Chicago. The company is preparing to build a small smelter at the mine this winter.

Methow, December 25.

STEVENS COUNTY

Five hundred tons of zinc carbonate ore has been contracted to go to Donora, Pennsylvania, from the Great Western mine, seven miles south-east of Northport. The ore assays 30% zinc, 5% iron, and 1% sulphur. The daily shipment will be 15 tons. Development is good in this mine operated by the Norman Mines Company.

CANADA

BRITISH COLUMBIA

The Granby company's furnaces are reducing 900 tons of ore each per day, the Anyox total in November being 60,000 tons. The converter plant here has been closed for the winter, matte being sent to the smelter at Grand Forks. Costs of producing copper at Anyox are expected to be reduced to 8c per pound.

On January 10 the Standard Silver Lead company will pay 24c per share equal to \$50,000, and making a total of \$1,800,000.

ONTARIO

In November the McIntyre mill at Porcupine treated 8657 tons of \$7.29 ore with 95.52% recovery, at a cost of \$4.07 per ton. The profit was \$25,950. The ore averages \$11.17 per ton at 600 ft. depth, at 700 ft. it is erratic, from 10c to \$10.40. The Extension shaft is down to 885 ft. The McIntyre-Jupiter Mines, Ltd., has been formed with a capital of \$2,000,000, of which the McIntyre-Porcupine Mines, Ltd., takes 955,000 shares and the Jupiter Mines, Ltd., receives 943,893 shares and \$60,000 for its property.

No. 8 vein of the Tough-Oakes has been cut at 250 ft. depth. Other developments are very satisfactory.

At a depth of 425 ft. the Hollinger company has started a long drift to connect with a shaft at the Vipond boundary. This will take 18 months, but will result in rapid underground electric haulage.

Near Timmins the Hayden Gold Mines Co. has 11 men employed at exploration.

A 3-in. vein of 3000-oz. ore has been cut in a winze below the 350-ft. level of the Chambers-Ferland. The vein is in conglomerate, 37 ft. from the Nipissing boundary.

After January 1, 1916, the Crown Reserve company need not pay royalty on ore extracted to the Ontario government, but will pay the 37% profits tax, which applies when an annual profit of more than \$10,000 is made.

The Triumph Mines Limited has been organized with a capital of \$1,000,000 to develop the Success claims at Porcupine, succeeding the Porcupine-Success Gold Mines Ltd. The western part of the property has been extensively trenched, disclosing 20 veins. Shaft-sinking is to be commenced.

The Hollinger mine and mill employs 1100 men, also contractors. Sinking continues.

A 6 ft. by 22-in. Hardinge ball-mill, one 5 by 11-ft. tube-mill, three 22 by 18-ft. agitators, and five 32 by 8-ft. Dorr thickeners are soon to be installed in the McIntyre mill, to increase the daily capacity from 300 to 450 tons.

By means of a device (to be patented) of C. A. Randall of the Tough-Oakes mill at Kirkland Lake, the capacity of the plant has been increased from 80 to 110 tons daily.

KOREA

In November the Oriental Consolidated mines and plants yielded \$144,800. The ore was above average grade.

MEXICO

HIDALGO

During October the Santa Gertrudis mill treated 20,503 tons of ore for a profit of \$34,000.

SONORA

Eight furnaces are in blast at the Cananea Consolidated. The Moctezuma mine and mill will be re-started in a few days. The railroad to Nacozari is not repaired yet.—El Tigre is to resume in a few days.

PHILIPPINE ISLANDS

After being erected in fast time the new mill of the Benguet Consolidated company at Baguio had its first clean-up near the middle of October. A new vein of better grade ore has been opened. C. M. Eye is in charge.

PERSONAL

FRANK A. CRAMPTON is at Philadelphia.

L. R. BUDROW has returned to El Tigre, Sonora, Mexico.

J. S. WILLIAMS has returned to Nacozari, Sonora, Mexico.

ARTHUR R. WEDGALL has arrived in San Francisco from Korea.

WILLIAM MALLERY is working antimony ore at Hercul, Nevada.

WALTER J. RADLOW has returned here from Breckenridge, Colorado.

E. C. BROOMFIELD has arrived from the Altai, having been in Siberia three years.

O. A. TURNER is manager for the Copperfield Mining Co. at Gross Springs, Arizona.

S. J. LEWIS spent the Christmas holidays at Monterrey, returning to Mexico City.

BERTRAM HUNT is now connected with Maurice, Radlan & Co., at Medellin, Colombia.

NORMAN C. STINES, manager of the Sissert copper mine, Ural region, Russia, is visiting Berkeley.

J. M. MITCHELL-ROBERTS, metallurgist with the Seoul Mining Co., in Korea, is on a visit to California.

W. J. LAKELAND sailed by the *Ventura* on December 28 on his return to Burma, by way of Australia.

E. H. HAMILTON is consulting metallurgist with the Canadian Consolidated Smelting Co., at Trull, B. C.

JOHN D. POPE, 11 years general manager of the North Butte mine, has resigned; NORMAN BRALLEY succeeds him.

WILLIAM THUM, superintendent of the U. S. Metals Refining Co.'s plant at Grassell, Indiana, is at Kennett, California.

JOHN HENRY RICKARD has arrived in San Francisco to superintend the antimony smelter of the Chapman Smelting Co., in this city.

GIULIO CARIANI, now an officer in the Italian engineering corps, has been wounded in action and recommended for the military medal.

B. F. P. RÖMER has left Amsterdam on his way to Batavia, Dutch East Indies, where he will make geological examinations for the Government.

ARTHUR GIFFORD, formerly superintendent of the Mysore mine, died at Madras in December.

H. L. TWITE, of the mining engineering firm of Twite & Stannard, has been killed in action while serving as a lieutenant with the Royal Engineers in France.

The U. S. Civil Service Commission, Washington, D. C., announces an open competitive examination for metallographist, for men only. From the register of eligibles resulting from this examination certification will be made to fill a vacancy in this position in the War Department, for duty at Watertown arsenal, Massachusetts, at a salary of \$2600 per year, and vacancies as they may occur in positions requiring similar qualifications. The appointee to this position will have general but subordinate charge of the testing laboratory at the arsenal; direct the preparation of metal specimens for microscopic examination, the photographing of the same and the interpretation of the appearance of the specimens under the microscope, and prescribe proper heat treatment, etc., for specimens examined. Applications must be filed at Washington by January 25.

The Commission also announces an examination for civil engineer, applications to be in by January 18. Eligibles from this will be available for vacancies in the Philippine service, at \$1800 to \$3000 per year. A knowledge of design and construction of various equipment, and also of water supply and irrigation is necessary.

THE METAL MARKET

METAL PRICES.

San Francisco, December 29.

| | Cents per pound. |
|--|------------------|
| Antimony | 40 |
| Electrolytic copper | 23.50 |
| Pig lead | 5.65—5.85 |
| Quicksilver (per flask) | \$135 |
| Spelter | 20 |
| Tin | 40 |
| Zinc-dust, 100-kg. zinc-lined cases..... | 30 |

ORE PRICES

San Francisco, December 29.

| | |
|--|-------|
| Antimony: market weaker; 50% product, per unit..... | \$ 2 |
| Chrome: 52% chromic oxide and 2% silica per ton..... | 12 |
| Magnesite: plastic, no iron and lime, calcined, per ton.... | 60—65 |
| Magnesite: refractory, up to 7% iron, calcined, per ton.... | 30—40 |
| Manganese: 50% metal, 8% silica, per ton, f.o.b. cars, S. F. . | 12 |
| Tungsten: minimum 65% WO ₃ , per unit for spot..... | 35—45 |

At Boulder, Colorado, on December 28, 60% tungsten ore realized \$47.50 per unit.

EASTERN METAL MARKET (By wire from New York.)

NEW YORK, December 29.—Copper is excited and active; lead is firm owing to export demand; zinc is quiet but firm.

SILVER

Below are given the average New York quotations, in cents per ounce, of fine silver.

| Date. | Average week ending |
|-------------------|---------------------|
| Dec. 23..... | 54.00 |
| " 24..... | 53.87 |
| " 25 Holiday..... | |
| " 26 Sunday..... | |
| " 27..... | 53.87 |
| " 28..... | 54.12 |
| " 29..... | 54.37 |

Monthly averages.

| 1914. | 1915. | 1914. | 1915. | | |
|-----------|-------|-------|------------|-------|-------|
| Jan. | 57.58 | 48.85 | July | 54.90 | 47.52 |
| Feb. | 57.53 | 48.45 | Aug. | 54.35 | 47.11 |
| Mch. | 58.01 | 50.61 | Sept. | 53.75 | 48.77 |
| Apr. | 58.52 | 50.25 | Oct. | 51.12 | 49.40 |
| May | 58.21 | 49.87 | Nov. | 49.12 | 51.88 |
| June | 56.43 | 49.03 | Dec. | 49.27 | |

An error in silver prices last week gave an average of 55.22c.; this should have been 54.23 cents.

The President of Uruguay has recommended to that country's Congress that a bill be passed to coin 5,000,000 pesos, equal to \$5,170,000, say 10,000,000 oz. silver, but old coins are to be melted, yet some new metal will be required.

Profit taking by India, and a lull in European buying caused a slight weakening lately, but there is not much set-back anticipated. The Chinese New Year occurs on February 4; this is a stiffening factor. The shortage of British coin is not yet satisfied; the Master of the Royal Mint is appealing to the suppliers of gas to arrange for the clearance of automatic gas-meters at more frequent intervals, with a view to the return of the coin into active circulation as speedily as possible.

COPPER

Prices of electrolytic in New York, in cents per pound.

| Date. | Average week ending |
|-------------------|---------------------|
| Dec. 23..... | 20.87 |
| " 24..... | 21.12 |
| " 25 Holiday..... | |
| " 26 Sunday..... | |
| " 27..... | 21.50 |
| " 28..... | 22.00 |
| " 29..... | 22.25 |

Monthly averages.

| 1914. | 1915. | 1914. | 1915. | | |
|-----------|-------|-------|------------|-------|-------|
| Jan. | 11.21 | 13.60 | July | 13.26 | 19.09 |
| Feb. | 14.46 | 14.38 | Aug. | 12.34 | 17.27 |
| Mch. | 14.11 | 14.80 | Sept. | 12.02 | 17.69 |
| Apr. | 14.19 | 16.64 | Oct. | 11.10 | 17.90 |
| May | 13.97 | 18.71 | Nov. | 11.75 | 18.88 |
| June | 13.60 | 19.75 | Dec. | 12.75 | |

Exports during the week ended December 11 totaled 15,793,210 lb., worth \$2,962,163. England got 2,637,192; France, 5,599,216; Italy, 4,282,917; and Sweden, 1,837,526 lb. Imports amounted to 7,470,514 lb., valued at \$1,180,923. Of this, Canada sent 1,901,362; Chile, 940,579; and Peru, 4,042,961 pounds.

Dividends declared are as follows: Anaconda, \$1.50; Champion,

\$2, making \$31 for 1915, against nothing in 1914; Greene Consolidated, 50c.; North Butte, 50c.; Osceola, \$3; Tennessee, 75c.; and U. S. R. & M. Co., 75c. on common stock.

The past year was the most profitable for the A. S. & R. Co. in the United States.

LEAD

Lead is quoted in cents per pound or dollars per hundred pounds, New York delivery.

| Date. | Average week ending |
|-------------------|---------------------|
| Dec. 23..... | 5.40 |
| " 24..... | 5.40 |
| " 25 Holiday..... | |
| " 26 Sunday..... | |
| " 27..... | 5.40 |
| " 28..... | 5.40 |
| " 29..... | 5.40 |

Monthly averages.

| 1914. | 1915. | 1914. | 1915. | | |
|-----------|-------|-------|------------|------|-------|
| Jan. | 4.11 | 3.73 | July | 3.80 | 5.59 |
| Feb. | 4.02 | 3.83 | Aug. | 3.86 | 4.67 |
| Mch. | 3.94 | 4.04 | Sept. | 3.82 | 4.62 |
| Apr. | 3.86 | 4.21 | Oct. | 3.60 | 4.62 |
| May | 3.90 | 4.24 | Nov. | 3.68 | 5.15 |
| June | 3.90 | 5.75 | Dec. | 3.80 | |

ZINC

Zinc is quoted as spelter, standard Western brands, New York delivery, in cents per pound.

| Date. | Average week ending |
|-------------------|---------------------|
| Dec. 23..... | 17.50 |
| " 24..... | 17.30 |
| " 25 Holiday..... | |
| " 26 Sunday..... | |
| " 27..... | 17.40 |
| " 28..... | 17.50 |
| " 29..... | 17.50 |

Monthly averages.

| 1914. | 1915. | 1914. | 1915. | | |
|-----------|-------|-------|------------|------|-------|
| Jan. | 5.14 | 6.30 | July | 4.75 | 20.54 |
| Feb. | 5.22 | 9.05 | Aug. | 4.75 | 14.17 |
| Mch. | 5.12 | 8.40 | Sept. | 5.16 | 14.14 |
| Apr. | 4.98 | 9.78 | Oct. | 4.75 | 14.05 |
| May | 4.91 | 17.03 | Nov. | 5.01 | 17.20 |
| June | 4.84 | 22.20 | Dec. | 5.40 | |

The Interstate-Callahan company, Idaho, has paid \$1.50 per share, equal to \$697,485, making \$2,557,495 since April last.

Net earnings of the American Zinc, Lead & Smelting Co. in 1915 were \$5,000,000; or \$20 per share, all debts are paid.

QUICKSILVER

The primary market for quicksilver is San Francisco, California being the largest producer. The price is fixed in the open market, and, as quoted weekly in this column, is that at which moderate quantities are sold. Buyers by the carload can usually obtain a slight reduction, and those wanting but a flask or two must expect to pay a slightly higher price. Average weekly and monthly quotations, in dollars per flask of 75 lb., are given below:

| Date. | Week ending |
|--------------|-------------|
| Dec. 1..... | 105.00 |
| " 8..... | 115.00 |
| Dec. 15..... | 130.00 |
| " 22..... | 130.00 |
| " 29..... | 135.00 |

Monthly averages.

| 1914. | 1915. | 1914. | 1915. | | |
|-----------|-------|-------|------------|-------|--------|
| Jan. | 39.25 | 51.90 | July | 37.50 | 95.00 |
| Feb. | 39.00 | 69.00 | Aug. | 30.00 | 93.75 |
| Mch. | 39.00 | 78.00 | Sept. | 36.25 | 91.00 |
| Apr. | 38.90 | 77.50 | Oct. | 53.00 | 92.90 |
| May | 39.00 | 75.00 | Nov. | 55.00 | 101.50 |
| June | 38.60 | 90.00 | Dec. | 53.10 | 123.00 |

The average price for 1915 was \$85.80 per flask.

According to H. D. McCaskey of the U. S. Geological Survey, this country produced 20,681 flasks in 1915, an increase of 4132 flasks, but the value was more than double. All States showed advances.

TIN

Prices in New York, in cents per pound.

| 1914. | 1915. | 1914. | 1915. | | |
|-----------|-------|-------|------------|-------|-------|
| Jan. | 37.85 | 34.40 | July | 31.60 | 37.38 |
| Feb. | 39.76 | 37.23 | Aug. | 50.20 | 34.37 |
| Mch. | 38.10 | 48.76 | Sept. | 32.10 | 33.12 |
| Apr. | 36.10 | 48.25 | Oct. | 30.40 | 33.00 |
| May | 33.29 | 39.28 | Nov. | 33.51 | 39.50 |
| June | 30.72 | 40.26 | Dec. | 33.60 | |

Tin is quiet at 39 cents.

Eastern Metal Market

New York, December 2.

Contrary to expectations, a revival in the demand for copper set in about December 15, and the climax came yesterday, the 22nd, when, through the United Metals Selling Co., the British government purchased 60,000 tons, or 120,000,000 lb., of copper for delivery at the rate of 5000 tons per month throughout 1916. The price was over 20c., and is understood to have been about 20.50c. From December 15 the quotation advanced almost daily, and prior to the news of the big purchase 20.50c. was quoted. Exports for the month were good. Spot zinc is scarce, and this fact, together with a fair demand has sustained prices. The unwillingness of consumers to buy far off deliveries of zinc is pronounced. Lead is firm at 5.40c., New York, and is principally supported by the strong export situation. Large consumers of tin were roused to activity by the report that Great Britain would limit exports until there was 4000 tons in stock. Antimony is more plentiful, but the quotation is maintained. Aluminum is easier, with fewer buyers in evidence.

The great demand for steel continues, ruling prices are the highest of many years. Several of the railroads have laid out large orders on shipments of iron and steel to New York for export, one result of which will be the shipping of steel to domestic consumers, which they might not have received otherwise. The entire trouble is due to the lack of ships to carry products abroad. Many thousands of loaded freight-cars, one estimate is 25,000, have been standing at or near New York harbor unable to unload. There is a shortage of lighterage facilities also. In some centres the situation has created a shortage of coal and coke.

COPPER

On the strength of the transaction before mentioned, the domestic quotation for electrolytic went to 20.75 and 21c., 30 days, delivered. Lake copper, the prices of which are on about par with electrolytic, is in an extremely strong position, with some of its producers sold up until March next. About December 15, following a period of quiet, some good inquiries appeared in the market and proved the forerunner of an excellent movement, something which was not expected in view of the heavy buying of previous weeks. Copper was taken, mostly for March and April deliveries at 19.87 to 20c., and by the 17th the market was firm at 20c., 30 days, delivered. By that date practically all resale metal had been absorbed, and the producers had the field to themselves. On the 20th, buyers were particularly active, and whereas 20c. could have been done in the morning, the market at midday went up with a rush to 20.25c., good sales were made at the latter figure. Coincident with the appearance of the large inquiries there was talk of a possible shortage of copper, of the possibility of consumption outstripping production, and persons in close touch with the producers are commencing to take the report seriously. War demand has continued the principal motive power behind activity, though the wire-mills have been heavier purchasers in the past few days. In London the trend of electrolytic copper has been upward, the quotation on September 21 being £100 10s. European statistics, as cabled to the New York Metal Exchange on December 20, showed that stocks in Great Britain on the 15th totaled 11,233 long tons, against 12,572 tons, November 30, and 17,118 tons, November 15. Fine copper in France amounted to 1262 tons on December 15, against 1473 tons on November 30, and 1645 tons on November 15. Exports in December total 24,972 tons.

ZINC

For upward of a week the market price of prompt spelter

has been close to 17.50c., New York. Lower has been quoted, it is charged, in the interest of some who seek to depress the market. On the other hand, sales of spot have been made at 17.75c., New York. The scarcity of prompt and nearby metal is insisted on by various producers. The demand has been good for deliveries to the end of the first quarter, but consumers are showing but little interest in deliveries further off, and this despite offerings at 15.50 to 16c., New York. St. Louis quotations are about 25 points under New York prices. Second-quarter metal is nominal at 13.30 to 14c., New York. Exports in December total 5661 tons.

LEAD

The strength of lead today unquestionably lies in the export demand. If the metal were to be had it would bring 5.50c., New York, for shipment to foreign consumers. Since the leading interest advanced its New York quotation to 5.40 (December 14) the independents have held to that figure. A few nervous consumers entered the market as a result of the advance, but the majority are proceeding cautiously and have not rushed to buy. Prior to the advance the market was weak, and both sellers and consumers were mystified by the advance. Inquiry has been light. Exports so far this month total 5908 tons.

TIN

The report published last week that England intended to curtail shipments of tin to this country until it had 4000 tons in its warehouses caused a rush to buy here, and on December 16 about 500 tons was taken by large consumers and dealers. On the 17th probably 300 tons more was purchased, but thereafter the market became quiet, and not even concessions in price could arouse the interest of buyers. The report that England is to regulate shipments, so far not officially confirmed, is generally accepted by the trade. It is regarded as reasonable that it should want to protect itself against delays in shipments from the Far East, and from possible interference with them. The New York quotation on December 15 was 37.75; 17th, 40; 21st, 39.50; and on the 22nd, 39c. Up to December 21, 3665 tons had arrived in the month, and there was afloat on that day 5478 tons.

ANTIMONY

Chinese and Japanese grades are quoted at 39c., duty paid, in a market considerably easier because of the arrival of several hundred tons. The plant of the Magnolia Metal Co., Matawan, New Jersey, was partly destroyed by fire on December 17. The company has been making antimony from domestic ores. Cookson's antimony at London is nominally quoted at £100 per ton.

ALUMINUM

The market for aluminum 99% pure is easier at 56 to 58c. per pound. Buyers are fewer and their requirements are more easily satisfied with scrap metal and wire. The latter, as previously stated, is being taken down and replaced with copper wire.

According to the U. S. Geological Survey, the past year's metal output was an increase of \$250,000,000 over that of 1914. The production is estimated as follows: copper, 1,365,000,000 lb.; gold, increase of \$7,000,000; silver, increase of 4,000,000 oz.; iron, increase of 6,500,000 tons; zinc, 425,000 tons; lead, 515,000 tons; quicksilver, 20,681 flasks, an increase of 25%, with small increases in coal, coke, oil, and portland cement. The Western States' metal output shows an increase of \$130,000,000. It is probable that final figures for 1915 will make a total of \$2,500,000,000.

Metal Production in 1915

The U. S. Geological Survey has issued its preliminary statements regarding the mineral output of certain states, from which the following is abstracted:

ARIZONA

The output of gold, silver, copper, lead, and zinc at mines was valued at \$88,551,000, an increase of nearly 48% from that of 1914, which was \$59,956,029. There was very little change in the output of gold, but there were notable increases in the other metals, especially in lead and zinc. Increased prices made a difference of nearly \$26,000,000 in copper, \$400,000 in lead, and over \$2,000,000 in zinc, according to estimates of V. C. Heikes.

A record production of silver was made, the output increasing from 4,377,994 to 5,458,000 oz. or over 24%. The greater part of the silver, as formerly, came from the copper ores, but the increase in the shipments of silver-lead ores also contributed to the increase. The Commonwealth mine, at Pearce, was treating approximately 10,000 tons of ore per month, making bullion containing principally silver.

Arizona is the leading copper-producing State of the country, and had an output of nearly 450,000,000 lb. in 1915, an increase of nearly 57,000,000 lb. in spite of the strike in the Clifton-Morenci district. Great increases were made at the smelting plants at the Calumet & Arizona, Copper Queen, United Verde, Hayden, International at Miami, and Consolidated Arizona at Humboldt.

The mine output of lead increased from 15,003,068 to \$22,272,000 lb., or 48 per cent.

The mine production of zinc, estimated as recoverable spelter, increased from 9,792,337 to 17,729,000 lb., an increase of 81%. It came almost entirely from the Golconda and Tennessee mines, in Mohave county.

For the first eleven months of 1915 the metal mines of Arizona contributed nearly \$11,000,000 in dividends, the principal ones being the United Verde, Miami, Calumet & Arizona, Ray Consolidated, Superior & Pittsburg, Old Dominion, Shattuck, Arizona Copper, United Globe, Tom Reed, and Magma.

COLORADO

The mine output of Colorado metals for eleven months of 1915, with an estimate for December, from data compiled by Charles W. Henderson, indicates a yield for the year of \$22,330,000 in gold, 7,080,000 oz. silver, 66,664,000 lb. of lead (in terms of lead in lead bullion and lead in leaded-zinc oxide), 7,100,000 lb. of copper, and 100,000,000 lb. of zinc (in terms of spelter and zinc in zinc oxide), with a total value of \$13,100,000, compared with \$19,883,105, 8,796,065 oz. 74,211,898 lb., 6,639,173 lb., and 96,774,960 lb., respectively, with a total value of \$33,460,126, in 1914.

The quantity treated by the Globe, Leadville, Pueblo, Durango, and Salida smelters was approximately the same as in 1914.

The gold output of Cripple Creek (Teller county) was \$13,539,245, an increase of \$1,543,129. The yield was also \$507,323 larger than the 1908 yield, which was the largest yearly output since 1906. Cripple Creek, to the end of 1915 has produced \$272,326,000.

Lake county, chiefly from Leadville, but also including the Lackawanna Gulch and St. Kevin lode districts and the Arkansas River dredge district, produced \$2,261,000 in gold, 2,660,000 oz. silver, 20,000,000 lb. lead, 1,840,000 lb. copper, and 71,000,000 lb. zinc, with a total value of \$14,000,000, against \$1,571,451, 3,810,830 oz., 26,784,615 lb., 2,382,910 lb., 78,763,334 lb., respectively, with a total value of \$9,957,297 in 1914.

The San Juan region of Dolores, La Plata, Ouray, San Juan, and San Miguel counties produced \$3,890,000 gold, 2,250,000 oz. silver, 13,800,000 lb. lead, 3,530,000 lb. copper, and 4,000,000 lb. zinc, compared with \$3,969,857, 2,515,437 oz., 11,861,766 lb., 2,379,639 lb., and 1,382,334 lb., respectively, in 1914.

IDAHO

The output of gold, silver, copper, lead, and zinc from ores sold or treated from Idaho mines in 1915, had a total value of about \$37,780,000. This is an increase of more than 53% over the production of 1914, which was valued at \$24,645,848. There was no great change in the output of gold and a slight increase in that of silver, but there were material increases in the production of copper, lead, and zinc, especially of zinc. The increase in the total value of these metals, amounting to over \$13,000,000, was due largely to the increased price of lead and zinc. These estimates are reported by C. N. Gerry.

The production of silver increased from 12,479,516 oz. to 13,000,000 oz., or more than 4%. The price of silver, however, was comparatively low and the value of the output was over \$400,000 less than in 1914.

The output of copper increased from 6,445,187 to 7,169,000 pounds.

The mine output of lead, which is the main mineral product in Idaho, increased from 348,526,069 to 377,000,000 lb. A large part of this output, however, had not reached the smelters at the close of the year. This is an increase of over 8% in quantity and nearly \$4,000,000 in value. Nearly all the large mines of the Coeur d'Alene region produced more lead in 1915 than in 1914 on account of the effort to market the ore the last half of 1915. The Yreka district around Wardner, alone produced 169,500,000 lb. of lead against 162,471,235 lb. in 1914.

Shipments of zinc ore and concentrate increased from 54,754 tons in 1914 to 97,000 tons in 1915. The shipments contained about 80,000,000 lb. of recoverable spelter, valued at over \$11,000,000. On account of the unusual price for zinc in 1915, the zinc produced in the State was more valuable than the gold, silver, and copper combined.

The principal dividend payers in 1915 were the Consolidated Interstate-Callaban, Hercules, Bunker Hill & Sullivan, Caledonia, Federal, Hecla, Stewart, and Success, which will pay in all nearly \$9,000,000.

MONTANA

The value of the output of gold, silver, copper, lead, and zinc from Montana mines in 1915 was nearly \$87,000,000, an increase of more than 81% over the total value of the same metals in 1914, which was \$47,849,747, and is the greatest annual value of metals produced in Montana. There were increases in the output of all metals, but especially of lead and zinc. Though quantities show increases, the large increase in value was even more the result of a great rise in prices. The figures are derived from preliminary estimates by Victor C. Heikes.

The mine output of gold was valued at nearly \$5,000,000, against \$4,117,911 in 1914, an increase of over 21%. There was a larger gold output from placers, particularly from dredging in Alder gulch, in Madison county. The production of gold from silicious ores also increased.

The mine output of silver increased from 12,016,460 to 14,500,000 oz., increase of nearly 21%. The increase was due not only to the enlarged output of copper ore, which supplies the greater part of the silver, but to the great impetus given to the marketing of zinc ores.

Montana's greatest asset is copper, the output of which increased from 233,229,640 to 275,000,000 lb. This was an increase

of nearly 18% over 1914, but the output did not reach that of 1913. In the early part of the year the mines were adjusting themselves to conditions, imposed by the War, but as the price increased from 13.60¢ in January to 19.75¢ in July, every effort was made to market the metal.

The mine output of lead increased considerably—from 9,656,998 to slightly over 14,000,000 lb., increase of over 45%, due largely to the shipment of lead concentrate and of residue resulting from zinc smelting.

The mine production of zinc increased from 111,589,544 to 184,086,000 lb. The spelter output represented an increase of nearly 61% in quantity, but as the price of the metal increased from 6.39¢ in January to 22.2¢ in June there was an increase in the value of the output from \$5,699,698 in 1914 to over \$26,000,000 in 1915. The two main producers were the Butte & Superior and Elm Orlu mines, at Butte.

The largest dividend payers were the Anaconda, Butte & Superior, and North Butte.

NEVADA

The value of the 1915 output of gold, silver, copper, lead, and zinc from Nevada mines was approximately \$34,566,000. This represents an increase of nearly 18% over the output of 1914. These estimates by V. C. Heikes of the Salt Lake City office of the Survey indicate a marked increase in zinc output, and increase in lead and copper yield, as compared with 1914. The copper production however was below that of 1913, when Nevada had a record output of over 90,000,000 lb. There was a slight increase in the gold production, but a decrease in silver largely in the Tonopah district, where the output was affected by the decreased price of silver.

The production of gold was valued at about \$11,968,000, an increase of 4% over the production of 1914. The greater part of the gold came from siliceous ores milled at Goldfield and about 2% of the total came from Tonopah.

The silver production decreased from 15,455,491 to 14,478,000 oz. The decrease was at Tonopah, where the mines were affected by the low price of silver. At the Comstock district of Storey county, the production was also lower, and the idleness of the Mason Valley copper smelter to a small extent lessened the silver output.

The mine production of copper increased from 69,986,450 to 67,480,000 lb., an increase of 19.6%. The total value of the output, on account of the high average price in 1915 increased from \$8,111,198 to approximately \$11,798,000.

The lead production increased from 12,899,655 to 14,782,000 lb., an increase of over 15%. This output, however, is not as great as that of 1913, when over 16,000,000 lb. was produced. There was great activity in the Yellow Pine district of Clark county, where lead-zinc ore is separated into lead and zinc products.

A great increase, nearly 92%, was made in the mine output of zinc from 12,989,232 to over 21,000,000 lb. As the price of the metal was abnormally high in 1915, the value of the output increased from \$661,992 to about \$2,993,000 in 1915. The Yellow Pine district of Clark county was by far the largest producer, but the Amalgamated Pioche property in Lincoln county made important shipments.

The main dividend payers of the State were the Nevada Consolidated, Goldfield Consolidated, Tonopah Mining, Tonopah Belmont, Tonopah Extension, Jumbo Extension, Jim Butler, Nevada Wonder, Seven Troungs Coalition, and West End. To December 1, 1915, the total in dividends was over \$6,000,000.

NEW MEXICO

The output for 11 months, with an estimate for December, indicates a yield of \$1,599,000 in gold, 2,632,999 oz. silver, 3,951,000 lb. lead, 72,000,000 lb. copper, and 24,640,000 lb. zinc (in terms of spelter and zinc in zinc oxide), compared with \$1,171,696, 1,777,445 oz., 1,763,641 lb., 59,397,925 lb., and 18,492,-

392 lb., respectively. These preliminary figures were compiled by Charles W. Henderson.

The Mogollon district, Socorro county, 80 miles from Silver City (Grant county), continued to be the most productive district in New Mexico in output of gold and silver. The production in 1915 was \$512,921 in gold and 1,319,460 oz. silver, as compared with \$629,192 and 1,410,327 oz. in 1914.

Another important district was the Cochiti (Hiland) district, Sandoval county, inactive from 1904 to 1914, but with a record from 1894 to 1904 of a production of \$695,000 gold and \$345,000 silver.

Copper has been an important metal in New Mexico. The output from 1845 to 1910 was 92,323,163 lb., and the total output to the end of 1915 was 318,027,798 lb. Since 1910 the increased production was due principally to the activity of the Chino Copper Co. Its gross output in 1915 was 69,375,000 lb. The Burro Mountain Copper Co.'s new 1000-ton mill in the Burro Mountain district, was operated only part of the time, but development of the mines continued on a large scale.

The yield of lead showed an appreciable increase.

Largely increased shipments of zinc carbonate and sulphide ores and zinc sulphide concentrates were made in 1915. The production of zinc ore and concentrates was 39,970 tons of 36.3%, compared with 29,459 tons of 37.53% in 1914.

SOUTH DAKOTA

The mine production of gold was \$7,390,000, compared with \$7,333,508 in 1914, and that of silver 193,000 oz., compared with 176,642 in 1914. A nominal quantity of lead was produced. These are preliminary estimates reported by Charles W. Henderson. The usual well-known producers contributed.

TEXAS

The output of Texas mines for 11 months, with an estimate for December, from preliminary figures reported by Charles W. Henderson, amounted to \$2500 in gold, 765,900 oz. silver, 250,000 lb. lead, 50,000 lb. copper, and 33,000 lb. zinc, compared with \$234, 539,817 oz., 149,027 lb., 23,760 lb., and 216,451 lb., in 1914, respectively.

WASHINGTON

The value of the mine output of gold, silver, copper, lead, and zinc in Washington decreased from \$809,767 in 1914 to approximately \$728,000 in 1915, according to preliminary estimates by C. N. Gerry. There were increases in copper and lead, to the extent of a return to normal production. There were shipments of zinc ore, the first since 1911. The gold and silver mines, however, showed decreased output, especially in the Republic mining district.

The mine production of gold, which is the most important metal of the State, decreased from \$557,173 to \$497,000.

The silver output decreased from 264,861 to 220,000 oz.

The mine output of copper increased from 778,728 to 915,000 lb., or over 17 per cent.

The production of lead from ores sold or treated increased from 65,597 to 230,000 pounds.

QUICKSILVER

The domestic output of quicksilver in 1915, based on preliminary figures collected from the individual producers by H. D. McCaskey, was 29,681 flasks, valued, at the average domestic price for the year at San Francisco (estimated at \$85.59 per flask), at \$1,768,225. Compared with the Survey's final statistics for 1914, which gave a production of 16,548 flasks, valued at \$811,680 (the smallest since 1869), the output of 1915 shows an increase of 4133 flasks in quantity and of \$956,545 in value. The value therefore more than doubled, owing to the greatly increased prices demanded, but the quantity increased only about 25%. The production was the largest in value since 1881, and the greatest in quantity since 1912.



EDITORIAL



T. A. RICKARD, Editor

STATISTICS issued by the State Mining Bureau indicate a remarkable increase of zinc production in California, from \$20,381 in 1914 to \$1,620,000 in 1915. On the other hand, the output of petroleum has diminished in value from \$47,000,000 to \$40,000,000, the yield having decreased by nearly 11 million barrels, although 240 new wells were drilled, increasing the total to 6500. The gold production is given as \$22,850,000, the highest since 1870 and the largest of any state in the Union. Increased activity in the mining of tungsten, antimony, magnesite, and manganese is reported. In value of total output, Shasta county is first. The total mineral output is estimated at \$95,211,000 for the year.

FOR some months past various brokers have been exceedingly active in the purchase of aluminum; first they bought scrap, and when that stock became exhausted they began to bid for aluminum electrical conductors in position, at prices that made it profitable to take down the aluminum and to replace it by copper of equivalent conductivity. Lately they have been purchasing such stock before it has been strung. If any owner of aluminum conductors, either in service or in the warehouse, still has any of it, either he has escaped the search of speculators or he is holding it for speculation on his own account. Where is it all going? Present evidence indicates that a complete answer may be found in the chemical literature of about four or five years ago, when a French chemist announced his discovery of an unusually powerful explosive, which he called 'ammonal,' the name being a combination of the chemical symbols of its component parts, ammonium nitrate and aluminum. A letter received recently from a German officer who was in the battle at Loos stated that in an examination of a position out of which the Germans were driven and which they afterward recovered, he counted some 640 dead in a space of about one hectare, of which less than 10% showed signs of mutilation. "The others were killed by that new terrible French explosive."

TUNGSTEN is in tremendous demand for the making of high-speed tool-steel. We take pleasure therefore in publishing a short account of the mining of scheelite, the tungstate of lime, in association with gold-bearing quartz at the Union Hill mine, in the Grass Valley district. In our 'Review of Mining' we also give notes concerning the Atolia mines. These have been worked for scheelite during the last ten years, but not with any remarkable profit until lately. Just now the output is at the rate of three carloads per month, say, 90 tons, of ore containing 30 to 50% tungstic acid. The few leases on

the property lapsed at the end of 1915 and will not be renewed, as the company intends to re-organize its operations, which are under the direction of Atkins, Kroll & Co., although the directors are four well-known Californian mining engineers. As high-speed tool-steel is worth \$3 per pound and tungsten ore is selling at the rate of \$45 per unit, it is obvious why the search for the principal tungsten minerals—wolframite, hübnerite, and scheelite—has been intensified lately. It is likely to continue unless manufacturers elect to use molybdenum steel, as they might do, for it has much the same qualities as tungsten steel. It would seem probable therefore that the price of molybdenum may rise shortly at the expense of tungsten.

ON New Year's day the principal mining companies at Douglas and Bisbee announced a voluntary increase in wages based on the recent rise in the price of copper. This is both just and sagacious. In the Clifton-Morenci district a sincere effort has been made by a Citizens Mediation Committee to arrange the settlement of the strike affecting the Arizona, Detroit, and Shannon copper companies and their employees. The strike has lasted now for four months. A concession as to higher wages was made by the mine managers, provided the men would surrender their charter of membership in the Western Federation, and this offer was presented by the citizens committee to the executive committee of the miners and through them to a mass meeting. The offer was rejected. It is reported that the American miners were for acceptance, but the Italians voted against it, as also many of the Mexicans, who are in a big majority. The committee of citizens, however, is still hopeful of settling the trouble, believing that the proposal was not thoroughly understood by the miners. We shall be glad to see this effort successful, for it will accomplish two worthy purposes: (1) to give the miners a share in the prosperity caused by 22-cent copper and (2) to help in eliminating an anarchistic organization that has done so much harm in the West and South-west.

MARANON PLACERS is a name familiar to our readers in association with an unsavory mining enterprise in Peru. In April 1914 the promoter, Mr. Raymond McCune, was arrested on the charge of using the mails to defraud the public by the sale of \$200,000 worth of stock in the scheme. A number of persons of high standing in Delaware had been lured by Mr. McCune's talk concerning his discovery of "the treasure-house of the Incas." The action taken by the Post-Office department to stop this imposition was most commend-

able, but its later efforts to secure evidence are not nearly so praiseworthy. An inspector, Mr. Harry A. Barber, was sent by the Post Office department to Peru to investigate McCune's alleged prospecting operations. This inspector was accompanied by two official companions, one of whom is versed in placer mining. Thus a considerable sum of public money was spent on what seems to us a wild goose chase, for, whether McCune sank few or many shafts, and whether he actually found gold at given spots or not, it is impossible to disprove it now, after a lapse of three or four years. If no gold were found by the investigating expedition, he could retort that they had examined the wrong spots. Moreover, most of the holes would now be filled up and overgrown. We consider the whole procedure foreign to the Department's duty in such matters. To stop the use of the mails for impudent circularizing and to warn the public is well within its functions, but if the Department is to undertake the examination of mines it should retain an engineer of high standing and act on his advice, which, in this case, would have prevented a fiasco.

COPPER is making new records. Just before Christmas the British Government signed a contract for the purchase of 135,000,000 pounds of copper in New York at 21 cents per pound, making \$28,350,000. This order is to be filled within the ensuing twelve months. We understand that the business was done mainly with the Anaconda Copper Company, although the American Smelting & Refining Company and the Tennessee Copper Company participated. On December 22 the total sales of copper are estimated to have reached 200,000,000 pounds, representing a gross value of over \$40,000,000, this being the record for a single day. The war demand for copper is estimated at 750,000,000 pounds per annum. That is in this country only, in the making of munitions for the Allies. Including the Germanic group, the present rate of consumption for use in the War is put at 1,200,000,000 pounds. This represents a little over one-half the total world production in 1913. The average annual consumption of copper in the United States during the five years from 1909 to 1913 inclusive was 365,000 tons. At the present time domestic production is about 900,000 tons. Allowing 400,000 tons for normal domestic requirements and 350,000 tons for normal export, we have an excess production at the present time of about 150,000 tons per annum. As the ordinary rate of increase in the world's consumption of copper is 7%, equal to 70,000 tons per annum, the present output is not so overwhelming. In 1907, when copper reached a price of 25 cents, the world's production increased only 18,619 tons over 1906, the average price in 1907 being 20 as against 19.2 cents per pound in 1906. For the last 15 years the average has been a little over 15 cents. During that period the world's production has increased from 486,500 to 1,100,000 short tons. On the whole, therefore, while the present price is decidedly high, it does not represent a figure so unreasonable as is feared by many mining operators. The main question is as to

the proportion of the war consumption that goes permanently out of use; in other words, how much of the copper in shells and cartridges is saved by the belligerents. If saved for future use, it will represent such an increase to the stock of metal as to endanger the market.

Antimony

The average price of antimony in 1913 was 8.73 cents per pound for Cookson's brand, in 1914 it was 10.73 cents, and the present quotation is nearly 40 cents. The War is responsible for this high price. In 1914 China produced 13,313 metric tons, France 5406 tons, and Hungary 859 tons. Large quantities of metal are now required in the making of ammunition and explosives. As the supply from France and Hungary is cut off, as well as the production in Mexico, that from China has to take care of an abnormal demand for war purposes, and the domestic needs of the United States. Imports into this country during a normal period, such as 1913, were 7667 tons of metal or regulus, also 25 tons in ore, and 50 tons in type metal. The production from domestic leady ores in that year was 2204 tons, from imported ore 304 tons, and from old alloys, scrap, etc., 2705 tons. No purely antimonial ores were mined in 1913, according to the U. S. Geological Survey, this being due to low prices and lack of railroad facilities to the mines. The Survey's bulletin on antimony for 1914 is not yet available. For several years the production in this country from domestic ores has been confined to that contained in antimonial lead and small quantities recovered in the electrolytic refining of copper and lead. The antimonial lead is mostly a by-product in the smelting of the precious metals. The high price has led to the search for, development of, and production of antimony from American deposits. At present the Alaskan (Fairbanks), Californian (Inyo and Kern), Idaho (Coeur d'Alene), and Nevada (Humboldt county), deposits are being exploited actively. Several mills are producing concentrate, and smelters are in operation at Los Angeles, San Francisco, and Seattle. The output of the United States in 1915 should show a big increase.

Little has been published on the metallurgy of antimony. The best work on the subject is that by Mr. C. Y. Wang, whose book, however, is a summary from French, Italian, and German publications and reports, as far as the metallurgical data are concerned. The description of the Herrenscheidt processes and appliances plays a disproportionate part in this interesting volume. Without going into details in regard to the claim set forward as to the sublimation treatment applied to antimony ores, it would appear from the facts that the first to obtain soluble oxide (Sb_2O_3) direct from the ores was Mr. Emmanuel Chatillon, of Brioude, in the Haute Loire, France. Prior to his invention or discovery, this product was obtained by subliming the metal and condensing the fume. In 1888 Mr. Chatillon patented his process in France under the title, *Pour un procédé de*

condensation des vapeurs métalliques,' and from that time forward the principal French and Italian smelters have adopted similar appliances for treating low-grade ores, running from 10 to 35%. This led to a long lawsuit between Mr. Chatillon and Giraud & Cie., Brioude, lasting from 1895 to 1900, when it was decided in favor of the former, but not until his patent had almost expired. In 1898 an Italian company erected a large sublimation plant in Tuscany; this is not described in Mr. Wang's book. He states that dry methods are generally adopted for the extraction of the metal, or of the metal in different combinations, while the proposals for the use of wet processes or of electro-metallurgical methods have not yet found practical application.

The different processes for treating antimony ores may be briefly described as follows: (1) Liqutation of rich ores, assaying 40 to 65%, in furnaces or pots for the production of crude antimony, the product being sulphide containing 71.4% antimony. (2) Direct smelting of high-grade stibnite and crude ore in furnaces or pots using iron as a desulphurizing agent, the product being antimony metal. (3) Sublimation process for the treatment of either sulphide or oxide ores, especially adapted to low-grade ores, yielding antimony oxide. (4) Reduction of oxide from the preceding process by smelting with fluxes and carbon, producing 'star' metal.

Crude metal is largely used in the making of fire-works, safety-matches, vulcanizing rubber, etc. Oxide of antimony is used for the manufacture of paints, enamels, in glass and crystal, and the preparation of antimony salts. Antimony metal is used for hard lead, type-metal, anti-friction compounds, and other alloys. It is sold as 'starred' metal, and the market not only demands a product assaying 99%, but also that each slab should have the fern-like crystallized surface known as the 'star,' although this does not indicate that it is chemically pure.

There are several furnace methods of reduction, that shown on the front cover of this issue of our paper being a part of the plant owned by the Chapman Smelting Company, in San Francisco, where smelting is being done by what is commonly called the English method. Here the furnaces and general working conditions are practically the same as those of Hallett & Fry, near London. The process comes under the second of those classified above, the different stages being: the melting of rich ore or crude in a crucible with fluxes and iron, the metal thus obtained being known as 'singles' and containing over 90% antimony, 7 to 8% iron, and 0.3 to 0.5% sulphur. It is poured into conical molds and the metal is detached from the slag—iron sulphide and silica—by hammering. Then four or more 'singles' are broken in pieces and melted in another crucible with a small addition of potash or soda. The metal from this second melt should only contain traces of iron and sulphur, less than 1%. Next the 'doubles' are broken and re-melted in a crucible together with antimony flux or antimony glass, known as 'toppings'; the metal is brought to a bright cherry-red heat and is poured into

square molds, care being taken to get enough of the 'toppings' to cover completely the surface of the molten metal and to prevent volatilization, forming the required 'star' under a gentle cooling action. With 30 fires this plant reduces 250 tons of ore yielding about 120 tons of 'star,' 99.5%, per month. Its capacity is limited by the amount of ore obtainable. More labor is required than is commonly supposed; when working full time 32 men are employed. The process is crude yet effective, and considerable physical strength and intelligence are required. Losses in reduction are high, more than in zinc smelting. Blast-furnaces are not satisfactory, and make larger losses. No. 60 plumbago crucibles are used, their life being 20 melts. Coke is the fuel, but oil is used in a new battery of furnaces for the first reduction, as the heat would cause too much loss in volatilization for the subsequent melts, namely, the 'doubling' and 'starring.' The maintenance of a proper temperature throughout the whole treatment plays an important part, as does also the manipulation, which requires skill and experience. On page 61 of this issue is a brief description of the treatment of antimony-gold ore by the caustic soda process, as now used in Rhodesia, and tried some time ago in Australia.

Antimony smelting in the United States has many disadvantages compared with the work done in China in respect to labor, freight, and other charges. It is only the sudden increase of price that has justified the revival of prospecting for antimony, but it is possible that before the War is over the improvement of facilities in regard to transport and reduction of the ores may lay the foundations of a new industry.

Testing for Flotation

In this issue and in the one immediately preceding we have been able to publish an article that must prove of immediate usefulness to a large number of readers. We refer to the detailed description of the apparatus for making flotation tests. For this the profession will, we are confident, be deeply grateful to the authors, Messrs. Oliver C. Ralston and Glenn L. Allen. The senior author, Mr. Ralston, has enriched our columns on several previous occasions. He is assistant metallurgist of the U. S. Bureau of Mines and has been assisting Mr. D. A. Lyon in making the Salt Lake station of the Bureau a centre of useful service to the mining industry. In this article the reader will find not only a detached and unprejudiced description of the various machines designed to ascertain the amenability of ores to the frothing process of flotation, but he will also find a discriminating analysis of the suitability of the individual machines for various experiments and a number of practical suggestions in regard to the manipulation of them. Indeed, we can hardly imagine any information more timely. The article is based on personal experience in the laboratory at Salt Lake City in the testing of a great diversity of ores from the surrounding region. It will be noted that in making such tests the experimenter

must not expect a high percentage of extraction and a high grade concentrate at the same time; in practice that final result is only attained by a repetition of the process in supplementary cells. The authors give the names of the makers of the several machines, with prices, and we have given supplementary information in two notes, realizing that many of our readers will be asking for such information as soon as they have been prompted, by reading the article, to make some tests on their own account. We hope they will. While the process has not the universality of application nor the comprehensiveness of scope that some of its more enthusiastic advocates may claim, it is yet certain that there are few mills in which it cannot play a useful part in one way or another.

Among the hints contained in the article we may draw attention to the convenience of separatory funnels in making preliminary tests, as well as the glass tube designed for testing oils, illustrated by Fig. 19. It will be gratifying to the novice to know that large-scale operations in flotation generally do better than the laboratory experiment indicates. But of all the suggestions proffered the one that impresses us most is the statement that a rational method of devising proper tests must be based on some theory of flotation. Of course. Any metallurgical work, to be productive of result, must be illuminated by sound theory, by a rational conception of the scientific principles involved. It is the absence of sound theory that has retarded the progress of flotation during the 30 years in which the use of oil for concentration has been known and it is the patenting of methods without knowledge of first principles that has produced a pestilential crop of litigation. So far, most of the work done in connection with flotation has proceeded by trial and error, by a crude empiricism unilluminated by scientific comprehension of the forces involved, by a succession of fortuitous discoveries the meaning of which has been obscured by the exigencies of litigation. We hope that the publication of this information concerning testing machines will be accompanied by such a study of essential principles as will yield a rich harvest of careful observation and logical theory. On that basis the practical application of the process can be extended confidently.

Last Year's Mining

The preliminary reports of the U. S. Geological Survey provide an excellent summary of mining conditions in 1915. Last week we reproduced the summaries dealing with Arizona, Colorado, Idaho, Montana, Nevada, New Mexico, and South Dakota; this week we give an abstract of the reports on California, Oregon, and Utah; and we reproduce, almost in full, the account of Alaskan mining. As a rule we care but little for last year's almanac, preferring to look forward, but the Director of the Survey should receive the thanks of the community for giving this interesting information promptly and therefore usefully. The record is superb. In the Western States alone the increased value of the metal pro-

duction is \$130,000,000 as compared with the previous year, and for the whole country the increment of output of the principal metals during the twelve months represents \$250,000,000. It is probable that complete statistics will show that 1915 was the most productive year in the mining industry of the United States, the total reaching \$2,500,000,000, which is a lordly sum even in these days of war finance. Copper mining, of course, has responded to the intensified demand and the higher price. In 1915 the output of this metal was worth \$236,000,000, which is an increase of \$83,000,000 over 1914. It is estimated that the production of blister and Lake during the year reached a total of 1,365,500,000 pounds, or 120,000,000 pounds in excess of the largest previous production. The increase over 1914 was 18%. All zinc records have been broken. The output from domestic ores was 425,000 tons, worth \$120,000,000 as compared with 313,118 tons, worth \$35,000,000, in 1914; thus the increase was 82,000 in tonnage, \$85,000,000 in value, and 25% in quantity. As regards the increase in lead, the figures are not so remarkable. The output of pig-lead from domestic ores was 515,000 tons, worth \$48,500,000, as compared with 512,794 tons, worth \$40,000,000, so that the increase in tonnage was only 2500, but the gain in value was \$8,500,000, equivalent to 20% more. Antimonial lead increased from 16,668 to 20,550 tons, the gain representing \$2,000,000. In regard to the precious metals, the Survey and the Mint join in estimating an increase of \$4,359,300 in gold, principally from Colorado, California, Alaska, Montana, and Idaho, while the silver production has advanced by 4,000,000 ounces, chiefly from Montana, Utah, and Arizona. The increase in the yield of gold brings the total to \$98,891,100, as compared with \$94,451,800 in 1914. Quicksilver also has seen its best year in 1915, the quantity produced increasing 25%, while the value of the output was more than doubled, owing to the price having averaged higher than at any time in the last 40 years. The estimate is 20,681 flasks of 75 pounds each, worth \$1,768,225. In value this is the best since 1881; in quantity it is the best since the year 1912.

In several states the past year was the best on record as regards metal mining. In Arizona, which is first in copper, even the 1913 record has been beaten. California is still at the head of the gold-producing states, with an output of \$23,005,800, which is the biggest in 45 years. Colorado comes second with \$22,191,200, Alaska third with \$16,626,700, and Nevada fourth with \$11,314,700. In Montana and Arizona the increased by-production of silver has been noteworthy, but Nevada is still the largest producer, with 13,793,000 ounces, as against Montana's output of 12,690,200 ounces and Utah's output of 11,168,500 ounces. Idaho produced 10,595,300 ounces of silver. In Alaska the intensified production of copper has joined with the yield of gold in making a year more prosperous than even the halcyon period of bonanza alluvial mining in 1906, when both Nome and Fairbanks were at their best. In fine, 1915 was a great year; and 1916 promises to be even better.



DISCUSSION

Our readers are invited to use this department for the discussion of technical and other matters pertaining to mining and metallurgy. The Editor welcomes the expression of views contrary to his own, believing that careful criticism is more valuable than casual compliment.

Who Owns a Report?

The Editor:

Sir—Your recent editorial on this subject brings forward a question of particular importance to the young engineer in the earlier stages of his professional work, and of great interest and practical significance to the older practitioner. Your request for a general discussion of the question shows a recognition on your part that "all opinions, properly so-called, are stages on the road to truth." In a young profession like ours, the code of ethics is still in the making, and I believe that a thorough discussion of it would be of general benefit. I therefore endorse your hope that there will be a wide response to your invitation.

The problem may be considered both from the legal and from the ethical standpoint. From the legal point of view the ownership of a report would probably be decided by a consideration of the customary practice, and of legal decisions, if such exist; but this phase of the question is better left to the lawyers or those in touch with the authorities, for while most of us think we know what our legal rights are, in many cases a close analysis of our ideas is apt to show them to be based, not so much on an actual knowledge of the law, as on the principles of fair play and justice. From the latter standpoint the question may be stated as follows: should a mining engineer communicate to one client, or use for his benefit, information obtained for and at the expense of another client; and what circumstances, if any, would justify a course of this kind? How far may a client insist on an engineer's secrecy concerning the report? In answering these questions it may be well to first consider the relationship between the engineer and his client.

The circumstances that usually bring the client into touch with the consulting engineer are that the one wishes special information and advice to guide him in the spending of money on a mining property, and the other is in a position to secure and furnish such guidance. An agreement is reached under which the engineer is to furnish the desired information for a money compensation. The relation is contractual, and an element vital to a contract is a mutual understanding between the parties to it; a distinct common intention as to the part each shall play in it. In order to reach a fair decision in the matter it is, therefore, of importance to examine further the mental attitude of the parties to the agreement.

To this end it is pertinent to inquire what the client

wants and what he expects to get when he retains an engineer to examine a mine. It may be assumed that he desires a written report containing a description of the property, an appraisal of its value, a statement concerning its probable future, and mention of any facts or conditions that may have a bearing on these subjects. Frequently he desires advice as to the purchase of the property at a particular price. It may further be assumed that he expects to secure the engineer's loyalty to his interests for as long a time as his exclusive knowledge of the property is reasonably of use to him. Also he may expect non-intercourse on the engineer's part with conflicting interests, inasfar as such intercourse might injure his business. He wants the examination and report for the purpose of furthering his pecuniary commitment.

The engineer, in accepting the commission, implies an agreement to furnish, to the best of his ability, the required information and advice as far as it is possible within the limitations of the time and expense allowed. Tacitly he agrees that the quality of his work shall be commensurate with the breadth of his experience.

Without speaking from a legal standpoint, we have in these mutual considerations all the elements that go to make up what is ordinarily meant by an agreement or a contract. One feature of the contract I would especially emphasize: that the client enters into it for the purpose of making money, and that he employs the engineer as a precautionary means of safeguarding his investment. Presumably the engineer is fully aware of this phase of the contract and agrees to it.

Since the report is for the purpose of promoting a matter of business, its value to the client is often dependent on his exclusive possession of its contents. Its confidential features are: first those that are private from their very nature and remain so for a long time, and second those that are private as long as they may affect the client's negotiations for the property, or the other business with which the report may be concerned. In my opinion the former class includes the terms of the proposed deal, the specific advice offered, and perhaps the report itself as a whole, or even the bare fact that a report has been made. All of these may be essentially concerned with the client's private business operations and are only to be given out at his pleasure. The latter class includes geological, metallurgical, statistical, or engineering facts; things that could be as well secured by other equally competent engineers for other clients. They need be regarded as confidential only as long as the

client retains sufficient control of the property to prevent others from searching for them. Possibly they have already become known to others through previous examinations, and are not so very private after all. The dropping of the business, as through the failure to exercise an option, would immediately make the same facts available to the next prospective buyer. What good reason would there be, in a case of this kind for an engineer to deny himself the patronage of a second client who wished him to report on the same mine? In most cases there would be none. But exceptional cases may exist: the engineer may not be informed on all the provisions of the deal; unknown to him there may have been provisions for the renewal of the option, such as would be affected in a way injurious to the client by the divulging of information, even after the expiration of the original option. Obviously, the client is in the better position to pass on this question, and the only way in which the engineer can be safe in letting down the bars of secrecy is to refer the question to him.

The limit of time, within which secrecy should be observed, decreases with the client's interest in the property in a business way. This variation may be judged by direct information from the client himself, by significant events, or by the passage of time. A definite statement from the client to the effect that the property is no longer of interest to him, or permission to make use of the original report for the benefit of a second client, would, of course, be sufficient. A request from a second party for an examination, or the intervention of a later option and examination by another engineer, would at least indicate the lapse of the original client's interest. Under certain circumstances, the spread of information concerning the mine might justify the engineer in considering himself to some extent released from secrecy. For instance, an engineer might be sent to report on a new strike of tungsten ore in a district where its existence had not previously been known to others than his client and the discoverer. In this case it might be of particular interest to the client that the nature of the ore, or even the fact that a deposit of any kind had been found, should be withheld; but certainly after the discovery had become common knowledge, there would be no breach of faith in the engineer speaking of it. Another circumstance that might tend to loosen the bonds of secrecy would be the further development of the mine to such an extent that, practically, it had become a new mine: the later disclosures being such that the earlier report had lost its significance. Still another situation in which the client could hardly claim the exclusive right to a report would be where the mine was first brought to his attention by the examining engineer, but where the option was not exercised. The engineer obviously would be privileged to mention it to another client, although the propriety of exhibiting the first client's report might be questioned.

To summarize the matter, the engineer, in making an examination, may wish to use data secured in making a previous report. His experience and general knowledge,

by which his client hopes to profit, were obtained largely in doing work of a confidential nature for others. Some important part of it may have been done in the same district, or perhaps in the same mine, where the examination is to be made; and under circumstances that make it of particular importance to the case in hand; and although of a confidential nature when it was done, perhaps the work might no longer be considered in that light. Possibly it was for these reasons that this particular engineer was chosen for the work. Now then—and here is an important point in my argument—if the client expects to profit by data resulting from the engineer's previous work, the confidential nature of which has lapsed, it seems that as a matter of justice, of common every-day fair-play, he thereby obligates himself to surrender similar information when his interest in it ceases. In deciding when such data are available for second use, the engineer must use tact and common-sense. Facts within his knowledge, or direct permission from the former client, will usually make these data honorably available. If such facts are lacking, and if the former client is thought to be unreasonable, it is best to submit to his wishes; and if the refusal appears to be due to 'pure cussedness,' to abstain from further relations with him. But it should be remembered that the client is in the better position to judge of how his own interest might be affected. It would be better to get along without such data than to be accused of using them to a client's detriment.

The engineer's standard of professional conduct should be high. He should be particularly careful not to permit the possession of valuable information to overshadow his knowledge of the former client's object in securing it. In doubtful cases the test should be, not the letter of the law alone, but that of fairness and regard for the client's interest.

What rules should guide an engineer, in the employ of a company, when writing about the technical details of the work he is doing, or has done, for his employer? I think the answer to this question should be governed by the same principles that control the reply to 'Who Owns a Report?' namely: those of fairness and regard for the employer's interest. There is this difference between the two situations; that where a client depends for protection on the consulting engineer's honesty, and where he would be practically at the mercy of an unscrupulous engineer, with doubtful means of redress in case of a breach of faith; an employer has a much more effective means of enforcing his will over the engineer on his staff. But aside from this phase of the question, no engineer of good judgment should be tactless enough to publish, without his employer's consent, an article that might be considered as bearing on the company's business affairs. Even where the article consisted of a description of technical methods as applied in the company's operations, the product of the engineer's own brain, it would at least be in good taste to first submit it for the employer's approval. I think this would be, in most cases, largely a matter of form, as the engineer

should be able to gauge fairly accurately the limits beyond which he might not go. On the other hand, since most men are reasonable if properly approached, I think it will be only in exceptional cases that the publication of articles on purely technical operations will be denied. A broad-minded employer will surely sympathize with the engineer's desire for such recognition from his fellow engineers as may be secured from writing on technical matters; and, if he gives the matter sufficient thought, will perceive that he, through the medium of the engineer's reading, is receiving the benefit of the technical experience of others. Here, again, we have run the question down to the principle that a fair exchange is no robbery.

J. A. BURGESS.

Wonder, Nevada, December 14, 1915.

The Alaska Gold Mines

The Editor:

Sir—In your editorial on the Alaska Gold Mines, in the issue of November 20, you estimate that it will take 18 years to return the capital invested, provided that $5\frac{1}{2}\%$ is set aside for that purpose annually. And in a recent editorial in the *Engineering and Mining Journal* (one of your contemporaries) it is stated that "A mine with a delimited orebody figured upon as lasting 20 years ought to pay about $9\frac{1}{2}\%$ gross in order to afford 6% net." As the valuation of these shares has been so much discussed it seems as if an examination of the question from an actuarial standpoint may be of interest.

You evidently arrive at the term of 18 years for redemption of capital at the rate of $5\frac{1}{2}\%$ annually by dividing 100 by $5\frac{1}{2}$, which gives practically 18; however, you have neglected to take into account the fact that the shareholder who applies a portion of his dividend to redeeming, or amortizing, his capital does not put the money received in his safe-deposit box, but invests it in other securities. At present he can safely invest these sums in Government bonds to net nearly $5\frac{1}{2}\%$, and at this rate it will require but 13 years to recoup his capital instead of the 18 of your estimate.

The fact, however, that it will only take 13 years to repay the capital does not interfere with your conclusion that the price of \$40 per share seems unreasonably high. Not enough information has been given to allow of an exact valuation of the shares, but the maximum statement of resources seems to be that made by the management that the mines will last for a generation and will produce 8000 tons daily at a profit of 75 cents per ton. The buyer of the shares at \$40 is paying at the rate of \$30,000,000 for the property (750,000 shares) and if 2,800,000 tons are worked yearly the annual profit will be \$2,100,000, or 7% on the \$30,000,000. Taking the life of the mine at 30 years and the rate on the sinking-fund for redemption of capital at 4% (to be on the safe side) it works out that the shareholder will receive about 5.25% for his investment, an entirely inadequate return for capital invested, or, speaking more accurately, used for speculating in gold mines. On the

basis suggested by you that the shareholder ought to have 10% net on his money, the value of the shares works out at about \$24. In view of the fact that a large horse of barren material has cut the profits to 45 cents per ton it would seem as if the price of \$24 per share was fully high enough.

Although these problems of valuation of shares are fully understood by most engineers, yet they are not treated with any great detail in the ordinary engineer's pocket-book. The most complete set of tables for a reasonable price is to be found in Hurst's 'Architectural Surveyor's Handbook,' published by Spon & Co., London. This is often bound with Molesworth's 'Pocket Book of Engineering Formulae.' One of the most recent books on the subject is 'The Mathematical Theory of Investment,' by E. B. Skinner, published by Ginn & Co., at \$2.25. On pages 160-163 is found an article on the valuation of mining properties, the general problem being stated as follows: "To find the value of a mine when the rate to be received by the investor differs from the rate at which the redemption fund can be accumulated." The formula for this is:

$$V_n = \frac{R}{\frac{1}{S_n} + i'}$$

where V_n = value of the mine; R = the net annual income; i' the rate of interest the shareholder expects on his investment; i the rate at which the dividends can be re-invested; n , the time to elapse before the mine is exhausted. S_n denotes the amount of an annuity of \$1 per annum, payable annually for n years, at the rate i .

JOHN WORDEN.

Salt Lake City, December 10.

Colorado-Gilpin Gold and Radium

The Editor:

Sir—Noting publication in your Mining Summary columns of December 18 of the notice of organization of the Colorado-Gilpin Gold & Radium Mining Co., in which I am named as consulting engineer, I desire to say that I am not connected with this company and that my name has been used without authority.

Further, I take occasion to disclaim any connection with or responsibility for the prospectus of this company, issued from 1005 Drexel building, Philadelphia. Also, for my own part and on the part of others, I wish to protest against the use in this prospectus of letters bearing no dates and published in such a way that they are calculated to give a false impression of their real significance.

FORBES RICKARD.

Denver, December 30, 1915.

MONTANA has an area of 146,080 square miles, which is over twice that of Missouri. Its population is less than half a million, which is smaller than that of Rhode Island, a territory of less than one-hundredth the size. Montana's output of metals in 1915 was \$87,000,000.

Scheelite Mining and Grading

By P. B. McDonald

THE Atolia district in southern California, near the line between San Bernardino and Kern counties, has become an important producer of scheelite. Both lode and placer mining are in progress, and lessees are active in many operations of small scale but high profits. Prices of over a dollar per pound for concentrate of 60% WO_3 have stimulated the prospecting and mining of tungsten ores to an unusual degree. But the occurrence of scheelite in California is not confined to the Atolia district.

In the Union Hill gold mine at Grass Valley some scheelite is found associated with the quartz veins, and several shipments of picked ore have been made to a buyer in Colorado, the Wolf Tongue Mining Co. at Nederland in Boulder county, and to Atkins, Kroll & Co. of San Francisco. A. D. Cox, the mine superintendent, has noted that the scheelite is found where the quartz veins traverse a wide sedimentary series of black slate, quartzite, and intermediate phases. The accompanying sketch shows the four narrow veins cutting amphibolite schist at surface, in which no scheelite is noted; but in the 500-ft. thickness of sedimentaries where the presence of lime may be a factor in the formation of the tungstate of lime, scheelite appears likely to be found liberally. It is not known whether or not there is scheelite in the altered diabase below the sedimentaries, as the mine-workings have not yet reached that depth. It was at first thought that the scheelite would only be found bordering the lenses of quartz, particularly where the vein changed in width. However, later developments in the lowest vein, called the Georgia, have not confirmed this idea, as the scheelite there is found in various parts of the vein.

Mr. Cox's method of grading the scheelite for shipment to the buyer is as follows: The scheelite ore is dried, cobbled, and picked. As is usual with most scheelite ores, what is apparently pure scheelite will be seen, if examined closely, to contain minute stringers of quartz. The specific gravity of chemically pure scheelite containing 80.5% of WO_3 is 6, that of quartz about 2½. The specific gravity of a piece of apparently pure scheelite was determined by test and found to be 5.42, showing the presence of a small amount of quartz as an impurity.

By proportioning the specific gravities of scheelite and quartz, it was computed that 'pure' scheelite, as found in this mine, contains 84% scheelite and 16% quartz, which means an estimated amount of 67.6% of WO_3 . Continuing this computation, it was determined that ore that looked to be ¾ (by volume) of 'apparent' scheelite, as judged by the man sorting it, contains 58% of WO_3 ; that ½ 'apparent' scheelite contains 46% of WO_3 ; that

¼ 'apparent' scheelite contains 35% of WO_3 ; that ¼ 'apparent' scheelite contains 28% of tungstic acid. These figures seem high, but the apparent discrepancy is due to the high specific gravity of scheelite as compared with that of quartz, it being remembered that the sorting is done by volume.

In the first lot that was shipped, the mine estimate of its No. 1 grade as averaging 65% of WO_3 checked closely with the analysis of the buyer, which was 65.4%. The second grade, which was judged at the mine to be 50% of WO_3 , proved to be 45.7%. The third grade, estimated at the mine at 25% of WO_3 , ran 26.2%. In the sorting for shipment at the Union Hill mine the No. 1 grade is usually made up of apparently pure scheelite; the No. 2

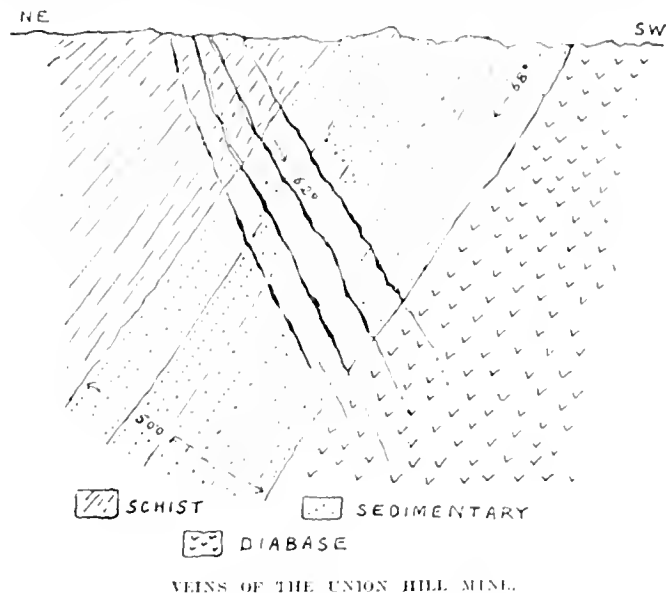

grade embraces the picked ore between apparently pure scheelite and ½ apparent scheelite by volume. The proportions of the No. 2 grade would thus lie between 46 and 67.6% WO_3 ; the final percentage is adjudged after looking it over carefully and would be probably nearer to 46 than to 67.6%, rather than the numerical average, because there is usually more ore slightly above 46% than there is slightly below 67.6%. The No. 3 grade is between ¼ and ½ apparent scheelite judged by volume. The usual grades shipped are: 1st, 65%; 2nd, 50%; 3rd, 25%.

Mr. Cox's figures on specific gravities and volumes are as follows:

With ¾ apparent scheelite by weight, the other ¼ assumed to be quartz:

$$0.75 \times 5.42 \text{ (sp. gr. apparent scheelite)} \dots\dots = 4.06$$

$$0.25 \times 2.5 \text{ (sp. gr. quartz)} \dots\dots\dots = 0.63$$

$$\text{Specific gravity of specimen} \dots\dots\dots = 4.69$$

Proportion of apparent scheelite by weight... = $\frac{4.06}{4.69} = 87\%$
 Proportion of $WO_3 = 0.87 \times 0.676$ (percentage
 of WO_3 in apparent scheelite)..... = 58.8%

With $\frac{2}{3}$ apparent scheelite by volume (other $\frac{1}{3}$ assumed
 to be quartz) :

0.67×5.42 = 3.63
 0.33×2.50 = 0.82

Sp. gr. specimen = 4.45

Proportion apparent scheelite by weight..... = 81.5%
 Proportion WO_3 in specimen = 0.815×0.676 = 55.1%

With $\frac{1}{2}$ apparent scheelite by volume, etc. :

0.5×5.42 = 2.71
 0.5×2.50 = 1.25

Sp. gr. specimen = 3.96

Proportion apparent scheelite by weight..... = 68.3%
 Proportion WO_3 in specimen = 0.683×0.676 = 46.2%
 With $\frac{1}{3}$ apparent scheelite the proportion of WO_3 = 35%
 With $\frac{1}{4}$ apparent scheelite the proportion of WO_3 = 28%
 With $\frac{1}{5}$ apparent scheelite the proportion of WO_3 = 24%
 With $\frac{1}{6}$ apparent scheelite the proportion of WO_3 = 20.8%
 With $\frac{1}{8}$ apparent scheelite the proportion of WO_3 = 16%

Phosphorus, sulphur, and arsenic, although not of consequence in the Union Hill ore, are deleterious impurities in the scheelite because harmful to the steel to which the tungsten is added; one buyer of scheelite imposes a penalty on more than 5% of these elements. The occurrence of scheelite in gold ore raises a question as to the line at which the tungsten becomes more valuable than the gold. If the ore is treated for its gold content, the scheelite slimes so readily, on account of its friability, that it becomes difficult to separate. The most practicable way seems to be to pick the high-grade scheelite and grade it by hand methods. A fine intimate mixture of scheelite and other heavy minerals is difficult to separate; fortunately scheelite is usually found in particles of $\frac{1}{4}$ inch, or over, while the accompanying pyrite is generally less than $\frac{1}{16}$ inch. Cases where scheelite occurs with gold are increasing; they include besides the Union Hill mine, the Wasp No. 2 mine of South Dakota, the Suan Concession in Korea, and several gold mines in New Zealand.

SAFETY IN USING EXPLOSIVES. In a discussion of the above subject at a meeting of the Chemical, Metallurgical, and Mining Society of South Africa, the points of importance considered by eight members were as follows:

Fractional re-blasting of cut, saliva in detonators, placing the detonator well down the charge, crimping the fuse causing misfires, electric blasting, tearing off paper at ends of cartridge, slitting cartridge longitudinally, frozen explosives, use of cheap fuse of irregular burning speed, deterioration of fuse on storage, rate of burning speed of fuse, tying of fuse with detonator to primer cartridge, primer cartridge at bottom of charge with water tamping, Nowag clip, No. 6 and 8 detonators, weak detonators, damp detonators, saw-dust in detonators, working ends of detonators pointing wrong way, stacking of cases of explosives, excessive coiling of fuse,

copper-sheathed tamping-rods, quality of fuse, natives firing holes, cut-out shots, and lig-dyn primers.

Flotation at Humboldt, Arizona

*The flotation process has been introduced into the mill of the Consolidated Arizona Smelting Co., at Humboldt, Arizona, with such success as to increase the concentration of copper 20% above the best work done previously with jigs, tables, and vanners. The ore treated in this mill consists of pyrite and chalcopyrite in a gangue of quartz and schist. Starting with a 3% copper ore, a table concentrate assaying 7% and a table tailing assaying 2.1% are obtained. This table-tailing becomes the flotation-feed, which, after treatment, yields a 14% concentrate and a 0.3% tailing. In September 1915 the mill treated 7173 tons of 2.65% copper ore for a recovery of 90.9% of the copper, 68% of the gold, and 72% of the silver. The ore contains 0.03 oz. gold and 1.3 oz. silver per ton. The ratio of concentration in the mill as a whole was 4:1 and in the flotation department $7\frac{1}{2}$:1. By the old method—with jigs, tables, and vanners—the recovery of copper was only 70%.

The friable copper mineral made a slime that eluded water concentration but is readily amenable to flotation. About 60% of the flotation product is finer than 200 mesh. Wilfley tables are used now only for the rough work, the flotation machines being responsible for the major part of the recovery. The Minerals Separation apparatus is used. Acid is not employed. Nor is the temperature of the pulp raised.

When oxidized ore finds its way to the mill, the extraction suffers. Decomposition products such as iron oxide and magnesium carbonate 'kill' the froth in the flotation-cell.

The total cost of concentration, including coarse crushing and flotation royalty, is slightly over \$1 per ton. In September it was \$1.03. Exclusive of royalty, the cost of the flotation part of the treatment has been 27 cents per ton during a period of six months. The cost for oil is 2.8c. per pound, on a consumption of a little less than one pound of oil per ton of crude ore. The power consumed by the flotation machine is 32.7 kw. per 24 hours. The improvements made in the metallurgical treatment are due to G. M. Colvocoresses, the general manager, and J. N. D. Gray, the mill superintendent.

ECUADOR has an area of 116,000 square miles, being larger than Arizona, and a population of 1,500,000, which is six times that of Arizona. Quito, the capital, situated practically on the Equator, has 60,000 people. Three railroad companies operate, with a total of 360 miles of track. Guayaquil is the leading port of that section of the coast.

*A précis of an article appearing in *Metallurgical & Chemical Engineering*, December 1, 1915.

The Relation of Employer and Employee

By John P. Irish

THE relations of employer and employee have undergone great changes, affecting both classes. Before organized labor was known the workman of exceptional skill and industry commanded not only steady employment, but a premium on his skill, in the form of higher wages than were paid to the less skillful and less industrious. This acted as an incentive to all ambitious workmen to acquire skill in their trade and apply themselves to it with industry. In that time the American mechanic ranked high and advanced rapidly to a position of independence. It was our patriotic boast that a President of the United States had been a tailor, and that U. S. Senators who left a great work in the history of this republic had started in life as skilled cabinet makers, coopers, and harness makers.

All that is so far past that it is forgotten. The labor union system permits no premium on special skill, and it checks industry by limitation of output. Ambition is not merely smothered. It is discredited. Workmen no longer depend upon their skill and quality for employment, but upon the power of the union. They are commanded to work or to cease by the walking delegate or the business agent. The employer is no longer permitted to pick his employees from the members of a union. The business agent does that for him, and orders whom he pleases to work and whom to lie idle. That this power is liable to abuse goes without saying, since the power to favor some members by detailing them to jobs includes the power of the business agent to get a rake-off from the wages of his favorites.

There is no logical nor economic objection to the union organization of labor. The objection runs against its use of power. The unions are extra-legal bodies. They refuse to incorporate and so incur legal obligations, and the right to sue and be sued in civil actions. But they impose fines upon their members and collect them under penalty in denial to the delinquent of the right to work, which is a denial of the right to live, since nature endowed man with wants upon which his life depends and which can be satisfied only by the labor of his hands. Thus denial of his right to work is a sentence to death or dishonesty. This is a power that the State cannot exercise. The government of the United States cannot deny to the weakest of its citizens the right to live by his labor.

The exercise of that power by labor unions, extra legal bodies, with no standing in the courts, and no right to sue or liability to be sued in a civil action, is one of the most alarming manifestations of irresponsible power that the mind can conceive.

One of the avowed principles of labor unions is the right of collective bargaining. The individual workman

no longer makes his contract with the employer for wages, hours, and conditions of labor. The contract is made for him by the business agent or other authority of the union. Now a contract, to be just, must be bi-lateral, equal in the responsibility of both its parties for its enforcement and observance. But a contract between a labor union and an employer cannot be enforced by the employer against the union, for the union is a legally irresponsible body. But the union can enforce the contract against the employer, if not by damages against his property in the courts of equity, by calling a strike, putting him under boycott, picketing his property, denying to his customers the right to trade with him, and throwing him into bankruptcy and ruin.

The history of these affairs shows that these things have been done when the employer has not violated any part of the contract, but because he has violated some "union rule" that was not part of the contract and of which he knew nothing.

The public has become accustomed and callous to these things. The courts, under terror of the recall, are cowardly or indifferent to their duty to protect the rights of property and under these circumstances the employer finds himself the powerless victim of union power and vengeance in matters not involved in contract, and which do not concern wages, hours, or conditions of labor.

The streets of Oakland for months have been incumbered by union pickets, sporting a red sash and marching in front of boycotted business houses, and for what reason?

The statement of one case answers for all. A large confectionery store and ice-cream parlor on Broadway is owned and operated by a widow. She has had the same teamsters in her employ for years, paying them the union scale and more. But they were non-union men, and the business agent of the union demanded that they join. They stubbornly refused. Then the business agent demanded of their employer that she make them join or discharge them. She replied that they were free to join or refuse, and she would not discharge them in either event. Therefore the union put her place under boycott and picket, and has in every way annoyed and threatened her customers and injured her business.

Now can you imagine a more defiant and impudent denial of the common right of men than that? Can you imagine a more brutal impairment of the rights of employer and employee alike? Can you imagine anything more repugnant to American citizens, to a lover of liberty, to a believer in our system of government?

Yet it goes on unchecked by the courts, permitted by the municipal government, which asks employers for support, while denying to them the protection of their rights for which they pay taxes. And yet there is no question of hours or wages involved; none of those things called by the unions "the rights of labor."

Surely it is time that the business men of the country organize and demand that labor unions accept legal civil liability or be treated as organizations injurious to the State, and forbidden by law.

*An address before the Oakland branch of the Merchants and Manufacturers' Association.

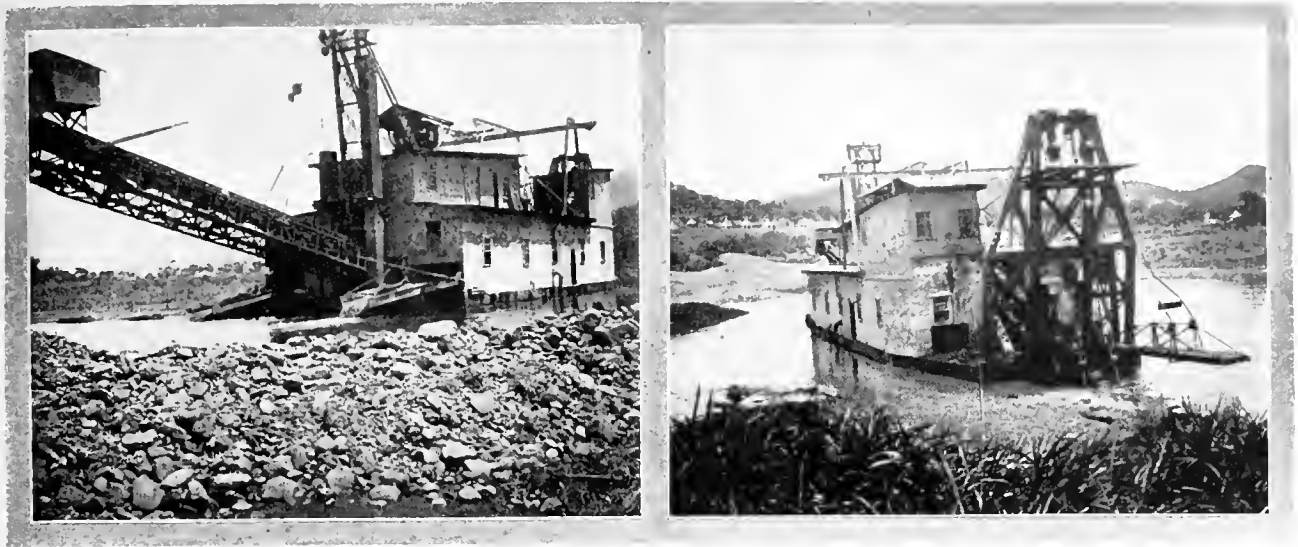

TWO VIEWS OF THE ALPHA DREDGE OF THE ANDRADA MINES, LTD.

Dredging in Mozambique

THE general manager for the Andrada Mines, Ltd., L. C. de la Malière, has communicated to us the results of the first year's work of the dredge *Alpha*, which is working in the Mozambique territory (Portuguese-East Africa), near the Rhodesian border.

After a trial, the dredge was set to work on February 10, 1914; from then to December 31, 1914, it worked out a surface of 19½ hectares or approximately 48 acres, digging a depth of 14 ft. 8 inches. During this period it treated 1,149,798 cubic yards, yielding gold worth 11,076,239 francs,* equivalent to 18.6 cents per cubic yard. The expenses, including all the general charges, in Mozambique, at Paris, and London were 545,090 francs, excluding amortization. The cost therefore was equivalent to 9.4 cents per cubic yard. The dredge worked 5407 hours, being stopped for repairs during 1912 hours, and for lack of power during 483 hours, equivalent to 2395 hours of lost time. This total is distributed as follows:

| | |
|--|----|
| | % |
| For repairs and improvements | 39 |
| For lack of power | 27 |
| For boulders | 20 |
| For moving the dredge and stepping ahead | 14 |

The average working-time per day, counting the loss from lack of power, was 16 hr. 40 minutes. The yardage treated per month averaged 100,000. This was unsatisfactory and was due to shortage of power, caused by the dry season, which lasts nearly three months. The company has erected an auxiliary Diesel oil-engine plant to remedy this defect.

The average expenses per month have been:

| | | | |
|----------------|---------|-----------------------|--------------------|
| | Francs. | | Francs. |
| White men | 13,400 | Realizing gold | 1,000 |
| Natives | 1,600 | Sundries | 1,400 |
| | 15,000 | General expense | 14,000 |
| Material | 12,500 | | |
| Power | 5,500 | Total | \$10,000 or 49,400 |

*A franc may be taken at 20 cents U. S.

As this one dredge had to bear all the general expenses, the cost is very high, for it includes all the expenditure in prospecting, to prepare ground for additional dredges.

| | |
|--------------------------|-----------------------------|
| | Per month. |
| 1 Dredge-master | \$200 to 250 |
| 3 Winch-men (each) | 175 to 200 |
| 3 Oilers (each) | 150 |
| 1 Fitter | 200 |
| 1 Blacksmith | 175 |
| 1 Shore-man | 125 |
| 40 Natives..... | 25 to 75c. per day and food |

An average of 3 Americans has been employed, their board being paid by the company. The two features of this dredging operation are:

1. The blasting of the boulders in the buckets, 5625 blastings in 11 months 20 days.
2. The swinging of the boat in a pond about 1000 ft. wide, sometimes 1200 ft. This wide pond helps to render the monthly outputs less irregular, especially in patchy ground. Wear and tear of the principal parts of the dredge was distributed as follows:

Notwithstanding about 8000 blastings, the buckets have not been changed until August 1915, after 19 months work. The lips could serve two months more, 50% of the hoods were cracked or pierced, the bottoms and eyes were in very good shape and will serve for another 18 months, with new lips and hoods.

- Pins have lasted 18 months.
- Bushings have lasted 9 months.
- Screen-plates have lasted 18 months.
- Conveyor-belts have lasted 10 months.
- Wire cables have lasted 8 months.

The cast-iron idlers, for the conveyor-belt, were all broken in a month's time, on account of boulders. They are now made of cast-steel and resist much better. During the first six months in 1915, the output has been 673,256 francs for a treatment of 781,253 cu. yd., that is, an average of \$22,441 per month for 130,209 cu. yd. excavated.

Testing Ores for the Flotation Process — II

By O. C. Ralston and Glenn L. Allen

SEPARATORY FUNNELS. During the past year an article on practice in Mexico mentioned the fact that much of the preliminary testing on the ore was done in separatory funnels, in which the charges of pulp, oil, etc., were shaken, after which the cock at the bottom of the funnel was opened and the tailing run into a second separatory funnel for further flotation tests, the cock being closed in time to catch the froth. The versatility of experiment permissible with the use of such apparatus (Fig. 13) is commendable. Obviously, this arrangement is open to the same objections as is the slide machine except that separatory funnels are simple and inexpensive.

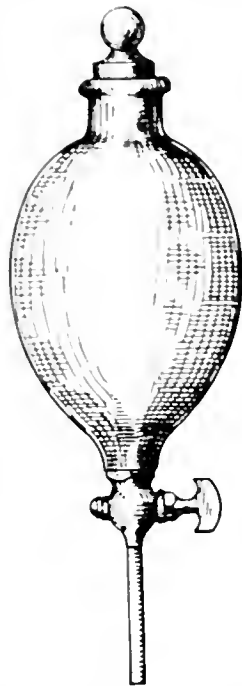

FIG. 13. SEPARATORY FUNNEL

ELMORE MACHINE. As far as we know, no small test-machine for the Elmore process has come into common use on account of the fact that the pulp must be lifted through a tube corresponding in length to the column of water equivalent to barometric pressure. This makes an awkward laboratory machine. Mr. Hoover (2nd edition, page 98) describes "illustrative" experiments with the pulp in a bottle connected with a water-pump for producing a vacuum, but no quantitative method of this kind has been developed.

Other miscellaneous frothing tests are in the literature but most of them are merely "illustrative." Putting a charge into a soda-water siphon, pumping in air to dissolve the water, and then releasing the charge into a beaker gives nice-looking froth. In some of the lawsuits

square glass candy-jars (Fig. 14) with a motor-driven impeller have been used to show flotation phenomena in court. In a recent U. S. Patent (No. 1,155,836) taken out by T. M. Owen, one of the engineers of the Minerals Separation Co., is a sketch of a simple test-machine made of an ordinary 2½-litre acid-bottle. (See Fig. 14A).

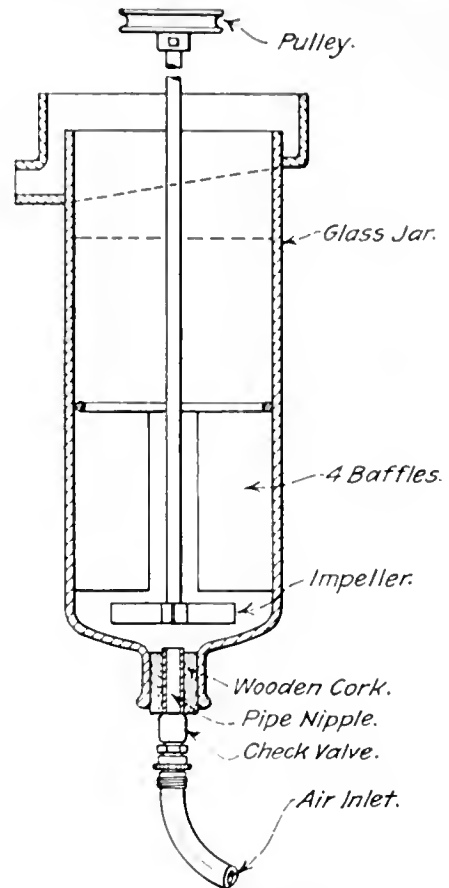

FIG. 14A. OWEN TEST-MACHINE.

This corresponds to the sub-aeration type of machine and is recommended by Mr. Owen for test-work when such a type of machine seems necessary, as in differential flotation. Air is led into the pulp through the stopper in the bottom and beaten into the pulp by the impeller. The four large baffles above the impeller prevent the swirling of the pulp from rising through them, so that there is a quiet zone in the top of the machine where the froth can collect. One great beauty of such a machine is that any froth formed will rise immediately to the discharge. However, we believe that the Janney and Hoover machines are the most useful of the mechanically-agitated type.

PNEUMATIC FLOTATION. Among the different pneumatic machines, as far as we are acquainted, the Callow test-machine is the only one of laboratory size that has

been much developed. It is merely the commercial Cal-low machine reduced in size (see Fig. 15, 16, and 17). Later development in the laboratory of the General Engineering Co., in Salt Lake City, has resulted in the reproduction of the whole plant in miniature (see Fig. 17 and 17a), with Pachuca mixer, roughing-cell, cleaning-cell, vacuum-filter, and sand-pump to return middling to the Pachuca mixer. As seen in the drawing, the

such an installation, as there are a number of things to be kept in operation at the same time. The mixture of ore, water, oil, and any other reagents is fed either into

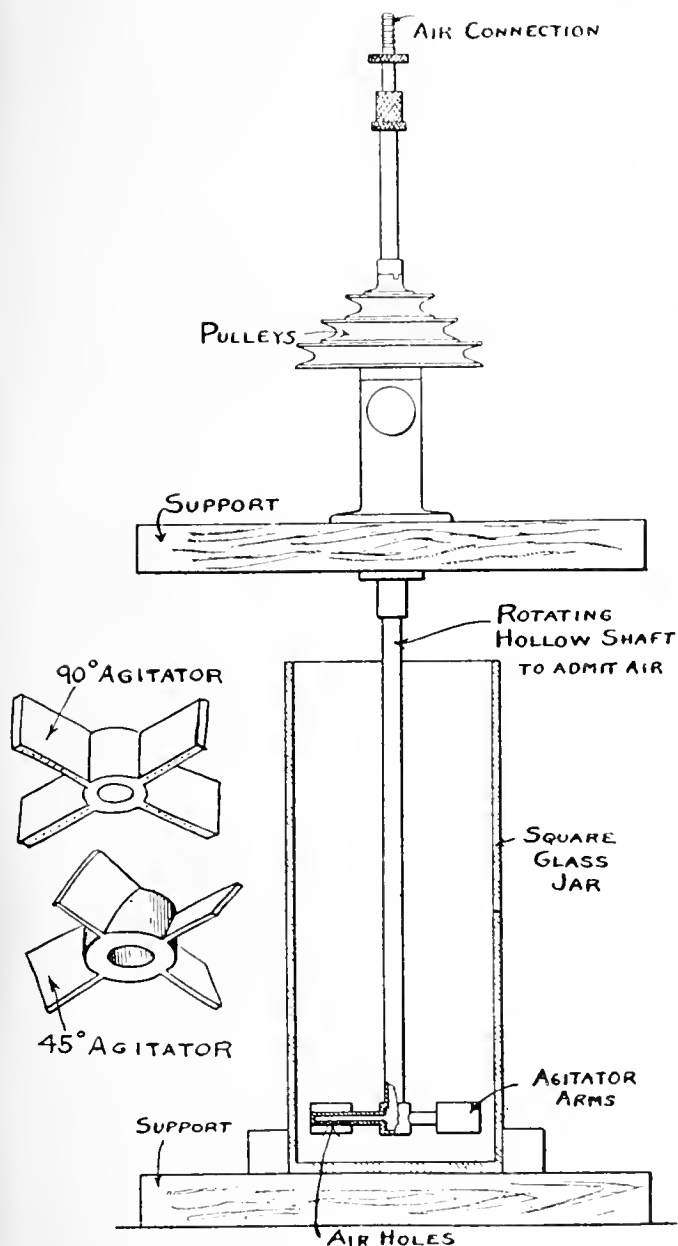

FIG. 14. THE SQUARE GLASS JAR MACHINE.

pulp is mixed well in a Pachuca tank of small size, overflowing into the rougher flotation-cell. The tailing from this rougher goes to a sand-pump and is returned to the Pachuca. The froth is treated in a second and smaller pneumatic-flotation unit, giving a concentrate that overflows into an ordinary laboratory vacuum-filter actuated by a water or aspirating pump. The tailing from the 'cleaner-cell' consists of a middling that likewise flows to the sand-pump and back to the Pachuca.

A novice will have no small difficulty in operating

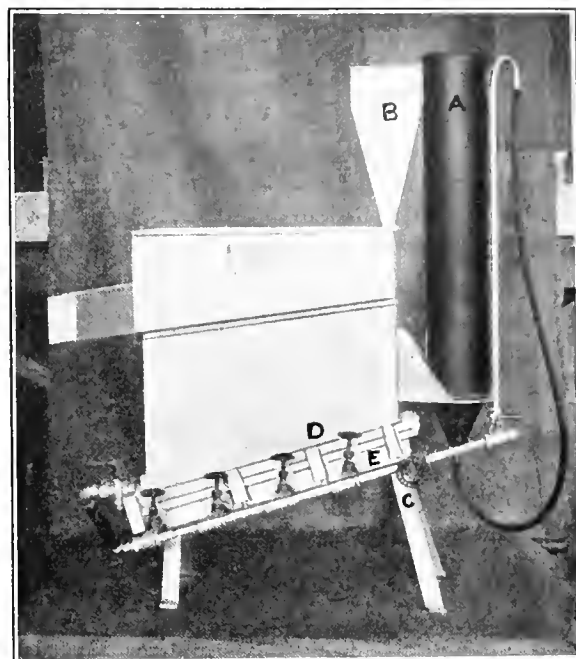

FIG. 17. CALLOW TESTING-MACHINE WITH PACHUCA MIXER.

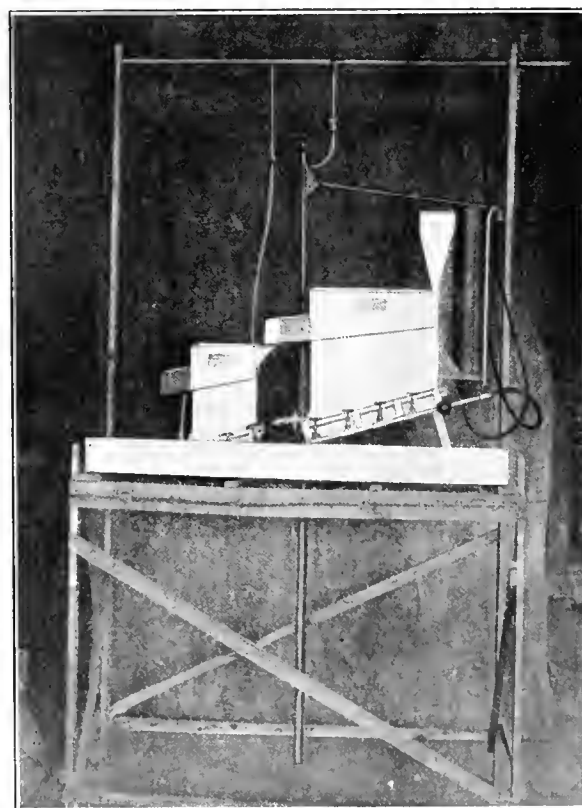

FIG. 17A. CALLOW ROUGHER AND CLEANER IN MINIATURE.

the suction of the sand-pump or into the top of the Pachuca after air has been started into the various machines. The overflow from the Pachuca into the rougher-cell accumulates until a nice froth is coming up and nearly overflowing. Then the tailing-discharge valve on

the rougher is gradually opened and froth allowed to overflow from the cell into the 'cleaner' cell. It is best to get most of the charge circulating before much concentrate froth is allowed to overflow, the overflow of froth being controlled by the main air-valves leading to each unit. After the valves into the individual wind-boxes beneath the machine have been once adjusted they should never be disturbed, and all control of air supplied should be at the valves in the main pipes. When everything is going well, the air pressure in the cleaner can be increased until concentrate-froth is overflowing into the vacuum-filter. A wooden paddle to stir any settled material in the flotation cells is of value, as well as a small jet of water from a rubber hose for washing concentrate along the froth-launder and for beating down froth when occasional too-violent rushes of froth from the cells take place. After a test is complete the pulp should be drained completely from all parts of the machine while the air is still blowing, so that solids will not settle in passages or clog the canvas blanket in the cells. Only practice will allow anyone to get reliable results with this machine. A watch-glass for catching and panning occasional samples of froth is another necessary auxiliary to this equipment. The cost of installing such a set of apparatus is from \$100 to \$150. At least 1000 grams of ore is required for a test and about 30 minutes to 1 hour is spent. It can be seen that nothing but a finished concentrate and a tailing are obtained. The machine is said to give results closely paralleling those obtained with larger-scale apparatus. A source of supply of compressed air at 3 to 5 lb. per sq. in. is necessary and the main valves on the air-pipe leading to each machine should be some type of needle-valve in order to ensure exact control.

LABORATORY MANIPULATIONS. Turning from the description of the machines used to the operations on the ore before and after the flotation operation, we have in general the problems of crushing the ore and of drying the froth-concentrate.

As a rule laboratory machinery for the pulverization of ore is of the dry-grinding type, with the exception of small ball-mills that can crush from 1 to 100 lb. charges in the wet. Consequently, most people start with weighed charges of finely-ground dry ore, a known quantity of water, of oil, and of acid or alkali. Our experience has been that most dry-ground ore must be treated in an acidified pulp to get good flotation. Doubtless the surfaces of sulphide particles become somewhat oxidized in, or shortly after, dry grinding and the function of the acid would be to clean the slightly oxidized surfaces. Wet grinding usually does not call for so much acid. In nearly all laboratory work finer grinding than is used in practice seems to be necessary. This may possibly be due to the smaller amounts of froth that are formed. Such small quantities of froth cannot form layers as deep as those made in the large machines. If a big particle of sulphide can be entrained with a number of smaller particles, it can be floated, but with a thin froth the chance of such entrainment would seem to be less. Some

experimenters have informed us that they were able to float even as large as 30 mesh material, but our own experience is that 60-mesh material is often hard to float with any chance of getting a high extraction, while the operation is performed with much more ease and expedition when the ore is crushed somewhat finer.

Wet grinding is more desirable, as it parallels conditions in practice, where most of the finer grinding of ore is in Chilean, tube, and other mills. However, wet grinding is harder to manipulate in a small laboratory and requires more time. The dry weight of the feed to the flotation machine must be known; hence a weighed charge of dry ore crushed to about 10-mesh can be introduced into a porcelain or iron pebble-mill for grinding and ground for the length of time found necessary to reduce the pulp to sufficient fineness—15 minutes to 24 hours. The charge can then be poured and washed through a coarse screen (to retain the pebbles) into a bucket and thence into the flotation machine. The oxidation of sulphide surfaces is thus avoided, but separate grinding of each charge, in order to know its exact weight, is rather tedious and requires a number of small mills if many tests are being run, on account of slow speed in grinding. A mill with iron balls rather than pebbles is of greater service. It is possible to introduce the flotation-oil before grinding, to be sure that it will be thoroughly mixed. For thick viscous oils this is highly beneficial, as a ball-mill gives about the best conditions for agitation and mixing. Usually 1 to 2 lb. charges are used and a small laboratory mill of the Abbe type serves well, although a good mill can be made with a 10-inch length of 8-in. iron pipe and two heavy iron caps for the same.

Practice in our laboratory has been standardized to a laboratory-gyratory crushing to 10-mesh, splitting into weighed samples kept in paper bags and reduced to smaller size by either wet or dry grinding as occasion demands.

A short-stemmed tin funnel about 6 inches in diameter with a one-inch opening is found to be about the most convenient means of pouring a charge of ore into a laboratory flotation-machine.

The measuring and testing of flotation-oils in the laboratory has been very inexact in many instances witnessed by us. It is common practice to count the number of drops of oil falling from a small piece of glass tubing. We are using a Mohr pipette of 1 c.c. total capacity for measurement of the amount of oil used in each test. Such a pipette is shown in full size in Fig. 18. It will be seen that this pipette allows measurement of the oil to the nearest 0.01 c.c., which is as close as will ever be desired. If the density of the oil is known, the volume as measured by this method is quickly converted into the weight of oil used.

The testing of oil samples for flotative power is a matter that needs standardizing. It is desirable to classify oils according to flotative power, but just how to do this is not exactly clear. A unit of 'flotativeness' might be established and each oil referred to that unit

in terms of percentage. But it has to be remembered that the best oil for one ore may not prove to be the best oil for another, although two such series of oils might roughly parallel each other. For any given ore, it would be permissible to make such a measurement on a series of oils and group them according to some definite standard. A standard oil might be chosen and the value of a second oil expressed in percentages of the flotative power of the first as determined by using equal quantities of the two oils in tests on an ore under identical conditions. This

Coutts gives about the only directions on oil testing that are to be found in the literature of the subject⁶. He states rightly that the first thing to do with an oil is

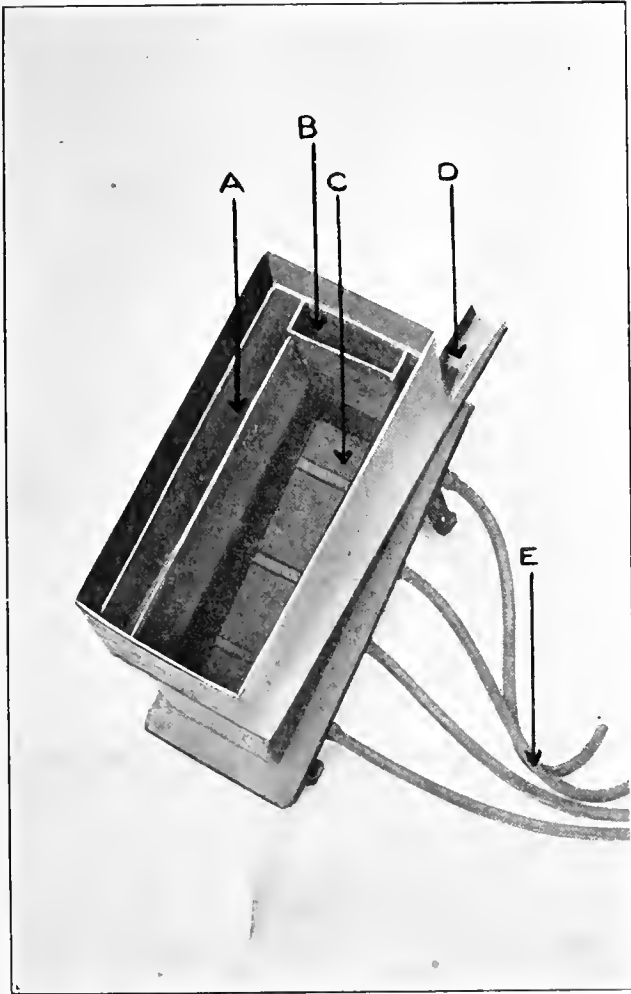

FIG. 15. THE CALLOW CELL.

test could not be fair for the reason that different amounts of two different oils are necessary to accomplish the same results. Further, the conditions of acidity or alkalinity might favor one oil and handicap another. If we measured the amount of oil necessary to give a fixed percentage of extraction the first of the above objections would be satisfied but conditions of acidity or alkalinity could make the test unfair for some oils. Hence the dilemma as to a standardized test of a flotation-oil.

No single test could definitely place an oil in any scheme of classification and nothing can be done but run a series of tests using varying amounts of the oil to be tested and with varying acidity or alkalinity. The temperature of the pulp must be kept constant although it has a minor effect.

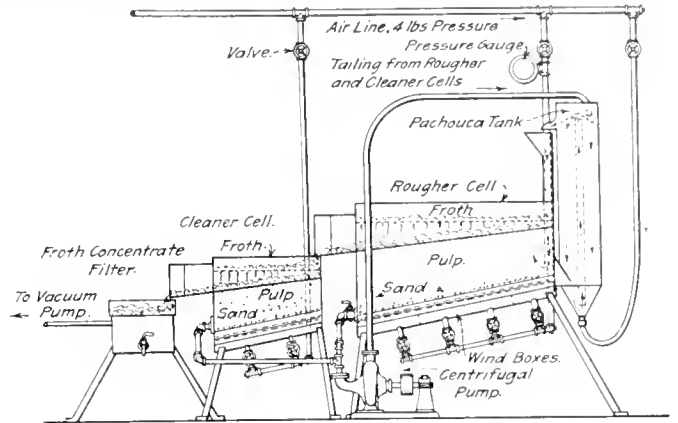

FIG. 16. CALLOW TEST SET.

to measure its density, for future calculations, as it will be measured by volume in the laboratory and must later be reduced to weights. He recommends the use of a burette for measuring the oil, but we favor the Mohr pipette mentioned above. He chooses a standard ore on which all tests are to be run and classifies three different kinds of standard tests: (1) for mixed sulphides, (2) differential separation, and (3) flotation of copper and iron sulphides. He states that oils high in phlanderene have proved best for differential separation of zinc-lead sulphide ores. While this is helpful, he does not state just how the oils are to be classified after the tests have been made.

Much work with oils is needed in order to determine if there are any definite constituents in oils that give them flotation power. Research is also needed in the preparation of oils from the wood, coal, and mineral oils in such a manner that they will have maximum efficiency in flotation. Work on this subject has been initiated in our own laboratory and it

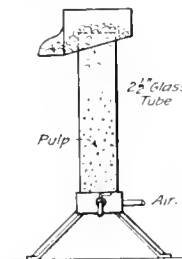

FIG. 19. CALLOW QUALITATIVE TESTER.

is known that several of the larger companies have employed oil chemists to look into such problems. We understand that most excellent work is being done on methods of modifying and reconstructing oils that can be had cheaply. By this we mean



FIG. 18. MOHR'S PIPETTE.

more than mere mixing of a good flotation oil with a cheaper non-selective oil. Sulphonating the oils, dissolving them in acids, dissolving modifying substances in the oils, etc., are some of the ideas being tested with varying success. It is on account of all this oil testing

⁶J. Coutts. E. & M. J., Vol. XCIX, page 1079 (1915).

that considerable progress has been made in flotation during the past year, so that now most of the larger companies are using cheaper oils than they were a year ago.

When starting to work with a new ore, there is needed a rapid qualitative method of choosing an oil that seems well adapted to the flotation of the ore in question. Such a scheme is in use in the laboratory of the General Engineering Company in Salt Lake City. Their qualitative tester is designed to test oils for use in the Callow pneumatic flotation cell and consists of a glass tube of about two inches diameter and two feet long. (Fig. 19). This can be set on end and closed at the bottom with a one-hole rubber stopper through which passes a glass tube into a small canvas bag. The small bubbles of air coming through the canvas are similar to those used in large-scale machines and can be observed through the glass walls of the tube. With some pulp in the tube, oils, acids, salts, etc., may be added in very short tests until the proper appearance is obtained. An overflow lip is provided in case it is desired to examine the mineral in the froth. A slight adjustment of the air will provide an ample overflow of froth.

DISPOSAL OF THE FROTH. The handling of the flotation froth in the laboratory finds difficulties which are reflected in practice. It is often very slow to settle and filters with difficulty. A vacuum-filter, connected with a laboratory aspirating pump, is a very convenient method of getting the concentrate out of the froth. A large porcelain Buchner funnel fitted into a filtering flask, as shown in Fig. 7, is used at present in our laboratory. A copper vacuum-filter of much the same type, provided with a porous false bottom of acid-proof wire cloth, resting on a punched plate, is shown in Fig. 17 of the Callow test set. Filter-papers can be laid over the bottom of either of these funnels to collect the concentrates and the vacuum beneath sucks out the water and oil of the froth. Such a filter can be placed under the froth-discharge of a flotation machine so that a fairly dry cake of concentrate is ready for further drying at the end of the flotation test. By loosening the outer rim of the filter-paper and then turning the funnel upside down over a pan, the filter-paper with the concentrate can be dropped into the drying-pan by gently blowing in to the stem of the funnel. This is set aside in a warm place to dry and later weighed against a filter-paper tare.

If it is desired, the froth can be collected in a glass beaker or other vessel and allowed to stand over-night. A layer of clear water can then be siphoned off and the thick pulp remaining filtered or dried direct. In some laboratories the froth is dumped onto a shallow pan on a hot plate and the water evaporated. Occasionally such a sample of froth will be left too long, and will be ignited and roasted. We once used a numbered set of shallow pans for such evaporations but prefer filtering before drying the precipitate. A numbered tag is now put in each pan along with the cake.

The products coming from the flotation machine should be watched closely and occasionally panned or examined

with the microscope to see what kind of work is being done. This is fairly easy to determine as the sulphides are most of them distinguished easily from the gangue under the microscope, and likewise gangue particles in the froth concentrate can often be distinguished. A microscope is a most useful adjunct in a flotation laboratory or mill.

GENERAL CONSIDERATIONS. We have mentioned at various places the relation of the laboratory tests to the large-scale operations and now repeat that in almost every instance the laboratory results are somewhat pessimistic as compared to large-scale work. The reasons are made apparent by the smallness of the machine and the shallower layer of froth often formed under these conditions. Moreover, laboratory operations seem to call for greater amounts of oil, acid, etc., than do the large-scale operations.

Only one of the above machines is adapted to 'roughing' and 'cleaning' operations in a single test. Present-day practice tends toward re-treatment of at least part of the froth in order to make cleaner and higher-grade concentrates. Consequently, it may be desirable to collect enough froth from a series of tests to be re-treated in a 'cleaning' test. Of course, this is provided for in the Callow test set, where only 'cleaned' concentrate is discharged from the machine. It is further found desirable to weigh and analyze some of the successive fractions of the froth being discharged from a flotation machine, as the tailing becomes leaner, and determine at what point it may be desirable to re-treat such froth.

Many reports of flotation test-work with mechanical-agitation machines give the speed of the rotation of the agitating-blades. We have found that it was possible to get much the same work done with quite a variation of speeds, the only effect being to lengthen or shorten the time of treatment. We feel that the importance of this matter has been much exaggerated. Some means of speed-control is necessary and the speed can be adjusted in each case until the froth presents the proper appearance as to depth, size of bubbles, color, etc. Speeding toward the end of a test in order to give a deeper froth with a faint line of concentrate on the very top is often advisable. We recommend adjusting the speed in each test to suit the other conditions, rather than running a series of tests with different speeds. Only in the slide machine, where operation of the impeller must be suspended in order to allow froth to collect, is the speed of much importance. Here we recommend agitation for a definite length of time, and then a period of settling. The effect of variation of speed during a definite length of time may be a considerable variation in the amount of froth collected during the quiet period. Hence we are prejudiced against the use of the slide machine except for oil-testing.

When a good set of conditions has been found for the flotation treatment of an ore, it is best to recover the water from each test to see what effect a closed circuit of the mill-water will have. Some oil and chemicals are thus recovered, cutting down the amounts necessary for

operation. In fact, a carboy or two of the water to be used in the large mill should be used to make certain that no deleterious contamination will ensue from this source. Under these conditions filtration of the concentrate and tailing for recovery of the water is necessary. Such conditions are provided for in the Callow apparatus, above described, and can be applied easily to any of the other machines.

Oil samples for test purposes can be obtained from the various wood-distilling companies now advertising in the

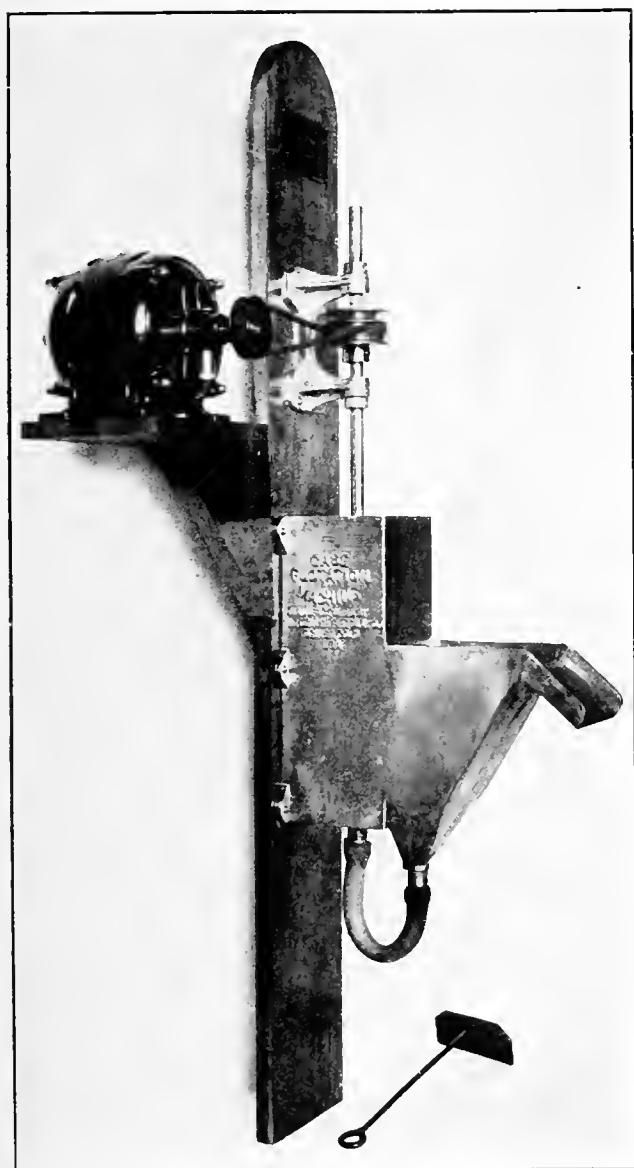

FIG. 20. THE CASE MACHINE.

technical press, from gas companies and from petroleum-refining companies.

In attacking refractory ores, there are a number of ingenious things that can be done to the pulp both in and out of the machine. The trouble may be due to deleterious substances, which sometimes can be washed out, rendered harmless by boiling, or by acidifying, or by making alkaline with lime before entering the machine. Occasionally, the ore will not work well under ordinary conditions but will yield beautifully after finer grinding.

Sometimes extra reagents are necessary, such as powdered charcoal, modified oil, argol, soap, calcium sulphate, alum, etc. A rational method of devising the proper tests in such cases must be based on some theory of flotation. Colloid chemistry is a branch of knowledge that we believe to be very necessary for such work, as it has facilitated a more intelligent control of our tests and has given wonderful results in a number of instances.

Finally, it is well to be prodigal in the amount of analytical work connected with flotation testing in order to discover interesting differences in gangue-constituents carried into the concentrate, as well as to find the best conditions for leaving out some gangue constituent that is less desirable than the rest. If an experimenter does his own analytical work he can be expected to spend three-fourths of his time analyzing what has been done during the other fourth.

Summarizing the most important points to be tested on a given ore with any given flotation machine, we have:

Method of grinding.

Fineness of grinding.

Kind of frothing agent used.

Amount of frothing agent.

Acidity or alkalinity.

Temperature.

Necessity of preliminary agitation.

Effect of addition-agents in flocculating gangue-slime.

It can be seen that there may be a certain best combination of the above variables that will be entirely missed if a great many tests are not carried out; hence the desirability of doing the testing in a small laboratory-machine where many trials can be made in a short time.

After the best conditions have seemingly been established, they should be further tried in a larger-sized machine before they are incorporated into the general practice of a mill. The test-work on this scale need hardly be described, as, for the most part, it is a question of translation of laboratory results into large-scale operation.

[We have added an illustration of the Case machine, evidently a modified Hoover apparatus, made by the Denver Fire Clay Co.—EDITOR.]

SECONDARY COPPER. As contrasted with lead and zinc, the uses for which copper is principally employed are such that a large percentage of the metal can be eventually recovered and returned to the trade. According to J. P. Dunlop, of the U. S. Geological Survey, "the production of copper from secondary sources in 1913 was equal to about 17% of the refinery output of primary copper in the United States from all sources, or about 22.4% of the primary copper smelted from domestic ores." It is difficult to determine the amount of secondary copper, but apparently 200,000,000 lb. is recovered annually in the United States from material that has been actually used and scrapped. Copper probably shows less depreciation from corrosion, disintegration, burning, abrasive action, etc., than any other metal.

Treatment of Molybdenite Ore in Australia

NEW SOUTH WALES and Queensland are the world's principal sources of molybdenite, and as an embargo has been placed on its export to foreign countries, and as there is a good demand combined with high prices—now \$1.50 per pound for 90% product—diligent search is being made for deposits in the United States, while in Arizona and Colorado some ore is extracted. In the Press of February 6, 1915, molybdenum was discussed editorially.

The geological department of the New South Wales Department of Mines is preparing a report on molybdenite mining and treatment, and in an advance note one of the staff, E. C. Andrews, makes the following remarks:

Methods in this State are more or less crude even at present, and consist, in the main, of crushing and screening dry. Experiments in water and oil flotation are being carried out in various places in the State, but no large quantities have yet been treated by such processes.

METHODS. (1) Small deposits containing molybdenite flakes of moderate size in quartz. The ore is crushed either by means of bucking-hammers or by hand-rolls. The larger flakes are hand-picked, while the smaller flakes are saved by hand-sieving, the undersize being mainly of the nature of quartz grains.

2 Large deposits such as at Kingsgate, containing molybdenite and bismuth in a clean gangue of quartz or silicious granite.

The following description is of one of the several plants at Kingsgate, 20 miles east of Glen Innes. The capacity is about 5 tons per day, and the cost of the plant erected was about \$5000. Two men and a boy are employed. Ore with an average content of 3% bismuth and molybdenite is hand-fed from a plant to a No. 2 Dodge rock-breaker, and there crushed to pieces about 1-in. diameter. From the crusher the ore passes through two sets of rollers, each set having screens to save the large flakes of molybdenite as over-size. This product is re-rolled to further reduce the quartz. Underneath the second pair of rolls is a shaking-screen. The holes in this shaking-screen are about 1 1/2-in. diameter. The under-size passes onto a Wilfley table to save the bismuth, the tailing being stored pending probable improvements in treatment, such as some form of oil concentration.

The over-size from the 1 1/2-in. screen is carried to a third set of rolls, where it is crushed to 1/20-in. gauge and screened. Much of the over-size from this process is cleaned by hand-sieving. The first part of the over-size, however, is re-crushed in rolls set close together, and passed over screens of 1/32-in. mesh. The over-size from this varies from 92 to 95% molybdenite. The under-size is a product rich in molybdenite, but considerably below the required 90% standard.

Some method of water or oil concentration for saving the molybdenite, after treatment of the crushed ore on a

table for recovery of the bismuth, is obviously the proper method of treating this ore.

The most satisfactory method known of saving molybdenite up to the present is that practised at Irvinebank in north Queensland.

Some small plants have been made in New South Wales with the idea of concentrating molybdenite ores wet. These, however, have not treated large quantities so far. Of these the plant erected by M. Charles Poulot at Sheehy's wharf, Greenwich, Sydney, presents some interesting features: The ore, after fine-crushing, is pumped to the top of the building into a de-watering tank. Thence the water returns to the pump, while the ore drops into a small centrifugal pump situated below the de-waterer. The centrifugal mixes the pulp with oil fed from a tank by drops. From taps, this oiled mixture is dropped into horizontal shaking-troughs pierced with holes and discharging into boxes filled with water. The molybdenite floats, and is discharged into launders leading by tubes to a screen of 180-mesh, and then dried. The boxes are arranged in four tiers vertically above each other. As soon as a certain amount of pulp has been treated in the upper tier, taps are opened in these boxes and the material, which has sunk to the bottom is led into the horizontal shaking-troughs attached to the second tier, and the whole process is repeated; similarly for No. 3 and 4 tiers of boxes. The process is thus a four-fold one.

[American mining men will be interested to know that at Denver, Colorado, H. E. Wood has a plant for the treatment of molybdenite ores, in which film-flotation is used.—EDITOR.]

Flotation-Tests in Separating Funnel

EFFECT OF ALKALINITY.

100 grams of 200-mesh mill-heads, assaying Au. 0.17, Ag. 29.53, frothed 6 times in 400 cc. mill-water, with 0.44 lb. S. S. oil and 0.44 lb. cresylic acid per ton of ore, at a temperature of 80°.

| Test No. | Lime lb. per ton | | | —Concentrate-Assay— | | | —Tailing-Assay— | | |
|----------|------------------|---------|---------|---------------------|------|-------|-----------------|------|------|
| | At start. | At end. | | Gm. | Au | Ag | Au. | Ag. | Acid |
| 1. | 0.08 | 0.02 | Acid | 17.562 | 0.16 | 99.9 | 0.12 | 16.1 | Acid |
| 2. | 0.01 | | Neutral | 15.859 | 0.60 | 110.6 | 0.10 | 12.4 | " |
| 3. | 0.15 | | " | 15.250 | 0.82 | 181.6 | 0.06 | 5.1 | " |
| 4. | 0.25 | 0.01 | Alk. | 13.470 | 1.00 | 192.1 | 0.06 | 4.1 | " |
| 5. | 0.24 | 0.02 | " | 11.20 | 0.85 | 184.2 | 0.06 | 3.8 | " |
| 6. | 0.43 | 0.04 | " | 15.05 | 1.00 | 166.4 | 0.06 | 4.9 | " |
| 7. | 0.70 | 0.12 | " | 26.95 | 0.52 | 89.2 | 0.03 | 6.1 | " |
| 8. | 1.00 | 0.25 | " | 31.55 | 0.31 | 69.3 | 0.09 | 12.9 | " |

In separatory-funnel tests, assays of concentrate are much lower than in plant-practice. Tailing-assays are practically the same.

When frothing in mill-water, the best alkalinity, both as regards extraction and grade of concentrate, is from 0.01 to 0.02 lb. per ton of water.

THE U. S. ASSAY OFFICE in New York, for the first time in 18 years, has more gold on hand than it has room for; the overflow has been taken to the sub-treasury vault; the total recently was \$235,000,000.

Mining in Alaska in 1915

Advance Statement by U. S. Geological Survey, Compiled by Alfred H. Brooks

GENERAL. The Alaska mining industry as a whole was more prosperous in 1915 than in any previous year. This is indicated by the value of the total mineral output, which is estimated to have been \$32,000,000, compared with \$19,064,963 for 1914. The highest value for any previous year was in 1906, when Alaska produced \$23,378,428 worth of minerals, but this was at a time when the bonanza placers of Fairbanks and Nome were yielding their greatest returns.

The high value of the mineral output in 1915 was due in large measure to the extraordinary amount of copper that was mined. Preliminary estimates indicate this to be 83,850,000 pounds, valued at \$14,400,000. In 1914 21,450,628 lb. of copper was mined, valued at \$2,852,934. The gold production also increased in 1915, when the value was about \$16,900,000, against \$15,626,813 for the output of 1914. This is the largest gold production since 1912, when the output was valued at \$17,145,951. As the production of silver is incidental to gold and copper mining, this also increased. It is estimated that \$400,000 worth of silver was mined in 1915, against \$218,327 worth in 1914.

The output of other minerals, including tin, antimony, marble, gypsum, coal, and petroleum, in 1915 had a value of about \$300,000, compared with \$222,802 in 1914.

In addition to the productive mining a large amount of dead-work was accomplished during 1915 on properties that made no output. Therefore the abnormally large value of the total mineral production must not be considered as simply a temporary expansion of the mining industry, due to the high price of copper. The developments made during the year give assurance of continued large operations in both copper and gold-lode mining. Placer mining has been less prosperous, for this industry has not yet reacted to the stimulus of the Government railway, which will make available for profitable exploitation large bodies of low-grade gravel. The same is true of the coal-mining industry, which also must await railway transportation.

The first gold mining in Alaska was done in 1880, and since that time gold to the value of about \$261,050,000 has been produced. Of this about \$186,200,000 has been won from placers. Copper mining began in 1901, and the total copper output of Alaska is now about 217,250,000 lb., valued at \$34,150,000. The value of the total silver production to date is about \$2,650,000. Coal, petroleum, tin, lead, quicksilver, antimony, marble, gypsum, and other minerals have been produced to the value of about \$2,150,000. Therefore, the value of the total mineral production during 36 years of mining in Alaska has been \$300,000,000.

GOLD PLACER MINING. The data in hand indicate that the value of placer gold produced in 1915 was \$10,500,000, compared with \$10,730,000 in 1914. This decrease of output, if borne out by the final figures, is chargeable to the falling off in the output of some of the Yukon camps. On the other hand, the developments in the Tolovana district, where gold was discovered in the

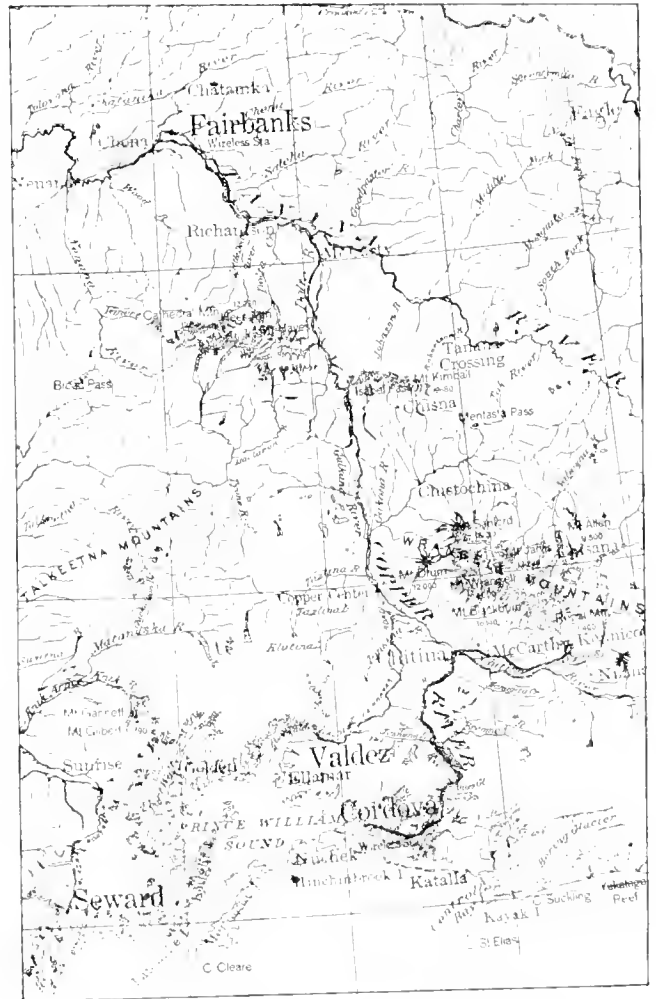

PART OF CENTRAL AND SOUTH-EASTERN ALASKA.

autumn of 1914, indicate that this will become of some importance.

About 42 dredges were operated in Alaska during 1915, the same number as in 1914. From the information at hand it appears, however, that the value of the gold recovered by dredges was less than \$2,000,000 in 1915, compared with \$2,350,000 in 1914. This decrease is chargeable to the Seward Peninsula districts, where about 37 of the dredges are at work. There can be no question that this decrease of dredge output is but a temporary check to the industry as a whole and is due to

certain local conditions. Several new dredges will be operated in 1916.

GOLD LODE MINING. About 23 gold-love mines were operated on a productive basis in 1915, compared with 28 in 1914. On the other hand, the value of their output has increased from \$1,863,928 in 1914 to about \$6,200,000 in 1915. This increase is to be credited to the Junesau district, where large developments were continued throughout the year. There can be no question that the gold-love output will increase at a rapid rate. This will be due not only to large-scale operations in southeastern Alaska, but also to the encouragement given to lode mining by the railway under construction from Seward to Fairbanks.

COPPER. The tremendous increase in copper output during 1915 has already been noted. Nearly four times as much copper was produced as in the previous year, and the value was nearly five times as much. The copper was taken from 11 mines, of which seven were in the Ketchikan district, four on Prince William Sound, and three in the Chitina district. Though the high price of copper led to the re-opening of some of the smaller mines in the Coast region, yet it should be noted that the increased output was possible only because of the large developments that have been under way for several years. The advance of the Alaska copper-mining industry during the year may therefore be said to have been a normal development of the industry. It is of course true, however, that if it had not been for the high price of the metal, the output would have been considerably less. It augurs well for the future of the industry that the Alaska copper mines are now sufficiently developed to produce so large a tonnage.

TIN. It is estimated that about 200 tons of stream-tin was produced in Alaska during 1915. Much the larger part of the tin came from the York district of Seward Peninsula. Here one dredge was operated throughout the season on Buck creek. A new dredge was installed on the same creek during the summer and operated for a part of the season. No returns have yet been received from the two dredges operated in 1914 on the Anikovik river, in the same district. These two are working on placers carrying both tin and gold. Developments were continued on the Lost River lode-tin mine, and there was also some prospecting of other lode-tin deposits. There was, however, no production of lode-tin.

The only other tin mining in Alaska during 1915 was done in the Hot Springs district of the lower Tanana basin. Here considerable tin is recovered incidental to gold-placer mining.

ANTIMONY. The high price of antimony in 1915 led to the mining of over 800 tons of stibnite ore in Alaska. Nearly 700 tons of this output came from the Fairbanks district, and the rest from Seward Peninsula. It is difficult to obtain any exact valuation of the stibnite ore shipped from Alaska. The evidence in hand indicates that the producer received from \$1.25 to \$1.75 per unit of stibnite. It is reasonable to estimate that the

Alaska shipments sold for \$85 per ton in San Francisco. This indicates a value of about \$70,000 for the total shipments made in 1915.

Four antimony properties were operated in the Fairbanks district during 1915: the Scrafford, in the Treasure Creek basin; the Stibnite, in the Eva Creek basin; the Gibner, in the Vault Creek basin; and the Chatham Creek mine. All the operations were on a small scale. The mining consisted chiefly of making open-cuts and digging out the ore, which occurs in shoots, kidneys, and irregular masses along zones of fissuring. Most of the ore was broken and hand-sorted, and no ore of less than 50% antimony was shipped. The average content of the ore was probably 58%. Considerable prospecting was also done on a number of other stibnite lodes in the Fairbanks district.

The ore was hauled to the railway by wagons and then sent by rail to Fairbanks and over the all-water route to San Francisco. The transportation companies offered a low freight rate to encourage the new industry.

Developments were continued on the Slisovitch mine, in the Nome district. The ore from this property carries some gold, and the mine has been worked for gold. In 1915, however, the energies of the operators were directed toward getting out stibnite ore. Some stibnite was also mined at the Hed & Strand property, a few miles north of the Slisovitch mine. The total ore shipped from Nome is reported to be 132 tons, but there is reason to believe that a considerably greater quantity was mined.

Stibnite is not an uncommon mineral in Alaska. The recent demand for antimony has led to the prospecting of a number of stibnite deposits within the Territory. Such work is reported in the Kantishna district, on Prince William Sound, and on Kenai Peninsula.

Here follows a review by districts.

SOUTHEASTERN ALASKA. About 12 gold-love mines and 4 copper mines were operated in southeastern Alaska during 1915. Preliminary estimates indicate that the gold production of this region, including the output of the placer mines in the Poreupine district, had a value of about \$5,500,000. The estimated copper production from this field, all of which came from the Ketchikan district, was 4,500,000 lb., valued at about \$800,000.

The Rush & Brown was the only copper mine operated in the Ketchikan district throughout the year. Operations were resumed at the H. Mamie, and Mount Andrew mines in the spring and continued on a large scale for the rest of the year. Work was resumed on the Jumbo mine early in summer, and the mine was again put on a productive basis. Some ore was shipped from the Goodro and Cymru mines, and developments continued on the Big Harbor and on other properties. The Ready Bullion, Dutton, and Valparaiso gold-quartz mines were operated, and some output was also made from the Gold Standard, Googoo, and Snowdrift claims. Marble quarrying continued in the Ketchikan district, as in previous years.

Considerable work was done on both copper and silver-

lead properties in the Wrangell district. Some shipments of barite were made from a deposit near Wrangell.

In the Juneau district the four mines of the Treadwell group were operated on the same scale as last year. An accident to the central hoist curtailed the output for several weeks during the summer. The construction of 30 additional stamps to the Ready Bullion mill is under way. A mill having a daily capacity of about 6000 tons was completed in February at the Alaska-Gastineau mine and operated for the rest of the year. Power is furnished by a hydro-electric plant on Salmon creek. Another plant, the Annex power project, is under construction on

Juneau and at the Enterprise, on Limestone Inlet, south of Juneau.

In the Berners Bay region the Jualin mine was productive during the year, and the installation of a new power-house was nearly completed. Hydro-electric power is to be used, supplemented by an oil-burning plant. A group of claims, including the old Kensington, Bear, and Comet mines, in the Berners Bay region, has been consolidated, and the installation of equipment was begun.

The old Funter's Bay mine, on Admiralty island, has been re-opened and was operated on a productive basis in

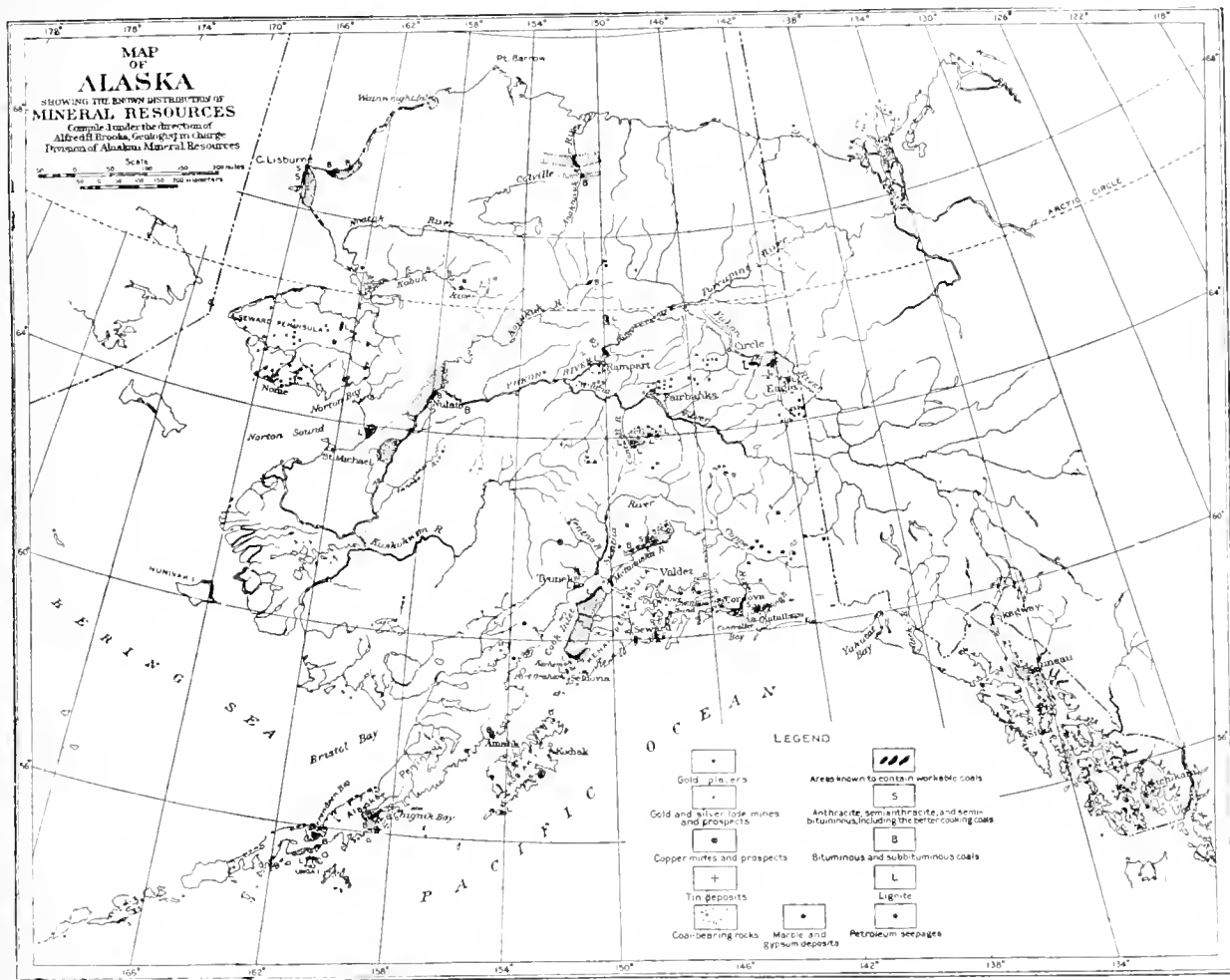

Taku Arm. The mill of the Alaska-Juneau was operated during the year. The construction of a larger mill—a part of the original plan for the equipment of this property—has been begun. This mill includes four units, each having a daily capacity of 2000 tons. Hydro-electric power is to be used, supplemented by an oil-burning plant. Developments were continued on the properties of the Alaska Gold Belt, Alaska Taku, and Alaska Treasure mining companies, all of which are near Juneau.

The Eagle River mine was operated during the year, and a little productive mining was also done on the Peterson properties. Developments were continued on the Yankee and Montana and other properties north of

1915. The plant of the Chicagof mine, in the Sitka district, was enlarged and the mine was operated throughout the year. Gypsum mining continued at Iyoukeen Cove, on Chicagof island.

Three hydraulic plants were operated in the Porcupine placer district. In the Yakataga district beach mining continued and one hydraulic plant was operated.

COPPER RIVER. The enormous output of copper from the Bonanza and Jumbo mines, in the Chitina district, overshadowed all other operations. The adjacent Mother Lode mine was, however, also operated throughout the year. Its actual shipments are as yet limited to the winter season, as the ore is sledded to the railway, a distance of 14 miles. Ore shipments from this district were

interrupted for several weeks during the summer on account of the burning of several railway bridges. Work was continued on a number of other copper properties, but they made no output and details regarding development are yet lacking. The Nizina placer district had a prosperous season. Five hydraulic mines were operated, in addition to some smaller plants. Some placer mining was also done in the Bremner River region, and, so far as now known, placer mining was continued in the Chistochina district on about the same scale as in previous years.

PRINCE WILLIAM SOUND. The operation of four or five copper mines and four gold mines constituted the principal mining activity of the year in this region. The value of the total product was about \$1,400,000, against \$1,198,742 in 1914. The Ellamar copper mine was operated on about the same scale as in the past. Operations were also resumed in 1915 at the Three Friends, and copper ore was shipped. The McIntosh mine, on Fidalgo bay, made some copper production, and it is reported that some ore was taken at the nearby Dickey mine, although no shipments were made. Large operations were continued at the Beatson copper mine, on Latouche island. The tram connecting the Midas copper mine with Port Valdez was completed in October, and since that time productive mining has been undertaken. In addition to the productive copper mines noted above, there were developments on many other properties.

The Granite mine, at Port Wells, was the largest gold producer on the Sound in 1915. In the Valdez district the Ramsay & Rutherford mill was operated during the summer, and underground work was continued. The same is true of the Gold King, where the mill was, however, operated for only about a month. At the Cliff mine another vein was found, and the mill was run intermittently during the summer. In the aggregate much other work was done during the year on the gold veins of Prince William Sound, but these operations are too numerous to be listed here.

KENAI PENINSULA AND SUSITNA REGION. The productive mining region that will be rendered accessible from Seward by the Government railway now under construction includes the gold lode and placer mines of Kenai peninsula, the Willow Creek lode district, the Yentna placer district, and the placers of Valdez creek. Latent mineral wealth is also found in the high-grade coals of the Matanuska fields and the lodes reported to occur in the Broad Pass region. This province has naturally been the scene of much mining activity during the season of 1915. While the large developments planned have not yet reached a productive stage, the preliminary estimates indicate that this field produced nearly \$500,000 worth of gold in 1915, which is about \$100,000 more than the value of the output for 1914.

In the Kenai peninsula there was much more placer mining than in any previous year. Among the important operations was the installation of a dredge on Six-mile creek. Much work was done on the auriferous lodes

of the peninsula, but it was chiefly prospecting and dead work, though incidentally several properties produced some gold. In the Willow Creek district three lode mines were operated during the open season, and developments were continued on several other properties. The hydraulic plant on Valdez creek was operated, and placer mining in the Yentna district continued on about the same scale as in 1914.

SOUTHWESTERN ALASKA. There were no important developments in southwestern Alaska. Development work was continued on the copper-lode claims in the Hiamna region. Some work was done at the Aniak lode mine, on Kodiak island. Beach mining continued as in the past on Kodiak and Popof islands.

THE YUKON. The Alaska camps of the Yukon basin are believed to have produced gold to the value of \$7,300,000 in 1915, against \$7,795,421 in 1914. The value of the output of the Fairbanks district was about the same in 1915 as in 1914, that is, \$2,725,000. Preliminary estimates indicate that the gold output of the Ruby and Hot Springs districts was less in 1915 than in 1914. On the other hand, the Circle gold output was greater in 1915 than in the previous year.

No new placers were discovered in the Fairbanks district in 1915. The largest gold production, as in previous years, was from the mines of Cleary, Ester, Goldstream, Fairbanks, and Dome creeks, and their tributaries, this order being about the relative value of the output from each creek. One dredge was operated on Fairbanks creek. On Goldstream creek and its tributaries, Pedro, Gilmore, and Fairbanks creeks, mining was done chiefly by the use of the steam-scraper, which has been found an economical method of handling gravel. Most of the other large operations in the district are those of deep mining—a method that is becoming increasingly expensive, because of the increasing price of the wood used as fuel.

Of the \$2,450,000 worth of gold recovered from the Fairbanks placers in 1915 about \$50,000 was taken out during the winter. The most extensive winter operations were those in the Chatanika flats. About 115 placer mines were operated at Fairbanks during the summer, employing 1200 men.

Little progress was made in the development of gold lodes in the Fairbanks district during 1915. Most of the lode miners have decided to await railway communication before embarking in any new ventures, because the present operating costs are prohibitive. In spite of these conditions, the value of the lode-gold production was about \$250,000, or nearly the same as in 1914.

The most productive gold-lode mines of the district are the Rhoads & Hall, operated until September, and the Crites & Feldman, operated throughout the year. In the autumn a 5-stamp mill was installed on the Gilmore-Stevens property, on Fairbanks creek. This mill was operated from about the first of September to the end of the year. Gold ore was also produced from a number of other properties and treated in one of the many mills of the district. The production of nearly 700 tons of anti-

mony ore from four properties in the Fairbanks district has already been noted. It is reported that a vein carrying tungsten ore (scheelite) was found near the head of Gilmore creek in the autumn of 1915.

The newly discovered Tolovana district lies about 50 miles north-west of Fairbanks. It is connected with Olnes, a station on the Tanana Valley railroad, by a winter road about 55 miles long. This road has also been used for pack-horses in summer. Another route of access is by launch up Tolovana river to a log-jam, around which a tram has been built. The distance to the log-jam by the windings of the river from the Tanana is about 200 miles. Above the log-jam a launch can be used for another 20 miles to the head of navigation; thence a wagon can go up the river-bars to Livengood, the principal settlement of the district, where are a post-office and a wireless station.

The gold placers of the district that have actually been developed are nearly all on Livengood creek and its tributaries. Of these the richest deposits are the so-called 'bench gravels,' which have been traced as a deep channel for two or three miles. Probably a dozen shafts have been sunk to bedrock on this deep channel, which lies on the north side of the creek. At Discovery claim the deep placers are about 100 ft. below the surface. The overburden thickens rapidly down-stream and becomes thinner up-stream.

Placer gold has also been found in the gravel of Livengood creek. These deposits are said to be from 10 to 20 ft. deep and to carry some gold, but they have not been developed. Besides the work on the deep placers, mining has also been done in the comparatively shallow gravels of several tributaries of Livengood creek and on Olive creek, in the same district. There were probably in all not over half-a-dozen plants installed in time for operation during the summer of 1915. These produced gold to the value of about \$60,000. There was, however, a good deal of prospecting, and the results were encouraging. Late in the summer some promising prospects were found on the south fork of Mike Hess creek and its tributaries.

About half of the gold output of the Ruby district came from the mines on Long creek and its tributaries. This locality contained not only the largest producers, but also the greatest number of plants. The output was somewhat curtailed by a dispute between the operators and miners in midsummer, when the 8-hour law for all underground mine-workers went into effect. Poorman creek and its tributaries was the second largest producer

of gold in 1915. Placer mining was also done on Birch, Trail, Tamarack, Spruce, and Flat creeks. Extensive prospecting was done on Greenstone creek, where a dredge is to be installed in 1916.

The value of the gold produced in the Iditarod district in 1915 is estimated at \$2,050,000, or practically the same as in 1914. In all, 31 placer mines were operated, employing from 350 to 400 men. Two dredges, one on Flat creek and one on Otter creek, were in operation throughout the season. One drag-line excavator, the



THE SEWARD PENINSULA.

first to be used for placer mining in Alaska, was installed on Willow creek during the summer. The principal centres of gold production were at Discovery claim on Otter creek, on the upper part of Flat creek, and at the heads of Happy and Chicken creeks.

Complete returns have not yet been received from the Circle district, but the data at hand indicate a larger production than in 1914. The installation and operation of a dredge on Mastodon creek formed the most important event of the season. A number of hydraulic plants were also operated, as well as a larger number of smaller placer mines.

In the Hot Springs district about 30 placer mines, em

ploying 300 men, were in operation during 1915. The largest plants were near the mouth of Woodchopper creek, where some rich placers were developed. The value of the gold output is estimated to be between \$500,000 and \$600,000. There was also some production of stream tin incidental to gold mining.

Preliminary estimates indicate that gold to the value of about \$135,000 was recovered from the Chisana district. The value of the output in 1914 was \$250,000. About 25 placer mines were worked during the summer and the principal operations were on Bonanza creek. New discoveries of placer gold are reported to have been made on Dry gulch, a tributary of Johnson creek.

The Koyukuk district is estimated to have produced gold to the value of nearly \$300,000 in 1915, compared with \$260,000 in 1914. A large part of this was taken out of one or two mines on Hammond river as a result of winter deep mining. The next largest producers were the mines on Nolan creek. A new discovery of placer gold was made on Jay creek, a tributary of Wild creek, and here considerable gold was mined.

It is estimated that the value of the gold output of the Innoko district in 1915 is \$190,000, or about the same as that of 1914. About 22 mines were operated in the winter and 38 in the summer. Yankee creek was the largest producer, and here two steam-scraping plants were installed. The second largest producer was Spruce creek, and mining was also done on Little, Ganes, Ophir, and Cripple creeks.

No important developments are reported from the other Yukon districts. The value of the gold output of the Fortymile, Eagle, Rampart, and other smaller districts was probably about the same in 1915 as in 1914. In the Kantishna district some work was done on gold and stibnite bearing veins.

The Wade Hampton placer district is situated on the lower Yukon, and Marshall is the name of the recording office. Placer gold was first discovered in the district in 1912 on Wilson creek. In 1915 gold placers were also found on Willow creek, in this district. Four mines were operated during the summer, and some high values were reported. Some prospective dredging ground was tested on Elephant creek with a hand-churn drill, with results that appear to have justified the installation of a power-drill. Some work was done on an auriferous quartz vein on Willow creek, and a sample was shipped for a mill-test.

KUSKOKWIM. Placer mining was carried on during 1915 in the Candle Creek, Aniak-Kwethluk, and Goodnews Bay districts. The value of the total production is estimated at about \$110,000. At Candle Creek a hydraulic plant was installed and operated during the later part of the season. About 40 men were engaged in mining in the Aniak-Kwethluk district. Most of the gold from this district was taken from the placers of Canyon creek. About a dozen men were engaged in placer mining in the Goodnews Bay district.

SEWARD PENINSULA. It is estimated that the Seward Peninsula mines produced gold to the value of \$2,900,000

in 1915, against \$2,700,000 in 1915. About 37 dredges were operated in 1915, against 39 in 1914. It appears that the dredge production, for which data are not yet complete, decreased much more than is accounted for by the smaller number of dredges. The reason for this decrease is not clear, but it is probably in part due to the fact that as yet there has been but little attempt made to dredge the placers that require artificial thawing. This is in contrast to the operation of the dredges in the Yukon basin, which are practically all on ground that is permanently frozen.

The data available indicate that about \$1,500,000 worth of gold was taken from the region immediately tributary to Nome and about \$700,000 from the Council district. The other districts, named in order of the value of their output, are Solomon, Kougarok, Fairhaven, and Port Clarence. One of the most important features of the year's operations was a marked revival of underground mining during the winter. It is estimated that about 36 deep mines were operated near Nome in the winter of 1914-15. There was also a little deep winter mining in other districts of the peninsula. The value of the gold produced in this winter work was probably about \$300,000. Besides the dredging and deep mining, there were many large open-cut operations, some with the use of hydraulic methods. There were also more small operations than in the previous year, and a good deal of mining on the present beach.

The continuation of stream-tin mining and of lode-tin development in the York district has already been referred to. It has also been noted that antimony ore was mined and shipped from two properties in the Nome River basin. There was considerable prospecting of auriferous lodes in this district, but so far as learned no gold was produced from this source.

NORTHWESTERN ALASKA. No important developments are reported from the Kobuk basin. Placer mining continued in a small way on Squirrel river and Dahl creek. No returns of production have yet been received, but it is probable that the value of the gold output was about the same as that of 1914, namely, \$33,000. The discovery of the petroleum seepage near Wainwright inlet has already been noted.

THE SAN FRANCISCO MINT reports the following transactions, bullion received, for November:

| Gold. | Fine ounces. | Value. |
|-----------------------|--------------------|------------------------|
| English coin | 296,912.416 | \$6,137,724.41 |
| Chinese bars | 2,517.923 | 52,950.10 |
| Australian bars | 191,446.977 | 2,997,976.51 |
| Other sources | 209,299.861 | 4,326,612.12 |
| Total | 610,176.277 | \$12,613,463.14 |
| Silver | 58,935.27 | \$29,797.25 |

Coinage consisted of \$152,000 in half-dollars, \$76,000 in quarter-dollars, and \$4000 in Philippine one-centavos. Coin, bullion, etc., on hand at the end of the month totaled \$360,219,025.78. A feature of 1915 was the large quantity of foreign coin and bullion received.

Cyanide Consumption on the Rand

*IN the treatment of 25,701,954 tons of ore in 1914, there was purchased for consumption a total of 10,518,009 lb. of cyanide and 8,543,014 lb. zinc. This gives an average of 0.4 and 0.32 lb., respectively, per ton. The present annual requirement of sodium cyanide is 5000 tons, costing at current prices about \$2,400,000. The possibilities of economizing in the consumption of cyanide was first investigated by the Buyers Committee of the Chamber of Mines and the consulting metallurgists of the Rand. The latter agreed that no application of known methods could be relied on to reduce the consumption materially in an economic manner. Special trials made a year ago showed a loss of gold more than balancing any saving in cyanide. Later, experiments were made under the control of a sub-committee consisting of W. A. Caldecott, K. L. Graham, E. H. Johnson, and H. A. White. These were mostly done in the laboratory of the Consolidated Gold Fields of South Africa by C. A. Meiklejohn, and were presented at the Society's meeting by H. A. White.

A theoretical limit to the minimum consumption of cyanide is set by the fact that the ore, crushed in water, carries into the collected charges a large amount of moisture; this water must be brought up to the cyanide strength required for extraction. For example: assume 50% sand at 15% moisture with a strength of 0.05% KCN, and 50% slime at 40% moisture with 0.01% KCN; this would give a loss of 0.12 lb. KCN per ton of crushed ore, and the exact figure will depend on the proportion between sand and slime and the moisture with each.

Another way of looking at this is to note that as the solution in stock is always kept at a certain average strength, the water brought into the plant as moisture must be brought up to that strength by the addition of cyanide, one way or another, and this cyanide must go to the residue or be dissipated elsewhere. This dilution effect is, of course, minimized by crushing in solution.

If to this is added the cyanide converted by contact to KCNS, $K_4Fe(CN)_6$, etc., a limit is reached which cannot be improved upon in practice, and to it must be added the self-decomposition of the solution while standing in sumps.

The cyanide going to the residue-dumps in various forms must represent the dilution loss, less the decomposition and HCN or other gas losses. Any saving in these two directions must therefore be partly discounted by increase in cyanide sent to dumps.

No attention need be paid to cyanide used in dissolving copper, silver, gold, mercury, or zinc, which merely has the effect of a temporary accumulator.

The theoretical minimum cyanide consumption for Geduld ore, based on 60% of the pulp (that is, 40 tons

of water with 60 tons of dry slime) and 40% of sand of 15% moisture (that is 15 tons of water to 85 tons of dry sand) after allowing for cyanide required to raise the associated water to 0.3 lb. NaCN per ton for slime, and to 1 lb. per ton for sand, amounts to 0.19 lb. per ton of ore treated. To this must be added 0.07 lb. converted into unavailable products. The irreducible minimum of 0.26 lb. NaCN per ton is thus arrived at, and this shows a possible saving in this case of only 0.06 lb. per ton if there were no losses in the form of gas.

Of course, a saving could be effected if lower cyanide strengths were possible without corresponding losses of gold in the residue, but that is not generally the case, and the point must be emphasized that any saving of cyanide by means of increased alkalinity or in any other way of reducing gas losses must be partly offset by increased amount of loss in residue moisture.

It is, however, a theoretical possibility that the CO_2 of the boiler flue-gases might be utilized to displace the HCN in the sand and slime residues, and in the former case the use of cyanide destroyers previous to sand-filling would thus be avoided and the HCN collected in alkali instead.

A number of experiments were undertaken, and are given in great detail. Briefly, they were as follows:

(1) Estimation, as NaCN, of the amount of total cyanide, ferro-cyanide, and sulpho-cyanide in sand-residue as discharged at the Simmer Deep.

(2) Estimation, as NaCN, of the amount of total cyanide, ferro-cyanide, and sulpho-cyanide remaining with settled charge of slime after treatment, and before same is discharged.

(3) Estimation same as No. 1 on sand-residue as discharged at the Rose Deep.

(4) Estimation, as NaCN, of the amount of total cyanide, ferro-cyanide, and sulpho-cyanide remaining with the settled charge of slime after treatment, and before same is discharged.

(5) Estimation, as NaCN, of total nitrogen in a sample of zinc-ox precipitate from the Simmer Deep.

(6) Estimation of cyanide solutions from the Simmer Deep and Rose Deep for total nitrogen present.

These tests showed a total loss as NaCN of 0.305 lb. at the Simmer Deep, and 0.268 lb. at the Rose Deep. The loss due to the escape of HCN as gas into the air was 44.7 and 49.5% respectively. It was noticed that an increased proportion of the pulp treated as slime results in increased cyanide consumption, owing to the greater amount of cyanide-bearing moisture in slime-residue; and that the smaller loss per ton of slime at the Rose Deep is due to the lower cyanide strength required for treatment at that plant.

In a test to determine the effect of exposure of sump cyanide solutions to the atmosphere, it was found that

*Abstract from the *Journal* of the Chemical, Metallurgical and Mining Society of South Africa.

loose or incomplete covering is practically useless in preventing loss of alkali or cyanide, with weak solutions there is no loss of HCN as total cyanide, and but little loss as free cyanide occurs while available protective alkali is present, with strongest solutions the loss of HCN, both as free cyanide and total cyanide, becomes serious when available protective alkali is below 0.01%. NaHO, and, comparing previous results, it is evident that the presence of zinc enormously decreases the loss of HCN by hydrolysis.

Another investigation covered the exposure to the atmosphere under varying conditions of working cyanide solutions. The conclusions to be drawn from a careful consideration of the exposure experiments, which are sufficiently comprehensive and consistent when account is taken of the various sources and conditions, may be briefly stated as follows: The loss is incomparably greater in pure synthetic solutions, even with added alkali, than is the case with ordinary working solutions; and a very heavy loss is shown in the presence of little or no protective alkali, when determined with addition of ferro-cyanide. This suggests that it is safer to omit the addition of ferro-cyanide in mill-tests.

An estimation was made of the amount of cyanide consumed during the treatment of a charge of collected slime, from the time of leaving the collectors till immediately after transfer to the first settling-vat. This resulted in 0.0158 lb. KCN, or 0.0122 lb. NaCN, per ton of slime treated. In transferring from the first settlement to the second, the loss was 0.0188 lb. NaCN. A considerable loss takes place during the settlement and decantation in the vats. In each of these the solution loses 0.001% KCN during the time the charge is under treatment. The loss during the treatment is considerable, and if this is taken as representing the loss by evaporation of HCN during the slime treatment, it will account for more than 0.14 lb. NaCN per ton of slime treated.

At the Rose Deep the consumption of NaCN is 0.0442 lb. per ton during transfer of slime from the collector to a Trent agitator, during agitation in this machine, and during transfer from it to the first settling-vat. No decomposition of the KCN in solution could be observed at the end of 72 hours from the action of the mill-service water.

Tests were made on regeneration. In ore, the cyanide regenerated equalled 28.9% of the total cyanide lost during agitation. This was in a closed vat. This was confirmed by using absorption-towers.

At the same meeting of the Society (September 18) a paper on the prevention of hydrolysis in cyanide solutions was presented by H. M. Leslie. He said that in ordinary practice it has always been recognized that a great deal more cyanide is used for dissolving the precious metals than is theoretically necessary, and various reasons have been put forward to account, in individual cases, for high consumptions; but in stating that, no one has ever yet put forward a reason to account for this large excess of cyanide which is necessary

in present practice, and which excess also applies to cyanide practice in general. A cyanide solution undergoes gradual decomposition; it evolves hydrocyanic acid, and this decomposition is not prevented by the use of excess alkali; the evolution of hydrocyanic acid means loss or consumption of cyanide in working practice, and it is this loss which is accountable for the large excess of cyanide which has to be used over and above that which is necessary for efficient extraction.

Experiments demonstrated clearly the following points:

That simple cyanide solutions decompose by the hydrolysis of the solution; that the percentage loss by this reaction is greater in a given time, the weaker the solution; that increased temperature accelerates this decomposition; that the alkali formed as a product of the hydrolytic action has little or no protective action on the remaining cyanide, so that hydrolysis goes on until all the cyanide is destroyed; and that the protection afforded by the addition of an excess of caustic alkali is by no means complete, and that the protection is only of a very temporary nature.

An investigation into the protection afforded to a simple cyanide solution, by means of a cover, showed the loss in a covered vessel is small compared with that in an open one. This loss was found due in accordance with the equation



Larger tests, on a working-scale, at the Village Deep mine, were made, to see if a loss was really being made which the 'closed' system would prevent, and if it was sufficient to justify any modification of plant. A large loss of cyanide, due to evaporation, was found; in the decantation-plant definite results were obtained, showing a loss of 0.0013% KCN per 24 hours, amounting to 32.572 lb. of 100% KCN per year, added to which is 10.857 lb. per year lost from the clarifiers on this solution, a total of 43.429 lb. Other tests were made, and it was ascertained that there was a difference of 0.2092 lb. per ton of 100% KCN, or 0.161 lb. of 130% KCN, in favor of the closed system per ton of sand treated. This was done at a small test-plant. The cyanide consumption at the Village Deep plant is 0.3 lb. 130% KCN per ton, or 0.39 lb. of 100% KCN. This might be reduced to 0.139 and 0.1806 lb. respectively by using the closed system of treatment. Pachuca tanks would also show a reduction by being closed.

Calculating the present rate of treatment on the Rand as 27,000,000 tons per annum, and the cyanide consumption as 0.3 lb. of 130% KCN, a saving by closed method would mean 1250 tons per year, say \$770,000. [It is significant that Mr. Leslie did not estimate the cost of covering treatment vats, etc., without doubt a large expense.—EDITOR.]

THE LAST TABULATED REPORT of the Transvaal Chamber of Mines shows that 10,048 stamps and 328 tube-mills, working 26.46 days, crushed 2,470,760 tons of ore, equal to a stamp-duty of 9.49 tons. The yield was \$6.19 per ton, and costs \$4.20. The working profit was \$5,050,000.

CONCENTRATES

Readers of the MINING and Scientific PRESS are invited to ask questions and give information dealing with technical and other matters pertaining to the practice of mining, milling, and smelting.

A CUBIC INCH of gold contains about 10 troy ounces and is worth \$200.

BORNITE contains from 77 to 55% copper, and 18 to 6% iron, with the formula Cu_5FeS_4 .

HEAT-LOSSES in electric furnaces occur around the charging-doors, tap-holes, and where the electrodes pass into the furnace. The latter loss cannot be reduced with the present design, but the others can be.

THE USE OF THE SLIDE-RULE by engineers and men about mines should be encouraged. Being able to settle quickly a question, involving numerical calculations, when it is being discussed is a matter of constant advantage, and a slide-rule in a handy leather-case for the pocket is an invaluable adjunct to a man who must consider costs.

IN BUSINESS there are two stages: one when the business is small, and can and should be dominated by an individual; and the other when the business has grown to such a size that it requires an organization. The dividing line is clear, but difficulty arises when one phase passes to the other. This applies to mining as well as other industries.

BELTED ALTERNATORS can be used to advantage in many installations where the space occupied is not a deciding factor in the selection of the generating-unit. Their lower first cost, as compared with direct-connected units, and the ease with which these generators may be connected to an existing source of power, as an engine, water-wheel, or line-shaft used for driving other machinery, has led to an extensive use of this type of alternator.

CANARIES have been used in coal mines to show a deficiency of oxygen in the air, but recent tests by the U. S. Bureau of Mines at Pittsburg proved that the use of these birds is not altogether reliable. Guinea-pigs have been used in Western Australian gold mines to note the effect of rock-dust, and subsequent examination of their lungs; but these animals evidently knew something was wrong, and buried their snouts in their fur, thus defeating the investigation.

CHANGE-HOUSES are necessary to the comfort, contentment, and efficiency of miners, millmen, and smeltermen. Every company that can afford it should erect one, and it is gratifying to note that the advantages of having a bath, dry, or change-house is becoming largely understood. In dirty mines and poisonous works men finish work in a considerable mess, making in many cases changing absolutely necessary. Seven States require change-houses by law, while in 13 States, where this is

no law, many companies have supplied them. Good material and sanitary ideas should be used in construction, and they should be well lighted and heated, with arrangements for drying wet clothes. Forty gallons of water per man-day is a reasonable consumption.

THE ELECTRIC-FURNACE is considered to be able to produce steel of superior quality to that made by other methods. The furnace makes a temperature higher than any other furnace, and produces such temperature economically; it produces this without contamination of the charge through gases and other impurities, and in case of the induction-furnace, without contamination through carbon; and it offers the possibility of controlling the temperature within limits which are entirely beyond the reach of the older types.

STARTING a load suddenly or when there is excessive slack is one of the most destructive influences on wire rope under any conditions of work, and especially a drilling-cable. Experiments made by placing a dynamometer between the rope and the load prove this contention, as when there was 2½ in. of slack, the stress on the rope was 39% greater than when the rope was pulled slowly; with 3 in., 65%; with 6 in., 122% or more than double; and with 12 in. stress was three times as great. When a new wire drilling-line is put on, it should be run a few times without doing any work, in order to get its 'set.' The cause of a lot of wire-rope trouble is due to kinks, and care should be taken to prevent them. All small bends and kinks should be taken out by placing the line on a wooden block and hammering it carefully with a wooden or copper mallet. If such kinks are not taken out promptly, there is likely to be a projection where the kink appeared, and when the wires at this point rub on the side of the casing, there is excessive wear.

ANTIMONY-GOLD ORES are troublesome to treat by cyanidation; this is the experience in New South Wales, Western Australia, and Rhodesia. At Hillgrove, in the first-named country, the caustic soda process was used for a time. In the Murchison range of Rhodesia the occurrence of antimony has hindered work, but a plant has been started at the United Jack mine, in which the McArthur-Forrest process is used. The ore is reduced to 30 mesh in two No. 7 ball-mills. From bins it is conveyed to tanks 23 ft. 9 in. diameter, and 8 ft. deep. A solution of caustic soda is pumped on ore, which assays \$7 gold and 12.5% antimony, and allowed to percolate through it. The resultant solution carrying the antimony sulphide chemically combined, is drained off to three carbonators, where it is treated with carbonic acid gases from a lime-kiln. The antimony is precipitated as an amorphous sulphide, and the sludge is pumped to a filter-press, the cakes being finally dried and sent to the market. The solution from the filter-press is used again. The sand residue is treated in the usual way by cyanide solution, which goes through zinc-precipitation-boxes for the recovery of the gold.

Recent Patents

1,157,176.—SEPARATION OF METALLIC SULFIDS FROM ORES. Thomas Mackellar Owen, Sydney, New South Wales, Australia, assignor to Edward William Culver, Sydney, New South Wales, Australia. Filed February 27, 1914.



1. In selective or preferential froth flotation separation of metallic sulfids from slimes, the herein described process for augmenting the flotative quality of certain sulfids in relation to certain other sulfids, which consists in adding to and agitating with the pulp a limited proportion of alkaline permanganate.

2. The herein described improved process of preferential or selective froth flotation of lead and zinc sulfids, which consists in subjecting slimes to contact with alkaline permanganate in solution, agitating the slimes in water containing a flotation medium, removing the leady float concentrate, adding acid, re-agitating and removing the zincy float concentrate.

1,159,141.—FURNACE AND ALLIED STRUCTURE. Utley Wedge, Ardmore, Pennsylvania. Filed March 4, 1914.

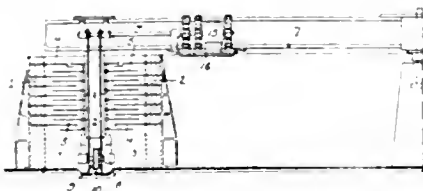

1. The combination, in a furnace, of inner and outer fixed annular structures, the inner having annular hearths projecting outwardly therefrom and the outer having annular hearths projecting inwardly therefrom, and an intermediate rotating annular structure supported from below and having annular hearths projecting in both directions therefrom, the inwardly projecting hearths lapping those of the inner fixed structure and the outward projecting hearths lapping those of the outer fixed structure.

1,159,713.—SEPARATION OF MINERALS BY FLOTATION. Lewis G. Rowland, Brookland, N. Y., assignor to New Jersey Zinc Company, New York, N. Y., a corporation of New Jersey. Filed August 1, 1914.

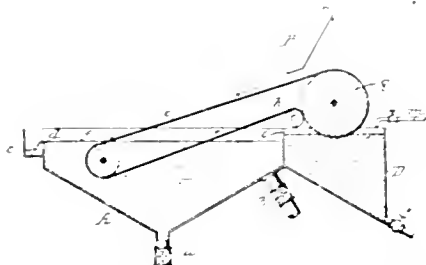

1. The method of separating sulfid constituents from ores in which they are contained, which comprises feeding the solid particles of the ore in a finely divided condition upon a moving layer of an oleaginous liquid having a selective action for the

sulfids of a character to effect flotation, progressively feeding said layer with its charge of ore into a flotation liquid at the surface thereof, and floating off and recovering the floating sulfids; substantially as described.

1,158,511.—EXTRACTION OF METALS FROM THEIR ORES. Hugh M. Leslie, Glasgow, Scotland. Filed December 30, 1911.

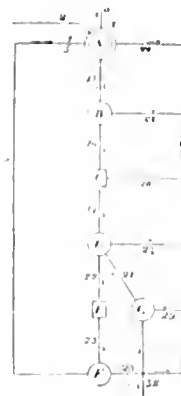

1. The improvement in the cyanid process for treating ores consisting in collecting the gases liberated at all stages of the process and conducting them continuously to a regenerating vessel wherein they are subjected to the action of an alkali so as to convert any hydrocyanic acid gas into a simple cyanid solution which latter is drawn off and added to the solution, from which the metal has been extracted, in the sump and thereafter supplied to the vessel in which the ore pulp is undergoing treatment, the arrangement constituting a closed circulatory solution system whereby the hydrocyanic acid gas which is constantly evolving from all the tanks, vessels or places in which cyanid liquor is used or stored and which go to form the various units of a cyanid plant is continuously being re-used in the process.

1,158,513.—TREATMENT OF ORES BY THE CYANID PROCESS. Hugh M. Leslie, Glasgow, Scotland. Filed December 30, 1911.

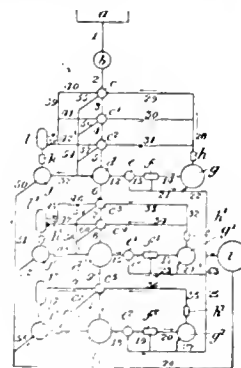

1. The closed circulatory cyanid process for the treatment of ores for the extraction of metals, consisting in effecting the treatment in stages, the first stage consisting in continuously bringing the ore pulp into contact with cyanide solution, then agitating the same, then conveying the same to the second stage which consists in removing surplus solution and then transferring the residue, from which surplus solution has been removed, to the third stage which consists in treating the same with a weaker cyanid solution, then agitating same and then conveying same to the fourth stage which is a repetition of the

second stage, the process further consisting in collecting the liquid removed at the second and fourth (dewatering) stages, extracting the metal therefrom and re-using same as required throughout the process, and also in collecting the whole of the cyanogen containing gases evolved during all stages of the process and re-using same in conjunction with air to agitate the ore pulp and convey same from stage to stage.

1,157,375.—PROCESS FOR THE MANUFACTURE OF SPELTER FROM FERRUGINOUS AND ADMIXED ZINC-BLENDE ORES. John James Fingland, Kaslo, British Columbia, Canada. Filed September 10, 1913.

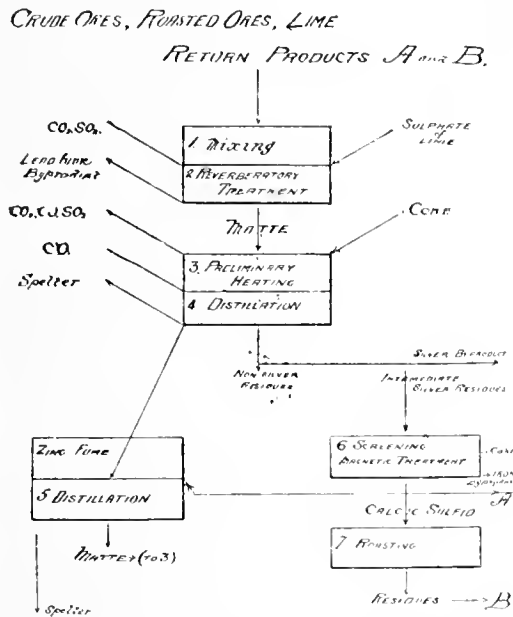

1. The herein described steps in the process of manufacturing spelter from ferruginous and admixed lead and zinc-blende ores, which consists in heating a mixture of crude ore, roasted ore, and lime, thereby forming litharge and maintaining the heat treatment until the litharge has been driven off by volatilization.

1,157,836.—AMALGAMATOR. Erastus B. Bennett, Denver, Colorado. Filed November 23, 1914.

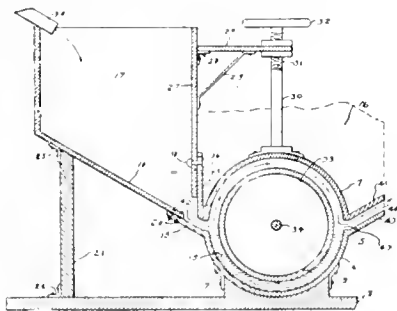

1. An amalgamator, consisting of two semi-circular members, arranged in conjunction with each other to form a circular chamber, said members being normally separated to form longitudinal openings the entire length of said chamber on opposite sides of the latter for the intake and discharge of the ore to be treated, an amalgamating roll journaled in said chamber, and one of said semi-circular members being adjustable to vary the size of said intake and discharge openings, a space being provided between said amalgamating roll and one of said semi-circular members for the passage of the ore through said chamber.

1,162,044.—PROCESS FOR EXTRACTING VALUABLE COPPER CON-

STITUENTS FROM CUPRIFEROUS ORES AND THEIR GANGUES. Eugene Erdős, Kolozsvár, Austria-Hungary, assignor to Azurit Company Limited for Chemical Industry Kolozsvár, Kolozsvár, Austria-Hungary. Filed February 26, 1914.

1. Process for extracting valuable copper constituents from materials containing the same consisting in disintegrating the said materials and thereafter leaching the same with aluminium sulfate solution.

2. Process for extracting valuable copper constituents from materials containing the same consisting in disintegrating the said materials, roasting the said materials and thereafter leaching the same with aluminium sulfate solution.

1,160,849.—PRECIPITATION. Harry R. Conklin, Joplin, Mo. Filed April 7, 1915.

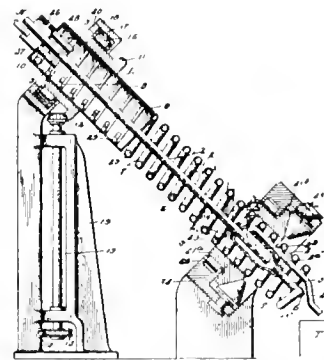

1. The method of precipitating substances from solutions which comprises passing a solution of the substance successively over pieces of a suitable solid precipitant moving in succession.

2. The method of precipitating substances from solutions which comprises subjecting a solution of the substance to pieces of appreciable volume of a suitable solid precipitant moving in succession in a direction opposite to said solution.

1,161,859.—APPARATUS FOR DISINTEGRATING ORE AND OTHER MATERIAL. Harry W. Hardinge, New York, N. Y., assignor to Hardinge Conical Mill Company, New York, N. Y., a corporation of New York. Filed December 31, 1908.

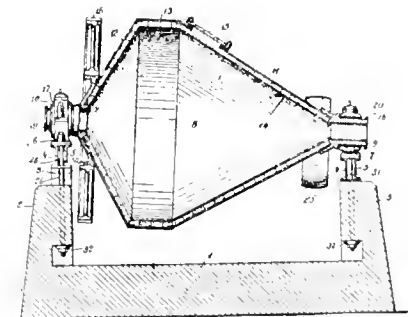

1. In an apparatus for disintegrating ore and other material, in combination, a barrel or drum having axial inlet and outlet trunnions, bearing members for the trunnions, each having a cylindrical inner surface surrounding a trunnion, and a spherical outer surface, supporting members having spherical inner surfaces to fit the said bearing members, a foundation upon which the supporting members are mounted, means for raising and lowering a supporting member to vary the inclination of the axis of the barrel, and driving means for rotating the barrel, including a driving shaft parallel with the axis of the barrel and supported by said supporting members whereby to remain substantially constant in position relative to the barrel at all positions of the latter.

REVIEW OF MINING

As seen at the world's great mining centres by our own correspondents.

ATOLIA, CALIFORNIA

LATEST FROM THE TUNGSTEN AREA INCLUDING PRICES FOR ORE

A local township organization, followed by the laying out and platting of a townsite to be known as Atolia, is almost accomplished. The tract covers 40 acres, on mining ground, the mineral rights of which are reserved to the original locators. Lots are being sold every day. A new general store has been built, to be open for business on January 1; a bakery will be built by a San Diego man; a pool-room, a stationery and cigar store, with a club-room annex, are other substantial evidences of progress in this important tungsten district.

Brock & Lipp, lessees at the Osdick group, received a check for \$57,000 for tungsten ore shipped to New York in November. Another lot was bought from the same lessees by Atkins, Kroll & Co. of the Atolia company. The price paid was said to be \$48 per unit of 60% WO₃.

The Scheelite group of 10 claims, which adjoin the Atolia company's ground on the east, is being prospected by means of a Keystone drill.

The recently erected mill is now working at full capacity, night and day, on ore extracted from the Atolia company's ground. When ore is short, there is 500,000 tons, more or less, of tailing that is being re-treated with good results.

The area of the tungsten belt is gradually increasing. Scheelite float is now being found on the Kramer road, three miles south of Atolia. Bailey and Anderson found a chunk of scheelite weighing over 200 lb., yielding nearly 200 lb. of high grade, which brought \$1.50 per pound.

There are half a dozen, or more, buyers of high-grade tungsten ore at Randsburg and in this district. Some of these are paying over \$2 per pound for grades better than 60%. As a consequence, there is more or less high-grading, and purloining of ore from dumps, warehouses, and cars, when shipments are being made. Last week two sacks worth over \$100 disappeared quickly when the watchman was not looking. A peculiar arrest was made. It is difficult to find out from where the ore comes, as many who sell scheelite buy for cash, in small quantities, from others and then resell it to agents or middlemen, who market the valuable high grades to eastern steel manufacturers. Tungsten is now so high that smaller shipments than carload lots must be sent by express. Several tons were thus shipped in a regular express-car last week. The rate is \$120 per ton by express for high-grade ore in sacks.

Victor Lipp has purchased the McGinnis hotel of Randsburg for \$2000. During the scarcity of accommodations at Atolia, the hotel is being used as an adjunct to his tungsten mine, where he can board and lodge his employees. The acute-ness of this problem of accommodations is illustrated by the fact that there are nine regular boarding-houses, and two restaurants and chop-houses, that are 'trashed to death.' The overflow goes to Randsburg, five miles away, by jitney.

More than 100 men are working at No. 1 shaft of the old Churchill mine, on the various levels. The main shaft is down about 100 ft., with the bottom in ore of good grade. Driving and stoping is under way for several hundred feet east and west, showing continuity of the main vein. At present the principal producing mines are the Churchill, No. 1, 2, and 3; Papoose, Piute, Para, Paradox, and Spaniard lease. Harry Hughes and R. D. Mayhood are the principal operators of leased ground from the Atolia Mining Company.

All leases of ground owned by the Atolia company will terminate on the first of January 1916. Leases of the Osdick, Scheelite, Toboggan, and other groups, however, will continue indefinitely. These groups are all outside of the 90 or more claims held by the Atolia company, only a half dozen of which are being worked as quartz producers. Several others, located and patented as lode claims are being worked by Italian squads for 'float' digging. The float diggers receive \$3 per day wages.

WASHINGTON, D. C.

MEETING OF THE PAN-AMERICAN SCIENTIFIC CONGRESS. TITLES OF SOME OF THE PAPERS.

During the last two weeks there has not been much mining legislation at the Capital, but the second Pan-American Scientific Congress has been of interest to mining men. It was in session from December 27 to January 8, during which time there were a large number of meetings at which many papers on a variety of subjects were read and discussed by prominent men. The Congress was divided into many sections and sub-sections, the papers being grouped according to their relationship to subjects. Mining, metallurgy, economic geology, and applied chemistry made up section 7, with Hennen Jennings as chairman. Van H. Manning, director of the U. S. Bureau of Mines, was chairman of the sub-section devoted to mining; W. R. Ingalls, president of the Mining and Metallurgical Society, chairman of the sub-section on metallurgy; George Otis Smith, director of the U. S. Geological Survey, chairman of the sub-section on economic geology; and Charles E. Munson, former president of the American Chemical Society, chairman of the section on applied chemistry. In the 19 sub-section meetings, all of which were fairly well attended, considering the diversions, over 50 papers were read and discussed.

Some of the papers were as follows: 'The Relation of Mining to the Pan-American Countries With Special Reference to the Mineral Resources of Peru,' by Hon. P. A. Pezet, Peruvian minister to the United States; 'The Value of Technical Societies to Mining Engineers,' by Dr. R. W. Raymond, past secretary A. I. M. E.; 'The Influence of Technical Journals Upon Engineering Education,' by T. A. Rickard, editor of the *MINING AND SCIENTIFIC PRESS*, San Francisco; 'The Possibility of Treating by the Cyanide Process the Complex Silver or Silver-Gold Ores of the Latin American Republics,' by G. H. Clevenger; 'Cyaniding in South America,' by H. A. Megraw; 'Mining in Ecuador,' by J. W. Mercer; 'The Electric Furnace in Metallurgy,' by J. W. Richards, Lehigh University; 'The Iron Mines of Cuba and the Methods of Preparing Their Ore,' by J. E. Little, Felton, Cuba; 'Metallurgy of Native Silver Ores in Southwestern Chihuahua,' by Walter M. Brodie; 'Concentration by Flotation,' by F. G. Fuchs, Lima, Peru; 'The Copper Mining Industry in the Americas,' by Walter H. Weed; 'Improved Mining and Metallurgical Methods as an Aid to Conservation,' by L. D. Ricketts; 'Buying and Selling of South American Non-ferrous Metals,' by L. Vogelstein; 'History and Development of Gold Dredging in Montana,' by Hennen Jennings; 'Recent Progress in Electrical Smoke Precipitation,' by F. G. Cottrell; 'Metallurgy at Braden,' by B. T. Colley and R. E. Douglas; 'Metallurgical Operations in Chuquicamata,' by

E. A. Rose; 'Ore Dressing,' by R. H. Richards; 'Mining Laws of Panama,' by J. F. Sanchez; 'Mining Law,' by J. W. Thompson; 'The Prospect of Marketing South American Zinc Ores,' by W. R. Ingalls; 'Lead and Zinc in the United States,' by C. B. Siebenthal; 'Iron Ore Deposits of the Americas,' by C. K. Leith; 'Value of Mining Property,' by J. R. Finlay; 'Mining the Pioneer of Intimate Commercial Relations,' by F. F. Sharpless, secretary of the Mining and Metallurgical Society; 'Development Work and Placer Operations of the Chile Exploration Co.,' by Pope Yeatman; 'Placer Mining Methods and Operating Costs,' by Charles Janin; 'Metallurgical Practices at the Tin Mines of Bolivia,' by Scovill E. Hollister, Bolivia; and 'Bolivian Tin,' by Howland Bancroft.

HOUGHTON, MICHIGAN

COPPER OUTPUT IN 1915.—FACTORS AFFECTING OPERATIONS.—
COPPER RANGE, WINONA, OSCEOLA, CALUMET & HECLA, AHMEEK, ALLOUEZ, AND MOHAWK.

The production of copper from the Michigan mines during 1915 broke all records, with a total of 259,352,000 lb. The nearest approach to this figure was in 1909, when it was 231,870,000 lb., and 230,437,000 lb. in 1905. Individual yields were as follows:

| Mine. | Pounds. | Mine. | Pounds. |
|-----------------|------------|--------------------|--------------------|
| Osceola | 20,945,000 | Copper Range Con., | |
| Ahmeek | 21,500,000 | including Baltic, | |
| Wolverine | 7,400,000 | Champion, and | |
| Mohawk | 15,800,000 | Trimountain | 54,000,000 |
| Isle Royale | 9,500,000 | Winona | 1,500,000 |
| Calumet & Hecla | 72,000,000 | Hancock | 1,400,000 |
| Centennial | 2,500,000 | Tamarack | 3,700,000 |
| Allouez | 10,000,000 | White Pine | 3,000,000 |
| Mass | 6,000,000 | La Salle | 700,000 |
| Superior | 4,000,000 | Houghton | 270,000 |
| Franklin | 2,600,000 | South Lake | 82,000 |
| Victoria | 2,500,000 | Lake Copper | 855,000 |
| Quincy | 20,000,000 | | |
| | | Total | 259,352,000 |

In considering these figures from a shareholder's point of view it should be understood that they are not the present annual rate of production, which is now 25% higher than the rate for the year. The first quarter of 1915 showed an output much below normal. When the War started in August 1914, the general condition of the copper business was not good. There were enormous quantities of metal on hand. It was a task for the treasuries of the companies to carry their unsold metal. All business was depressed. Copper mines in Michigan curtailed production; some went on half time, and some on three-quarter time. This was the condition when the year 1915 opened. In February the situation showed improvement, and by March all of the companies were turning their attention to an increased output. The War resulted in a big demand for copper. Lake Superior mines did not benefit much until April and May; it has been maintained ever since. Wages, dividends, and treasury surpluses were increased.

At present every mine's output of copper is only limited by its milling capacity. The output for 1915, while it was the largest on record, shows, in addition, a much greater increase in ore treated; also the largest working force ever employed here, a total of 18,000 men, and a yearly pay-roll of \$17,000,000.

The most interesting feature of the present situation in this State is the fact that 1916 will show a general betterment of at least 20% over 1915, provided the demand and price of copper averages the same as in 1915.

Perhaps the most remarkable yields are those of the three mines of the Copper Range Consolidated Co., which owns the Baltic, Trimountain, and Champion, but only a half interest in the third named. The output of these three was 54,000,000 lb.,

which is 30% more than their combined output in any previous year. More than half is from the Champion, which did well both in the ore extracted and the increase in copper content; as high as 50 lb. for a month at a time, a yield for an amygdaloidal mine that is rarely equalled.

The output of the Winona, 1,500,000 lb., includes 500,000 lb. which was taken out by contract and tribute mining, upon which the corporation received a royalty. The Winona was inactive part of the year.

The production of the Osceola Consolidated includes that of the North Kearsarge, South Kearsarge, and the original Osceola. The yield is larger than many anticipated, owing to the general belief that the life of the property is limited. The

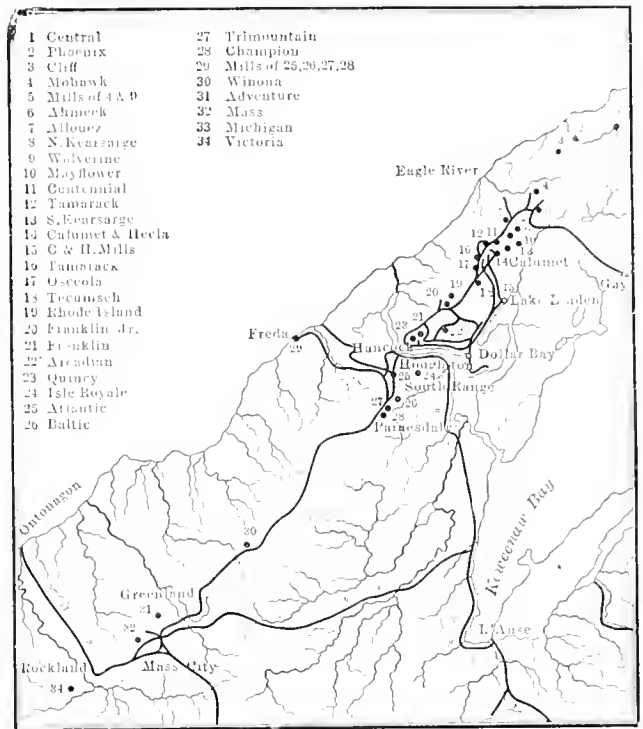

THE COPPER COUNTRY, MICHIGAN.

showing is 2,000,000 lb. better than any made in recent years, with the exception of 1909, when it was 25,000,000 lb. The record is all the more creditable when it is remembered that at the Kearsarge there was interference with hoisting owing to accidents and the completion of some construction. In addition to its earnings of at least \$24 per share, the company at present has the largest treasury balance of any in the district, excepting the Calumet & Hecla. The most encouraging feature is the fact that its underground openings in the North Kearsarge, where the ore has been extremely low grade, are slightly improving.

Calumet & Hecla's performance is the more remarkable when it is remembered that the increased tonnage of ore came entirely from the lower-grade amygdaloid shafts. Naturally the conglomerate has to be conserved. It is quite a different proposition handling Calumet & Hecla with a grade that averages 80 lb. per ton, and with about 20 lb. The output is better than it has been in six years, and with its subsidiaries the total was 146,000,000 lb., about 66% of the entire Lake Superior region. In the profit of this subsidiary production, however, the Calumet & Hecla treasury participates only to the limited extent of its ownership, one-half of Ahmeek, one-third of Osceola, and similar proportion in its other subsidiaries. Calumet & Hecla's present dividend rate is on a basis of \$60 a year, yet the earnings for 1915 undoubtedly were better than \$80 a share on its own mine alone.

The richest subsidiary of the Calumet & Hecla is the Ah-

books. The output in 1916 will probably show an increase of 10% over that of 1915. Two new stamps are to be erected at once. This work will take at least four months, possibly six. In the meantime the mill capacity is taxed to the utmost. The quality of ore maintains a good average, and the workings which now are well opened to provide for the additional tonnage needed show the average quality of the Kearsarge lode.

In 1903 the Ahmeek Land & Improvement Co. was organized, and purchased the surface rights of three estates in Keweenaw county. The mineral rights under the town of Ahmeek were recently sold to Thomas F. Cole of Duluth for \$1000 an acre, or \$160,000 in all. Evidently the idea is to develop the Kearsarge lode, and a 2500-ft. shaft will have to be sunk.

Ahmeek is another Calumet & Hecla subsidiary which is now, after five years of thorough preparation, in shape to produce copper at the rate of at least 10,000,000 lb. annually for 10 years at least, and 25 years with reasonable certainty. Costs will be lower in 1916 than ever before, as practically all necessary construction is done, and underground openings are further in advance than in any mine in Michigan.

Mohawk's performance is the talk of the district. Earnings for 1915 are over \$15 a share, and the present rate of earnings is better than \$20. Further, the mine is in excellent condition.

TORONTO, ONTARIO

COBALT AND NEW DEVELOPMENTS.—PORCUPINE NOTES. KOWKASH, CANADIAN MINING & EXPLORATION CO.

Lately there has been a marked revival of interest in Cobalt, stimulated by the opening of new veins in some of the older properties. There is an active demand for prospects, and the share market has been buoyant, with a general upward tendency. While shipments have increased, they are not being pushed as most of the companies are pursuing a conservative policy, thinking that the price of silver will advance.—The Nipissing has added considerably to its ore reserves. In a cross-cut from an old drift a vein which yielded nothing on the surface has been opened 27 ft., assaying 3000 oz. per ton over 1½ in. Driving 60 ft. above the No. 1 level on a vein paralleling vein 98 has opened a 3-in. shoot, containing 2500 oz. per ton.—The Coniagas has purchased the old Aganico mine on Lake Timiskaming, one of the early producers of the district.—Work is to be resumed on the Ophir Cobalt, which was closed down some years ago for want of funds. B. Neilly will be in charge.—The old Silver Queen is being worked from the Right of Way shaft, and making regular shipments of high-grade ore.—The new vein recently found on the Cobalt Comet is opening well at depth, containing 4000 to 5000 oz. of silver per ton at 20 ft. The shaft sunk on it will be continued to connect with the old workings.

At Porcupine good progress is being made with the new central shaft of the Dome; it is expected to reach a depth of 700 ft. in March. The hoist will have a capacity of 75,000 tons per month, which will be considerably ahead of the requirements of the mine for some time to come.—The Tisdale Mining Co. is sinking a shaft near the Dome Lake boundary.—Diamond-drilling on the Preston East Dome has shown a mineralized zone 200 ft. wide, traversing the property for 2000 ft. Surface development has been started to uncover promising looking veins cut during drilling.—The directors of the Dome Extension have been authorized by the shareholders to sell 1,000,000 shares at not less than 25c. each.

Though the original discovery on the King Dodds claims in the Kowkash district has proved disappointing, the vein which showed so rich on the surface having pinched out at the depth of a few feet, the latest report of Percy E. Hopkins, of the Ontario Bureau of Mines, on the district generally is understood to be of a favorable character, especially as regards the prospects to the west of the district along the line of the National Transcontinental railway. It has not been consid-

ered advisable to publish it, as too little development has been done to form a basis for a conclusive decision as to the value of the region.

The Canadian Mining & Exploration Co., organized in 1912 by New York and Canadian people, with a capital of \$5,000,000, to investigate and exploit mining property, is being wound up, and the money returned to investors. It investigated about 1500 mining propositions, but found none that were considered worth purchasing at the price asked. In the meantime the capital was invested in good securities, and the shareholders will, it is stated, be repaid in full.

The annual report of the Coniagas Mines, Ltd., of Cobalt, has been issued. Development was confined to following small veins and extending certain cross-cuts. This work added 212,700 oz. to the reserves, which were estimated as 12,891,380 oz. on October 31. The mill treated 55,037 tons of ore. Shipments included 473.9 tons of concentrate assaying 2174 oz. per ton, and 133.2 tons of 233.3-oz. slime. The heads averaged 23 oz. per ton, and residue 3.91 oz. Ore shipped weighed 267.2 tons, containing 3519.6 oz. per ton. Silver sold totaled 2,002,053 oz. Mining and treatment cost 13.618c. per oz., exclusive of freight, smelting, and marketing, which was 3.252c. per oz. Dividends totaled \$740,000, making \$7,810,000 to date. P. D. Reid is superintendent.

During shaft-sinking at the Croesus gold mine in Munro township, \$125,000 was extracted in 75 ft. of work. The vein has been cut at 200 ft., where it is high grade.

On January 20 the La Rose company will pay 1½, equal to \$74,931, making \$5,472,052 to date.

RAND, NEVADA

NOTES ON A DISTRICT WITH THREE RICH MINES.

Rand is in Mineral county, about 15 miles east of Walker lake. It has been somewhat sensational by having shipped upward of \$100,000 of high-grade ore, also having opened large veins of excellent mill ore. Only three mines have been developed, but are shippers of rich ore.

The most important deal made in the camp so far is the sale of the Golden Pen mine to a syndicate of Western operators headed by Jesse Knight of Utah, associated with Adams and O'Neil of Los Angeles, J. H. Miller of Hawthorne, and others. The deal was closed on December 15, and the new owners immediately started 12 men working. High-grade ore is being hauled to Nolan spur, a station on the Southern Pacific railway. The price reported is \$150,000, to be paid within one year. The Golden Pen has made very rich shipments; one car, the lowest grade shipped, averaged \$118; another, \$600; while a recent carload averaged \$1018 per ton; smaller lots have contained as much as \$18 per pound. One very unusual condition of the sale is the fact that the owners retain for their own use and operation, one high-grade shoot in the mine 20 ft. long, from which they are stopping some wonderful ore and will soon make shipment.

The Queen Regent Merger Mines Co. recently bought the Lone Star claims for \$50,000. It has steadily developed the property with a good number of men and reports the opening of a 30-ft. vein on the first level, which in the second level is 40 ft. wide, with the hanging wall not yet reached. Development is now going on on No. 3 level. A good grade of mill ore has been opened, but rich material has not yet been cut as in the other mines, except at No. 2 shaft, where a block of ground was leased last November to Miller and Meaker, who have opened high-grade ore, and are now making shipments. In addition to this the lessees have opened a 5 to 7-ft. vein of fine mill ore.

Adjoining the Queen Regent on the west the Last Hope mine recently shipped a carload to the Hazen sampler, averaging over \$80 per ton. It is thought that the Last Hope will, with cross-cutting at depth, open the huge vein of mill ore that is under development in the Queen Regent.

THE MINING SUMMARY

The news of the week as told by our special correspondents and compiled from the local press.

ALASKA

JUNEAU

November returns of the mines on Douglas island were as follows:

| Results of operations. | Alaska Mexican. | Alaska Treadwell. | Alaska Juneau. |
|-----------------------------|--------------------|----------------------|-------------------|
| Stamps working | 120 | 540 | 300 |
| Ore crushed, tons | 16,800 | 80,609 | 48,594 |
| Gold from all sources | \$27,959 | \$166,628 | \$82,003 |
| Yield per ton | \$1.66 | \$2.06 | \$1.72 |
| Operating profit | \$5,667 | \$67,472 | \$22,495 |
| Construction charges | \$9,618 | \$12,953 | \$24,352 |

In addition to the Treadwell operating profit, there was received from the Mexican and United companies, a total of \$24,705. the amount of adjustment of construction expenses.

KETCHIKAN

(Special Correspondence.)—After a delay of two months, lessees at the Cymru mine at North arm have finally secured transportation for a small shipment of copper ore. The *Despatch* will load this ore, also about 300 tons from the Mt. Andrew mine, for the Tacoma smelter.

The Rush and Brown is now shipping to the Granby smelter at Anyox, British Columbia, and the first shipment to the plant from this mine, consisting of 700 tons, has just been delivered.

Recent developments at the old Hydah mine, Corta bay, has proved that the ore is practically continuous from the old workings to a distance of 350 ft. in an easterly direction, while several open-cuts have exposed magnetite chalcocopyrite ore along the contact-zone, and at one place an open-cut exposes a solid sulphide body 15 ft. wide, averaging 3.5% copper. This deposit was traced from a magneto-metric survey made by W. L. Polson.

Gold mining in the vicinity of Twelve-mile arm and Hollis is proceeding with good results. The Julian mine at HARRAIS creek has been developed to a depth of 300 ft. on the vein, and J. H. Rodgers, the principal owner, has finally decided to enlarge the mining and milling plant, and make other improvements. Lessees on the old Puyalop mine are said to be making good.

Flotation experiments made on ore taken from the Apex group at McLeans arm are said to give satisfactory results. Mining in this district will become more interesting when it becomes more generally known that there are a number of low-grade copper-gold deposits containing large quantities of ore amenable to flotation.

A body of ore said to be 80 ft. wide, near Smeaton bay, averaging \$1.50 gold per ton is said to have been bonded to J. T. Jones, representing Tacoma and Portland people.

Ketchikan, December 15, 1915.

ARIZONA

COCHISE COUNTY

The approximate copper production of the Calumet & Arizona and Copper Queen smelters at Douglas in 1915 was 75,000,000 lb. and 125,000,000 lb., respectively, both good increases. The totals include custom ores. Both companies have extended the sliding-scale of wage up to 25-cent copper, effective December 1, 1915. The price of metal on which wages are to be based

will be the average quotation of electrolytic copper for the preceding calendar month.

GILA COUNTY

Two more units of the Inspiration mill are working, making 11 out of 18, treating 8000 tons per day. Improved driving gear has been fitted to the apron feeders supplying the gyratory crushers. A battery of motor-driven blowers for the flotation-plant is expected soon.

The raise above No. 12 level in the Arizona Commercial is nearly up to No. 11 in 8% ore. The output is now 500,000 lb. of copper a month.

Five cars of ore from the Iron Cap early in December assayed from 15 to 20% copper, netting \$15,042. The profit for 1915 was about \$130,000.

GREENLEE COUNTY

On December 27 the United States marshal, J. Dillon, and 50 deputies escorted 236 miners at Morenci from the Duncan refugee camp. The men are to do assessment work on the Detroit Copper Co.'s unpatented claims, and will be unmolested by the strikers on account of an injunction from the Federal court.

The strike is costing the Shannon company over \$10,000 a month, not including loss of copper production.

On January 1 the strikers voted against accepting an offer from the Arizona, Detroit, and Shannon companies, which wished to resume operations with former employees, with an extension of the present scale of wages on a basis of 20c. copper, provided the men gave up their Western Federation of Mines charter. The offer meant an increase of 5% in wages for 5000 men, but no recognition of the union. A mediation committee of neutral people of Clifton acted in this offer. Nearly every American voted for acceptance, but the Italians and Mexicans were against it. It was further proposed by the companies to place the wage-scale on a basis in accordance with the selling-price of copper.

Under the proposed schedule the following scale would be in force: miners and muckers 39½c.; trimmers 31½c.; timbermen, 41½ to 51c.; furnace-men 39c.; skimmers 47½c.; boiler-makers 62½c.; electricians 66½c.; carpenters 59½c., and machinists 62½c. per hour.

MOHAVE COUNTY

Much excitement prevails at Oatman through the 400-ft. level of the Big Jim cutting the hanging wall of what is thought to be the Tom Reed lode. So far it is 43 ft. wide, averaging \$20 per ton.

Some good ore has been opened on the surface of the Times mine, about 4 miles from Oatman. A large sample is on view on Bush street, San Francisco.

YAVAPAI COUNTY

Three miles north of Constellation, R. T. Barton and son have opened silver-lead-vanadium ore to a depth of 60 ft. The vanadium is said to occur partly as beautiful crystals, and is of high value.

CALIFORNIA

The number of new oil wells drilled in California during 1915 was about 240 compared with over 400 drilled during the previous year. This decrease, in conjunction with the natural decline in productiveness of wells, accounts for the 10% short-

age in total production. Demand for oil has increased in the past few months causing a reduction in storage.

On page 24 of the issue of January 1 it was stated that the State Mining Bureau chapter on Amador, Calaveras, and Tuolumne counties was by W. B. Fletcher, this should have been W. B. Tucker.

BUTTE COUNTY

A new type of dredge designed by L. D. Hopfield of the Natomas Consolidated, is to commence work at Oroville in a few days. Its purpose is to redredge the tailing-piles and leave the final material level. Mr. Hopfield considers that the owners of dredged land should pool their areas for the success of this scheme on a large scale.

It is reported that the Burlington property at Forbestown has been sold to Eastern people for \$130,000. W. C. Ralston of San Francisco was instrumental in arranging the deal.

ELDORADO COUNTY

(Special Correspondence.)—John D. Cover, of Seattle, has acquired, after personal examination, four gold quartz lode-mining claims in this county, situated on the Mother Lode between the Church-Union and the Laus Padre mines on the north fork of the Cosumnes river, about four miles south of El Dorado (formerly Mud Springs) railroad station. Three miles along the trend of the same formation south is the Montezuma quartz mine, which has been for the last nine months, and is yet, under extensive development in depth by George Wingfield of Goldfield and W. J. Loring of the Plymouth Consolidated, seven miles farther south. Mr. Cover intends to develop and equip his property in a modern manner.

Mining was started on the old Church-Union mine (two claims adjoining) in 1872, and the two properties have produced over \$10,000,000 in gold. At the 200-ft. level there was a long shoot of ore 20 ft. wide, between good walls, that averaged \$20 free gold per ton. The vein has been mined to a depth of about 2000 ft. It is said to be a good mine yet. The Church mine was named after 'Tom' Church of New York, who operated it for some years. The Rheta mine (the old Bay State) on which deep-level development on a large scale was recently started by B. C. Clark, is also on the same formation, about midway between the Montezuma and the Plymouth mines.

Placerville, December 26, 1915.

Steam-shovels will not be used as contemplated by the Webber Creek Co. at Cold Springs.

The Golden Center company of Grass Valley has acquired the Lady Emma and Noon Day quartz claims in the Nashville district. Some rich ore has been extracted from the Emma lately.

INYO COUNTY

A transmission-line seven miles long is to be erected at once between Keeler and the Cerro Gordo zinc-lead mines. M. A. Stampher & Co. of Los Angeles has the contract.

KERN COUNTY

A large tungsten area is reported to have been discovered six miles south-west of Randsburg. It is in the tungsten belt, and can be traced from Atolia to White's and Powell's camp, and from the latter the ground is 2½ miles west. 'Float' ore contained as high as 75% tungsten. The field has been rushed.

NEVADA COUNTY

The new change-house at the Champion mine on Dry creek is in full occupation. It is of corrugated iron, lined with asbestos, has a cement floor, hot and cold water installed, and accommodation for 350 men.

The North Star and Empire companies are to pay bonuses to miners. For the present the standard shift's work will be seven holes, depending on the character of the rock drilled. It is thought that some men will make up to \$4 per day; the present wage is \$3.

SHASTA COUNTY

The monthly ore production of the Mountain Copper Co. at Keswick is about 15,000 tons. The smelter at Martinez is kept busy.

Ten stamps are working 20 hours a day at the Uncle Sam mine four miles west of Kennett.

SIBERIA COUNTY

The Young America mine at Forest has been bonded to E. J. Wiley of Nevada City. The 1000 ft. adit is being prepared for resumption of work.

STENISLAUS COUNTY

A new company, the Pacific Coast Manganese Co., with offices at the Monadnock building, San Francisco, is commencing work at Ingram canyon, and expects to start shipping at an early date. J. C. Sartorius is president, and J. A. Rumsen, vice-president.

TUOLUMNE COUNTY

(Special Correspondence.)—J. W. Mercer of New York, has exercised his option on the Polson Oak mine, and has taken



CYANIDE PLANT, MILONES MINE, CALAVERAS COUNTY, CALIFORNIA.

it over on a lease and bond. Development has been started under the supervision of W. H. Knowles of Sonora. This mine has been idle for about 15 years. The former owners sunk an incline shaft on the vein to a depth of 300 ft. Three levels were opened, all showing good ore. A five-stamp mill was erected, and about 5000 tons of ore crushed. As depth was attained the ore became more mineralized, and the recovery by amalgamation decreased. While part of the gold was saved by concentration, a great deal went down the creek in the tailing. In those days the concentrate was hauled by wagon to the nearest railroad, and shipped to the Selby smelter. Electric power was not in use in this county, and other modern methods of mining and milling were unknown at that time.

There are other deals pending in the district:

Sonora, January 2.

The McAlpine Mines Co., an organization of Californian people, has been formed to re-open the old McAlpine mine near the line between Tuolumne and Mariposa counties, the nearest town being Coulterville. F. R. Whitcomb is president and manager, L. C. La Rue is vice-president. The mine was worked in the 60's, and was a well-known producer in the early days. A shaft has been sunk 500 ft., and some development done toward re-opening the old workings. Electrical machinery will be installed.

COLORADO

CLEAR CREEK COUNTY

(Special Correspondence.)—An 18-in. shoot has been cut in the Lake vein by Craise & Co.; the first carload shipment

settled for 5.4 oz. gold per ton. Work is done through the Big Five adit, and at the bottom of a 50-ft. winze.—The 1915 production from the Edgar and Bellman veins of the Big Five company totaled \$34,780. These were the only two properties worked by the company.

All preliminary work at the McClelland adit has been completed, and machine-drills are at work. Progress is expected to be at the rate of 150 ft. a month. L. W. Shaffer is manager.

Eighteen inches of ore has been cut in the east drift of the Ruler vein at Georgetown, worth \$100 per ton in gold and lead. Work is done from the Capital adit.

It is reported that the Onondago Mining Co. will take over the Doric property on Saxon mountain. The adit has a length of 3009 ft., but it is proposed to drive 2000 ft. to intersect the vein system of Highland park.

Harper & Co., leasing on the Aetna vein at the Capital mine, has commenced shipments of \$80 ore. The shoot is 10 in. wide.

Idaho Springs, December 29, 1915.

Ore production of the East Argentine district has averaged 24 tons per day during the past two months, the largest recorded. The largest shipments come from the Imperial mine. All lessees are getting satisfactory returns.

TELLER COUNTY (CRIPPLE CREEK)

Work has been resumed at the Black Belle company's property on the east slope of Beacon hill. The Chester Leasing Co. has a lease on 17 acres. Shipments will soon commence.

GEORGIA

LUMPKIN COUNTY

Thirty stamps are crushing hard ore from the Findley Ridge Mining & Power Co.'s Crown Mountain mine. A cyanide-plant, in charge of A. H. Head, is being erected.

Black sands from the Briar Patch placer claims are being investigated; they assay up to \$200 per ton.

Encouraging developments are reported from the Stouard, Calhoun, Consolidated, Turkey Head, and other properties.

IDAHO

CUSTER COUNTY

The town of Mackay was started by the owners of some copper mines nearby, and has grown considerably. The Empire mine is of some importance, managed by Ralph R. Osburn. Utah people, headed by L. R. Eccles, now have control. Frank M. Leland is consulting engineer.

In the Yankee Fork district the Custer Slide & Development Co. operates the Montana mine. Two weeks ago 27 tons of ore was brought to Mackay from this property. Of this, 6.5 tons is worth \$15,000, and the remainder, \$350 per ton. The mine is well equipped.

SHOSHONE COUNTY (COEUR D'ALENE)

In *The Wallace Miner* of December 30 are some interesting figures on 13 years' mineral production of the region, also the estimated output of the State in 1915, the latter compiled by the state mine inspector, Robert N. Bell. His total value is not much different from that of the U. S. Geological Survey, but the outputs vary somewhat. He estimates as follows:

| | |
|----------------|--------------|
| Metal. | |
| Copper, pounds | 6,655,000 |
| Gold, value | \$1,235,000 |
| Lead, pounds | 364,300,000 |
| Silver, ounces | 12,206,000 |
| Zinc pounds | 91,731,000 |
| Total value | \$37,551,542 |

The Coeur d'Alene produced 95% of the lead and 98% of the zinc. Custer county yielded 95% of the copper, and Boise county 50% of the gold. Most of the antimony came from the Coeur d'Alene.

Employees of the mining companies were well treated during the holidays, along with the days off they were given turkeys and cigars by some.

The Morning-Evening vein of the Federal company's Morning mine is expected to be soon cut by No. 4 adit of the Independence Lead Co., which is in 3000 feet.

The Washington Water Power Co. reports that it has made contracts for power with 22 mining companies in the Coeur d'Alene since last July. Others are awaiting connection.

ILLINOIS

(Special Correspondence.)—Large shipments of zinc ore continue to be sent from the Black-Jack, Federal, Kohlmann, North Unity, Great Western, and Joplin producers at Galena. A new separating-plant, built by the Great Western company, is treating a stock-pile, making four cars of top-grade product each week. The Galena Refining Co. has purchased seven acres of land in this city, and a new 75-ton separating-plant will be finished on January 1. The new plant involves new methods of electrolytic separation devised by L. V. Rice. All grades of ore can be treated at greatly reduced cost.

Galena, December 22.

MICHIGAN

THE COPPER COUNTY

A brief review of this region appears on page 63 of this issue. Over 1200 employees of the Mohawk and Wolverine companies received a 5% bonus at Christmas.

MISSOURI

JASPER COUNTY

Prices for zinc concentrate at Joplin during the week ended December 31 ranged between \$85 and \$116 per ton. The output of the Missouri-Kansas-Oklahoma region was 5473 tons blende, 898 tons calamine, and 1098 tons lead, averaging \$96.70, \$64.10, and \$67.06 per ton respectively. The total value was \$622,830, and for 52 weeks, \$25,268,783. Another week's return will complete the past year.

The 'Origin of the Zinc and Lead Deposits of the Joplin Region' (Missouri, Kansas, and Oklahoma), is the title of U. S. Geological Survey Bulletin 606 by C. E. Siebenthal. The publication covers 283 pages. The author has been studying the deposits for 12 years, although not continuously. The work is very thorough, and should be secured by all interested in the area which produced the large total as given above.

MONTANA

SILVERBOW COUNTY

(Special Correspondence.)—The East Butte Copper Co. is negotiating for control of the Butte & Duluth property, which has been tied-up in bankruptcy for several months. The claims are near the Pittsmont mine and smelter of the East Butte. The ore contains copper carbonate and is mined by means of an open-cut. The mill has a capacity of about 250 tons per day. The ore was crushed through 8-mesh and leached with sulphuric acid in a series of five large Dorr classifiers. The copper was precipitated by electrolysis. The mill was completed only a short time before the shut-down, and the company was not strong enough to work in the face of the low price of copper and the general depression that existed at that time. The process was successful, however, and there is every indication that the property can be worked at a profit.

The Butte & Bullwhacker has been leased to Patrick Wall and I. A. Heilbronner for one year, under the condition that they mine at least 1000 tons of ore per month, and pay as royalty 25% of the net proceeds. They also secured an option on 51% of the stock of the company at 50c. per share. The first payment is to be made in 30 days, the second in 90 days, and the final payment at the end of 18 months. The Bull-

whatsoever near the Butte & Duluth and it was also worked by a glory hole. About \$400,000 was spent experimenting with leaching processes similar to that adopted by the Butte & Duluth but as the copper occurs as a silicate, they were not successful. Former lessees have made money shipping the high grade ore to a smelter.

Butte, December 24, 1915

NEVADA

HUMBOLDT COUNTY

A flotation concentrating plant is to be erected by the Antimony Syndicate Co. near Unionville. The ore is high grade. John Ross is superintendent.

Little has been heard from National lately, but it is now reported that the National Mines Co. has installed a tube mill and is shipping concentrate. The Indian National, Snorting Bob Shilo Mining, and Howard and Hudson companies are busy with development.

At 60 ft. below the 1400-ft. level the Seven Troughs Coalition company has cut two feet of \$240 ore, showing plenty of free gold.

NIJE COUNTY

Six companies and several lessees at Tonopah last week produced 7567 tons of ore worth \$162,166.

The Tonopah company shipped 60 bars of bullion valued at \$72,225. Development generally is satisfactory.

The Extension profit in November was \$61,800.

The Nevada-California Power Co., which supplies Tonopah with electricity, has insured its employees for \$1000 each in the Equitable Life, and will keep the policies in force at its own expense. A benefit fund is also being arranged.

Kansas City people, connected with the Tigre Mining Co. of Sonora, Mexico, have purchased the Phonolite claims three miles west of Lone. E. C. Cooley represented the purchasers. A mill is contemplated at an early date.

SOUTH DAKOTA

LAWRENCE COUNTY

Two weeks ago the Wasp No. 2 company sent 26 tons of tungsten ore to the Crucible Steel Co. of America at Pittsburg. The lot is valued at \$48,000.

PENNINGTON COUNTY

If sufficient money can be raised, the Hill City Mining & Development Co. will sink its shaft, develop the mine, and erect a flotation mill. A persistent vein has already been opened to a considerable extent. The property is five miles north of Hill City.

TENNESSEE

POLK COUNTY

A much greater output of zinc is expected from the Mascot mine of the American Zinc, Lead & Smelting Co. during 1916 than in 1915. The total may be 45,000,000 lb. The 10 months ended October 21, 1915, produced 386,880 tons of 3.99% ore, yielding 18,741 tons of 59.88% zinc concentrate equal to 22,444,000 lb. of metal. The estimated cost is 4.95c. per lb. The present daily capacity of the mill is 2600 tons of ore.

UTAH

In its issue of January 2, *The Salt Lake Tribune*, devotes 88 pages to a review of the year, etc., in this State, the mining section covering 19 pages including carefully prepared statistics, brief notes on the mines, districts, processes, and power development.

JUAB COUNTY

The Colorado Mining Co. has issued its report for the year ended November 1, 1915. The property at Tintic was worked mostly by lessees, which resulted in a net profit of \$9914 to the company. When the Tintic Milling Co.'s new plant is ready,

probably in January, the low grade ore will be treated there. The lessee's output was 1190 tons (dry) of ore assaying \$36.15 per ton in gold, silver, lead, and zinc. Sampling, freight, and treatment cost \$8.42 per ton. The cash balance is \$42,054. J. W. Knight is general manager, and E. F. Birch assistant.

SALT LAKE COUNTY

The Hingham Toole Mining Co.'s adit is in 572 ft. in heavily mineralized formation. The flow of water is increasing. Officials expect interesting developments in the near future.

SUMMIT COUNTY

The Ontario company is now shipping 50 tons of ore daily from its 1000 and 1500-ft. levels to the Garfield smelter. It is highly silicious.

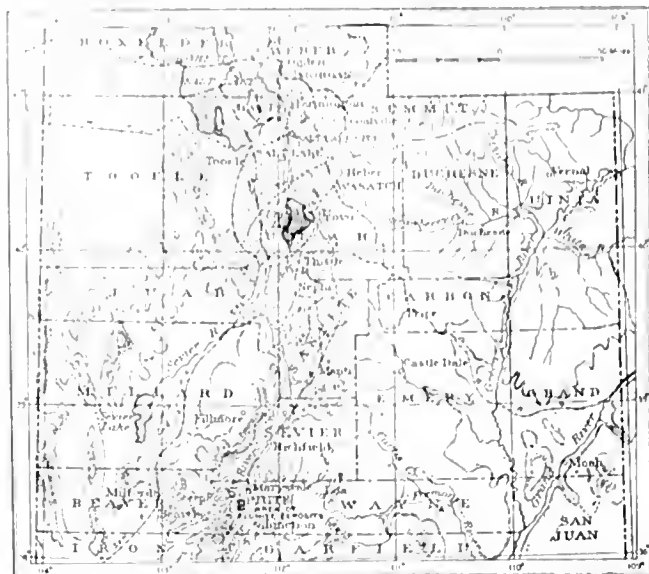

PART OF UTAH, SHOWING ALUNITE DEPOSITS. THE U. S. GEOLOGICAL SURVEY RECENTLY ISSUED A BULLETIN DESCRIBING THEM.

WASHINGTON

FERRY COUNTY

(Special Correspondence.)—During the last seven weeks the following shipments of ore have been made from mines at Republic: Ben Hur, 2960 tons; Tom Thumb, 765; Knob Hill, 480; and Lone Pine, 400; a total of 4605 tons.

Work has been resumed in the Belcher mine in the Belcher district, with a few men and shipping three to four cars of ore per week.

Lessees have been extracting \$25 ore from the Washington mine, on Belcher mountain, and are now developing an extensive body of pyrrhotite, which gives small returns in gold.

Information from Keller states that a five-foot vein in the Golden Crown mine is producing ore assaying \$234.80 in silver, copper, and zinc, with enough gold in addition to pay the cost of treatment. The mine is owned by the Illinois Copper-Silver Mining & Milling Co. Andrew Hamilton is the local manager.—Four miners are working on the Walla Walla group, and recently struck a stringer of high-grade copper ore a foot wide.

Republic, December 25, 1915.

OKANOGAN COUNTY

Following a request made by the Northwest Mining Convention held at Spokane last February, F. A. Thomson, head of the mining department of the Washington State college at Pullman, has made an investigation of the mineral deposits in this county. He states that there are in this district bodies of more or less complex ore, consisting mainly of pyrite, sphalerite, galena, and tetrahedrite, all contained in a gangue of

bluish-white quartz. He has not been able to make a thorough investigation of the deposits in the district and consequently cannot report on the quantity of ore available, as the State government, unfortunately, while it makes liberal appropriation for research work in other lines and industries, does not provide funds to finance investigations of the mineral resources. For this reason he was compelled to confine his efforts to devising treatment methods. In this Mr. Thomson feels that he and his assistants have been successful, having made a series of exhaustive tests in the college laboratories. While this investigation has not been carried far enough, as yet, to justify final conclusions or specific recommendations, it is evident that local treatment can be provided that will yield satisfactory results. The choice so far appears to lie between a light chloridizing roast, followed by cyanidation after water-wash, and flotation concentration of all the ore, after crushing to 80-mesh. Each of these methods shows an extraction by laboratory test of approximately 90% of the silver and a large proportion of the copper. The flotation method, of course, yields a concentrate which must be either shipped to smelter or treated further at the mine. It seems probable that an application of the light chloridizing roast with water-wash, followed by cyanidation, which has proved successful with the ore, might be applied to the flotation concentrate with equal or greater success. This point will shortly be investigated.

SPokane County

Mining companies operating in regions tributary to Spokane paid a total of \$10,560,060 in dividends last year, making \$83,285,455 to date.

Stevens County

Negotiations are pending for a lease and bond on the properties of the American Tungsten Consolidated Corporation, 25 miles west of Springdale, and about 50 miles north-west of Spokane, by Eastern interests, represented by Fletcher T. Hamshaw of Seattle. It is thought the deal will be closed shortly. Men and supplies are now being sent into the camp to prepare accommodations for a crew of 100 men, who will be at work, it is thought, in the next 30 to 60 days. The mill was dismantled several months ago, but it is said that the building is in good condition to receive new equipment that is reported to have been ordered, and that the installation will be completed within 30 days, provided the heavy machinery can be transported to the property. Ten four-horse teams have been secured to haul ore from the mine, and that until the mill is ready to operate crude shipments will be made regularly. Not less than a car daily will be forwarded to the smelters, beginning about January 10. The workings consisting principally of three adits, aggregating about 3000 ft., are said to have exposed a considerable quantity of ore.

WISCONSIN

Grant County

(Special Correspondence.)—At Hazel Green the McMillan Zinc Co. is down 140 ft. in ore. An initial shipment of hand-cobbed ore will be made before January 1. A complete separating-plant is nearing completion.—The Monmouth Zinc Mining Co. has a 7 by 11-ft. shaft well under way. Mechanics have begun construction of the main power and mine plant, to be ready by March 1.—Regular weekly shipments continue from the Kennedy, Cleveland, and Lawrence mines. Several tracts have been drilled out with success.

At Platteville the Wisconsin Zinc Co.'s Empire roasting-plant, after continuous operation for six years, will be closed on January 1 and the plant removed. The Klar-Piquette mine, at one time paying 350% dividends per year, has resumed and is shipping heavily. Two dividends have been paid this year.—The West Hill Mining Co., with a small capital, has paid 150% in dividends this year. Local interests have carried the brunt of new mine development and equipment in this district

in the past year. Tremendous strides have been made in this field, as is shown by the number of new plants completed recently, namely, 32, with a total capacity of 6825 tons.

The National Separating Works at Cuba is running at high capacity, regularly treating 700 to 800 tons of crude ore per week. Shipments of 61% ore are made at the rate of 8 to 11 cars.

Platteville, December 22, 1915.

IOWA COUNTY

(Special Correspondence.)—The Highland district, well known for extensive deposits of carbonate of zinc ore, is languishing for want of a demand for the product. Thousands of tons of ore ready for shipment are held.

The New Jersey Zinc Co. is preparing to mine new deposits of blende on the Kennedy farm. A new two-compartment shaft is nearing ore. A 250-ton power and milling-plant will be provided this winter. Electric power recently available in this district, gives an incentive to extend operations.

The Linden Separating Works is making the highest-grade product of the field, namely, 62%.

The new acid department of the New Jersey Zinc Co.'s plant is returning one 25-ton tank car of commercial sulphuric acid per 24 hours. The supply is consigned to the Atlas Powder Works, at Senter, Michigan. The New Jersey Zinc Co. has begun the construction of a new zinc-ore roasting and separating-plant of 150-ton capacity. The present equipment is inadequate. Five Mathey hearths are now at work on ores mined from the New Jersey company's mines in this field.

The Peacock Mining Co., operating the Peacock mines in the Mifflin district, has paid to shareholders of record for 1915, 75% in dividends.

Eastern mining syndicates have representatives in this district reporting on leaseholds and fees available for zinc-mining. This district, practically eliminated from mining reports early in the year, has jumped into second place, shipping from 20 to 30 cars of zinc ore per week. Milwaukee capital is heavily interested. The Coker mines, owned by the New Jersey Zinc Co., continue weekly shipments of from 10 to 15 cars.

Mineral Point, December 22, 1915.

LAFAYETTE COUNTY

(Special Correspondence.)—The high-water mark has been reached at Benton in producing 50 cars of crude ore in a week.

The Fields Mining & Milling Co. has installed new crushing machinery, facilitating the handling of 750 tons of mill-rock, each 20-hour mill run.

The Vinegar Hill Zinc Co. has a new shaft in ore on the Blackstone lease of 160 acres and a new plant will be started on January 15.

Local interests, including four of the leading mining operators of the district, have a road-building project under way, to give all outlying producers track facilities during all seasons. The C. & N. W. R. Co. offers to contribute \$20,000 if mining men will pledge their traffic in return for this aid.

Benton, December 22, 1915.

CANADA

BRITISH COLUMBIA

(Special Correspondence.)—In the Windermere district of north-east Kootenay, Burgess & Co., who last summer bonded the Lead Queen claims situated on No. 3 creek, has just finished building 14 miles of sleigh-road, and about $\frac{3}{4}$ mile of rawhide trail to the mine, and is preparing to ship ore. The first 100 tons will be on the way before the end of the year, after which a steady production will be kept up; the expectation of the bond-owners is to ship at least 100 tons per week during the winter. There is a large tonnage opened in the mine, assaying well in lead and silver.

Negotiations were on foot earlier in the year to re-open the Paradise mine, but they have not yet materialized. This mine shipped approximately 2000 tons of lead carbonate ore

of high lead value and good silver content, some 10 years ago. There is a lot of second class ore assaying from 20 to 30% lead and 20 to 30 oz. of silver, on the dump. The above ore was chiefly taken out in development, and in the mine there is a correspondingly large amount of both first and second class ore blocked out. Transportation difficulties, owing to lack of railways and inefficient boat service only in the summer months, caused the shutting down of the mine at that time. The building of the Kootenay Central railway through the upper Columbia and Kootenay valleys has done away with these hindrances, and will enable the mine as well as many others in the district to make fine profits. Lack of capital to open them is the drawback at present, and here is a good field for the investor. The ores are chiefly lead-silver, with some copper in the form of tetrahedrite.

Wilmer, December 22, 1915.

The Standard Silver-Lead company's profit in November was \$99,929, from a revenue of \$136,278. The balance on November 30 was \$336,397.

The Slocan Star company will probably issue \$100,000 7% bonds to finance improvements at the property. An aerial train 1000 ft. long, from the mill to Sandon, is to be ordered.

The Tonopah Belmont Development Co. of Nevada has decided to complete its option on the Surf Inlet mine on Princess Royal island. A hydro-electric plant, 250-ton mill, and other machinery is to be erected.

In the January 1, 1916, issue of the *Journal of Electricity, Power, and Gas*, San Francisco, is a condensed report on the water-power plants of the Province taken from the original by G. R. G. Conway for the Dominion government. The Province has a superficial area of 372,649 sq. miles. The drainage from the mountains and highlands is received in numerous lakes, their surplus water flowing to the sea by several large rivers or their tributaries. The principal rivers are the Columbia, Fraser, Liard, Peace, Skeena, and Stikine. Development of water-power on a fairly large scale began in 1897. The present capacity of 16 large and several small concerns is 230,000 hp. Those supplying the mining industry have an output of about 50,000 hp., the Britannia, Canadian Colborne, City of Nelson, Granby, Hedley, and West Kootenay.

MEXICO

El Oro

Esperanza Limited has issued a report for the period July 1 to September 30. Development amounted to 921 ft. Milling work has not been resumed, as there has been no improvement in the political situation. El Oro is still cut off from the outside world, as there is neither railroad nor telegraphic communication. During the quarter several suspensions of power occurred, caused by troops of the opposite party from that which might be occupying El Oro at the time. In September the mine was without power for two weeks at one time. In August, acting upon a peremptory order from the Governor of the State, all wages payable in Mexican currency were increased 50%. This order was absolutely uncalled for, as there had been no difficulty over wages—on the contrary, arrangements had been completed whereby the workmen should receive increased pay, and be furnished with the most common of foodstuffs at cost. At the end of the quarter 90% of weekly pay-rolls is being given to the laborers in food, as there is no food in the camp aside from that brought in by the mining companies.

Later advices from the mine state that "the local as well as the general political situation has 'cleared up' remarkably during the past month. Trains are now running daily between El Oro and Mexico City and mail and food supplies are coming in."

DURING DECEMBER the San Francisco Mint received 259,572.383 oz. gold, and 65,886.43 oz. silver. Coinage executed was worth \$2,199,690.

PERSONAL

ROBERT E. CRANSTON is at Butte.

S. A. JONES was at Spokane this week.

CHARLES E. KNOX was in New York recently.

BEN W. TRAYER sails for Chile on January 15.

WILHELM SAMMIS is at Thermopolis, Wyoming.

JOHN H. BAKER of Phoenix is at the Palace Hotel.

CHAS. A. O'CONNELL is at Santa Barbara, California.

ARTHUR R. WEGGALL and H. R. BOSTWICK are at Denver.

F. R. WEEKS has returned to New York from California.

R. M. RAYMOND has returned from London to New York.

T. J. JONES has returned from Kyshtim, Siberia, to London.

RALPH ARNOLD has returned to Los Angeles from Venezuela.

LEO VON ROSENBERG recently visited the Ray district, Arizona.

ERNEST WILLIAMS is on his way from London to South America.

W. H. BASSETT is visiting the Miami and Inspiration mines in Arizona.

F. H. MASON has gone to San Diego with the Canadian mineral exhibit.

L. D. RICKETS sails from New York for South America on January 15.

A. N. MACKAY is now manager of the Frontino & Bolivia mines in Colombia.

W. J. LORING has returned from a visit to Angels, California, and opened an office in the Crocker building.

G. D. HURSHURG and M. N. ZIMBERG sailed from San Francisco on their return to Russia, on January 6.

HOYT S. GALE of the U. S. Geological Survey has gone to Chile and Peru on three months' leave of absence.

SUMNER S. SMITH, Federal mine inspector for Alaska, is visiting Washington, D. C., before returning to Juneau.

H. S. MULLIKEN has been appointed manager of the mines and smelter of the Peñoles company at Mapimi, Durango, Mexico.

GEORGE B. BUTTERWORTH, manager of the Whim Well copper mines in Western Australia, visited Anaconda on his way to London.

JAMES J. CARRIGAN, safety engineer for the Anaconda company, has been appointed assistant mining superintendent of the company's zinc mines at Butte.

GEORGE P. COFFEY, of Oakland, superintendent of hydraulicking for the Yukon Gold Co. at Dawson, Klondike, is at the St. Francis hospital recovering from an operation for appendicitis.

ALBERT G. WALKINS, for eight years a foreman at the Copper Queen property, Arizona, was killed underground on December 29.

JOHN T. WHITE, well known at Joplin, Missouri, died on December 30. He was well versed on the geology and mining of this region.

Bulletin 3, series 11, of the Mackay School of Mines at Reno, is the alumni number, with short addresses by the president, Archer W. Hendrick, Ellsworth R. Bennett, and F. C. Lincoln. The secondary mining schools at Virginia City at Tonopah are under the supervision of this institution. One hundred and thirty-six men have graduated from the Mackay school, of whom 10 have since died; of the remaining 126, more than one-half are in Nevada, one-quarter in California, and one-tenth in foreign countries.

THE METAL MARKET

METAL PRICES

San Francisco, January 6.

| | Cents per pound. |
|-------------------------------------|------------------|
| Antimony | 40 |
| Electrolytic copper | 25 |
| Pig lead | 6.00—6.95 |
| Quicksilver (per flask) | \$150 |
| Spelter | 20 |
| Tin | 45 |
| Zinc-dust, 100-kg. zinc-lined cases | 30 |

ORE PRICES

San Francisco, January 6.

| | |
|--|---------|
| Antimony: no change; 50% product, per unit | \$ 2 |
| Chrome: 52% chromic oxide and 2% silica, per ton | 12 |
| Magnesite: crude, according to quality and quantity, per ton, f.o.b. | 7.50—10 |
| Magnesite: plastic, no iron and lime, calcined, per ton | 50 |
| Magnesite: refractory, up to 7% iron, calcined, per ton | 30—40 |
| Manganese: 50% metal, 8% silica, per ton, f.o.b. cars, S. F. | 12 |
| Manganese: 80% metal, f.o.b. New York, per ton | 70 |
| Tungsten: minimum 65% WO ₃ , per unit for spot | 35—45 |

At Boulder, Colorado, on January 2, 60% tungsten ore realized \$45 per unit.

EASTERN METAL MARKET

(By wire from New York.)

NEW YORK, January 6.—Copper is very strong, with spot metal becoming scarce; lead is very strong and active; zinc is quiet and easier.

SILVER

Below are given the average New York quotations, in cents per ounce, of fine silver.

| Date | Average week ending |
|----------------|---------------------|
| Dec. 30 | 54.87 |
| " 31 | 55.00 |
| Jan. 1 Holiday | |
| " 2 Sunday | |
| " 3 | 55.87 |
| " 4 | 56.12 |
| " 5 | 56.50 |
| Nov. 24 | 52.35 |
| Dec. 1 | 56.27 |
| " 8 | 55.54 |
| " 15 | 55.66 |
| " 22 | 54.33 |
| " 29 | 54.05 |
| Jan. 5 | 55.67 |

Monthly averages.

| | 1914. | 1915. | | 1914. | 1915. |
|------|-------|-------|-------|-------|-------|
| Jan. | 57.58 | 48.85 | July | 54.90 | 47.52 |
| Feb. | 57.53 | 48.45 | Aug. | 54.35 | 47.11 |
| Mch. | 58.01 | 50.61 | Sept. | 53.75 | 48.77 |
| Apr. | 58.52 | 50.25 | Oct. | 51.12 | 49.40 |
| May | 58.21 | 49.87 | Nov. | 49.12 | 51.88 |
| June | 56.43 | 49.93 | Dec. | 49.27 | 55.34 |

A shipment from San Francisco to China last week was valued at \$240,000. Shipments from London to India and China to December 15 totaled £3,676,000, against £5,261,500 in 1911, a decrease of, say, 16,000,000 ounces.

The Jim Butler company reports \$163,388 on hand at 50c. per ounce.

COPPER

Prices of electrolytic in New York, in cents per pound.

| Date | Average week ending |
|----------------|---------------------|
| Dec. 30 | 22.37 |
| " 31 | 22.50 |
| Jan. 1 Holiday | |
| " 2 Sunday | |
| " 3 | 22.87 |
| " 4 | 23.00 |
| " 5 | 23.50 |
| Nov. 24 | 19.58 |
| Dec. 1 | 19.77 |
| " 8 | 19.60 |
| " 15 | 19.54 |
| " 22 | 20.06 |
| " 29 | 21.55 |
| Jan. 5 | 22.85 |

Monthly averages.

| | 1914. | 1915. | | 1914. | 1915. |
|------|-------|-------|-------|-------|-------|
| Jan. | 14.21 | 13.60 | July | 13.26 | 19.99 |
| Feb. | 11.46 | 11.38 | Aug. | 12.34 | 17.27 |
| Mch. | 11.11 | 14.80 | Sept. | 12.92 | 17.69 |
| Apr. | 14.19 | 16.64 | Oct. | 11.19 | 17.99 |
| May | 13.97 | 18.71 | Nov. | 11.75 | 18.88 |
| June | 13.60 | 19.75 | Dec. | 12.75 | 20.67 |

Exports during the week ended December 18 totaled 22,178,658 lb., valued at \$4,221,473. England secured 5,810,044 lb.; France, 12,118,729 lb.; Italy, 1,536,621 lb., and Russia, 1,904,550 lb. Imports amounted to 2,909,663 lb., worth \$441,174.

Anaconda output in December was 25,600,000 lb., an increase of 1,200,000 lb. over November; the 1915 total was 254,800,000 lb., against 223,720,292 pounds.

November returns were as follows: Chino, 6,939,006 lb.; Nevada Con., 5,495,487 lb.; Ray, 5,764,910 lb.; and Utah, 13,722,723 pounds.

LEAD

Lead is quoted in cents per pound, New York delivery.

| Date | Average week ending |
|----------------|---------------------|
| Dec. 30 | 5.10 |
| " 31 | 5.50 |
| Jan. 1 Holiday | |
| " 2 Sunday | |
| " 3 | 5.50 |
| " 4 | 5.75 |
| " 5 | 5.75 |
| Nov. 24 | 5.25 |
| Dec. 1 | 5.25 |
| " 8 | 5.25 |
| " 15 | 5.30 |
| " 22 | 5.40 |
| " 29 | 5.40 |
| Jan. 5 | 5.58 |

Monthly averages.

| | 1914. | 1915. | | 1914. | 1915. |
|------|-------|-------|-------|-------|-------|
| Jan. | 4.11 | 3.73 | July | 3.80 | 5.59 |
| Feb. | 4.02 | 3.83 | Aug. | 3.86 | 4.67 |
| Mch. | 3.91 | 4.04 | Sept. | 3.82 | 4.62 |
| Apr. | 3.86 | 4.21 | Oct. | 3.60 | 4.62 |
| May | 3.90 | 4.21 | Nov. | 3.68 | 5.15 |
| June | 3.90 | 5.75 | Dec. | 3.80 | 5.31 |

On January 1 the Bunker Hill & Sullivan paid dividend No. 221, of \$81,750.

QUICKSILVER

The primary market for quicksilver is San Francisco, California being the largest producer. The price is fixed in the open market, according to quantity. Prices, in dollars per flask of 75 pounds:

| Date | Week ending |
|---------|-------------|
| Dec. 8 | 115.00 |
| " 15 | 130.00 |
| Dec. 22 | 130.00 |
| " 29 | 135.00 |
| Jan. 5 | 150.00 |

Monthly averages.

| | 1914. | 1915. | | 1914. | 1915. |
|------|-------|-------|-------|-------|--------|
| Jan. | 39.25 | 51.90 | July | 37.50 | 95.09 |
| Feb. | 39.00 | 60.00 | Aug. | 80.00 | 93.75 |
| Mch. | 39.00 | 78.00 | Sept. | 76.25 | 91.00 |
| Apr. | 38.90 | 77.50 | Oct. | 53.00 | 92.90 |
| May | 39.00 | 75.00 | Nov. | 55.00 | 101.50 |
| June | 38.60 | 90.00 | Dec. | 53.10 | 123.00 |

ZINC

Zinc is quoted as spelter, standard Western brands, New York delivery, in cents per pound.

| Date | Average week ending |
|----------------|---------------------|
| Dec. 30 | 17.50 |
| " 31 | 17.50 |
| Jan. 1 Holiday | |
| " 2 Sunday | |
| " 3 | 17.50 |
| " 4 | 17.30 |
| " 5 | 17.30 |
| Nov. 24 | 18.58 |
| Dec. 1 | 18.52 |
| " 8 | 18.83 |
| " 15 | 16.04 |
| " 22 | 17.50 |
| " 29 | 17.41 |
| Jan. 5 | 17.42 |

Monthly averages.

| | 1914. | 1915. | | 1914. | 1915. |
|------|-------|-------|-------|-------|-------|
| Jan. | 5.14 | 6.30 | July | 4.75 | 20.54 |
| Feb. | 5.22 | 9.05 | Aug. | 4.75 | 11.17 |
| Mch. | 5.12 | 8.40 | Sept. | 5.16 | 14.11 |
| Apr. | 4.98 | 9.78 | Oct. | 4.75 | 14.05 |
| May | 4.91 | 17.03 | Nov. | 5.01 | 17.20 |
| June | 4.84 | 22.20 | Dec. | 5.40 | 16.75 |

The New Jersey Zinc Co. is now producing 20% of the country's spelter. A dividend of 4% and an extra of 16% has been declared.

TIN

Prices in New York, in cents per pound.

| Date | Average week ending |
|----------------|---------------------|
| Dec. 30 | 37.85 |
| " 31 | 34.40 |
| Jan. 1 Holiday | |
| " 2 Sunday | |
| " 3 | 37.23 |
| " 4 | 48.76 |
| " 5 | 48.25 |
| Nov. 24 | 33.10 |
| Dec. 1 | 33.10 |
| " 8 | 33.12 |
| " 15 | 33.10 |
| " 22 | 33.51 |
| " 29 | 33.50 |
| Jan. 5 | 33.60 |

Tin is strong at 44 cents.

ANTIMONY

Good inquiries have developed, some of which have culminated in business, and whereas the market was easy last week at 39 to 39.50c. duty paid, it is now strong at 39.50 to 40c. for Chinese and Japanese grades. Spot is scarce and higher prices are looked for, if the pressure of demand keeps up.

The revolution in China, especially in the antimony provinces of Hunan, may affect prices later on.

Eastern Metal Market

December 30, 1915.

Copper has held the centre of the stage, and so far as buying is concerned has outstripped all the other metals. The excitement started by Great Britain's big purchase of a week ago has been sustained until now. Zinc has not shared the activity, but is firm at last week's price. Lead is extremely strong, principally because of the heavy export demand. Tin quotations have changed but little, and most of its activity has been in futures. Antimony is higher and active. Aluminum has had a dull week and quotations are easier. Sheet copper is now quoted at 27c base. Early this week some of the independent brass mills withdrew quotations on their products. So winds up a year that has been a good one for the metal trade, but its prosperity has been based entirely on the War demand, although it is true that in the last few months domestic demand improved considerably. Copper exports of December made a good showing compared with previous months.

The congestion of foreign bound freight at the port of New York because of the lack of cargo space on trans-Atlantic vessels shows little improvement, although the French and English governments and their agents are straining themselves to get vessels here to relieve the situation. The steel mills are receiving fewer domestic specifications, one reason being that when last quarter contracts are concluded, new ones become effective which were placed at advances of several dollars a ton. Consumers who bought steel at 1.20c., Pitts. Burz. will henceforth have to pay 1.80c., or more. Many foundries in the East have been crippled by a shortage of coke, due to the railroad tie-up, and one blast-furnace has been blanked for the same reason. Tin-plate for export has been in heavy demand, especially from the Far East, and contracts for the year have been made on the basis of \$3.80 per box.

COPPER

The purchase of 120,000,000 lb. of copper a week ago by the British government not only caused great excitement, but started a rush of buying on both domestic and foreign account that is not yet ended. Domestic consumers have bought heavily for first and second-quarter delivery, and some of the large selling-agencies are now saying that they have but little metal to sell this side of April. It is understood that the order was shared by the United Metals Selling Co. and the American Smelting & Refining Co. Under the influence of this demand quotations have advanced from day to day, and sometimes from hour to hour. Electrolytic is now 22.25 to 22.50c., full terms. Lake is nominal at about the same figure, as none is to be had. That copper should reach its highest point in the last week of the year was unlooked for, and members of the trade are of the opinion that almost anything may be expected. Predictions that the price of copper will go to 25c. are commonly heard. Some of the independent brass mills withdrew prices on their products, Monday of this week, but sheet-copper is to be had at about 27c. base. Wire drawers and the brass mills have been more liberal purchasers of late than at any previous time in the year. After a three-day Christmas holiday at London the quotation there for electrolytic advanced £4 to £107, which is about equal to 22c. landed in England. On December 29, the London quotation went to £108. The exports of this month are the best since last March. Their total, up to December 30, was 29,694 tons, whereas in March they were 39,148 tons. There is more and more talk of a scarcity in copper, but as to the real likelihood of such a situation none but the producers know, as since

the dissolution of the Copper Producers' Association authoritative statistics are not available to the general public, or the buying public, for that matter. Whatever the state of stocks, the outlook is good for the trade. The National Conduit & Cable Co. says in 'Copper Gossip':

The pronounced expansion in American consumption of copper during the last half of this year established a new high record for domestic melting. This feature of the situation has created an unusually interesting and strong market. Manufacturers have been able to operate their plants to capacity recently. Urgent demand for manufactured material and shapes naturally created a big market for raw copper. With the consuming trade extraordinarily busy, the development of strength and activity in copper followed as a matter of course. And it is an encouraging fact that there are signs indicating substantial operations in manufacturing enterprise during 1916."

ZINC

This metal has not shared the excitement which has prevailed in copper, a fact which is rather contrary to precedent. One reason for this is the heavy buying of a few weeks ago, while another is that the holidays at London included Monday. About December 24 offerings became a little freer and the quotation for spot dropped a few points, but recovered after the Christmas holiday, and 17.50c., New York, again was quoted. Prompt metal continues scarce. The London market on December 28 and 29 was quoted at £90 for prompt. There is some good inquiry in this market for prompt and near-by, but consumers continue to hold themselves aloof from future deliveries. February is quoted at 16c., March at 15.50c., and second quarter at 11 to 11.25c. Exports from December 1 to 30 total 5691 tons. Sheet-zinc, in carload lots, is unchanged at 22c. f. o. b. mill, 8% off for cash.

LEAD

There is little to say about lead, save that prices are strong, and predictions of an advance are heard on all sides. It has been repeatedly observed, however, that lead prices often move just the opposite of what is expected. At the same time there can be no question as to the strength of the market, inasmuch as independents are getting from 2 1/2 to 5 points over the quotations of the leading interest, which continue at 5.40c., New York, and 5.32 1/2c., St. Louis. The London market has been quiet because of the holidays, but is strong at £29 10s. Resale lots have pretty well disappeared from the market. Exports continue a strong phase of the situation, as evidenced by an offer of 5.50c., New York, for 500 tons for January export shipment, an offer which was turned down. Exports would be heavier were it not for the scarcity and high cost of ocean freight-space. Conditions have reached a point where only the allied governments can be half way certain of getting freight room. With them it is a necessity. Exports to date this month total 6651 tons.

TIN

Business of late has been almost entirely in tin afloat or shipment from the Far East. On various days trading aggregated from 150 to 300 tons, all in futures. Sellers are few. It is a question to what extent Great Britain will permit direct shipment to America from the Far East. Its restrictions of a few months ago indicated that it intended to keep a strong hand on the supply, and already reports are current that it may cut down tonnages intended for direct shipment, preferring that shipment be made by way of London. The spot quotation on December 29 was 39.50c. The quantity afloat on the 30th was 5618 tons, and up to that day 3922 tons had arrived.

Metal Production in 1915

The U. S. Geological Survey has issued its preliminary statements regarding the mineral output of certain states, from which the following is abstracted:

CALIFORNIA

California mines show a materially increased output in gold, silver, copper, lead, and zinc in 1915, compared with 1914, according to preliminary figures compiled by Charles G. Yale. The mine figures for 1914 were \$20,653,496 in gold, and 1,471,859 fine oz. silver; the estimates for 1915 indicate an output of \$22,860,590 in gold and 1,974,529 oz. silver. California remains the premier gold-producing State of the country. The yield for 1915 is, with one exception, the largest in any year for 51 years, and is the largest for 32 years. There are about 700 producing metal mines in the State, about evenly divided between deep and placer mines of various kinds. About 2,500,000 tons of ore is mined and treated in the State annually of an average value in all metals of \$6.75 per ton. In value of all metals produced, Shasta is the leading county, while in value of gold output, Nevada, Amador, Yuba, and Sacramento are the leading counties in the order named.

Dredges are producing 86% of the placer gold. During 1915 there were 67 boats in operation and 60 at the end of the year.

The yield of copper was 44,098,552 lb., compared with 30,507,692 lb. in 1914.

The mine output of lead in 1914 was 4,251,923 lb.; in 1915 it is estimated at 6,346,319 lb.. Most of this is derived from the southern counties of the State, particularly Inyo county.

The zinc output is 11,443,926 lb. against 389,471 lb. in 1914, an increase of 11,054,455 lb. This is the largest production of this metal ever made in California in one year. The greater proportion was derived from Shasta county, where one of the large copper smelters has installed a zinc-sorting plant. Inyo county was also a large contributor to the zinc output of the State.

OREGON

Preliminary estimates made by Charles G. Yale show material increases over the figures of 1914, in both gold and copper, and nominal decreases in yield of silver and lead. The gold yield for 1915 was \$1,771,618, an increase of \$180,157. The silver output was 136,033 oz., or 6519 oz. less. The yield of copper was 910,104 lb., an increase of 870,856 lb.; and the yield of lead was 6650 lb., or 9786 lb. less than in 1914.

It is noteworthy that such material increases in output of gold and copper should be apparent when the fact is considered that the number of producing mines in Oregon has fallen off fully one-third in the past two years. Baker county continues to be by far the most productive county of the State, yielding annually fully 85% of all the gold. Of the placer mines in Oregon, by far the most important enterprise is that of the Powder River Dredge Company, Cracker Creek district, Baker county. This company, which owned but one dredge in 1914, put another one in operation in the same field in 1915, and it is to the work of this company that the increase in gold yield in the State for the year is mainly due.

UTAH

Mines in Utah produced gold, silver, copper, lead, and zinc in 1915 amounting in value to \$55,000,000, as estimated by V. C. Heikes. This represents an increase over the production in 1914 of nearly 50%, or \$18,000,000. There was a considerable increase in all the metals. About one-fourth more ore was mined, increasing the total from 8,544,014 tons in 1914 to about 10,725,000 tons in 1915. About 9,900,000 tons was produced at Bingham, an increase from 7,800,661 tons in 1914.

The bulk of this ore was mined at the Utah and Ohio copper properties, which yielded about 9,000,000 tons of low-grade ore in 1915. Other mines that contributed large quantities of ore were the Utah Consolidated, Utah Apex, United States, Bingham, Bingham New Haven, and Utah Metal mines. The Tintic district produced about 290,000 tons, against 298,486 tons in 1914. The main ore producers were the Chief Consolidated, Iron Blossom, Centennial Eureka, Eagle & Blue Bell, Mammoth, Gemini, Grand Central, and May Day mines. The 100-ton concentration mill, built primarily to treat Chief Consolidated ores, did considerable custom work.

In the Park City region about 99,795 tons of crude ore and concentrates was shipped, against 66,736 tons in 1914. Improvements in concentration methods resulted in large shipments of lead and zinc concentrate from the Daly-Judge, Daly West, and Silver King Coalition mills.

The mine output of gold increased over 19%, from \$3,265,347 in 1914 to \$3,908,000 in 1915. Copper ores yielded the larger part of the gold but large quantities also came from lead ore and silicious ore.

The mine production of silver increased from 11,154,916 oz. in 1914 to approximately 12,724,000 oz. in 1915, the increase amounting to 14% in quantity and about \$169,000 in value. Much of the silver is derived from lead ore, and smaller quantities from the copper and silicious ores.

The copper output from Utah mines increased from 152,034,002 lb. in 1914 to about 182,589,000 lb. in 1915, the increase amounting to more than 20% in quantity and about \$11,450,000 in value. The gain was made mostly by the Utah Copper mine at Bingham, which is credited with an increase of 34,207,552 lb. over the output of 1914.

The mine production of lead increased from 171,323,137 lb. in 1914 to 219,098,000 lb. in 1915, or about 28%, mostly from the Bingham district.

With the advance in prices, zinc ore was offered from many sources. The mine production of zinc recoverable as spelter aggregated 22,643,000 lb., valued at about \$3,224,000. This is an increase of about 41% in quantity over the output of 1914, amounting to 15,989,267 lb.

All the smelting establishments were operating at full capacity soon after the first of the year. These were the Murray, Midvale, International, and Garfield plants.

Dividends amounting to about \$9,000,000 were distributed by Utah mining companies in 1915 and \$7,431,017 in 1914.

PETROLEUM

Preliminary estimates of the total yield of petroleum for 1915 indicate a slight increase over the record-breaking yield in 1914. This condition does not agree with the currently reported reason for the exceptionally high prices now prevailing for motor fuel.

As a result of the over-load put on the transporting and refining phases of the petroleum industry by the excess output of crude petroleum in 1914, the year 1915 may be characterized as a period of re-adjustment, in which production activity was purposely retarded as far as practicable. The small increase therefore is more significant than the simple figures suggest.

According to John D. Northrop the marketed production of petroleum in the United States in 1915 approximated 267,400,000 bbl., and the total yield approximated 291,400,000 bbl., about 24,000,000 bbl. of oil brought to the surface during the year being placed in field storage by the producers.

The following table shows by States the marketed production of petroleum in 1914 and an estimate of the corresponding production in 1915 in barrels:

| State | 1915 | 1914 |
|---------------|-------------|-------------|
| California | 89,000,000 | 99,775,327 |
| Oklahoma | 80,000,000 | 73,631,724 |
| Texas | 26,000,000 | 20,068,181 |
| Illinois | 18,500,000 | 21,219,749 |
| Louisiana | 18,500,000 | 14,309,135 |
| West Virginia | 9,000,000 | 9,680,033 |
| Pennsylvania | 8,700,000 | 8,170,335 |
| Ohio | 7,000,000 | 8,536,352 |
| Wyoming | 4,200,000 | 3,560,375 |
| Kansas | 3,000,000 | 3,103,585 |
| Indiana | 1,000,000 | 1,335,156 |
| New York | 900,000 | 928,974 |
| Kentucky | 450,000 | 592,411 |
| Colorado | 200,000 | 222,773 |
| Other States | 50,000 | 7,792 |
| | 267,100,000 | 265,762,535 |

The apparent increase in the quantity of marketed production in 1915 is accounted for by the continued output of oil in large quantities from the Cushing field, Oklahoma, during the first half of the year, and from the Humble pool, Texas, during the entire year, as well as by the discovery and rapid development of new pools in Louisiana and Texas.

The stocks of crude petroleum held by pipeline companies at the end of 1915, amounted to approximately 195,000,000 bbl. including the oil retained in storage by certain oil companies that conducted a pipeline business at the beginning of the year, but which business was taken over and later conducted by separate pipeline companies. This reserve is approximately 50,000,000 bbl. greater than at the end of 1914.

Prices of crude petroleum at the wells were uniformly low in all fields from January to August, when the permanent decline of the Cushing field resulted in an increased demand for oil produced in other parts of the country, with a consequent advance in the scale of prices warranted. From the low level of \$1.35 a barrel maintained from April 3 to August 14, 'Pennsylvania grade,' the market standard, advanced steadily during the last third of the year, reaching \$2 on November 18, and \$2.15 on December 17 and disclosed a strength which indicates a rapid return to the \$2.50 level attained before the advent of Cushing. 'Kansas and Oklahoma' grade recorded an even more rapid recovery. From its low level of 40 cents maintained from February 15 to August 2, this grade advanced to \$1.20 in a little more than four months passing its former high level of \$1.02 on December 13, and attaining the price above quoted on the following day. California grades were fairly steady throughout the year, a 5-cent cut affecting heavy oils in the Valley fields on June 7, and a corresponding advance affecting the same grade of oil on October 26, followed by a general advance of 2½ to 5 cents on all grades except Ventura county and Santa Maria effective November 20.

Throughout the country as a whole, drilling activity was at a low ebb in all the developed fields until late in the year when the advancing market proved an incentive for a moderate amount of new work. The Cushing field, Okla., and the newer pools discovered as the result of wildcat drilling, during the year sustained a marked activity which was due to the conditions of local competition rather than to any justification expressed by the oil market.

ANTHRACITE production of Pennsylvania was 2,000,000 tons less than in 1914; shipments totaled 66,382,218 tons.

SULPHURIC ACID showed a large increase, 25%, the quantity being 4,007,000 tons of 50% acid.

IRON-ORE SHIPMENTS were 55,000,000 tons, against 39,714,280 tons. Portland cement increased 6.1% to 86,524,500 barrels.

Commercial Paragraphs

The SEARS CONCENTRATOR Co., San Francisco, has recently issued a pamphlet descriptive of its new pan-molton baten amalgamator, giving instances of its application to placer and quartz mining.

With a cover illustrating the action of oil flotation in a tank, the DENVER FINE CLAY Co. in Bulletin No. 150 briefly describes the process, and the Case laboratory flotation machine. A leaflet shows the Case oil-fired forge for drill-steel.

A LESCHEN & SONS Rope Co., St. Louis, send us the following. The Moctezuma Copper Co. has recently completed at Nacozari, Sonora, Mexico, the installation of a Leschen heavy-duty friction-grip aerial tramway. This is used for the disposal of tailing from the mill, it being 'wasted' along the line. The tramway is so arranged that the carriers pass around the outer terminal without detaching, so no labor is required at this point. The track ropes are 1½ and 1 in. locked coil, and the traction-rope ¾-in. diameter of the patent flattened-strand construction. The capacity of this tramway is 50 tons of tailing per hour.—The United Verde Extension Mining Co., Jerome, Arizona, is installing a Leschen heavy-duty friction-grip aerial tramway for carrying its ore from the mine to the railroad. The line will be about 1000 ft. long, having a fall in this distance of about 600 ft. This tramway will have a capacity of 50 tons per hour. The carriers are of 10-cu. ft. capacity, and run when loaded on a 1½-in. diameter locked-coil track rope, and return on a track rope 1-in. diameter of the same construction. The traction-rope is ¾-in. diameter of the patent flattened-strand construction.

The ROSSLER & HASSLACHER CHEMICAL Co., 100 William street, New York, has issued the following circular, entitled 'Cyanide': "Beginning January 1, 1916, we shall change the designations of our various grades of cyanide, basing same on sodium cyanide content. When the cyanides now in the market superseded potassium cyanide, the various grades of sodium cyanide were designated by their equivalents in potassium cyanide, in order to show their comparative strengths. Potassium cyanide 95-96% contains 38% cyanogen. Thus sodium cyanide containing 51-52% cyanogen was designated as 129%, that being its equivalent in potassium cyanide. Owing to its lower cost, sodium cyanide has now entirely replaced potassium cyanide in the recovery of precious metals, in fumigation, plating, etc., the results being equal if not superior to those obtained by the use of potassium cyanide. The lower cost of transportation is also an element of saving because of the greater cyanogen content of pure sodium cyanide. As potassium cyanide is no longer used, and the change to sodium cyanide fully understood, a re-naming of the different grades of cyanide is advisable. We shall label and sell sodium cyanide as such, and with the following we illustrate the change from the old to the new style of labeling and billing, and refer to the last page of the December issue of our price-list as to the actual wording of our labels:

| Old designation. | Cyanogen content for both. | New designation. |
|--|----------------------------|--|
| Sodium cyanide..... 129% | 51-52% | Sodium cyanide 95-96% |
| Cyanide chloride mixture..... 98-99% | 39-40% | Cyanide chloride mixture..... 73-76% |
| Cyanide chloride—carbonate mixture..... 28-30% | 11-12% | Cyanide chloride—carbonate mixture No. 1 |
| Cyanide chloride—carbonate mixture..... 35-40% | 15-16% | Cyanide chloride—carbonate mixture No. 2 |
| Cyanide chloride—carbonate mixture..... 45-50% | 19-20% | Cyanide chloride—carbonate mixture No. 3 |
| Cyanide chloride—carbonate mixture..... 55-60% | 23-24% | Cyanide chloride—carbonate mixture No. 4 |

"We wish to emphasize particularly that we have not changed the composition of our products in any respect. The change is solely in the designation."



EDITORIAL



T. A. RICKARD, *Editor*

EXPORTS of copper continue heavy. Our New York correspondent reports that the market exhibits signs of strong support. Foreign demand persists with extraordinary vigor. Zinc is strong in sympathy and antimony is reported to be scarce. Lead also is strong, mainly on foreign account.

LITIGATION between the North Star and Empire mines at Grass Valley is likely to be avoided by a compromise, the particulars of which we hope to publish at an early date. The peaceful settlement of this intricate conflict of mineral rights does credit to the parties concerned and furnishes a good example to other mining companies in difficulty over their title by reason of an ambiguous law.

PPROMOTION has caused Mr. H. M. Wolfen to leave San Francisco, in order to assume the duties of his new post at Pittsburg. We have heard many expressions of regret that he should have left this community, where he won the respect and confidence of those engaged in mining while acting for the U. S. Bureau of Mines on the Industrial Accident Commission. Mr. Wolfen had a difficult duty to perform and he performed it with a sincerity that commanded esteem.

ACCORDING to telegraphic dispatches, the striking miners of the three copper companies in the Clifton-Morenci district have withdrawn from the Western Federation of Miners at the insistent demand of the managements of these three mines. The men have applied for membership in the Arizona State Federation of Labor as a local union. This organization is affiliated with the American Federation of Labor. The concession thus made to the demand of the companies is credited to Mr. John L. Donnelly, of the executive board of the Arizona State Federation of Labor. Mr. Donnelly is to be congratulated on his public service. We hope that the incident presages further concessions and a speedy settlement of the dispute.

MINE transfers in California are being recorded with interesting frequency. The South American Mines Co., as related in our Mining Summary last week, has exercised its option on the Poison Oak mine in Tuolumne county, on the advice of Mr. J. W. Mercer. Another important deal is that whereby the old Eureka mine, in Amador county, passes from Mrs. Hettie Green to a group of mining men in New York. These strokes of business coincide with several highly satisfactory de-

velopments in deep mining on the Mother Lode. In the Kennedy mine a magnificent body of ore has been disclosed below the 3750-ft. level, and the Argonaut has been so successful in its deepest development work that a large hoist is to be erected at the 4200-ft. station of the incline shaft in order to continue systematic exploration downward.

ROBERT M. RAYMOND has been appointed Professor of Mining in the School of Mines, Columbia University, filling the vacancy created by the retirement of Mr. Henry S. Munroe. This appointment will excite keen interest and pleasure not only among the sons of Columbia but in the mining profession generally. Himself a graduate from the School to which he now goes as a professor, Mr. Raymond has had a wide, successful, and honorable experience not only in this country, but in Australia, Rhodesia, China, and Mexico. Born a Canadian, he became naturalized as an American in early manhood, thus coming back to the fold from which a progenitor strayed at the time of the Revolution. During recent years he has been manager and consulting engineer successively for the group of mines controlled by the Exploration Company, of London, in Mexico. Thus he brings thirty years of observation and experience to the lecture-room on Morningside Heights. And he has other qualifications fully as important. His soldierly poise and straight glance indicate a sincerity of purpose and directness of thought that will exert that moral influence without which the mere lecturer cannot be a real teacher. At a time when several professorships of mining are vacant and suitable selections are notoriously difficult to make, we congratulate our friends at Columbia on a choice so sagacious. We wish Professor Raymond every success in his new departure.

FORECASTS are more interesting than retrospects; perhaps on account of their hazard. The early days of this new year have brought us many opinions as to the future course of business and industry in the United States. One psychological fact is noteworthy: all the vaticinations assume the proximate ending of the War. The problem of the quidnuncs is as to what will happen "after the War." That is not a little remarkable at a time when there is no visible slackening in the intensity of the European conflict. Among so many optimistic statements, the warning issued by Judge Gary is not unwelcome. Danger is always near when everybody unites in prophesying smooth things. It is well that it should be realized that no precedents exist for any confident prediction as to the sequel of Armageddon. Dis-

tory furnishes no standard. Even the Napoleonic debacle affords no adequate experience. Credit has been extended to the fourth dimension. The wastage of men and material is stupendous. Our own trade has undergone an expansion that is altogether abnormal. The landmarks are gone, we are sailing in uncharted seas. Therefore, we welcome the cautious tone of the memorandum published by the Secretary of Commerce and his insistence upon the need for better organization. The review issued by the National City Bank of New York likewise conveys some sound ideas, while emphasizing the check upon normal progress as the chief consequence of the War. To make real gains, the United States must use its productive powers and resources "with a new and extraordinary degree of coordination and efficiency." The *Analyst*, another sagacious observer, believes that the adoption of the Federal Reserve banking system came most opportunely, that the United States had just begun to look with increasing consciousness of power to business opportunities in foreign countries, and that the War has but accelerated that development. The wastage of war and the reconstruction in Europe will furnish an opportunity to the United States for extending help and so making a return for the assistance formerly given by the older countries in developing the natural resources of this country. In short, it is believed that the United States will emerge from the War period as a great creditor nation prepared to play the part that formerly centred at London, Paris, and Berlin.

Another Mexican Outrage

The latest performance of Mexican brigandage has created a keen feeling of resentment on the Pacific Coast, where the victims were well known and highly regarded. The demoralization of government on the south side of the Rio Grande has been brought home to the friends of Charles A. Pringle, W. J. Wallace, and the other Americans that have been killed under conditions of particular brutality. It appears that on January 10 a party of 19 men, including the staff of the Cusiuhiriachie Mining Company, operating in western Chihuahua, was on its way from the city of Chihuahua to the mines by rail when the train was attacked at Santa Ysabel by a force of bandits led by José Rodríguez. These ruffians are reported to have stripped their captives naked and then shot them. The train carried a stock of supplies and silver currency to be used in the resumption of mining operations. It is stated that the party was traveling under the military protection of the *de facto* Government. One man escaped, Mr. Thomas M. Holmes, and from him the details of the atrocity have been obtained. The Cusiuhiriachie company was one of the first to accept the promises of protection made by the Carranza government, and it remains to be seen what amount of responsibility is accepted by the Government and what steps are taken to catch the murderers. It is pitiable to read accounts of 'General' José Rodríguez, one of Villa's lieutenants. These military titles tend to cloak brutal

assassinations under the guise of warfare, giving them a dignity that is monstrous. We do not wonder that a number of mining men at El Paso sent a telegram to Washington, reading, "The massacre of fifteen more American citizens in Mexico shows the result of a watchful waiting policy." It may not be logical, but it is intelligible. The President may reply properly that the men thus killed took their own lives in their hands by going to the mines at this time and the American government cannot be held responsible for their unfortunate fate. But this will be poor solace to their friends and relatives, who had the idea that the recognition of the *de facto* Mexican government involved an obligation to protect American citizens in the conduct of peaceful business.

Mining Education

Three pronouncements on this subject have been made recently: by Mr. William B. Phillips, the new President of the Colorado School of Mines, by Mr. John R. Allen, Professor of Mechanical Engineering in the University of Michigan, and by Mr. Charles F. Willis, Director of the Arizona State Bureau of Mines. In these discussions of the subject there is an evident struggle between the broad idea of a training that shall develop an effective citizen and the narrower concept of a specialized instruction that shall fit a young man to win bread and butter, and eventually wealth, in the competitive arena of an industrial civilization. Even the least expansive of professors understands, however, that no mining school can graduate either mine managers or smelter superintendents. Professor Allen quotes a wise saying: "No engineer was ever educated in a university, but the university has given many a man an excellent opportunity to educate himself." The motto of the school to which the present writer went as a boy was a saying in Latin that can be translated: "We do not learn for school but for life." Professor Phillips expresses the same idea when he says that "the training in such highly specialized matters as mining, ore dressing, and metallurgy is largely of a prophetic nature." It is impossible to foresee what the technical requirements of the future may be. The teacher can only elucidate principles by means of methods and processes that may be discarded by the time the student has barely started on his career. Professor Willis recognizes the rapidity with which conditions have changed in mining and metallurgical practice; he complains that the schools have lagged behind, retaining curricula that are largely obsolete. The theoretical mining engineer of an earlier era is no longer wanted, the commercial element now dominates the technical, so that science without business insight is quite ineffective. As industry becomes organized on scientific lines, it calls for technically educated men for every position of responsibility; not the captains alone, but even the corporals, must be properly equipped. We conclude then that to be effective the education must not be too specialized; what is needed is not so much the civil,

mechanical, or mining engineer, but an engineer *tout simple*, ready to adapt himself to conditions as they arise and to train himself for opportunities as they become evident. The European criticism is that the American is superficial but imaginative; he lacks thoroughness, but he is rich in adaptability. Part of this characterization is acceptable; the question arises whether some of the deficiencies cannot be corrected. In this, as in many other matters, Europe and America go to extremes both of which are faulty. Yet, in the end, all the efforts to reconcile divergent ideals will fail. You cannot eat your cake and have it. One ideal must be sacrificed to the other. A sane compromise is the only practical solution. The man who pursues the shekel unremittingly must not complain if his appreciation of sundry other good things becomes atrophied, as Darwin found his taste for music left him when he concentrated his days to grinding generalizations out of facts. So also the man of generous mind and philosophic temperament must not be surprised if he does not become a forceful driver of men or a successful collector of coins of standard value. Each presumably finds his happiness and each his usefulness. The genuine product of each school is better than the simulation of either.

The foregoing may seem an unsatisfactory answer to the question at issue. No reply can be completely satisfactory. Our own observation of men has taught us that they are too varied in their natural gifts and defects to respond to the same system of culture. To learn anything thoroughly is a mental training, to half-learn a dozen things tends to enfeeble the mind. A sound knowledge of Greek is a better preparation for engineering than an unsound schooling in electricity.

We find ourselves in quick agreement with Professor Phillips in attributing defective technical training in large part to the lack of a thorough teaching in mathematics and English. The one contributes to logical thinking and the other to clear expression; they react on each other, so as to combine in developing good habits of mind. Of course, the growth of the reasoning faculty is stimulated and developed by mathematics, but good teachers of this subject are rare. A firm hold of mathematics is essential to the engineer in obtaining a sound grasp of mechanics, just as a thorough understanding of the principles of chemistry is requisite to the intelligent development of metallurgical skill. As for the acquisition of a knowledge of the language, we can hardly lay too much stress on the importance of a control of, rather than a facility in, the expression of scientific thought. To know the English, or any other, language thoroughly is a liberal education. Not to be able to command the vehicle of ideas is to be handicapped in acquiring information for ourselves, no less than in giving it to others. While yielding to none in recognizing the paramount importance of a scientific training, we realize that the emphasis placed on the sciences has tended to cause a neglect of adequate schooling in English, the result being not only a lack of skill in writing and speaking but a loss of ability in the acquirement of technical

knowledge. Much of what we learn comes to us in the form of the printed word, therefore the young man who has not learned thoroughly the language in which that printed word is given is handicapped in his effort to assimilate the knowledge that is provided by the literature of the period. The sooner it is acquired the better. It is the vehicle of thought in which all the other forces of written knowledge are conveyed.

Thus, the final conclusion is that no schooling is good that spoils sincerity of purpose. Inaccuracy of observation and statement is the dominant curse of a half-educated community and the mark of the half-baked engineer. No man can "see life sanely, see it whole" who deals in make-believe; none is worthy the name of engineer who has not learned that "there is no alleviation for the sufferings of mankind except veracity of thought and of action."

Individualism and Co-operation

The editorial under this title in our issue of December 4 has provoked an opinion as to the preservation of individuality in great organizations from no less a person than Mr. L. D. Ricketts himself. The ideas of a mine manager and consulting engineer of such wide experience on a subject so pertinent cannot help but be a matter of interest to both young and old members of the profession. Where is the corporation unit who does not at times chafe at the clumsy inertia of action and thought that characterizes large masses; in what mine staff or city office does not the question of the man versus the company play a constant and critical part? Yet all of us realize that co-operation is the secret of the success of American development in 'big business.' The specialization of useful effort, the co-ordination of unusual faculties, the utilization of spontaneous ability for the serving of the common good have come in this great undeveloped country to mean the binding together of diverse minds and varied capacities for an organization more than competent to compete on even terms with the industries of older and less well-paid peoples. We take pleasure in quoting herewith from the letter received from Dr. Ricketts, as he is generally known in the West: "In my opinion any organization that aims to prevent the expression of individuality will injure itself. My view-point is that an organization of large size requires a great many men in different capacities; that it is essential from top to bottom that a certain amount of personal effort be allowed to the employee, and that the more important the man the greater leeway should be allowed him. In taking up a study of a new process or the application of an experiment in commercial work, it has always been my practice to select a number of men, if necessary, to work out the details and the process. Each man should be given full swing, should be allowed credit for his work, and should be required to report his opinion. You must remember, however, that there are few men who have the qualities required for investigation and development, and at the same time possess

balance. As a consequence, someone with balance must review the work of the men under him, and, to the best of his ability, sort the practicable from the impracticable and see that the practicable points are developed, but if the work goes no further, both the investigator and the reviewer are apt to get in a rut so deep that they cannot see over the edge, and as a consequence other men must come in with fresh minds to discuss the problem, and throw side lights upon it. Then there must be someone with decision to adopt the plan and carry it out. I most thoroughly agree with you as to the tremendous importance of individualism and you appear to agree with me in the tremendous importance of organization and committee work. When, therefore, there are two view points there must be a compromise, and the only compromise is the value of an efficient organization balanced in size to compare with the magnitude of the operation. Where individualism is curbed to a slight extent, and the organization evolves a final plan, the result of individualism may be apparently concealed, but if a well matured practical plan is studied in detail in all its branches, the individualism is bound to become apparent."

The statement of Mr. Ricketts needs no embellishment. He believes in the practicability of organization; he also believes in the genius of individualism. As he states: "When there are two view-points, there must be a compromise." Any compromise to attain the greatest degree of success—as measured in all its aspects—must be a careful balancing of the discipline, helpfulness, and bigness of organization with the imagination, originality, and personality of individuals. Corporations are giants in strength and system, but they deteriorate rapidly when deprived of that ability to think which must be supplied to them by individual intellects subject to all the play of human character. The problem is to harmonize individualism and co-operation.

The Everson Myth

On another page we give the salient facts in the life of Mrs. Everson, as recorded in a letter from her son to a committee of the Colorado Scientific Society. Apparently a belated desire had been expressed at Denver to learn something concerning the Carrie J. Everson whose name has been so prominently identified with a famous flotation patent. The melancholy result was to discover that the lady, whose experimental work had been quoted freely in recent litigation, although neither litigant had dared to subpoena her as a witness, had died a year before the enquiry was set afoot. Another consequence is to shatter the romantic story of the alleged invention of the oil-flotation process. It was about time to ascertain the truth. We have been told that Carrie J. Everson of U. S. patent No. 348,157 was a Miss Everson, a school-teacher, the sister of an assayer, in whose laboratory at Denver she had discovered the flotative power of oil by washing some greasy ore-sacks containing concentrate, and that therefrom had resulted the invention of an epoch-making process for treating sulphide ores.

Indeed, one authoritative writer gave a final touch to the picture in these words: "When she had the greasy concentrate sacks in the wash tub and gave them such agitation as was incident to the operation of washing, it only required the customary neuteness of observation of the Western lady school-teacher to grasp the essential facts of sulphide flotation." Alas, our hold on those essential facts is slippery enough even 30 years after the date of the supposed discovery. The excellent lady herself proves to have been a Mrs. Everson, the wife of a Chicago doctor, with no brother assayer and no laboratory for washing ore-sacks or other scientific research. Several years after the patent had been obtained she became a nurse and later still, twenty years subsequent to the filing of that patent, she was for a short time a teacher in a school for girls. The romancist is welcome to that scrap of fact, even if it comes at the wrong place in the story. In short, Mrs. Everson was an intelligent earnest woman who happened to touch the fringe of a metallurgical enigma. We do not ridicule her, nor her effort to investigate a problem that remained entirely unsolved for many long years after she made her amateur experiments; but we permit ourselves a laugh at those who have exaggerated her ineffective attempt into a great invention, in order to belittle the work of real metallurgists and in order to destroy the originality of much later and far more scientific research. The Everson patent describes no workable process; it was forgotten until patent litigation brought it into fictitious prominence. Posthumous demonstrations of the prior art made in court do not impress the detached onlooker. If Mrs. Everson had never recorded her experiments the flotation process would have lost nothing. Flotation was not descended from her. That oil would adhere to metallic particles and float them was known to Herodotus, it has been a matter of encyclopedic information ever since. Mrs. Everson tried to apply the old fact to the concentration of ore, and failed. The flotation of today comes to us through the Elmore brothers, who got their idea from George Robson, at the Glasdir mine, in Wales; where Robson got his idea we do not know, but we hope to find out before the chapter is closed. No reason exists for believing that he got it from the U. S. patent records, for his method bore no resemblance to that of Carrie Everson. From the Elmore the flotation pedigree continues to Aleide Froment, who saw the Elmore bulk-oil process in Italy, and from Froment to H. L. Sulman and H. F. K. Picard. It is only the distortion of scientific vision created by the miasma of litigation that has caused the Everson patent to loom so large against the later investigations and developments of the process. One myth has been swept away; in course of time others may follow it, so that ultimately the scientific truth may stand out clear. Meanwhile we congratulate the Colorado Scientific Society on its course of action and hope that it will not abate in its intention to do honor to a woman who was an investigator, a nurse, a teacher, a good wife, and a devoted mother. That is more than being a bubble in the froth of litigation.



DISCUSSION

Our readers are invited to use this department for the discussion of technical and other matters pertaining to mining and metallurgy. The Editor welcomes the expression of views contrary to his own, believing that careful criticism is more valuable than casual compliment.

The Electrical Theory of Flotation

The Editor:

Sir—I have read with much interest Mr. Bains' article in your issue of the 27th ult. on this subject. I believe he is right in his theory and that electrification plays a very important part in the phenomena of the new metallurgy. The slime problem—the great difficulty mill-men attribute to 'colloids'—is a manifestation of the electrification of the particles causing them to form into flakes and to interfere profoundly with the effect of gravity as utilized in water-concentration methods. I have noticed that dry 'dust' classified by transportation in air is similarly affected and will retain large percentages of air in the mass and will 'run' on a slight grade.

Studying the effect of 'colloids' in gravity work on slime three years ago I noted that some force was causing the extremely fine particles to be attracted to each other with system, and in a manner to suggest that the phenomenon was due to electrification. I assumed, however, that the aluminous and earthy particles were the only ones charged, and that the crystalline sulphide particles which I was trying to separate from the mass were not subject to the queer behavior noted in the 'colloids.' In connection with an application for a patent on a 'colloid separator,' I wrote a description of what was to my mind happening, from which I quote:

By 'slime' is meant, for the purpose of this discussion, a mixture of water with ore and mineral so finely comminuted as to be impalpable. The losses (by gravity concentration) in these sizes are very largely caused by the fact that the slime contains a very large percentage of so-called 'colloids.' In the language of the mill metallurgist, 'colloids' is pulverized ore, affording a great deal of material that contains more than an ordinary amount of combined water, and when in an impalpable state apparently carries a static 'charge' and has the peculiar property of quickly forming into flakes, being then known as 'flocculent slime.'

When greatly diluted with water, that is, when the amount of 'solid' matter in suspension is a very small percentage of the whole and the mass is at the same time in a state of agitation, the formation of flakes is prevented. As the mass of water comes to a state of rest and the solids present begin to fall under the influence of gravity, the crystalloids (more or less cubical particles) go rapidly toward the bottom of the vessel. The colloidal, or clay-making 'solids' also commence to fall, and at the same time begin to migrate toward each other

and form themselves into flakes or strings, which behave in water much like fine feathers of fluffy down in air. While the flakes are widely separated the particles of non-electrified, non-hydrated, crystalline material fall readily in paths between them.

When the flakes have settled into a mass touching each other at their extremities, their movement under gravity is interfered with and when in this state they are no longer free-settling particles, but are a mass of flakes resting upon each other with clear water filling their interstices. When they fall farther the mass formation is condensed and the process is one of re-adjustment of the flakes among themselves, in which the water in their interstices is displaced, and on account of the greater degree of impediment as the mass becomes more dense, they require longer periods to fall a given distance or crowd into less space. Thus, each stage of the condensation or thickening process is a successively slower one and one which greatly embarrasses 'gravity' processes of separation.

When I take a long glass cylinder, say of 1½ in. diam., fill it with 100 to 500 slime-feed, as found in average mill conditions (in which all of the mass would pass a 240-mesh screen) and allow the cylinder to stand perpendicularly a short time for the slime to settle and commence the cycle referred to above, I find that by the time approximately 10% of the water is supernatant, that is, clear water on top of slime, then the colloids have migrated under this system of attraction and have become flakes large enough to be seen and have settled until they touch each other. Looking through the glass, I note that the water between the flakes is clear and that the process of re-arrangement among them in process of 'thickening' is visible. The passage of the water upward from among them is made instantly apparent by inclining the tube about 15°. Observing the upper side of the incline I find the water racing along the glass, in the path of least resistance, causing wavelets among the flakes and carrying them upward; and on the under side of the cylinder the movement is downward but in a more uniform manner, that is, a larger section of the mass is moving downward with less speed. When I reverse the inclination of the cylinder the direction of movement is reversed in a surprisingly short interval, with a very short period of rest before starting in the opposite direction. This demonstrates visually the action noted in the re-adjustment of the flakes mentioned, and demonstrates that the water is being squeezed, so to speak, out from

the interstices between the flakes as they re-arranged themselves in a more compact mass in the act of falling.

If I take a 'drop' of clean, water saturated, slimed sulphide, which I have previously separated from a similar mixture on a conventional 'slimer' and drop some of it from a glass rod into my cylinder, I can watch the sulphides pass downward through the mass. When the apertures between the flakes are large enough, a majority of the little black crystals are able to reach the bottom, but if I continue this from time to time as the mass thickens I find that the sulphide crystals are being arrested. The finer ones first begin to be held up and may be seen suspended upon the flakes even when the mass looks very thin and extremely fluid like. By the time the 'colloids' have excluded the water until the proportion in the mass is 100, 10, all sizes of the so-called 'slime sulphide' concentrate are held up on it like coal dust or sand supported upon down.

When the 'colloids' first begin to settle and combine into flakes they are feathery in appearance in the water, especially toward the surface of 'slime,' but as the mass becomes more dense and less free to move, it assumes a cream-like consistence. When I pour the clear water off from the top and the slime begins to also go over, the appearance by reflected light suggests cream or syrup and viscosity. In very fact I realize that I am dealing with fluid clay.

I think it is entirely obvious that the thickening of slimes in preparation for feeding on so-called 'sliming machines,' as now practised, is entirely wrong in principle. In the absence of the peculiar 'colloids' this would be quite correct and the results upon the machine would be what is intended, but we have the colloids all of the time in all ores—though in varying proportions—and this part of the tonnage is not only *not* amenable to the concentrating action of any machine or device used for water-concentration by the gravity method and cannot be concentrated by these machines, but it prevents the crystalline particles—which, when clean of colloids, are easily separated—from having a chance to reach the concentrating surface and be saved. We use pointed boxes, spitzkasten, Callow tanks, pulp-thickeners, etc., the object of which is to "thicken the feed," and these devices are admirably adapted to make material so dense that a concentrating unit may handle a larger and more satisfactory *tonnage* of it, but, for reasons that have been explained, the unit will concentrate the valuable portions with very poor success.

Here ends the quotation from my former notes.

Considering what Mr. Bains' experiments and experience have shown I now see that the whole mass of solids was 'charged' and that the effect was misunderstood as far as the coarse particle was concerned, because it was too large to 'migrate' and collect into masses governed by the 'charge,' but as the particles carrying the charge became finer they could migrate and assemble so as to become visible. The sulphide particles were not exempt from the influence as I had supposed. Their suspension in the mass of colloids was not a mechanical proposition

altogether or so much as it was one of attraction due to the charge of electricity present in the mass, and the superfine sulphide particle contained in the mass of flakes was just as much an electrically charged colloid as any other part of the mass, and that is where the main losses, the unavoidable losses, were, and where the apparently easy and most notable saving by flotation comes into play.

Now comes flotation with its peculiar and unexplained influence upon the colloid condition, and I am satisfied that the new theory points the way to a better understanding and realization of what is taking place in connection with the burden-carrying bubble. Oil evidently does not belong at the head of the class and has been enjoying a measure of popularity that does not belong to it. Verily, much is yet to be learned about how, and why, and what, is flotation.

I am sending herewith a small sample of Anaconda concentrate which seems to have peculiar properties. It is not a sample of the average concentrate of its size, but is a class of pyrite which selects itself out of the feed in passing over the table and floats off on the surface of the water. Note its relatively coarse size (20-mesh). It is plentiful at times and scarce at other times, evidently depending upon where the ore comes from for that day. It has not been oiled either purposely or by accident, but it will float persistently, as you will note if you put the dry material in a pan and allow a tongue or wedge of water to crawl under it. As soon as it is drained, the film of water will peel off from this material like it does from a duck's back and it advertises that it wants to float by doing so at every opportunity. This material won't stay drowned, and the question naturally arises as to what is peculiar about it and what can be learned by studying its peculiarities. I am sending some of it to Mr. Bains with a copy of this letter.

DAVID COLE.

El Paso, December 14, 1915.

Trade in South America

The Editor:

Sir—Your remarks on this subject are very good. You should enlarge upon it and while doing this, refer to some particular line of trade. It is not possible to say much in general terms without making mistakes.

I take it that your readers are more interested in the machinery trade with South America than with simply 'trade.' And the 'machinery trade' should be again limited to machinery trade other than agricultural. The reason for this is that there is no similarity between agricultural machinery business and mining, power, or nitrate machinery business.

Agricultural machinery is sold by big houses that give a year or two of credit, based on crops, which are in turn often contracted for when machinery purchases are made. This makes it difficult for the American manufacturer of agricultural machinery to retail for cash.

Electrical machinery is usually sold on long terms to

lighting and power companies by the European manufacturer that takes an interest in the business. I should say this *was* the way this business was done. None is being done in this line now.

Mining machinery is sold here, as in other parts of the world, for cash. There are occasional exceptions to this, but the results of giving time on mining sales are not such as to inspire imitation.

In other lines, such as shirts, shoes, and shelf goods in general, longer terms were granted by European houses than by American, but there are two ways of looking at this question of terms. The American manufacturer can either hold out for his terms of cash, or he can give away and allow credits, or he and his customer can compromise. If there was just one American manufacturer, this could be settled easily, but there are many, and American goods are appearing on the market, so the terms finally arranged must be satisfactory to both sides.

Personally, I think that the allowing of a special discount for cash is a better way for the buyer than giving him a long credit and covering it in the price; and apparently the buyer here thinks so also. Anyway, why should it be necessary for the American shipper to change his methods if they are better than the European, as he thinks?

Dollar exchange is appearing in the financial circles with much greater frequency, lately. The Braden and Chuquicamata companies try to obtain all the money required for their operations by selling 90-day New York exchange. So far their arrangements for doing this are not convenient. That is, it is easier for me to go to the bank and buy the exchange on New York than it is to call up the Braden Copper Co. at Rancagua, get a quotation, send them the money, and wait for the draft, even though their rate of exchange is better than that of the bank. It is stated that this condition will be changed, and then we will have an American bank to all intents and purposes, except as regards lending money.

I think you lay too much stress on the importance of speaking Spanish. We have, among the American colony, men who have been here a score of years without learning much about Spanish—and there are Englishmen who could be here centuries without learning the subjunctive any better than I have. Yet the Englishmen do most of the business in Chile. If the men sent to South America to do banking know banking the task of learning enough Spanish is only a question of a short time.

So far, any sales of New York drafts are based on the rate of exchange between pesos and pounds sterling. As soon as we have an exchange rate quoted in dollars, trading in New York exchange will be much easier. Not long ago the first sale of nitrate in dollars was effected in Valparaiso. Not long ago the first sale of tin concentrate was contracted in dollars. A number of locally represented American companies have given instructions that hereafter quotations must be made only in dollars, and not in pounds, pesos, marks, or francs. These are straws that show that the importance of the dollar is increasing.

Occasionally my customers wish to pay accounts with

90-day sterling exchange. Our account will be in dollars at sight in New York, so this means figuring the exchange. In order to be able to remit dollars, I must go to a bank here in Santiago and ask what the rate is. They in turn must ask Valparaiso, because the rate of exchange is based on the sale of drafts at Valparaiso. I return to the bank in the afternoon and they give me a rate. From this I figure the value of a dollar in pounds and get the draft from my customer for the right amount. This draft must be used to purchase between 2 and 4 p.m. of the same day New York exchange, or I am liable to lose or gain by the fluctuation of exchange, because a new rate must be obtained on the next day. You can see what trouble this entails. Another difficulty is that the rate is not the same at all the banks, so that it becomes necessary to ask several in order to know which is the best rate. Their rates depend upon whether they wish to sell or buy on that particular day. So it is that at times I have been asked, "Are you sure going to buy?" before I have been quoted a rate.

My company remits funds for current expenses in drafts on New York, and it is in such cases that I am keen on getting the best possible rate. When the draft is such that any bank will accept it, the difference in price offered is sometimes as much as 2%. Even in cases where the draft is drawn directly on a given bank here, it is possible to obtain a better rate than is originally quoted if one is independent and in a position to send the draft back to New York if the price is not right.

This is not like banking elsewhere, but the condition is not to be charged to the banks so much as to the uncertainty of the value of Chilean money from day to day. Nevertheless, it is to be hoped that if an American bank is ever established here, it will not quote different rates to different people.

MARK R. LAMB.

Santiago, December 4, 1915.

THE WEEDON COPPER MINE in the Eastern Townships of Quebec has produced in five years 174,000 tons of cupriferous pyrite ore. According to a recent report on the 'Copper Deposits of the Eastern Townships of Quebec' by the Provincial Department of Mines, the main orebody of the Weedon is a lense 570 ft. long, 40 to 45 ft. in maximum thickness, striking north-east and dipping 40° to the south-east. The ore averages 3.6% copper, 40.7% sulphur, with traces of zinc, lead, silver, and gold; it has been sold for about \$9 per ton. On September 1, 1914, about 200,000 tons of ore was known to be in reserve. The mine is 3½ miles from the railroad to which transportation of the ore is effected by an aerial tramway; the cost of this transportation by tramway is under 7 cents per ton. John McDonald of Sherbrooke, Quebec, bought the property for a small sum in 1908, on account of its rusty showing of schist. He sunk several pits and finally a shaft in the bottom of a grass-covered depression, penetrating 25 ft. of ore. The property was leased under option to P. de P. Ricketts of New York, who transferred it to the East Canada Smelting Co.

Carrie J. Everson and Flotation

The Colorado Scientific Society recently started an inquiry into the work of Carrie Jane Everson, who did some early work in connection with the flotation process in Colorado. The committee of investigation consisted of H. C. Parmelee, the secretary of the Society, Philip Argall, and George E. Collins; the last mentioned being chairman of the committee. The chief result was to elicit an authoritative account of Mrs. Everson's life from her son, John L. Everson, of San Anselmo, California. From this account it appears that many of the details circulated in the literature of flotation are quite incorrect.

Her maiden name was Billings. She was born at Sharon, Massachusetts, in 1842, and in 1851, when only nine years old, went with her parents to Illinois, where in 1864 she married William K. Everson, a physician and surgeon practising at Chicago. Through her husband she became interested in chemistry. In 1878 Dr. Everson lost money in one of Brick Pomeroy's wild-cat mining schemes, causing his wife to seek a means of adding to their livelihood. She studied mineralogy and chemistry, and, as her son states, "discovered what she termed the chemical affinity of oils and fatty substances for mineral particles. She later qualified this theory when she learned by further experiments that other substances would accomplish the same results, notably wheat-gluten, lamp-black, soot, etc." Her husband became interested in these experiments and aided her in obtaining the celebrated patent, No. 348,157, of August 29, 1885. Two years later the family moved to Denver, where Dr. Everson tried vainly to get mining men interested in the process. He died in 1889. Thereupon his widow, being in financial straits, took to obstetrical nursing. At this time she met Thomas F. Criley, who tried to get some people at Baker City, Oregon, to interest themselves in the process. Criley died shortly afterward. Then, in 1891, Mrs. Everson met Charles B. Hebron, who had a little knowledge of concentrating plants and arranged to aid her in mechanical details. The joint patent No. 471,174 of 1891, was a result of this association. A Mr. Pischel of Denver is also mentioned by her son as having become interested to the extent of furnishing funds for the erection of a demonstration plant. One or two trials were made in this experimental plant, but a disagreement between Hebron and Pischel caused the abandonment of the scheme and a final cessation of her courageous effort to make something out of her patents. Thereupon, in 1892, Mrs. Everson became visiting nurse of the Denver Flower Mission and was employed in this capacity until 1906, when failing health caused her to accept a position as teacher of physiology and hygiene in the State School for Girls at Morrison, Colorado. In 1909 she joined her son in San Francisco, and later at their joint home at San Anselmo, where she died on November 3, 1914, being then 72 years of age.

Concentrating Molybdenum

As is generally known, molybdenum is in great demand at present as a substitute for tungsten in the making of tool steel. The principal ore, molybdenite (MoS_2) much resembles graphite in appearance, having, however, a little bluer color and giving a green streak on fractured porcelain. Molybdenite occurs commercially in narrow veins in granite and crystalline rocks. The concentration of the ore, containing from 1% to 10 or 20% of MoS_2 , to a merchantable product of 80 or 90%, is receiving attention in various parts of this country and Canada. The Canadian Department of Mines, at Ottawa, has been experimenting along these lines, and has lately obtained one of the flotation machines of Henry Wood of Denver for its testing laboratory. Mr. Wood has concentrated molybdenite ores from several localities in the Western states and British Columbia, and claims that his machine will separate molybdenite from gangue without preliminary sizing, yielding a merchantable concentrate, and recovering 80 to 90% of the molybdenite. The Mines Department at Ottawa apparently favors preliminary sizing and in some cases a roasting operation.

According to the *Canadian Mining Journal* the process suggested by the Mines Department as devised from treating 2½% ore containing other sulphides and mica from the Chisholm mine, in Ontario, is as follows:

Crush to inch size. Dry in a cylindrical drier that does not allow the furnace-gases to come in contact with the ore. Pass to ½-in. rolls; thence to a Newago screen that gives material over ¼-in. to a picking-belt, material over ½-in. going to another picking-belt, and under ½-in. to a Keedy sizer. The picking-belts carry the product to ¼-in. rolls, thence it passes over a Newago screen, from which over ½-in. size goes to ½-in. rolls, and under ½-in. to a Keedy sizer. All the ore (finally under ½-in. size) goes to a Keedy sizer, which is simply a large flour-bolter made exceptionally strong. This makes ten sizes, each of which goes to its own water-flotation machine; the dust passing to an oil-flotation machine or to waste, depending on its content of molybdenum. The tailing from the water-flotation goes to waste. The concentrate, containing 20 to 30% molybdenite, goes to a Wilfley roaster that subjects it to a slightly oxidizing roast at about 1000° F. Careful roasting is necessary to obviate any partial oxidation of molybdenite. The roasted concentrate, now containing oxidized pyrite and pyrrhotite as well as some mica and gangue, is again concentrated by water-flotation machines, giving a product of about 80% molybdenite. The tailing from the roasted ore can be ground and treated in oil-flotation units or can be dried and returned to the Keedy sizer. On the ore tested, 50% of the molybdenite was recovered by crushing in steps and picking out the coarse flake that yields material coarser than 6-mesh.

Prices for molybdenum remain around \$1.50 per pound for a product containing 90% MoS_2 . Frequent reports are published regarding the discovery of new deposits, and the 1916 output should be of fair quantity.

Theoretical Considerations Governing the Persistence of Ore

By T. A. Rickard

*The non-persistence of ore in depth has disconcerted the miner from time immemorial. The geologist did little to explain the difficulty until the effects of oxygenated water within the vadose zone were elucidated by Posepny, and the water-level became recognized as a factor in the distribution of rich ore. When Emmons¹ and Weed² brought forward an explanation for the secondary enrichment of copper lodes, and others, including myself,³ followed suit with a discussion of the conditions affecting concentrations of gold in veins, then the miner sat up and took notice, as it were, for the geologist began to touch upon the one subject most important to him, namely, the ascertainment of the factors favoring the making of those extraordinary concentrations of metal for which he has sought since first a pick struck the earth. The miner does not seek merely for gold in quartz, galena in limestone, or cinnabar in serpentine, for example; he seeks for those few spots where the gold, the lead, or the mercury is in a form or in a mass so concentrated as to yield him a handsome profit. Mining is the art of exploiting enrichments, not universal disseminations. There is gold in seawater, what profits that?

So when theories of secondary enrichment, with all the deductions arising therefrom, began to made headway, they, being true, prevailed over the old generalization, being untrue. One of the first systematic statements on the subject was tendered, most fitly, by that keen observer and effective teacher, Waldemar Lindgren, in 1905. In the first volume of *Economic Geology*⁴ he wrote an article entitled 'Ore Deposition and Deep Mining.' That article summarizes current theory on the subject we are discussing. Turning to what Mr. Lindgren has to say concerning "deposits in which the metal is of later origin than the surrounding rock," we find that he considers contact-metamorphic deposits to be non-persistent. "Slight changes of composition and texture of the rock influence their susceptibility to contact metamorphism to a very surprising degree. Few

mines on contact deposits have been worked at a greater depth than a few hundred feet."

Concerning the deposits "in which the ores have

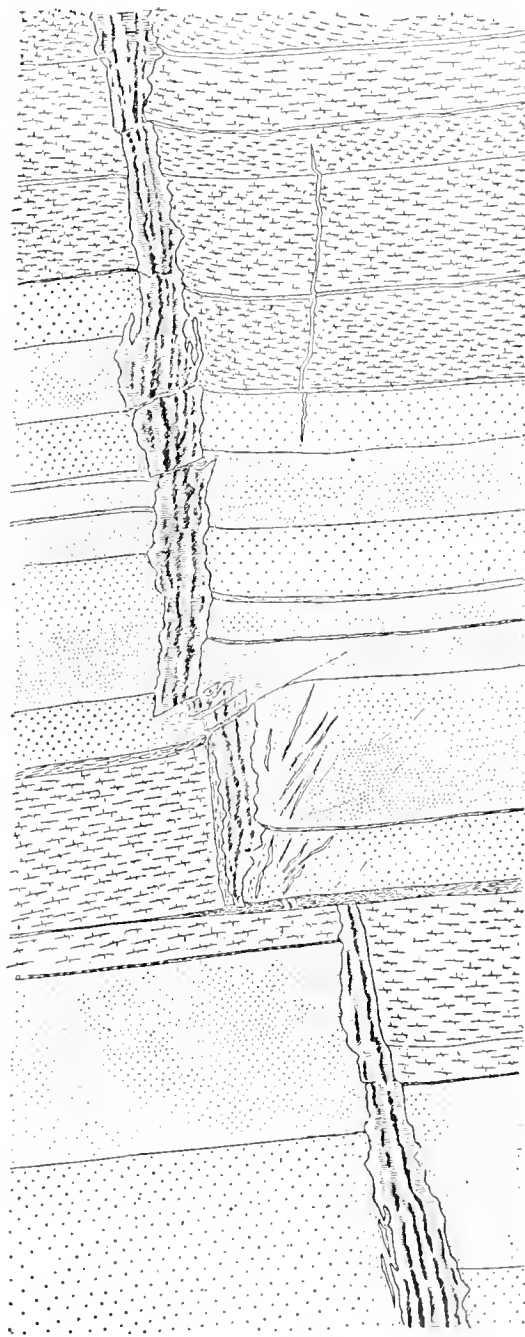

CROSS-SECTION OF THE JUMBO VEIN, IN THE ENTERPRISE MINE, RICO, COLORADO.

*From 'Persistence of Ore in Depth,' a paper presented to the Inst. M. & M., London, November 19, with additions. See the *Mining and Scientific Press*, December 19 and 26, 1914.

¹The Secondary Enrichment of Ore Deposits.' S. F. Emmons. *Trans. A. I. M. E.*, Vol. XXX, pp. 177-217.

²Enrichment of Mineral Veins by Later Metallic Sulphides.' W. H. Weed. *Bulletin Geol. Soc. Am.*, Vol. 11, pp. 176-206.

³The Formation of Bonanzas in the Upper Portions of Gold Veins.' T. A. Rickard. *Trans. A. I. M. E.*, Vol. XXI, pp. 198-220.

⁴Vol. 1, pp. 34-36, October-November, 1905.

been deposited either by filling or replacement along fissures or other paths for underground waters," he states that the views now generally accepted agree in supposing the metallic contents to have been "deposited by ascending hot solutions—in fact, ascending hot springs—and most observers also agree that the metals were taken up in solution by the water at some point considerably below the point of precipitation." He allows that "the conditions for deposition grow less favorable as depth increases, but the change takes place slowly. The richest ores are those near to their original apex." Here he is referring to the erosion of the upper portion of the vein as originally formed. Finally, he concludes, on theoretical grounds, that "ores deposited by ascending hot waters are more likely to show a decrease than an increase in value when developed by deep mining."

However, this is not all that he has to say. It is important to note his suggestion that in some cases erosion may have removed so much of the vein or lode that the present outcrop "may be thousands of feet below the point where the fissure reached the surface during the vein-forming epoch." Applying this idea, he distinguishes between veins traversing volcanic rocks of relatively recent geological age and those penetrating older intrusive rocks known to have consolidated at great depth. He argues therefrom that "the date of vein formation" in the latter case "is likely to be remote," as compared with the former. He places the veins of the Southern Appalachian region, of the California gold belt, and of Australia under the first category, while he mentions the mining districts of western Nevada, the Haunaki peninsula in New Zealand, Owyhee county in Idaho, the San Juan region and the Cripple Creek district, both in Colorado, as in the younger class of deposits. Mr. Lindgren argues, for example, that because "the thickness of crust removed by erosion in the foot-hill region" of California is 3000 ft., and the most persistent orebody as yet discovered has been mined to 3000 ft. vertically, therefore "deposition of free gold ores in the California veins has proceeded to depths from the surface of about 6000 feet."

This argument assumes that the ore as now found is much the same in character and richness as it was at the time when the vein was first formed; it infers the geological age of the orebody from that of the vein in which it lies. To this I demur. The vein, of course, cannot be older than the rock by which it is encased, but it may be much younger; moreover, the ore as now found by the miner in the vein may be considerably younger than the fissure or other receptacle in which it lies. Furthermore, I am discussing the vertical distribution of enrichments, not of the mere vein-filling, for the orebodies exploited by man represent the selected parts of a lode, not the whole of it, and certainly not its poorer portions. I submit that these rich parts may be the result of later chemical reactions long post-dating the waters that first circulated along the fissure and precipitated the primary ore. In short, I submit that most

orebodies, that is, the rich parts of a lode, are geologically young.

The suggestion made by Mr. Lindgren, that the present veins may be only the stumps, as it were, of those that at one time, previous to erosion, reached to a former surface several thousand feet higher than their present outcrops, has been advocated with some enthusiasm by persons of less acknowledged authority in matters of this kind. A good example is afforded by the literature on the goldfields of Nova Scotia. In that Canadian province the small veins of gold-bearing quartz follow thin beds of slate belonging to an extensive series of slates and sandstones of pre-Cambrian age. This sedimentary formation has not only been metamorphosed, but it has also been subjected to violent plication resulting in sharp anticlinal folds, so that the quartz veins assume the shape of saddles, which by the further action of cross-folds, become domes.⁴ Apart from these structural features, it is a remarkable fact that this sedimentary formation has a known thickness of 30,000 ft., of which 18,000 ft. constitutes the division characterized by gold veins. It is estimated by E. R. Faribault, J. E. Woodman, and other geologists who have studied the series, that erosion has removed overlying rock several miles thick. Mr. Faribault writes⁶ of the veins having been "truncated by extensive denudation." Again he says: "Some of the sharpest and highest folds have been truncated to a depth, as far as we know, of over eight miles, exposing at the surface a section of gold-measures of over five miles in thickness." This means that 8 miles has been denuded, and that the gold veins persist through the underlying and surviving 5 miles of rock. His diagrams express the same idea. Several less-known writers on the geology of the Nova Scotian goldfields have argued likewise: that the little quartz veins to be seen nowadays at the surface are the stumps of veins that once reached three or four miles to the surface of a former period, and therefore, that these same little veins may persist a few miles deeper, thus arriving at the cheerful conclusion that gold mining in Nova Scotia is "in its infancy."

This reminds me of the cynic's definition of faith as believing things you know to be untrue. It is a brutal fact that of the gold veins that are supposed, on a geological diagram, to have continued several miles overhead and to persist yet for several miles underfoot, not one has been exploited profitably to a vertical depth of more than 1100 ft.⁷ Most of the little mines in Nova

⁴'The Domes of Nova Scotia.' By T. A. Rickard. *Trans. Inst. M. M.*, Vol. XXI, pp. 596-599.

⁶'The Gold Measures of Nova Scotia and Deep Mining.' By E. R. Faribault. *Mining Society of Nova Scotia*, 1899.

⁷The deepest gold mine in Nova Scotia is the Libbey property at Brookfield, Queen's county. This was worked to a vertical depth of 1962 ft., following the orebody on its pitch by means of an incline. The Lake lode, at Caribou, in Halifax county, was mined to a vertical depth of 1099 ft. Not more than a couple of dozen mines were exploited to a depth greater than 500 ft. vertical.

Scotia that have given good results were abandoned when they were 200 to 300 ft. deep. When a man tells me that a 6-inch quartz vein once penetrated rock, now eroded, for several miles, either way, up and down, from the spot where I now see it, I marvel at his imagination; and when I find that a prospect-hole, or at most a shaft only a couple of hundred feet deep, suffices to follow that vein to its vanishing point, I turn to him and say to him that he has stated something that is scientifically untrue.

Even if the actual story of mining in Nova Scotia had not given the laugh to any such assumption of persistence on quasi-geological grounds, we should be warranted in rejecting the theory of continuity on such knowledge as is extant concerning the origin of ore deposits in general. Mr. Faribault and others assume that the granite, of Silurian age, was extruded after the gold veins had been formed, "for granite dikes and veins have been observed to always cut the inter-strati-

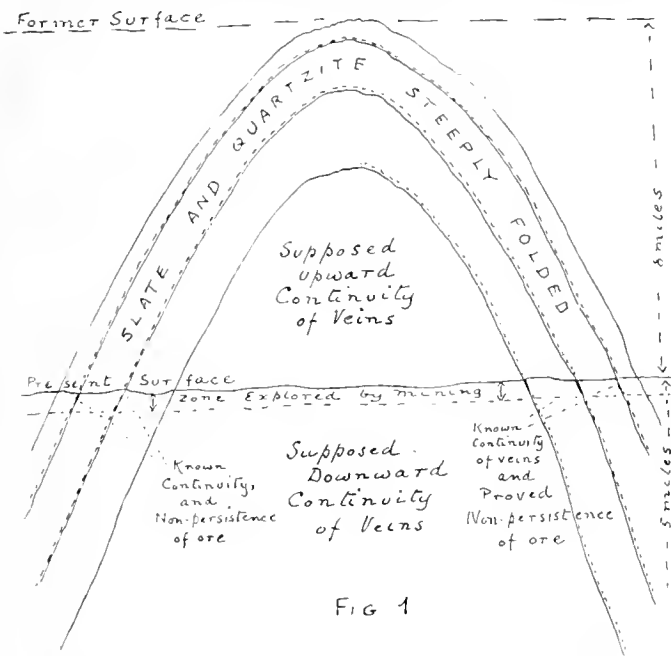

SECTION ILLUSTRATING SUPPOSED PERSISTENCE OF VEINS IN NOVA SCOTIA.

fied quartz veins wherever they come in contact with them." This is open to doubt. At Forest Hill the quartz of a vein can be seen penetrating into the granite, and gold is visible both in this quartz and in that of a vein near-by.⁸ Mineralization is usually the sequel to eruptive activity. In Colorado, almost without exception, the deposition of ore over a wide region of great geological diversity is known to have taken place in post-Cretaceous time, and in most cases it can be proved that the orebodies hitherto discovered were formed after the extraordinary eruptive activity of the early Tertiary period.⁹ I could quote scores of other examples indicating the geological recency of the agencies that may

⁸Trans. Inst. M. M., Vol. XXI, pp. 565, 566.

⁹Geological Distribution of the Precious Metals in Colorado.' T. A. Rickard. Mining and Scientific Press, January 8, 15, and 23, 1910.

be connected justifiably with the deposition of ore, not of the precious metals only, but of the base ones as well. Even if the evidence indicates that a vein was formed at an early date in geological history, before erosion had removed thousands of feet of younger rock, it still remains to be proved that the metals enriching that particular vein were precipitated at so early a period where we now find them; and even then it is incumbent on those who argue persistence of ore on the basis of the

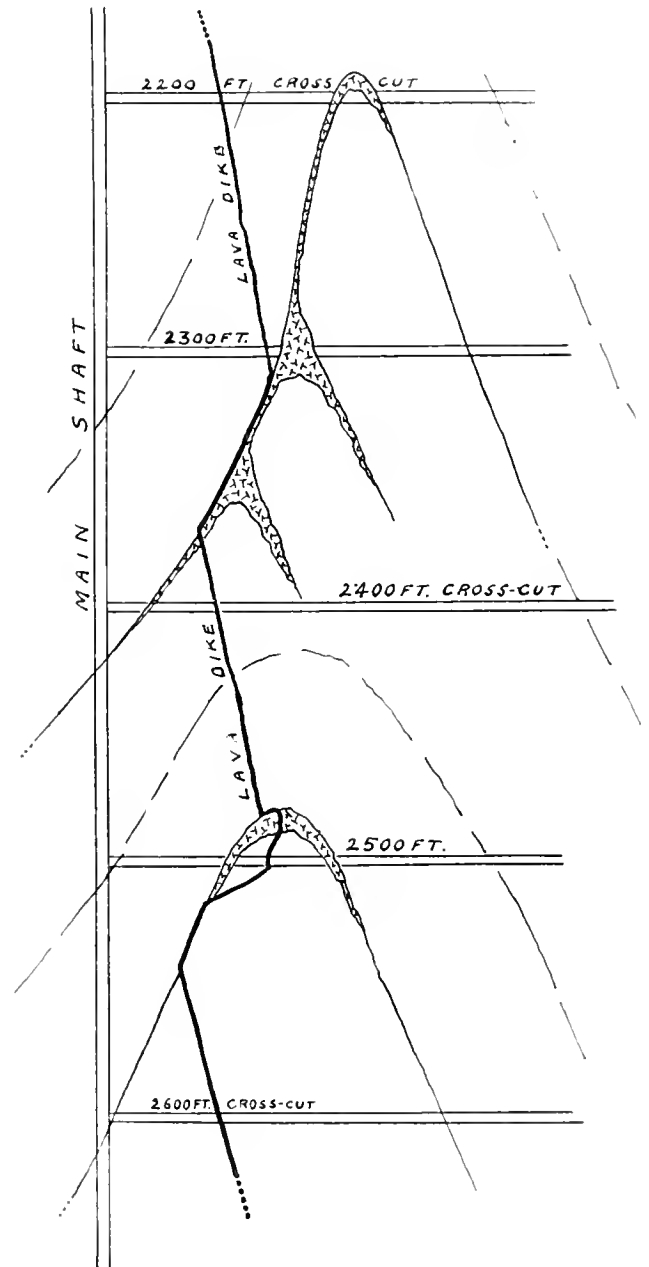

FIG. 2. THE SADDLE-BEELS IN THE 180 MINE, AT BENDIGO.

geologic antiquity of the veins, to prove that the richest portions, namely, the orebodies, were not the product of activities belonging to a much later time. We are entitled to make this last stipulation, because, as I have said, and have elsewhere proved, so many orebodies are definitely known to be the products of the thermal and igneous activities that came into play at a period long subsequent to that in which the veins themselves were

first formed. Let me quote the case of the Homestake.

That celebrated lode, in South Dakota, consists of a mineralized zone in schist, known to be of pre-Cambrian age. In the overlying Cambrian conglomerate are found boulders recognizable as eroded fragments of the lode-schist. The conglomerate is a 'banket' deposit, for it contains enough gold to be exploited as ore. So here, it has been said, we have proof of a gold-bearing lode of pre-Cambrian age, for is not the débris of it and the gold of it found as a constituent of a Cambrian conglomerate?

As early as 1882 W. B. Devereux indicated that part of the gold in the overlying Potsdam conglomerate was not of mechanical origin, derived from the erosion of the Homestake outcrop, but had been deposited as a chemical precipitate, for he found it as a film between the folia of the schist and in the overlying quartzite.¹⁰ In 1889, F. R. Carpenter, long resident in the locality as a mine manager, testified that the vicinity of intrusive rock is favorable to the richness of the ore; he concluded that 'porphyry' produced "either an enrichment of the deposit or a further concentration of what gold originally existed in it." In the neighboring district he ascertained that the silver-bearing galena ores, in Cambrian quartzite, are found "only in connection with the igneous intrusions." In the overlying Carboniferous limestone, ore of similar character is found "adjoining the porphyry, where it cuts through the limestone." He then expressed the opinion that the ore-bearing rocks of the region are "co-extensive with the intruded igneous rocks."¹¹ In 1897, F. C. Smith¹² stated that neither the Potsdam quartzites "nor those of the Carboniferous are ever sufficiently mineralized with the precious metals to be called ores, except in certain localities where they are cut by dikes, covered by flows, or intercalated with sheets of igneous rocks."

In 1896 I had an opportunity of going underground in the Homestake mine and of visiting neighboring workings; in 1899 I examined the Hawkeye-Pluma mine, which is in the gold-bearing conglomerate overlying the Homestake lode. I formed an opinion then that the richer portions—that is, the orebodies—of the Homestake schist are associated with the dikes of rhyolite that penetrate not only the overlying Cambrian strata but transgress a formation of shale belonging to a period so late as the Cretaceous. In other words, it seemed likely that the enrichment of the lode was consequent upon thermal action of post-Cretaceous age.

In 1903, J. D. Irving published a paper on the subject.¹³ He stated that the fact of the Homestake lode

being "mineralized and gold-bearing" in Cambrian time "is proved by the presence of gold in the basal or lowest rocks of the sedimentary series which lie in the isolated patches about the outcrop of the orebody." However, Mr. Irving also says, in regard to the Homestake lode: "It appears, first, that there have been several different periods of mineralization, at least one of which has preceded the deposition of the Cambrian rocks, as is distinctly shown by the presence of placer gold in the lowermost gravel beds of the Cambrian series; second, that there have been periods of mineralization which followed the entire deposition of the sedimentary rocks and were later than the intrusion of the dikes and bodies of rhyolite. It is probable that this belt has been the seat of much fracturing and crushing from very early geological time until the present, constituting a line of weakness along which mineralizing waters were permitted to circulate more freely elsewhere."

In 1904, J. D. Irving, S. F. Emmons, and T. A. Jagger published a paper on the economic geology of the district.¹⁴ They concluded that while some of the gold in the Potsdam conglomerate is detrital, the high-grade portions of it are indebted to secondary enrichment. This enrichment was contemporaneous with the introduction of the pyrite, which was not an original constituent of the pebbles, but serves now to distinguish the rich parts of the deposit. The pyrite occupies fissures and cavities in the pebbles. Barren conglomerate is cemented by quartzite or by calcite free from pyrite. He refers to the films of gold in the schist.

It is noteworthy that Irving considers the increase from a grade of 1 dwt. gold to the higher average of 10 dwt. per ton to be due to secondary enrichment. In other words, the formation of that part of the deposit that has an economic value—and is therefore 'ore'—is ascribed to the later processes whereby the original detrital deposit was enriched by secondary precipitation. In short, the Cambrian conglomerate became an orebody by reason of chemical precipitation associated with post-Cretaceous, or Tertiary, thermal circulation.

In regard to the Homestake lode, Emmons ascertained that intrusive bodies of rhyolite, of Eocene age, dip and strike with the orebodies, through which they also pass. The breccia formed along their contact with the schist is gold-bearing and pyritic, showing that the "mineralizing solutions must have entered along the channels produced by these movements," which, he it noted, took place in the Eocene period. Thus the gold-bearing ore of the Homestake, once supposed to be wholly of pre-Cambrian age, proves to be largely of Tertiary age; in other words, the enrichment or concentration that changed a zone of crushing into an orebody was not ancient, but young, geologically.

An interesting example of ore deposits undoubtedly due to more than one period of formation is afforded by the copper veins of Butte, in which chalcocite has orig-

¹⁰The Occurrence of Gold in the Potsdam Formation, Black Hills, Dakota.' By Walter B. Devereux. *Trans. A. I. M. E.*, Vol. V, pp. 465-475.

¹¹Ore Deposits of the Black Hills of Dakota.' By Franklin R. Carpenter. *Trans. A. I. M. E.*, Vol. XVII, pp. 570-599.

¹²The Potsdam Gold Ores of the Black Hills of South Dakota.' By Frank Clemes Smith. *Trans. A. I. M. E.*, Vol. XXVII, p. 405.

¹³Contributions to Economic Geology.' U. S. Geol. Survey, 1903, p. 128.

¹⁴Professional Paper No. 26, U. S. Geol. Survey.

inated¹⁵ in at least three ways, and at three different periods:

- (1) As a primary deposit from ascending solutions;
- (2) As a secondary deposit from ascending solutions; and
- (3) As a secondary deposit from descending solutions.

Indeed, the idea that ore deposits as now found came into being at one moment of geological time and have survived unaltered through the continual interplay of natural forces, operating for periods during which the Alps and Andes might come and go like a child's sand-castles before the encroaching tide, is contrary to all the teachings of geology. On the contrary, the evidence, especially that gathered during recent years in connection with secondary enrichment, all goes to show that the orebodies found by man today represent the temporary balance between solution and precipitation, between dissemination and concentration. Man, by removing the ore and subjecting it to his own processes, interrupts the work of Nature, who otherwise would continue to modify her handiwork indefinitely. The idea of fixity in the composition of an orebody is as

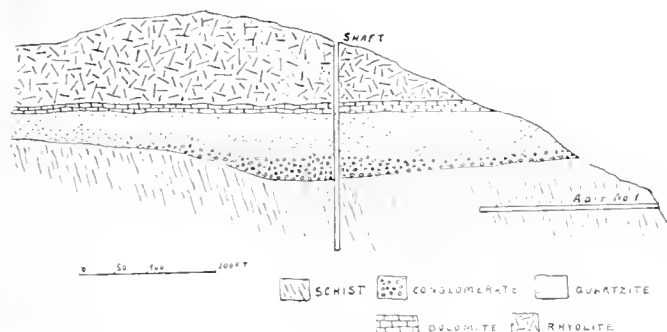

FIG. 3.

THE GOLD-BEARING CONGLOMERATE IN THE HAWKEYE-PLUMA MINE.

After J. D. Irving.

repellant geologically as the notion that the present face of the earth is permanent.

Among those that have demurred to the conclusion I am seeking to establish is J. Malcolm Maclaren. Two years ago, in discussion of a couple of articles¹⁶ on this subject written by me, he objected¹⁷ to one generalization being replaced by another; that is, while he could not support the old idea of general persistence, he considered my sweeping contradiction to be a "pernicious doctrine, if universally applied." He makes a big exception for ore deposits in Archean and Paleozoic rocks, and even several in Mesozoic rocks. Imputing the ore-bearing character of such lodes to a favorable country-rock, he concludes that the richness will continue downward until the lode passes out of the favorable rock. He instances the Mother lode in California, the Treadwell lode in Alaska, and the Champion vein in India to support his conclusion. He endeavors to make a point of

differentiating between geologic structure and depth *per se*.

Having regard to Dr. Maclaren's knowledge of economic geology, this may be considered the best argument yet advanced in favor of an idea that I consider ripe for final sepulture. The argument is ingenious, but it amounts only to a red herring across the trail we are trying to follow. Suppose we accept geologic structure as more decisive than depth, does that falsify the argument from world-wide experience? Of course not. Increase of depth involves change of geologic structure. It is most unlikely that a mine opening can be extended downward for many thousand feet without exposing a change of rock or of rock-structure. The probability of change is implicit in the idea of depth.

He refers to the Champion lode, in the Kolar gold-field, and says that "if it should fail at greater depths, it will fail not on account of the depth, but because the fissure has passed from hornblende-schist into the gran-

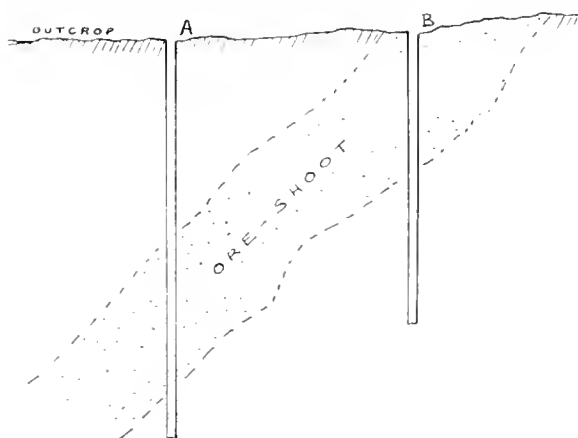

FIG. 4.

ite, and so far as I [Dr. Maclaren] know, there is no evidence to indicate such a change is likely to take place." To this I reply that the Champion lode, without marked change of geologic encasement, has become impoverished in depth.

That impoverishment or even abrupt cessation of ore may ensue from a change in the structure or composition of the wall-rocks is true, of course. This is an explanation, not a rebuttal, of my argument. We are all aware that ore-shoots have a pitch that takes them beyond one line of vertical descent and may bring them across another line of descent, as is illustrated in Fig. 4, where shaft B is started in the ore-shoot and goes out of it in depth. On the other hand shaft A starts in a barren portion of the lode and does not strike ore until a depth of several hundred feet has been gained. It would be as illogical to conclude, from B, that the ore peters out at, say, 300 ft., as it would be to assume, from A, that enrichment with depth has been proved at 350 ft. At Oatman, Arizona, at the present time, we have more than one illustration of the conditions typified by shaft A; it is highly probable that the explanation will be similar in kind. One reason for missing the outcrop of an orebody and starting to prospect in a relatively poor

¹⁵Austin F. Rogers. *Economic Geology*, Vol. VIII, No. 8, p. 794.

¹⁶'Persistence of Ore in Depth,' *Mining and Scientific Press*, August 24 and 31, 1912.

¹⁷*Mining and Scientific Press*, October 26, 1912.

portion of the vein is the fact that where the ore is soft or easily decomposed, the ore shoot exhibits no outcrop, on the contrary, it is covered with a mantle of detritus sufficiently thick to cause the prospector to miss it.

We miners are also aware that a 'congenial' rock exercises an important influence on the distribution of ore. Cornishmen have known that since the days when the Phoenicians came to the Cassiterides. In Fig. 5 a group



FIG. 5.

of veins is shown passing from slate into granite. Under such conditions no ore may be found in the veins until they penetrate the granite, or else they carry copper when in the slate and tin when in the granite, as has been the case at Dolcoath and other Cornish mines. Another good example of a congenial rock is illustrated by Fig. 6, where a vein, itself of minor consequence as an ore-carrier, is capped by a rich mass of ore in a bed of dolomite. Such conditions exist in the Black Hills of South Dakota. The flat orebodies of Newman hill, at Rico, Colorado, also belong to this type, only there the

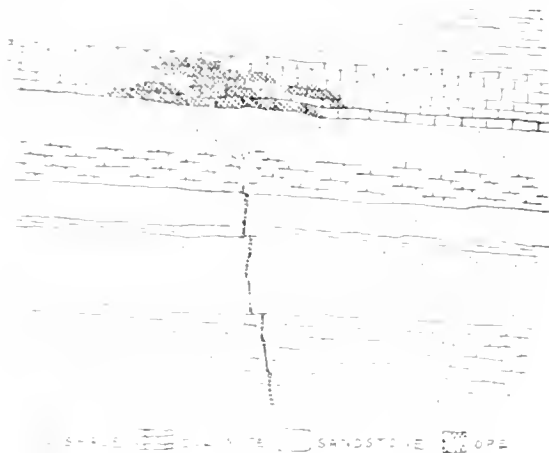

FIG. 6.

favorable horizon is marked by a bed of gypsum. In both cases, however, the roof or upper limit of enrichment is shale, which appears to have been relatively impervious to the mineralizing waters that impregnated the soluble dolomite and gypsum. Here also the miner was compelled, in most cases, to sink several hundred feet, or to drive a long adit into a hill, in order to reach the place of enrichment, yet when he followed the veins

that had fed the so-called contacts he found that they became impoverished at a short distance below the ore-bearing horizon.

Another type of contact is shown in Fig. 7, where a porphyrite adjoins a limestone. Such igneous contacts with soluble rocks have proved good places for the finding of ores, both those of lead and of copper, as at Leadville and at Clifton. The neighborhood of dikes and intercalations of irruptive rock has proved favorable in the search for gold and silver also, in numberless localities all over the world.

Finally, I may instance the crossing of veins as a struc-

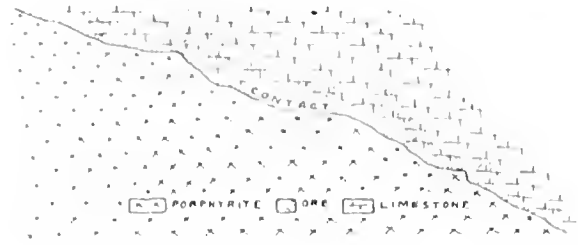

FIG. 7.

tural condition appreciated by the miner as a place likely to be marked by an enrichment. See Fig. 8.

Other examples of the localization of ore by reason of structural relationships might be cited, but those given will suffice. Such favorable conditions may recur in depth, and they are found at varying distances from the surface, but the effect of them in promoting the deposition of ore becomes modified in depth by the increase of temperature and of pressure. Moreover, the tightening of the ground, as the miner phrases it, tends to decrease the multiplicity and continuity of fracturing, thereby impeding the circulation of mineralizing waters and



FIG. 8.

checking those exchanges and reactions between solutions of diverse composition to which the precipitation of ore is largely due.

MANGANESE ore from the Caucasian region of Russia was produced to the amount of 730,310 short tons in 1914, which is 338,415 tons less than in 1913. Practically all of the annual production is customarily exported; before the War, Germany and Belgium were the best customers, while Great Britain, United States, Austria, and France took smaller quantities.

WHITE ARSENIC production of the United States in 1915 was 5195 tons, worth at the smelters 2c. per pound, or a total of \$207,780. This is 11% over 1914, and 65% over 1913.

Mining Districts of Northern Ontario

By Robert Livermore

† THE mining districts of the Province of Ontario may be divided into two classes: the precious-metal, gold and silver, producing areas; and the other mineral-producing districts, such as copper, nickel, iron, and the commercial earths. At present productive mines of the former class belong to the northern part,

tween the two, since gold rarely occurs in any considerable quantity with the silver ores, while silver, although found to some extent in the gold-bearing veins, is a by-product only. The chief reason for this is to be found in the fact that the veins of the two groups, though all in rocks of pre-Cambrian age, were formed under different geological and chemical conditions, and at different periods.



WINTER PROSPECTING.

and of the latter to the southern part of the Province. This, however, is a general statement only, as deposits of the precious metals have been known and worked for many years in the older southern districts, while considerable deposits of the baser metals are known, and at least one profitable deposit of nickel is being worked in the north. Still, the division is correct for the purpose of this article, which is to describe in general terms the gold and silver districts, and the conditions of mining in them.

The precious-metal mining districts may again be divided into two distinct groups: gold and silver; for unlike most of the Western mining districts, there is a very clear line of demarcation be-

*Manager of the Kerr Lake Mining Co., Cobalt, Ontario.

†Re-printed from the November, 1915, issue of *The Technology Monthly and Harvard Engineering Journal*. Protected by copyright.

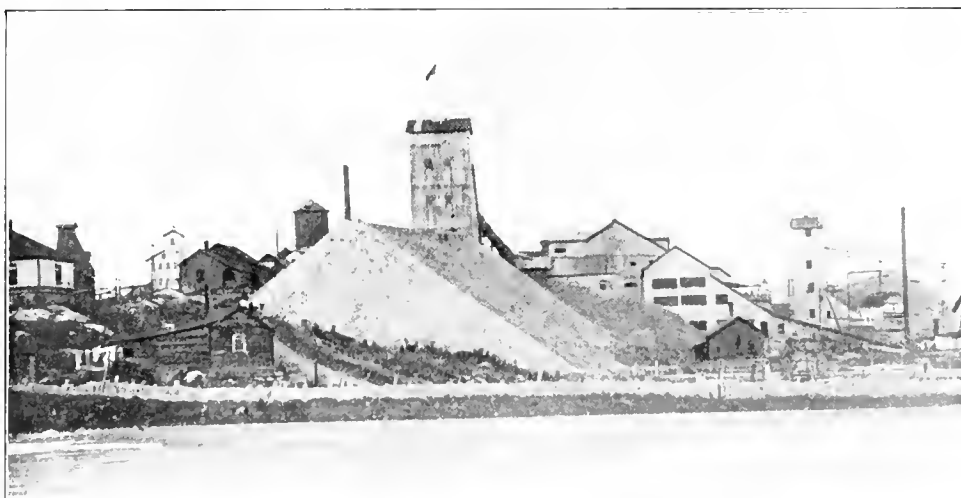

THE COBALT MINE.

the deposition of the silver ores in the Huronian. The Cobalt series proper consists mainly of slate, pebble conglomerate, and graywacke. It was originally deposited by sedimentary action on the uneven Keewatin floor, and subsequently tilted, faulted, and eroded, so that its thickness varies greatly, and its former horizontal bedding-planes are rarely maintained in that position. Its sedi-

mentary character is clearly shown in the waterworn pebbles of the conglomerate and the even stratification of the slate.

Subsequent to the laying down of the Huronian measures there was a great intrusion or eruption of diabase, which in the form of a huge sheet or sill cut through or spread over the entire series as well as the underlying Keewatin. This sill has been proved to be over 500 ft. thick. The generally accepted theory is that the shattering and fissuring of the rock that opened the way for the ore-bearing veins took place by contraction when this eruptive cooled, and that the diabase itself was the source of the silver. Some engineers of repute hold that the fissuring was subsequent to the eruptive flow, and not directly due to it, and that the silver was deposited from deep-seated solutions, in one or the other formation according to the favorable chemical conditions of the wall-rocks. Faults are quite numerous, varying from mere steps in the bedding-planes to throws of many feet. These seem in some cases to have influenced the deposition of the ore in the veins, notably in the vicinity of the great fault under Cobalt lake, and in the South Lorrain district, where the ore-bodies have usually been found near the faulted contact between the diabase and the Keewatin. The faults themselves, however, rarely form ore-zones.

The veins occur in all three formations: the basal Keewatin, the more recent Huronian, and the intrusive diabase. They are far more numerous in the Huronian than in the other formations, so much so that it has been the custom to measure the probable life of the district by the known areas of Huronian rocks. That this is not entirely the case is shown by the fact that important deposits in both diabase and Keewatin, which have added largely to the total production, have been worked since the early days of the district, and discoveries are still being made in these formations. In fact, since the Huronian terrain is distinctly limited both in area and depth, the best hopes for the future lie in exploration of these deeper-seated rocks.

In general it may be said that the veins occurring in the Huronian are far more dependable than those in other formations, and one fact is universally recognized, that a vein which carries ore in one of the three principal rock-series named, will carry it in that series alone, and though the vein itself may continue in strength for some distance, it will rarely contain ore for more than a few feet in a different series.

The silver occurs in several forms: native silver, in sheets, masses, and in fine combination with other minerals being the most common form. Proustite, argentite, and dyscrasite are also common. Closely associated with the silver are the cobalt compounds, smaltite and cobaltite. It is from this mineral that the camp takes its name, as the prominent outcroppings of cobalt bloom attracted the first notice to the veins. Niccolite is nearly as common as smaltite, and is usually an ore-bearing mineral. The commoner minerals, galena, pyrite, and chalcopyrite are frequent in occurrence, but are never good indications of ore. The vein-filling is almost in-

variably calcite and dolomite. Where quartz occurs it is a sign that no silver will be found.

In conjunction with the vein there is usually an impregnation of the wall rocks with silver, extending from a few inches to widths of many feet from the veins. In the early days little attention was paid to this feature, both for lack of methods for treatment, and because the high grade ore was so easily won; but with the approaching exhaustion of the high-grade, the low-grade mill ore has become of increasing importance, and today a very large tonnage is treated in the modern plants that have been erected as conditions warranted.

Erosion has played an important part in the physical features of the country, due to the intense glacial action of past ages. Unfortunately for the miner it has not worked entirely to his advantage, for undoubtedly enormous thicknesses of ore-bearing rock have been eliminated. Still, it has not been all one-sided, for just as probably, ore-formations formerly capped or concealed by barren rock have been exposed to view by this agency.

The physical aspect of the Cobalt country is one of low, rounded, rocky hills, rarely exceeding 200 ft. in height, formerly forest-clad, but now unsightly with stumps and brush. Numerous lakes make up a large part of the surface area, and often overlies parts of the mines. The altitude is about 1000 ft., and the climate dry and bracing. The winters are long and cold.

The Cobalt silver district so far overshadows the other silver-producing areas of Ontario that a description of its main features covers the whole subject. The Cobalt district proper includes an area some five miles long by two wide. While other productive localities, such as the Casey-Cobalt mine on the north and the South Lorrain district on the south, extend its limits for over twenty miles, the mines of both the last-mentioned places are simply isolated cases of ore deposition, to which the same features apply as to the parent district.

The district is served by the Temiskaming & Northern Ontario Railway, a government line that gives excellent service to the whole North country. This road, in fact, is the prime reason for the discovery of Cobalt. It was originally projected by the Ontario government to open up for settlement the fertile clay-lands known to lie to the north and west of lake Temiskaming, reaching far north over the height-of-land toward Hudson's Bay. The first ore was found on the shores of Cobalt lake, then known as Long lake, in 1903, by employees of the railway. Not until 1904 was the importance of the deposits recognized, but when it was, a rush set in, and scenes of excitement and 'wild-catting' usual to new finds prevailed. A strange combination of remoteness and accessibility was this rich silver camp in the heart of the northern wilderness, separated by many miles of untracked forest, yet to be reached in one night from the great city of Toronto by comfortable Pullman car. Today, only ten years after the time when none but the timber cruiser, the Indian, or trapper traversed the wilds by canoe and portage, a town of thousands of people, with good buildings of brick and stone, with electric cars and automobiles passing along its streets, stands on the site of the

old forest. So swift is the progress of a prosperous mining community.

Cobalt has produced in the ten years of its existence more than 210,000,000 ounces of silver, and has paid over \$60,000,000 in dividends. For the last five years the production has been maintained at nearly 30,000,000 oz. annually, and although there are signs that this yield is decreasing, the output is still maintained at not far

however, extremely rich, probably the richest silver veins ever uncovered. It is not unusual for carload shipments to contain four, five, or six thousand ounces per ton. The characteristics of the veins make it exceedingly hard to estimate their future productivity. This uncertainty has hurt many of the properties from an investment point of view, and economically speaking, has operated against initial installment of efficient equipment, and use of long-sighted mining methods proper to mines of more assured future. In the course of years, greater familiarity with the 'habits' of the ore has enabled engineers to make much more comprehensive estimates of the reserves, so that with the confidence of experience, many of the early mistakes have been set right, and mining and treatment methods brought thoroughly up to date.

The mining practice of Cobalt is not complicated. The wall-rocks are solid and on the whole little timbering is required. The ground is easily broken; and the ore is hoisted to the surface for sorting, where the high-grade is picked on belts or

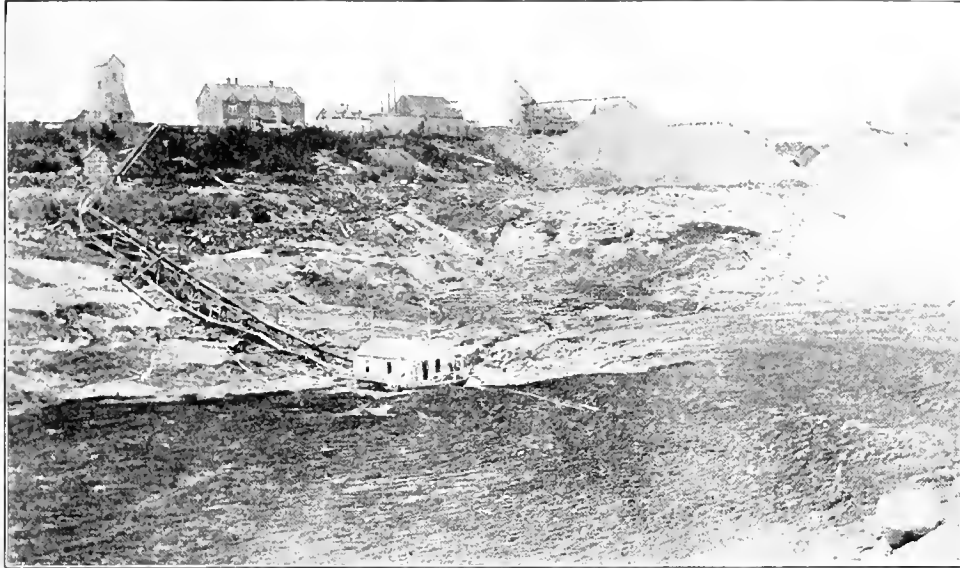

THE DRAINED BASIN OF KERR LAKE.

from its high mark. There are at the present time no less than 16 producing and dividend-paying mines in an area five miles long. In normal times there are 5000 men employed in and around the mines, and probably 10,000 people in the district and neighboring towns are dependent directly or indirectly upon the industry.

There are three main groups of mines; those near and surrounding Cobalt lake, where the town stands and where the first discoveries were made; those in the Kerr Lake district two and a half miles south; and those two miles farther south near the granite contact, known as the Temiskaming Beaver mines.

Of these, the first now derives its ore almost entirely from the Huronian formation, and is by far the largest in number of mines and productive area; the second takes a large production from the Huronian, but also has had veins of great richness in both diabase and Keewatin rocks; the third, and smallest, has depended upon the Keewatin for its production until recently.

The Cobalt veins are narrow, rarely exceeding a foot in width, and are irregular in all dimensions. They are,



THE TEMISKAMING MINE.

bumping-tables, the fine jigged for smaller pieces of high-grade, and the reject sent to the mills. About the only engineering difficulties underground have been those where the valuable deposits lay under water necessitating greater care in stoping and supporting the ground. At Kerr lake, a body of water some 40 acres in area, and 100 ft. deep had to be considered. The managements of the two companies, parts of whose property lay under it, undertook to drain the lake by mounting powerful pumps

on a sewer and pumping the 400,000,000 gallons of mud and water it was estimated to contain, out of the basin. This has been accomplished, and has thrown the formerly submerged territory open to prospecting and mining. The management of the Cobalt Lake mine, which lies under the lake of the same name, has installed apparatus of similar nature and has commenced draining that lake also.

Surface prospecting has always been a necessary part of the operations, since so many small rich veins lie irregularly over it, which would be difficult and expensive to find underground. This has usually been done by trenching through the drift material, but the Nipissing Mining Co., which has a large surface area, has tried the interesting and successful experiment of installing a powerful hydraulic plant, which strips large surfaces bare of overburden at a minimum of expense.

Cobalt is not a 'deep' district. Two hundred feet is considered a satisfactory thickness for the Huronian rocks, and the average is still less. The great number of veins and their richness have, however, compensated for the lack of depth, since if ore is concentrated by nature on the surface it is that much more easily mined than lower-grade ores that must be hoisted from greater depth at greater expense in equipment and elaboration of mining methods. This fact is too apt to be overlooked by the investor or engineer, who has always had impressed upon him the desirability of persistence in depth, and the reputation of Cobalt has in the past suffered accordingly. The continued productiveness of the district, however, has gone far toward re-establishing the confidence lost when its shallowness was first recognized. Naturally, depth of ore deposits is highly desirable, for lateral extension of the veins is obviously limited, and in the long run the continuity of industry depends upon the depth to which the ore will go. Signs are not lacking that this factor has still to be determined, as ore has been discovered and mined at quite respectable depths in the Keewatin and diabase. Up to the present, however, all discoveries are well within the 1000-ft. mark.

Almost all of the mining companies treat their low-grade ore in either their own or custom mills. The milling practice varies between simple amalgamation with concentration, and straight cyanidation. The concentrating advocates claim that though a less extraction is made, the loss is offset by the smaller cost of treatment. Those who uphold cyanidation alone say that the higher extraction far more than balances the extra cost. With the operation of the 240-ton low-grade mill of the Nipissing Mining Co., which does away with concentration entirely, and depends upon fine grinding with direct cyanidation, the latter practice has become generally recognized to be the best, and most of the mills are now using cyanide in their scheme of treatment.

Most of the mines have their own steam-driven power-plants, but these are used simply for heating or for auxiliary supply during occasional shortages due to vicissitudes of climate. The main supply is bought from a company that controls the huge water-power on the Montreal and Mataibitchouan rivers, and furnishes both

electric and compressed air power to the whole district.

Labor, on the whole, is efficient, and of a good class. The rank and file of the men are of all nationalities, with the native born in the majority. The Nova Scotian gold miners were at first the only experienced machine-men, but of late their places have been filled partly by foreign-born who have proved themselves adept. Finns and Austrian Poles are strong in numbers, and much to the credit of the Canadian temper, the latter have been permitted to continue at work without molestation, in spite of their nationality. Wages, in comparison with Western, and with other camps of Northern Ontario, are not high, ranging from \$2.25 to \$3.25 per day, but conditions of living are easy and working-hours are not long.

Smelting in Australia

As a result of the War, the Broken Hill Associated Smelters Proprietary Co. was formed by three companies operating at Broken Hill to acquire the Broken Hill Proprietary Co.'s plant at Port Pirie, South Australia, connected by rail with the mines and mills, a distance of 250 miles. The weekly capacity of four Ropp roasting-furnaces, seven Dwight-Lloyd sintering machines, 16 Huntington-Heberlein converters, and four blast-furnaces with mechanical feeders, was 3200 tons of 60% lead concentrate per week, and the lead refinery 2000 tons of bullion per week. The zinc smelter works consisted of one Matthieson-Hegeler roasting-furnace and 10 zinc-distillation furnaces, with a total capacity of 350 tons of zinc concentrate, and an output of 100 tons of spelter and blue powder per week. The output is to be increased to 5000 tons of lead concentrate per week, at a cost of about \$500,000. The area of the property is 136 acres, also a wharf 1200 ft. long. There are coke-works at Belambi, New South Wales, with a weekly output of 1100 tons for the smelter. The companies at present sending their products to the works are the Proprietary, North, South, and Zinc Corporation. When extensions are completed, the number of contributors will be increased. During the four weeks ended September 22 the following work was reported: concentrate smelted, 11,847 tons; slime smelted, 1210 tons; and silicious ores, 3000 tons, a total of 16,057 tons; refinery products consisted of 6975 tons lead, 59 tons antimonial lead, 296,023 oz. silver, and 372 tons spelter.

AT THE PAN-AMERICAN financial congress, held in Washington in May 1915, the following measures were advocated: two-cent letter postage between Latin-American countries and the United States; the adoption of the gold standard in all Latin-American countries; increase and simplification of banking and exchange facilities between the United States and Latin-America; more and faster steamer service; extension of the parcel-post service; better understanding as to tariffs, taxes on shipping, and free zones; publication of commercial laws in English, Spanish, and Portuguese; protection of foreign patents and trade-marks in South America.

Economics of the World's Supply of Copper

By Thomas T. Read

*COINCIDENTLY with the development of the electrical industry, the consumption of copper has increased at an extraordinarily rapid rate, and is now at its maximum. It is of interest to consider (1) whether this increase will continue; (2) whether resources are available to permit the continued production of constantly increasing amounts of copper. As sub-topics under (1), there are the questions: (a) whether substitutes may not be devised to take the place of copper; (b) whether changes in industry may not be brought about that will perhaps decrease the use of those materials in which copper is now used; (c) whether new uses for copper may not be devised that will increase its consumption. As sub-topics under (2), it is necessary (a) to review the known and probable resources of the world's copper deposits, and (b) to analyze the world's trade in copper in so far as it bears on the economic factors governing the exploitation of these deposits.

(1a) PROBABILITY OF SUBSTITUTES FOR COPPER. The electrical industry absorbs 60 to 70% of the present production of copper, the larger part of it in the form of wire. Aluminum is a strong competitor of copper for long-distance transmission-lines, or wherever aluminum can be stranded with a wire of steel to afford the tensile strength that the aluminum itself lacks. Aluminum is more easily attacked than copper by corrosive agencies of the atmosphere, but as long transmission-lines are most in use in the Rocky Mountain region, where the air is comparatively pure and dry, the importance of this factor is lessened. For telephone and telegraph lines, copper seems likely to hold its own, especially in the Eastern States, since it is resistant to corrosion, and the smaller copper wire is less swayed by the wind and holds a smaller load of snow and ice in the occasional severe storms that are so destructive.

It has been suggested that steel wires coated with copper would have greater tensile strength and equal conductivity, but it is difficult to make such a coating sufficiently homogeneous and adherent so that rusting will not take place beneath it, and it is also difficult to produce compound wires at a low cost. Where small wires are necessary, as in winding dynamos and motors, or for electric-light cord, there appears no possibility that

copper can be displaced, and the competition of aluminum must be confined to heavy wire.

(1b) POSSIBLE CHANGES IN INDUSTRY. For the present at least, there seems no reason to suppose that the electrical industry will demand smaller quantities of copper, while in a hundred fields of industry the grow-

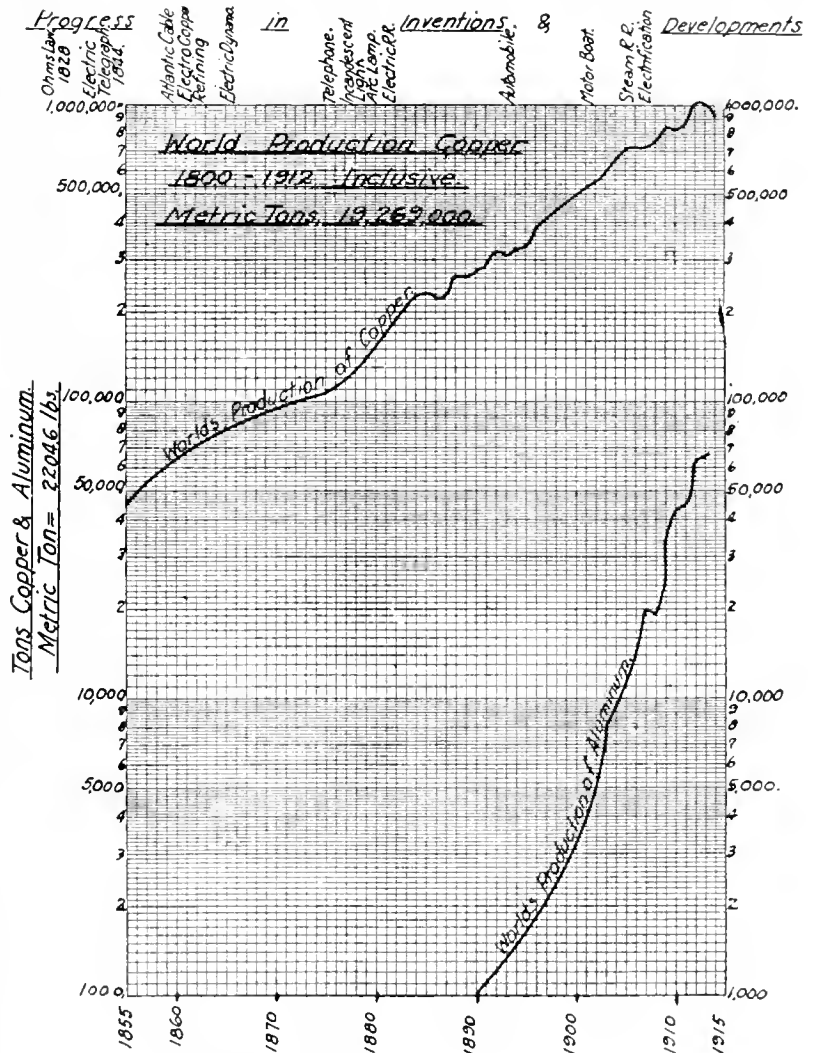

THE WORLD'S PRODUCTION OF COPPER AND ALUMINUM.

ing use of electrical equipment calls for increasing amounts.

(2a) KNOWN AND PROBABLE RESOURCES OF COPPER. The following table shows the copper reserves of the principal mines of the Lake Superior district, as estimated by J. R. Finlay in a report for the State Tax Commission of Michigan in the summer of 1911. The figures given are the recoverable copper, not the total content. Since 1911 the recovery methods have been improved and a leaching process has been devised that is expected

*Abstracted from a paper presented before the International Engineering Congress, in San Francisco, September 29, 1915.

not only to increase the recovery from ore, but also to yield large amounts of copper from old tailing.

| Mine | Recoverable copper lb. |
|---------------------------------------|---------------------------|
| Almeseck | 290,000,000 |
| Mohawk | 176,000,000 |
| Wolverine | 80,000,000 |
| Oscoda Consolidated | 300,000,000 |
| Alloué | 110,000,000 |
| Cahmet & Hecla | 702,000,000 |
| Oscoda amygdaloid | 330,000,000 |
| Quincy | 200,000,000 |
| Isle Royale | 112,000,000 |
| Superior | 75,000,000 |
| Battle | 110,000,000 |
| Trimountain | 16,000,000 |
| Champion | 110,000,000 |
| Lake | 40,000,000 |
| Total, July, 1911 | 2,681,000,000 |
| Deduct production to January 1, 1915. | |
| Add estimated recovery from tailing | 150,000,000 |

This table includes only those mines that, in 1911, were producing copper at a profit. There are other mines that produce (or have produced) considerable amounts without making any profit. A decrease in working costs or an increase in the price of copper would therefore increase the reserves given above.

Only a few of the other copper companies have published any statement of their ore reserves, but fortunately among these are several of the largest, as shown in the table below:

| | Ore in tons. | Copper % | Copper in lb. |
|--------------------------|-----------------|-------------|------------------|
| Utah Copper | 332,500,000 | 1.47 | 9,642,500,000 |
| Ray | 78,380,966 | 2.20 | 3,228,800,000 |
| Chino | 94,000,000 | 1.80 | 3,384,000,000 |
| Inspiration Consolidated | 45,000,000 | 2.00 | 1,800,000,000 |
| Miami | 20,300,000 | 2.45 | 995,000,000 |
| | 6,000,000 | 2.00 | 240,000,000 |
| | 17,200,000 | 1.21 | 413,000,000 |
| Nevada Consolidated | 41,020,296 | 1.68 | 1,374,189,000 |

Figures for the Anaconda and Phelps-Dodge companies are not available; otherwise, a fair estimate of the known copper resources of the United States might be made.

For foreign companies, even less authentic data are available. The list below gives most of those at hand:

| Mine. | Ore Reserves Short ton. | Copper Content % | Copper Content lb. |
|---------------------------------------|-------------------------------|------------------------|--------------------------|
| Chile Copper Co., Chile | 280,855,900 | 2.13 | 11,936,337,500 |
| Braden Copper Co., Chile | 78,000,000 | 2.8 | 4,368,000,000 |
| Mount Morgan, Australia | 3,125,000 | 2.55 | 1,572,500,000 |
| Kyshtim Corporation, Ltd., Russia | 356,000 | 3.00 | 21,360,000 |
| Spassky Copper Mine, Ltd., Siberia | 12,643 | 20.00 | 5,057,200 |
| Mount Lyell, Tasmania | 2,202,335 | 0.531 | 23,500,000 |
| | 1,086,112 | 6.00 | 130,300,000 |

These figures are useful only as hints, since the really significant factors are the large deposits that have never been thoroughly explored. Thus the immense copper deposits of the Belgian Congo have never been appraised, since under present conditions no profit can be made,

except in working the higher-grade ore. Improved facilities for mining and reduction, a new process, or higher prices for the metal may render immense quantities from these deposits available for industry. It is significant that the largest reserve in the table above, that of the Chile Copper Co., was unknown a few years ago. Large copper deposits exist in southwestern China and are only worked to a limited extent. The figures given for the two Russian companies undoubtedly represent only a modicum of the copper which that country will eventually produce.

(2b) WORLD'S COPPER TRADE. The United States produces more than half the world's supply of copper. Japan, with the next largest output, producing less than one seventh of the U. S. output. Of our yield about one-half is used in this country and one-half exported, chiefly to Europe, Germany having been our best customer. Japan uses a large part of its output and sells the rest in China and Europe. Much of the Australasian production goes to Europe, and the same may be said of the Mexican and Chilean copper. The copper output of Russia is absorbed in that country; in time Russia may become an exporter. Spain and Canada are also important producers of copper; the output of the other countries is small. It may be said that the general movement of copper, the world over, is toward regions of dense population. Manufactures of copper, on the other hand, tend to flow outward from the densely populated regions. In general, it may be said that such fluctuations in the price of copper as occur in the near future will be due to the relations between demand and immediate supply, and not to any scarcity of copper ores.

COPPER and its alloy, bronze, were known and used by prehistoric men. Copper was known before the time of Menes, the first Egyptian King, who reigned at a period possibly as early as 5500 B. C. It is believed that copper was used unalloyed for many centuries before the discovery of the use of tin as an alloy for producing bronze, which came into use on account of its greater hardness. At the beginning of the 18th century, Great Britain was making three-quarters of the world's copper—possibly 5000 tons. One hundred years ago the mines of the United States, Spain, Chile, Mexico, Canada, South Africa, Australia, and Tasmania, which now produce 90% of the world's copper, were undeveloped. In the United States, copper was discovered in Massachusetts as early as 1632, and in 1709 a company was incorporated in Connecticut for the purpose of working copper ores. The copper deposits of New Jersey were exploited in 1719. The copper mines of Vermont date from the 18th century. These were the principal sources of American copper until the opening of the Lake Superior mines in 1844. Really important copper mining in the United States dates from 1844, with the opening of a vein near Copper Harbor, in Keweenaw county, Michigan. In 1882 Montana produced its first copper. The copper industry of Arizona was started a decade later.

Points of View From Lake Superior

By P. E. McDonald

THE Franklin mine is trying a circular picking-table in its shaft-house where hand-picking of the ore is being done. Close picking of the ore at the shaft is an innovation in the Copper Country.

Steel is now being manufactured at Duluth in the new plant of the U. S. Steel Corporation. Hibbing, Minn., continues to have troubles; together with several neighboring towns, its saloons have been closed by an old Indian law of 1855.

The Calumet & Hecla group of companies is using $\frac{5}{8}$ -inch hollow steel for most ordinary drilling. With the longer steels now employed, a 16-ft. length of $\frac{5}{8}$ -in. steel appears, as one miner expressed it, "as springy as a whip."

The Wolverine mine, which was such a steady profitable producer for so long, was reported a few years ago to have its ore practically exhausted. Then the policy of seeking for copper in the foot-wall by drilling with small sinker-drills was adopted with such success that it is now announced that the mine has 15 or 20 years of life ahead, much of which time will be consumed in working from the bottom back to surface, prospecting the foot-wall in the old stopes. The report that the Stanton interests, who control the Wolverine and Mohawk, intend to consolidate the White Pine Extension with the Wolverine is officially denied, although Theodore Dengler will serve as manager of the three mines.

Calumet township has shown such an increase in births recently that for the year 1915 it registered approximately one-tenth of the total number of births in the State of Michigan. It is axiomatic that the statistics for marriages and births in the Copper Country rise and fall in the wake of the price of copper.

A mine-superintendent in the Copper Country recently remarked: "Our output hinges on the speed of tramming, yet if we put an extra man on each car, two men would work while the third loafed." In many of the copper mines the tramming is so scattered on twenty or thirty levels that close supervision is difficult. Mule or electric haulage never obtained much popularity in this region, such as the latter has on the Iron Ranges, because of the difficulty of concentrating the tramming; the Winona mine recently put in mules for underground haulage.

E. W. Walker, who returned to Michigan from Arizona several years ago and made a record at cutting costs and producing copper at the Mass Consolidated, is now in charge of the Lake mine. Six or seven years ago Lake

was the sensation of the stock speculators in the Copper Country, partly because of spectacular showings of copper and partly because of the connection of the Pryor family with the company. Mr. Walker's plan of campaign to rehabilitate the Lake mine will be based upon the same mixture of progressiveness and conservatism as characterized his management of Mass.

The White Pine mine down in the wilderness of the Porcupine mountains used to be more difficult to reach from Houghton than was Chicago or Milwaukee. With the recent completion of the branch railway, coal and supplies are being shipped to the locality and a settlement is springing up near-by; the company is also taking advantage of the rail-transportation to improve the equipment at the mine.

The Kitchigami Gold Development Co. is a recent venture of Lake Superior people to operate in the Kirkland Lake district of northern Ontario. The directorate includes John Daniell, Dr. John McRae, Chas. Chynoweth, James T. Fisher, and Edwin J. Hall, all of Calumet, Henry Baer of Hancock and John A. Doelle of Houghton. C. W. Botsford, a geologist of experience, is in direct charge of the work, which will consist at first of diamond-drilling to cut extensions of neighboring gold-bearing veins. The company was organized under the laws of the State of Arizona with a capital of \$300,000 divided into 150,000 shares of \$2 each; public participation in the stock holding was invited. Four mining claims, approximating 160 acres, have been secured in the part of the Kirkland lake district adjoining the Foster-Costello group. Every once in a while Lake Superior people take a chance on ventures in the West or North, and have picked some notable winners.

The year 1915 was an extraordinary one for the Copper Country, the output of copper being 259,352,000 lb. This was the largest production of copper that Michigan ever made, exceeding the great years of 1905 and 1909. As compared to the copper yield of Arizona in 1915, which was the enormous figure of 450,000,000 lb., Michigan's figure seems small, but the State of Arizona is many times larger than Keweenaw peninsula, and embraces several copper mining regions. Montana's output of copper in 1915 was 275,000,000 lb. Of Michigan's production the Calumet & Hecla Co. furnished 72,000,000 lb. or less than one-fourth, which was the company's biggest output in six years. It is interesting to note that the so-called Calumet & Hecla subsidiaries, produced slightly more than the Calumet & Hecla. Evidently the policy of expansion adopted by the C. & H. several years ago will be profitable. It should be remembered, however, that only a portion of the stock of the subsidiary companies is held by C. & H. Dividends from the Lake mines had dwindled a good deal since the happy days of ten years ago, and the large returns of the last year are all the more deserved when the lean months of the strike are considered.

CONCENTRATES

Readers of the MINING and Scientific PRESS are invited to ask questions and give information dealing with technical and other matters pertaining to the practice of mining, milling, and smelting.

MINI FURNACES should be well ventilated to get rid of the dust, steam, and smoke that always accompanies molding and casting metals. Small furnaces should have hoods attached.

MANGANOID STEEL RAILS and lining have been found to be the most efficient for Hardinge re-grinding mills at the Winona mine, Michigan. They are superior to the flint and silix imported from Europe.

WORN-OUT TIRE MILL LINERS of the Osborn type on the Rand are being successfully used as liners for launders, ore-bins, feeder-chutes, and mortar-boxes, also as fire-bars for assay and melting furnaces.

JOURNALS are best lubricated by having the rubbing surfaces constantly submerged in a bath of oil; it is not necessary that the whole surface be submerged. The same result is accomplished by chains and rings encircling the journals and dipping into oil-pockets.

FLY-WHEELS are commonly made of cast iron as it is cheap. With high speed this material is not safe. Some heavy fly-wheels are made of steel-plates (perhaps a dozen, each $\frac{1}{2}$ in. thick) securely riveted together; such a fly-wheel might be used on a motor-generator set.

THE WASTE of heat supplied an open-hearth furnace as fuel gas and combustible elements of the charge is 45%. Boilers placed in the flues will reduce this loss by 50 or 60%, by the generation of steam for power. An 85-ton furnace will produce 386 h.p. There are several difficulties in the operation of a boiler in this way.

THE BASIC-LINED copper converter is now well established. It gives splendid service. At the Old Dominion smelter, at Globe, Arizona, a converter of this kind was taken off the stand, early in December, after having been in continuous use since July 1913—a run of 30 months. During that time it had produced 70,000,000 pounds of copper.

SURFACES of machinery that are subject to heavy work and wear should be case-hardened. This is done by penetrating the surface of the steel by carbon. The best natural carbonizers are granulated bone, charred hoofs, leather, beet-sugar pulp, and crude raw sugar. Artificial carbonizers are made, but their effect is not considered equal to the natural ones.

HYDROCYANIC ACID GAS is used for fumigating various things, largely fruit trees. The gas is made in the orchard in a machine on wheels. The cyanofumer consists of two tanks, one above the other; in the lower one

is H_2O and H_2SO_4 , in the upper KCN solution, and by means of a pump the required quantity of solution is forced into the acid, generating gas instantly. This is sprayed onto the trees.

SOME ENGINEERS consider ball and roller bearings not successful or commercially practicable for heavy shafting. This type of bearing shows good results in low-friction losses when new and when kept in good condition, but give trouble if not frequently examined. A well-designed babbitted self-oiling bearing with chain or ring, is considered very reliable. It is simple, has low first cost, little wear, small oil consumption, and the metal lasts for years.

SPECIFIC GRAVITY of metals is of interest at this time of disturbance and new adaptations in metal economies. Tungsten's specific gravity is unusually high, being 17.3, which is nearly equal to gold of 19.3, and which exceeds that of mercury, 13.6. Magnesium, which German scientists are said to be advocating as a substitute for aluminum, is only 1.75, compared to 2.7 for aluminum, which in turn is three times lighter than copper with 8.8. Cobalt and nickel are close to copper. Chromium at 5 is lighter than steel at 7.8; while zinc at 7 is nearly equal to tin at 7.3, but lighter than lead at 11.4. Manganese is from 7 to 8; silver is 10.5.

AMYGDALOID, BASKET, conglomerate and pudding-stone are terms closely allied. The first is given to an igneous rock containing rounded cavities, caused by bubbles of steam in the original lava, now filled with secondary minerals, such as quartz or calcite, or lined with zeolites. Amygdaloid comes from *amygdalé*, the Greek for almond. Basket is the Boer word for almond cake, and was given by them to the conglomerate on the Rand. Conglomerate comes from the Latin *conglomeratus*, heaped together, which is derived from *cum*, with, and *glomus*, a ball. It is the more scientific equivalent of pudding-stone, given in the early days of geology to a rock formed of consolidated pebbles.

A 'POSSUM,' as used in the oilfields of California is intended to prevent wear on both the cable and casing, by keeping the cable from rubbing or striking the sides of the casing. They are especially effective where the hole takes a considerable turn from the perpendicular. These possums are usually from $1\frac{1}{2}$ to 2 in. thick, and from 12 to 14 in. long, tapered at each end to allow a rope knife to be run over them when necessary. The wrapping or material of which they are constructed is usually rope-yarn, but tarred marlin is better; electric tape can also be used. The number put on a cable, and the distance between them, depends upon the conditions existing at each well. The possums should be kept oiled or 'doped' with some lubricant. This idea came into use in California about 10 years ago, and it is gradually spreading to other oilfields. As possums will run over the crown-pulley and wind on the bull-wheel shaft, there are no bad features in connection with their use.

REVIEW OF MINING

As seen at the world's great mining centres by our own correspondents.

TUCSON, ARIZONA

FLOTATION TESTS ON ARIZONA ORES.

It is officially stated that a considerable amount of experimental work in oil flotation is being done this year at the University of Arizona, at Tucson, using the machine as shown in the accompanying illustration. The machine used is of the modified Hoover type, having an agitation chamber and spitzkasten, with a suction created by the agitator arms returning a portion of the pulp for re-treatment. The machine is in a series of three chambers, connected by glass tubes, and is arranged for mechanical agitation in varying speeds, as well as air agitation, where the air is forced through a 200-mesh screen, or a combination of both. The machine is arranged for continuous action, or any chamber may be operated separately. The chambers have glass fronts and glass connecting tubes, in order to observe the action. So far, molybdenum ores have received special attention, and very



EXPERIMENTAL FLOTATION PLANT AT ARIZONA SCHOOL OF MINES.

satisfactory results with selective flotation, in the separation of molybdenite from copper and iron sulphides, have been obtained with eucalyptus and creosote oils. Good results have been obtained with as low mixtures as 0.05% oil.

A large part of the experimental work is being done on mixtures made up from pure oils, in order to determine, if possible, some relation between the oils used and the mineral character of the ore. Experimental work is also going on in an effort to determine whether or not there is any relation between the mineral faces, as determined by varying the crushing. Over 80 oils are being used in the experimental work. The whole group of experiments is designed with a view to determining 'why is flotation?' The greater part of the work is being done by H. J. Stander, assisted by P. E. Joseph and

E. W. Ames, under the direction of the Arizona State Bureau of Mines.

The Arizona State Bureau of Mines at Tucson has so far published 10 bulletins dealing with the mining industry of Arizona; these should be of interest to those engaged in mining, and the Bureau will be pleased to send them to anyone desiring the same. The following bulletins are now in process of preparation: 'Tungsten,' 'Mercury,' 'Magnesite,' 'Workingman's Compensation,' 'How to Sell Ores.' The February Safety Bulletin, Safety series No. 1, is to hand.

JOPLIN, MISSOURI

BRIEF REVIEW OF THE PAST YEAR IN THE ZINC-LEAD AREA.—WORK OF STATE MINE INSPECTOR EFFECTIVE.—NEW PLANTS OF SOUTH CARTERSVILLE DISTRICT.—ZINC AND LEAD NOTES.

With an aggregate value of \$26,000,000 for zinc and lead ores shipped from the Missouri-Kansas-Oklahoma region in 1915, all previous records were easily broken, the best year prior to 1915 being 1912, when the total output was \$18,043,479.

Zinc sulphide concentrate constituted the larger part of the tonnage, and commanded the highest price per ton of any of the ores shipped, the highest price having been reached in the week ending June 12 when \$135, basis of 60% metallic zinc, prevailed for a greater part of the high-grade.

Shipments of the various ores from the district for the year were 286,000 tons of blende, 21,000 tons of calamine, and 45,000 tons of galena, the average price per ton for blende being \$76 for the year, compared with \$51 in 1912, the previous high year. Lead averaged \$55 per ton.

The new year dawns with 60% blende worth \$85 to \$115 a ton, compared with \$48 to \$52.50, calamine at \$60 to \$75, basis of 40% zinc, compared with \$22 to \$25, and \$70 for galena, compared with \$47 at the beginning of 1915. During the early months of the year the market displayed remarkable fluctuations. The rises and falls of the ore market uniformly reflect the movements in spelter.

The prosperity in the zinc-smelting industry throughout the United States has been reflected to a great extent in the mining industry of the local district, although the greatest margins of profits have been reaped by the smelters. For

instance: the smelter procures for an average of \$100 a ton, ores that yield metal valued at \$170. Much of the metal made from Joplin ores realize more than the quoted price on prime Western grades; hence the margin of profit to the smelter is even greater than would appear at first glance.

Following in the wake of the higher and steadier ore prices, the local mining field has enjoyed an epoch of activity never before equaled. Not only have new mills 'sprung up' in all parts, but new towns have sprung up from nothing; and where, a year ago, there was no sign of human habitation nor activity save, perhaps, a caravan of prospecting drills, prosperous, thriving and busy communities now exist. Picher and Cardin, Okla., are striking examples, the former being the 'baby' camp of the north-eastern Oklahoma

The lead field in northern Oklahoma now boasts of one of the best well-developed areas in Oklahoma, large foundries, hotels, modern brick buildings, macadamized streets and a population of 2,000. All these little places dot the prairies in the extreme north-eastern part of the state and constitute what is known as the Miami district, due to the fact that Miami is the largest town there, and was the only town there when the first mining was done about eight years ago.

The extensions of the district, reaching as far as Aurora, Lawrence county on the east down to Granby, in Newton county on the south-east, Alta and Neck City on the north, Geneva, Kansas on the west and Miami on the south-west show evidence of the wave of prosperity that is sweeping through the district. Foundries and machineries of all cities in the district are unable to meet the demand for equipment, and supply houses are doing the biggest business they ever did. Mine labor is at a premium, and workmen by the thousands are getting wages of \$3.50 to \$4 a day, while some are making more than this.

Efforts of the mine inspectors for this district of Missouri have been devoted not only to improving the working conditions in the mines and making work generally less hazardous, but also to making the surroundings of the workmen more elevating and to improving the sanitary features. In their report to the chief state mine inspector, Geo. Hill, the three inspectors of this district will set forth the work they have accomplished during the year just closed. The local inspectors are L. L. Burch of Joplin, C. M. Harlan of Cartersville, and W. W. Holmes of Webb City. They played a prominent part in the organization of the Southwest Missouri Mine Safety and Sanitation Association, consisting of mine operators who meet every Thursday at a noon dinner at Webb City. Much good has been done by the Association during the few months that it has been in existence. Mine owners, almost without exception, have shown a desire to co-operate with the inspectors in the enforcement of State laws. One result is that in nearly all the hard sheet-ground mines water-pipes have been fitted up to all headings, and holes are sprayed to prevent the circulation of rock dust through the drifts, thus greatly eliminating one of the principal causes of miners' consumption. The building of better 'dog-houses' has been started by many of the larger companies, while others are to follow suit. At the American Zinc, Lead & Smelting Co.'s property at Cartersville a new dog-house has just been finished. It is 112 ft. long by 39 ft. wide, heated with steam, and has 248 ventilated lockers. The building is floored with concrete, while at one end is a bath department equipped with numerous showers. At the Scott mine, Duane, Mo., the company has provided for the comfort of its men to an exceptional extent, a large swimming-pool in which the water is changed every 24 hours having been constructed in the dog-house. The mine inspectors have put the ban on boulder 'lopping' during working hours, and stress has been laid on the importance of having all roofs properly trimmed and examined regularly each day to eliminate the probability of accident from falling slabs.

Two new mills in the South Cartersville district will be working before the end of January. Both are being constructed by Mattes Bros., who have two separate leases of 20 acres each on property of the Zinc Corporation of Missouri, of which T. J. Franks is president. One mill will be on what is known as the Cary lease, a tract of land that was only recently drilled and opened with shafts and drifts. Disseminated ore was encountered at a depth of 119 ft., and continued down to 165 ft., while beneath this two sheets of sheet-ground, each 10 ft. thick, have been blocked out. The ore will yield about 3% blende and galena. The mill on this property will be of 300-ton capacity per shift, and will be ready before the other plant which is on what is known as the McGregor tract, where only a sheet-formation is to be worked. The Kirkwood, a 300-ton mill, is a recent one to begin work on the same land, while on the Connor land to the west the new plant of the Google Mining

Co. which was recently sold to the National Lead & Zinc Co., of Boston, for \$100,000 cash, is now producing steadily. A number of other new mills have recently begun operations in the South Cartersville district, and as most of them are of large capacity the development in this field is considered of much importance.

The Reeds, Mo., centre in the eastern part of the district is being heard from again through the activities of the United States Smelting company, which recently took over the old Ravenswood lease of the Cornell land, and constructed thereon a concentrating plant that ranks well up with the largest of the district, having a reported capacity of 500 tons per shift. The ore in that field occurs in disseminated bodies, both in hard and soft ground. No blanket formations have been blocked out. Another mine at Reeds to be started in the near future is the Jack Rabbit, which was a small producer some years ago. Improvements include the construction of a large concentrating-plant if prospects are satisfactory.

The Anna Lee mill of 200-ton capacity is being moved from the Spring City, Mo., to the Lincolnville district, where it will be re-built on a lease of the Old Abe Mining Co., the fee to which was purchased recently by S. W. Van Dyne, who was operator of the Anna Lee mine. New development on the Old Abe tract is reported to have revealed a sheet formation at a depth of 70 to 90 ft., the ore being milled easily, due to the fact that it does not have a tendency to be 'chatty.'

Prospect work on city lots on North Jackson avenue, Joplin, within a stone's throw of some of the finest dwellings in the city, is revealing 'pay-dirt' at a depth of 70 to 90 ft. in soft ground. One shaft is already into ore, a hand-jig plant is at work, and steady turn-ins of concentrate are being made. A drill-rig is now working even closer to the residences than any of the previous work, and new strikes are reported. The work is on property of G. S. Clemens, a Joplin dentist, who was holding the land for residences. Its value was materially decreased recently when several acres of mining land caved in, the brink of the pit coming to within a few feet of his choicest lots. Thereupon he decided to mine the property in preference to holding it for sale. His royalties already have more than compensated him for his decision.

The price of zinc-blende at the beginning of the new year is \$80 to \$110, basis of 60% metal, compared with \$48 to \$52.50 at the beginning of 1915. Every indication points to continued strength of the market.

PLATTEVILLE, WISCONSIN

CONDITION OF THE ZINC INDUSTRY IN DECEMBER.—ZINC, LEAD, AND PYRITE PRODUCTION IN 1915.—NEW PLANT.

In spite of bad weather during the latter part of December, unspeakable wagon-roads, intermittent electric-power supply in the southern districts, production and deliveries were large. There was no lull during the Christmas season, something unknown here. Building continued, while drill-rigs and labor to operate them were almost impossible to obtain. Zinc ore maintained a high price. Top grades of refinery products were the subject of keen competition among the more prominent buying concerns, the base range fluctuating between \$110 to \$115 per ton, 60% metal, an increase of \$30 to \$35 during the month. All grades were in constant demand. When good roads are constructed, and motor-trucks used for haulage, the outlying districts will be able to reach the market promptly. Producers of lead ore had advanced offerings, sales being made near the close of the year at \$72 per ton. Sales were light, as zinc is now the ranking ore of the field, and miners everywhere are devoting their energy to the recovery of zinc ore exclusively. Shippers of iron pyrite continued deliveries of fines from separating-plants, but the turn-in was light, some product being carried over. While the crude-ore producers had been curtailing production, the loss in deliveries was

made up from sales from refineries, and the figures at the close of the year will compare favorably with the output reported for 1914. Carbonate of zinc ore producers observed rather wistfully that quotations during the month had mounted to a high price, yet found little demand. As previously mentioned, the New Jersey Zinc Co. practically controls the districts in which this class of ore occurs, and it is not disposed to pay abnormal prices for ore to make a cheap commodity like oxide zinc. Competing compounds in the metal branch of the smelting industry are chary of invading these districts for fear of the reprisals that may be made at other points. The Lanyon Zinc Co. and the Picher Lead Co. have both displayed temerity in picking up some choice ore but the yield for the season is being carried over. In the Joplin district sales were reported at \$85 per ton and as low as \$65 for less desirable production; these figures generally govern quotations for the Wisconsin field, where the miner practically starved out would be willing to accept a much lower standard for a steady outlet for his labor and investment.

Ore deliveries during December were as follows:

| Districts. | Zinc pounds. | Lead pounds. | Pyrite pounds. |
|---------------------|-----------------|-----------------|-------------------|
| Benton | 15,124,000 | 458,900 | 80,000 |
| Mifflin | 7,860,000 | 222,000 | |
| Galena | 4,346,000 | | |
| Cuba | 3,363,000 | | 3,376,000 |
| Hazel Green | 3,162,000 | | |
| Platteville | 2,900,000 | | 696,000 |
| Linden | 2,816,000 | | |
| Shullsburg | 1,298,000 | 162,200 | |
| Highland | 826,000 | 50,000 | |
| Montfort | 248,000 | | |
| Potosi | 150,000 | | |
| Mineral Point | 110,000 | | |
| Total | 42,203,000 | 893,100 | 4,152,000 |

The gross yield of crude concentrates from all mines for the month totaled 35,515,600 lb.; net refined ores from separating-plants and from mine to smelter direct for the month, 22,712,000 lb. As usual, the Mineral Point Zinc Co. led in the amount of zinc concentrate handled and shipped to smelter at DePue, Illinois, 4,153,000 lb. of 60% 'jack.'

Summing up operations for 1915 in this region there was produced a total of 331,741,540 lb. of crude concentrate, against 261,594,330 lb. in 1914. Shipments of ore out of the field, the true barometer by which the value must be ascertained for the past year, aggregated 212,355,750 lb., compared with 166,136,300 lb. in 1914, or 23,110 tons more than in 1914. This gain is all the more to be appreciated since more high-grade ore reached smelters from Wisconsin mines than ever before, due to the extensive additions of electrolytic zinc ore-separating plants built during the second half of the year. Twelve are now at work, against four at the beginning of 1915.

Lead production in 1915 was 8,320,000 lb., against 4,970,270 lb. in 1914.

Shipments of iron pyrite were under the figures published for 1914, which reached a total of 31,520,110 lb. A gain was made in value, however, since nearly all of the product sold last year came from separating-plants as fines recovered in electrostatic separation, which command a higher figure than crude pyrite. The Wilkinson mine, the largest single producer of pyrite in the Benton district suspended production when its big surface equipment was destroyed by fire early in the year. The profit in handling the crude ore was so small that the owners of the mine concluded to give up the lease.

The building program during the year brought into active co-operation with old establishments 15 new power, mining, and milling plants. Seven others are in various stages of construction, four of them coming into active service soon after the first of 1916.

WASHINGTON, D. C.

PROGRESS OF MINING LAW CODIFICATION IN CONGRESS.

While the codification of the Federal mining laws remains in a favorable position, a marked change as to how it is to be done is manifesting itself, and is likely to go through Congress. All previous bills have contemplated the creation of a commission on codification independent of Congress and appointed by the President, this commission to be composed of experts in mining law and other mining matters, and to take evidence in various parts of the country and make its recommendations to Congress. The bill of Representative Taylor of Colorado proposes the appointment of a commission of five members having knowledge and experience in mining law and the industry, with \$25,000 at their disposal for expenses; that of Senator Smoot of Utah, which has been favorably reported by the Senate committee on mines and mining, proposes a commission of three members, two of whom shall be lawyers of considerable mining experience and one a mining engineer, the commissioners to receive \$500 per month while at work, and having at their disposal \$25,000 extra for expenses. A bill has also been suggested for a commission more representative of the mining industry, as recently recommended by mining men assembled at Washington. It appears that none of these bills are satisfactory to men of influence in the House, and they are declaring decided opposition to them, proposing that the commission to be appointed shall consist of no one not connected in Congress; in fact be made up of members of the Senate and the House familiar with Federal mining law. It is asserted that Congress contains great mining lawyers, such as Senators Walsh of Montana and Thomas of Colorado, and Representative Taylor of Colorado. While such talent is available in Congress, it is asserted, it would be foolish for Congress to go outside to form a commission, which, after all, could only make recommendations that Congress would have to review before enacting them into law. Besides it would all be more direct. As a matter of legal fact Congress would have to codify the laws. It can reject *in toto* the recommendations of any commission. It is even suggested that no commission be appointed at all, but that a joint committee of both Houses, composed of the two mining committees, be authorized to codify the laws and report to Congress. All salaries would be saved thereby, and little incurred. There could be nothing more direct in the codification of the laws. It is asserted that under such auspices the work of revision and of having hearings could be started at once. The mining committees have nothing much to do anyway. All the best legal talent in mining in Congress could be put on the committee. It is thought that such an appeal would carry more weight in Congress than any other that might be made. It is the method Congress ordinarily employs in revising the laws of the country. For some years it has had a joint commission of members of both Houses revising and codifying the general laws of the land, and good work has been done. The same arrangement of committee has also revised the printing laws of Congress. The committee could have its hearing, if any were needed, in the summer, going about the country, but the necessity of such hearings is doubted, but if expedient, everything could be got out of the way by December next. It is asserted that even a commission of independent men could not report its work any earlier. It is said that the mining laws are not so very voluminous. It seems as if this is the course the legislation is likely to take. Since Congress re-assembled in January, hearings have been held by the House committee on mining at which Senator Walsh, Van H. Manning, director of the U. S. Bureau of Mines, and J. F. Callbreath, secretary of the American Mining Congress spoke at length on the need to codify the laws. It is the House committee that is expected to report favorably the new kind of bill discussed above. In the opinion of Washington, it is not so much the personnel of the committee or commission that matters, so long as some

committee or commission of ability is appointed and goes forward with the work desired. And seemingly, it is declared, the more direct the work is the better it should prove, and the sooner finished.

EL PASO, TEXAS

DETAILS OF THE RECENT OUTRAGE IN MEXICO

On January 10 a party of American mining men on the way from Chihuahua to the Cusiuhuitachi Mining Co.'s property was attacked and murdered by Villa bandits. The only survivor was Thomas B. Holmes, who prepared the following statement for transmission to Washington:

Our train left Chihuahua City Monday morning, January 10, at about 11 o'clock. Train was stopped at or about the ranch Parza, a point about five miles west of Santa Ysabel, between 1:30 and 2 o'clock that afternoon. While the train was standing at the station of Santa Ysabel two armed Mex-

ican ran toward the river. MacHatton and I followed. MacHatton fell. I do not know whether he was killed or tripped. Watson got running and they were still shooting at him when I turned and ran down grade, where I fell in some brush, probably 100 ft. from the rear of the train. I lay there perfectly quiet and looked around and could see the Mexicans shooting in the direction at which Watson was running. I saw that they were not shooting at me and, thinking they believed me already dead, I took a chance and crawled into some thicker bushes. I crawled through the bushes until I reached the bank of the stream. I then made my way to a point probably 100 yards from the train. There I lay under the bank for half an hour and heard shots by ones and twos and threes. I did not hear any sort of groans or yells or cries from the Americans. I then continued farther under the bank, wading the stream part of the time until I reached a point probably 200 yd. from the train. There I remained a half or three-quarters of an hour. Later, after going to several ranch houses and picking my way cautiously for several miles, I met up with an unknown Mexican, who directed me to Chihuahua City. I reached Chihuahua City Tuesday morning at about 7:30. The foregoing facts are of my personal knowledge."

The previous story of the party being lined up naked before being shot is not confirmed by Holmes.

The following are the victims:

PERCIE, C. A., San Francisco.
 WATSON, C. R., El Paso.
 WALLACE, W. J., El Paso.
 ANDERSON, MAURICE, Chihuahua City.
 COY, B. W., El Paso.
 COUCH, A., Chihuahua City.
 EVANS, T. M., Chihuahua City.
 ENDERS, JOE, Hayden, Arizona.
 HALL, ALEXANDER O., Douglas, Arizona.
 HASSIE, E. C., Miami, Arizona.
 JOHNSON, THOMAS, address unknown.
 MAC HATTON, R. P., El Paso.
 NEWMAN, G. W., El Paso.
 PEARCE, W. D., Los Angeles.
 ROBINSON, E. L., El Paso.
 ROMERO, M. B., El Paso.
 SIMMONS, R. S.
 WADSWORTH, CHARLES, Bisbee, Arizona.
 WOOM, J. W., El Paso.

Romero was a Mexican, Couch a Canadian, and Robinson an Englishman.

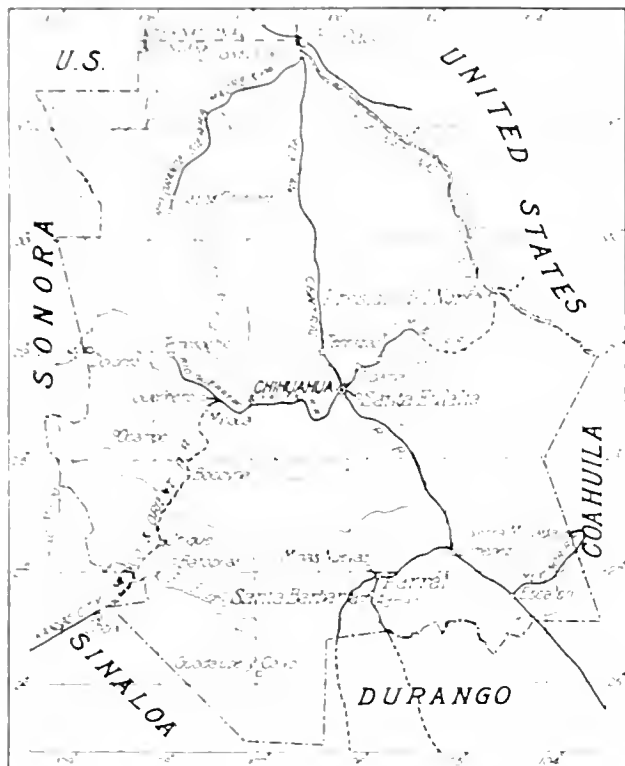

MAP SHOWING SITUATION OF EL PASO AND CHIHUAHUA

cans rode by and scrutinized the train. The Mexican passengers at Santa Ysabel told me afterward that the riders had inquired if there were any soldiers on the train. At the point of the massacre our train was stopped in a cut so that the last car was just inside of the cut. We were stopped by another train—the front trucks of one coal car being off the track. This was the first we knew of a train preceding us. There was nobody to be seen around the train in front. When our train stopped, Newman and I were sitting together, and Evans came up and looked out of our window. Evans, Newman, MacHatton and I then got off the train. Watson was either getting off or about to do so, behind us, when I looked back and saw him. Just after alighting I heard a volley of rifle shots from a point on the other side of the cut and just above the train. Looking around, I could see a bunch of about 12 or 15 men standing in a solid line, shoulder to shoulder, shooting directly at us. They were 50 to 75 feet away. The coach cut off my view, so I could not see how many bandits there were. The depth of the cut on the side near the Santa Ysabel river at that point was about 12 ft. On the other side it was much greater. To the rear of the train was an embankment declining toward the river. Watson, after getting off,

AUSTIN, TEXAS

MINERAL RIGHTS.—COPPER DEPOSITS.

It is thought that under the recent construction of the State mining law by the Attorney-General's Department, in which it was held that areas purchased under the land law of 1882 carry the mineral rights with them, and that such lands are not subject to being prospected under the mining law of 1913, promises to have the effect of retarding mineral development of such ground in the mining district of west Texas. A great number of tracts were sold under this law, classified as agricultural and grazing, and unconditional patents were issued covering many of them, but recently the State Land Commissioner has received many requests for the leasing of the mineral rights on the land in question, but under the ruling of the Attorney-General's Department applications to prospect this land for minerals cannot be granted.

The copper deposits in the 'red beds' of Hardeman, Knox, King, Haskell, Fisher, Baylor, Throckmorton, Jones, Wilbarger, Taylor, Wichita, Archer, and Clay counties, north-central Texas, are discussed by Louis M. Richard in *Economic Geology* for November-December, 1915. The area is composed of beds of limestone, gypsum, sandstone, shale, and clay, the surface being at an elevation of 1800 ft. above sea-level.

THE MINING SUMMARY

The news of the week as told by our special correspondents and compiled from the local press.

ALASKA

FAIRBANKS

Antimony production of this district is to be aided next season by the Northern Commercial Co., which has arranged to act as agents for shipments to the United States, from Fairbanks to the market. \$20 per ton will be advanced on ore at the point of shipment to help finance producers. George Coleman is agent at Fairbanks.

ARIZONA

COCHISE COUNTY

Six feet of \$44 ore has been cut at 220 ft. in the Commonwealth Extension at Pearce. The shaft is being sunk two feet per eight-hour shift.

GREENLEE COUNTY

A parade of over 1000 miners took place at Clifton on January 6; there was no disturbance. Assessment work has been completed at the Detroit claims. Some correspondence has passed between the companies' managers at El Paso and the strikers' committee, but without result.

It was reported on January 12 that the strikers had broken away from the Western Federation of Miners.

MOHAVE COUNTY

In the Big Jim mine the 400-ft. level cross-cut has passed through 50 ft. of formation, 22 ft. of which is good ore.

A station is being cut at 900 ft. in the Gold Road, while a winze is to be sunk to 1400 feet.

Drilling at the Copperfield Porphyry mine has passed through 33 ft. of good copper ore.

YUMA COUNTY

'A Reconnaissance in the Kofa Mountains, Arizona,' is the title of Bulletin 620-H of the U. S. Geological Survey, by Edward L. Jones, Jr. This isolated range is in the centre of the county. It covers an area of 200 square miles. The Kofa mining district is in the southern part of the range. The shipping point for two of the mines is Mohawk station, 45 miles distant on the Southern Pacific line, but since they were closed, Dome, 50 miles away, is more accessible. The ore deposits consist of gold-bearing brecciated zones and veins in andesite, copper replacements along sheer-zones in granite, disseminated galena in monzonite porphyry dikes, and placer deposits. In the Kofa district are the King of Arizona and North Star mines. The former, up to closing in 1910, produced bullion worth \$3,500,000. A 225-ton mill was operated. Up to 1911 the North Star yielded \$1,100,000 from milling and cyaniding. In both cases the ore became too low-grade to be profitable. Only assessment is being done around Ocotillo. In the Alamo district, in the north part of the range, prospects are considered encouraging.

CALIFORNIA

NEVADA COUNTY

Owing to snow in the ditch system of the Pacific Gas & Electric Co., the water supply of the Grass Valley district has been cut off, resulting in shut-downs.

The old Phoenix mine on Gold flat, one mile south of Nevada City, is to be re-opened by J. A. McKennie of Los Angeles, formerly of Cripple Creek, Colorado.

SAN BERNARDINO COUNTY

With a capital of 500,000 \$2 shares the Mojave Tungsten Co. has been incorporated under the laws of the State of Delaware, with head office at 165 Broadway, New York. The engineer is Foster S. Naething and assistant superintendent L. L. Draper. The company is to develop 12 tungsten claims in this county, 19 miles from Roach, Nevada, on the railroad. A good deal of work has been done, opening high-grade ore. Between No. 1 and 2 shafts is 1500 ft. of ore, as exposed by trenching. The ore will average 4% tungstic trioxide. The present equipment is satisfactory. A concentrating-plant of 25-ton capacity per eight-hour shift is to be erected at once. With an expenditure of \$10,000 to \$12,000, 300 tons of 4% and 5 tons of 20% ore can be extracted monthly; this would yield 20 tons of 60% concentrate. One hundred and twenty tons of low-grade unconcentrated ore has been sold, yielding enough to pay for the new plant, etc. The company will lease parts of its property.

Near Blythe junction on the Santa Fe railroad, 30 miles from the Colorado river, on the branch between Los Angeles and Phoenix, Arizona, is the Arica property of the Assets Realizing Mines Corporation, of Los Angeles. The main shaft is down 508 ft. Ore developed and on dumps is estimated to be worth \$629,331. Probably large bodies of copper-gold ore will be opened. A 100-ton mill, consisting of a crusher, rolls, Hardinge mill, and a continuous-decantation plant is being erected.

SANTA CLARA COUNTY

A new deposit of cinnabar is reported by E. O. Waldron and A. E. Eaton near San Jose. A 25 or 30-ton furnace will be erected in the spring. About 10 men will find employment.

SHASTA COUNTY

Four zinc claims up Cedar creek from Ingot, have been sold to F. L. Harrington of Oakland and W. H. Frickilton of San Francisco. The property is known as the Maemner.

With a capital of \$100,000 the California Chrome Co. has been organized by M. F. Hurlbut, Duncan A. McLeod, S. W. Molkenbuhr, Thomas W. Firby, and Charles F. Ryan, of San Francisco and Oakland. The mine is near Castella.

The owners of the Golden Jubilee mine, eight miles from Carrville on Coffee creek, are to employ over 40 men within the next two months, according to the superintendent, J. C. Boddiker.

SIERRA COUNTY

On January 9 two large snowslides came off the Sierra Buttes mountains above Sierra City, and swept away the compressor-house, part of the stamp-mill, and other equipment of the Sierra Buttes Mining Company.

COLORADO

'The Colorado Workmen's Compensation Act' was the subject of an address delivered by Wayne C. Williams, of the Colorado State Industrial Commission, at the Colorado School of Mines at Golden on November 5, 1915. The Act became law in April last, and Mr. Williams considers it the most salutary and important piece of legislation ever enacted into law in the State. Accidents, benefits, compensation, and insurance were well discussed. The Golden Cycle and Portland companies at Cripple Creek have made admirable arrangements for compensation.

BOULDER COUNTY

At the towns of Nederland, Lakewood, Stevens camp, Hammer gulch and Boulder Falls there are hundreds of men at work in the tungsten mines, and there is a constant stream of prospectors and mining men examining and negotiating for property. Trade, rotation of passengers is smaller than two months ago, but there is a material increase in freight shipments. It is rumored on good authority that the railroad company will find a branch down to the mills at Nederland as soon as possible. The line may be extended to Lakewood and thus secure a part of the freight between the mines and the mills of the district.

CLEAR CREEK COUNTY

During 1915 the Imperial Consolidated company shipped 1125 tons of smelting ore and concentrate, assaying \$85 and \$50 per ton respectively. The sampling-plant at Georgetown received most of it.

Company and lessee work in the Mineral Chiet mine is reported to be satisfactory.

An important development is reported by the J. D. L. Leasing Co. at Belevue mountain, where a drift from a winze below the Big Five tunnel has opened two feet of \$125 gold-silver ore. Two shifts are working.

CUSTER COUNTY

The Marion Mining & Mills Co. of Denver has erected a flotation-plant in the Greuthorn range, 27 miles from the D. & R. G. line. The plant will treat 100 tons of tailing from concentrators. The ore contains 15% zinc, the tables making a 48 to 55% concentrate.

LAKE COUNTY (LEADVILLE)

The Iron-Silver Mining Co.'s Moyer mine is shipping 1500 tons of zinc, lead, and iron sulphide ores per month; its Tucson mine produces 1600 tons of zinc-lead sulphide. Lessees are mining zinc carbonate. G. O. Argall is general manager.

The *Carbonate Chronicle* gives the following figures as the output of Leadville in 1915:

| Classes of ore, | Tons. |
|-----------------------------|---------|
| Carbonate | 27,756 |
| Iron and manganese | 43,714 |
| Sulphide | 219,763 |
| Zinc carbonate and sulphide | 196,899 |
| Silicious | 41,091 |

| | |
|---------------|---------|
| Total | 532,217 |
| Total in 1914 | 592,617 |

| Product, | Quantity, | Value. |
|-----------------|------------|-------------|
| Gold, ounces | 115,121 | \$2,379,551 |
| Silver, ounces | 2,732,646 | 1,361,355 |
| Lead, pounds | 18,534,952 | 865,540 |
| Copper, pounds | 2,254,268 | 387,059 |
| Spelter, pounds | 74,298,915 | 10,276,725 |
| Manganese, tons | 6,250 | 625,000 |

| | |
|---------------|--------------|
| Total | \$15,895,220 |
| Total in 1914 | \$9,087,628 |

The grand total is \$431,433,918.

OURAY COUNTY

Bids are being received for driving the Camp Bird's 9000-ft. adit from the mill to the mine. One of the bidders is J. P. Karns, who has devised a tunneling machine of large capacity, and which was tried recently in Utah.

TELLER COUNTY (CRIPPLE CREEK)

The annual number of *The Cripple Creek Times* consists of 52 pages, mostly devoted to mining, edited by Sam W. Vidler, from which the following data are taken:

The December output was \$1,352,000 from 82,750 tons of ore.

The smelters average was \$60 per ton, an increase of \$5.

The total production in 1915 was \$16,189,727 from 982,897 tons of ore. The largest month was March, with \$1,986,493 from 76,618 tons, when the Cresson mine shipped so much rich ore. Its output last year was \$1,983,200 from 60,000 tons of ore. The Cripple Creek district has produced \$354,761,653 to date.

The approximate outputs last year were as follows:

| Mills | Tons. | Value. |
|--|-----------|-------------|
| Golden Cycle (own mine and custom ore) | 1,407,950 | \$9,179,650 |
| Portland (Cripple Creek) | 1,211,415 | 612,179 |
| Portland (Colorado Springs) | 1,128,000 | 2,600,000 |
| Portland (Stratton's) | 66,700 | 155,284 |
| Stratton's Independence | 55,256 | 169,755 |
| Colburn-Ajax | 15,235 | 105,577 |
| Gaylord | 9,700 | 26,700 |
| Neville-Free Coinage | 8,152 | 28,228 |
| Kavanaugh-Jo Dandy | 6,800 | 13,600 |
| Wild Horse | 3,739 | 15,105 |
| Isabella | 1,500 | 3,900 |
| Caley | 4,917 | 19,061 |
| Smelters | 52,692 | 2,914,250 |

Dividends paid by listed corporations were as follows:

| | |
|--|-------------|
| Golden Cycle Mining Co. | \$3,495,000 |
| Portland Gold Mining Co. | 360,000 |
| Vindicator Consolidated Gold Mining Co. | 225,000 |
| Elkton Consolidated Mining & Milling Co. | 50,000 |
| El Paso Consolidated Gold Mining Co. | 50,000 |
| Mary McKinney Mining Co. | 26,185 |

Total \$4,206,185

Dividends of close corporations were as follows:

| | |
|---|-------------|
| Cresson Consolidated Mining & Milling Co. | \$1,000,000 |
| Stratton's Cripple Creek Ltd. (sale of property, estimated) | 500,000 |
| Strong Gold Mining Co. (estimated) | 250,000 |
| Stratton's Cripple Creek Mining & Development Co., the Stratton Estate, (estimated) | 50,000 |
| Gold King Mining Co. | 10,000 |

Total \$1,810,000

Profits of leasing companies and lessees, closely estimated \$ 500,000

Grand total of dividends and lease profits \$6,516,185

In 10 months the Roosevelt drainage-tunnel was extended 1920 feet; since August 1 the monthly rate has been 300 ft. The heading is within 250 ft. of the Elkton main shaft. Fifty-two men are employed in charge of C. Fuller. The total subsidence of water was 149 ft. The total water discharged last year was 5,550,000,000 gal., equal to 37,000,000 gal. per vertical foot, according to T. R. Countryman. The water has a temperature of 70° F.

There are now four producing mines on the recently-opened Tenderfoot hill, namely the Ella W., Queen Bess, Black Diamond, and the Hickman lease. Prospects are good.

Mill employees of the Golden Cycle and Portland companies at Colorado Springs have been given an advance of 25c. per day. This applies to those receiving less than \$3 per day.

As Colorado went 'dry' on January 1, 30 saloons closed their doors in the district.

On January 10 the Golden Cycle Mining & Reduction Co. paid dividend No. 105, amounting to 2c. per share, equal to \$20,000. With this distribution the shareholders will have received a total of \$7,338,000.

IDAHO

SHOSHONE COUNTY (COUER D'ALENE)

An extensive deposit of scheelite has been opened in the

Golden Chest mine at Murray, and shipments of rich ore are being made. Fifteen men are working three shifts. Three sacks, worth \$675, were stolen last week.

An Ingersoll-Rand compressor of 2000-cu. ft. capacity, costing \$11,000, to be driven by a 250-hp. General Electric motor, is being installed at the Red Monarch in Missoula gulch. Ore-cars, pumps, pipes, steel, etc., has also been purchased.

MICHIGAN

THE COPPER COUNTRY

From January 1 to July 1, 1916, the Calumet & Hecla and its subsidiaries will pay all employees a premium of 10% on their monthly wages. Twelve thousand men will be affected, receiving at least \$500,000 over the normal amount for the period. This voluntary gift does not bear out the accusations made against these companies during the strike of two years ago.

opened is valued at \$1,000,000. Wide stopes have been opened. G. T. Hansen in manager.

LEWIS AND CLARK COUNTY

On February 1 the Scratch Gravel Gold Mining Co. will pay 2c. per share, or \$20,000, the first monthly. Some excellent ore is ready for the mill all the time.

NEW MEXICO

GRANT COUNTY

The property of the Savanna Copper Co., in the Burro Mountain district, has been sold for \$700,000 cash, or, it is reported, the Burro Mountain Copper Co., a Phelps-Dodge subsidiary.

Other large mining transactions in this State of recent date are the sale of the Carlisle mine, Steeplerock district, for



THE BONNEY MINE, LORDSBURG, NEW MEXICO.

—The Copper Range company, controlling the Baltic, Champion, and Trimountain, will also pay a bonus to employees, amounting to 15%, for January and February. About 3000 men will benefit.

MISSOURI

JASPER COUNTY

An indication of the great amount of work done in the zinc-lead region is shown by a comparison of electricity sold by the Empire District Electric and Ozark Power & Water companies during the four weeks ended December 4, 1915, and that period of 1914:

| Company. | 1915 kilowatt-hours. | 1914 kilowatt-hours. |
|--------------|-------------------------|-------------------------|
| Empire | 6,621,830 | 4,301,710 |
| Ozark | 2,946,600 | 353,100 |

During this period of 1915 the net increase in load actually connected to the lines, after allowing for disconnections, was 1496½ hp. The power department secured 1815 hp. in new contracts and additions to existing contracts during this period, most of the business being of the latter character.

MONTANA

BEAVERHEAD COUNTY

The new owners of the Bannaek gold mine, J. H. McClement and F. G. Corning of New York, have paid the first installment of \$40,000, out of the sale price of \$240,000. About \$125,000 has been spent by them in development and a new mill. Ore

\$300,000; the Mogollon Gold & Copper mine, Cooney district, for \$100,000; and the Bonney mine at Lordsburg for \$25,000.

NEVADA

ESMERALDA COUNTY

The estimated production of the Goldfield Consolidated company in December is as follows:

| | |
|--------------------------|-----------|
| Ore mined, tons | 35,000 |
| Gross extraction | \$212,000 |
| Operating expenses | 161,000 |
| Net realization | \$51,000 |

An area of 900 acres of copper claims in the Cuprite district, 13 miles south of Goldfield, has been purchased by ex-Senator W. A. Clark of Montana, from Ellsworth Oldt, a pioneer of that district. A good deal of ore has been developed. Work has been started in charge of H. Evans.—The Rea mine, several miles west, was recently sold to large copper interests. Its prospects are also good.

HUMBOLDT COUNTY

Since work was started by the Rochester Mines Co. early in 1913, the output by the company and lessees totaled \$1,015,345 from 52,282 tons of ore to the end of 1915. Mine openings amount to 18,000 feet.

Supposed barren ground of the Nevada Packard is now showing \$52.70 ore; this is in the south drift off the D. adit.

Good results are reported from the Packard North Extension; more men have been started.

During 1915 the Seven Touches Coalition company produced \$116,084 gold and silver from 4,092 tons of ore, and paid 144 dividends amounting to \$189,748. Total distributions are \$216,192. The ore treated, which came from all parts of the mine, averaged about \$97 per ton.

NAI COUNTY

Five companies and 60000 tons at Tonopah last week produced 2943 tons of ore worth \$294,934. The Tonopah Extension or West End Consolidated quarrel has gone a step further in that the plaintiff wishes the defendant restrained from cross-cutting away from the area prescribed in the modified order of Judge Averill on December 7, 1915. The Court was to hear the case on January 7, and in the meantime the defendant was restricted in its work in the disputed ground.

STOREY COUNTY

The Mexican Gold & Silver Mining Co. has levied an assessment No. 193 of 10¢ per share. The directors state that the last assessment levied on Mexican stock was on December 6, 1910. Since that time the ore discovered on the 2500 ft. level, in what was supposed to be barren ground, has enabled them to pay \$171,369 in dividends, to build a modern mill at a cost of over \$1,000,000, and to contribute heavily toward the pumping of the Comstock lode, and toward the present equipment of the North End mines in general. At no time during the past 29 years have the mines at the north end been so admirably equipped and harmoniously managed, and the discovery of the ore in Union and Sierra Nevada, is but additional proof of the possibilities in depth. The discovery of the ore in the Union and Sierra Nevada mines on what is known as the main Comstock or foot wall fracture has doubly affected the Mexican. In the first place its mill, which has been comparatively idle, now becomes an asset of the first importance, since it is the only efficient and modern plant on the ground; in the second place it opens possibilities in that same fracture to the Mexican, as a large section of the vein in its property on the 2500-ft. level and below has never been explored. This exploration has now begun, and there is, in addition to the great possibilities existing at 2700 ft. and below, in the east vein, equal or even greater possibilities in the main Comstock. The mill is now treating all the ore produced by the Union and Sierra Nevada mines at a good profit but it was necessary to secure large supplies of cyanide and zinc-dust in order to insure continuous operation. On account of the War, these articles had risen greatly in price, and in fact it was with the greatest difficulty that they were obtained at all in sufficient quantities. To defray the expenses of exploration and mill equipment, therefore, the present management levies its first assessment, and can only assure the stockholders that every effort is being made to uncover ore, and that of the ultimate success of these efforts the management has no reason to doubt.

OREGON

BAKER COUNTY

Work has been resumed at the Iron Dyke copper mine at Homestead, after years of idleness. The lessees are shipping two cars of ore a day to Huntington, then to Colorado. They are erecting a bunk and boarding-house for 150 men.

The Cornucopia company has a number of men developing its Wilson claims.

The revival along the Snake river is of interest.

SOUTH DAKOTA

LAWRENCE COUNTY

The Wasp No. 2 mill is treating up to 175 tons of gold ore per day, or 30% of capacity, but better ore has been opened lately. The new tungsten concentrator is at work. The last shipment of this ore was 26 tons worth \$54,000, instead of \$48,000, as previously published.

UTAH

JAN COUNTY

Shipments from the Tintic district last year totaled 6458 cars, the principal contributors being as follows:

Chief Consolidated, 1109; Iron Blossom, 1067; Centennial Lumber, 1005; Stony mill dump, 659; Eagle & Blue Bell, 563; Mammoth, 523; Gemini, 279; Grand Central, 209; Dracoon Consolidated, 181; May Day, 130; Gold Chain, 105; and Lower Mammoth, 97. There were 27 other producers ranging from 20 to 4 car.

The new plant of the Tintic Milling Co. will be completed in a few weeks.

The low grade dump at the May Day, 50,000 tons, is to be treated by the Utah Minerals Concentrating Co., whose plant is kept busy on ore from various mines of the district. Part of this dump was exanided.

SALT LAKE COUNTY

The new copper shoot in the Bingham-New Haven section of the Utah Metal property is 100 ft. lower than any ore found previously. On the 850-ft. level two feet assays 3% copper and 19.5 oz. silver per ton. The mill is treating 140 tons a day. Earnings in December were \$50,000.

During the year ended August 31, 1915, the Utah Apex company's revenue was \$818,821, of which \$271,197 was profit. Owing to peculiar conditions large ore reserves cannot be opened, so continuous development is necessary. A process is being tried to separate the lead and zinc.

The Sells mine in the Little Cottonwood district sent out its first car of ore from the recent development. It settled for \$41.76 per ton. The moisture was 21 per cent.

SUMMIT COUNTY

Owing to the cold weather and shortage of water, the Big Four mill, treating tailing below Park City, is closed. The Daly West mill may also be stopped for a time.

The Snake Creek tunnel was advanced 341 ft. in December, and 3273 ft. in 10 months. The last 50 ft. was in diorite. The flow of water was 19 second-feet on January 2, nearly double that of a year ago. The heading is in 12,721 feet.

WASHINGTON

SILVER COUNTY

A 100-ton electro-chemical plant is to be erected by the Bimetallic Milling Co. at Turk, 25 miles west of Springdale. E. O. Weston of Spokane is president of the concern. Contracts have already been made for treatment of ore from several mines. The Fields' process is to be used. The plant will be either driven by steam or gas engines.

Two zinc furnaces are to be erected at the Northport smelter, in addition to the copper and lead furnaces. Zinc ore from the Coeur d'Alene of Idaho will probably supply the new plant.

By the installation of an Oliver filter the United Copper Co. at Chewelah expects to reduce expenses by \$2000 per month.

CANADA

ONTARIO

The mining industry of this Province in 1915 is briefly discussed by Thos. W. Gibson in the January Bulletin of the Canadian Mining Institute. He estimates the production as follows:

| Metal | 1915. | 1914. |
|--------------|-------------|-------------|
| Copper | \$2,700,000 | \$2,081,332 |
| Gold | 8,000,000 | 5,529,767 |
| Nickel | 7,200,000 | 5,169,088 |
| Silver | 10,750,000 | 12,795,214 |

Copper and nickel were in great demand, hence the increase; the Porcupine district is responsible for the larger gold output; low prices affected silver production at Cobalt.

MEXICO

According to Wilbert L. Bonney, U. S. Consul at San Luis Potosi, for the first time in months there appears to be a possibility of a gradual and part resumption of mining and ore treatment in the San Luis Potosi district. The operation of these industries depends on so many diverse factors that it is impossible to set any date for resumption, but conditions are now more favorable and the problems of operation are being taken up for solution. The mines cannot work until the smelters can take care of their product, and the smelters require regular transportation and the use of 60 to 80 cars per day continually for their operations. It is further necessary to assemble foreign employees from various parts of the United States and to have a stock on hand and a continuous inflow of supplies, such as dynamite, cyanide, coke, oil, chemicals, and repair parts that have become entirely exhausted. For the operation of the lead smelter it is necessary to purchase lead, copper, limestone, and other ores for making the necessary combinations, and some of these ingredients must be brought from distant parts.

For the financing of all these operations it is necessary that the product be exported and sold promptly, and in order to avoid an expensive shut-down all the processes must be continuous. San Luis Potosi depends upon the Tampico railway for nearly all of its heavy freight, and that line must be kept open if the lead smelter is to operate. The minimum steamer load of coke arriving at Tampico for the smelter is 3000 tons, or about 150 carloads.

The experience of the smelters has been unfortunate for the last two years, and attempts to operate in other districts have served to discourage the San Luis Potosi companies. The Monterrey smelter No. 3, which has the advantage of proximity to the frontier and to the Coahuila coalfields, attempted to resume in July. After about three weeks, during which stocks on hand were used up, it was found impossible to continue by reason of failure of transportation. The smelting company bought and paid for 25 cars of oil in Tampico, but was able to secure delivery of only 5 cars. In San Luis Potosi the cost of coke and other heavy material by rail from the frontier is prohibitive; they must come by water to Tampico.

In addition to the necessities already named, the smelter must have a constant supply of water in its dams. The 1915 season has been dry, and there is not at present sufficient water for use of the smelter. Considerable local difficulty is experienced on account of new and increased wage demands, and careful negotiation in this respect will be necessary. Difficulties are also experienced by reason of the fluctuation of the paper money in which labor is paid.

In these circumstances individuals operating small mines will find it practicable to begin taking out ore while the large organized companies are discussing the solution of their various problems. The conditions herein described apply to the mining and smelting of silver, lead, copper, antimony, and sulphur.

According to Thomas H. Bevan, U. S. Consul at Tampico, the attention of the oil interests during the week of December 10 centred on the well of the Pan American Oil Co., at Panuco, which was brought in on the first of the month and has been conservatively estimated to have a production of 2000 bbl. per day. Oil was first struck at a depth of 1760 ft., and drilling was immediately suspended.

There has been considerable leasing of oil lands in the southern fields during the past two months. A number of companies that now have production in the Panuco field have taken up leases in the Tuxpam fields where a lighter gravity of oil is found. The Compania Mexicana de Petroleo "El Aguila" S. A., is now making preparations to commence drilling again in the State of San Luis Potosi near Valles. The company drilled three wells in this territory over two years ago, which are the deepest oil wells in Mexico.

PERSONAL

LUTHER WAGONER has gone to Havana, Cuba.

R. B. LAMB, of New York, is at Oatman.

S. J. SPEAK has returned to London from South Africa.

WILLIAM Y. WESTERVELT has returned to New York from Cuba.

RALPH STOKES has been promoted to captain in the Royal Engineers.

T. P. MCNAMARA is superintendent of the Dome mine near Porcupine.

F. DORRION is manager for the Corocoro United Copper mines, Peru.

HARRY JAMES passed through San Francisco on his way from Denver to Honolulu.

K. P. SWENSEN, of the F. W. Horne Co. of Tokyo, returned to Japan on January 8.

A. A. COLE of Cobalt has been nominated for president of the Canadian Mining Institute.

B. M. MCATEE is now foreman in charge of flotation at the Inspiration mine, near Miami, Arizona.

L. W. ORYNSKI is superintendent of the Skidoo Mines Co., California, L. S. PRESTON resigning on December 31.

C. E. GRUNSKY, JR., has been elected secretary-treasurer for the San Francisco section of the American Institute of Mining Engineers.

O. G. ENGELDER, formerly in the geological department of the Calumet & Arizona company at Bisbee is in Rosas, Sardinia, Italy.

L. E. YOUNG, professor of mining in the University of Illinois, has been giving a series of lectures on the 'Economics of Mining' at the University of California.

HOWLAND BANCROFT has just returned to Denver from several months' absence in South America and leaves within a few days to make his headquarters in Chile during the next two years.

ROSWELL H. JOHNSON, Professor of Geology in the University of Pittsburg, attended the second Pan-American Scientific Congress at Washington, D. C., and read a paper upon 'The Conservation of Oil and Gas.'

Associated with WILLIAM J. COX, general manager of the Camp Bird at Onray, Colorado, are J. B. GLASSER, assistant manager; JOS. H. SCOTT, mine superintendent; and THOMAS H. WOODS, mills superintendent, according to the recently-issued annual report.

EDWIN HIGGINS, mining engineer of the Bureau of Mines, has been appointed Chief Mine Inspector for the Industrial Accident Commission in California, in succession to H. M. WOLFLIN, who has been promoted to the post of Mine Safety Engineer in the Bureau of Mines, with headquarters at Pittsburg.

According to the recently-issued annual report of the Consolidated Mining & Smelting Co. of Canada, operating in British Columbia, the present staff is as follows: R. H. STEWART, general manager; S. G. BLAYLOCK, assistant general manager; T. W. BINGAY, comptroller; JAMES BUCHANAN, superintendent of smelter; M. H. SULLIVAN, assistant superintendent of smelter; J. F. MILLER, superintendent of refinery; F. W. GUERNSEY, in charge of zinc experimental work; C. H. McDougall, engineer in charge of construction at smelter; M. E. PURCELL, superintendent Centre Star group of mines; E. G. MONTGOMERY, assistant superintendent; F. S. PETERS, superintendent Le Roi mine; J. K. CRAM, St. Eugene and Sullivan mines; W. M. ARCHBOLD, mining engineer in charge of Ainsworth and Slocan properties.

THE METAL MARKET

METAL PRICES

San Francisco, January 13

| | Cents per pound |
|-------------------------------------|-----------------|
| Antimony | 13 |
| Fluor spar | 25 |
| Pick lead | 6 1/2—7.20 |
| 2 1/2 lbs. Van. per flask | \$165 |
| Spelter | 20 |
| Tin | 15 |
| Zinc dust, 100-kg. zinc lined cases | 30 |

ORE PRICES

San Francisco, January 13

| | |
|---|---------|
| Vanadium, 80% product, per unit | \$2.25 |
| Chromite, 40% and over, for 4 cars California, per ton | 15—18 |
| Magnesian crude, according to quality and quantity, per ton, f.o.b. | 7.50—10 |
| Magnesite, plastic, no iron and lime, calcined, per ton | 50 |
| Magnesite, refractory, up to 7% iron, calcined, per ton | 30—40 |
| Manganese, 70% metal, 8% silica, per ton, f.o.b. cars, S. P. | 12 |
| Tungsten, minimum 65% W ₂ O, per unit for spot | 10—50 |

The following prices were paid for one lot of tungsten concentrates at Boulder, Colorado, last week: 60.9% \$47.50, 49.7% \$44.75, 41.5% \$41.00, 28.6% \$37.50, and 17.3% \$29 per unit.

New York, January 7

| | |
|--|-------------|
| Antimony, 100% product | \$2.00—2.10 |
| Manganese, 80% metal, f.o.b. New York, per ton | 70.00 |
| Molybdenum, 95% per lb. | 1.50 |
| Tungsten, according to position | 10.00—50.00 |

EASTERN METAL MARKET

(By wire from New York)

NEW YORK, January 13. Copper producers are firm, resellers are strong, lead is easier and unsettled; zinc is quiet at 19 1/2.

SILVER

Below are given the average New York quotations, in cents per ounce, of fine silver.

| Date | Average week ending |
|------------|---------------------|
| Jan. 8 | 56.62 |
| " 7 | 56.62 |
| " 8 | 56.25 |
| " 9 Sunday | 56.70 |
| " 10 | 56.75 |
| " 11 | 57.00 |
| " 12 | 57.00 |

Monthly averages.

| 1914 | 1915 | 1914 | 1915 |
|-------|-------|-------|-------|
| Jan. | 57.58 | 48.85 | 51.90 |
| Feb. | 57.51 | 48.45 | 51.35 |
| M. F. | 57.01 | 50.91 | 53.75 |
| Apr. | 58.72 | 50.27 | 51.12 |
| May | 58.21 | 49.87 | 49.12 |
| June | 58.42 | 49.03 | 49.27 |

A strong advance and steady rise about sums up the silver market.

Three companies at Tonopah shipped about 350,000 oz. bullion last week. This is worth 700 per oz. The Jim Butler pays 190 per ounce for \$171.872.

Bullion shipments from Colorado last year were 915,147 oz., not including refined concentrates.

COPPER

Prices of the metal in New York, in cents per pound.

| Date | Average week ending |
|------------|---------------------|
| Jan. 8 | 23.59 |
| " 7 | 23.62 |
| " 8 | 23.75 |
| " 9 Sunday | 23.87 |
| " 10 | 23.87 |
| " 11 | 23.59 |
| " 12 | 23.59 |

Monthly averages.

| 1914 | 1915 | 1914 | 1915 |
|------|-------|-------|-------|
| Jan. | 14.21 | 17.60 | 13.26 |
| Feb. | 14.46 | 14.58 | 12.34 |
| Mch. | 14.11 | 14.89 | 12.92 |
| Apr. | 14.19 | 16.84 | 11.16 |
| May | 13.97 | 18.71 | 11.75 |
| June | 13.60 | 19.75 | 12.75 |

Exports during the week ended December 26 totaled 3,861,413 lb., valued at \$1,907,520. England took 3,477,158 lb., France, 200,048 lb., and Italy, 1,295,332 lb. Imports amounted to 10,181,249 lb., worth \$1,824,242. Chile sent 5,896,927 lb., and Peru 3,488,291 pounds.

The A. S. & R. Co. in 1915 had a balance of 13% for the common stock. Calumet & Arizona made \$10 per share net last year, and Ray \$3.10.

The Tennessee Copper Co.'s acid plant is closed indefinitely. This will affect earnings considerably.

LEAD

Lead is quoted in cents per pound, New York delivery.

| Date | Average week ending |
|------------|---------------------|
| Jan. 8 | 5.75 |
| " 7 | 5.90 |
| " 8 | 5.90 |
| " 9 Sunday | 5.90 |
| " 10 | 5.90 |
| " 11 | 5.90 |
| " 12 | 5.90 |

Monthly averages.

| 1914 | 1915 | 1914 | 1915 |
|------|------|------|------|
| Jan. | 4.11 | 3.73 | 3.80 |
| Feb. | 4.02 | 3.83 | 3.86 |
| Mch. | 3.94 | 4.01 | 3.82 |
| Apr. | 3.86 | 4.21 | 3.69 |
| May | 3.90 | 4.24 | 3.68 |
| June | 3.90 | 5.75 | 3.80 |

The Hecla company, Idaho, is paying 100¢ per share, or \$100,000.

QUICKSILVER

The primary market for quicksilver is San Francisco, California being the largest producer. The price is fixed in the open market, according to quantity. Prices, in dollars per flask of 75 pounds:

| Date | Week ending |
|---------|-------------|
| Dec. 15 | 130.00 |
| " 22 | 130.00 |

Monthly averages.

| 1914 | 1915 | 1914 | 1915 |
|------|-------|-------|-------|
| Jan. | 39.25 | 51.90 | 37.50 |
| Feb. | 39.00 | 60.00 | 39.75 |
| Mch. | 39.00 | 78.00 | 76.25 |
| Apr. | 38.90 | 77.50 | 53.00 |
| May | 39.00 | 75.00 | 55.60 |
| June | 38.60 | 59.00 | 52.19 |

ZINC

Zinc is quoted as spelter, standard Western brands, New York delivery, in cents per pound.

| Date | Average week ending |
|------------|---------------------|
| Jan. 8 | 17.39 |
| " 7 | 17.50 |
| " 8 | 17.50 |
| " 9 Sunday | 17.50 |
| " 10 | 17.50 |
| " 11 | 17.50 |
| " 12 | 17.50 |

Monthly averages.

| 1914 | 1915 | 1914 | 1915 |
|------|------|-------|------|
| Jan. | 5.14 | 6.39 | 4.75 |
| Feb. | 5.22 | 9.05 | 4.75 |
| Mch. | 5.12 | 8.40 | 5.16 |
| Apr. | 4.98 | 9.78 | 4.75 |
| May | 4.91 | 17.93 | 5.01 |
| June | 4.81 | 23.29 | 5.40 |

Prices of zinc are nearly double those of a year ago in the Missouri-Kansas-Oklahoma region. The first week's output was 6745 tons blende, 122 tons calamine, and 1061 tons lead, averaging \$94, \$63, and \$74 per ton, respectively. The total was \$721,109.

TIN

Prices in New York, in cents per pound.

| Date | Average week ending |
|------------|---------------------|
| Jan. 8 | 37.85 |
| " 7 | 39.72 |
| " 8 | 38.16 |
| " 9 Sunday | 36.16 |
| " 10 | 33.29 |
| " 11 | 39.72 |
| " 12 | 39.72 |

Monthly averages.

| 1914 | 1915 | 1914 | 1915 |
|------|-------|-------|-------|
| Jan. | 27.85 | 34.49 | 31.60 |
| Feb. | 39.72 | 37.22 | 50.20 |
| Mch. | 38.16 | 48.76 | 33.16 |
| Apr. | 36.16 | 48.25 | 36.40 |
| May | 33.29 | 39.28 | 33.51 |
| June | 39.72 | 40.26 | 32.60 |

Tin is quiet at 41 cents.

Eastern Metal Market

New York, January 7.

As might be expected after the recent heavy purchases, domestic inquiry for copper is quieter, but the export inquiry continues very heavy, and probably will support the market for a time at its present level of 23 to 24c. Zinc has not moved in sympathy with copper, but its quotations are fairly well maintained. Lead is extremely strong, three advances having been announced within the week, all of which is principally due to foreign activity. Tin has had its ups and downs because of unconfirmed rumors. Antimony is scarcer than ever for spot delivery, and is quoted up to 43c. Aluminum is easier.

The prospects before the iron and steel trade are unprecedented. Heavy specifications continued to come out to the very end of 1915, and began promptly again with the first working day of the new year. Steel capacity in 1916 will be increased 4,265,000 tons by new furnaces now under construction or planned. The pig-iron output in December made a further gain, although the season is usually one of slower operations; the month's production was 3,203,322 tons, or 103,333 tons per day. Pig-iron is now being made at the rate of 38,000,000 tons per year. The 'fly in the ointment' is labor trouble, which has broken out virulently at Youngstown, Ohio, while farther East there are minor strikes at steel plants. The Steel Corporation, and most of the independents, have voluntarily agreed to increase the wages of common labor 10%, and of other labor proportionately.

COPPER

Both here and in London copper shows great strength, and in regard to prices both markets seem to have got beyond control. The New York quotation for prompt electrolytic, January 6, was 23.50c., cash, while the quotation in London on that day was £114. Lake was nominal on the same day at the same price. The features of the present situation are these: electrolytic producers are well sold up to April, while makers of Lake are booked until June; spot electrolytic is scarce and current trading is principally in positions one or two months off; consumers are well covered as a result of their recent activity, but there is a great foreign demand which has not yet been satisfied. As a matter of fact, it is the foreign demand that is supporting the market. A representative of one of the large copper companies said early this week that export inquiry was pouring in on his company, but that it had not, up to that time, resulted in a proportionate amount of actual business. In view of their sold-up condition, many of the producers would be pleased if there came a general lull in buying, for they have taken on heavy commitments to supply, not what they have, but what they must make, and some are becoming a little uneasy. The entire atmosphere is most bullish, and predictions of copper at 25c. or higher, are freely made. As the quotations go up consumers become more frightened and more inclined to buy ahead. Exports in December reached the comparatively large total of 32,936 tons, making the month the record one of the year, the largest previous monthly total having been 30,148 tons in March. The base price of sheet copper was advanced this week to 30c. The summary of December exports shows that the United Kingdom received 8590 tons; France, 14,501 tons; Holland, 398 tons; Italy, 5154 tons; Denmark, 300 tons; Sweden, 2867 tons; Russia, 400 tons; and others, 726 tons. Electrolytic at London is quoted at £114.

ZINC

In strange contrast with copper, zinc has been quiet, almost dull, and continuously so for several days. Quotations have changed but little, but that little has been downward, the

New York quotation during the greater part of this week standing at 17.30c., for prompt delivery metal. Today the New York quotation is 17.50c. Practically the only interest shown has been in spot or nearby, and the indifference of the consumers has brought out some pressure to sell. The report of the U. S. Geological Survey on January 3 stated that stocks in producers' hands on December 15, 1915, amounted to 20,758 tons, against 5884 tons on June 30. It had the effect of making some sellers a little more ready to part with their holdings, and business was done the following day at or near 17.15c., St. Louis, for spot, 17c. for January, 16.15c. for February, and 15.50c. for March. Exports in December totaled 6103 tons.

LEAD

The A. S. & R. Co. advanced its New York quotation on December 31 to 5.50c., an increase of \$2 per ton; on January 4, it announced another advance of \$5 per ton, or to 5.75c., New York, and on the 7th its quotation went to 5.90c., New York. All of these were expected. A great quantity of lead has been purchased in the past week or ten days, and export requirements promise a continuance of demand. Russia has been a very heavy buyer, both directly and through agents, while others, both at home and abroad, have been eager buyers also. To a considerable extent the situation is much the same as exists in copper, though not so acute. The December exports totaled 6775 tons. The London market is strong at £31 15s., an advance of £2 15s. in about 10 days.

TIN

This metal has been most unsettled. On various days there has been a fair amount of business in tin afloat, or for shipment from the Far East, but prompt and nearby has been scarce and to a large extent inactive. Considerable excitement was created on January 3 by a report that a Japanese steamer, the *Kenkon Maru*, en route from the Straits to London, had been sunk in the Mediterranean with a large quantity of tin, but up to the present time it has not been entirely cleared up as to whether the vessel lost really had tin among its cargo. It appears that there are several ships bearing the name *Kenkon Maru*. In the excitement occasioned by the report, which had it that probably 1000 tons of tin had been lost, the spot quotation advanced 2c., or from 40.50 to 42.50c. On the 4th the furor had not subsided, and spot tin went to 45c.; on the 5th the quotation dropped to 44.75c., and the 6th to 42.50c. Deliveries into consumption in December reached the excellent total of 5200 tons. Total deliveries in 1915 were 47,835 tons, against 41,700 tons in 1914. In stock and landing at the end of the month was 1371 tons, and afloat there was 8125 tons. The total visible supply on December 31, 1915, was 16,216 tons, against 13,396 tons on the same date of 1914.

ALUMINUM

No. 1 virgin aluminum, 98 to 99% pure, is quoted at 54 to 56c., in a dull and uninteresting market.

ANTIMONY

The supply of spot antimony is so limited that the quotation is nominal. The price quoted is 43c., duty paid, for Chinese or Japanese grades. There are some arrivals in prospect, but they are stated to have been sold and will not relieve the situation.

The U. S. Geological Survey and the Mint report that the gold output of the country in 1915, including Alaska, the Philippines, and Porto Rico, was \$98,891,100, an increase of \$4,359,300. Save one, all States showed advances.

The silver output was 67,485,600 oz. averaging 51c. per oz. Montana was probably first, having overtaken Nevada.

Metal Production in 1915

LEAD

The lead industry in 1915 made good gains in output, both in mining and smelting. The lead content of ore mined in the United States was approximately over 600,000 short tons, compared with 522,804 tons in 1914, an increase of 15%. With the higher prices prevailing the percentage of increase in value of the 1915 output was even greater when compared with other years. The following estimates have been compiled by C. E. Sieenthal from reports to the Survey by all the lead refineries and soft-lead smelters in operation during the year, except two smelters in the Jordan district, for which estimates have been made.

The production of refined lead, desilverized and soft, from domestic and foreign ores in 1915 was approximately 565,000 tons, worth at the average New York price \$53,119,000, compared with 542,122 tons, worth \$42,285,500, in 1914, and with 462,460 tons in 1913. The figures for 1915 do not include an estimated output of 29,550 tons of antimonial-lead, worth \$1,886,000, against 16,667 tons in 1914 and 16,665 tons in 1913. Of the total production, desilverized lead of domestic origin, exclusive of desilverized soft lead, is estimated at 306,682 tons, against 311,069 tons in 1914 and 259,578 tons in 1913, and desilverized lead of foreign origin at 48,318 tons, compared with 29,328 tons in 1914 and 59,582 tons in 1913. The production of soft lead, mainly from Mississippi Valley ores, is estimated at 210,000 tons, compared with 201,725 tons in 1914 and 161,300 tons in 1913. The total production of lead, desilverized and soft, from domestic ores, was thus about 516,682 tons, compared with 512,794 tons in 1914.

Imports of lead are estimated at 9625 tons of lead in ore, valued at \$653,000; 59,825 tons of lead in base bullion, valued at \$3,496,000, and 400 tons of refined and old lead, valued at \$28,000—a total of 69,850 tons, valued at \$4,177,000, compared with 28,338 tons in 1914. Of the imports in 1915 about 58,000 tons came from Mexico, against 23,141 tons in 1914. These imports from Mexico are to be compared with an average of over 100,000 tons before the civil strife in that country. The remaining imports of lead came mostly from Chile.

Exports of lead of foreign origin smelted or refined in the United States again show an increase, being estimated at 43,000 tons, against 31,951 tons in 1914 and 54,301 tons in 1913. For the last two years, on the other hand, notable quantities of domestic lead have been exported to Europe, and the total for 1915 is estimated at 76,000 tons, valued at \$6,650,000, compared to 58,722 tons, valued at \$4,591,974 in 1914.

The average New York price for the year was 4.7 cents a pound, compared with 3.9 cents in 1914 and 4.4 cents in 1913.

ZINC

Both the zinc smelting and the zinc mining industries of the United States enjoyed a year of unparalleled prosperity in 1915. According to the best information obtainable at this time the recoverable zinc-content of zinc ores mined was over 560,000 short tons, compared with 497,000 tons in 1914 and 418,000 tons in 1913. With a continuance of high price for spelter during 1916 the output will be greatly augmented, for the very high prices did not begin until April and May and it was naturally some time before much additional zinc mining could get under way. Production during the last quarter of the year was at a much higher rate than during the first quarter.

There was a large increase in smelting capacity during the last half of the year, the total number of retorts at the end of the year being 154,898, compared with 139,842 at the midyear, and with 113,914 at the beginning. In addition, 20,758 retorts were under construction or planned.

It seems certain that the zinc reduction capacity of the United States will soon be equal to every conceivable call upon it.

The following figures have been compiled without change by C. E. Sieenthal, from reports furnished by all operating smelters of zinc ores except one, showing their output for the first 11 months of the year and their estimated production for December.

The production of primary spelter from domestic ore in 1915 is estimated at 460,000 short tons, and from foreign ore at 30,000 tons, a total of 490,000 tons, worth at the average St. Louis price, \$139,160,000, compared to a total of 257,019 tons in 1914, worth \$36,910,998, and made up 343,418 tons of domestic origin, and 9631 tons of foreign origin. This was a gain of 157,000 tons and of more than \$103,000,000 in value. As noted above, however, the gain in value was considerably more than this amount. The production of spelter from both domestic and foreign ores, apportioned according to the States in which it was smelted, by six-months periods, was as follows, in tons:

| State. | 1914 | | 1915 | |
|--------------|-------------|--------------|-------------|--------------|
| | First half. | Second half. | First half. | Second half. |
| Illinois | 62,962 | 65,884 | 74,982 | 85,348 |
| Kansas | 23,737 | 20,773 | 35,247 | 65,398 |
| Oklahoma | 45,443 | 45,924 | 51,172 | 57,532 |
| Other States | 43,816 | 45,419 | 55,131 | 65,190 |
| Total | 175,958 | 177,991 | 216,532 | 273,468 |
| Yearly total | 353,949 | | 490,000 | |

The zinc-smelting capacity was as follows:

| State. | Total retorts at end of 1915. | Retorts to be added in 1916. |
|--------------|-------------------------------|------------------------------|
| Illinois | 38,424 | 4,840 |
| Kansas | 40,366 | |
| Oklahoma | 39,212 | 7,710 |
| Other States | 36,896 | 8,208 |
| Total | 154,898 | 20,758 |

Imports of zinc ore in 1915 were approximately 135,900 short tons, containing about 48,000 tons of zinc, and worth about \$4,600,000, compared with 21,962 tons of ore, containing 12,132 tons of zinc, in 1914. The zinc imports for the first 10 months of 1915 were as follows, in tons:

| Country. | Ore. | Zinc-content. | Value. |
|-----------------|--------|---------------|-------------|
| Australia | 45,972 | 16,700 | \$1,273,141 |
| Canada | 8,907 | 3,494 | 148,636 |
| China and Japan | 7,572 | 3,213 | 193,604 |
| Italy | 5,312 | 2,125 | 153,388 |
| Mexico | 49,694 | 14,521 | 1,619,270 |

Exports of spelter and sheets made from domestic ore are estimated at 115,000 tons, worth \$25,530,000, compared with 61,897 tons in 1914. Exports of spelter made from foreign ore are estimated at 13,000 tons, valued at \$2,250,000, compared with 5580 tons in 1914. Exports of brass are estimated at 33,500 tons, valued at \$12,200,000, compared with 3558 tons in 1914. Manufactures of brass were exported to the value of about \$30,000,000, compared with \$3,756,888 in 1914.

Exports of domestic zinc ore were about 900 short tons, valued at \$45,000, compared with 11,110 tons in 1914. Foreign zinc ore containing 609 tons of zinc and valued at \$24,270 was re-exported. Imports of spelter (probably mostly scrap) are

estimated at 863 short tons, valued at about \$122,358, compared with 880 tons in 1914.

The apparent domestic consumption of spelter in 1915 may be computed as follows: The sum of the stock on hand at smelters at the beginning of the year, 20,095 tons, plus the imports, 863 tons, and the production, 490,000 tons, gives the total available supply—511,000 tons. From this are to be subtracted the exports of domestic spelter, 115,000 tons, the exports of foreign spelter, 13,000 tons, the exports under drawback, 255 tons, and the stock on hand at smelters at the end of the year (to be exact, on December 15), 20,758 tons, or a total of 149,000 tons, leaving a balance of 362,000 tons as the apparent domestic consumption. This calculation takes no account of the stocks of spelter held by dealers or consumers. On comparing the consumption in 1915 with the 299,130 tons consumed in 1914, the 295,370 tons in 1913, and the 340,341 tons in 1912, it appears that the indicated consumption is not large when the larger exports of brass and manufactures of brass are considered.

The average price for the year of prime western spelter at St. Louis was 14.2 cents per pound.

COMPANY REPORTS

BRADEN COPPER CO.

This company's report covers the year ended August 31, 1915, and is mostly taken up by the report of the consulting engineer, Pope Yeatman, who recommended that the capacity of the plant be increased to 10,000 tons of ore per day, at a cost of \$7,500,000. The mill can treat 4500 tons at present.

The property has an area of 2362 acres. The labor situation has greatly improved from several causes.

A great deal of work has been done in developing the ore-bodies, and in preparing them for mining. The crater, about two miles in circumference, around which the ore occurs, has been completely circled, and in this circle have been proved five distinct orebodies, namely, the Fortuna, Regimiento No. 2, Teniente, Centinela, and Bornite. Stopping operations are now being carried on in Fortuna, Centinela, and Bornite, mining on the Fortuna largely predominating. No work has yet been done on the Regimiento No. 2 to prepare it for stopping, but on the Teniente, the largest and richest deposit. No. 1 and 3 levels are being put in shape to supply the large tonnages of ore to be extracted, and level C is being prepared for active stopping. Strictly speaking, the five orebodies are the richer or commercially profitable portions of the deposit completely surrounding the crater. In July, 1911, reserves amounted to 10,074,616 tons, averaging 2.7% copper; on January 1, 1915, the quantity of developed, probable and possible ore was 113,694,880 tons of 2.5% ore. Further work assures a greatly increased tonnage. On Teniente No. 1 level, the Teniente shoot is 4800 ft. long, with an average width of 300 ft., and a depth of 840 ft. The method of mining is like that at the Ray in Arizona, namely, caving and shrinkage stopping. Ore is taken out of the mine by adits, no shafts being necessary for this. Up to October 31, 1915, the ore mined totaled 3,204,484 tons, averaging 2.25%. Openings to April 1, 1915, amounted to 198,970 ft., nearly 38 miles.

The electric railway between mine and mill is working well. Extraction in the mill is improving, being 77%, with 80% expected. The sulphuric-acid plant supplying acid for flotation is making 20 tons a day.

Smelting has been the cause of much difficulty and experimenting. The blast-furnaces and converters gave good results under the conditions.

The hydro-electric plant has now a capacity of four 2000-kw. Pelton wheels and generators.

During the year under review 1,106,420 tons of ore was treated, assaying 2.09% copper, yielding 16,367 tons of metal,

at an average cost of 8.78c. per pound. October costs were 7.36c. Future charges are estimated at \$1.85 per ton of ore, and 6.5c. per pound of copper.

The profit and loss account shows revenue of \$4,126,040 from metal, \$1,258,170 profit, \$866,676 for interest, and a balance of \$537,535. S. S. Sorensen is general manager in Chile.

CAMP BIRD, LIMITED

This company's report deals with the year ended June 30, 1915. The directors' statement shows that of the available profit of £123,291, £100,476 was paid in dividends. The balance carried forward is £6590. From April 30, 1903, to June 30, 1915, the output was 795,129 tons of ore yielding £4,615,389, with a profit of £2,885,418. The revenue was \$27.86 and expenditure \$10.44 per ton during this period. The company holds considerable interest in the Imogene Basin Gold Mines Co., Santa Gertrudis, Messina (Transvaal) Development Co., and the Central American Goldfields Syndicate.

The general manager at Ouray, Colorado, William J. Cox, reported as follows: Ore was derived from seven levels of the mine. Development was confined mostly to the ground reached through No. 3 shaft. Reserves are estimated at 14,800 tons of broken, and 1100 tons of unbroken ore, containing a profit of \$275,000.

The mills treated 32,313 tons of ore, yielding \$952,288, an average of \$29.47 per ton. This is an increase of \$151,209 compared with the previous period. The combined gold and silver recovery was 94.31%. Of the total value, amalgamation gave 58.48%, concentration, 36.59%, and cyanidation, 4.93%. The cyanide-plant treated 20,655 tons of tailing. The profit at the mine was \$583,700.

SANTA GERTRUDIS CO., LTD.

This company operates in the State of Hidalgo, Mexico, and the report covers the year ended June 30, 1915. The general manager, Hugh Rose, and advisory engineer, William J. Cox, both made reports.

Development amounted to 15,838 ft., the last half of the term being at double the rate of the first half. An important orebody was opened on No. 1 and 3 levels. Its probable dimensions are 380 ft. long and 10 ft. wide, assaying \$7.92 per ton. Not much was done on No. 20 level. Development of the hanging-wall bodies was satisfactory. Reserves are estimated as 1,287,000 tons, containing 81,086 oz. gold, and 16,217,296 oz. silver.

The rate of production varied from 85 to 40% of normal capacity, with an average of 52.7%. The local revolution and European war were responsible for this. The mill treated 221,596 tons of ore, worth \$6.28 per ton, with 90.31% extraction. The bullion contained 10,727 oz. gold and 2,000,856 oz. silver. The profit was \$139,500. From the previous year there was a balance of \$625,000. This made \$764,500 available, of which \$360,000 was paid in dividends.

CHAMPION REEF GOLD MINING CO. OF INDIA, LTD.

This company operates one of the world's great mines, situated in the Kolar district, State of Mysore, India. The year ended September 30, 1915 with a yield of 140,895 oz. gold from 211,368 tons of ore, and \$720,000 in dividends. The total to date is 3,607,487 tons, 3,006,454 oz., and \$20,650,000 respectively. The superintendent, H. J. Gifford, reported a number of interesting results in the mine and plants. Reserves amount to 495,015 tons, an increase of 17,631 tons. Between Glen and Garland shafts, drifts have been driven 2000 ft. on the shoot from No. 43 to 46 level. Development totaled 15,111 ft. (From 91 to 103 machine-drills were operated.) Some interesting work was done in the cyanide-plants on current and old tailing. A total of 6620 people were employed, 131 being Europeans, and 102 Eurasians.

BOOK REVIEWS

THE MECHANICAL ENGINEERS' POCKET BOOK. By William Kent. Ninth edition, thoroughly revised with the assistance of R. T. Kent. P. 1-26. Ill., index. John Wiley & Sons, Inc., 1915. For sale by the MINING AND SCIENTIFIC PRESS. Price, \$5.

Kent needs no introduction to engineers and students; the work is always consulted; the appearance of a new edition (the last was in 1910) will be welcomed. There have been many changes and advances in engineering standards and practice during five years; this necessitated changing over 400 pages of the last edition, and in addition of over 150 pages of new matter. Many subjects previously discussed at length have been condensed. Materials, mechanics, blowers, heating and ventilation, fuel, steamboilers and engines, and steam-turbines have been extensively revised. Machine-shop practice received considerable attention. Electrical engineering will be found up to date. A number of new tables are given. Internal combustion engines are well treated. The variety of subjects included is too great to detail; they range from air to zinc.

INORGANIC CHEMISTRY. Edited by J. Newton Friend. Vol. VIII. 'The Halogens and Their Allies,' by Geoffrey Martin and E. A. Danaster. P. 337. Ill., index. Charles Griffin & Co., London; J. B. Lippincott Co., Philadelphia, 1915. For sale by the MINING AND SCIENTIFIC PRESS. Price, \$3.

The editor of this work states that the science of chemistry may be divided roughly into organic, physical, inorganic, and analytical branches. No single text-book can contain a thorough treatment of any one of these branches, therefore a series of works covering certain sections of chemistry are better. The work under review has been prepared from a scheme of periodic classifications with slight alterations. The elements of the seventh group of the periodic table (Mendeleeff's law), comprising the halogens and manganese together with those of their compounds, are discussed from a chemical and physical point of view. The elements fluorine, chlorine, bromine, and iodine form a natural group of closely allied bodies known as 'the halogens.' Manganese is quite dissimilar in its properties. The halogens are of great interest to the chemist, and enormous industries have been developed in their manufacture.

METALLURGY OF GOLD. By Sir Thomas K. Rose. Sixth Edition. P. 691. Ill., plans, index. Charles Griffin & Co., London; J. B. Lippincott Co., Philadelphia, 1915. For sale by the MINING AND SCIENTIFIC PRESS. Price \$6.50.

This is the revised and enlarged edition of a standard work. 'Rose on gold' needs no introduction to our readers. It will be noted that since the date of the previous edition, in 1905, the author has been knighted, in recognition of his scientific work as chemist of the Mint. He is now the president of the Institution of Mining and Metallurgy. Both of these marks of distinction indicate that he is a prophet not without honor in his own country. It is also manifest, from the world-wide distribution of his treatise on the metallurgy of gold, that his exposition of a great subject is appreciated far outside the confines of the British Isles. Indeed, he has won much more than a prefix to his name.

The edition of 1905 was issued at a time when notable changes were taking place in the treatment of gold and silver ores; these changes were mechanical, rather than chemical, and they have continued during the decade since. Hence a new addition was amply warranted. The work has undergone no sham revision; it has been increased by 68 pages; most of the chapters have been re-written, and the contents as a whole have been so re-arranged as to constitute a new book. In the chapter on the physical properties of gold, the information concerning the spark spectra and the position of the metal in

the periodic classification are new, so is that on vapor pressure. Crystallization in ingots likewise is discussed on the basis of recent investigations. The gold alloys are now described in a separate chapter of 35 pages, all of them highly interesting. The chemistry and occurrence of gold in nature constitute two chapters of particular interest to mining engineers, and the value of them is heightened by a scholarly bibliography. The two chapters on placer operations are a summary of current knowledge and are remarkable not so much for originality of observation as for concentration of information from a great variety of sources. The same may be said of the author's treatment of amalgamation and the crushing machinery associated with that ancient method of gold extraction. Tube-mills and their linings come under the heading of 'Fine Grinding,' which is discussed admirably. The chapter on 'Concentration' is noteworthy for containing only 10 lines on flotation, undoubtedly the most remarkable process of concentration as yet devised. In the next edition of this book we shall expect a large and deeply interesting chapter on this branch of the subject. But we find that this serial treatment of the various chapters will lengthen this review beyond reasonable limits; so we skip some parts. In 'Chlorination,' Sir Thomas returns to an old love, for he was metallurgist in a chlorination plant near Denver in 1887. The 'chemistry of the cyanide process' is worthy of the Chemist of the Mint. Next the cyanide process itself is given adequate treatment, and immediately afterward the author stands on his hearth-rug, as it were, while he writes on the refining and parting of gold bullion. Then come chapters on the assay of gold ores and of bullion, followed by a short chapter of statistics, closing with a bibliography. This book represents the conscientious labor of a keen scholar and a practical metallurgist. It does credit to its well known publisher and confirms the reputation of its distinguished author.—T. A. R.

TEXT-BOOK OF GEOLOGY. Parts I and II. By Louis V. Pirsson, and Charles Schuchert respectively. Complete in one volume. P. 1051. Ill., plates, map, index. John Wiley & Sons, Inc., 1915. For sale by the MINING AND SCIENTIFIC PRESS. Price, \$4.

This text-book has been compiled for use in technical schools and colleges by men of wide practical experience in their respective branches of the science and intimate knowledge of the requirements of the student to prepare him for more advanced study. It presents in connected, though elaborated form, the lectures given by the authors on physical and historical geology at the Sheffield Scientific School of Yale University. It is a welcome, instructive, and valuable addition to technical literature, and will supplant the more voluminous text-books of other writers, in that it gives in well balanced form, all the essentials of a comprehensive elementary knowledge of geology. The interest of the reader or student is maintained by the lucid description and logical sequence of contributory factors to the 'make' of the earth as known today. A discussion of the natural forces which find topographic expression in the earth's crust is augmented by the chemical and physical analysis of the structure developed. Economic geology receives only passing comment in comparison with the number of pages devoted to physiography and palæontology; but the study of ore deposits is a more advanced course.

The text is profusely illustrated with excellent photographs from the field, and descriptive drawings. This is commendable, as it enlivens interest and clarifies what might otherwise be more or less ambiguous statement, although in casual criticism the reviewer would question the advisability of inserting photographs of the great masters of geological and biological science, with pictures of fossils of past geologic ages. Adam Sedgwick, at the age of forty-seven, does not look well with the Ordovician graptolites, nor will the student appreciate the fine features of Huxley, when standing on the shoals of the evolutionary theory before plunging into the depths of palæontological record. Generally the work is excellent.—F. H. P.



EDITORIAL



T. A. RICKARD, *Editor*

OUR readers must not assume that we had no photographs of the late Mrs. Everson. We have them still.

COPPER has been sold ahead at New York to the extent of the first half of the current year's production.

IN a recent issue we mentioned the new explosive ammonal, made from aluminum dust and ammonium nitrate. We publish this week a timely article on this new use for aluminum, written by Mr. G. H. Clevenger, Professor of Metallurgy in Stanford University.

PASSAGE of the mineral-land leasing bill through the House of Representatives presages the correction of an injury done to oil-operators in California by the withdrawal of public lands under the Taft administration. Approval by the Senate is assured.

WE publish a letter from Mr. F. C. Brown, the inventor of the Pachuca tank, which is more correctly called the Brown agitator. We divulge no secret when we mention the fact that Mr. Brown, instead of trying to collect an irritating royalty from users of his invention, has had the good sense to ask only for a reasonable lump payment based on tank capacity. We are glad to add that his tactful treatment of the problem of getting some recompense for his valuable invention has been frankly recognized by mine operators in this country.

GREAT MINES die slowly. The Camp Bird, in Colorado, has been described as 'exhausted' for three years successively. Last year the company's report said that the reserve remaining would still yield a profit of \$307,600; now it is stated that during the past year a profit of \$566,500 was won, or \$258,900 more than the estimate made the year before; and yet the ore left on June 30 last is expected to yield about \$275,000 more. Since then we have heard news of further promising developments, so we shall refuse to consider the mine even moribund.

BOSTON appears to be in danger of losing prestige as a mining centre. Several companies managed from Boston have been listed recently on the New York Stock Exchange. Among them we may mention the Butte & Superior and American Zinc, which are to be followed by the Old Dominion and United States Smelting companies. It is suggested that the reason for the decrease of share activity at Boston is the meagreness of the information vouchsafed to shareholders. In that regard the New York companies are not pre-eminent.

Annual or semi-annual reports are of no consequence from the speculator's standpoint. They are too infrequent. To the insiders belongs the game, so long as shareholders are like "dumb driven cattle."

REMARKABLY good metallurgical work is being done by the technical men on the staff of the Sulphide Corporation, which owns the Central mine at Broken Hill, in Australia. At the recent annual meeting of the company it was stated that the recovery of silver was 90.6%, of lead 93.7%, and of zinc 92.8%. The operations include wet concentration, flotation, and smelting. Our compliments to Mr. Charles F. Courtney, the general manager, and to Messrs. James Hebbard and H. A. Evans, the superintendents of works.

ADVICES from Yokohama indicate that the mining industry of Japan has been favored by the War. The exploitation of precious-metal deposits has been increased considerably. Exports of copper are being made to England and Russia. The mining of zinc has been stimulated, and zinc ore from China is being imported for treatment at Japanese smelters. When the War ends, it is likely that Japan will produce a supply of zinc sufficient for the domestic consumption. Lead ore is being imported from Australia. We publish an excerpt from a Japanese official report.

WAR is not often akin to humor, so that the following story will be forgiven. When hostilities began some of the people at Johannesburg wanted to help the cause that they favored. Mayor Dahymple of the Anglo-French group presented the Chamber of Mines with a plan to equip a contingent to be sent to the front at the expense of the mines. This scheme was popular locally and would have been put through if some of the German directors and shareholders in London, Johannesburg, and elsewhere had not kicked against it. A counter-suggestion was made that a hospital ship be substituted for fighting men, "as this would be fairer to the enemy shareholders"! So a hospital ship it was; but Sir Joseph Robinson, an old curmudgeon not particularly popular in the financial set, because of his predilection for playing a lone hand, sent his contribution of £5000 direct to General Botha to be used for fighting purposes.

ON June 26, 1915, we published an article on the Altai mining region in Siberia by Mr. H. W. Turner. It seemed worth while to draw attention to the introduction of fresh capital and modern methods to a part of the world that offers an inviting field to Anglo-American

enterprise. So far the most important work has been done by the Russo Asiatic Corporation, although the Russian Mining Corporation has played a good second. As regards the former, we note from the information given at the company's recent annual meeting in London that they are already proved amounts to 3,174,000 tons, averaging 7.8% lead, 11% zinc, 0.64 oz. gold, and 1.1 oz. silver with 0.8% copper, from which a profit of \$50,000,000 is expected. Mr. H. H. Knox, of New York, made the underlying estimate. Exploratory diamond drilling is still in progress. A railway has been built from the Irtysh river to the Ekibastus coalfield, belonging to the Corporation, and another railway is just being completed from the same river to the mines. A zinc-lead concentration plant is being erected at the Kidder mine and a zinc smelter at Ekibastus, so that the enterprise will reach a highly productive stage at an early date. The technical work is in the hands of one Russian and three American engineers, namely, Messrs. A. P. Ivanoff, R. Gilman Brown, Thomas J. Jones, and Deane P. Mitchell. The Russian government is proving most sympathetic and the Corporation has made systematic provision for the comfort of its work-people, including the building of churches, schools, and clubs. Altogether this promises to be the nucleus of a highly organized and most profitable undertaking.

IN another paragraph we refer to the longevity of the Camp Bird mine. We learn now, from London, that it is the intention of the company, acting on the advice of Mr. John A. Agnew, to proceed with systematic exploration in depth by means of a low-level adit. This adit, which is to be 10,700 feet long, is to strike the lode 450 feet deeper than any existing workings and 800 feet below the main ore-bearing ground. The choice lay between the driving of this adit and the sinking of No. 3 shaft, after it had been supplied with a heavier equipment, and the pumping of a heavy inflow of water. The method chosen for testing the question of deeper persistence is undoubtedly the wiser of the two alternatives. What the chances are of discovering valuable orebodies is another matter. Mr. Agnew is an engineer of ripe experience, and he will have had the friendly assistance of Mr. W. J. Cox, long familiar with local conditions, in arriving at a conclusion. The opinion used to prevail in the San Juan region that the gold-silver veins became impoverished as they passed out of the andesite breccia into the underlying sedimentary rocks. In that part of Colorado—a great trickiness—10,000 feet at its maximum—of lava flows and breccias lies upon the sedimentary series, the highest member of which is a Tertiary conglomerate, next to which come the limestone and sandstone beds of the Jurassic and Triassic. While some productive mines have been developed along lodes enclosed within the sedimentary rocks, it has been proved by experience that the rich, richer veins in the great covering of breccia do not continue into the sedimentary terrain and become impoverished before they reach that horizon. Our recollection is that the lower adit of the Camp Bird

is fully 2000 feet above the conglomerate, so that there is an ample margin of safety, say, 1000 feet, between this low level adit and the limit of possible productivity. A number of veins should be intersected and a large territory prospected without great cost, having regard to the value of the orebodies already exploited in the existing upper workings. It is a reasonable venture and well worth while.

STATISTICS can be made to prove anything, simply because any sort of vague data can be given statistical form. For example, the mineral statistics published at the beginning of each year are notoriously inaccurate. Even those of the Geological Survey have to undergo radical revision before they can be accepted as part of the historical record. While it is comparatively easy to collect the figures of domestic mineral production, it is much more difficult to get at those of foreign countries, for the simple reason that in most cases no figures are issued by the various governments and mining bureaus until late in the ensuing year, if then. Yet this does not deter the *Engineering and Mining Journal* from giving a detailed tabulated statement of the world's gold production. Such a statement is farcical. Only the output of gold in the United States and the British dominions is obtainable, even estimable, with any accuracy, in the first week of the year. In making such an estimate, it should be indicated that 10 out of the 17 items are mere guesses, some of them bad. The idea that the gold production of China, Europe, or South America during 1915 can be estimated within \$5000 on January 1, 2, or 3 of 1916 by an arithmetician in New York is preposterous. As Disraeli said long ago: "There are three kinds of lies: lies, damned lies, and statistics."

The Mexican Crisis

In our last issue we recorded the killing, by Villa bandits, of 18 Americans on their way to the Cusiuhua mines in Chihuahua. The party included several mining engineers well known in the West, notably C. R. Watson, Charles A. Pringle, William J. Wallace, and Thomas W. Evans. The news of the murder has excited keen indignation, which, after a lull, has been reawakened by the arrival of the bodies of the victims at their home communities. At El Paso a riot broke out soon after the news was received there, and talk arose of mobilizing a force of a thousand men to exact reprisals. A number of prominent Mexicans had to be deported to California in order to prevent a lynching. But the first feeling of resentment has been calmed, so that thoughtful men can put the question: "What is to be done?" A crime such as that perpetrated at Santa Ysabel on January 10 excites the emotions first, and then arouses the intellect to logical effort. Something has been done already. José Rodríguez has been captured and shot. Sundry legislators in Congress have availed themselves of the chance to attack the President's policy, which is

vulnerable; Mr. Theodore Roosevelt has delivered himself of a forceful denunciation, which is easy; Mr. William Randolph Hearst has mobilized his many-headed reptile press to stir the country into intemperate action, which is not surprising; and all the while thoughtful men have recognized that in this affair, as in that of the Italians at New Orleans, it is necessary to give the Government of the country a chance to punish its own criminals before we can take action in behalf of the victims of the atrocity. Let us examine the facts, as far as they are known. The statement that the murdered men were "too previous" in going to the mines is negated by the assertion that General Alvaro Obregon, for the Carranza government, invited Americans to return to their mining properties and accompanied the invitation with assurances of their safety. They were duly authorized by the authorities at Juarez and at Chihuahua to proceed to their destination at Cusi, as it is generally known among mining men. So no blame attaches to the unfortunate victims on the ground of foolhardiness. At the same time it should be recorded that the State Department at Washington had not withdrawn its urgent warning to its own nationals against endangering themselves by going into parts of Mexico where guerilla warfare was in progress. Next, it appears that the deed was done by Villa's men, suggesting that, apart from his predatory tactics, he would be glad to embroil the United States with the Mexican people, for thereby he would get a chance to appeal to national prejudice and patriotic impulse. If this country were to intervene forcibly, Villa would be a military asset to the Mexicans, for, thrice damned brute as he is, he is a natural soldier and could not be shelved by a Mexican president in time of national need. Thus the crime was partly political, we think. For that reason alone the *de facto* Government has cause to regret the incident and, we believe, will be particularly anxious to placate American sentiment by punishing the murderers. The killing of this party in Chihuahua is a denial of Carranza's claim to having secured control in that part of Mexico. His government is disgraced by the act and must be anxious to prove itself able to enforce punishment. The recognition of Carranza pre-supposed his ability to maintain order; it was a long shot perhaps, and unless he moves quickly in this affair his claim will be stultified. We must give him a chance to make good. Meanwhile military intervention is no more warranted now than a month ago or a year ago; we do not see that this horrible crime should cause a change in the deliberate policy of the administration at Washington, any more than any one of a dozen other crimes perpetrated against American life and property during the last three years. The moment for forcible intervention was when General Funston and his troops were at Vera Cruz, and in a position to stand astride the railway to Mexico City. The President's policy has been termed consistent, which it is; it has also been called 'heroic,' which is a satire, even in days when heroic is a word much over-worked; but it may be sagacious. Anxious as we are to see Mexico pacified and mining operations resumed in that great

mineral region, we believe that the solution of the problem must now be left to the Mexicans. This country is committed to that policy. If it succeeds, the historian will call it wise; if it fails, and armed intervention is finally necessitated, the historian will condemn it in strong language, as many people are doing already. It remains for all good citizens to support the national policy until Congress refuses any longer to sanction it. Hence we regret the violent language of an ex-President like Mr. Roosevelt. It smacks too much of politics. In any case, the endorsement by him of an editorial in the *New York American* is greatly to be deplored. No good can come from applauding the efforts of a prostituted journalism or supporting the diatribes of a publisher not remarkable for high principle. Remember McKinley. The man whose string of yellow papers reaches across this continent is trying to drive Mr. Wilson, as he drove William McKinley, into war. Has Mr. Roosevelt forgotten what he himself said soon after the assassination of McKinley? While never anything but a dangerous leader of opinion, in this case Mr. Hearst is particularly suspect on account of his large holding of lands and ranches in northern Mexico. No, the friends of the murdered dead do not wish, we venture to say, that their loss should be used by reckless politicians or a pestilent press to hurry this people into a war in a fit of resentment against the crime perpetrated by a beaten revolutionary desperado. Wherever Mr. Hearst leads, it is well to hang a red lamp.

Learning to be a Metallurgist

In this issue we publish another of our series of interviews. The subject this time is Mr. Philip Argall, an engineer particularly associated in recent years with metallurgical work in Colorado. Our readers will find the interview deeply interesting; it is the record of a keen student, a hard-working man, and a resourceful manager. The term 'self-made' has been used too much, like the adjective 'practical,' as an excuse for the uneducated and the uncouth, so that it has lost its real significance, but if ever there was a man that hewed his way to success, that found the *carrière ouverte aux talents*, that owed little to good fortune and much to earnest endeavor, then Philip Argall is the man. Consider the beginning: the small boy that rummaged among the sluice-boxes and found a little nugget of gold, and in the act became infected by the longing to seek and to find, by that call of the mineral explorer that takes the adventurous to the ends of the earth and to the waters under the earth. The boy had an education that was not conventional; indeed, the shallow-minded might be inclined to say that if he had gone through the regular preparation of school and university he would have done better. We doubt it. Of education it may be said, as of many other things, that we get out of it what we put into it. To be among mines and smelters, to work in a concentrating mill, and to be in close touch with those actually engaged in winning the metals from ores is not

necessarily a mining education, if the recipient is lazy or unobservant; but to an alert mind eager to learn and anxious to become efficient, it is a veritable school of mines. Apparently the boy Philip had the happy gift of arousing the personal interest of his older acquaintances, some of whom took pains to help him by the loan of books or apparatus. That blow pipe of which he tells us was the key to a whole world of rudimentary metallurgy, for a blow pipe and a piece of charcoal constitute a blast furnace in miniature. And then came the "complete laboratory" found in an abandoned mine. That was the luck of the miner, of course; of the energetic seeker and intelligent exploiter. Thus the awakened faculties were trained and developed. What could be a wider eye-opener to the mind of a keenly observant boy than the phenomena of kernel-roasting and the leaching of copper ore? The formation of a nucleus of copper sulphide in a lump of mixed sulphide ore is one of the most subtle of metallurgical operations, while the leaching of copper ore affords a typical example of the impact between chemical and economic factors.

With adolescence came hard work in a mine, the learning of practical details underground, and the comparatively rapid winning of a post of responsibility. At 19 the boy Philip became the man Argall, for at that age he was appointed a shift-boss in the Cronchane mine. But routine work was not allowed to interfere with further study. Witness the detection of hydrogen as the cause of underground explosions due to gas arising from the precipitation of copper in the mine-water. Then came the designing of a brake on a whim; his first application of mechanical ingenuity, to be evinced during later years in the invention of a classifier and a roasting-furnace. And then, after 25 years in Ireland, Mr. Argall went to Swansea, which at that time was the Anaconda of Europe, as a centre of copper-smelting industry. But Swansea was reactionary and unprogressive, and in that respect wholly unlike the Washoe works; for that fault it has paid the penalty of becoming a melancholy 'has been.' However, in 1880 Swansea was yet in its glory as the recipient of all kinds of ores from every quarter of the world. And what was more important to the subject of our story, it was the locality chosen by Parnell for several ingenious methods of his own devising, including a complex copper process of the Hunt & Douglas type, now only of academic interest. One of Parnell's ventures was the treatment of tin-scrap, in which operation the young Irish-Cornishman from Wicklow had a chance to discover that sulphur rendered tin unfit for plating, and so to remedy a defect in the process. Other experiences followed, including zinc mining and antimony smelting, after which a wider horizon was opened by a journey to New Zealand and Australia, with visits to France and to Mexico. Shortly afterward his appointment as manager of an important smelting enterprise at Leadville, when Mr. Argall was 33 years of age, brought him to the West, with which he has been identified ever since. The La Plata episode was no picnic, for the cut-throat competition between the Leadville, or 'mountain,'

smelters and those of the 'valley,' at Pueblo and Denver, called forth all the resourcefulness of a strong character. His story of the decision to shut down is full of human interest. Five years later came his first contact with cyanidation, in the technology of which process Mr. Argall has written his name enduringly. In the controversies between dry and wet crushing, between roasting and non-roasting, between sliming and non-sliming, he played a prominent and useful part. The treatment of the telluride gold ores of Cripple Creek gave him a congenial problem, which he attacked with all the intensity of the Celtic temperament, incidentally waging a technical war of considerable vigor with the advocates of both bromination and chlorination in Colorado. The logic of events has proved his judgment to have been right. Finally, as first consulting engineer and then manager of the celebrated Independence mine, at Cripple Creek, he was able to put all of his ideas into effect in the construction of a large cyanide mill that made a remarkable record. A cost of \$1.51 per ton and an average extraction of 74.57% on dump ore speaks for itself, at least to those conversant with similar problems. And then, as if to prove his up-to-dateness, Mr. Argall became involved in the use of flotation, achieving a noteworthy technical success so quietly that the mention of the fact in this interview is the first publication of it. For three years at Magdalena, New Mexico, he has been winning 95% on a mixed zinc ore, by the use of a film-suspension process of the Wood type. And so we bring this summary to the present time, when Mr. Argall is engaged in consulting practice with two of his sons at Denver. Having fought single-handed for instruction in science, he has given his sons the best education available, including a university training, thus affording them opportunities foreign to his own youth. Surely the United States has a good citizen in the man that has done so much to develop its mining industry and then contributes five sturdy intelligent sons to the community, not omitting the capable daughters, who being voters in Colorado, are also citizens in good standing.

We like the choice of a "best achievement." Mr. Argall says it was the introduction of the 8-hour working day in the cyanide mills of Colorado. There speaks sympathy with his fellow-men; such a manager can get more effective work in 8 hours than the small-minded autocrat who thinks the manual laborer is only a slave to be driven to his toil for 12 hours. But the dominant note in this fine career is expressed in the early part of our interview, where Mr. Argall acknowledges that he has been a student throughout his life. "Modern mining and metallurgy keeps one a continuous student, however humble his part." Yes, indeed; and not only in order to keep at the head of the procession but to enjoy that sense of useful power that comes to him who is gaining persistently in his understanding of the diverse operations of Nature. When John Richard Green, the historian, was dying, he asked that his epitaph should be: "He died learning." To be able to learn until the last summons is the wish of all thoughtful men.



DISCUSSION

Our readers are invited to use this department for the discussion of technical and other matters pertaining to mining and metallurgy. The Editor welcomes the expression of views contrary to his own, believing that careful criticism is more valuable than casual compliment.

Why Is Flotation?

The Editor:

Sir—I have read, in your issue of January 1, Mr. Huston's interesting discussion of this subject. Mr. Huston's article shows close observation of flotation phenomena, but I am by no means ready to admit the correctness of the preferential affinity theory of flotation, and since he has opened the discussion, I shall take this opportunity to present some further evidence in support of the electro-static theory.

It is undoubtedly true that oils, in general, have a greater adhesiveness for dry sulphides than for dry gangue-minerals, but I cannot see how this in any way proves that water will displace oil films from the gangues and not from the sulphides, or even that these films will be present to be displaced. Some of the transcript of the case of Minerals Separation *v.* Miami Copper Co. is now available, and it was certainly shown that unmoiled particles could attach themselves to air bubbles. Entirely apart from this, Mr. Huston pre-supposes the presence of oil in the pulp. I have myself carried out flotation tests with a fair degree of recovery in a saturated brine without the use of any oil whatever. While the use of small amounts of oil improved the results, it was certainly true that there was a marked selective action in the brine alone.

Such work as I have done along this line would show that the main function of the oil is to lower the surface tension, and to form a surface film that is flexible, and at the same time coherent enough to get in contact with more of the sulphide surface than the tightly stretched film of a bubble in plain water. There have been several articles in the PRESS lately, in which theoretical and experimental proof has been presented showing that gangue-minerals possess negative electro-static charges, and that sulphide minerals possess positive charges. This explains why the floatable minerals will adhere to the flexible bubble-film, while the gangue-minerals will not. In other words, it explains the selectiveness of the process. The other details, it would seem to me, are largely mechanical. The oil may cause the sulphide particles, after they are in contact with the bubble, to adhere together in a coherent armor. Other mechanical effects, with various oils and various processes may be noticed, but the question "Why is Flotation?" must be answered by telling why one portion of the ore floats while the other does not. To determine this we must, of course, study differences in physical properties which

parallel the flotation properties. It may be perfectly true that galena and the common sulphide-minerals differ from the gangue-minerals in their air-water contact angles and in their adhesiveness for oil, but so far as my information goes, the electro-static parallelism is the only one that explains the flotation properties of bad gangues and artificial sulphides.

JAMES A. BLOCK,
Salt Lake City, January 8.

Precipitation With Zinc

The Editor:

Sir—In your issue of December 11 there appeared an article on zinc precipitation, by J. A. Carpenter, which is of timely interest, for, as Mr. Carpenter states, the present high price of zinc has driven metallurgists to a closer consideration of precipitation methods. In the course of his careful comparison of figures, Mr. Carpenter advocates the use of zinc-thread by inference, although admitting the effective results obtained by the use of zinc-dust.

The interesting and essential feature to workers in the field of cyanidation, developed in this article, is that the saving in the cost of treatment was effected by a change in the regulation of solution contents, in lime and cyanide, rather than by the character of the precipitant, or the method of using it.

Had zinc-dust been employed, I believe that the results would have been substantially the same as those noted in the article in question. Not every ore will yield an equally satisfactory extraction within as wide limits of cyanide and lime contents in solution; hence it is clear that the reduced zinc consumption noted by Mr. Carpenter cannot be attained similarly in other plants by the use of the same tactics as those found practicable with the West End ore, unless the whole set of conditions were found to be parallel.

Mr. Carpenter's point is well taken, that the precipitation-presses are costly, and the less expense of operation with zinc-dust must hold for a considerable period, to offset the high initial outlay as compared with zinc-boxes, which are relatively cheap. On the other hand, he makes reference to "an occasional bad cask of zinc-dust" and the trouble it will entail.

Moist and caked zinc-dust is generally thought to have become entirely unfit for a precipitant, but this is not necessarily the case. In cases known to me, caked zinc-dust, which had been wetted in transit, was cast aside as worthless, or unsafe to use, and later, when force of cir-

circumstances required using it, it was dried and broken up to as near a powdered state as could be, and then fed into the solution in quantities of some hundreds of pounds. No bad results ensued, either in precipitation or extraction; although it was feared that the former would be seriously affected, in accord with the generally accepted belief about wet zinc-dust.

Although no 'short zinc' troubles the operator who uses zinc-dust, a zinky precipitate may be handled as follows: assume two precipitation circuits, in which the richer solution is incompletely precipitated, giving a high-grade precipitate and a nominally 'barren' effluent solution. The poorer solution is precipitated in most cases to 0.02-0.04 oz. silver; the question of precipitating to a 'trace' being purely a commercial one.

The second precipitate will contain more zinc than the one from the richer circuit.

With adequate solution-storage capacity, the zinky precipitate from the poorer solution may be raised in fineness prior to clean-up by pumping the richer solution through the press, and returning the effluent solution from the press to the stock-solution circuit. This parallels the return of short zinc to the head of the boxes, but has the advantage that no handling or preparation of material is required.

Naturally, it is preferable to avoid an excessive feed of zinc-dust, rather than to remove it afterward. With this point in view, a satisfactory method of avoiding excess of zinc and one affording a closer regulation than daily assays in a silver cyanide plant, is that of colorimetric titration of solutions at suitable intervals.

A titration scheme may be devised so that it can be run quickly through with a minimum manipulation and sufficient accuracy.

As Mr. Carpenter pointedly states, the best reason for choice of zinc-thread precipitation is found in the question of capital outlay in equipping plants when the duration of mining operations is a matter of more than the customary uncertainty.

DONALD F. IRVIN.

Pasadena, December 13, 1915.

Pachuca Tanks

The Editor:

Sir—In your issue of December 11 there is an article on 'Precipitation with Zinc Thread' by Jay A. Carpenter, in which he gives very interesting and valuable data regarding the use of this precipitant; but in the preamble of the article Mr. Carpenter, in using a simile to give force to an argument, makes what I consider an unfair criticism of the Pachuca agitator. The passage I refer to is as follows: "At the time of the growing popularity of the Pachuca agitator, it would have been heresy to publish the fact that they filled gradually with solidified pulp, and it was not until their popularity was on the wane that this was asserted in print."

If, instead of using the sweeping expression "they filled gradually with solidified pulp," the writer had

said that "some filled gradually" I would have no complaint to make, as I am well aware that when a Pachuca is not correctly installed and properly operated there may be trouble; but this applies equally to all our modern mill machinery, and there are "some" tube-mills that do not grind properly, "some" vacuum-filters that do not filter successfully, and "some" zinc-precipitation arrangements that do not seem to take the precious metal out of the solution, and even "some" cyanide plants that won't work.

It seems to me that the use of such a broad and inclusive statement is, first, not fair to the agitator itself, which is now in service all over the world, and secondly, a severe reflection on the intelligence and business ability of those in charge of the large plants where Pachuca agitators are in operation. If Pachuca agitators "fill gradually with solidified pulp" they would soon be on the scrap-heap, as untreated pulp is of more concern than the apparatus used for treating it.

Some incidents in connection with the early history of the Pachuca may be of interest to your readers. I was in San Francisco in 1904, and, having letters of introduction to one of the leading mining men there, I showed him drawings of the apparatus, since called the Pachuca tank. He looked at it in a curious way, and asked if I really meant that in such a device a charge of 50 tons of settled pulp could be started up and kept in agitation, and when I answered in the affirmative, he brushed the drawings aside as though the interview were concluded, and remarked: "Why dynamite wouldn't shift it in such a vessel." After informing him that the apparatus was no longer an experiment, but that over 1000 tons of sand had been treated in it, he again looked at the drawings and asked me to explain the operation, and suddenly said "Why of course it will work; I think you have a valuable idea."

In 1905 I was at a mine where they shipped their concentrate across the ocean to smelters, and although fairly high-grade, there was little, if any, profit. The managing director approached me regarding local treatment, and it was decided to install a Pachuca, and one of 7 ft. 6 in. diameter by 37 ft. high was purchased from a neighboring mine and installed without delay. A 50-ton charge was immediately pumped into it, but owing to a break-down of some machinery, it had to stand for 10 days. When things were running again I was told to start up the Pachuca, and the men in the mill had a grin on their faces as I climbed to the top of the tank to operate the valves. In three-quarters of an hour it was all loosened up and a heavy lead weight, lowered into the tank by means of a cord, struck metal whenever it was bumped on the cone bottom, showing that there was no lodged concentrate.

I think the late Albert Grothe, of Mexico City, named the agitator the Pachuca. In 1904 I sent him drawings of the tank, and in 1905 he built a small one for testing purposes, and when he had his first charge in agitation, he threw a handful of buck-shot into the tank and was

astonished to find them lifted up and discharged from the central pipe. He said that an agitator that would handle buck-shot would suit his ore all right.

For simplicity and low cost of erection there is nothing to equal the Pachuca; no belts, no shafting, and nothing moving except the compressor; and when a tank is put in right, the quantity of air necessary to perform the mechanical work is just about what is wanted for the chemical requirements. Such a tank is especially suitable for cold climates, as it occupies so little space and can easily be kept warm.

An objection I have heard raised here to Pachuca is that it is difficult to raise the pulp to them owing to their height, as belt-elevators and centrifugal pumps are costly to operate. I always use a plunger-pump of the same design as is so successfully used in the clay-working industry to pump gritty clay into filter-presses against pressures of 80 lb. or more. At one mine I used such a pump for 12 years until the mine closed-down, and the pump was still perfectly good.

Boise, Idaho, December 29, 1915.

F. C. BROWN.

The Air-Lift in Leaching

The Editor:

Sir—While leaching seems an old-fashioned subject, there are a great many plants in which the leaching of

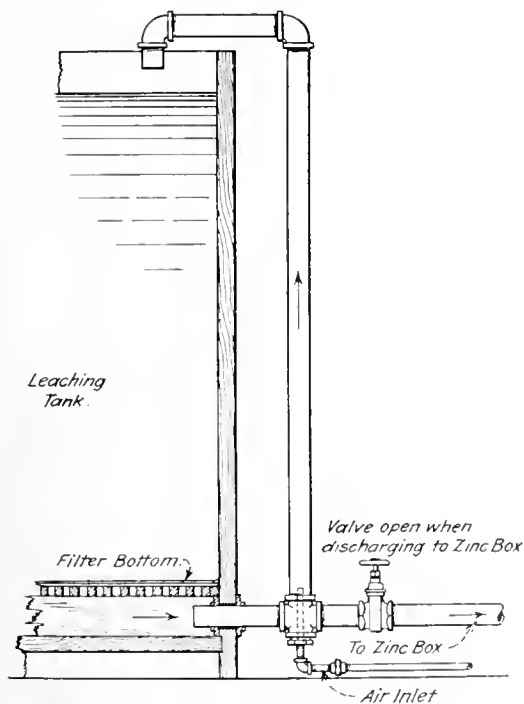

AN AIR-LIFT IN A SOLUTION-DISCHARGE TANK.

the sand is carried on with the agitation of the slime, so even at this late date, it seems to me, suggestions on the improvement of this phase of cyaniding are not out of place.

The Zopilote mill in Tepic, Mexico, was of this type. In order to increase the capacity of this mill, without additional equipment, it was necessary to increase the

proportion of sand to slime in the crushing department and, to handle this increased tonnage of sand, the time of leaching had to be cut down. I accomplished this by the introduction of air-lifts in the solution-discharge of the tanks, as is shown in the sketch. In this way the solutions were kept in constant motion in the tanks and a freshly aerated solution was continuously supplied to the ore with a surprisingly small consumption of air, the lift being less than a foot and the total length of the column being less than seven feet.

This simple arrangement cut down the time of treatment 33% with an increased extraction and, at the same time, cut down materially the zinc consumption, as the solutions were not precipitated until they were much richer than under the old system.

Wonder, Nevada, January 3.

CLARKE SULLIVAN.

[This idea was adopted at Kalgoolie as far back as 1900; however, everybody may not know it.—EDITOR.]

Prohibition in the West

The Editor:

Sir—When a section of the country that particularly prides itself on its virile manhood and untrammelled liberty for the individual passes prohibition laws, such as the states of Arizona, Colorado, Idaho, Oregon, and Washington have done, it is time to discuss the matter. Not the least interesting part of Mr. Probert's article on Oatman in the first number of the year was his comment on the dry condition of that lively district. It is axiomatic and scarcely worth mentioning that copious experiences of North American communities with the prohibition experiment, from the Black Belt of the southern states to Canadian mining districts, have shown results so vicious as not to stand comparison with the public drinking in Western saloons. Little details like 'squirrel-whiskey,' tons of broken bottles behind the bushes, and enormous growth of the drug habit are scarcely in the same class as the direct masculine atmosphere of a saloon. Undoubtedly some temporary advantage to industry is anticipated, or such laws as prohibition could not find serious support. It is rather humorous to think that anyone who knows anything should believe that a law prohibiting drinking in saloons will persist after the novelty of the experiment has grown flat; a reaction against these Sunday-school reforms will undoubtedly come. The American people, particularly in the West, need prohibition about as much as they need a law forbidding the eating of pancakes or red pepper, both of which are surely bad habits. Attempts by cranks and faddists to limit the individual liberty of a people having the traditions of the United States can never achieve any lasting success. It begins to look as though there was a tendency to an unthinking exaggeration of such matters as temperance, sanitation, safety-first, efficiency, purity, etc., all of which are probably good in moderation.

P. B. McDONALD.

Berkeley, January 4.

Aluminum Dust

By G. H. Clevenger

ALUMINUM dust is chiefly of interest to the mining man on account of its use as a precipitant of the precious metals in the cyanide process. It is also used as a reducing agent wherever a powerful metallic reducing agent is required, as, for example, in the production of carbon free metals, particularly those difficult to reduce, or in the Goldschmidt process of welding. It is used for producing *in situ* super-heated molten iron or steel. Another use is as a 'bronze powder' in the preparation of aluminum paint. Perhaps the most important use at the present time is in the manufacture of various explosives. This was first proposed by Escales of Munich in 1899, and, in 1900, von Dahmen patented the use of aluminum, magnesium, or other light metal mixed with an oxidizing agent. Ammonium nitrate was among the first used of such oxidizing agents. This explosive, called 'ammonal,' has given good results in mining and as a high explosive in shells. It has the advantage of being insensitive and very stable, as indicated by the fact that, in Austria-Hungary, shells filled with it were found good after ten years. The reaction taking place when ammonal explodes is probably represented by the equation

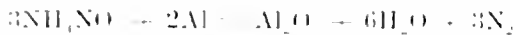

Recently aluminum dust has been added to many other explosives. Other metallic powders, as, for example, magnesium, copper, zinc, iron, silicon, ferro-silicon, certain of the rare metals, and various alloys are now used for a similar purpose. An example of the composition of a modern explosive using aluminum dust is as follows:

| | |
|------------------------|----------|
| Ammonium nitrate | 15 parts |
| Di or tri-nitrotoluene | 1905 " |
| Aluminum dust | 22 " |

Below are given two representative analyses of good grades of aluminum dust:

| | A | B |
|--------------------------------|-------|---------------------|
| Al | 91.29 | 92.50 |
| Al ₂ O ₃ | 5.89 | 5.72 |
| SiO ₂ | 1.39 | |
| Si | 0.49 | |
| C | 0.23 | 1.78 |
| H ₂ O | 1.97 | |
| N | | May also be present |

Aluminum dust is frequently adulterated with powders of other metals, particularly zinc and tin and, at times, also with mica. The difficulty of manufacture accounts for the relatively high cost of the dust, which, in normal times, is almost double that of the metal in other forms.

One method of manufacture involves the production of foil by a special system of rolling or combined rolling and hammering. The perfect foil is marketed in that form, while the imperfect foil, usually constituting 65 to 67% of the total is comminuted in two series of spe-

cial stamp mills, the finished product being separated by bolting and winnowing. The final operation is the polishing of the dust in a special device. Another method is to force gas or air into molten metal while it is setting, accompanied by vigorous mechanical stirring. The granules thus formed are powdered in special stamp-mills or in ball-mills. The finely-ground dust is separated and polished by methods similar to those previously described. In all the methods of making aluminum dust, it is necessary to add stearine or some other wax, to prevent the welding together of the fine particles during crushing.

A source of much annoyance, if not actual danger, is the not infrequent explosions that take place during the various operations after the aluminum has become finely divided. It has been pointed out that this is probably due to the presence of an inflammable gas, since aluminum dust alone is not explosive. Carbon is always present in aluminum, presumably as the carbide, its source being the carbon electrodes used during the reduction of the metal. This, under the conditions obtaining in the grinding mills, probably produces methane. Thus 0.10% of aluminum carbide, which is not unusual, would be capable of producing 132.8 cubic inches of methane per pound of aluminum dust. In addition, there are the possibilities of the decomposition of water-vapor or the wax by the finely divided aluminum to form inflammable gases. These, mixed with air, are, of course, explosive.

Although a great deal of heat is generated during grinding, with ordinary precautions it seems improbable that the temperature would rise to the point of ignition of the gaseous mixture. Sparks might be formed through the impact of the steel grinding surfaces, but a more probable cause of ignition is the electrical discharges which are known to take place. This view is supported by the fact that aluminum dust at times ignites after it has left the mill, when allowed to stand in a solid pile. The dust becomes rapidly coated by a film of oxide which, although exceedingly thin, acts as an insulator. During grinding and polishing, a considerable amount of frictional electricity is generated. This is not readily conducted away on account of the insulating film of aluminum oxide. Potential differences up to 3000 volts are possible. Therefore, when the insulating film breaks down, electric sparks occur which ignite the gaseous mixture. Since it is impossible to entirely avoid explosions, the units for producing aluminum dust are made comparatively small and are provided with loosely fitted iron covers so that, in event of an explosion, little damage will result. In one case an explosion occurred in a new plant 1½ minutes after beginning operations.

DRILL-STEEL is a matter worth considering. It is not unusual for a large mine to buy 100 tons of drill-steel in one order, representing \$15,000 or \$20,000. Hollow steel, of course, costs much more than solid steel, in fact is usually quoted at prices 50 to 75% higher.

Philip Argall, and Metallurgical Progress

An Interview. By T. A. Rickard

Mr. Argall, your name suggests that you are of Cornish origin.

My father was Cornish, my mother Scotch-Irish. I was born in Newtownards, county Down, Ireland, in 1854, and was 25 years old before leaving the country. I used to call myself an Irishman until I became an American by naturalization, in 1889.

Was your father engaged in mining?

My father, Philip Argall, descended from a Cornish mining family, spent his lifetime in the mining business, commencing with tin, lead, and copper mining in Cornwall, leading to lead and coal mining in Wales, and, I believe, lead mining in the Isle-of-Man. At the time of my birth father was at the Conlig mine, near Bangor, this mine being at that time the greatest lead-producer in Ireland and possibly in the British Isles; the family moved to the Wicklow copper mining district in 1858, and a year later my earliest recollection of mining begins. Father left Oveca in 1872 to engage in coal mining in county Tyrone; he died in Dungannon in 1887, in his 72nd year.

Have you any personal knowledge of the Conlig mine?

I visited the locality in 1911 and saw the ruined tower of the famous wind-mill that operated the crushing machinery in the early 'fifties. The large dumps of jig-tailing adjoining bore ample testimony to the power developed by this huge wind-mill, of which I heard father speak so often. In average weather it ran the whole dressing-works, but as a local wit remarked to father, "she had her off days, and in that respect was more human than the steam pumping-engine that was never affected by the weather."

The architecture indicates the work of Cornishmen?

Yes, the engine-house is typically Cornish; indeed, everything except the wind-mill would pass as an old-time Cornish mining scene. The general manager was Silas Evans, one of the foremost lead miners of his day; he too worked his way up from Cornwall through Wales to the Isle-of-Man lead mines and thence to Conlig.

I suppose the mine was abandoned after exhausting the ore?

Yes, father often said he considered the mine bottomed except at the bog shaft, and there the ore occurred in barite gangue, and they failed in raising the lead to marketable grade. I saw much barite in the dumps in 1911; also some evidence that recent attempts had been made at re-working them, evidently with unsatisfactory results.

What is your earliest recollection of mining?

Strange to say, it is closely connected with this great

State of California. It was an attempt at gold mining on the Aughrim river, a tributary of the Oveca river, county Wicklow. I remember a Californian miner in a red-flannel shirt; he was boss of the New Diggings. It was the first red shirt I ever saw. In the land of the 'sleeved waistcoat' he wore no vest; his hat had the widest brim it had been my privilege to gaze upon. For a year he was the hero of my childhood, and to this day nothing in my early life stands out so clear cut and so vivid as that Californian gold miner in 1859, with his red shirt, sleeves rolled up, hat tilted back. I see him yet, prominently posed on the bank shouting orders to the workmen below.

So you can recollect gold mining in Ireland; what became of this venture?

I remember the sluicing operation distinctly and also that in rummaging in the sluice after work was over I found something yellow one day, about the size of a wheat grain. They told me it was a gold nugget, the first found at that place. I date my mining career from that event. The placer mining did not prove profitable, and not finding veins, they collected the float-quartz from the hillsides and treated it in a stamp-mill erected to crush it. The stems were of oak and the hard quartz got the best of the cast-iron heads.

The next move consisted in roasting the quartz in a sort of lime-kiln, and quenching it with water, before stamping. The roasted quartz went through the battery without incident, that I can recall; then came the clean-up, and, as I learned afterward, no amalgam, so the mercury was finally volatilized in an iron ladle over the forge-fire and "like the baseless fabric of a vision left not a wreck behind." That process I saw, and realized some of the disappointment. The Irish quartz-rock proved too much for my red-shirt hero, who went out of my life, as it were, in mercurial vapor.

Can you recall any further gold mining in Wicklow?

Nothing of importance. In 1875 I assisted G. Henry Kinahan of H. M. Geological Survey, in looking over the placer workings; some three or four men were at that time eking out a scant existence with pick and pan. I re-visited the place in 1901 and heard that one old gold-miner was still active in the district.

What was the source of the gold?

Mr. Kinahan believed the gold came from the oxidation and disintegration of the pyritic lodes, and my subsequent experience in other countries inclines me to support that view.

Do the Wicklow copper lodes contain gold?

Yes, in minute quantity; it was only in the gossan that visible gold occurred, or immediately below it, in what is

now called the zone of secondary enrichment; assays of several ounces of gold per ton have been obtained in that zone.

Did you have any regular mining education?

Not of the college type; before reaching my 16th year I finished the grammar-school work, and obtained a grounding in Latin, and such familiarity with Macaulay, Shakespeare, and the English Bible, as has stood by me ever since. Shakespeare I disliked until I reached the years of maturity, but he has long since been my favorite author.

I spoke of mining education.

I am coming to that; when 16 I was laboring 10 hours per day in the dressing-works of the Tigroney mine and receiving a penny per hour as compensation. I soon learned about all that was then known regarding jigs, buddles, and copper-ore dressing, as well as the method then used in precipitating copper from mine-waters. I also studied three evenings per week with a tutor. At 17 I worked 8 hours per day in the mine and took two hours instruction daily from Capt. Chamley, an ex-officer of the Ordnance Department of the British army, on mathematics and surveying. We had at that time a sort of mining college on Stephens Green, in Dublin. I believe it was called the Royal College of Science for Ireland. The Wicklow mines were but 40 miles from Dublin and we saw much of the professors; they were very kind to me, giving me books to study and directing my reading in chemistry. I particularly recall Prof. J. P. O'Reilly, Prof. Robert Galloway, also, whose 'Qualitative Analysis' was my chemical 'horn book.' I owe much to these men and perhaps most to a scientist whose name I cannot now recall. I had shown this gentleman through the mines, and we were lunching together, when he asked me about the blow-pipe. I knew nothing about it. His conversation greatly interested me; he went out and scraped some of the mud off the road, explaining that the minute pieces of hoof and hair in the mud should react for ammonia in the closed tube. To my astonishment it did. He fixed me up with a blow-pipe and a list of books. These I procured, and set to work. He insisted on checking over my notes and within six months I was quite handy with the blow-pipe. To this scientist I am also indebted for notes, how to record the essential information in brief form, arranged for ready reference. I only regret he did not impress on me the importance of dates. In 25 years past I have on every available occasion told my assistants and younger friends that the date is often as valuable as the other data, sometimes more so, and should always form the first notation on every sheet.

How did you manage experimental chemistry?

I purchased some few pieces of apparatus and some reagents to putter along with, but at 20 I was fortunate in being able to pick up a complete laboratory apparatus, reagents and all, at a defunct mine. The equipment came from Germany at the time elaborate experiments were made by German metallurgists on the Connary ores.

In connection with the leaching of copper, I suppose?

Yes, kernel-roasting and copper-leaching. I visited the plant almost every day on my way home from school, the laboratory always commanded my admiration, and years afterward when I obtained possession of it I was a proud boy indeed, though I had borrowed more than half the money I paid for it. Some 30 years later I met the late George W. Maynard in New Mexico, and on comparing notes found he was in charge of the Connary mine when kernel-roasting was tried in 1866-8. We then exchanged much information of mutual interest and remained fast friends thereafter. I made good use of this laboratory and soon got out of debt by making sulphur and copper determinations; previously the former had been sent to Dublin and the latter to Swansea or Cornwall for assay. In the year 1879 I took a course in metallurgy at Swansea, Wales, then the metallurgical centre of the world as regards copper. Such was my mining education, or rather the basis of it. I grew up among mines and metallurgical works, absorbing practical details as I grew, and learning the scientific details later.

You remained a student always?

Yes, throughout my active life. Modern mining and metallurgy keeps one—if he expects to remain in the procession—a continuous student, however humble his part.

You were subsequently connected with the Wicklow copper mines, were you not?

Yes, I worked at all kinds of mining, driving, raising, sinking, stoping in both hard and timber ground. In 1873 I was promoted to shift-boss in the Cronebane mine, and two years later was assistant-manager with title of Captain, as Cornish customs prevailed there.

You have written about copper precipitation underground at that property?

The Cronebane mine did not command the mouth of the main adit. I knew from repeated analysis of the waters that our mine was furnishing its principal copper content. When the manager was fully convinced that the copper came from our property and that it could be precipitated from the mine-waters underground, a demand was made on the Tigroney company for a share of the profit and was turned down hard. My people still had an obsession that precipitation in the mine might lead to some complication, so I was first instructed to place 100 ft. only of launders; these were filled with tin-plate scrap, the precipitation was simply wonderful, the precipitate assaying nearly 90% copper. The result I soon learned was due to the clear warm water that was collected near its source in the mine, as compared with the cold muddy water, often laden with ochre, that fed the surface precipitation plant. Well, the full plant was then ordered in and in a few months was operating satisfactorily.

So copper precipitation in the mine was an unqualified success?

Not completely so, we had two setbacks that I recall.

What were they?

We had to use all the available space in the mine for precipitation. One unventilated cross-cut 600 ft. long caused the first trouble; following a triple holiday, an explosion took place, burning two men rather painfully. An explosion in a metal mine so alarmed the chief Mining Inspector that he wired us to leave everything as it was, pending his inspection. We did, I, however, started an investigation on my own account. I had often noticed gas bubbles rise through the clear water, in the launders, so I collected and tested this gas, which proved to be hydrogen. That night I crawled without a light into the cross-cut to where a hole went up in the roof and there collected a wash-bottle full of the air. On reaching my laboratory I began and ended my investigation

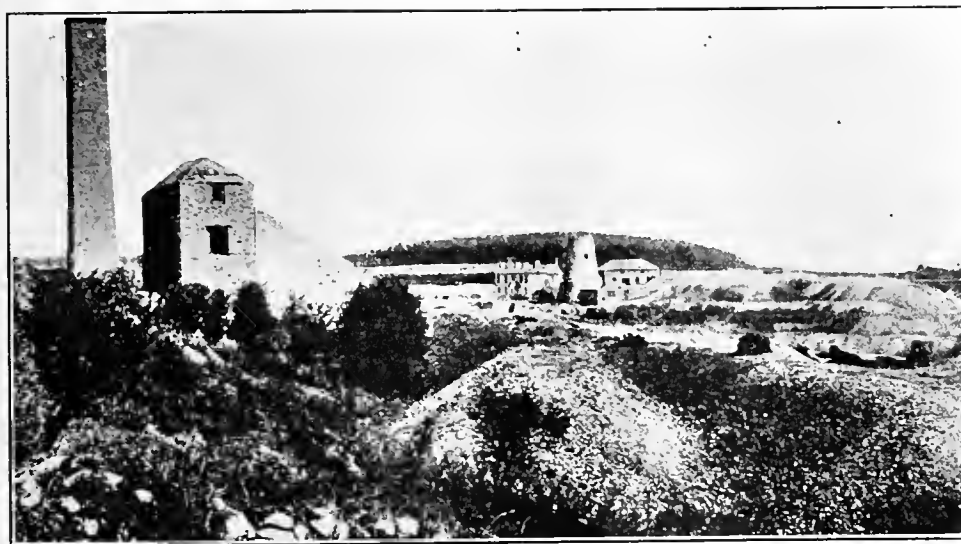

CONLIG MINE, COUNTY DOWN, IRELAND.

by holding a light to the mouth of the flask, I had a real first-class explosive mixture in it.

When the Chief Inspector arrived he was placed in my charge; I told him it was hydrogen gas that caused the explosion, showed him the gas bubbles, collected some, and tested them for him. We then entered the cross-cut with Clanny lamps provided by the inspector, Mr. Dickenson of Pendelton, Manchester, who gave me my first instructions in the use of safety-lamps, and formulated rules for the daily inspection of the 600 ft. of cross-cut before the men were allowed to enter. Mr. Dickenson was greatly impressed with my work on the cause of this explosion and the remedy applied. He gave me prominent mention in his dispatches and annual report, and later when I left for Cornwall he wrote the Inspector for that district, R. J. Frecheville, to look me up.

What was the other incident you referred to?

At one point on the upper adit a Cornish horse-whim, with two buckets, was utilized to lower the cast-iron used in precipitating. I saw that if a brake was applied the horses might be eliminated. I got out a design for a brake on the top of the vertical whim 22 ft. from the

ground, with rods and levers to the shaft-collar. The manager finally approved the design, but discarded the lugs I had provided to keep the brake-band from rising. The brake worked nicely on the evening it was finished. The next morning we had snow and ice, and in lowering the first bucket of iron, a lump of ice caused the brake-band to lift and slip off the friction-blocks, with the result that the bucket and 1200 ft. of steel-wire rope, the second I ever saw, went down the shaft. I believe it took a week to clean up the wreck. Afterward this apparatus gave great satisfaction.

You wrote some papers on the Ovoca mines?

Yes, two, one describing the geology and ore deposits, the second in collaboration with G. A. Kinahan, on copper precipitation. Both were published by the Royal Dublin Society. The plan and section in the former paper were awarded the first prize for the best plan and section of any mining district at the Cornish Polytechnic Society's exhibition in 1878.

I remember an article of yours describing the precipitation of copper from the water of the Ovoca mines and the introduction of the mono-rail underground.

I wrote one paper describing the mono-rail, in connection with the precipitation of copper, in a drift where two lines of launders were estab-

lished: car-tracks could not be used, so the mono-rail was devised for transporting the heavy cast-iron and the copper precipitate, and proved a great success. It is described in the MINING AND SCIENTIFIC PRESS of July 28, 1906.

A revival of the copper industry in Wicklow was attempted in later years?

Yes, but nothing came of it. Some friends induced capitalists to re-open the zone under the gossan explored in 1875-8. I had the records of hundreds of assays I made during that period, as well as my original surveys. Several pits were sunk at places I selected under promise of 3% copper; the ore found, however, averaged nearly 4% copper, about one quarter of which was soluble. Instead of mining the ore in mass (it was about 40 ft. wide) and treating it by some modern process, the new operators followed the practice of the previous centuries, in attempting to dig out the fine seams and stringers of high-grade in the shale and sending the ore to Swansea for reduction. On that basis the enterprise proved unprofitable. A steam-shovel proposition was tackled with pick and timber, and the result was inevitable.

How long were you at these copper mines?

I came there as a child and left in my 25th year to take charge of the Stannic works at Swansea, South Wales.

What kind of business was that?

The principal business was removing the tin from tin-plate scrap; tin and copper matte-smelting was also carried on to some extent; puddling furnaces and a steam-hammer formed another part of the plant. The Parnell process used then contemplated the removal of the tin from the scrap in a hot solution of sodium sulphide, evaporating the spent liquor, roasting to produce tin oxide and sodium sulphate, smelting the tin oxide in Cornish furnaces. The iron scrap was heated in the puddling-furnaces and beaten out into blooms under the steam-hammer. In a word, Mr. Parnell intended to sell block tin and tin-plate blooms to the tin-plate works across the valley, so that both the tin and the iron might enter the channel of trade a second time in the form of tin-plate.

Did he succeed in this?

No, both the tin and the iron proved to be 'cold short'; the former could only be sold for some £15 per ton below standard tin, and the iron was unsaleable except for desulphurizing in lead-smelting. At the time I took charge of the works no one had ascertained what was the exact trouble with the tin, though considerable money had been spent in complete analysis of the refined tin; the iron had up to that time been forced into a mold under the steam-hammer and the compact balls sold to the lead-smelters. On entering the refinery one day our Cornish refiner was struggling with what looked like a very tough slag; I said, "What is that you are trying to pull out of the furnace?" He said, "I don't know; I have been 30 years smelting tin and never saw no such stuff before"; he continued, "if I was them there chemists I'd assay this devilish stuff and not fool with the block tin." I took the hint, secured good samples, chilled them, and set to work, and soon found that the metallic substance was mostly tin sulphide reduced from the sulphate left in our tin oxide. I then determined the sulphate present in the batch of oxide we had ready for smelting, added lime to correct it, and smelted, I believe, a dozen samples, testing each button and finding every one best-grade tin. But I wanted John Uren's opinion; I had worked through the night and our refiner was late in arriving. I placed all the buttons in a ladle and poured several test-bars on the marble slab; when John arrived he nicked and tested each bar and said "It's best Banka, where did you get him." I replied, "It is our tin scientifically smelted."

I had obtained this, my first independent job, on four months trial; the time was about up, so I repaired, after breakfast, to the head office and emerged from a directors' meeting an hour later with a year's contract in my hand and 50% advance in wages, provided I kept the tin up to the grade of Banka in the future. With the assistance of John Uren, the Cornish refiner, this happy result was maintained, and John, too, who gave me the 'stuff' to work on, was duly rewarded.

What quantity of sulphur will render tin 'cold short'?

About 0.02% sulphur will render tin unfit for tin-plating, 0.03 to 0.04% will render the tin quite brittle; in testing a bar containing, say, 0.04% sulphur by nicking and bending, the 'ery' will be dull, the fibre does not develop, and the bar breaks after slight bending. However, after so many years, I am not positive as to the exact percentage of sulphur.

Did you experiment with this iron scrap?

Yes, I started the furnaces and made about three tons of blooms one day. The iron worked beautifully under the hammer, and being at that time short of rabble-heads we forged a score or so. The next morning, on entering the forge, I saw several broken rabble-heads; they were so brittle that they broke in several pieces in being dropped on the cast iron floor-plates.

Was that due to tin in the iron?

Yes, in rolling the tin-plates after dipping, to remove the superfluous tin, a double or perhaps treble thickness forms on one edge of the plate. That thickened edge was our undoing; if we left the tin-plate scrap in the solvent long enough to dissolve the extra thickness of tin on the edge, sulphide of tin was precipitated on the larger portion of the plate, greatly reducing our tin recovery; furthermore, there appeared to be a sort of tin-iron alloy in the pores of the plates that could not be removed. This tin rendered the iron 'cold short.'

Did you try other means to remove the tin from the scrap?

Yes, and succeeded by using a weak solution of lime chloride as a dip, before feeding the de-tinned scrap to the puddling furnace. This gave us a higher recovery of iron in blooms and quite free from tin, which latter was volatilized as chloride. We ran a batch of five tons of blooms, sold them to the tin-plate works, where they were rolled into plates and covered with our refined tin, thus realizing Mr. Parnell's ideal, but the blooming process would not pay.

What did you do with the iron after that?

The rabble-heads we made proved much superior to common iron in skimming furnace-changes, and we supplied the copper-smelters with rabble-heads at good profit. Later, we sold them ladles of the same iron-tin alloy, beaten out under the steam-hammers and pressed into form in molds by the same hammer.

You spoke of blast-furnace smelting?

We smelted several thousand tons of tin-slag in our blast-furnace and did very well, using puddling-furnace cinders to break up the tin silicate and incidentally accumulated quite a bit of 'hard head,' a tin-alloy, the subsequent treatment of which caused more trouble than anything else about the plant. I left considerable of it for my successor to work up.

What about copper-matte smelting?

The business was controlled by a large firm of ship-owners who picked up cargo in various places and sent it to the Stannic works for reduction. I recall a large cargo from Algeria, containing gold, silver, zinc, and

2% copper. It was my first experience with zinc, and I had a very bad time of it with 12% in the charge. In the midst of my troubles your uncle, Richard White Rickard, dropped in; I believe the ore came from his mine; we became good friends and he proved a great help to me later; permit me to say he was a splendid engineer, one of the best informed men I had met and an all-around good fellow.

Did you remain long at Swansea?

After a year and a half my health suffered from the ever-present sulphur fume, so I left with the good wishes of the board, and a handsome testimonial from Mr. Parnell for "improving and completing his process." I

boyish questions. I remember also that the mine was exceedingly hot, and of being awakened to an appreciation of the heat generated by chemical decomposition. If I remember correctly, you went soon afterward to New Zealand, on the recommendation of my father?

I did, but first I spent a year in London as manager of the Barking Metal Works. Antimony smelting and refining.

How did you like that position?

Very much, it was extremely interesting and instructive work. The smelting was done in crucibles, using salt cake, and rich slag, with tin-plate scrap for desul-

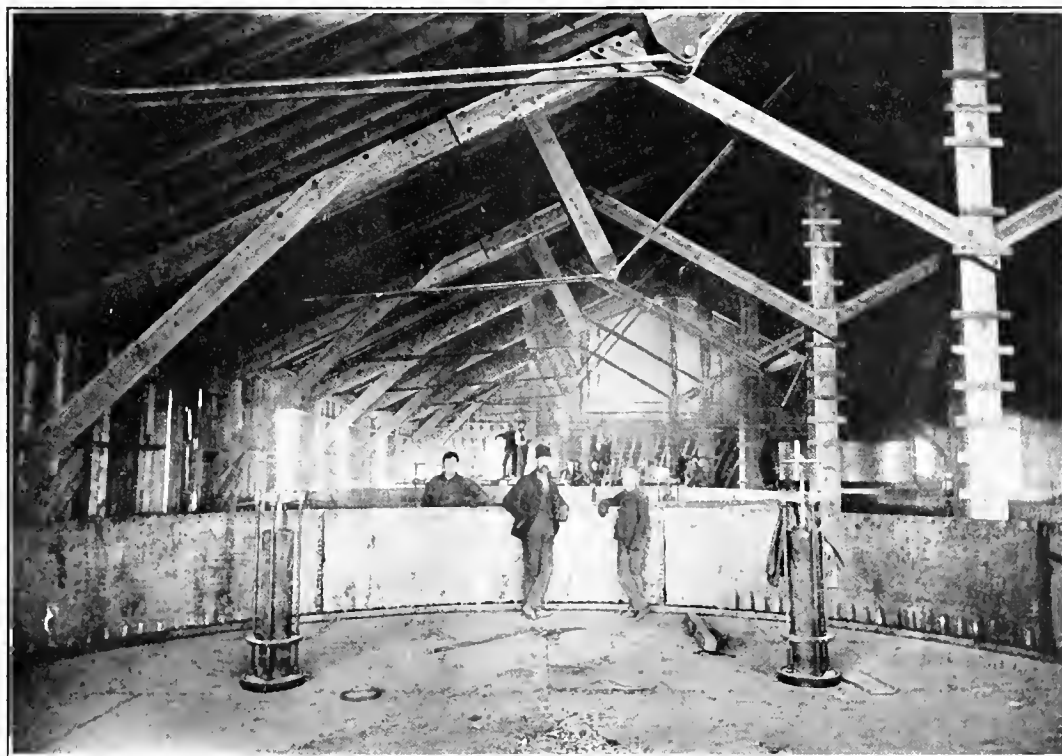

RIVETTING A 30-FT. STEEL TANK, METALLIC WORKS, FEBRUARY 1895.

returned to mining, accepting the management of the Glenariff Iron Ore & Harbor Co., in county Antrim, Ireland. The supervision of extensive mines of aluminous iron ore, pisolitic, below the basaltic plateau, ten miles of railway, and the fascinating geology of the Glen kept me busy for a year, during which I published a paper on 'The Tertiary Iron Ores of Antrim.' Mr. Rickard next offered me the management of the Duchy Peru mine in Cornwall, of which he was then consulting engineer; so in 1881 I found myself mining zinc-blende with siderite gangue, hand-sorting the coarse ore and wondering what I would do with the fine, of which my predecessor left a large tonnage for good measure.

In what part of Cornwall was that?

The great Perran iron lode in the parish of Perranzabulo, about six miles from Newquay. Perhaps, Mr. Editor, you will recall that I first met you at that mine. *Indeed I do, and how kind you were in answering all my*

phurizing; the product from the first smelting, called 'singles,' was re-smelted with alkaline flux and excess of antimony sulphides, two buttons 'single' formed a crucible charge, the product was called 'doubles' or 'star bowls.' The 'doubles' were melted, and refined, with a special so-called secret flux, which was allowed to cover the plates in the mold to develop the 'star.' Our product was sold as French star antimony, and so far as I could see, it mattered little what the composition of the metal was, so long as it had a good crystallization on the surface—the much-desired 'star.' The refiner was a secretive, independent, and in his cups, insolent man. As he was inimical to proper discipline, I dismissed him, but before leaving he tampered with the refining flux. I promoted the man on the 'doubling' furnace to refiner, but he could not produce the 'star;' together we tried all sorts of mixtures of pearl-ash, adding various salts, including tin, which was believed to

help the stirring process, hence the use of tin plate scrap in the first smelting. The third day we threw away the old flux and began experimenting with fresh salts, and with the knowledge and assistance of the new refiner soon produced the much desired 'star.'

Did you introduce any improvements in the plant?

No. We were designing furnaces to smelt the ore in quantity and preparing to put in a lead stack for silver ores when the sudden failure of Richards Power & Co., in 1883, closed up the works. Lord Penzance had the largest holding, but having been misled by R. P. & Co., refused to continue operations. I realized on the stocks, the company was wound up, and I went back to Cornwall to pump out the Old Duchy Peru mine, just purchased by Brown Bros., of St. Austell.

What was your next move?

Your father, Mr. Thomas Rickard, kindly recommended me to the Kapanga Gold Mining Co., and I obtained the management of their mines at Coromandel, across the Hauraki Gulf from Auckland, in New Zealand. The Kapanga was a specimen-gold mine and the most disappointing I have ever operated; I got the tail end of one small pocket and insufficient funds to find another. The only incident worth recalling is the discovery of auriferous native arsenic, the collection of, I believe, 350 lb., of this metal from the dumps, and extracting about 50 oz. of gold from it. The pin I am wearing is native arsenic from Kapanga.

You were not long in New Zealand?

About a year. I traveled a good deal, called at all the principal ports, saw some of the best mines, visited the hot springs and volcanic district, and greatly increased my knowledge of geology and mining. I spent a few weeks in Australia, on my way back to England.

What was your next move?

Some mine examinations in France; then I met one of the Brown Bros., who offered me the superintendency of a group of mines in Sonora, Mexico. The Los Bronces and Animas mines in the Barranca district.

In what year was that?

In 1886.

How long were you in Mexico?

Almost one year. The company operated under the name of The Silver Queen United. I found a concentrating mill under erection, and no water with which to operate it, and indeed very little ore either. I procured boilers, steam-pumps, and about three miles of pipe, unwatering three or four mines without filling the reservoir, but we finally got started and made very irregular runs, because of the many shortages of ore and water. The last Rittinger percussion tables I saw in use were in this mill; we had, I believe, four of them. At Bronces the company had a dry-stamp mill and hyposulphite leaching plant. Realizing that the company had not obtained title to the property, and that its finances were in poor condition, I left at the first convenient opportunity and returned to London before the crash came.

What was your next position?

Consulting engineer to the Mountshel Iron Ore Co., in Antrim, Ireland. I built a concentrating mill of 200 tons daily capacity to recover the hematite pisolites from the aluminous gangue. The plant was quite a success. In the same year (1886) I was appointed consulting engineer to the Société Anonyme de Plomb D'Asperieres, operating on the river Lot, near Capdenac, Aveyron, France. A large concentrator had been erected against my previous advice to the company, and it did not treat the ore satisfactorily. The silver-lead, carrying an ounce of silver per unit of lead, was as soft as graphite and was enclosed in quartz of the very hardest type; slime trouble was ever present and was never conquered, although the largest fixed Linkenbach tables I had ever seen had been put into commission to save the silver-lead in the slime. It was not much of a success. To crush the quartz fine enough to liberate the galena so that a 60% lead product could be made meant enormous losses, hence hand-sorting was pushed to the limit and a jig and table product sold running high in silica.

So that did not last long?

It did. The English people struggled along for about three years with it, when a clever Welshman, one Henry E. Fry, managed to sell it to the French, who operated it for several more years; but I doubt if anyone made it pay. I was in the midst of my work improving the plant when I was offered the position of manager of the La Plata smelter at Leadville, succeeding William Hanson.

He was a man of high character, I knew him well. He died in San Francisco in February last, having been for many years the manager of the California Wine Association. When did you succeed him, Mr. Argall?

In March, 1887.

What was the condition of the smelting business in Colorado at that time?

Very bad indeed; keen competition between the valley smelters and those at Leadville, and not ore enough to go around. Sulphide ores were coming in strong and the La Plata had no roasters, the blast-furnaces were small and obsolete, ore and charges were all handled by shovel and wheelbarrow. A large custom business was being handled at a loss. I piloted the old smelter along for a couple of months and, having worked out the smelting conditions carefully, I cabled my company to either furnish \$250,000 to re-build the furnaces, put in roasters, and generally modernize the plant or go out of business. The conditions were such that I could only promise 10% net earnings on the new investment, not on the entire capital. I confess to a feeling of relief when the directors decided to close-down the smelter and cut their loss; nevertheless the night we blew down the furnaces was a trying one for me. It seemed like a metallurgical funeral. I patrolled the dump the whole night long, wondering if I had terminated a great industry that in other hands might have been profitable, or if I had

rightly advised my company. A few days later this depression passed away with the full conviction that I had taken the proper course, and I have never since regretted my action. In the course of a few years other and better equipped Leadville smelters went out of business and for years past there has been but one smelter at Leadville.

The survival of the fittest?

Undoubtedly, the largest, most modern, and best plant survived, the Arkansas Valley plant now operated by the American Smelting & Refining Co.

What became of the La Plata smelter?

I sold it to D. H. Moffat and associates. Pyritic smelting was introduced under the direction of W. L. Austin and was successfully continued under the management of the late Franklin Ballou, for several years. I had an opportunity of following the results during the trial-runs. The dust-loss at first was enormous; I was called in consultation, and designed dust-flues and condensing-towers in which the fume was washed with water, and thereafter the plant operated at considerable profit. Later, in association with Mr. Austin, I endeavored, without success, to introduce pyritic smelting elsewhere in Colorado. The La Plata smelter, partly re-built and enlarged, was afterward purchased by the American Smelting & Refining Co., and dismantled.

It was in 1887, if I remember correctly, that you examined the Rathjen mine in Calaveras county, California, and were good enough to give me my first job as manager?

You refer to the Union Gold. Yes, I remember quite distinctly examining that property and later placing you in charge there, but the rest has passed like a dream. I can scarcely recall the developments.

When did you first become acquainted with cyanidation?

After leaving Leadville I had my first dip into the cyanide process. I had of course heard and read much about it, but for some time I considered it one of the humbugs. It was in the hands of people who did not inspire confidence, and who advertised the requirements of the process as a few old tubs, some mill-tailing, a chunk or two of cyanide, and a handful of zinc shavings. Strange to say, you yourself were the first man to place in my hands actual results obtained from the treatment of sulphide ores in Arizona.

I had quite forgotten that. The results to which you

refer were those obtained on a pyritic gold ore from the Hillside mine near Prescott, then being worked by a flamboyant person called H. H. Warner, of 'Safe Cure' fame. But, Mr. Argall, you became connected with the MacArthur-Forrest people, did you not?

Yes, when the late Thomas W. Goad obtained the management of the American MacArthur-Forrest Co., he virtually forced me to act in the capacity of consulting metallurgist to that company. My first task was to rectify the failure of the first plant erected in the Black Hills; I can't recall the name of the mill but it was built at Deadwood by men from the Hill City tin mines. I believe it was in the winter of 1903. The ore could not be leached, because dust and sand were treated together in the tanks and there was too much dust. Those in charge had imported a patent pulverizer from Grenoble.

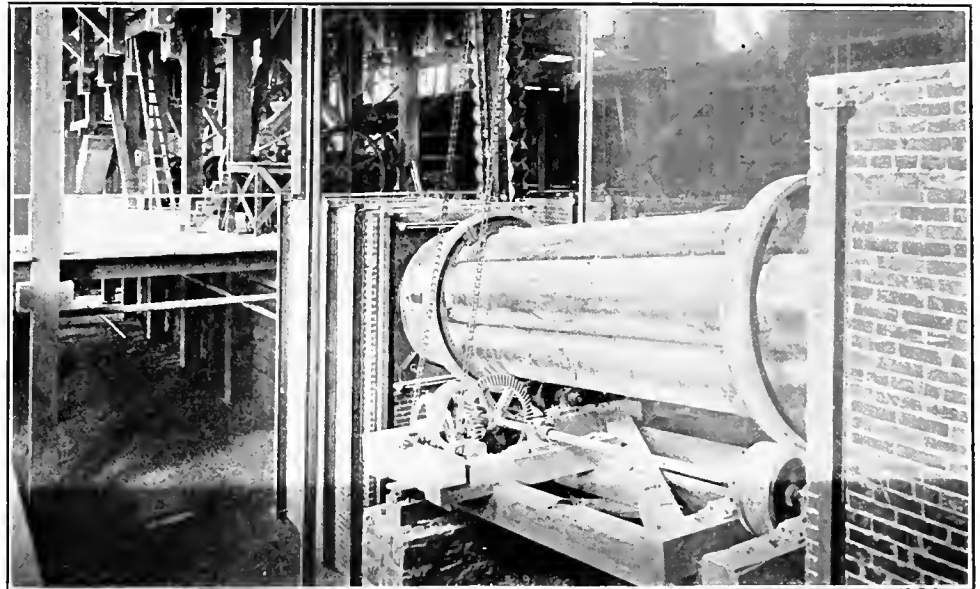

FURNACE IN WHICH THE FIRST TELLURIDE ROASTING WAS CONDUCTED.

France, believing slime—I should say "fine dust," for it was a dry-crushing machine—essential to good extraction. I had rolls substituted for the pulverizers, and with a few other changes, the plant operated successfully. However, I reached the conclusion that slime and sand should be treated separately, so I designed a special machine for separating the dust from the sand in dry crushing, and used V-boxes to effect the same object in wet crushing.

What was the name of the dust-separating machine?

It had no particular name, but I patented it in 1904; also crushing in alkaline solutions, separating the slime or dust from the sand and treating each separately. The dust-separator has since been widely used in Western Australia and elsewhere.

You anticipated what later became standard practice, but how did you treat the dust?

This was my practice in 1894; the dust was moistened and run through a briquetting machine, the bricks stacked, dried, and roasted in the same way as common

building brick are made, then broken up and cyanided. The extraction obtained from the roasted brick was so very much better than that obtained from the sand, that it led to an investigation which subsequently caused me to introduce roasting as a preliminary step to cyanidation. The experiment made on the dust from Deadwood ore gave extractions of 96 to 98%, and those on Cripple Creek ores yielded similar results.

The briquetting and roasting had the effect of giving you a porous material, I suppose?

Yes, and setting free the gold from tellurium; the bricks were so porous that I have often obtained 90% extraction from an unbroken brick.

When did you come to Cripple Creek?

In January 1894, to investigate the failure of the first cyanide plant in that district, afterward called the Brodie mill. Here the trouble was precisely similar to that at Deadwood. The charges in the tanks could scarcely be wetted, there was so much tale and clay in the dry-crushed ore. I pointed out the cause of the trouble and rectified it when enlarging the plant, which operated successfully for a year or two and was again enlarged.

What was the capacity of the Brodie mill in 1894, and what was the treatment charge at that date?

I left the Brodie mill with a capacity of 25 tons per day. The treatment charge on ounce ore was \$15 per ton and we needed every cent of it.

You next built the Metallic works at Florence, I presume?

Yes, that was my next effort. The Moffat interests were building the Florence & Cripple Creek railroad and desired to have a large reduction plant near its terminal. I was sent for and found the directors prejudiced against cyanidation, because "the ore would not leach." On the following day, I made a stack of briquettes in a cupel-mold from the slime of Cripple Creek ore, roasted them, and repaired to the First National Bank with a pocketful of the roasted cupels, a small plate, and a bottle of water. I poured water on the plate and set the cupels in it; in a few minutes the water was all soaked up by the briquettes and I added more; when the water rose to the rim of the briquettes and began to fill the bowls, the directors were satisfied, and a week later the Metallic Extraction Co. was incorporated, and by June 1895 we were treating 3000 tons of ore per month.

That was the first large custom plant to treat Cripple Creek ore by cyanidation, was it not?

Yes.

How much of the ore purchased at that time underwent briquetting?

From 15 to 20%, depending, of course, on the crushing qualities of the ore, or the amount of clay or tale in it.

When did you begin roasting Cripple Creek ores?

During the winter of 1895, I modified one of my multitubular driers and roasted and leached several

lots of 25 tons each. We next purchased a Ropp roasting furnace, the invention of Baron Alfred de Ropp, formerly manager of the Selby smelter. I believe ours was the first 'Ropp' used outside Selby; at any rate, it was the first in Colorado. Afterward I used multitubular roasters of my own design. We then purchased all the oxidized ores available and treated them direct, but the recovery of gold from the roasted product was so superior that the roasting facilities were rapidly increased, and by the close of 1897 we had a capacity of 10,000 tons per month. This was a pioneer plant in the direct treatment of sulpho-telluride ores. Engineers and metallurgists came from various countries to study our methods, more particularly the roasting feature. We had several visitors from Kalgoorlie, notably from the Great Boulder Perseverance mine.

But you modified this method later?

By the time the roasting process was fully developed, it became apparent that we were placing the cart before the horse. In roasting the telluride, coarse gold, in shots and grains, was formed commensurate with the size of the telluride particles in the feed, pieces often too large to be soluble in the time available for the leaching process; to avoid large particles we crushed finer, also placed riffles in the tailing-slucice. These riffles were very effective in collecting the 'metallies' and also some of the unroasted sulpho-tellurides, but obviously the better method under our conditions was to grind still finer; that resulted in more dust, an enlarged bag-house, and general increase in the treatment cost. I then jumped experimentally to the other extreme, with the object of making all the coarse gold possible during the roasting process and recover this coarse gold by amalgamation. Cripple Creek ore at that time contained about 2% sulphur, and I was able to make good extractions on 1-inch roasted cubes, but found that ore crushed to pass $\frac{1}{2}$ -in. round-hole screen when roasted gave almost perfect extractions by amalgamation and cyanide. Several tests on 5-ton lots were placed before the directors and a complete new plant decided on, embodying these features: crushing to pass $\frac{1}{4}$ -in. round hole, roasting the ore at that size, fine crushing, and amalgamating the roasted ore in Chilean mills using weak cyanide solutions in place of water. Drying of the ore was eliminated, also dry-crushing and dust-loss, hence a bag-house was not required. A site for the new plant was chosen at Canon City and a branch of the Florence & Cripple Creek railroad was built to Canon City to accommodate the new plant.

In what year?

I believe work was begun on the branch in 1898 or early in 1899, but was suspended when the Moffat interests optioned their railway and the Metallic plant to those controlling the Midland Terminal railway, a rival line for Cripple Creek traffic.

Was the option taken up?

Yes, and the Metallic works passed into other hands, but I remained in charge until the close of 1900, in ful-

fillment of my contract. The new people naturally did not care to build a new works and scrap or remove the plant they had just purchased for \$600,000, so I refused to renew my contract.

Was it your purpose to scrap the Metallic plant?

Not exactly; the directors decided to erect a new plant at Canon City of 15,000 tons per month capacity, and when that was in successful operation, remove the machinery from the Metallic, and ultimately have a plant capacity of 25,000 tons per month under the new process at Canon City at an estimated treatment cost 50% below our cost at the Metallic plant.

What was the cost of treating a ton of ore in the Metallic plant?

About \$3.50, all-roasting, at 9000 tons monthly capacity.

Chihuahua, and other Mexican mines, the ores of which I tested before outlining their proper treatment. I urged consistently that cyanide was bound to win as against chlorination in the treatment of Cripple Creek ores; cyaniding was so much simpler, so much cheaper, and with the many improvements introduced throughout the vast regions tributary to cyanidation, the process would yearly become simpler, more certain, and cheaper.

Did you make any bromination experiments?

Only on a laboratory scale. The late H. R. Cassel was the bromine protagonist and a most remarkable man. I first met him in 1887 when he was building the Nelly Bly mill to exploit his bromine process in Boulder county. We next met at the Telluride mill, at Colorado City, afterward called the Golden Cycle mill. This was erected to treat Cripple Creek ores by leaching with bromine solution in open vats, displacing the bromine



THE METALLIC WORKS AT FLORENCE, COLORADO, 1896.

How did you treat the 'metallies' caught in the sluice?

We first sold the heads to the smelters and sent the lower-grade back through the plant. Then I put in a small Chilean mill, amalgamating plates, etc., and ground fine, amalgamating the entire product. In this test-mill I also made my first experiments in amalgamating and cyaniding the coarse roasted Cripple Creek ore.

What became of the Metallic mill?

It was operated for about six months after I left; the new owners helped to form the mill 'trust' or 'combine,' in which chlorination was the dominant feature. The Metallic mill was sold to this group, closed-down, took fire while being dismantled in 1904, and burned to the ground. Financial affairs often upset the best-laid plans of metallurgists, so through financial backing, and not because of merit, the chlorination process reigned supreme for about six years.

But that did not end your connection with cyanidation, Mr. Argall?

No, I maintained my interest in cyanidation by frequent contributions to the technical press, by lectures, and in consultation work; such as the Dolores mine, in

the filtrate with chlorine and recovering the bromine for re-use. The evolution was from open vats to covered vats, covered vats to revolving barrels similar to those used at that time in the chlorination mills, and, lastly, to straight chlorination in the revolving barrels. J. T. Milliken, of St. Louis, having secured an option on a block of Telluride Reduction Co. stock, employed me to look into the process at the time of the trial run. I pointed out in a letter what I considered the weak points and advised him to not exercise his option. He followed my advice. A few years later, 1904, the plant went into the hands of a receiver and at Goldfield, Nevada, an urgent telegram reached me, requesting that I come at once to New York for a consultation. I did, and found that Mr. Milliken had handed my letter on the process to the company; that it had been discovered by the receiver, and found a fairly accurate forecast of the shortcomings of the Cassel bromine process, so much so that the directors desired my advice. I examined and reported on the plant, placed a valuation on it, and advised that cyanidation be introduced. The large shareholders held some meetings and finally decided that they had had enough. I believe the money lost in that ven-

ture was about \$800,000. Toward the close of operations Mr. Cassel was working on an electro-chlorination scheme somewhat similar to the Clerici-Pelatan, in which salt was electrolyzed in cyanide solution, but the apparatus had not been set up.

But you redesigned and greatly enlarged this mill later?

Yes, in 1906-7, after Mr. Milliken had purchased the old Telluride mill, I had the opportunity of introducing the methods I had intended using at Canon City in 1899 with, of course, such improvements as had developed in the interval. The old roaster-building was enlarged, a new sampling and fine-crushing mill added also a large leaching plant and storage-bins. The scheme was to crush the ore without drying, to somewhat less than $\frac{1}{2}$ inch, roasting, crushing fine, and amalgamating in Chilean mills; separating the slime from the sand and treating each separately. I never operated the plant, however. After a set-back through fire the plant gradually forged to the front and drove chlorination from the field, so that for the last three years cyanidation reigned supreme in the treatment of Cripple Creek ores.

What is the present capacity of the Golden Cycle mill and the cost of treatment?

The mill is reported to be treating about 40,000 tons per month and is paying \$30,000 per month in dividends on a capital of \$1,500,000 or 24% per annum. The total gold production is in the neighborhood of \$50,000,000, five times the total production of the Metallic Extraction Company. I have not seen any recent treatment cost.

What was your next important work?

I was very busy between 1903 and 1907, apart from the work noted, traveling extensively in Mexico on consultation work. One case of importance was at a cyanide plant where old tailing would neither leach, filter in a press, or settle for a decantation. It proved to be a surface-tension phenomenon, cured by the addition of 2 pounds of sulphuric acid per ton of dry slime. An agitated charge, after 12 hours standing, gave less than 1 inch of clear solution; after acid was added, over six feet of clear solution could be drawn off under like conditions of time and charge. That was one of my best day's work; on leaving, I told the superintendent to cut down the acid after everything was running nicely; a year later I wrote to know how much acid he was using, he replied "Two pounds per ton of slime. I tried to reduce the acid on various occasions, but the settling rate decreased, as did also the extraction." So in this case of arrastra tailing, acid increased the extraction and made decantation possible.

In the fall of 1905 I had charge of the field-work of the Zinc Commission appointed by the Government of Canada to investigate the zinc resources of British Columbia and test the ores to determine the best commercial process for beneficiating them. It took the greater part of 1906 to complete these ore-tests and prepare the report and maps. That work has been well received, and may be said to have stood the test of time, though the field-work was greatly rushed in an endeavor to get it finished before snow-fall.

When and how did you become connected with Stratton's Independence?

In November 1906, while in the Arizona desert, I received a cablegram from London offering me the position of consulting engineer, with special request to make prompt investigation of the best means for treating the big dumps at Stratton's Independence mine, at Cripple Creek.

Had any previous work been done on the dump?

Yes, Cassel had built a small testing-plant, introduced his electro-cyanide process and the Cassel filter process, in which latter the old Stratton's Independence company had an interest. Godfrey Doveton and others investigated this, the last of the Cassel processes, and turned it down. Over \$60,000 had been spent and nothing particular accomplished, except sampling the dump, hence the directors were very anxious for me to get busy and report. I started concentration tests in January 1907, and determined the recovery available by that method. Next, the recovery by cyanide from the tailing. I then fell back on long years of experience in arriving at the cost of the various operations, such as mining the ore from the dump, delivery of it to the mill, crushing, concentrating, cyaniding, treating the concentrate, and marketing the bullion. I cabled my results in March 1907, claiming a working cost of \$1.52 on a basis of milling 10,000 tons per month. This, mind you, at a time when custom mills were charging \$5.50 to treat a ton of low-grade ore. Of course, I laid myself open to criticism by stating that such ore could be treated on the mine for about one-fourth that cost, and I certainly received my full share of attention from the people that fail to advance with the times. It was a new problem, anyhow; it cost us \$3.50 to treat a ton of ore at the Metallic works; here a profit had to be made from \$3 ore.

I know you worked within your estimate for some years, but how did cost and extraction average over the milling period?

The milling of 671,665 tons in 6 years shows an average treatment cost per ton of \$1.5138, and an average extraction of 74.57%, against my estimate of \$1.52 and laboratory extraction of 74.22%.

The agreement between the figures is almost uncanny?

Perhaps it's a coincidence; the cost during the six years varied with the tonnage, the lowest annual cost being \$1.38 on 133,875 tons; the highest, \$1.79 on 68,711 tons.

You have had a long and active experience in the metallurgy of Cripple Creek ores?

It has been my privilege to see the cost of treating these ores by wet methods, reduced from \$15 per ton in 1893 to \$3.50 in 1898 and to \$1.38 in 1913.

Have you had anything to do with flotation?

Yes, quite a little. I was familiar with Henry E. Wood's experiments and had read about the Elmore vacuum process. In 1907 I had an Elmore expert test a line of samples from the Independence dump. The re-

sults were very erratic and on the whole little better than water concentration gave. I had sufficient tests made to lead me to the conclusion that the Elmore process was of no use in treating that particular dump, which contained much oxidized stuff; furthermore, cyanide treatment of the flotation tailing was equally uncertain and invariably low. At first I attributed poor extraction to the acid, and later to oil, which I concluded interfered with the solvent action of the cyanide; so I dropped the matter in disgust.

Just what recovery did you obtain by the Elmore vacuum-oil flotation process?

Taking the more regular of the tests:

But you have used flotation since?

Certainly, we have been floating these very ores for almost three years now, and I assure you we have one of the most complicated mixtures ever encountered, consisting of sphalerite, intimately blended with magnetite, pyrite, pyrrhotite, specularite, galenite, and chalcocopyrite in a lime and tremolite gangue.

What mine is it?

The old Graphie, now the property of the Ozark Smelting & Mining Company.

What phase of flotation do you employ?

Surface tension or 'film flotation,' as I prefer to call

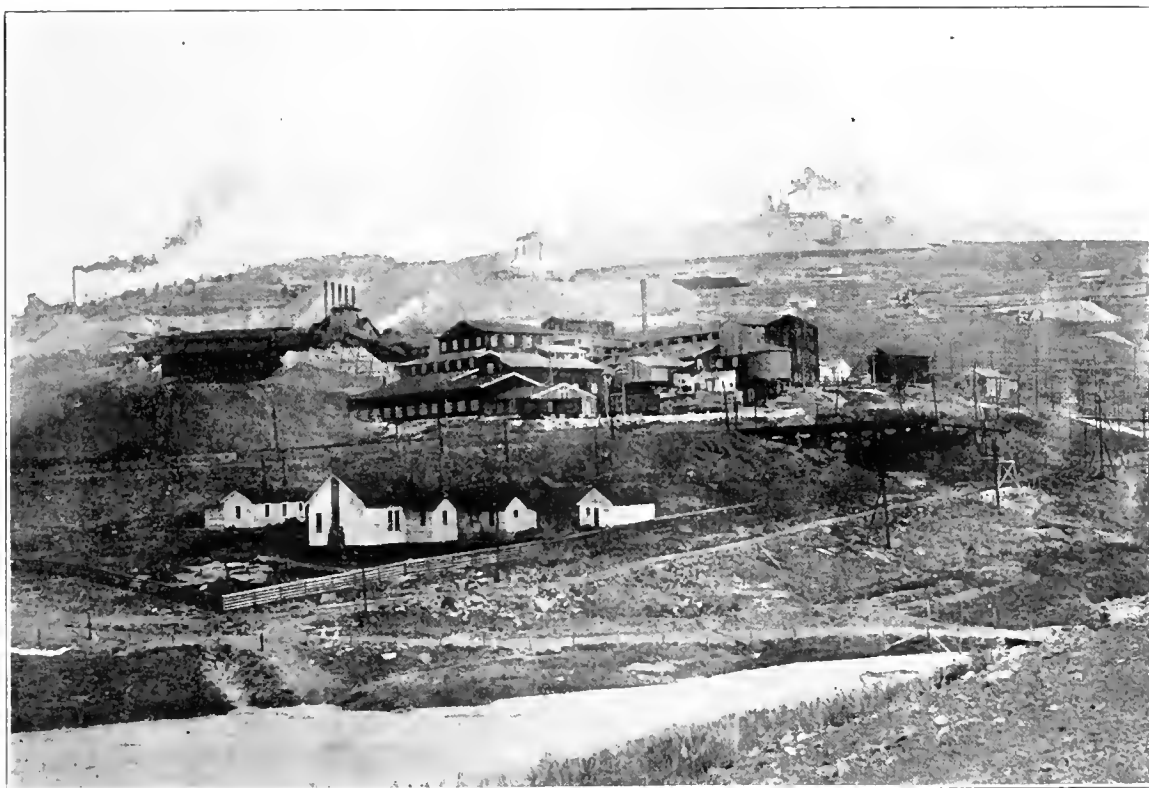

THE INDEPENDENCE MINE AND MILL, CRIPPLE CREEK.

| | |
|------------------------|--------------|
| Ore reduced to 20 mesh | 34% recovery |
| “ “ “ 40 | “ 50 |
| “ “ “ 60 | “ 51 |

In the same year, 1907, I was investigating the ores of the Graphie mine, at Magdalena, in New Mexico, a very bad mixture of sulphides and iron oxides. Again I had tests made by the Elmore vacuum process, and the results were extremely erratic, but two tests gave a concentrate exceeding 40% zinc, one a 46% zinc concentrate, the highest-grade product secured up to that time. Several other tests gave only a 30 to 40% zinc concentrate with a very poor recovery. It appeared that the specularite in the ore became oiled under average conditions in the vacuum process and floated readily; on the other hand, much of the zinc failed to oil; consequently the majority of the tests gave unfavorable results. Still I believed that flotation offered the best solution, and advised the company to erect a small testing-plant, seven years ago.

it, in distinction from the 'scum' or 'froth' that is allowed to accumulate in a thick layer by other methods.

I understand that you use oil?

Yes, we use mineral oil, and that is, perhaps, one of the chief points of departure. We are pretty well out in the desert there and use Diesel engines for generating power, and have gotten the oil question down to the point where we use the same oil in the Diesel engine that we use in the mill for flotation purposes.

But I understood you to say that the result of the use of oil with agitation is to give a film rather than a froth?

Precisely, crude oil, or residuum, can scarcely be classed among the good froth-producers.

Do you make a froth?

No, the ore is agitated with oil and acid and presented in large open vats to a surface of briskly moving hot water, on which the oiled particles float away rapidly as

a thin film, and the unoiled particles sink. There is no froth to be seen on the vats at any time.

What becomes of the matter that sinks in the vats?

It passes to other mixers and is given a second, third, and, if necessary, fourth opportunity to oil and float.

When the mixture of ore, acid, and oil is discharged upon the surface of the hot water in the vat, the oiled mineral forms a film, I presume?

Yes, a continuous film of considerable cohesion, but very thin. I might add that owing to the intimate mixture of complex minerals we crush very fine, over 50% of the pulp will pass 200-mesh.

Which of the sulphides are found in the film on the hot water?

Mostly the sphalerite, with some pyrite. Pyrrhotite often favors sinking unless excess of oil is present.

Does that suggest that the sphalerite has a greater selectiveness for the oil than pyrrhotite?

I believe it does.

As you are crushing so finely, I presume that slime offers no obstacle to the operation of this process?

None whatever, the most marvelous recoveries are made despite the fineness of the pulp, both the highest-grade zinc and the highest recovery are obtained from minus 200-mesh pulp.

Can you give me any figures of actual extraction?

You scarcely expect a full answer to that question. I can, however, answer it in part without giving away any secrets. We make no recovery of zinc carbonates or oxides, but of the sulphides that are minus 200-mesh. Our recovery is around 95%, making a 45% zinc concentrate from 16% zinc ore in one operation. I have been astounded at the recoveries that it is possible to make from slime, by flotation methods. In slime treatment, I feel assured, the future of flotation lies.

Do I understand you to say pyrite, pyrrhotite, and other sulphides, except the zinc sulphide, sink with the gangue minerals?

I do not wish to convey that idea: pyrite is always troublesome, pyrrhotite less so, yet when the minimum amount of oil is used we do sink some of the pyrite and much of the pyrrhotite. Under certain conditions there appears to be a selective action for the sulphides in the order given. The ore is delivered from the mine to a breaking and sorting plant, where pyrite, other sulphides, and waste are sorted out as closely as possible on a picking-belt. The sorted ore is then conveyed to the mill, one mile distant over an aerial tram and the remaining sulphides treated by flotation.

Do you have to re-treat your first film-concentrate?

No, just dewater it. The concentrate-overflow from all the vats is pumped direct to an Oveco classifier, the overflow from which consists of dilute gangue-slime, all of which will pass 200-mesh and assaying about 3% zinc, while the concentrate discharged from the screws will average about 45% zinc.

How do you remove the specularite?

By strict adherence to film flotation. In the Elmore flotation specularite was taken up with the sphalerite in the mineral 'scum' or 'froth,' perhaps on account of its high lustre. Specularite, though an oxide, is easily floated. Henry E. Wood tested the Graphic ore for me on his machine in 1907, using water only; the specularite floated beautifully, with some of the sphalerite. Mr. Wood said at the time that specularite was the only oxide he knew that would float in his process. Why we sink this mineral in our process is difficult to explain, but it is done.

What do you call the process?

The Ozark Flotation Process, worked out especially for these ores, and patented by W. Sydney Stevens of Magdalena. My firm is responsible for the detailed design of the plant and general supervision of its operation.

I recall your article on the occurrence of siderite in the Leadville ore, published in the MINING AND SCIENTIFIC PRESS of July 11 and 25, 1914; has the discovery proved of economic importance?

There is yet no market for siderite carrying 20% manganese and 25% iron; siderite, however, is of great importance in prospecting for sulphide ores and occasionally for zinc carbonate ores, "no siderite, no sulphide" is now a recognized guide in prospecting in the White Limestone horizon.

The much debated and vexed question of the origin of the manganese in the oxidized ore, or "black iron," of Leadville is finally settled. My reference to siderite as the source of the manganese in the *Mining Magazine* of April, 1914, was not fully convincing, but the second paper 'Siderite and Sulphide' has proved incontestable; furthermore I have recently found what I call the Rosetta stone of Leadville; a piece of siderite colorless and unaltered at one end, passing into 'black iron' at the other, through the oxidation of the siderite.

Have you made further researches on what you call 'vein' siderite?

I have, and find in every case that vein siderites carry high value in manganese, specimens from Mullan, Idaho, show as much as 25% manganese in siderite associated with chalcopyrite, magnetite, and quartz. The fact I endeavored to establish, that vein siderite is invariably manganiferous, may have wide economic importance.

Mr. Argall, you are now in consulting practice in Denver. I believe your sons are following in your footsteps? By the way, when were you married?

Some few years ago I formed a partnership with two of my five sons. The two partners are Philip Henry, who is a graduate of the University of Colorado and has practised in metallurgy for several years, four years at the Selby plant, part of the time as assistant-superintendent; and George, a graduate of the Columbia School of Mines, and now general manager for the Iron Silver Mining Co. at Leadville. We are consulting engineers to the latter company, Stratton's Independence, and the

Ozark Smelting & Mining Co. I was married on August 31, 1876, in the sweet Vale of Oveoa. My wife, who died in 1903, was the daughter of Capt. George Oates, a Cornishman with a long ancestry of miners, a man to whom I am indebted for much of my early training in engineering and ethics.

You consider that our profession is still one that offers good opportunity to young men?

I consider that mining and metallurgy offer the very best opening to talented energetic young men, and the openings in the future will be far better than they have ever been in the past.

I remember that you received the gold medal of The Consolidated Gold Fields of South Africa, through the Institution of Mining & Metallurgy in 1903.

Yes, the medal and 40 guineas was unanimously awarded to me by the council of the Institution for my paper on 'Sampling and Dry Crushing in Colorado,' in other words, the mechanical treatment of ore by the dry process.

What do you consider your best achievement?

The introduction of the 8-hour working-day in Colorado mills, in the spring of 1899, at the Metallie works, without consulting my directors. It led to better work, in time, to a better class of workmen, and a greater tonnage handled per man, in a word, to the elevation of our workmen and the lowering of the working cost.

TUNGSTEN discoveries are being made in the Black Hills, South Dakota, as described in our issue of November 27. Three areas are known, the Lead-Flatiron, Tinton, and Harney Peak pegmatite districts. At the Wasp No. 2 gold mine at Flatiron the ore appears to be a replacement of dolomite at and near the top of the Cambrian quartzite; the deposits are nearly horizontal, about a foot thick, 4 or 5 ft. wide, and at times several hundred feet long. The Wasp company recently shipped 26 tons to the Crucible Steel Co. at Pittsburg; the lot was valued at \$54,000. The low-grade ore has been put on a dump, for the concentration of which a plant of 25 to 30 tons daily capacity will be operated as soon as machinery arrives. The company's profit from wolframite appears likely to be larger than the net realization from its cyanide plant. The ore is fine-grained, hard, and tough, requiring grinding to not coarser than 30-mesh in order to make a good recovery. The ore is mostly wolframite, scheelite occurring only in small grains. In the Harney Peak area, wolframite and ferberite occur in quartz veins and pegmatite dikes, although so far no production has been made from the latter. The veins are generally less than a foot thick, with walls of schist, granite, or pegmatite; their direction is usually parallel with the schistosity of the wall-rock. In other localities small veins have been discovered; the quartz veins as a rule produce clean ferberite, with occasional scheelite, and since the ores contain no pyrite, tautalite, columbite, or other heavy interfering mineral, a good product is made. In the Tinton district the placer deposits yielding wolframite and scheelite are low-grade.

Metal Mining in Japan

According to a report issued recently by the Department of Agriculture and Commerce, the mining industry in Japan has in general been favored by the War.

GOLD AND SILVER. Mining of these two metals has been favored more than others. New gold mines have been recently opened, and the output from those in the province of Idzu has increased. Their ores are being sent for refining to the Kubara Mining Co. in Hitachi province. The output of refined gold in Kushikino, in Kashima prefecture, owned by the Mitsui Mining Co. and in the Matsnoka mine, in Akita prefecture, owned by the Fujita Gumi, has also improved. The amount of gold recovered to the end of September 1915 shows an increase of 24%, compared with the amount in the corresponding period of 1914.

COPPER. Japanese copper has in the past been mostly in demand in China, but the decrease of coinage in that country in recent years caused a depression in this trade last year. The outbreak of war, however, saw the sudden growth of demand for war use toward the end of last year. Since then, the metal has been supplied to England and Russia in large quantities.

ZINC. The zinc-refining industry in Japan is of recent origin. In 1913 the Mitsui Mining Co. started zinc refining in its Miike mine, and the Osaka Zinc Co. in the Kamishima refining works, Okayama. The management has had to overcome various technical and economic difficulties to push on the work in the earlier stage, but the War has cut off the supply from Germany and Belgium, and has encouraged the new industry in Japan. The amount of refining is steadily increasing. At present, the metal is even being exported to Russia. Judged from the present conditions, it would seem possible that Japan will establish permanent independence in the supply of zinc after the restoration of peace. Besides the above mentioned refineries, there are also the Yasojima, Niigata, Takaehiho, Yamaguchi, and Shikama, Hyogo. Zinc ores are supplied partly from Chosen, the coast province of Siberia, and Australia, and partly from home mines.

THE superintendent of the Mint at San Francisco, T. W. H. Shanahan, reports the following receipts for the calendar year 1915:

| | Fine ounces. | Value. |
|--|---------------|------------------|
| Gold | 5,798,686.341 | \$119,869,484.97 |
| Silver | 2,120,595.240 | 1,958,711.50 |
| Coin, bullion, etc., on hand at close of business on December 31, 1915 was as follows: | | |
| Gold coin | | \$6,293,507.50 |
| Silver coin | | 61,607,187.18 |
| Minor coin | | 26,680.26 |
| Checking balance Treasurer U. S. | | 3,721,834.91 |
| Gold certificate bars, | | 176,717,272.59 |
| Gold bullion | | 110,330,121.40 |
| Silver bullion | | 1,174,956.67 |
| Total | | \$359,871,560.54 |

Mining in Utah

By L. O. Howard

THE past year has seen the mining industry of Utah return to a condition as prosperous as that preceding the collapse of 1907, and announcements made near the end of the year presage even more prosperity. The development of a potash industry in Utah has been widely noted. The plant of the Mineral Products Co. at Marysvale has been producing 25 tons of potash salts daily for some time past. It has been decided to treble this capacity, and plans are being drafted for the extension of the aerial tramway to bring the product of the mine nearer the mill, there being a wagon-haul of about four miles from the present terminus of the tramway to the mill. It is also announced by officials of the company that some progress has been made toward the extraction of aluminum from the by-product alumina. Other possibilities suggested are the manufacture of refractory materials from the by-products of the potash extraction.

Another company, the Utah Potash Co., of which F. A. Fitzpatrick of Philadelphia is the active head, has announced its intention to erect a mill at Marysvale, and is receiving bids for an 8-mile tramway to connect mine and mill. F. K. Cameron, formerly of the U. S. Bureau of Soils, is the company's chief chemist. In addition to the holdings of these two companies there are said to be many other promising alunite veins in the district; these have been located by others.

Efforts to produce potash have not been confined to the alunite district. A strong organization is building a plant near Great Salt Lake with the expectation of recovering potash from the brine of the lake. The content of the brine in potash is so low, however, that many regard this attempt as likely to succeed only during the period of high prices. Little doubt is expressed as to the operation being profitable while war prices prevail, and it is decidedly possible that the costly experience gained during the period of high prices may enable the company to remain in business when the market again becomes normal.

The Promontory zinc district continues to maintain its excellent rate of production. Successful development has given great impetus to the search for zinc ore. It has been distinctly a poor man's opportunity. Little initial capital was required and the dividends within a year of the first development have exceeded, I believe, the money invested in the district. The Lakeview Mining Co., the principal operator, has paid dividends of over \$45,000 on an original investment said to be less than \$4000. Minnesota capital has recently come into the Santaquin-Nebo district, where large bodies of low-grade lead and zinc carbonate ores have been known for some time to exist, and it is likely that the coming sum-

mer will see the removal of the handicap under which this district has labored through lack of capital.

In two branches of metallurgy great advances are expected in 1916. At Murray, the American Smelting & Refining Co. has been making electrolytic zinc at the rate of about two tons per day. There is a possibility that this experiment will warrant the construction of a plant of commercial size. Much work is being done looking toward the extraction of zinc by hydro-metallurgical methods, in order to relieve the smelters of the necessity of discarding valuable zinc from their mixed lead-zinc ores, and to avoid not only this waste, but the accompanying losses in zincy slags. With the aid of flotation in the making of a high recovery of the lead and zinc sulphides, roasting in furnaces of the McDougall or Wedge type and leaching, it is expected that the zinc can be recovered as a valuable product and the residue utilized for its lead-silver content, with better results than now obtained where a lead ore high in zinc must be charged to the furnaces. The local station of the U. S. Bureau of Mines reports gratifying progress in the treatment of mixed carbonate ores also. Great advances in the metallurgy of lead and zinc are indicated in the current year.

War prices have also induced the final drafting of plans for the manufacture of sulphuric acid. A plant is to be erected to be operated in connection with the Garfield smelter, the first unit of which is to have a capacity of 100 tons of acid daily. Here, also, a loss of the past is expected to be converted into the gain of the future.

Operations in the Cottonwood districts have been greatly hampered by the heavy snow-fall of the last few weeks, but are being advanced with a vigor not seen since the early days of the districts. The output for the past year has been estimated at 25,000 tons, double that of the previous year. It is likely that this increase can be accounted for in the production of the Cardiff mine. Shipments will be increased as soon as the snow has packed enough to make hauling easier. Every little prospect has two or three men at work, either driving tunnels on contract or leasing in old workings.

On the Big Cottonwood side of the district the following companies have from two to six men working: Reeds Peak, Branberg, East Carbonate, Big Cottonwood Consolidated, Tar Baby, Price, Monte Cristo, American Con. Copper, Kennebec, Last Chance, Baker, Copper King, Swastika Copper, Woodlawn, Logger, Alta Tunnel & Transportation, Mines Development, Big Cottonwood Coalition, Giles, Alta-Cottonwood, and the Antelope and Prince of Wales lease. In Little Cottonwood the following are active, Sells, Albion, South Hecla, Alta Consolidated, West Toledo, Columbus Extension, Michigan

Utah, Emma Copper, Alta-Tiger, and Wasatch Mines. In addition the Cardiff employs about 100 men, and the Maxfield something less than half that number. Activity extends from the extreme eastern to the extreme western edge of these twin districts. One small mill is in operation jiggling the old stope-fillings of the Prince of Wales, which are stated to average \$8 per ton in lead and silver. Other companies are known to be planning extensive development as soon as weather conditions will permit it in the spring. Indications point to a heavy production next summer, as a result of the large amount of work

The Nation's Life

In his annual report the Secretary of the Interior says: "There is an evolution in a new nation's life quite as interesting as that in the life of a man. We pass through stages of development from the simple and earlier period when food is the one thing desired into the more elaborated and complex stages where first we begin to deal with the easily handled things and later reach the point where mind has a controlling part in all that is done. The pioneer builds his cabin and turns his cattle to graze upon the unfenced wilderness. He takes his water from the stream and makes his gun serve him with food and give him protection. It is not many years, however, before he has passed from herdsman to farmer, when soil must be plowed and seeded down. At first the one-horse plow will do, and any seed. But life grows more intense—society has gathered around, new demands are created—machinery must be used, seed must be selected, soil fertilized, credit obtained, markets sought, and the life of the simple herdsman has become complicated and broad. The gay recklessness of other days gives way to constant thought. So has it been with this country. For a long time we lived off the country's obvious supplies. Later we were producers of raw materials—grains and minerals, lumber and cotton. When manufacturing began it was of the larger, coarser things, which perhaps in their turn went abroad for higher fabricating. Now, however, we have come into the full tide of modern life when we seek for greater and more varied industries, wider markets, more economical methods of production and exchange. And in such a new time direction is needed, mutual and co-ordinated effort must be set up and the more elaborate machinery of organization put into service. Thought becomes the basis of the new life—hard, close, insistent, constructive thought, illuminated by knowledge and made practical by imagination."

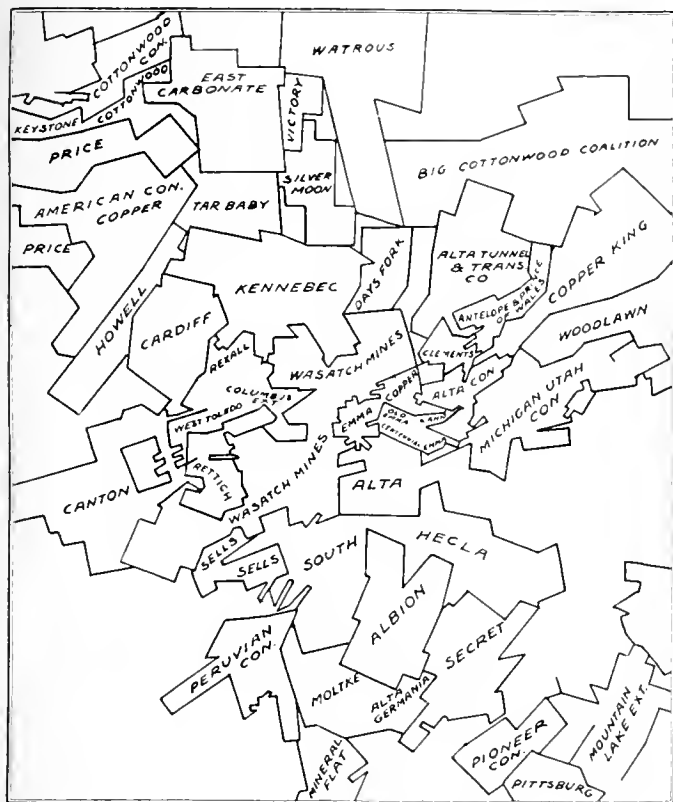

THE COTTONWOOD DISTRICT, UTAH.

being done, and the systematic expenditure of money by many companies.

This activity bids fair to extend to the adjoining American Fork district. Development work is in progress there, and more is planned. It is also certain that a publicity campaign such as was engineered for the Cottonwoods last summer is in preparation in connection with American Fork.

Owners of mining locations in Beaver county are quietly planning an energetic development for this year, and it is probable that the attention of the investing (or perhaps the editor prefers 'speculating') public will be strongly directed to this district. The entrance of the United States S. R. & M. Co. into the Fortuna district will result in well-directed exploitation of that section of Beaver county.

The Cottonwoods and American Fork districts have been made the subject of a short study by geologists of the U. S. Geological Survey, a report of which has just been issued. Comment is reserved for a later article.

FIRST COST IN BUYING is illustrated by a story told in the interesting little monthly publication of the W. S. Tyler company of Cleveland. In a club in that city, a member of the restaurant committee, who was looking to cut costs, remarked to the steward that it seemed extravagant to buy domino sugar of which each lump was individually wrapped in paper. "Yes, but it is quite a saving in our sugar bill," said the steward, "in spite of the fact that it costs 10% more. In the first place, when we bought unwrapped cube sugar, there was always 10 to 20 pounds that became granulated in the bottom of the barrel, and which could only be used for cooking—at cube-sugar prices. Then, there are many cubes wasted on the table and these have to be thrown away by reason of being stained when taken out of the bowl with a wet coffee-spoon. Then, still another and very large economy in wrapped sugar is the fact that people do not use so much sugar when they have to go to the trouble of taking off the papers."

The Chuquicamata Mine

By Pope Yeatman

*The Chuquicamata mine is situated at Chuquicamata, in the great arid region of northern Chile. It is, as regards tonnage and content of its valuable metal, the greatest known copper deposit in the world. It is unique in that its principal mineral, brochantite, is mined on a commercial scale in no other locality. Labor conditions are good. The Chileans are strong and active and make good miners and mechanics.

The ore outcrops over a length of about 8000 ft. and an average width of about 554 ft. The ore deposit represents a section of great dynamic disturbance, which allowed the deposition later of primary metallic minerals, brought in by solutions from below. Taking a cross-section through the deposit, five zones are represented, which, beginning at the surface, are as follows:

1. Leached zone or capping.
2. Oxidized ore or zone of brochantite, carrying oxidized minerals of copper.
3. Mixed oxide and secondary sulphide minerals, representing the transition between the oxide and sulphide ores.
4. Secondarily enriched sulphide zone.
5. Primary ore. This is represented by iron pyrite, chalcopyrite, enargite, and bornite, which were deposited from hot solutions introduced from below.

Drill-holes and shafts have so far shown a thickness of 361.3 ft. of oxidized ore, 116.3 ft. of mixed oxide and sulphide ore, and 58.6 ft. of straight sulphide ore.

The value of the deposit is due primarily to secondary minerals, resulting in the concentration of values and in oxidation of such secondaries as sulphate. These latter, instead of being removed entirely, owing to the remarkable aridity of the district, were not carried off by surface water, and hence produced, even in the zone of oxidation, commercial ore.

Ore reserves, as of April 25, 1915, amounted to over 300,000,000 tons, containing better than 2% copper. Mining is done by means of steam-shovels. They load into broad-gauge cars of 60 tons capacity, which will transport the ore to the plant.

The ore is crushed to a maximum size of one-half inch and leached in vats of about 10,000 tons capacity each. Copper in the solutions from the dechloridizers is deposited electrolytically and the cathodes melted into commercial bars.

Power for operating the machinery at the plant and for the electrolytic deposition of copper is generated at Tocopilla, in a plant of 40,000 kilowatt capacity. The generators are operated by steam-turbines, and the current is conducted from Tocopilla to Chuquicamata over a transmission line 140 kilometres in length, carrying a current of 110,000 volts.

*Abstract of paper read before the Pan-American Scientific Congress, Washington, December 1915.

Preparation of Tungstic Metals

*The metal is prepared in two forms, namely powder and ferro-tungsten alloy. Much discussion has arisen regarding their respective advantages, especially with reference to the relative waste incurred during introduction of each form into the steel bath. Apparently, no decision has been reached, since both forms are manufactured, although about 85% of the tungsten is made into ferro-alloy. Powdered tungsten is fed into the bath by means of an enclosure in steel tubes, in order to prevent oxidation of the tungsten. The manufacture of powdered tungsten first demands a preparation of tungstic trioxide (WO_3) from the ore. This is accomplished by grinding the concentrate very fine in tube-mills, followed by fusion on a reverberatory hearth with sodium carbonate in the form of soda-ash and a small proportion of sodium nitrate. The hand-rabbed mass is drawn, crushed, and leached with hot water. The sodium tungstate so formed is readily soluble, while the iron remains as insoluble ferric oxide and the silica as insoluble sodium silicate. Loss from formation of insoluble sodium meta-tungstate may be largely overcome by treatment of the insoluble residue with a solution of caustic soda, which transforms the 'meta' into the normal tungstate. Indeed, a method is published whereby the mineral tungstate is purposely converted by careful addition of acid into the insoluble meta-tungstate, which is then filtered, washed, and decomposed by hydrochloric acid. The rather concentrated solution containing the sodium tungstate is heated and poured into hydrochloric acid, which precipitates the yellow tungstic acid. The latter is filtered and washed in acid-proof presses, and then dried.

Reduction of the oxide is accomplished by mixing intimately some pure form of carbon, such as charcoal or petroleum coke, and the charge is pressed into graphite crucibles, which are heated in coke furnaces to a high temperature. A rather coarse, steel-gray dense tungsten results, which, with care, may have its carbon contents kept within 1%.

Ferro-tungsten, the second product, is made mostly from the concentrate direct by electric-furnace treatment. It contains from 50 to 80% tungsten. Many different reducing materials are recommended. Carbon, in the form of coke, is the common reducing agent. Lime and silica are added to form a suitable slag, and sometimes fluorspar is added to aid liquification. Hematite is used subsequently as a de-carbonizer. Other procedures call for silicon, ferro-silicon, aluminum, and even titanium as agents to reduce the carbon contents of the metal.

BAGDAD, which is just now in the public eye, was once the centre of the known world and a city of over two million people, ranking in size with Paris or Chicago. Bagdad has now about a hundred thousand inhabitants.

*Abstract from paper by Herman Fleck before the Colorado Scientific Society.

Flotation in Cuba

WE are indebted to Mr. Benjamin B. Lawrence for the following notes.

The Cuba Copper Co., operating the old Cobre mine near Santiago in Cuba, was among the first to experiment with flotation, using the methods introduced by the Minerals Separation company. A little over two years ago an experimental plant with a capacity of 50 tons was erected, and as a result of the experience gained, a 600-ton plant was put into operation and has been running since March 1914.

The development of the Minerals Separation process has been so rapid that it has been difficult to keep track of the many improvements, largely mechanical, which are constantly being made. One distinguishing feature of the process is the necessity for adapting it to the particular class of ore to be treated. In the case of the

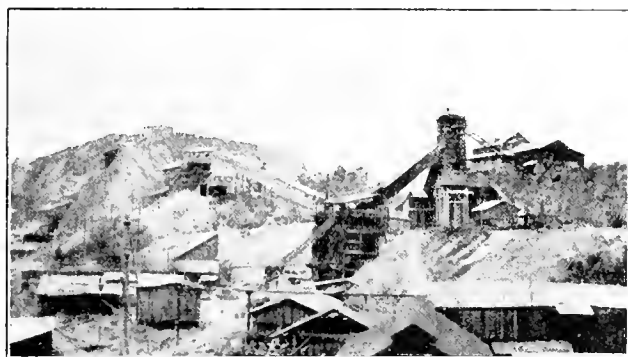

EL COBRE MINE AND MILL.

Cobre the problem is complicated. In the upper workings the ore is largely oxidized. With depth we have a good deal of semi-oxidized or tarnished ore, while in our deeper workings, we have the untarnished chalcopyrite, which, in combination with pyrite, forms the bulk of the material that the mill is now treating.

The treatment of tarnished ore has been difficult, or rather, the mixture of tarnished with unaltered ore. Variations in the character of the ore and the difficulty of obtaining uniform composition have aggravated our troubles. We have, however, succeeded in solving most of our difficulties, as the results given by Edward H. Emerson, the manager, will show. Under his direction the process has developed into a pronounced success. Mr. Emerson describes the treatment of the ore briefly as follows:

"The ore is crushed dry by rolls, screened through 8-mesh and conveyed to the storage-bin. Four Hardinge and two ordinary tube-mills are fed from the storage-bin by individual Challenge feeders to insure equal distribution of feed. Each is fitted with an electric alarm to give warning the moment anything goes wrong. It is interesting to note that one man's life has been saved by these signals. The man fell into the storage-bin and blocked a feeder. He was taken out and resuscitated with great difficulty. Failure of instant notification would have

cost his life. However, the main object is to insure regular feed, as the ratio of oil to ore is most important. Cresylic acid, carbolic acid, Mexican crude, and light asphalt oil are fed into the tube-mills by special machines. Grinding is done on a thick pulp, 25 to 30% moisture, until 65% will pass 60-mesh. The pulp goes to the M. S. box without classification or re-grinding. Fourteen stirrers with 13 spitz-boxes are used. Direct concentrate is taken from as many boxes as show a good concentrate, the poorer froth being returned to the first box. Number of boxes treated varies with this and is changed by the operator who judges by eye. All the coarse tailing is roughed over Wilfleys to recover the coarse pyrite carrying copper. Caustic soda and fuel-oil are added as needed in the stirring-boxes. The various concentrates go to the classifier, the coarser product passing direct to the bins with about 8% moisture. The overflow is thickened and drained by an Oliver filter, giving about 20% moisture. The plant handles 600 tons per day and gives about 85% extraction of the insoluble copper in a 3% feed. It is interesting to note that with El Cobre ores using a cold neutral solution wood-products have not given any satisfaction. The concentrate carries 16% copper, 35% iron, 40% sulphur, and 9% silica."

Now that we have finally succeeded in unwatering the Cobre mine, we find that the old workings reach to a depth of 1120 ft. The mine had been under water for some 80 years, and the final unwatering was completed in April of this year. The work was made doubly difficult by the underhand stoping of the earlier operators. The old stopes in the lower workings contained a large quantity of silt, and the tapping of these stopes resulted in a flow of fine mud (which, by the way, we suspect of being a precipitate), that greatly aggravated the danger of the unwatering of the mine. The final completion of this task, which has been in progress since 1907, is a great tribute to the skill of the engineer and manager, Mr. Emerson.

Nicaragua has an area of 49,200 square miles, which is greater than that of Pennsylvania, and a population of 600,000, of which 40,000 is in Managua, the capital. The Panama Canal has helped transportation by allowing coast-to-coast trade, the country having both a Caribbean and a Pacific shore; and it is hoped that channeling and dredging of the rivers will be undertaken to alleviate still further the serious lack of communication. Nicaragua has suffered from being exploited by unscrupulous politicians and adventurers. A third of the foreign trade is with the United States, and 51% of the stock of the National Bank of Nicaragua is held by Americans. Monetary conditions have been bad for years but are improving.

WASHINGTON'S production of coal has grown gradually from 5374 tons in 1860 to 3,877,891 tons in 1913. California oil is hurting the coal business of Washington. The counties of Kittitas, King, and Pierce in west central Washington contain important mines.

CONCENTRATES

Readers of the MINING and Scientific PRESS are invited to ask questions and give information dealing with technical and other matters pertaining to the practice of mining, milling, and smelting.

EDUCATION is a fundamental of the safety-first movement.

TUNGSTEN is used for phonographic record needles, spark plugs, contacts, and X-ray targets, as well as for tool-steel.

PENTLANDITE is a mineral occurring in the Worthington mine, Sudbury district, Ontario, and consists of 30.68% iron, 34.48% nickel, 1.28% cobalt, and 32.74% sulphur.

JAW-CRUSHERS are not so satisfactory as gyratories when the rock fed them consists of flat slabs, these dropping straight through the jaws. This is an experience in Western Australia.

WATER-HOLDING TREES and plants in the Panama Canal zone have been found to be breeding places for mosquitoes. One banana tree had five pockets, some holding several gallons of water. Such trees are to be destroyed.

LABORATORY PORCELAIN, used in ignition work, may be reliably marked by a very dilute solution of cobalt nitrate. The utensil is warmed and the mark made. This is heated strongly for a few minutes, resulting in a black mark.

GOLD recovered from 11,000,000 tons of silicious ores treated in the United States in 1914 averaged \$5.53 per ton. The average recovery of gold per ton from the Alaskan quartz mines was \$2.78, from California \$5.46, from South Dakota \$3.63.

PLATINUM is now worth over \$80 per ounce. A great deal of the metal is used in incandescent lamps. B. E. Eldred of the General Electric Co. has devised a combination of nickel-steel, a jacket of copper, and a jacket of platinum as a substitute for all platinum.

TESTS between ordinary carbon-steel and tungsten-steel tools in a lathe showed that the former failed at a cutting speed of 15 ft. per minute, while the latter withstood 90 ft., its edge becoming dull red in diffused daylight. High-speed tool steel contains 5 to 17% tungsten, 0.15 to 0.35% manganese, 1 to 3.5% chromium, and 0.4 to 0.85% carbon.

If the front wheels of a steam-shovel are off of the track, fill the dipper with rock or other heavy material, loosen up one jack-arm and swing the dipper over this side. This will raise the other side of the shovel. Put a number of men on the up-side jack, and tighten it down as hard as possible. Swing dipper over high side, and screw down loose-side jack. Continue this operation until the shovel is off the centre-bearing. If there is a

key in the king-bolt, the trucks will be raised off the track. If the rear trucks are derailed, lay blocks in usual manner in order to assist the wheels to climb on the rails. If this is unsuccessful, drop the dipper and boost by means of the thrusting-engines.

REMOVAL of broken ore from stopes on veins, such as at the Rand, having dips from 25 to 33°, is considered very inefficient by M. Weinbren. This is especially so when kafir labor is employed shoveling the ore, regulation and supervision being difficult. If excessive shoveling can be eliminated, the efficiency will be greater. To this end a new system was devised. A permanent line of chutes was laid down at a safe distance from the stope faces. The chutes were well anchored. A water tap was fitted at the top of each chute-line. Tracks of 12-in. gauge were laid down every 50 ft. along the dip of the stopes, and running from the faces to the chutes. A special ore-car was designed, having a capacity of five cubic feet. It was 18 in. above the rails, and cost \$12. The number of shovelers was reduced by 50%. Several advantages are claimed for this system, including the aid of gravity and better supervision.

ALLOYS possess properties not combined in any single metal. Practical substitutes for gold, platinum, and other precious metals are not yet satisfactory in the form of alloys, yet it is hoped to find something, according to F. A. Fahrenwald, in Bulletin 109 of the A. I. M. E. Experiments proved that: (1) Metals or alloys of metals outside of the precious-metal groups, are unsuitable as substitutes for platinum. The gold and silver alloys of palladium have been found to be excellent substitutes for platinum in its softer forms, and while not so chemically resistant, fill all requirements where conditions are not too rigid. (2) Except in two respects, pure ductile tungsten, and, to a lesser degree, molybdenum, meet all of the specifications of a practical substitute for platinum and its alloys. These two defects are its ease of oxidation, and the difficulty with which it can be soldered; and they have been overcome by coating with a precious metal or alloy, the resultant material being in many ways far superior to platinum or its alloys. This material has met with instant demand, is in many cases replacing the best platinum-iridium alloys, and permits the performance of work which has been impossible with the materials hitherto available. And (3) wrought tungsten and molybdenum were produced on a laboratory scale, but no success attended the attempted production of alloys of tungsten with gold and palladium; while, on the other hand, the alloys of the tungsten-molybdenum series were produced in wrought form. These operations were governed entirely by metallographic control, and their success suggests the possible application of a similar method in a treatment of such metals as iridium, tantalum, rhodium, osmium, etc., in combination with each other, or with tungsten or molybdenum, which may result in the production of alloys possessing properties far superior to those of any material now available.

REVIEW OF MINING

As seen at the world's great mining centres by our own correspondents.

CRIPPLE CREEK, COLORADO

DRAINAGE-TUNNEL.—ORE TRANSPORT.—A 'Dry' TOWN.—EL PASO.—PORTLAND.—LITIGATION.

The report of T. R. Countryman shows that the Roosevelt drainage-tunnel was advanced 290 ft. during December. The character of the rock traversed has not changed of late, accordingly there has been no increase in the flow of water from the portal. Toward the end of January it is expected that the main Elkton vein will be intersected. This should result in a large increase of water.

Petition has been made to the Public Utilities Commission to order the Short Line railroad to accept shipments of ore over

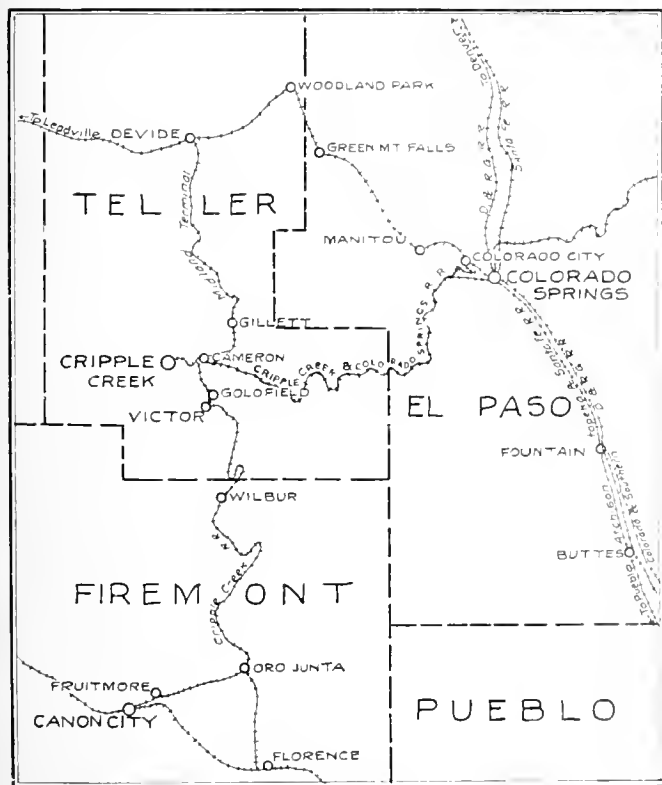

SITUATION OF CRIPPLE CREEK IN RELATION TO COLORADO SPRINGS, COLORADO CITY, AND CANON CITY.

the Midland line. The Colorado Midland & Midland Terminal tracks are leased by the Short Line. The Midland has a direct route from the district to the mills at Colorado Springs. By the Short Line extra switching of cars is necessary at the Springs, thus causing extra expense to the shipper.

The new schedule for treatment and freight on Cripple Creek district ores has been announced by the Golden Cycle company at Colorado City as follows: under and including \$10 per ton, the charge is \$4; over \$10 and including \$15 per ton, \$5.25; over \$15 and including \$20, \$6; over \$20 and including \$25, \$6.50; over \$25 and including \$30, \$7; over \$30 and including \$40, \$7.50; over \$40 and including \$60, \$8.50; over \$60 and including \$100, \$8.75; over \$100 and including \$150, \$9.75; over \$150 and including \$200, \$10.75; over \$200 and including \$300, \$12.75;

and on all grades above \$300, \$12.75 per ton plus 1% of the value in excess of \$300. It is expected that the Portland company will make a similar announcement. Both milling companies are busy engaging ore supplies and signing up contracts, and the belief is expressed in some circles that the lowering of rates and the efforts to secure contracts are due to anxiety concerning the success of the numerous flotation investigations being conducted by large mining companies.

The first day of 1916 the Cripple Creek district had no open saloons for the sale of intoxicating drinks. Owing to the prohibition laws in effect, more than 30 saloons were forced to go out of business. It is to be hoped that they will be closed for many years to come.

At the recent meeting of the directors of the Portland Gold Mining Co. the regular quarterly dividend of 3c. per share was declared, amounting to \$90,000, and payable January 20. The total, including this one, is \$10,267,080. The annual shareholders' meeting of the company has been called for February 21.

The December production from the El Paso mines is reported as being 2200 tons, worth \$50,000.

The threatened apex suit between the El Paso company and the Katinka company has been settled out of court. The ore from the ground in dispute will be mined by lessees as formerly. All royalties paid on such ore will be equally divided between the two companies.

The building that was formerly the main office of Stratton's Independence has been moved to a point south of the railroad to make room for the new sampler which the Portland company will erect as soon as possible. Grading for foundations is already in progress. Through this sampler will pass all ores going to the Independence mill of the Portland company.

At its generating-plant at Canon City, which has a capacity of 5500 hp., the Arkansas Valley Railway, Light & Power Co. is to add 10,000 hp. The transmission-lines to Cripple Creek will be improved.

It has been published in Colorado Springs that the Vindicator company is to erect a 1000-ton flotation plant to treat dump ore at Cripple Creek.

ATOLIA, CALIFORNIA

RUSH TO NEW TUNGSTEN AREA.—FLOAT TUNGSTEN.—HIGH-GRADING.

Work in this important tungsten district is increasing each week. Rich 'float' ore continues to be found in numerous places adjacent to Atolia, and it seems as if the producing area would eventually cover 150 square miles of San Bernardino and Kern counties. During the two weeks following the holidays tungsten deposits were discovered about three miles west from the Rand mountains, toward Kane Springs. A regular stampede took place to the new area last week, horses, autos, and even trucks being commandeered to make the trip. The weather was fierce, and all through the night of a blinding blizzard the stampede worked amid snow and slush to get a location somewhere near the latest tungsten discovery. Since the excitement, reports seem to verify the occurrence of a good vein of high-grade scheelite, which runs east and west, similarly to the deposits in the Atolia district. The lode seems to lie across the valley toward Jawbone canyon, the outcrop

Leak will be three miles of the Southern Pacific line to Owens river.

A number of new lasses are working adjacent to the Churchill workings, west of Atoia, while the usual production of placer scheelite from the Stringer district is shipped every week to the East. At Powell's Rand Mountain scheelite claims are being operated again by two Alaskan miners named DeBerry, who are now transporting their ore by packtrain to the Johannesburg mills for reduction and concentration.

On the 'potato patch' near Atoia about 50 miners are working for the Atoia company, while individual claims adjacent to the company's are being operated for placers by their owners, or lessees, who all seem to be doing unusually well. Instances are mentioned where some are making over \$100 per day in digging scheelite float.

While moving a drilling outfit from Hawes to Atoia, some float was found near Fremont peak that contained fully 60% tungsten. At the west end of the tungsten-producing belt, in the production of scheelite ore Mayhood and Fellman approximate about four tons per week. This comes from Kelsey creek, and is situated on the homestead of J. H. Robinson, who also has turned his attention to tungsten mining instead of farming.

There are several buyers of high-grade tungsten here who are paying cash for the ore, and prices are still from \$1 to \$1 per pound for the proper quality. 'High-graders' are keeping up their usual activity, and the appointment of a constable and justice of the peace has been found necessary to keep the community properly protected from the marauders who are indiscriminately operating throughout the district. One individual was caught on January 11 with a sack of high-grade on his shoulder and his pockets loaded as he emerged from the shaft of Churchill No. 1.

LEWISTON, MONTANA

ACTIVITY AT MAIDEN.—GYPSUM.—COAL.—GOLD.—OIL.

Development and mining is active around the old district of Maiden in the Judith mountains.—The Cumberland, which contains zinc ore, is being operated under lease, after being closed for several years.—The new Spotted Horse mill erected by E. B. Coolidge is working successfully after minor changes were made; a good supply of ore continues to be developed in this famous old producer.—The Mount Grassy claims have been thoroughly sampled, and a mill is promised if sufficient profitable ore is found. Some high-grade ore has been found, but most of the assays are said to be from \$6 to \$10 per ton.

The H. Meyer Gypsum Co. has recently been incorporated. It owns 200 acres of land eight miles west of Lewistown, and within 600 ft. of both the Great Northern and the C. M. and S. P. railroads. It is proposed to build a gypsum mill next summer. The property is estimated to contain 2,000,000 tons of gypsum, and the company contemplates marketing 50,000 tons yearly. There is only one gypsum mill in Montana at present, and much gypsum for stucco and plaster is imported, so there should be a good market. O. U. Miricle and Dan R. Brown are at the head of the company.

The Cottonwood Coal Co. at Lehigh is now producing about 800 tons of coal daily. Over 200 men are employed. When present development has been completed the company will be capable of producing 3000 tons a day.

The Ruby Gulch Gold Mining Co. of Zortman, Blaine county, in the Little Rocky mountains, has purchased the steam power-plant of the old Gabo coal mine on Spring creek in South Lewistown. The plant is now being installed at the company's coal mines on the Missouri river, and will increase the capacity of the power-plant there to 1000 hp. The power is transmitted 30 miles to the 600-ton cyanide-plant of the Ruby Gulch company in the Little Rockies, which is producing gold at a rate of about \$25,000 per month from low-grade ores.

Drilling for oil will soon be started in Musselshell county 10 miles south of Lewistown. Oil and gas are reported to have been found in shallow wells near Grass range east of Lewistown, and near Denton north of here, at a depth of 500 ft.

SONORA, CALIFORNIA

NEW WORK IN THIS TUOLUMNE COUNTY DISTRICT.

The new five-stamp mill at the Hope mine, near Sonora, which was under temporary cover, is now housed in a substantial building. Other buildings have also been erected on the property, and a powerful gasoline engine and an air compressor installed. The Hope vein is what is commonly designated a 'pocket-milling lead,' and recently over \$25,000 was taken out in a few days' work.

The opening of large orebodies in the Experimental mine, above Columbia, during recent months has been followed by the erection of a five-stamp mill. It is understood that the new mill will be started when rain has replenished the depleted water supply. The adit in which the orebodies were developed is in 2800 ft., and will have to be driven 200 ft. more to reach the shoot that made the mine famous years ago. The last two months' work with the old two-stamp mill returned approximately \$1500 in gold.

Operations will shortly be resumed at the Atlas mine, near Tuttle town, which recently was bonded to a new company. Preparations for the resumption of mining activities have begun.

At the property of the Mammoth Mining Co., at Jacksonville, between 30 and 40 men are employed, and the mill is running steadily. Important surface improvements have lately been made.

Approximately 100 tons of ore from the Louisiana mine, near Tuolumne, is about to be treated at the Columbus, an adjacent property. The Louisiana, idle for many years, is being operated under lease by Richard McGhee, William Heath, and A. Layman. Good returns are expected from the ore to be milled.

The erection of new buildings and a head-frame, the installation of a hoist and other machinery, and the repairing of the collar of the shaft are among the most important things that have kept a crew of 15 or 20 men busy at the Rawhide mine the past two months. A large rotary pump and an electric motor were received last week, and it is understood that the unwatering of the mine will begin soon.

The South American Development Co., of which J. W. Meerer is general manager, has re-opened the Poison Oak mine, near Tuolumne, and development work has begun under the direction of W. H. Kuowles. At present the men are driving a cross-cut from the bottom of the 300-ft. shaft. Former operators erected a five-stamp mill and crushed considerable good ore, but in the meantime development revealed no new orebodies and the mine was closed several years ago.

TORONTO, ONTARIO

PORCUPINE AND KIRKLAND LAKE NEWS.—TELLURICUM AND PLATINUM.

The leading Porcupine mines continue to increase their gold yields. During December the Dome produced \$160,950 from 39,120 tons of ore, an average yield of \$5.39 per ton.—The Hollinger return for the four weeks ended December 2 showed a large advance over any previous output, the gross profit was \$210,559, from 29,448 tons, averaging \$10.99 per ton. Working costs were \$2.34 per ton. The mill also treated 11,214 tons of ore from the Acme. The surplus on hand is \$1,525,130.—The West Dome Consolidated, which has taken over the West Dome, will shortly begin development. Instead of deepening the old shaft, which is down 120 ft., a new shaft will be sunk

nearer the Dome, with a view to cutting an extension of some of its side veins.—The claims of the Porcupine Mines Syndicate, adjoining the Foley-O'Brien, are being developed by trenching and stripping the principal vein, which is thought to be an extension of the Foley-O'Brien vein. R. Hamilton, who was formerly engaged in mining in Chihuahua, Mexico, is in charge.—Diamond-drilling is being started on the Dome Consolidated, a property of 120 acres situated north-east of the Dome.

At the Croesus, formerly the Leyson-Dobie in Munro township, the main dome has been cut at 200 ft., where the high gold content of the ore on the upper levels is well maintained.

At the Tough-Oakes mine, Kirkland Lake, a telluride not previously known to occur in Canada, kalgoorlite has been found on the 400-ft. level. It contains more silver than gold, with some mercury. With it is associated calaverite more abundant and noticeable than the kalgoorlite.—The Lake Shore, in the Goodfish Lake area of the Kirkland Lake district, which has been extracting good ore at the 200-ft. level, has sunk to the 300-ft. level, where a station has been cut.

During assessment work at the Quinn claims, in Munro township, one mile east of the Croesus mine, owned by George Quinn, Archibald Burton, and P. S. Haviston, platinum was discovered in commercial quantities. About three months ago the men employed discovered a mineral which was not recognized by them, and the importance of it was not realized until recently, when one of the owners had some samples assayed. The ore, of which the principal constituent was iron, was found to be rich in platinum. Five assays were made of ore taken at different places, the platinum content being stated to run between \$180 and \$1800 per ton. Traces of platinum have previously been found in the locality, but this is the first occasion in which it has been discovered in paying quantities. The country, which has been all staked out as gold locations, will be closely prospected in the hope of finding further platinum deposits.

WASHINGTON, D. C.

FURTHER NOTES ON THE MINING LAW REVISION BILL.—LEASING.

The Senate has passed the bill of Senator Smoot of Utah creating a commission to codify the mining laws of the United States, and the bill has gone to the House of Representatives. There was no opposition whatever to the bill in the Senate, where it was passed in less than five minutes when called up by Senator Walsh of Montana, chairman of the Senate's committee on mines.

This was quick action, as was promised. The bill calls for the appointment of a commission of three members, two of them shall be lawyers of large experience in mining law, and a mining engineer who has had practical experience in mine operations. Alaska is included in the scope of the commission's work. Hearings are authorized to be held in the principal mining centres, and the work must be done in a year after the appointment of the commission by the President. \$500 per month is allowed to each member of the commission, and \$25,000 for other expenses.

Great opposition has arisen to the bill in the House, as previously indicated. The House committee on mining is still giving hearings, and among others lately heard have been J. Parke Channing, Henry B. Winchell, and W. R. Ingalls, and Senator Smoot and Congressmen Howell of Utah and Evans of Montana. Delegate Wickersham of Alaska has been heard, and he offered much opposition to any revision of the mining laws of Alaska, indeed of the whole branch of mining-law. He was personal as well as caustic in his remarks.

In the House committee on mining it is now said that leanings are against the recommendation and passage of any codification commission at all, and that a plan is gaining favor whereby the revision will be done in Congress by members of Congress, and that even the House committee on

mines and mining may begin this work at once and send it up to the Senate when completed for action. The growth of this sentiment is quite unexpected and has been combated, the claim in answer being that the work of codification cannot be done adequately except by experts with plenty of time at their disposal and who shall be able to go about the country and come into touch with the views of practical mining men, who will be accessible only near their places of operation and who cannot come to Washington in any large numbers.

The leasing bills, so called, still occupy Congress. The House has passed the bill permitting the leasing of water-power sites on Government land still owned. A vigorous report has been filed on behalf of the minority on the committee on public lands, written by Congressman Taylor of Colorado.

MAGALIA, CALIFORNIA

NOTES ON AN OLD DRIFT-MINING DISTRICT.

Drift-mining operations in this district have been more active than usual this winter, as a number of new operators have taken the field. The drift mines in Butte county have proved to be rich in the past, and should respond to further development. The question arises, why have these mines been dormant during the past few years? There are several answers; the

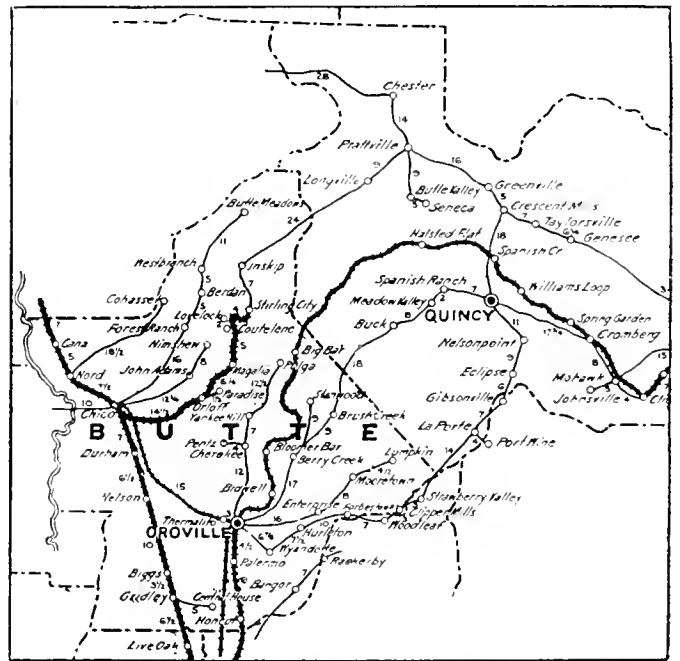

BUTTE COUNTY, CALIFORNIA, SHOWING POSITION OF MAGALIA.

two most important are adverse mining legislation, and the taking of nearly all available water by power companies. Water is very important in this class of mining, but the days are gone when the miner may take what water he wants to wash the gravel. Under favorable conditions drift mining may flourish. It is now a question of storing all the water and washing intermittently, except in some cases where the main workings of the mine may be near plenty of it.

The Oro Fino has come again to the production stage lately, under the experienced management of W. F. Anderson. Eight men are working. The property is near DeSabra.

George C. Allen and associates are opening the old Williams claim near Appleton. Three men are working, and an incline is being sunk on the contact to reach the gravel.

Henderson brothers have driven their adit into gravel near Magalia, and have four men working.

J. F. Littlefield has six men driving an adit from Little

Butte creek to a tributary channel of the Mammoth. An incline was driven for some distance, but had to be abandoned on account of swelling ground, an uncommon occurrence in this district. This property is well equipped, and may yet be heard of as a producer.

The Lucky John mine, nearby, is being opened by P. J. Dunne and others. This is a promising property, as a considerable amount of gold has been extracted from adjoining claims. The Mineral Slide, now idle, has produced over \$1,000,000 since it was first opened. It still has possibilities, but will take a considerable sum of money to put in shape for resumption of work. It is not likely to remain idle long.

The Kirby mine, near DeSaba, is to resume shortly, as soon as a settlement has been made with Mushrush & Co. This mine is opened by a shaft to the gravel and is near the famous Indian Springs mine which has produced over \$2,000,000.

J. Allen Veatch is employing 8 to 10 men on the Royal Drift and Robinson Drift mines on Big Butte ridge. This is a strong company, and development on a good scale is planned.

It is likely that other drift mines will be reopened in the spring. It is time that these deposits received more attention, especially when one considers that since the early days they have yielded approximately \$200,000,000, or an average of \$1,000,000 per mile of channel worked. According to maps of the Geological Survey, there is an enormous length of ancient river-channels remaining in this State.

DEADWOOD, SOUTH DAKOTA

WOLFRAM PRODUCTION.—PROSPECTS OF THE OTER.—SUNDRY NOTES.

With a production of \$147,000 of hand-sorted wolframite ore shipped to market in the past six months, and the accumulation of a low-grade dump estimated to contain \$100,000, net, the Wasp No. 2 company, in the Flatiron district, occupies an enviable position both as a producer of first magnitude of this class of ore, and as a profitable concern as well. The last car of the ore, shipped in December, consisted of 26.25 tons of 40% product, sold to the Crucible Steel Co. for \$17.50 per unit, the carload realizing \$54,000. Production of this high-grade ore continues, meanwhile the new plant is at work concentrating the low-grade dump. The concentrating equipment, installed at a cost of \$5000, includes a Davis roll, 5 by 4-ft. ball-mill, Richards jig, horizontal jig, classifier, elevator, Wilfley table, etc. It has a capacity of about 25 tons daily, and is expected to make a product containing 60% tungstic acid. During 1915 the company paid dividends of 16½c per share, making the total distribution \$82,500, and from present indications 1916 should be even more profitable.

With a production of over 50 tons daily, and the certainty that this quantity will be considerably increased within the next few weeks, the Ofer Gold Mining Co. has taken an enviable position among Black Hills producers. It is the old story of a mine supposedly worked out, showing, under development in adjoining ground, orebodies not known to exist. Most of the output, from 40 to 50 tons per day, is being extracted by the Mogul company, which has the Ofer's Burlington and Apex group under lease. This ore is of good milling grade, and there is a considerable quantity of it. It is a continuation of a shoot which the Mogul discovered in the North Lode—its own property—and from which a large tonnage was taken last year. The Mogul worked this shoot up to its boundary lines on both the north-west and south-east of the North Lode. On the south-east the shoot extends into the Burlington and Apex group, and on the opposite side, into the Monday-Reindeer group, both belonging to the Ofer company. And, as has been stated, the Mogul secured a lease on the Burlington and Apex, and is negotiating for an agreement whereby the ores of the Monday-Reindeer group may also be secured. While terms have not been definitely agreed upon, it is practically assured that the Mogul will treat the latter ores, either

by lease or working agreement. This will bring the Ofer's output up to probably 100 tons daily from this one ore-shoot, and should it prove as extensive and valuable in Ofer territory as it was in Mogul ground, will net the company a splendid profit. Schilpfin and Moore have been granted a lease on the Ofer's Lackawanna fraction, and production will immediately commence from that ground, as ore is known to exist in paying quantities. On the American Express group, also Ofer territory, on Blacktail and Sheeptail gulches, lessees Phillips and Carretto are taking a narrow-gauge carload 15 tons—daily from the old dumps. This ore is being treated at the New Reliance mill, and good profits earned. Underground conditions are favorable at this property for a large future production, as there appears to be a large quantity of \$5 to \$8 ore developed, ore which would not pay to work at the time the property was operated, some 15 years ago. Plans are also maturing for unwatering the Imperial shaft, in Blacktail gulch, where considerable \$6 ore was found some years ago—likewise at a time when that grade would not pay to work. The Ofer company has plans for a comprehensive development of its estate, and the present production and earnings indicate that it will have sufficient funds to proceed along broad lines of development and firmly establish another big mining enterprise in the Bald Mountain district.

Sinking is again under way at the Hidden Treasure shaft, in Deadwood gulch. The work will be carried to the 400-ft. level, 200 ft. below the present bottom.—Operations are being conducted steadily at the Rattlesnake Jack mine, near Galena, where, since the installation of Wilfley tables, a better saving is being made. Concentrates assaying \$160 to \$200 per ton are being saved. Cyanidation is also yielding good returns.—A 10 by 12-ft. Portland filter is being installed in the Mogul mill at Terry, supplementing the continuous-decantation process. The machine will be particularly valuable in the saving of cyanide, although some dissolved gold will probably be recovered that now goes to the dump.—Lateral work continues on the 600-ft. level of the North Homestake, and the 200-ft. level of the Echo, both at Maitland.

AUSTIN, TEXAS

SULPHUR, IRON ORE, ZINC IMPORTS, QUICKSILVER.

The Freeport Sulphur Co. of Freeport, is preparing to build a loading-dock on the west side of the Brazos river near its sulphur mines. The dock will be 300 ft. long, and equipped with modern loading machinery. The company is arranging to increase its sulphur output considerably. A new boiler-plant is being erected to increase the output from 10,000 to about 22,000 hp. It is estimated that this additional power will enable doubling the sulphur output of the wells.

A. G. Elliott, Jr., and associates of Dallas are perfecting plans for the extensive development of their iron-ore deposits in east Texas. They control beds in Cass and Marion counties that are estimated to contain a minimum of 100,000,000 tons.

The Bailey Mining Co. has been organized with offices at Burnet and Lometa. It has a capital of \$40,000.

The British steamer, *Chalister*, arrived at Galveston on December 18 from Australia with a cargo of 7500 tons of zinc concentrate for the smelters at Bartlesville, Oklahoma. It is the fifth vessel to bring this product during the past six months. It is stated that two other steamers, the *Toromeo* and the *Conargo*, are now on the way to Galveston with similar material.

It is interesting to note that the Terlingua quicksilver district continues to expand. Two old mines are to be unwatered. The territory adjacent to Terlingua across the Rio Grande in Mexico is again attracting attention.

The tungsten mine of T. Owens and E. Kiam, 30 miles north of Van Horn, promises to be extensive.

Machinery has been installed at the molybdenum mine of E. Kiam and W. J. Badu near Llano.

THE MINING SUMMARY

The news of the week as told by our special correspondents and compiled from the local press.

ALASKA

JUNEAU

The Alaska Gold Mines Co. is to issue monthly statements; that for December is now available. The mill treated 114,183 tons of \$1.36 ore.

Two men were killed above the 1450-ft. level of the Alaska Treadwell mine on January 4. They were bulldozing large boulders. A quantity of giant powder exploded near-by.

ARIZONA

Bulletin No. 10 of the State Bureau of Mines is entitled 'Gold Placers of Arizona,' by Frank G. McClure. A table gives the gold output from these deposits from 1903 to 1912, inclusive. Yavapai county has one of the large areas, in the south-central part, 60 miles north of Phoenix, along the Hassayampa river. One problem is that of water supply. Pima county has three important districts, while those in Yuma are of value.

MOHAVE COUNTY

It is considered probable at Oatman that the Tom Reed-United Eastern merger will not be consummated. Negotia-

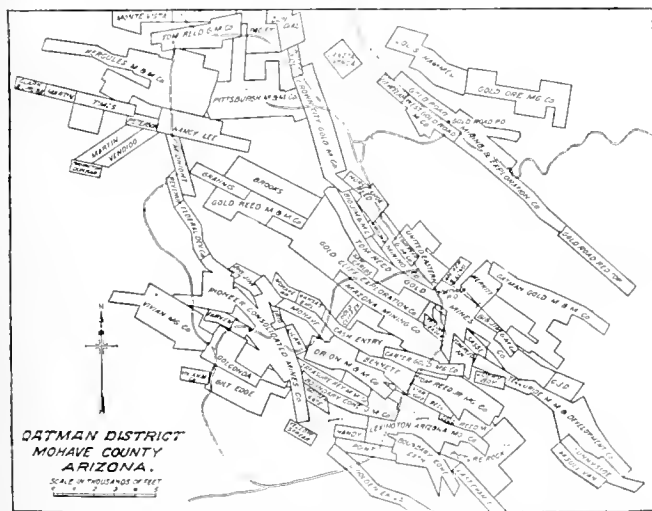

tions continue. Erection of machinery at the latter is making good headway.

Tonopah and Goldfield people have acquired an interest in the Times property, about four miles from Oatman, where some good ore was opened recently. Charles E. Knox and Ben S. Revett are mentioned as new shareholders.

About 100 men are working at the Tennessee mine, 28 miles north of Kingman. The daily output of zinc-lead ore is 150 tons, concentrated at Needles, and the product smelted at Bartlesville, Oklahoma, and Midvale, Utah. A wide vein is being developed at 400, 800, and 1170 ft. The main shaft is being sunk from 1200 to 1400 ft. Work at the Schuykill, Payroll, and Minnesota, near the Tennessee, is giving encouraging results.

The Pittsburg mine has been sold to Eastern people for \$300,000. This is one of the most important transactions in the Oatman district.

A fine body of tungsten ore has been opened at 40 ft. depth

in the property of J. C. Wichmann, 12 miles east of Yucca. A mill is soon to be in operation.

The Arizona Venture Corporation shipped last week, through its agent at Kingman, W. D. Grannis, 256 crystals of lenzenite. These are used in wireless telegraphy.

YAVAPAI COUNTY

It is reported that at 1400 ft. in the United Verde Extension at Jerome the cross-cut has passed through two 6-ft. veins of 20% ore, and one 8-ft. of 23% copper. The new machinery and tramway from the mine to the United Verde smelter at Clarkdale are ready for work.

ARKANSAS

According to Reuben Willett of Yellville, who buys most of the zinc ore from the North Arkansas field, and supplies the U. S. Geological Survey with production figures, he estimates that the output in 1915 was 15,429,910 lb., worth \$1,000,000, an increase of 400%. This yield was from 87 mines. Carbonate and silicate ores amounted to 14,064,315 lb., of which 6,841,325 lb. was shipped without milling. Many mills are in course of erection. The output in 1916 should be 30,000,000 lb. The counties are Boone, Baxter, Marion, Newton, and Searcy.

Grading has been started on the new railroad between Yellville and Rush. The line will be ready in July, and should be of great benefit to the mining industry of north Arkansas.

CALIFORNIA

Considerable snow has fallen in all the mountain counties, which, while it will be of great value later on in the year, has considerably interfered with mining operations.

AMADOR COUNTY

The following is the preliminary report of the Plymouth Consolidated for December:

| | |
|------------------------------|----------|
| Ore milled, tons | 11,650 |
| Value of gold | \$58,490 |
| Working expense | 26,324 |
| Development charge | 5,215 |
| Surplus | 26,951 |
| Other capital expended | 206 |

During the six months ended December 31, 1915, the Keystone company at Amador City produced \$86,167 from 38,663 tons of ore, equal to \$2.23 per ton. The 40-stamp mill only lost about 5½ days during the period. Most of the ore came from a depth of 900, 1000, and 1200 ft. Work at 1400 ft. is highly encouraging. The balance on hand is \$6465. Carlton R. Downs is manager.

A mill may be erected at the Treasure mine in the spring. The property is between the Bunker Hill and Fremont mines.

CALAVERAS COUNTY

(Special Correspondence.)—The Pioneer Chief Gold Mining Co., with offices in San Francisco, and whose property is situated about two miles south of San Andreas, on the foot-wall belt of the Mother Lode, has installed electrical equipment consisting of hoist and air-compressor of sufficient capacity to meet requirements for some time to come, and to operate to a depth of 1000 ft. A full two-compartment shaft is being sunk, and is down 320 ft., showing a five-foot shoot of high-grade milling ore. Sinking is under way on three shifts, using ma-

chine drills, 100 ft. with 60 ft. 300 and 300 ft. The 220-ft. level has been extended 175 ft. south and 160 ft. north. The ore now being developed assays from \$5 to \$10 per ton, although some parts of the shoot yield up to \$30 and \$50. The assay office is being erected, and preliminary plans are being drawn for a mill, the first unit to be 100-ton capacity. The company has built its own power line connecting the mine with the main transmission line, receiving electricity from the Electric Department of the Pacific Gas & Electric Co. J. F. King is local superintendent.

San Francisco, January 17.

TRAVO COUNTY

(Special Correspondence).—A heavy snowstorm at the beginning of the year caused a break in the pipe line, leaving Skidoo to subsist on tumbled snow for five days.

Many prospecting outfits have passed through here lately. Sulphate and possible schreibite deposits along the western side of Death valley are the attraction.

Skidoo, January 9.

NEVADA COUNTY

A 475-gal. per minute pump, driven by a 10-hp. motor, has been added to those already lifting 1100 gal. at the Golden Center mine. Water from Wolfe creek seeps into the workings.

At the eighth annual meeting of the Le Duc Mining Co. it was decided to continue development in charge of B. A. Penhall. Over 3100 ft. of adits has been driven, but no commercial orebody has been developed.

The recent storms considerably upset work around Grass Valley, mainly through a shortage of water.

PLACER COUNTY

Owing to a legal tangle over title to three areas of ground at Forest Hill, the Grey Eagle company has suspended operations, probably for several months.

PLUMAS COUNTY

Developments in the Walker copper mine continue very satisfactory, a wide body of good ore being recently opened. Diamond-drilling is to be started soon.

Nevada and California people constituting the Lucky Strike company, headed by H. O. Howard of Lovelock, have acquired the King Solomon claims. Men will start work in March.

SHASTA COUNTY

To obviate litigation concerning the Peterson-Lutman property on Clear creek, the partly completed dredge of Lawrence Gardella was moved 200 yards in 40 minutes by 11 men on January 14. A temporary canal was cut for the boat.

Ground left by the Shasta Dredging Co. at Horsetown is being sluiced by J. G. Andree and C. O. Silversten. Dynamite is used to loosen the gravel. Two clean-ups were satisfactory.

SIERRA COUNTY

At the North Fork mine, at Forest, the shaft is being sunk to 200 ft. depth. Some rich arsenical pyrite was extracted at 185 ft. G. L. Stone is in charge.

At Alleghany the Kendricks Consolidated is to operate some claims in charge of C. O. Jackson.

TUOLUMNE COUNTY

The Buchanan gravel channel has been cut by the 200-ft. adit driven by the Springfield Tunnel & Development company.

COLORADO

CLEAR CREEK COUNTY

(Special Correspondence).—The Argo mill, which has the largest cyanide plant in this county, is being provided with flotation equipment. It will consist of six cells, making it possible to treat 200 tons of ore daily. Only tailings from the mills will be treated, but it is hoped to increase the recovery considerably, no effort having been previously made to extract

the silver and lead contents of the ores. J. A. Pearce is in charge of the mill.

The Oneida mill at Creeland is being operated full time, treating an average of 50 tons daily. This plant has a flotation plant. It is officially announced that the cost of oil is 3c. per ton.

Work will be started in a few days on the Lord Byron property, near Lower Fall river. The Stanley adit will be extended 500 ft. to intersect the Lord Byron vein at increased depth. D. J. McDonald is manager.

The discovery recently made in the Albro mine on Albro mountain is developing into a bonanza. The vein is two feet wide, and from a shipment of 30 tons made last week the lessees, Dungle, Swanson, and Shaffer, received a check for \$2200. It is stated that the output will be at the rate of one carload per week.

Mosher and associates, leasing at the East Lake, have opened another orebody that is three feet wide, and the initial shipment returned a settlement of 3.25 oz. gold per ton.

The Argo O. R. & P. Co. purchased in 1915 a total of \$125,000 in gold and \$19,000 in silver, while the Chamberlain Ore Co. paid out \$350,000. Shipments made to the Salida smelter brought the production for the Idaho Springs district to \$718,000.

Idaho Springs, January 9.

LAKE COUNTY (LEAVILLE)

The pumps at the Penrose shaft are now below 710 ft., lifting the water with ease. There is about 135 ft. more to unwater. Some old workings are being cleaned out.

Extensive development is promised for the Iowa Gulch area; some of which is to be examined in the spring. Lessees in the upper workings of the Lilian are shipping gold-bearing oxide and carbonate of zinc.

SUMMIT COUNTY

Two of the Tonopah Placers Co.'s dredges were stopped for the season on December 31; the third will continue through the winter as usual. The French company's boat is closed also.

Both the mills of the Wellington Mines Co. are working full time.

Lessees at the Dunkin, near Breckenridge, recently sent another lot of ore direct to the Mint at Denver. This was worth \$12,000, making \$40,000 from the pocket.

TELLER COUNTY (CRIPPLE CREEK)

Extraordinary rich ore is reported as having been found in the Vindicator, even better than that extracted from the Cresson. About 70 tons of 25-oz. ore was shipped from the Cresson mine last week to the Golden Cycle mill at Colorado City.

Lessees at the United Gold Mines Co.'s Bull Hill claims produced 800 tons of ore in December.

IDAHO

SHOSHONE COUNTY (COEUR D'ALENE)

The Highland-Surprise Consolidated company, operating in the Pine Creek district, has overhauled and added to its plant, and since November 16 has treated 2500 tons of ore, producing concentrates assaying 55% zinc and 35% lead. More machinery will give 80% and 85% recovery of the zinc and lead respectively. Ore worth \$105,000 has been shipped from No. 1 stope in the Surprise mine. No. 2 stope produces the present mill feed, and it is different from the other, requiring finer grinding and flotation. Development generally is very satisfactory. Bad roads, nine miles to the railway, hinder work, and a railroad is wanted.

On January 23 the Success company will pay 3c. per share, equal to \$45,000. Net earnings in December were \$90,000.

On the 100-ft. level of the East Caledonia 30 in. of 17% lead ore has been opened. The main workings begin on the level of the principal street of Wardner.

MICHIGAN

THE COPPER COUNTRY

(Special Correspondence.)—The Calumet & Hecla smelter at Hubbell is producing 440,000 lb. of copper daily. The metal goes East by rail. Work on furnace No. 23 is making good progress. The plant at Dollar Bay treats most of the 'mineral' from the company's subsidiaries.

Mass copper of considerable quantity is being opened in the north section of the Ahmeek mine.

The increased assessed valuation of the Copper Range Consolidated properties for taxation is the subject of protest from the owners, the manager of the Baltic, F. W. Denton, paying taxes in Adams township under protest.

Discussion has arisen over the greater speculation in copper stocks in New York than in Boston. Several Lake Superior companies are to be listed on the New York exchange. Boston capital is entirely responsible for the development of the Michigan copper deposits.

Houghton, January 10.

According to James MacNaughton, general manager of the Calumet & Hecla, the past year was one of notable achievements for the Michigan copper mines. The properties were never so efficiently operated. Ore has been mined and milled for \$1 per ton in several instances. The C. & H. re-grinding plant is treating from 1200 to 1400 tons of tailing daily. The leaching plant will not be ready for six months. The outlook for the region this year is most encouraging.

MISSOURI

JASPER COUNTY

Cold weather last week considerably affected mining operations in the Joplin district. The street-car service was interrupted, preventing miners from getting to work. Water-pipes burst in many places.

The production of ore last year was as follows in tons:

| State. | Blende. | Calamine. | Lead. | Value. |
|----------------|---------|-----------|--------|-------------|
| Kansas | 28,089 | | 1,649 | \$2,105,912 |
| Missouri | 232,097 | 21,411 | 33,993 | 21,307,176 |
| Oklahoma | 27,955 | 84 | 9,675 | 2,625,556 |

The output in 1914 totaled \$11,922,837.

MONTANA

FERGUS COUNTY

A dividend of 7½c. per share, the first, has been declared by the Barnes-King Development Co. A monthly output of \$100,000 is expected before the end of 1916.

GRANITE COUNTY

A revival is reported from the Henderson district near Phillipsburg. The Henderson company has 40 men at work, and is shipping copper ore. The Coyote mine is a gold producer, with a 10-stamp mill. Other properties are considered promising.

LEWIS AND CLARK COUNTY

The Anaconda company's bond on the Porphyry Dyke mine, west of Rimini, has been extended for further development and mill tests.

SILVERBOW COUNTY

Work is to be resumed at the Butte & Zenith mine, according to word from Duluth, where the directors recently met. John D. Pope is to be consulting engineer, with W. D. Gibson as mine foreman. The Montana Power Co. is to supply electricity. A good flow of water must be pumped. The property is four miles west of Butte.

In the suit of Peter Geddes and others, minority shareholders in the Alice Gold & Silver Mining Co. v. the Anaconda Copper Co., an appeal has been taken to the Circuit Court of Appeals at San Francisco, to try and set aside the order for re-sale of

the property, held at Butte on November 10, 1915. The Anaconda company, which bought the Alice, a zinc mine, for over \$1,000,000, has a large number of men at work.

The east Coeur d'Alene region of this State, an area of 20 sq. miles, extending three miles into the eastern part of Idaho, has attracted considerable notice during the past year. Saltse is the centre. Two main railroads run through the area. There are two large mineralized zones, probably an extension of the lead and copper belts of the Idaho Coeur d'Alene. Some



THE COEUR D'ALENE REGION OF IDAHO AND MONTANA.

of the most promising mines are the Hemlock, Last Chance, Tarbox, United States, Bryan, Silver Cable, Richmond, St. Lawrence, and Monitor.

The Montana Silver-Lead Mining Co. has developed a large quantity of ore on Leigh creek, near Libby, and will erect a mill next summer. Joseph Williams is manager.

NEVADA

According to Frank M. Manson, general manager of the Utah Ore Sampling Co., Nevada is at present employing more miners and shipping more ore than at any time in the past few years, there are more prospective shippers being developed, and a more optimistic feeling prevails relative to the mining industry than in years.

According to a bulletin of the Mackay School of Mines at Reno, antimony in the form of stibnite, the sulphide, occurs widely distributed in Nevada. Stibnite is the principal ore of antimony, containing when pure 71.4% of the metal. It is a soft, lead-grey, metallic mineral having a high lustre, and usually occurring in aggregates of bladed crystals and in radiating groups, while more rarely it is found in massive or granular form. Near the surface, the Nevada antimony deposits contain cervantite, an oxide of antimony, which has been derived from stibnite by oxidation, and appears as a pale yellow earthy mineral. Other minerals containing antimony which occur in Nevada are pyrrargyrite, polybasite, and stephanite, which are of more value for their silver than for their antimony; jamesonite and its derivative binheimerite, which are not valuable as antimony ores because of their lead content; famatinite, a variety of which occurs in the rich gold ores of Goldfield, and is called goldfieldite, and tetrahedrite, also a copper-antimony sulphide frequently of value for its gold and silver output. None of these minerals are of value as ores of antimony.

The known occurrences of stibnite in Nevada are as fol-

lows. Churchill county, Barnes and Boyer districts, Elko county, Columbia and Good Hope, Eureka county, Stafford, Humboldt county, Antelope Springs, Bloody Canyon, Jackson Canyon, Juniper Mountain, Lovelock, Red Butte, Rosebud, Seven Troughs, Star Canyon, and Winnemucca, Lander county, Battle Mountain and Big Creek Canyon, Mineral county, Aurora, Nye county, Hot Creek district.

At Columbia, in Elko county, and in the Stafford district of Eureka county, the stibnite was mined for its silver content, while at the other localities named, it has been exploited for antimony. Before the outbreak of the War, all of the Nevada antimony deposits were shut down on account of the low price of the metal, which was only 8½¢ per pound. Since then the price has risen to 37¢, and a number of the properties are now working. Among these may be mentioned Antelope Springs, in Humboldt county, where the ore is said to be chiefly a high-grade oxide, but as yet a depth of only 30 or 40 ft. has been reached. In the Red Butte district, mining operations were begun last summer, and as in the preceding case, the ore was mainly high-grade oxide. Here, however, stibnite began to appear at a depth of a few feet. The Sutherland mine near Lovelock was worked last summer by the Magnolia Metals Co. of New York, which also operated the prospect near Red Butte. The deposits at Bernice are said to be working now, and there are doubtless a number of deposits in the State which are working at the present time. Anyone interested in an antimony deposit should attempt to get out as much ore as possible in as short time as possible, because it is practically certain that as soon as the War is over, the price of antimony will again drop back to the normal level of 8½¢. It is probable that many of the deposits mentioned in the above list, and not in operation at the present time, could be made to produce antimony at a profit with the present price of the metal, and it is to be hoped that their owners will take advantage of the opportunity.

EMERALDA COUNTY

During December the Jumbo Extension produced 2938 tons of ore worth \$110,000. Sampling, freight, and treatment cost \$28,000; smelter losses, \$12,500; and working costs, \$16,500, leaving \$53,000 net. The total output in 1915 was 22,508 tons for \$921,780, yielding \$402,827 net, of which \$323,750 was paid in dividends.

In the January issue of *Leschen's Hercules*, A. Leschen & Sons Rope Co. of St. Louis, describes the electrically operated Lidgewood cable-way of 1799ft. span for carrying old tailing from dumps to the Goldfield Consolidated mill. The capacity in 16 hours is 1000 tons.

The Reorganized Kewanas Mining Co.'s annual report has been issued, including the remarks of the general manager A. I. D'Arcy. The area of the two claims is 34 acres, adjoining the Laguna mine of the Goldfield Consolidated. The shaft and equipment of the Laguna are used for development of the Kewanas property at 700 ft. depth. Some encouraging results were obtained, although enough high-grade ore was not found to warrant shipments. There is a lot of unexplored territory in the property yet, and treatment of the gold-copper ore is soon to be possible.

The Reorganized Booth Mining Co. has also issued its annual report, including one from A. I. D'Arcy. The cash balance at December 1 was \$197,458. The company realized the sum of \$187,316 from the sale of 135,400 Jumbo Extension shares, and received \$19,275 in dividends on stock owned during the year. Development amounted to 2239 ft. The report discusses the extra-lateral aspect of the Booth vein and the Jumbo Extension property, which dispute was settled by the Jumbo Extension company giving \$15,000 cash and 300,000 shares, in return for that portion of the Booth vein lying within vertical planes drawn through the exterior boundaries of the Jumbo Extension. The vein was thoroughly prospected during the suit, but no commercial ore was found. The

mine was closed until August, 1915, to await further developments in the district. An apex dispute with the Goldfield Consolidated, Reorganized Kewanas, and Merger companies was also settled, on a share basis.

HUMBOLDT COUNTY

At 1500 ft. in the Seven Troughs Coalition 8 in. of \$1200 ore is being driven on. The mine is a veritable bonanza.

Recent developments at the Colligan lease of the Weaver No. 2 claim, prove the extension of the ore-zone of Rochester hill by several hundred feet.

NYE COUNTY

The Kansas City-Nevada Consolidated Mines Co., operating at Bruner, has issued a circular to the shareholders of the Phonolite Paymaster Mining Co., and the Phonolite Silent Friend Mining Co., whose properties, with others, were recently examined by C. M. Heron. A consolidation of all the claims was agreed upon, the above company being organized with a capital of 6,000,000 \$1 shares, which have been distributed as necessary. The president is E. C. Sooy of Kansas City, vice-president of the Lucky Tiger company, operating at El Tigre, Sonora, Mexico. H. W. Bruner is general manager.

Tonopah companies and lessees last week produced 8597 tons of ore worth \$180,006. All the properties continue their usual operations, on which there is nothing of special importance to chronicle. The Belmont company has examined the Bull Moose claims near Realty. Judge Averill made a decision in the Extension-West End suit, defining where the latter may work, and fining it \$10 and costs for inadvertant contempt.

UTAH

BEAVER COUNTY

(Special Correspondence.)—According to William Farish, who has examined the Newton district surrounding Fortuna, a general connected gold belt extends from a point west of Fortuna east past the Sheep Rock mine on to the Annie Laurie mine at Kimberly, a distance of at least 10 miles by air line. If such is the case, the gold-bearing area extends fully 10 miles east and west and 10 miles north and south, so far as is known. The general formation is made up of different kinds of porphyry. The veins are numerous, running north and south. They vary greatly in size. This series of veins is cut by east and west veins, which occur at frequent intervals, say 100 to 1000 ft. apart. In many instances there is a slight faulting of the north and south veins at the intersection. The east and west veins are generally smaller than the others. Several north and south veins are fault fissures. These in many instances fault the east and west veins from 100 to 200 ft. Both series of veins are gold bearing. There are said to be many veins from 100 to over 200 ft. in width that carry from \$3 to \$6 per ton their entire width. Generally Mr. Farish considers the district of much promise, and worth the attention of capital.

Fortuna, January 10.

JUAB COUNTY

Attention is being directed to the large mineralized area west of the Tintic district. Several properties are developing favorably.

Property owned by the Chief Consolidated company at the east and north ends of the district is to be developed as soon as possible.

On January 25 the Iron Blossom company will distribute 5c. per share, equal to \$50,000. The property is in splendid condition.

SUMMIT COUNTY

On January 16 W. R. Elliott became manager of the Three Kings company, with Joseph Kemp as superintendent. The main shaft is down 500 ft., where a drift has been driven 450 ft., lately in favorable ground.

To overcome the shortage of water the Daly West company

has ordered pumps to be installed at 1200 ft. in the mine. The water will supply the mill.

WASHINGTON

A review of mining conditions in Washington, Idaho, Oregon, and Montana during 1915 has been issued by F. A. Thomson, head of the mining department of the Washington State college at Pullman. Discussing the Tacoma smelter he says that the old lead and copper plant has been virtually re-constructed, and is rapidly becoming one of the most complete copper plants in the country. The lead furnaces were taken out several years ago, and this year has seen the completion of the most modern electrolytic copper refinery in the West, having a capacity of 6000 tons of copper a month, which with the old refinery gives a total of 8000 tons. A 130-ft. oil-fired reverberatory is under construction. This is to take care of the Britannia concentrate. A Cottrell fume plant is to be built early in the year. Alaska, British Columbia, and South America are the main sources from which the Tacoma smelter draws its ore supply.

CANADA

BRITISH COLUMBIA

A new contract has been secured by the Lucky Jim company at Zincton for its zinc ore and concentrate; for 1000 tons the net return will be \$3 per ton more than the previous arrangement. The mine is looking well.

A barge on Slocan lake, carrying concentrate worth \$12,000, the property of the Standard Silver-Lead company, lost this product during a storm two weeks ago.

Zinc ore and concentrate from Kootenai mines last year totaled 13,058 tons, an increase of 2869 tons over 1914. All was sent to United States smelters. Twelve mines contributed.

On February 29 the Hedley Gold Mining Co. will pay 3c., and an extra of 7c., making a total of \$120,000.

ONTARIO

(Special Correspondence.)—The current year opens full of promise and increasing activity, 35 properties showing signs of renewed work. When construction at the Hollinger and Dome are complete the gold output will be greatly augmented. —The surface plant at the Success has been thoroughly overhauled, and the new owners are ready for extensive development.—The Apex plant is also being prepared for resumption of development.—Many rumors are heard regarding renewed work at the Moneta.—The Standard has been optioned to Boston interests, who are to commence at an early date.—In the north cross-cut at the 100-ft. level 40 ft. from the shaft, the Hayden company cut the orebody that dipped out of the shaft at a depth of about 60 ft. The cross-cut is through 21 ft. of ore worth from \$12 to \$48 per ton, with the face still in ore.

The Jamieson claims in Robb township have been optioned to people represented by Duncan Chisholm of Toronto, for a price said to be \$175,000. A small payment has been made and work has been commenced.—The owners of the McLean claims in Turnbull, are soon to commence some further development of their holdings.—It is rumored that the McAulay-Bridge claims in Bristol township have been optioned to Toronto financiers.

Permission has been granted by the Ontario government to some of the owners of claims in the Tashota Lake district to go ahead with their assessment work. Permission had not been granted previously because it was thought that the Nipiyon Forest Reserve covered most of the district. Excellent discoveries have been made on several properties, notably the Devaney and Brennan Kline groups; the Green claims all have yielded good results in panning and sampling.

Work is proceeding on the molybdenite property owned by Smith and House near mileage 77 on the T. & N. O. railway. Camps are being erected, and preparation being made for con-

tinuous shipment of ore.—Interesting discoveries of tungsten ore have been made near North bay; the situation is a secret and is occasioning local excitement.

Porcupine, January 4.

During 1915 the Dome mine produced 317,873 tons of ore averaging \$4.68 per ton. The first Hardinge mill is at work. Worn out stamp batteries will be replaced by these machines.

Work has been started at the La Belle Kirkland Lake Gold Mines property. The new plant cost \$20,000. Sinking is under way. Prospects are considered good.

During December the Nipissing high and low-grade mills treated 71 and 6754 tons of ore respectively, yielding bullion worth \$112,907. With this and custom products the refinery produced 681,213 oz. Underground work was favorable. Equipment is finished at shaft 81, which is 90 ft. deep, and is to be continued to 480 feet.

Some 3000-oz. ore is being extracted from the Chambers-Ferland.

KOREA

The Seoul Mining Co., operating the Suan concession, reports the following results for December:

| | |
|---|-----------|
| Ore treated, tons | 16,880 |
| Mill operated, days | 28 |
| Bullion recovered | \$ 72,250 |
| Concentrate | 50,420 |
| <hr/> | |
| Total | \$122,670 |
| Expenses | \$ 65,000 |
| <hr/> | |
| Net | \$ 57,670 |
| Received by adjustment of smelter returns on concentrate shipped during 1915, due chiefly to increased price of copper, an excess over estimated value of.. | \$ 55,000 |
| <hr/> | |
| Total for month | \$112,670 |

MEXICO

Large shipments of coke for the plants of the American Smelting & Refining Co at Monterrey, Chihuahua, Matehuala, and Velardena are going into Mexico from Birmingham, Ala. Three furnaces have been blown-in at Monterrey. The Matehuala smelter treats only copper ore, and that at Velardena is equipped to reduce copper as well as lead. Work at Chihuahua will be delayed by the recent murders. The smelter at Aguascalientes is also to be re-started.

EL ORO

During the annual meeting of the El Oro Mining & Railway Co., held at London late in December, the chairman, R. T. Bayliss, made the following remarks regarding operations in Mexico:

"Since we were compelled to close down in February last (1915), the main object has been to keep the mines free from water. Should we fail in this, considerable damage would be done to the lower workings, and much delay would occur when we were able to resume operations. The other work which was done since February has been done partly from motives of common humanity and partly from prudence. That is to say, the native population of the camp, when the works were closed down, was in danger of starvation; and we have been employing from 500 to 600 men to avoid this calamity. A starving Mexican population is a dangerous element; and it has only been by the co-operation of the mining companies in the El Oro district that a very serious situation has thus been avoided. Incidentally, this policy has enabled us to maintain the mine workings in good order and to do a small amount of development. The interruption which has thus occurred in our operations is exasperating to a degree, for I do not think the prospects of the El Oro company were ever brighter than they were 18 months ago. The development of the Ofir claim,

which was purchased in November, 1912, had, up to the time that work was stopped, exceeded all expectations, and was placing us in possession of a large reserve of ore which, for the El Oro district, was of high grade. The development of the various veins in the Sonora claim was also fully justifying all forecasts, and the directors were looking forward to a period of prosperity, equalling anything the El Oro company had experienced in the past. So long as no physical damage is done to the property, and I am pleased to be able to say that so far no extensive or material injury has been done, we shall be able to take up this work on resumption where it was left off. When we do resume we shall be confronted by many difficulties. There will probably be a considerable increase in taxation on output, and a higher cost for labor, supplies, and so forth, and the general cost of operations will be increased by this sum, whatever it may be. On the other hand, it is confidently expected that when tranquil conditions are once more established, several advantages will tend to offset these increases.

Just when we shall be able to resume it is, at present, quite impossible to predict. While for the time being there is a lull in the military activities among the various factions in the Republic, those best able to advise the directors cannot foresee any immediate prospects of a recovery in the political and economic conditions of the country which would warrant us in re-commencing operations at an early date. It is, moreover, the determination of the directors that they will not, if they can help it, jeopardise the interests of the company by attempting to re-start operations unless, and until, we have a reasonable assurance that we can continue the work unmolested for an indefinite period. It is a matter of great regret that we cannot tell that shareholders' troubles are at an end. They are not, and I should be misleading you if I pretended they were."

JALISCO

The Cinco Minas Co. has operated about 50% of the time during the last two years. It started operation again at full capacity on November 30, 1915, and at present remains at that pace. The company experienced no great difficulty through revolutionary trouble, except that transportation for the past six months has been greatly demoralized. At present there is six months' supplies on hand, and steady work is contemplated. Bullion and concentrate has been shipped from the property via Manzanillo and San Francisco. The mill is treating 340 metric tons per day in a plant designed for 250 short tons. A contemplated increase to 500 metric tons will be made in the near future, and a few additions will give this capacity. The plant has been giving about 93% extraction. It was designed by the late Godfrey Doveton.

SONORA

Cananea is suffering from a shortage of Mexican labor. Nacozari is busier than usual.

Schools and Societies

The Bulletin of the MASSACHUSETTS INSTITUTE OF TECHNOLOGY for December consists of 597 pages. It includes a catalogue of officers and students, with requirements for admission, and notes on the courses of instruction. The laboratories are described, and prizes offered are discussed. The second term of the school-year 1915-1916 begins on February 7.

THE U. S. CIVIL SERVICE COMMISSION announces an open competitive examination for physical metallurgists on February 2, 1916. From the register of eligibles resulting from this examination certification will be made to fill a vacancy in this position in the Navy Yard, Boston, Massachusetts, at a salary ranging from \$4 to \$6 per diem, and vacancies as they may occur in positions requiring similar qualifications, unless it is found to be in the interest of the service to fill any vacancy by reinstatement, transfer, or promotion.

PERSONAL

O. E. JAGER has arrived from Peru.

W. SPENCER HUTCHINSON, of Boston, is here.

A. P. ROGERS is on his way to Ormo, Bolivia.

L. B. SPENCER is here from Hawthorne, Nevada.

J. H. FRANCE, of New York is at the Palace Hotel.

BLANCA STEVENS is visiting New York from Mexico.

T. SKIWEK SAUNDERS is in New York on his way from Mexico to London.

GEORGE WALKIN EVANS, of Seattle, is on his way to Washington, D. C.

LOUIS A. WRIGHT has gone to Chile for the American Metal Co. of New York.

W. E. UPHAM, Michigan College of Mines, 1895, is in San Francisco, at 1451 Taylor street.

J. R. FINLAY has been elected president of the Mining and Metallurgical Society of America.

R. M. RAYMOND is making a visit to Mexico, before commencing his lectures at Columbia.

NORMAN C. STINES sails from New York on February 1, returning to Russia by way of London.

W. A. KARR-DAVIES, so honorably known in South Africa, is at the Hotel Claremont, Berkeley.

HAROLD WHITTINGHAM, Michigan College of Mines, 1911, is a captain of British artillery in France.

N. O. LAWTON is at Sneedville, Tennessee, where he will for several months conduct explorations in Hancock county.

FRANK M. LILLAND has resigned as manager for the Empire Copper Co., at Mackay, Idaho, becoming consulting engineer to the same company.

JOHN G. KIRCHEN, general manager of the Tonopah Extension Mining Co., has been elected president of the Nevada Mine Operators Association.

W. J. LORING has not left the firm of Bewick, Moreing & Co. His taking of an office in San Francisco simply marks his firm's interest in Pacific Coast mining.

F. G. CLAPP, managing geologist of the Associated Geological Engineers, has returned from the Oklahoma fields, and may be addressed in Pittsburg for the next few days.

R. T. BAYLISS, chairman of the El Oro Mining & Railway Co. of El Oro, Mexico, at the recent annual meeting, made the following statement: "Six of the younger men of the staff recently employed at El Oro joined the colors, and have been engaged in active service in France. One of these, Mr. Lacy, was awarded the Distinguished Service Order; and it is a pitiful reflection that the announcement of this award, and his promotion, should have been received upon the day on which he was killed in action. Two of the others, O. D. Filley and G. A. Syme, have received the Military Cross for conspicuous gallantry, and I think the fact that three out of the six men who volunteered from El Oro should have earned these distinctions gives an accurate impression of the character of the men whom you have in your employ."

WILLIAM J. WALLACE, formerly superintendent of the Cusi Mining Co. at Cusiuhiriachic, was among those killed by Mexican bandits last week. Wallace was from Houghton, Michigan, a graduate of the Michigan College of Mines, 1905, and a member of Sigma Rho fraternity. He leaves a wife at Tombstone, Arizona.

THE METAL MARKET

METAL PRICES

San Francisco, January 20.

| | Cents per pound. |
|-------------------------------------|------------------|
| Antimony | 44 |
| Electrolytic copper | 25 |
| Pig lead | 6.15—7.10 |
| Quicksilver (per flask) | \$225 |
| Spelter | 21 |
| Tin | 43 |
| Zinc-dust, 100-kg. zinc-lined cases | 30 |

ORE PRICES

San Francisco, January 20.

| | |
|--|---------|
| Antimony: lower, 50% product, per unit | \$2 |
| Chrome: 40% and over, f.o.b. cars California, per ton | 15—18 |
| Magnesite: crude, per ton, f.o.b. | 7.50—10 |
| Magnesite: plastic, no iron and lime, calcined, per ton | 50 |
| Magnesite: refractory, up to 7% iron, calcined, per ton | 30—40 |
| Manganese: 50% metal, 8% silica, per ton, f.o.b. cars, S. F. | 12 |
| Tungsten: minimum 65% WO ₃ , per unit for spot | 40—50 |

For 26.25 tons of 40% product (wolframite) sold in December to the Crucible Steel Co., the Wasp No. 2 company of South Dakota realized \$47.50 per unit.

The United States output of tungsten concentrate in 1915 was 2165 tons, worth \$2,000,000.

New York, January 14.

| | |
|----------------------|--------|
| Antimony: per unit | \$2.20 |
| Molybdenite: per lb. | 1.40 |

Tungsten is exceedingly firm at \$60 for spot, that price having been paid for several lots for immediate delivery. Contracts covering eight or nine months of this year have been made at over \$40. Dealers and buyers are unwilling to give exact figures.

EASTERN METAL MARKET

(By wire from New York.)

NEW YORK, January 20.—Copper is quiet, though fairly strong; lead is quiet, but becoming firmer; zinc is active and rising.

SILVER

Below are given the average New York quotations, in cents per ounce, of fine silver.

| Date. | Average week ending |
|-------------|---------------------|
| Jan. 13 | 56.87 |
| " 14 | 57.00 |
| " 15 | 56.87 |
| " 16 Sunday | |
| " 17 | 56.37 |
| " 18 | 56.37 |
| " 19 | 56.62 |

Monthly averages.

| | 1914. | 1915. | | 1914. | 1915. |
|------|-------|-------|-------|-------|-------|
| Jan. | 57.58 | 48.85 | July | 54.90 | 47.52 |
| Feb. | 57.53 | 48.45 | Aug. | 54.35 | 47.11 |
| Mch. | 58.01 | 50.61 | Sept. | 53.75 | 48.77 |
| Apr. | 58.52 | 50.25 | Oct. | 51.12 | 49.40 |
| May | 58.21 | 49.87 | Nov. | 49.12 | 51.88 |
| June | 56.43 | 49.03 | Dec. | 49.27 | 55.31 |

Apart from small fluctuations, silver remains steady. India has bought at rising prices. European and English orders assisted firmness.

Silver market conditions in China are discussed in the January Bulletin of the Canadian Mining Institute, by G. G. S. Lindsay. At the end of last August there was \$2,000,000 Mexican dollars in the banks there. This is an accumulation due to customs and salt revenues, pledged for loans awaiting distribution from foreign banks. Small banks are to be opened. New currency is needed. The country is not a large silver consumer.

TIN

Prices in New York, in cents per pound.

| Monthly averages. | | | | | |
|-------------------|-------|-------|-------|-------|-------|
| | 1914. | 1915. | | 1914. | 1915. |
| Jan. | 37.85 | 31.40 | July | 31.60 | 37.38 |
| Feb. | 39.76 | 37.23 | Aug. | 50.20 | 31.37 |
| Mch. | 38.10 | 48.76 | Sept. | 33.10 | 33.12 |
| Apr. | 36.10 | 48.25 | Oct. | 30.40 | 33.00 |
| May | 33.29 | 39.28 | Nov. | 33.51 | 39.50 |
| June | 30.72 | 40.26 | Dec. | 33.60 | 38.71 |

Tin is quiet at 41 cents.

The first Bolivian concentrate for the new A. S. & R. smelter at Perth Amboy has arrived.

COPPER

Prices of electrolytic in New York, in cents per pound.

| Date. | Average week ending |
|-------------|---------------------|
| Jan. 13 | 23.62 |
| " 14 | 23.62 |
| " 15 | 23.62 |
| " 16 Sunday | |
| " 17 | 23.62 |
| " 18 | 23.75 |
| " 19 | 24.00 |

Monthly averages.

| | 1914. | 1915. | | 1914. | 1915. |
|------|-------|-------|-------|-------|-------|
| Jan. | 14.21 | 12.60 | July | 13.26 | 19.09 |
| Feb. | 14.46 | 14.38 | Aug. | 12.34 | 17.27 |
| Mch. | 14.11 | 14.80 | Sept. | 12.02 | 17.69 |
| Apr. | 14.19 | 16.64 | Oct. | 11.10 | 17.99 |
| May | 13.97 | 18.71 | Nov. | 11.75 | 18.88 |
| June | 13.60 | 19.75 | Dec. | 12.75 | 20.67 |

Exports during the week ended January 1 were 26,586,160 lb., worth \$5,318,134. France got 12,511,269 lb. of this. Imports amounted to 2,197,661 lb., valued at \$371,465. Cuba sent 518,560 pounds.

The 'American Metal Market' estimates stocks at the end of 1915 as 240,000,000 lb., an increase of 67,000,000 lb. compared with a year ago.

In 1915, Michigan companies made a total profit of \$20,000,000; the cost was 9c. and revenue 17c. per pound. The January output will be about 5,000,000 lb. less on account of bad weather.

Wages at Butte have been raised 25c. per shift.

Braden produced 3,826,000 lb. in December. The Chile Copper Co. is to prepare for a 300% increase in yield, available in 1920.

LEAD

Lead is quoted in cents per pound, New York delivery.

| Date. | Average week ending |
|-------------|---------------------|
| Jan. 13 | 5.90 |
| " 14 | 5.90 |
| " 15 | 5.90 |
| " 16 Sunday | |
| " 17 | 5.90 |
| " 18 | 5.90 |
| " 19 | 5.90 |

Monthly averages.

| | 1914. | 1915. | | 1914. | 1915. |
|------|-------|-------|-------|-------|-------|
| Jan. | 4.11 | 3.73 | July | 3.80 | 5.59 |
| Feb. | 4.02 | 3.83 | Aug. | 3.86 | 4.67 |
| Mch. | 3.94 | 4.04 | Sept. | 3.82 | 4.62 |
| Apr. | 3.86 | 4.21 | Oct. | 3.60 | 4.62 |
| May | 3.90 | 4.24 | Nov. | 3.68 | 5.15 |
| June | 3.90 | 5.75 | Dec. | 3.80 | 5.34 |

QUICKSILVER

The primary market for quicksilver is San Francisco, California being the largest producer. The price is fixed in the open market, according to quantity. Prices, in dollars per flask of 75 pounds:

| Date. | Week ending |
|---------|-------------|
| Jan. 13 | 150 |
| Dec. 22 | 130 |
| " 29 | 135 |

Monthly averages.

| | 1914. | 1915. | | 1914. | 1915. |
|------|-------|-------|-------|-------|--------|
| Jan. | 39.25 | 51.90 | July | 37.50 | 95.00 |
| Feb. | 39.00 | 60.00 | Aug. | 80.00 | 93.75 |
| Mch. | 39.00 | 78.00 | Sept. | 76.25 | 91.00 |
| Apr. | 38.90 | 77.50 | Oct. | 53.00 | 92.90 |
| May | 39.00 | 75.00 | Nov. | 55.00 | 101.50 |
| June | 38.60 | 90.00 | Dec. | 53.10 | 123.00 |

The market is bare of supplies, and high prices continue.

ZINC

Zinc is quoted as spelter, standard Western brands, New York delivery, in cents per pound.

| Date. | Average week ending |
|-------------|---------------------|
| Jan. 13 | 17.62 |
| " 14 | 17.87 |
| " 15 | 18.00 |
| " 16 Sunday | |
| " 17 | 18.00 |
| " 18 | 18.50 |
| " 19 | 18.62 |

Monthly averages.

| | 1914. | 1915. | | 1914. | 1915. |
|------|-------|-------|-------|-------|-------|
| Jan. | 5.14 | 6.20 | July | 4.75 | 20.51 |
| Feb. | 5.22 | 9.05 | Aug. | 4.75 | 14.17 |
| Mch. | 5.12 | 8.40 | Sept. | 5.16 | 14.14 |
| Apr. | 4.98 | 9.78 | Oct. | 4.75 | 14.05 |
| May | 4.91 | 17.03 | Nov. | 5.01 | 17.20 |
| June | 4.84 | 22.20 | Dec. | 5.10 | 16.75 |

Eastern Metal Market

New York, January 14

Taken as a whole, the market shows a somewhat irregular tendency. The big buying of copper has ceased, for the time being at least. The market is adversely affected by Great Britain's evident intention to protect its interests, and curb speculation. The same is true of lead, which has been quiet in New York, despite offerings at concessions. Spelter has been fairly steady, but not active, although spot and prompt metal has been taken. Tin has been dull, not only because consumers have lacked interest, but because of difficulty in getting licenses to ship from England and unusual delays in cable communication. Antimony is dull, scarce, and firm. Aluminum continues to grow easier for no apparent reason.

As for domestic business in general, so far as metal working lines are concerned, a betterment is indicated on all sides by the steady and diversified demand for machine tools. The shipyards have orders aggregating \$100,000,000 on their books, calling for some 700,000 gross tons of merchant vessels, to say nothing of Government work. Several vessels cannot be delivered for three years, and many authorities believe the yards will be busy for five years. The Seattle Dry Dock & Construction Co. will build two vessels for the Atlantic coast trade because it can deliver them more quickly than can any yard on the Atlantic seaboard. In the East, the railroad freight embargoes continue to hamper business, especially the foundry trade. The steel trade continues to boom. In December the Steel Corporation's unfilled orders increased 616,000 tons, making the total 7,800,000 tons, the largest since early in 1913. The Corporation, and most of the independents, have advanced the wages of common labor 10%. Mills are asking up to 2.50c. Pittsburg, for plates.

COPPER

In the past few days the copper market has been somewhat uncertain, and in many minds there is a belief that quotations have gone as high as they are likely to go for the present. The producers are asking from 24 to 24.25c., 30 days, delivered. Some of them say business is still fair, while others say there is but little doing. Second-hands, in the early part of this week, offered substantial concessions to get business, but succeeded in placing only a few hundred tons. On January 13, the London quotation for standard advanced £2 2s. 6d., to £87, whereas in the past few days it had been losing strength and had declined £6. After the advance, second-hands thought better of the market and their offerings were withdrawn. It was said they had sold down to 23.12c. cash, New York, but their minimum quotation January 13 was 23.50c. Not much was taken at cut prices. The London quotation for electrolytic has stood fast at £113, although Great Britain has fixed £100 as the maximum price which munition makers should pay, its intention being to curb speculation. France has been a good buyer recently. A short time ago when the recent movement was at its height the wire-drawers and other domestic consumers were heavy purchasers, but since that time the buying has been entirely on the account of the munition makers. In this connection the fact will bear repetition that many of the War buyers know little or nothing about the working of copper. Some of them already have met with costly troubles in the execution of their orders, and some of the contracts are being turned over to other concerns to complete. Certain users of copper are expecting that considerable metal, originally intended for War purposes, will find its way to the general market. One large concern which had orders for shells valued at millions has practically collapsed, and it is no secret that others are having their troubles. Re-

liable engineering firms will make a great deal of money out of War orders, but the inexperienced individuals that rushed into the game, declaring that with an order in hand they could raise any amount of money, and that with money they could buy all the brains that were needed, also do anything, no matter how short the time, are not quite so enthusiastic. European stocks have continued to diminish, as indicated by the following statement of Henry R. Merton & Co., Ltd., London, under date of December 17: "The European visible supplies on December 15 amounted to 23,493 tons, as against 26,068 tons, on November 30, thereby showing a decrease of 2575 tons. The actual stocks in England and France shrunk 2550 tons, and now amount to only 12,195 tons (December 15)." Exports in the first 11 days of January totaled 11,951 tons.

ZINC

Except for spurts of demand for spot and nearby deliveries the zinc market has been continuously dull and uninteresting. Sellers do not appear to have much early metal to offer, but what comes out is taken steadily. Considerable surprise has been expressed because the market did not become more active in sympathy with copper, and the only explanation is that consumers filled up a few weeks ago. At no time has the quotation been far from 17.50c., New York, though a stronger tendency developed late this week. The galvanizing trade is staying out of the market to a great extent, and its absence was accentuated by two or three violent strikes at steel plants at Youngstown, Ohio. There was fear that the strikes would become widespread, but a wholesale advance of 10% in the wages of laborers appears to have quelled the trouble. Prompt metal was quoted on January 13 at 17.50c., New York, for spot; 16.55c. for February; 15.75c. for March, and 14 to 14.50c. for second quarter. Exports in 14 days of January totaled 1929 tons.

LEAD

The most important development in lead since the last report, is the announced intention of Great Britain to halt speculation which is working to the detriment of her munition makers, and to the disadvantage of the Government itself. This news caused the London quotation for spot to decline on January 12 from £31 to £29 5s. (off £1 15s.). The New York and St. Louis markets quickly reflected the weakness abroad, particularly at St. Louis, and although the leading interest adhered to its quotations of 5.90c., New York, and 5.82c., St. Louis, second-hands were willing to sacrifice a few points to get business. For some days the domestic market has been very dull and unsettled. The exports in fourteen days of January totaled 3245 tons.

TIN

The market has been dull to a point of stagnancy for several days. Not only have domestic consumers shown little interest, but trading has been hampered by events abroad. News comes that licenses to ship from England are obtained with difficulty by firms in whom the British government does not seem to have complete confidence. Again, cable messages have been subject to unusual delays, frequently arriving too late for action to be taken on them. The spot quotation on January 6 was 42.25c., and January 12, 41c. Up to January 14, 3975 tons had arrived in the month, and there was 5365 tons afloat.

ANTIMONY

The market has been extremely dull, but the scarcity of nearby supplies has been a sustaining influence, and quotations range from 41.50 to 42c. for Chinese and Japanese grades. The American product is quoted at the same figure.

MINING DECISIONS

OIL LEASE HELD A MERE LICENSE

An agreement in the form of a lease for a term of years granted the right to explore for oil and gas, and provided that unless a well were drilled within a year, a rental of \$2.50 per acre per year should be paid thereafter. Held, such an agreement is more like a license than an estate in land, and may under its terms include a forfeiture without notice, if the rental is not paid or the well drilled in the specified time. In the case of an option, time is of the essence of the contract, unless the contract expressly provides it shall not be.

Mitchell v. Probst (Oklahoma) 152 Pacific, 597. October 19, 1915.

MINER'S LIENS—PRIOR TO MORTGAGE

A mortgagee in a mortgage executed subsequent to the statute giving laborers and material men a preference lien, is not deprived of his property right without due process of law, because the liens of mine laborers and material men attaching subsequent in date to the date of his mortgage are given preference over the mortgage. When the liens are attached by reason of obligations incurred in the mining operations of a lessee, no personal judgment can be entered against the owner.

Haines Commercial Co. v. Grabill, et al. (Oregon), 152 Pacific, 877. November 16, 1915.

OIL-WELLS—DRAINING ADJACENT LAND

Where oil-wells are driven in such close proximity to the division line that they drain oil from the adjoining land, such operations, in the absence of special circumstances or relations between the parties, afford no basis for a claim to a share in or accounting for the oil so produced, or for a receivership thereof.

Gain v. South Penn Oil Co. (West Virginia), 86 South-eastern, 883. October 19, 1915.

OIL LEASE—ADDITIONAL ROYALTY CLAUSE

Where in a deed conveying oil and gas privileges on a stated consideration, it is further provided that the grantee is to pay the grantor additional consideration "within 90 days after a well for oil and gas is drilled on the land and oil produced in pipe-line in paying quantities," there is no obligation for payment of the additional consideration if a well is drilled and gas alone produced.

Ball v. Freeman (West Virginia), 87 Southeastern, 91. November 16, 1915.

OIL CORPORATION—NOT TO OWN RAILROAD

Statutory authority to erect, build and own tank-cars does not authorize an oil company to build and operate a railroad even though such railroad be used in the operation of its business.

Continental Trust Co. v. Brown (Texas), 179 Southeastern, 939. November 17, 1915.

INJURY TO MINER—LIABILITY OF OWNER

An employee of a tunnel contractor was killed by coming in contact with a defectively insulated electric cable in an air shaft where he was not supposed or required to go. Held, that no liability attached to the mine-owner who had contracted with the employer of the deceased to drive the tunnel.

Patterson v. Alabama Fuel & Iron Co. (Alabama), 69 Southern, 952. November 18, 1915.

Note: This decision would have no weight in those States which have adopted compensation acts.

COMPANY REPORTS

TONGKAH HARBOUR TIN DREDGING CO., N. L.

This company's report for the year ended September 30, 1915, is of much interest. The head office is at Hobart, Tasmania, and the field of operations is at Puket, Siam. The title explains the metal produced and the method of extraction. The general manager is Eliot T. Lewis, with G. H. Symons as assistant.

As No. 1 dredge sank and was of no further use, only five boats were operated. They worked a total of 27,369 hours, digging 2,968,600 cu. ft., yielding 0.953 lb. tin oxide per yard, at a working cost of 8.926c. per yard. The time was less, yardage more, yield less, and costs less than in the previous year. The tin-dredging plant returned 1262.3 tons of oxide averaging 72.5% metal.

The net profit was \$195,000, of which \$110,000 was paid in dividends. Adding the previous balance, the credit is now \$340,000. Dividends to date amount to \$1,090,000, equal to \$7.92 per share.

ASHANTI GOLDFIELDS CORPORATION, LTD.

This company operates in West Africa, and its report is for the year ended June 30, 1915. The ores mined have been the subject of considerable discussion, on account of the graphite contained, and its effect on cyanidation.

The consulting engineer reported as follows: The Ashanti, Ayeinn, Old Chief, and Tom Collins mines produced a total of 138,316 tons of ore. Reserves amount to 433,900 tons averaging \$21.55 per ton, an increase of \$860,000 in value. Ventilation of the Ashanti is not solved yet. The Old Chief and Tom Collins are about exhausted. Labor and fuel supplies were plentiful. The gas-electric sets are working well, the cost per horse-power day being 44 cents.

The central mill treated 109,287 tons by dry crushing, roasting, and cyanidation, for a yield of \$1,930,000, with 93.1% recovery; the Côte d'Or mill treated 29,029 tons, yielding \$217,000, with 83.9% extraction. A variety of processes are used in the latter.

The year's profit was \$770,000, of which \$720,000 was paid in dividends. The credit balance is \$340,000.

Mining cost \$2.46; treatment, \$3.24; and general expenses, \$1.12, a total of \$6.82 per ton.

CONSOLIDATED MINING & SMELTING CO. OF CANADA, LTD.

The report of this British Columbian company covers the year ended September 30, 1915. The general manager, R. H. Stewart, briefly gave the result of operations.

Development in nine mines totaled 21,067 ft. of narrow work, and 26,415 ft. of diamond-drilling. Ore reserves remain practically as before. Work is underway at 2400 ft. depth in the War Eagle mine, by means of a cross-cut from the Center Star shaft. Some small properties were purchased.

New plant cost \$334,909, mostly at the Trail smelter. Considerable testing was done on the production of electrolytic zinc, and a 25 to 35-ton plant is about complete. The Sullivan mine can supply the ore for this process.

Custom ore received was 57,251 tons, against 72,098 tons in the previous year. The smelter treated 447,064 tons of ore, yielding 148,891 oz. gold, 2,230,500 oz. silver, 40,177,910 lb. lead, and 5,306,184 lb. copper, valued at \$6,898,744. After writing-off \$192,479 for depreciation, the profit was \$795,411. Four dividends absorbed \$464,398. Adding this and last year's surplus the balance is \$2,058,300.

Since 1894 the output is 4,372,886 tons ore, 1,610,903 oz. gold, 22,247,832 oz. silver, 374,091,124 lb. lead, and 63,196,978 lb. copper, valued at \$73,402,078.

RECENT PUBLICATIONS

MINE SAFETY RULES. Issued by the Industrial Accident Commission of California. P. 123. Ill., index. State Printing Office, Sacramento, 1915. These rules were effective on January 1, 1916. The book was noted in the Press of December 12.

METHODS FOR THE EXAMINATION OF BITUMINOUS ROAD MATERIALS. By Prevost Hubbard and Charles S. Reeve. Bulletin 314. P. 48. Illustrated. U. S. Department of Agriculture, Washington, D. C., 1915. Of practical value to road engineers.

ANNUAL REPORT of the Superintendent, U. S. Coast and Geodetic Survey, to the Secretary of Commerce, for the fiscal year ended June 30, 1915. P. 156. Maps, index. Washington, D. C., 1915. There is a lot of interesting matter in this report, a good deal covering work done in and proposed for Alaska.

EXTRACTION AND RECOVERY OF RADIUM, URANIUM, AND VANADIUM FROM CARNOTITE. By Charles L. Parsons, R. B. Moore, S. C. Lind, and O. C. Schaefer. Bulletin 194, mineral technology 12. P. 124. Ill., plans, index. U. S. Bureau of Mines, Washington, D. C., 1915. A brief outline of this process was given in the Press of December 25.

ANNUAL REPORT of the Director of the Mint for the fiscal year ended June 30, 1915; also report on the production of the precious metals in the calendar year 1914. P. 304. Ill., index. Washington, D. C., 1915. This publication deals with gold and silver work at the Mints, foreign gold, money, consumption of precious metals, output of the principal countries, etc.

MINERAL RESOURCES OF CALIFORNIA. Advance chapters on Amador, Calaveras, and Tuolumne; Colusa, Glenn, Lake, Marin, Napa, Solano, Sonoma, and Yolo; Del Norte, Humboldt, and Mendocino; Fresno, Kern, Kings, Madera, Mariposa, Merced, San Joaquin, and Stanislaus; and Shasta, Siskiyou, and Trinity counties, by various authors, field assistants with the California State Mining Bureau. Total pages, 989, with illustrations and indexes. By writing to the Bureau at the Ferry building, San Francisco, these publications may be procured at from 25 to 50c. each. In the Press of January 1 they were given considerable space.

ORIGIN OF THE ZINC AND LEAD DEPOSITS OF THE JOPLIN REGION. (Missouri, Kansas, and Oklahoma). By E. Siebenthal. Bulletin 606. P. 282. Ill., maps, index. U. S. Geological Survey, Washington, D. C., 1915. The region, generally known as the Joplin district, has been the subject of a number of geological investigations. In studying the ore deposits of this area, Mr. Siebenthal reached certain conclusions regarding the genesis of the ores which are somewhat at variance with those reached by some other investigators, but are in general confirmatory of the findings of the U. S. Geological Survey's earlier work. In these investigations, the original source of the metals has generally been the subject of much speculation and study. Analyses of large quantities of material have shown the general presence of measurable quantities of lead, zinc, and copper in the pre-Cambrian crystalline rocks, in the Cambrian and Ordovician limestones, and in the Mississippian limestones, and it is also known that the Pennsylvanian shale in a few places carries appreciable quantities of lead and zinc. These rocks comprise all the geologic groups that make up the Ozark uplift, and each group has been considered the immediate source of the metals by one or more writers on the geology of the ores. The present report, the result of several years' study, likewise holds that the ores were deposited by ascending artesian solutions which derived the metals chiefly from the Cambrian and Ordovician limestones.

Commercial Paragraphs

The Fort Wayne Electric Works of the General Electric Co., Fort Wayne, Indiana, has issued two bulletins describing its type H and M2 demand indicators.

At Denver, Colorado, the STUBBINS, SUTELLE & SUTELLE MANUFACTURING, MILLING & MINING Co. has its new demonstrating mill ready to receive all kinds of common and rare ores. Storage bins have a capacity of 700 tons. The mill is entirely automatic. The patented machines concentrate dry.

SNYDER ELECTRIC FURNACE Co., Chicago, Illinois, has recently published an attractive illustrated booklet on the application of electric furnaces to the manufacture of steel. The application of the electric furnace is finding favor in a great many localities, and many advantages are claimed for the Snyder furnace over other types of furnaces.

Bulletin No. 9 of the Electric Weighing Co., New York, whose Western agents are the Mine & Smelter Supply Co. of Salt Lake City, Denver, and El Paso, describes the Messler conveyor scales. This machine has been tested under working conditions for over three years. It weighs material while being carried on belt, pan, or bucket-conveyors. Weights and prices are given.

The January issue of *Mine and Quarry*, published by the SULLIVAN MACHINERY Co., Chicago, contains several interesting items, including 'Rapid Sinking at the Newport Mine, Michigan,' 'American Drills in an Italian Tunnel,' 'A Mechanical Drill Smith,' 'Deep Mining with Ironclad Coal-Cutters,' 'The Dorchester Tunnel Under Boston Harbor,' 'The Air-Feed Drifter,' and 'Core-Drilling at the Hollinger,' Ontario. These are authoritative articles.

The UTAH KARNS TUNNELING MACHINE Co. of Salt Lake City, recently perfected a heading machine for rock tunnel work. The machine puts in a 12-in. cut hole 15 ft. into the heading, and eases the ground so that 15 ft. can be broken down in a round in any size heading in an 8-hour shift. Small drills are used in connection with the machine, all holes being drilled the 15 ft. No powder is used in the 12-in. hole, but is put in the small drill holes and the whole mass breaks into the relief hole.

In its flotation oil Circular No. 11, the PENSACOLA TAR & TURPENTINE Co., of Gull Point, Florida, states that the list of oils has been greatly reduced. It is considered that there are too many oils, and most of the business will be done on one abundantly produced medium-priced oil, such as No. 350, which contains most of the other oils. This is a special crude wood oil, costing 24c. per gal. in tank-cars, or 27.5c. in barrels. The No. 80, a crude pine oil, 23c. in bulk, is a useful flotation medium. No. 1589 is suitable for lead, silver, zinc, and other complex ores. Doped oils are briefly discussed. One apparently good oil consisted of a skillful mixture of mineral oil, turpentine, and rosin. Plain distillation tests are useless for analysis of such material.

The Anaconda Copper Mining Co. has placed an order for six more 10-ft. diam. by 4-ft. cylindrical length HARDINGE ball-peg mills, making a total of 56 conical mills for the new plant, 48 of which are already in operation. The Hardinge company reports that the 10-ft. mills are direct connected herring-bone gear driven, operating with less than 75% of the power which was originally estimated to be necessary.

V. A. Stout, San Francisco representative of the HARDINGE CONICAL MILL Co., announces the following sales of Hardinge mills for 1916: Natomas Co. of California, six 4½-ft. diam. by 16-in. pebble-mills for re-grinding concentrate on the various dredges; Treasure Mining Co., one 4½-ft. diam. by 16-in. ball-mill, and two of the same size as pebble mills for its new plant near Amador City.



EDITORIAL



T. A. RICKARD, Editor

INDEX to our Volume 111, covering July to December, 1915, is now ready. Copies will be mailed to subscribers upon application.

PRICES of metals continue to rise, as will be seen by reference to the interesting letter from our New York correspondent. Copper at 25.37, zinc at 19.25, and lead at 6.10 are figures to warm the miners' heart.

FORTUNATELY pan-amalgamation has been superseded at most of our mines, otherwise the present price of quicksilver, at \$275 per flask, would be distressing to the miner. In pan-amalgamation an average of about 1½ pound of quicksilver is used per ton of ore; at present prices that means \$4.65 per ton.

FLOTATION is to be applied to the low-grade copper ore of the Spassky mine, in Siberia. Mineral oil is to be used. Some changes will be made in the smelter to prepare for the treatment of the concentrate. We note a decided interest in flotation at Cobalt, where the process is likely to be applied to low-grade silver ore and tailing.

MISSOURIANS complain that the big zinc output of their State, notably from the Joplin region, is treated at smelters in other States. Now that acid leaching and electrolytic precipitation have proved an economic process, why should not the Missouri zinc concentrate be treated in domestic reduction works? They have the water-power.

ACCORDING to statistical evidence, the total foreign trade of the United States in 1915 was only 1.1% of the domestic commerce of the country. The actual increase in external trade last year, extraordinary as it was, shrinks by comparison with the internal growth, for the foreign increase was \$1,450,000,000 as against a gain of \$58,000,000,000 in the home trade.

IN the course of a recent interview in Paris the French economist M. Paul Leroy Beaulieu expressed the opinion that the War will not plunge the belligerent nations into bankruptcy, or anything like it. Undoubtedly the pauperizing effect of the Great Calamity has been exaggerated by failure to realize how much of the abnormal expenditure is distributed among the people of the respective countries at war; moreover, the richness of these countries and their powers of recuperation are vastly greater than is generally assumed, on the basis of precedent wars in periods of early industrial develop-

ment. M. Beaulieu predicts remarkable manufacturing activity at the close of the War, about a year hence, and commercial rivalry among the nations, leading to protective tariffs, even in England, and yet higher tariffs in the United States.

DECISION in the case of the Elm Orlu Mining Company against the Butte & Superior Copper Company has been handed down by Judge Bourquin at Butte in favor of the plaintiff, although the decree is in the nature of a compromise, out of which the Elm Orlu gets a recognition of priority of location over the Black Rock claim. As our readers are aware, Mr. W. A. Clark controls the one company and Mr. D. C. Jackling the other.

RESUMPTION of work at the three big copper mines in the Clifton-Morenci district of Arizona is announced, the men on strike having decided on January 24 to accept the higher wages based upon the rise in the price of copper. We congratulate the companies and the miners both on the adjustment of their quarrel and more particularly on having eliminated the Western Federation of Miners as a factor in their economic conditions.

A RECENT issue of the *Saturday Evening Post* contains an article describing the underground workings of a copper mine. We quote from it: "This maelstrom in the stone, its vortex lost in shadow, appeared yawning like an open throat. I was struck dumb on the very rim of that ominous cavity. It seemed to me as if this rift was a sort of heartless ruin caused by a landslide or by some disaster unforeseen. It was nothing more or less than a stope." We are reminded of the young woman who called the weather "absolutely revolting" and found a potted-ham sandwich "positively divine."

ON January 24 we received the news of the sudden death of John A. Hill, the publisher of a group of trade papers, including the *Engineering and Mining Journal*, the *American Machinist*, *Power*, the *Engineering News*, and the *Coal Age*. John Alexander Hill was a commanding personality, rough and forceful, honest and honorable, with all the superb initiative that marks a captain of industry. Starting life with no education save the ordinary schooling obtained by a boy up to 14 years of age, he entered a printing office and employed his spare time to equip himself for a useful career. By sheer force of industry and character he won a way not only to fortune but to a position of great influence. He used that influence well, although we think he might have

employed it even more to the public good if he had received a more generous mental training. That may be; it is certain that men of his dynamic type are responsible for the technical and industrial development of our time and generation, they do a splendid share of the world's work, and the world is impoverished when their activities cease. We desire to honor the memory of a strong, useful, and honorable man.

TIN is now being smelted in the United States, in the smelter just built by the American Smelting & Refining Company at Perth Amboy, New Jersey. This plant is intended mainly to treat Bolivian tin concentrate, at the rate of 750 tons per month. In order to produce a metal suitable for the tin-plating industry the product of the smelter will be refined electrolytically. To assure an adequate ore-supply, the company will make liberal advances on shipments from the mines. Unfortunately the block in the Panama Canal has interfered with the transport of Bolivian concentrate, but this is temporary. A more serious danger is the threat of a differential tariff in Bolivia as between *barilla*, or 60% concentrate, and bars of metal. Such a step may be taken by the Bolivian government with the hope of encouraging the domestic reduction of the ore. If this happens, the smelter at Perth Amboy will be the victim of the same ill fate that befell the tin smelter built at Bayonne in 1903. The latter was intended to treat tin concentrate from the Malay peninsula, and it was just ready to start when the government of the Federated Malay States imposed a duty of \$30 per picul, or 133½ pounds, on all tin ore exported. This impost, plus an older tax equal to 12% of the value of the tin, killed the export and at the same time put a quietus on tin smelting at Bayonne. The plant was dismantled. According to information coming from La Paz an effort is being made to induce the Bolivian government to subsidize a domestic tin smelter, thus saving the freight on the 40% of impurities in the concentrate, but the affair appears to be half-baked. We hope nothing may arise to disturb the success of the new smelter at Perth Amboy, and we conclude that the Guggenheim directors ascertained the intentions of the Bolivian government before committing themselves to the scheme. Bolivia produces about 40,000 tons of 60% tin-stuff per annum, while the United States imports about 44,000 tons of metallic tin annually, this being equal to 40% of the world's consumption.

WE publish an extremely interesting letter from Mexico City in which an observant correspondent expresses himself frankly concerning present conditions in Mexico and the causes leading thereto. While we do not agree with all the conclusions stated, it is obvious that the writer knows what he is talking about and is well qualified to state his own point of view—one by no means optimistic. It is not likely that any American long resident in the country can be other than depressed by the persistence of political chaos. What he says is largely in accord with the best information previously

available. The reference to syndicalism and the Casa del Obrero Mundial, or House of the World's Workers, is timely, more particularly if read in conjunction with an article by Sr. Carlo de Formado on the 'Great Mexican Revolution' in the *Forum* of November last. Evidently this representative of the I. W. W. is an organization that represents the most radical elements in the revolutionary party. As such it is likely to become less violent in its program when the Carranzistas find that government cannot be conducted on vaporous pronouncements, and that their promises to make a new world for the peon require time for fulfillment; in short, that evolution from political chaos is not done in a hurry, any more than development from elemental chaos. Indeed the most liberal-minded man may well be dismayed at the prospect of changing a peonage dominated by military adventurers into a self-reliant democracy disciplined by representative government. The problem in Mexico is much the same as that in China: an effort to effect a true political revolution under the shock of impact with nations several centuries more advanced in the complex art of living. What Mexico and China both need is a benevolent despotism pending the education of the people and their adjustment to modern conditions. Unfortunately despots, even if benevolent at first, do not remain so long, causing struggles for power amid which the delicate fruits of humanitarian ideals are crushed under-foot, to make room for brute force, corruption, and thinly disguised slavery.

To Those in the Trenches

It will interest our readers to know that the group of American mining engineers resident in London joined in sending a box of Havana cigars to each of 98 British mining engineers in the trenches. This was done as a New Year greeting. With the gift the following note was transmitted:

Jan. 1, 1916.

To the British Mining Engineers
at the Front.

Dear Fellow Engineers,

Please accept this as a small token of our earnest sympathy and our admiration of the fine spirit with which you are meeting the supreme need of the hour. The War may disarrange, but it cannot break the bonds of our common profession; and our sincere hope is that whatever sacrifices the New Year may exact, you personally may come through safe, and that long before the year be ended, you may be able to return to the regular duties from which you can so ill be spared.

American Mining Engineers
Resident in London.

In addition a verse was attached:

"It's the same sort of honest devotion
That's always stood by you before;
When you solved metallurgical problems,
When you put down the deep-level bore,
When you fought with disease in the Tropics,
Won out in the strike at the mines,
It's the same sort of honest devotion
That blows up the enemies' lines."

To the first the initials H. F. B. might have been signed, and to the latter those of E. R.

The act and the manner of it render comment almost superfluous. Even those whose sympathies are enlisted on the other side will appreciate the incident. For ourselves, although we do not like hyphens, it seems that when the hyphen takes the shape of a real cigar, the link between Anglo and American is one to which even the most doctrinaire neutral cannot object. "In the far savannahs a talisman grows that makes all men brothers," and for that reason a fragrant smoke serves as the best expression of the mutual understanding and good-fellowship that exists between the mining engineers who share the same language, the same technical literature, and some of those great imponderables on which our notions of life and happiness depend.

Flotation Litigation

In our issue of December 18 we outlined the present status of the litigation over the flotation patents, referring to the two principal suits, but we failed to note a third suit, arising from the Butte & Superior case. The first suit was brought by Minerals Separation against Mr. James M. Hyde personally, although his operations were conducted on behalf of the Butte & Superior Copper Company. After Minerals Separation had obtained a decision in their favor from Judge Bourquin in the District Court at Butte, they brought a suit against the Butte & Superior, and asked the Court to grant a preliminary injunction enjoining that company from continuing the use of flotation. As our readers probably are aware, a preliminary injunction is one granted in advance of the trial of a case, and is granted upon a preliminary showing, generally in the form of affidavits. In this country a preliminary injunction is rarely granted in favor of a patent that has not previously been adjudicated. In other words, the presumption of validity arising from the mere grant of a patent by the Patent Office is not strong enough to warrant a court in granting a preliminary injunction, that is, granting the injunction without having a regular trial and giving the defendant full opportunity to present his case. In the suit against the Butte & Superior company, Minerals Separation proceeded upon the theory that a full trial had previously been had in the Hyde case as a result of which the Court had found patent No. 835,120 valid and infringed by the Hyde operations, which operations were in reality the operations of the Butte & Superior. There was some force in this position assumed by Minerals Separation. But when the application for preliminary injunction came before Judge Bourquin for argument, the defendant made a series of demonstrations before the Court showing the formation of a froth with large quantities of oil, that is, quantities considerably larger than 1%. As a result of these demonstrations, Judge Bourquin refused to grant a preliminary injunction, thus seeming to indicate a lack of certainty on his part as to the correctness

of his decision in the Hyde case. The Judge made a sort of compromise decision. He decided that if the Butte & Superior company would furnish a bond in the amount of \$75,000, said bond running to Minerals Separation, and payable in the event that the decision was finally in their favor, he would not grant any preliminary injunction. In case Butte & Superior failed to file such a bond, the Judge decided that he would grant a preliminary injunction, provided Minerals Separation filed a bond in the sum of \$125,000, payable to Butte & Superior in case that company was finally successful in the suit, as indemnity against the loss arising from having the mill shut-down. In other words, the Judge decided that he would not grant a preliminary injunction if Butte & Superior filed a bond, and even if that company did not file a bond, he still would not grant an injunction unless Minerals Separation filed a still larger bond to protect Butte & Superior against injury resulting from the mill being closed-down, and the final decision being in their favor. The Butte & Superior company did file a bond in the amount of \$75,000, and, in compliance with a further provision of the Court's ruling, has since filed monthly reports of its operations in Court. After the above proceedings the Court of Appeals at San Francisco reversed the decision of Judge Bourquin in the Hyde case, holding the patent invalid. Apparently this would have warranted, if not compelled, the lower court to cancel its ruling in the Butte & Superior case, inasmuch as the bond in that case was filed upon the presumption that was upset by the Court of Appeals. However, no action was taken in the Butte & Superior case along this line, the company being willing to let the matter rest and to leave its bond in force until the Hyde case is finally decided.

Patents

A patent is the grant by a Government of the exclusive privilege, for a limited period, to make, use, or sell an invention, or to authorize others to do so. In order to record this right, and to warn others from infringing it, the inventor prepares a description of his invention and specifies his claims of originality in a written statement that is lodged at the Patent Office. Right to a patent can be based either upon originality of apparatus or originality of use. In practice, however, the inventor usually discloses only so much of the design of his machine or of the use to which he puts it as will justify his request for a monopoly. In consequence, the language of a patent description or of its claims is often cryptic intentionally, so as to give the minimum of information to possible infringers. Moreover, the tendency to regard patents as an unnecessary interference with industrial initiative and to look upon the royalties imposed by patentees as an irritating exaction has caused them to be classed with vexatious monopolies to evade which is not culpable, if indeed it is not creditable. In short, the use and abuse of this form

of privilege has produced a low state of public morality, the blame for which is widely distributable.

Two aspects of the problem present themselves to any one wishing to be fair. On the one hand it is said that the patentee does not disclose frankly what it is he has discovered or what use he intends to make of his discovery, thereby affording the infringer an excuse for claiming innocence of any trespass. On the other side the inventor can reply that the incompleteness of the disclosure is necessitated by self-protection, having regard to the flagrant disregard of property rights evinced by the public and applauded by the press. As between these opposite statements the onlooker will observe that the granting of patents has not done away with trade secrets, and it is often a nice question whether an inventor shall patent his process, disclosing his method, or keep his process secret and protect himself by a copyright name. If he be a manufacturer himself, this may prove the wiser course. 'His Master's Voice' is worth more than the Victor patent. A middle course may be followed, disclosing enough to procure the essential patent and then copyrighting a label for commercial identity.

Again, it is said that the effort to protect himself is made increasingly costly to the patentee, who is often deprived of his profit by sheer financial inability to defend himself, so that he has to submit to being robbed of the privilege obtained by him legally from the Government. To that the reply is made that the whole world is much in the same fix; the patentee is like the rest of us, who have to arrange for the necessary capital as best we can. Not until the millenium will a poor man be able to compete successfully in business with the rich. As they say in Mexico: *las minas son para los ricos*, if you are a poor man you have no business with a mine. This *non possumus*, of course, is an evasion of the problem, for the end in view is the rewarding of the inventor without creating an incubus upon industry. It has been suggested, for example, that the Government, having rewarded the inventor with a privilege, should protect him in the exercise of it; but that is untenable, one might as well ask the Government to protect a man in the ownership of a homestead. Not until paternalism has been raised to the *n*th degree will anything of the kind be possible. So we come to the patentee who is unable to exploit his patent commercially and feels compelled to sell his rights for a relatively small sum to an individual or a corporation having adequate funds for the exploitation of the patent, whereupon the monopoly passes into the hands of persons who may proceed to exact royalties of an exorbitant character or to impose conditions that render the use of the invention prohibitive. Thus, it is claimed, a proper reward rarely comes to the inventor himself, but to a patent-owning corporation, which waxes rich on royalties. It may be objected that the royalties are not paid by the ultimate consumer, but as a matter of fact, they add to the cost of the article, and in that way he does bear the freight. In the case of metallurgical patents, such as, of course, we have in mind, the

royalty comes out of the miner's settlement for his ores and out of the dividends of the mine owner. But, if the royalties are excessive, they, like usurious rates for money, will create dangers from which moderate demands are exempt. In the end, a law is inoperative against a unanimous public sentiment. That point has not been reached, but it is true that the studied obscurity of patent specifications, the confusing character of judicial decisions, and the excessive demands, not of inventors themselves, but of patent owning corporations, have awakened a keen feeling of protest against the whole system, causing a set of conditions detrimental to metallurgical initiative, for example.

It has been questioned whether the monopoly implicit in a patent is in the public interest. Divided as we may be in our opinions on this matter, we answer in the affirmative, because we recognize the advantage of having ingenious men on the alert to discover improvements to their benefit, much of which accrues to the community in a measure outweighing all the discomforts and scandals incidental to patent squabbles and legal fiaseos, which represent the froth on top of the inter-actions between diverse activities. Comparatively few patents result in litigation, while the hope of a patent spurs many men to work that promotes the development of ideas and the improvement of apparatus. To abolish the granting of patents because one or two patentees are unreasonable would be on a par with the abolition of marriage because divorces happen. We may trust public sentiment and the adjustments of business to act as a corrective. The conclusion is that no other method is available, and no other is needed, as yet.

America is a nation of inventors; we must have a liberal patent law. The typical Yankee boy is Darius Green with his flying-machine. Every lad who works in a factory fancies himself an inventor and exercises his wits to analyze the operations in the factory. His spare time is spent in the wood-shed working at a model. Even if his invention come to nothing, he has improved his quality as a workman and made himself more valuable both to his employer and to himself. The nation gains thereby; the conditions of life are ameliorated by the inventor's ambition to better himself. If we do not travel in an ox-cart by the light of a pine torch, we owe the improvement to the inventor; to Winans, Westinghouse, Edison, Tesla, and a host of others who took out their patents and did their work for what there was in it. Morse, Field, Bell, and Marconi perfected their methods for the transmission of thought in order to gain an honorable profit. Barbed-wire, gang-plows, grain-headers, well-drills, turbines, and other patent machinery have populated the land with progressive agricultural people, who are not peasants. He who makes two blades of grass grow where but one grew before is declared to be a benefactor of his race, but he who does this doubles his crop of hay. Let the man who would abolish the Patent Office pack his blankets, his frying-pan, and his tallow candle, and, calling his dog, take to his log cabin in the tall timber of the Sierras.



DISCUSSION

Our readers are invited to use this department for the discussion of technical and other matters pertaining to mining and metallurgy. The Editor welcomes the expression of views contrary to his own, believing that careful criticism is more valuable than casual compliment.

American Potash

The Editor:

Sir—Referring to the article in your issue of November 27, to which my attention has been drawn, I beg to say that while others have been advancing various theories for the production of potash on this Coast, its actual manufacture has been established by the Inyo Development Co., at Keeler, California. The constituents of the water of Owen's lake render it one of the most interesting chemical problems in California. Its peculiar composition has long attracted the attention of scientists and chemists. For 30 years, before there was any chemical industry to speak of in California, crude carbonate of soda was manufactured by this company on the borders of the lake near the little town of Keeler. Then about 20 years ago followed the making of soda-ash, which is now one of the most important industries in this part of the state.

The chemical composition of the solids of the water of Owen's lake is, according to a Government bulletin:

| | % |
|--|-------|
| Silica | 0.28 |
| Alumina, lime, and magnesia..... | 0.13 |
| Sodium borates | 0.63 |
| Potassium chloride | 4.07 |
| (Other analyses show from 2.80-4.25% average 3% KCl.) | |
| Sodium chloride | 38.16 |
| Sodium sulphate | 14.38 |
| Sodium carbonate | 34.95 |
| Sodium bicarbonate | 7.40 |

The lake-water contains approximately 8% of solids, but the contents vary considerably according to the season.

Solar heat is used for the evaporation of the brine to crystallize the carbonate of soda. To manufacture it more than 96% Na₂CO₃ pure, much experience is required.

If the evaporating is properly conducted, a great part of the carbonate of soda can be produced as a crystallized salt of the above-named standard. This will serve to furnish, by melting and grinding, a high-grade soda-ash, while the rest of the soda remains in liquid. After all the carbonate has been precipitated, the remaining liquor is termed 'spent water.' This spent water has hitherto been wasted by returning it into the lake, but will now be used for the manufacture of potash manure salt.

The chemical analyses of water samples taken from the different vats at different times vary considerably in

the proportion of their components. A test of the solids of this water showed the following results:

Specific gravity of the water 1.3249 at 20° C.

Solution distinctly alkaline, total residue on evaporation 505.2 grams per litre.

The solids contain:

| | % |
|---------------------------|-------|
| Sodium chloride | 47.84 |
| Potassium chloride | 3.41 |
| (between 3.20-5.50% KCl.) | |
| Sodium tetraborate | 2.83 |
| Sodium sulphate | 16.42 |
| Sodium carbonate | 29.21 |
| Silica and alumina | 0.24 |
| Calcium carbonate | 0.13 |
| Magnesium carbonate | 0.07 |

As a rule there is about 50 to 100% more KCl in this 'spent water' than in the lake water.

In warm weather and under good supervision, the crystallizing of the soda takes place in such a way that the spent water will contain more chloride of sodium and potash, and less carbonate, than indicated by this analysis.

Solar heat is used to concentrate the liquor, to produce a potash salt of a higher percentage and to remove the main part of the other constituents.

It might be mentioned that the extraction of potash can be profitably done only as a by-product where soda is made as the main product, otherwise it would not pay.

To save fuel, the spent water is therefore run in vats or ponds, exactly like those used for concentrating the lake-water and crystallizing soda, or for manufacturing crude sea-salt. In these vats, it is exposed in layers of a few inches to over one foot to the heat of the sun and the dryness of the air prevailing around the lake. There is a system of vats, arranged in such a way that the liquid after partial evaporation can be withdrawn from the crystallized salt crusts. This fractionizing or working in phases is very important, as, with changing temperatures and other conditions, the liquid may act again on the salt crusts and may even cause a loss of potash. The purpose of the evaporating and crystallizing process is to enrich the mother liquor with potash as much as possible, and to get out the other salts as free from potash as possible. Artificial heat is not necessary for this evaporation, and the only running expenses are a part of the wages paid to an employee attending to the vats in connection with the supervision with the soda-crystallization, and for pumping.

The first fraction of crystallization of the spent water

is an impure carbonate of soda and the liquor is allowed to remain on the soda crusts until cubes of sodium chloride just begin to crystallize out. There is no difficulty at all to note the end of this phase, and the liquor is then conducted to another vat. The remaining carbonate crusts can be re-crystallized as they are comparatively pure, although hardly reaching a minimum of 96% Na_2CO_3 after grinding and heating. The solids of this liquid contain at this point about 6% and even more potash salts, and the liquid spindles about 35° B.

Then the crystallization of sodium chloride sets in and thick crusts of this salt, very often in big beautiful cubic crystals, are formed on the bottom. This salt, of course, contains some carbonate and a little borate of soda, which, however, can be easily removed, if it is desired to purify the salt. When the salt precipitations, as far as the conclusion of this phase, cease, the appearance of the vat becomes different. The liquid must be drawn off again, as soon as fine silky crystallizations, consisting of carbonate, sulphate, and some borate begin to float on the surface.

In colder weather more sulphate is precipitated than in warm; as a rule, it might be said that this salt mixture contains between 60 and 70% of sodium carbonate on a dry basis. Sometimes small precipitations of sodium chloride occur and the Beaumé hydrometer indicates the changing specific gravity of the brine during this evaporation. As a rule, the highest density is 39-39½° B., and then the liquid becomes lighter, sometimes suddenly several degrees, then heavier again, however keeping under the high mark. To follow the varying degrees of aggregation of ionic dissociation in this solution, and the varying degrees of ionic concentration in the brine, indicated by the varying composition of the separating salts, is very interesting. Sudden precipitations from over-saturated solutions make this process theoretically rather a complicated one. This might cause difficulties in separating the potash from other natural brines.

A chemical control, of course, is necessary to see that no potash precipitates. Under the conditions prevailing at Owen's lake, there is no danger of losing potash from the liquid by crystallizing out, until the solids of the liquid contain at least 40% potash salts, when the process is conducted with skill.

The solution that contains sulphuric, carbonic, some boric, chlorine, potassium, and sodium ions must then be evaporated to dryness in a separate vat. The salt crusts thus obtained are now completely dried out by artificial heat and then ground. Of course, by more complicated processes the potash salts can be purified further.

The whitish potash manure salt represents a mixture of the carbonates, sulphates, and chlorides of potash and soda in varying proportions; it is free from the chloride and the sulphate of magnesium, an important advantage against some of the Stassfurt products.

When employed by the Inyo Development Co. as their consulting chemical engineer, I, having had a long

experience in the Stassfurt (Germany) potash mines and factories, as well as an agricultural chemist, suggested taking up the manufacturing of potash manure salts. Despite many failures of other concerns to create a potash industry in the United States, A. B. Davis, general manager of the Inyo Development Co., took up my proposition, and he deserves the credit of promoting the first manufactory of potash salts in America from natural brines. An experimental plant was erected this year, the results being entirely satisfactory. The first run produced potash salts running 20.41% potassium chloride, the second run 29.40%, and the third run 34.05%. These runs were made late in the season after the weather began to get cool; if they had been made when it was warm, the results would have been much higher. This experimental plant will now be extended, and the making of this American potash, on a commercial basis, will take place on a larger scale. Possibly the manufacture of purer potash salts will follow later.

C. V. ELSENER.

1169 Geary street, San Francisco, January 8.

Small Machinery

The Editor:

Sir—I think the articles in your issue of October 23 last, on the 'Psychology of Advertising,' are timely, and your stress upon the importance of the buyer's side is much to the point.

It is nearly 40 years since I entered a copper smelter to hold a very junior position, and nearly 30 years since I took a hand in the management of a mine, and all that time I have been reading advertisements and, directly or indirectly, purchasing mine supplies; so I have had a little experience. What I have found is that advertisers do not advertise what I want, which is something fitted for a small mine.

The bulk of the examples illustrated and described are the latest and largest of their kind. One would think, from reading advertisements, that no mine exists whose output is less than 1000 tons per week. The big winding-engine to hoist from 5000 ft., the big crusher to put through 250 tons per hour, and the big locomotives are very interesting to hear about and to see, but there are not many men who are likely to want them.

It is the same when one writes for quotations: ten to one, the replies are all for huge machines, and when one asks for something smaller, the curt reply makes one feel a very small potato indeed.

Some time ago I had occasion to investigate two new technical processes, and asked for estimates, etc. One made no reply—evidently we were beneath notice—the other sent an estimate for an output of 20,000 tons per month.

Now, putting America aside (where, I presume, there is nothing small even among mines) our country, Australia, is a big place, with famous and widespread mineral deposits, but how many mines are working whose

output is a regular 1000 tons per week? I venture to say, very few; and yet there are hundreds of mines needing machinery and supplies.

The average man is still somewhere about 5 ft. 8 in. in height, and about 140 lb. in weight, and the present War shows he is still the main factor, and not the 16-in. howitzer with its 20-mile range, and surely the day of the small mine is not gone? If it has, as our advertisements would lead us to think, then we have far too many colleges of mines, institutes of engineers, and technical journals, especially the latter.

But I venture to predict that the small miner is still worth the machinery-maker's courtesy and attention. Instead of always putting the big machines in the front, I would suggest that the small machines be the regular exhibit, and that the big fellows be used only for an occasional show, as the pride of the factory.

EDGAR HALL.

Silverspur, Queensland, December 14, 1915.

[We like to have opinions such as this, from buyers of mine supplies. As to the criticism that America has time only for big things, we are pleased to state that this megalomaniac tendency is fast decreasing, and our business firms are rapidly recognizing the desirability of courteous treatment for all customers. The small buyer of today may be the big buyer of tomorrow; furthermore, the small man talks more than the big buyer, and is at once a strong friend of the firm that treats him well and a vindictive disparager of the company that is inclined to be contemptuous of an order for a couple of rock-drills or a half-dozen cases of dynamite. Large mining companies, accustomed to being pointed to as typifying standard practice, are apt to buy machinery at enthrone prices, because so many dealers are anxious to have their name-plate at the big plant. Generally speaking, a dozen orders at \$1000 each from small operators will bring more profit than a \$15,000 order from a large company.—EDITOR.]

An Unusual Head-Frame

The Editor:

Sir—Relative to P. B. McDonald's article on head-frames in your issue of December 25, the enclosed photograph of a head-frame that I erected for the Fremont gold mine in Amador county, may be of interest.

It is seen that the shaft is an incline and that the cable, as it leaves the sheave, goes to a hoisting-engine situated on the hanging wall. As a matter of fact the hoist is on a hill at a relatively high elevation above the collar of the shaft. The resultant of the pull on the sheave, being between the two lines indicated, lies at a difficult angle to counteract. The pull tends to tip the head-frame over. As it was impossible to provide against this pull by the back-brace, on account of the flat angle of the resultant, I resorted to the expedient, now not uncommon in the building of high head-frames, of anchoring the front legs securely to heavy concrete foundations. The front legs of the structure, that is the two legs on the

foot-wall, are in tension when hoisting takes place. The head-frame is of the so-called A type, and all four legs are battered. It is entirely of steel, although the central structure containing the ore-bin, waste-bin, and crushing plant, is of wood. However this wooden tower is

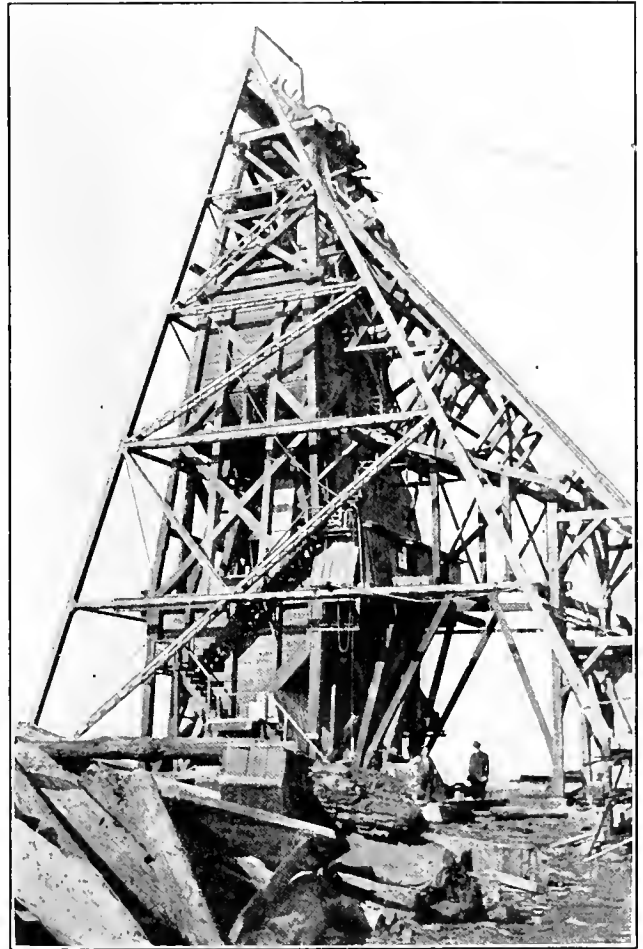

THE FREMONT HEAD-FRAME.

entirely separate from the head-frame, so that vibration or settlement of the structure does not affect the steel. The head-frame was designed on the basis of being able to withstand a load equal to the breaking strength of 1½-inch plow-steel cable; it is 92 ft. high from the collar of the shaft to the centre of the sheave.

J. R. CAHILL.

San Francisco, January 13.

Another, and Earlier, Ball-Mill

The Editor:

Sir—As a further contribution to your "ancient history" communications relating to the genesis of the more modern forms of machinery for ore reduction, I beg to submit the following:

In 1863 I designed and superintended the erection of a mill at Black Hawk, Gilpin county, Colorado, for the treatment of gold-bearing sulphide ores of that region by pulverizing and roasting, followed by amalgamation.

The ores were broken by a Blake crusher, and then

ted to a Howell mill, named after its patentee. Briefly described, it was a strongly built fan blower, with steel-shod arms to the rotor. It had heavy removable corrugated cast iron rim within the casing of the machine, to receive the impact of the ore thrown against it by the rotor. This mill received the ore from the Blake crusher at the open centre, corresponding to the inlet of a fan-blower. The rapidly moving rotor arms beat the ore back and forth within the casing; and as it became sufficiently fine it was carried from the mill by the air current caused by the rotor, as would be the case with a fan-blower, with this exception: the rotor moved the reverse way from that of a fan.

This was, as far as I now know, the first of the type of 'hammer' or 'beater' mills, now in some considerable use in dry pulverization of minerals softer than the general run of ores.

While the rapidly revolving steel-shod arms pulverized the ore satisfactorily as to size, quantity, and power, the wear and tear and delays due to replacement of worn parts made their operation too expensive.

So, in 1865, I set my wits to work to devise something better. I had heard of a drum, containing iron balls, which was charged with a batch of ore and run until the ore was sufficiently fine; and then it was emptied and charged again. Whether this was the Lundgren pulverizer, described by J. Ross Browne in 1868, I do not know; the name having passed from my memory.

I liked the principle of the machine, but not its application to requirements. I needed something to work continuously, not intermittently. Remember that Black Hawk was then over 600 miles from any railroad, and that all freight was mule or ox-drawn. But the foundry and machine-shop of Langford & Marshall, at Black Hawk, had scrap-iron from poorly designed and unnecessary machinery, bought and sometimes erected to treat supposititious ores from 10-ft. shafts of so-called mines. These were times that tried the miner's soul. Failures were constantly calling for other devices to be substituted as makeshifts. Something had to be done. The mill was idle because the last 'Howell' had finished its windy howl and beaten itself to dissolution. But the remains were sold for scrap—from which to make other things.

With the active co-operation of John W. Nesmith, then the superintendent of the Langford & Marshall foundry, and afterward president of the Colorado Iron Works, of Denver, the ball-mill was constructed as follows: Two circular cast-iron discs, four feet in diameter, for the heads, were mounted, three feet apart, on a steel shaft. For staves for this drum, or barrel, wrought-iron bars $\frac{1}{2}$ by $2\frac{1}{2}$ inches were used. Each bar was spread by forging at the ends and in the middle, for the length of an inch, to measure at those points $2\frac{1}{2}$ inches. They were then bound on the heads and at the middle by three hoops of iron. Thus there were openings of $\frac{1}{2}$ inch between the staves.

One end had a circular opening around the shaft through which the ore could be fed. The other head

was closed; but each head had a hand-hole with a suitable cover, which could be removed at will, to give access to the interior of the drum. The drum was mounted in suitable bearings for the shaft, and on a wooden frame, provided with a wooden casing to confine dust. A gear-wheel on the drum shaft, and pinion mounted on a counter-shaft with a pulley, furnished means to drive the drum at the speed of about 21 r.p.m.

When this installation was completed, about 1000 lb. of chilled cast iron balls was put into the drum, and the trial began. The ore so ground flowed from the mill through the spaces between the staves. From the bottom of the casing, which was hopper-shaped, a screw conveyor moved the crushed and ground ore to a revolving screen of 30-mesh wire-cloth. That which passed through the screen went to the roasting-furnace, and the coarse material flowed back with the feed to the drum.

This device apparently worked perfectly from the start, to the extent of grinding one ton per hour for a few days. Then we observed that its hourly output decreased day by day until but one-quarter of a ton hourly was all we could produce. Examination showed that the staves had been worn until they were so smooth that they slipped under the charge of ore and balls, instead of being lifted so as to cause the balls to fall to impact the ore.

We overcame this defect by removing some of the flat staves, and placing about 12 of them at regular intervals between the other staves at right angles thereto; so they projected from the inner sides of the staves radially toward the shaft. These formed barriers to prevent sliding of the drum under the load; and, further, to lift the balls and ore to a height that they might beat upon each other as they moved downward on the ascending part of staves. The mill then was more efficient than at the start.

But another trouble arose: The chilled cast-iron balls proved too brittle for the work, and broke rapidly. After trying cast-steel balls, wrought-iron balls forged from old shafting by hand and sledge-hammers, and swages, proved successful; and wore to 1-in. diameter, keeping their spherical form up to the periodical times for their removal from the drum. These small balls were mixed with pebbles of flinty quartz and used in a lengthy rotating cylinder to pulverize the roasted ore. But that is another story.

N. S. KEITH.

Philadelphia, December 21, 1915.

COSTA RICA has an area of 23,000 square miles, which is a little less than that of West Virginia. The population is 411,000, of which 55,200 are in San Jose, the capital. The total debt of the country is \$17,000,000, of which nearly half is held by English interests and the remainder mostly French. Money-order and parcel-post service exist; the custom regulations give facilities to imports; foreign patents and trade-marks are well protected.

Research Problems

By Will E. Coghill

INTRODUCTORY. How often we hear a mining engineer remark that he has certain theories about certain phases of some particular branch of his profession and that some time he will investigate. Time passes and the theories are never tested, while so many young men in the mining schools are wondering where they will get the problems for their thesis.¹

If all unfinished problems were made public some one might find something among them that would make a special appeal and by a further investigation be able to produce results that would be a contribution to science, if not of commercial value. It is with this in mind that I submit the following 'near processes.'

WET DESULPHURIZATION AND FLOTATION. To my knowledge, outside the work of the Nipissing, very little has been written regarding wet desulphurization.

About the effectiveness of the nascent hydrogen liberated by the caustic soda and aluminum in decomposing silver minerals there is no question. But other minerals are included in the category. And here is where the process may be balked entirely. It is very likely that in making the maiden attempts with wet desulphurization at the Nipissing they happened to hit upon the most fortunate sample possible. I tried it on an oil-flotation tailing. After 10 minutes of agitation the sheets of aluminum were covered with a nasty black paste. The natural inference was that this was caused by the oil that had remained in the tailing. In order to force the test to completion aluminum impellers were used on vertical revolving shafts for agitators. The same deposit formed. Coarse sand was then placed in the bottom of the containers to act as a scouring agent, and, after con-

siderable effort, the test was put through, and it was found that the silver, which was otherwise refractory to cyanide, dissolved readily after desulphurization. The black deposit was then collected and tested. No trace of oil could be found, but a large percentage of lead in its stead. As some sulphur was also present, the first impression was that it was a sulphide or sub-sulphide of lead. Galena was present in the tailing but if native PbS were converted into artificial PbS in one step it meant a new bit of chemistry. That was hardly probable. After a lapse of several months wet desulphurization was again tried; this time on a slightly oxidized lead-zinc ore. The same black mess appeared in large quantities. This ore had not yielded its lead freely to oil-flotation.

About this time I had a stock of galena on hand that had been given a sulphate coating by roasting. Directed by something other than scientific reasoning, I put some of this into a caustic soda solution with sheet aluminum. A thick deposit formed on the aluminum and the solution was soon clouded with a dark-brown colloidal substance. The dilemma had passed. Of course $PbSO_4$ is decomposed, forming Pb , H_2O , Na_2S . This was corroborated at once by pure $PbSO_4$ giving a mass of spongy lead. The sulphated galena had not floated easily by oil-flotation, but after brightening it by wet desulphurization it floated freely.

Cerussite ($PbCO_3$) is readily decomposed by this process and spongy lead is deposited on the foil (these tests can best be made in test-tube). I think anglesite ($PbSO_4$) acts in the same way, though I could not get a good specimen to test. My impression is that by this method one can detect the slightest amount of oxidation of galena (fresh galena is not decomposed), and that if in flotation work, galena is escaping, the tailing should be panned and the galena tested for a sulphate coating. I used galena that was very slightly oxidized by dilute sulphuric acid, and got a distinct reaction. Aside from being an aid in determining the character of an ore it is not impossible that some day wet desulphurization might be worked into the flow-sheet of a flotation plant. The Nipissing² charges off 0.54c. per ton to desulphurization and gives a 12-hour treatment. Oxidized galena could probably be brightened in two hours with the same strength of solution if the deposit of lead on the aluminum did not prove to be a nuisance. I thought at one time that I had a method worked out that would prevent the deposition of sponge lead on the aluminum, but have never concluded the experiments.

¹Possibly the fourth-year man in the mining school should not do a thesis. For my part I would like to see the thesis thrown out of the curriculum of the fourth year. The ideal research problem is the one that the investigator has met 'face to face' on his own initiative, and it is only under such circumstances that he gets the proper inspiration for original thinking. The parent spends about \$500 for the son's fourth year in school only to have him thrown on his own resources, when, in fact, he has none and cannot be expected to have, and he flounders around for weeks to do work that should be done in a few days; and in the end he is deceived into thinking that he is qualified to go out and take a 'position' when in fact he should have only a 'job.' On the job he will have plenty of opportunity to develop initiative, and it will be more likely to develop if the instructor will take the thesis period and give him careful instruction on the 'known' instead of pushing him out into the 'unknown.' So often we hear that the prescribed course has not room for this and that. If the thesis period were eliminated there would be more time. Of course, the man learns something while on his thesis, but I believe he would learn more in school and be better prepared to step from a 'job' to a 'position' if the instructor gave him more of his time in the fourth year.

²J. J. Denny, MINING AND SCIENTIFIC PRESS, Sept. 27, 1913, Page 488.

HYPO-SULPHITING. I picked up the statement in one of the old volumes of the transactions of the A. I. M. E. that freshly precipitated silver sulphide dissolves instantly in the Russell extra solution $XCu_2S_2O_3, YNa_2S_2O_3$. This seemed to suggest a way out on an ore that had proved refractory toward cyanide on account of the copper and silver being chemically combined. Knowing that wet desulphurization would decompose the copper-silver mineral, throwing down cement silver, and being aware also of the avidity with which sodium sulphide attacks silver, making silver sulphide, it seemed quite possible then to dissolve this freshly formed Ag_2S in extra solution upon a few minutes agitation. Fully aware that the extra solution is awkward to handle as compared with a cyanide solution, the idea of a nearly instantaneous dissolution of the silver, where the copper could not interfere, seemed attractive.

A specimen of pyrrargyrite was therefore selected, crushed through 200-mesh, and mixed with sand to make an ore assaying 24 oz. silver. It was given the wet desulphurization treatment, washed, and then an hour's agitation in a closed jar with a 1% solution of Na_2S . After washing, it was agitated in the same manner with a 1% extra solution. The periods of agitation in hypsulphite varied from five minutes to two hours, and the percentage extracted varied from 25 to 40; the five-minute treatment in some cases being as effective as any. The probabilities are that all of the Ag_2S that was formed did dissolve instantly according to the original premise, but that it existed only as a coating on the particles of cement silver, and as soon as the coating was dissolved the dissolution ceased. Or, on the other hand, it is possible that the copper which replaced the silver when the silver went into solution formed an impervious coating on the sulphidized silver. If the latter portion of the silver had proved as soluble as the former the dissolution of the silver would have been as simple as the old style trough-lixiviation, but, under the circumstances, the scheme had to be shelved.

CARBON IN CYANIDE SOLUTION. I read with a great deal of interest the articles of Messrs. Feldtmann and Ralston on the precipitating power of charcoal and graphite in cyanide solutions. They concurred in the opinion that "an explanation of how and why the gold is precipitated by charcoal will throw light on the action of graphitic schist," and that "the gold-bearing ions are doubtless adsorbed in the charcoal;" and also that it was pretty thoroughly demonstrated that gold entered "the pores of the charcoal." Whether a solution enters capillary tubes or cleavage-planes or planes of fracture caused by crushing, the phenomenon is plainly one of capillary action (capillary action can be demonstrated as well by two plain plates of glass set close together, as by a capillary tube).

Now, the capillary rise in a tube is merely one of the manifestations of the forces acting in the surface of a

liquid and known as 'surface tension.' We can therefore attribute the penetration of the pores of the charcoal to surface tension. If the pores are penetrated by a solution containing gold bearing ions, and if by reason of some chemical reaction (the writers discussed the reactions) these ions cease to exist as such, others would follow at once, as the consequence of diffusion. So I reasoned that in order to check precipitation of gold by charcoal one would have to reduce the surface tension of the solution. Amyl alcohol was chosen as the auxiliary reagent on account of its phenomenal effect in this regard. I duplicated Feldtmann's experiments as nearly as possible, using 200 cc. of solution, titrating 2 lb. KCN, 0.5 lb. CaO and assaying 9.63 mg. gold per 100 cc. The charcoal was crushed to 10-mesh and 10 gm. was used in each test. For the first trial two tests were allowed to stand for 24 hours side by side, one with and one without amyl alcohol. The alcohol was added to make a 2.4% solution, which, disregarding the effect of cyanide and lime, would reduce the surface tension of the solution from 71 to 26.⁴ The amount of gold precipitated per 100 cc. was 9.23 and 7.88 mg. in the non-alcoholic and alcoholic solutions, respectively. The difference was not great, but sufficient to give encouragement. From the amount precipitated, it seemed that the tests had stood too long, and since beakers were used which probably allowed a great evaporation of the alcohol, the tests were repeated in closed flasks and allowed to stand only 14 hours. Gold was precipitated to the extent of 8.91 and 5.56 mg. or 93 and 58%, respectively. The approximate surface tensions in the same order were 71 and 26. (I took the precaution to compare the dissolving rates of the alcoholic and non-alcoholic solutions on gold foil and found that there was no difference).

The results make me feel that my theory—that the precipitation of gold on carbon can be controlled by the control of the surface tension of the solution—was correct, though I realize fully that I have not presented enough evidence to claim a proof.

Probably the largest repair job by means of oxy-acetylene was recently made at Chicago by the Oxweld Acetylene Co., when a gyratory-crusher spider weighing 40 tons was mended. A piece weighing 10 tons broke off, and a new spider would have cost \$2300. The break was chipped out and 900 lb. of new metal had to be welded in. This work occupied two men per shift for 60 hours continuously. The hub was kept warm in a fire during this period to take care of expansion and contraction. After the job was finished the repaired spider was covered with sheet asbestos and allowed to cool gradually. Much expense and time was saved by this weld.—*The Excavating Engineer*.

OREGON has an area of 96,030 square miles, which is over twice that of Pennsylvania. Its population is 800,000, having doubled since 1900. Baker county produced \$1,500,000 in gold in 1915.

³W. R. Feldtmann, MINING AND SCIENTIFIC PRESS, May 22, 1915, page 791; O. C. Ralston, MINING AND SCIENTIFIC PRESS, July 17, 1915, page 77.

⁴Morgan and Neidle, *Jour. Am. Chem. Soc.*, Dec. 20, 1913.

Mining in Ecuador

By J. W. Mercer

INTRODUCTION. It is difficult to write on this subject when there is, in all of the Republic, but one mining enterprise in actual operation, namely, the gold mines of Zaruma in the southernmost province.

It has been said that Ecuador is poor in minerals. True, it is almost undeveloped and not at all known, but there are many evidences of mineral wealth. How can a country be explored and developed without roads, to say nothing of railroads? Senators from the extreme eastern provinces, wishing to attend the session of Congress at Quito, instead of ascending the rivers and crossing the mountains, deem it preferable to take steamer down the Amazon to the Atlantic ocean, travel by steamship to Buenos Aires, thence across country and high mountains to Valparaiso, up the Pacific to Guayaquil, and thence by rail to the capital.

THE COUNTRY. Ecuador extends north and south along the Pacific more than 300 miles, and eastward about 500 miles across the Andes to the tributaries of the Amazon, an area of 116,000 square miles. The population is estimated at 1,500,000, but there has been no census. In the larger cities and the coastal region a mixed race predominates, the Spanish-Indian, but in the inter-mountain region the population is almost entirely native Indian. Of course, there are many direct descendants from the Spanish, and also foreigners from other countries.

The seaports are Guayaquil, Bahía de Caraquez, Manta, Esmeraldas, and Puerto Bolívar, in order of importance. Guayaquil, situated 830 miles south from Panama, on the west bank of the Guayas, 35 miles north from the Pacific ocean, claims a population of 75,000. Quito, the capital, in the mountains, 300 miles northeast from Guayaquil, has about 60,000 people.

Ecuador is served by three steamship lines running between Valparaiso and Panama, one of which conducts a coasting service between Guayaquil and Panama. River-steamers ply on all the large rivers, connecting the small towns and plantations with Guayaquil. The Panama Canal puts Guayaquil within eight days of New York.

The Guayaquil and Quito narrow-gauge railway (a New Jersey corporation) is the only railroad of any extent being operated. A number of other railway projects are under consideration, and some under construction. The greater part of Ecuador is inaccessible and undeveloped, because it lacks not only railroads but wagon-roads.

Tributary to the coast and extending 50 miles inland

from the ocean to the foothills lies the richest part of the country. The river Guayas, flowing from the north through the bottom-lands, empties into the large bay of Guayaquil and furnishes convenient transportation. These river-lands are rich and can grow all tropical products. Ecuador's great wealth is in *cacao* (chocolate); the total weight of this material harvested in 1914 was approximately 100,000,000 pounds. The lowlands produce many other articles of commerce, but next in value is the *tagua* (ivory-nut) and the *toquilla* (panama-hat fibre). Ecuador also produces coffee, rubber, sugar, tobacco, rice, coco-nuts, bananas, oranges, and pineapples. Aside from the coastal lowlands the country is mountainous and little developed, yet the many fertile valleys yield all the temperate-zone cereals, vegetables, and meats; excellent potatoes, wheat, rye, barley, beans, peas, alfalfa, cattle, sheep, and hogs. Altitude compensates in climate for what the country lacks in latitude.

The timber of Ecuador is not well known. It is claimed that there are many varieties of useful hardwoods within the coastal lands, but in the interior it is scarce. The gold mines at Zaruma obtain many varieties of soft woods, including cedar, cinnamon, etc., but they do not endure long. Hardwoods are scarce and far away. The soft woods may endure if kept from the air, but if subjected to air and moisture, they decay rapidly. Mine-timbers last only from one to two years. Boring insects play havoc in the wood-work of buildings. The timber from the coast cannot be used owing to lack of transportation.

In the matter of industries there is little to say. Every large city has a brewery and there are a number of small businesses in various places, such as flour and cotton mills; the manufacture of panama-hats is an extensive industry, it being done by hand; also there are a number of important sugar-mills.

GEOLOGY AND MINERALS. The immense uplift of the Andes throughout the entire length of Ecuador has furnished a vast area for the prospector, but for many reasons the country is difficult of access. Lack of roads and railroads leaves the inter-mountain region remote and inaccessible, and the fact that the north-central part is covered with volcanic ash and that a large area in the south and east is covered by a dense growth of trees and jungle makes it almost impossible of exploration. The vicinity of Mt. Cotopaxi offers an interesting exhibit of various periods of eruption. In many places where the soil has been deeply cut by rivers and railway-grades there are several layers of volcanic ash alternating with layers of black loam. In places the ash is 6 ft. and the black loam 3 ft. deep. It is noticeable that the thickest

*Contributed by the author. A paper also read before the Pan-American Scientific Congress, Washington, December 1915.

beds of ash are opposite the volcano, while 25 miles away the layers thin to a few inches and are much finer in texture. In the tropical and semi-tropical reaches of the mountains, the rapid oxidation, disintegration, and erosion, followed by dense floral growth, have so changed the face of the earth that it is impossible to know what lies beneath. Even in the vicinity of ancient mine workings it is seldom possible to find the bottoms of the excavations exposed.

I believe there has not been any geological study since that of Dr. Theodore Wolf, therefore little can be said about the mineral possibilities of Ecuador. Iron ore in workable quantity has not been discovered, neither have any important deposits of lead, zinc, or copper, although the latter is known to exist in several places.

Oil is now being found in the lands along the coast west from Guayaquil, in the district called Santa Elena. It was discovered by the earliest voyagers, and Dr. Wolf in 1892, made a report on it to the Government. Since then a small extraction has been made from the superficial capping. In 1912, an exploratory bore reached a depth of 2000 ft. with negative results except in the superficial area. In 1913 the production was at the rate of 10,000 to 20,000 bbl. for the year, being used locally as fuel for furnishing power. There are two grades reported by recent analyses: *a*—Green oil, 24-28° B. *b*—Black oil, 18-19° B at 60° F. Both are low in asphaltum, gasoline, and kerosene, and high in fuel and lubricating stock.

Coal exists in various places, a low-grade lignite, high in ash and volatile matter. In the provinces of Azuay and Loja some wide seams have been discovered, but as yet they have not been tested adequately.

Mercury has been discovered in the province of Azuay. Silver was mined by the ancients and particularly in the district of Pillsum, province of Cañar. In 1891-'94 an attempt was made to explore these mines, and some ore was shipped to foreign markets, but they were abandoned, probably for lack of capital and means of communication.

Gold is the only metal being produced in any quantity. I am unable to procure close figures as to the amount produced from the small placer work of the Indians, but I am supplied with the figures for the vein mining, and I believe we may estimate the total annual production at \$600,000.

Gold probably exists in all the rivers on both sides of the mountains. The Indians wash the gravels in many places and bring it in small quantities, to be sold to the merchants and banks. Particularly do they come from the mountain tributaries of the big rivers on the east side of the main watershed. I believe the Napo river and its tributaries at present contribute a small amount and that not far from the city of Cuenca, in the district known as Sigsig, the Indians wash out coarse gold and sell it in the large towns, but it is said that the whites are not permitted to enter that district. Again, in the extreme south-east some small amount of gravel-washing is done. Also near the north-west coast in the province

of Esmeraldas a United States corporation conducted some placer development about ten years ago, but this work was discontinued; it was said that the gold could not be recovered. Platinum has been reported in the gravels of some of the rivers in the north west. In the province of El Oro, in the district of Zaruma, the river-gravels contain small quantities of gold, but it is usually flaky and light and the gravel extremely shallow.

Tradition has it that in many parts of this country, the veins contain gold in fabulously rich pockets. This has been assumed because of the vast quantities of plate, images, and ornaments of gold found in the possession of the natives by the Spanish conquerors. However, it is not likely that there existed great treasure-houses where the gold could be chiseled out in chunks, but it probably came from a long period of small gains. The Spaniards operated haciendas and employed their slaves, when not engaged in agriculture, in working the mines, and also no doubt there were many independent natives washing the ores and gravels for small returns. The vast quantity of gold possessed by the natives at the time of the Conquest, used as plate and for ornaments and temple decorations, probably came from small accumulations over centuries.

Gold-bearing quartz veins exist in the mountains in many parts of Ecuador, but the only ones now being developed are those in the district of Zaruma in the province of El Oro. History tells us that soon after the Conquest the Spaniards discovered the natives working important gold mines, and founded several towns because of the mines. The principal ones were Zaruma, in the south in the province of El Oro; Zamora, in the south-east in the province of Loja; Sevilla del Oro and Logroña del Oro, both in the central part of the Republic.

After the Spaniards founded the towns of Zamora and Sevilla del Oro, the native Indians joined together in great numbers, overpowered and massacred all the foreigners except the women and children, whom they carried away into captivity. In various histories it is stated that the Spanish governors were exacting exorbitant taxes, requiring the Indians to bring in large quantities of their gold, presumably to be sent to the Spanish Crown; after this had gone to a point where they would not longer endure it, the Indians organized and swept in one night upon the sleeping Spaniards. One account is that to punish the Spanish Governor-General they killed him by pouring molten gold down his throat, stating that they hoped he would be satisfied.

We often hear of discoveries in the eastern provinces among the big rivers that help to form the Amazon, but that entire region east of the Andes is without adequate roads. A north American prospector recently reported the discovery of a large quartz vein which he estimated would assay 1 oz. in gold per ton. This was on the lower Napo river, and in order to reach Quito he had traveled three weeks, mostly afoot.

MIXING. The mining laws of Ecuador are fairly liberal. A pertenencia or lode mining-claim is 200 by 600

metres, containing twelve hectares, or thirty acres. It is acquired by location and held by the payment, in advance, of an annual tax. This is equal to \$5 in United States money for claims not in exploitation, and \$25 for claims in exploitation. If the possessor should fail to pay his taxes during the month of January he may still redeem the property by paying a double tax the month following. If he should cease to pay taxes for any length of time, the property becomes subject to auction-sale for the benefit of the Government, at which time the original owner is allowed the first opportunity to buy in, by paying the back taxes and the penalty. Mining machinery and supplies are admitted into the country free of duty. Likewise the product of the mines is not charged any export duty. There are no smelting works or mints, and at present Ecuador has no means for the purchase and coinage of gold bullion.

GOLD MINING AT ZARUMA. This district is in the extreme south in the province of El Oro, 150 miles from Guayaquil. The latitude is 3°45' south, the longitude 82° west, the altitude from 2000 to 5000 ft. above sea-level. It is reached by steamer to Santa Rosa, thence by mule-back for 45 miles.

It was just before the middle of the 16th century when Francisco Pizarro and his associates went by boats from Panama to Ecuador. After discovering the Gulf of Guayaquil, and conquering some 50,000 Indians on the island of Puná (now with a population of only 100), the first headquarters was made at a point where now is situated the town of Tumbez, at the mouth of the river of the same name, near the boundary between Ecuador and Peru. This river empties into the gulf near its southern end, its source being 125 miles east. Amid these rivers and hills lies the mineral district of Zaruma. During the first years after the Conquest the adventurous Spaniard ascended the river in search of the origin of the gold found in the gravels, until, arriving at the heart of the Zaruma district, he found native Indians engaged in washing gold from the outcrops of large quartz veins. Here, in 1549-'50, he founded the town of Zaruma, the present seat of the canton, now a village of 800. The famous road built under the rule of the Inca passes not far from Zaruma, and here may still be seen stretches of the original stone pavement. Here they began mining for gold, and subsequently explored and worked veins over a large area not now defined in extent, but at least 15 miles long north and south by 5 miles wide. One may still see the marks of caves denoting a vast number of old workings, now filled with water or covered with a tropical growth.

Entrance and exit were by shaft, adit, and incline, and the ore was carried out on men's backs. They probably took out the rich streak and left standing the low-grade quartz, filling back under-foot the broken waste, occasionally leaving a pillar of vein-matter. Seldom is high-grade ore found standing, and it is impossible to sample the bottom of the workings because of the accumulation of filling and mud. Work evidently ceased at the water-level, where oxidation ended. The bottom of the oxidized zone is usually 100 ft. beneath the surface, but the greatest of the ancient mines undoubtedly reached a depth of 300 ft. The only tools of metal ever found are some soft-iron bars. The ore was treated by grinding and washing. A vast system of ditches and reservoirs spread over the district and many a large out-

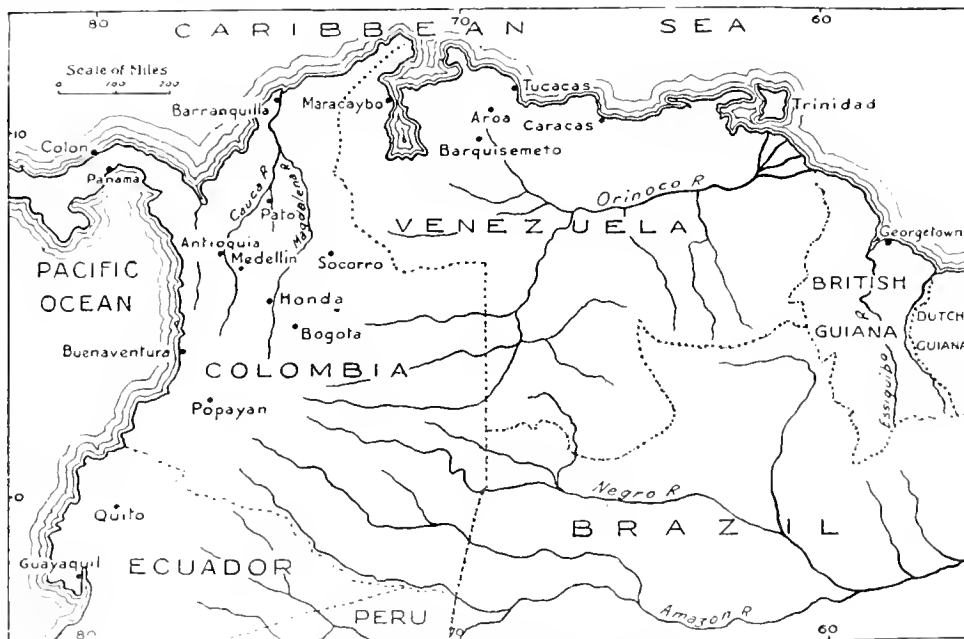

MAP OF PART OF SOUTH AMERICA.

crop shows signs of washing. Hundreds of stone shoes and dies of the little two-stamp mills have been found in the soil, and there are also visible the beds of old arrastras. The stamp-mill consisted of two stamps; the mortar was a wooden box of the size of the modern candle-box; the die an oval boulder having on its upper side two cupped-out wells, into which dropped the stone shoes, smaller boulders with the upper end sharpened to a neck. This neck was driven into a wooden boss-head, tapered to form a stem on which was a wooden spike to serve as tappet. The cam was operated by an overshot water-wheel. The principle is that employed today in our gravity stamps, with steel replacing the stone. After stamping they probably panned the free gold.

In 1815 Spain sent an agent to Ecuador, who reported that many mines were being worked, but after the War of Independence it almost ceased for a long time. In 1876 Dr. Wolf made a study of the district and published a short description in 1879. In 1878 mining men came from Chile and Peru to make the first denouncements (locations), and in 1880 the Great Zaruma Gold

Mining Company was organized in London. Two years were spent in road construction and attempts to introduce large machinery, but not having finished the road, and the machinery being too heavy for mule back, it has lain abandoned at tide water ever since. In 1883 the English company's manager joined the Salazar revolution and was killed at the gates of Quito. Between 1883 and 1887 the English company raised additional capital, worked the mines, and made some shipments of gold. In 1887 it was liquidated and a new corporation, calling itself the Zaruma Gold Mining Company, was organized to continue development. In 1889 French capital investigated the district, but discontinued work the following year. In 1895 the English company abandoned the district entirely, their failure being due probably to lack of improved metallurgical methods and adequate means of communication with the coast. In 1897 a company organized in the United States, took over the properties and is still operating.

The geological structure of the district has not been accurately determined, but it consists mainly of large flows of andesite, dacite, rhyolite (some porphyritic and some brecciated), lying on the mica-schist that appear at the south end. This area has been extensively faulted and intersected by veins of quartz and calcite, all of which probably contain some gold. In the country-rock a few pyrite crystals are found, while near the veins this mineral is more plentiful, and within the veins there is often a heavy mineralization by pyrite, chalcopyrite, blende, and galena. The quartz veins often reach a thickness of more than 15 ft. and in some places many large veins lie parallel, forming a great mountain of quartz and country-rock, with here and there ancient workings. On the surface the country-rock decomposes rapidly, resulting in yellow and red clay. Ridges often indicate quartz and many of the canyons are worn deep by decomposition and water. The area described is literally peppered with ancient workings and in most places where recent development has penetrated beneath ancient mines, workable ore has been found.

As already explained, the country is andesitic and is cut by several large north and south faults and numerous cross-faults. One large fault passes through the centre of the district, having a course a few degrees west of north and dipping 70° east. It may be traced for several miles with ancient mine-workings along it. This fault frequently makes orebodies composed of quartz and calcite. Coming into, but not found to cross it, are large quartz veins with a strike north-east by south-west and a dip to the east of 70° or steeper. Large orebodies make at the junctions. Numerous cross-faultings occur, causing a slight offset in the veins. The walls of the main fault are often loose, but those of the true veins are firm. Ore-shoots are irregular in the fault and regular in the veins. In character the veins are of quartz, sometimes containing mineralized country, and in the vicinity of the fault will also contain large quantities of calcite. The sulphide minerals, pyrite, chalcopyrite, blende, and galena, are also present. The entire vein-matter contains

fine particles of free gold, so scattered and small as to be invisible to the eye, and it is probable that the gold is mechanically locked in the quartz and sulphide. Occasionally an exceedingly rich streak is found, made up of a black mineral, probably tetrahedrite, containing fine particles of free gold. The mines are opened by adits and shafts. Prospecting drifts usually follow the vein, but if the walls are loose, laterals are run. Several vein-systems have been developed and partly mined, the shoots ranging in size from 3 to 15 ft. thick, and in gold per ton up to \$30. In silver the ore averages \$1 per ton. Of course, there have been developed besides many shoots too low-grade to be worked by small-scale operations. The ore, as milled is a mixture of quartz and calcite, containing sulphides to the amount of 10% of the total weight. Weekly development samples are taken from the various faces and after the ground has been opened, systematic sampling is completed. Several methods of stoping are employed. Where the walls are loose, close filling is done. In veins having firm walls, box-chutes are put in and the shrinkage system employed, while in some of the tight narrow veins the stopes are left open and in some cases pillars of vein-matter are left over the level run-way. Underground drilling is almost entirely by air, there being employed the one-man hammer-stoper, the jack-hammer for sinking, and both the mounted jack-hammer and the regular drifter for development.

By long experience in milling operations and numerous experiments, it has been determined that the metallurgical methods so far most satisfactory for the treatment of these ores is—after crushing—re-grinding in tube-mills, followed by agitation in cyanide solution. As there is neither smelter nor mint in Ecuador, all bullion must be shipped to foreign countries. The principal water-power installation is a 60-in. concrete tube, 2½ miles long, delivering 6000 cu. ft. of water per minute under a vertical head of 150 ft. The 40-stamp mill has an 8-ft. Pelton wheel on the line-shaft. In a like manner the crushers are direct-driven, while the hoisting-engine is operated by a 9-in. Francis-type turbine, reducing the speed through gears. From a low-head power another line drives three air-compressors by means of Pelton wheels, direct-connected. Concrete is employed for the tube instead of conducting the water in an open ditch, because of the fractured condition of the mountain and the certainty of land-slides.

The distance is 45 miles from tide-water. The trail is difficult of grade and during the rainy season almost impassable. All machinery and supplies must be sectionalized for transportation by small mules. Mule-freight ranges from a cent per pound in the time of good roads to 20 cents in time of bad roads.

The available workman is a mixture of Spanish and Indian, the type found in most of the towns and cities. The full-blood native in the higher altitudes lives by cultivation of the soil; he seldom comes to the low country and does not care to enter the mines. But in the few cases where they have become familiar with mining, they

prove exceptionally good workers. The native need not come to the mines because he can live on rice and bananas; as in all parts of the world where Nature drops the ripe fruit into the mouths of her beloved children, they seldom work. But these Ecuadorians usually show ability and eagerness to learn and become good workmen as miners, drilling both by hand and by machine. They also become good mechanics. Since there are no other mines in the Republic, they must learn here. The common laborer is considered unreliable, but those who do important work, such as mechanics, carpenters, drill-runners, timber-men, mill-helpers, and clerks, are steady, especially since they have obtained food free. The wages range from 50c. per day, in United States equivalent, for common labor, to \$1 per day up for the miners, the latter based upon the depth of hole drilled; many miners make \$3 per day? All labor receives free food. Over a long period the drilling speed has averaged two metres per shift per man for single-hand work and 14 metres per shift per man for the machine-stoper. There are at present employed 500 native Ecuadorians and 40 foreigners.

Because of extraordinary overhead expenses, such as traveling agencies, attorneys, hospitals, management, etc., with also excessive repairs and high transportation, costs must always be considerably higher than in similar operations in settled countries, and because of this it is all the more important in such an enterprise to attain to a large tonnage basis of operations, and that again calls for adequate transportation.

Isolation and lack of railroads cause difficulties unusual at similar operations in well-developed countries. The possibility of steamship delays and the bad condition of trails require that machinery and supplies be anticipated long in advance. Another hardship and expense, often causing delay and grief, is the necessity to sectionalize all machinery to a maximum load of 300 pounds. Of this necessity it is often difficult to convince the outside manufacturer. Foreign manufacturers desiring business with these republics should send representatives that know the language and customs, and then endeavor to grasp their point of view and requirements. All this will come in time, and with the other much-needed aid of banking and steamship connections there will build up a large interchange of commerce of great mutual advantage.

The Zaruma mining district ranges in elevation above sea-level from 2000 to 5000 ft. The climate is equable and agreeable. During the 17 years the thermometer has ranged from 51° to 93°F.; the averages for each day are with almost no variation, minimum 63°, maximum 83°, average 8 p.m. 70°. The rainy season begins in December and ends in April, the remaining seven months being without heavy rains. The average annual rainfall is 60 inches. It is always cool in the shade, and at night one needs at least one blanket throughout the year. During the rainy season brush and vines grow to the height of a man, but by the end of the dry season all is destroyed.

Rice is the staple cereal and is planted on the steep sides of the mountains, toward the end of the dry season. With machetes the natives cut all the dry brush and allow it some weeks in which to dry, after which it is burned; and then, with iron bars, holes are punched into the hard-baked clay soil and the rice grains dropped. When the heavy rains begin, it soon sprouts and by the beginning of the next dry season is harvested by clipping off the heads. Trees and garden vegetables grow rapidly during the rainy season, but slowly by irrigation in the dry season. Flour is imported from the outside, potatoes and all temperate-zone cereals are brought in from the higher altitudes. Coffee, bananas, oranges, pine-apples, and *avocados* grow in the district. All classes of fowl flourish in the district, and sheep and goats may be brought in from the higher altitudes. Excellent beef may be had from the high altitudes to the east and southeast, but cattle do not thrive on the grasses of the lowland; therefore a number sufficient for two weeks is brought in, killed, dressed and hung in the refrigerator. Hogs are raised in the district.

Distilled or boiled water is provided at all times, as the river-water is dangerous during the first excessive rains, when all the world is being washed into spring and river. A medical staff is maintained and a constant fight conducted to prevent illness and to better the conditions of hygiene. The methods employed at Panama have been followed and an energetic fight instituted against malaria, the hook-worm, and other ills of the tropics; but yellow fever and bubonic plague have not been known. The surface is drained and kept clean; the brush is cut; rubbish and garbage are removed daily, and dwellings are provided with screened quarters and water-works. A community can be brought to a high state of sanitation by proper care and prevention, but it is difficult to secure the co-operation and assistance of the less intelligent native population.

The mining company has introduced several welfare improvements: it has voluntarily given free food to all the workmen, deeming that this makes for health, strength, and steadiness; the company provides schools free to all children in the district; it operates a boarding-house for feeding the staff and runs a garden where most of the temperate-zone vegetables and local fruits are grown for their benefit; large refrigerating rooms have been installed where meats may be hung and all cereals kept in full strength and free from insects; the company provides a building used as a miners' club, a club for the staff, and a chapel. The latest dwelling used by employees is made of concrete; floor, walls, and ceiling are all reinforced-concrete, the roof is of local tile, the windows and doors are screened. These are practically insect-proof and shuiceable, so that roaches and fleas cannot harbor therein. This type of building is permanent, whereas those first built of ordinary lumber rapidly decayed from boring insects and rot. The native village and all staff dwellings are equipped with water, bath and sewer. For diversion, baseball, tennis, swimming, riding, and dancing are popular.

Concentration of Tungsten Ore

In a paper before the Colorado Scientific Society the practice of ore dressing in Boulder county, Colorado, was discussed recently by Mr. Herman Fleck.

The brecciated nature of much of the ore offered difficulties that were overlooked in early days, permitting about half the tungstate of iron, ferberite, to pass into the tailing ponds. The problem is affected by a two-fold difficulty, namely, the friability of ferberite, whose perfect cleavage has been noted, and which produces thin plates of mineral all too readily slimed by the action of stamps. In a measure, this has been overcome by a better demand for concentrates containing from 25 to 40% and by apparatus devised to treat the slime rejected in older practice. In the one case the increased density of the horn-stone, due to enclosed ferberite, allows coarser crushing, and subsequent separation from the gangue. In the other, modern slime-tables and canvas-tables prevent much of the ferberite, unavoidably slimed, from going to waste. Again, with the first instance in view, still coarser crushing, sizing, and jigging, followed by full use of present practice, have been suggested; but apparently without producing a change of general method. As it is, with increased use of the expedients mentioned, a recovery of 65% is made possible on more refractory ores, and recoveries of 85% are common. Two examples will suffice to describe current practice.

1. The ore is passed over a 2-in. grizzly, from which the undersize is fed to stamps and the oversize to a 7 by 10-in. Gates crusher, thence to the mill. The latter consists of 20 stamps of 1000 lb. each with a six-inch drop from which the ore, crushed to 20-mesh, passes to a special classifier, which delivers the coarse to two No. 5 Wilfley tables, middling to one No. 3, and the slime to two No. 3 tables. The coarse concentrate forms one product, while concentrate from the middling and slime are combined into a second product. Tailings from all the tables are tanked and distributed to four Wilfley slime-tables, from which the tailings are rejected, the concentrates being combined to make a third product and the middlings sent to an additional Wilfley slime-table where a final concentrate is collected. The capacity is 25 tons per 12 hours, the average concentrate being 15:1.

2. The ore is passed over a 2-in. grizzly, the undersize going to stamps, while the oversize goes through a 7 by 10-in. Gates crusher into a battery of 10 stamps, 760 lb. each, making an 8-in. drop 64 times per minute, and through a 12-mesh screen. Two No. 5 Wilfley tables receive the pulp, yielding a high-grade concentrate, the tailing going to a settling-tank, thence to classifiers. The coarse is sent to a 4 by 12-ft. Frue vanner, the middling and slime to two 6 by 12-ft. Frue vanners. The concentrates from middlings and slimes are combined. The tailing from the coarse vanner is run through a Huntington mill with a 60-mesh screen and then to canvas tables. The tailings from the other two vanners go to a V-settling tank, from which the pulp is treated by four van-

ners and the overflow goes to canvas tables. The latter, two sets 12 by 40 ft. each, have a slope of 1 in 12.

A typical analysis of high-grade concentrate is as follows:

| | % |
|---------------------------|-------|
| Tungstic oxide | 59.99 |
| Iron oxide | 32.57 |
| Sulphur | 0.00 |
| Manganese oxide | 1.02 |
| Phosphorus | trace |
| Silica | 8.32 |

It will be noted that the mineral proper constitutes nearly 90% of the product.

Nearly all the mills do custom work, and settlement varies from purchase of ore outright on a sliding-scale to a fixed price of \$3 to \$1 per ton for concentration, and purchase of the resulting concentrate at the market price. A sliding scale is graduated from 1 to 4%; 5 to 9%, etc., and in terms of cents per pound of tungstic oxide present in the ore or concentrate up to 60%.

Magnetic separation has been tried with some success. Where the ore contains arseno-pyrite, or pyrite, or both, experiments on direct treatment with electro-static machine have proved successful. In practice wet concentration is usually first employed, and the dried mixed concentrate is roasted to make it magnetic, after which the contaminating minerals are withdrawn in the magnetic field of a separator. Such is the case with Nova Scotia scheelite. With wolframite and tin ore a differential separation by magnetic fields of varying intensity may be used. The Cornwall tungsten ores are thus treated, making a separation of the above from iron oxide, and then from one another.

AMONG RECORD MILL-RUNS, as recently related by a mining engineer of wide experience, was a notable performance in 1878 at the mill of the old Syndicate gold mine at Bodie, in Mono county, California. A million dollars was produced in six weeks from a 20-stamp mill when the supply of ore was only sufficient to supply an average of 7 stamps. During the six weeks a total of 1600 tons of ore was crushed, making the recovery over \$600, or 30 ounces, per ton. On one occasion the engineer in charge reported a yield of 900 pounds of gold amalgam in one day; the general office thought this must be a mistake and that he meant 900 ounces. "To one familiar with the sound of the stamps when in regular operation," he relates, "it is interesting to state that occasionally the free gold filled the inside of the mortar so that a peculiar soft impact was heard instead of the customary pounding of the stamps. No amalgamation was attempted in the mortar, but the pans sometimes got choked with amalgam so as to hinder operation; the amalgam accumulated on the side-wings of the pans so as to jam the mullers and slow-down the mill-engine. So much retorting was done that for days at a time the retort had no chance to get cold." The choking of a mortar-box with amalgam occurred several times at the old Caledonia mine on the Thames, New Zealand, 40 years ago. This mine yielded 10 tons of gold in a year.

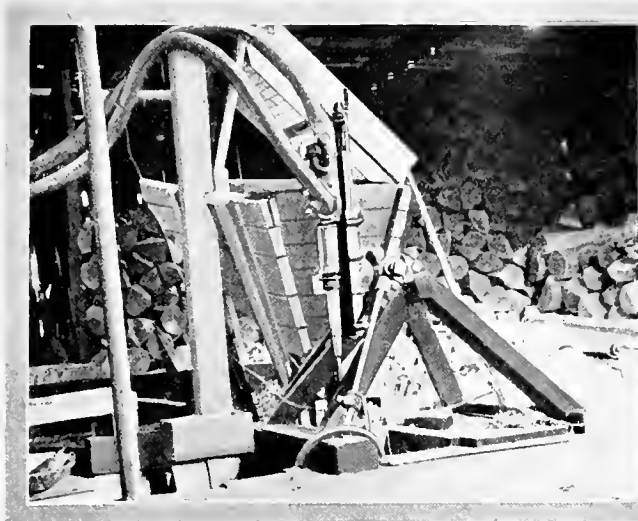

AN EXTEMPORIZED STAMP-MILL.

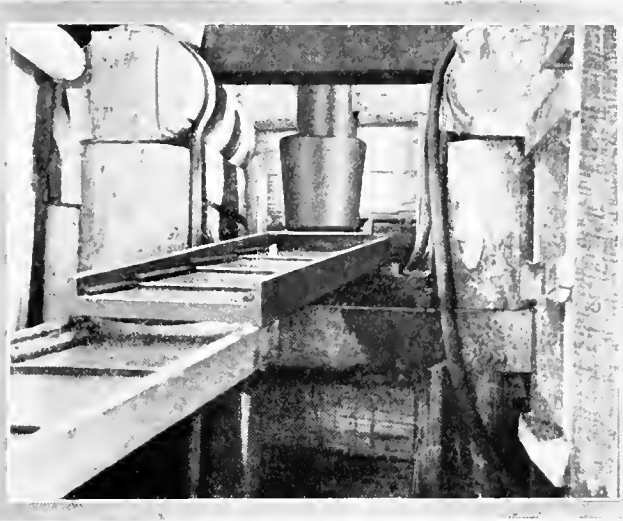

A CLOSE VIEW OF THE MORTAR-BOX.

A Rock-Drill Stamp-Mill

By C. F. Weeks

MANY a mine superintendent has felt the need of a more thorough method of prospecting orebodies he is opening than by the assaying and panning of marked samples, before it is advisable to build even a small mill of the regular type. This need has been met by the South Fork Gold Mining Co. at Forest, Sierra county, California in the following manner. The company had purchased a Temple-Ingersoll electric air-drill, for the purpose of extending the hard-rock tunnel for gravel, and did 400 ft. of work along that line. Since then attention has been given to developing one of the lodes where the rock is not hard or solid enough to stand a power-drill. The drill not being in use, it was thought that it could be made serviceable as a one-stamp mill; on account of the heavy blow that it strikes and because of the low cost of operation, it has answered the purpose exceptionally well. Working in this capacity, the drill uses $2\frac{1}{2}$ hp. and crushes a ton of hard quartz through a No. 1 screen in 14 hours, striking 220 times per minute with the motor operating at half-speed, which is not the regulation rate, but the motor does not show any ill effect of continuously running at half speed. The drill is mounted on a tripod that in turn is held by heavy timbers, which are anchored to the solid rock. The construction of the mortar is simple as well as substantial. It is composed of a 30-in. length of 6-in. standard pipe shrunk on a soft-iron casting with a square base having four holes for anchor-bolts. The casting and the hard-cast die, which is 4 in. diameter and 6 in. high, were cast at the foundry, and with these exceptions, the entire mill was constructed in the blacksmith-shop of the company, which is in no way exceptional in equipment. The stamp is made from a piece of $1\frac{1}{4}$ -in. drill-steel upset

to 4 in. at one end and shanked for the drill-chuck at the other. The screen-opening is 8 in. high and cuts out half of the mortar. The screen-frame is built of iron in such a manner as to place the screen on a 2-in. offset at the top and an inch at the bottom. The feed-chute is connected directly at the back of the mortar and is made of 20-gauge galvanized iron and fastened with screws to the mortar in which the opening is 3-in. square and on a level with the discharge. The lip of the mortar is also of 20-gauge galvanized iron and is securely screwed and clamped. The mill is equipped with the ordinary type of jar-feeder, which is easily constructed and is efficient when properly adjusted. Then follow second-hand silver-plated copper plates, a foot wide, 8 ft. long, with a half-inch drop per foot. Owing to the fact that the clearance of the stamp in the mortar is small, as compared with the usual type of mill, the crushing capacity is exceptionally large, while for the same reason inside amalgamation is poor. This, of course, could be remedied by increasing the size of the mortar, and so allowing more chance for amalgam to settle. But when the gold is readily amalgamated as is the case here, this type of mill gives excellent results.

BRAZIL has an area of 3,292,000 square miles, which is greater than the United States exclusive of Alaska, and a population of 24,000,000, which is one-quarter of that of the United States; Rio de Janeiro, the capital, has 1,500,000. Portuguese is the national language. Ocean-going steamers can ascend the Amazon to Manaus, a thousand miles inland. Shipments of iron and steel, machinery, and oils from the United States is increasing rapidly.

Treatment of Miners' Injuries

By T. C. Witherspoon¹

*Every wound, whether it is large or small, is of interest to the sufferer. In every wound, that is, where the skin or mucous membrane of the body has been broken, there lies the possibility of an inflammation which may become serious. On this account no injury of this sort, whether it be a simple abraded skin, a clean cut, or a jagged, extensive opening into the tissues, should be neglected.

Treatment of open wounds is simple, but must be done with some intelligence. Nature is the chief physician whose aid never fails if due attention is paid to her laws. When a wound is made there is an immediate oozing or bleeding from its surface, and in this blood, or serum, there is nature's first application of an antiseptic. The living blood has a certain resistance to inflammation-producing germs, but the dying blood, such as that which escapes from a wound and clots upon its surface, is many times more destructive of germ life than the living; therefore, this blood which is being exuded on the surface of the wound is the first great antiseptic application, washing away infection directly from within outward, and helping to destroy the germs that may have been implanted by the injury.

To this should be added the surgeon's aid. It was a practice in olden times, and even until recent date, to immediately wash these wounds with a solution containing carbolic acid, corrosive sublimate, lysol, iodine, or some antiseptic agent. The idea was that in washing the wound it was cleansed, and in the application of a dilute antiseptic the germs present were killed. From much experience and tedious experiment the medical profession has definitely proved that, instead of cleansing the wound, washing more often carries germs into it, and the antiseptics used are so dilute that instead of destroying germs they are practically useless. On this account wounds that were washed most carefully were often the wounds which inflamed and developed pus shortly afterward. Through this knowledge it became apparent that the best way to treat a wound was simply to protect it.

Sometimes when wounds result from instruments probably holding highly poisonous germs, or in places where such poisonous germs are likely to be found, it is necessary to use some measure to destroy such as might have been carried into the wound. To do this two agents are best used; one a concentrated tincture of iodine, and the other pure carbolic acid. In a wound where infection is suspected, it is a good plan to drop into it some tincture of iodine. If, however, there is good reason to believe that the wound

is seriously infected, the surgeon usually makes an application of pure carbolic acid to its entire surface, then wipes it dry of all excess. This, when done immediately or shortly after the injury is received, will practically always prevent germs from growing in the wounds.

One other hindrance to the healing of wounds is the presence of some foreign matter like rock, splinters, or small fragments of metal. As a rule, these particles do not carry serious infection in with them, but in all cases they should be removed if this can be accomplished without too much further injury to the already wounded tissue. They can never be washed out well, therefore, here again water or antiseptic solutions are out of place. Small forceps or dry pieces of gauze are used to remove these foreign bodies, purely by mechanical means.

The use of peroxide of hydrogen in or on wounded surfaces has been often advocated. This will be found to be a mistake. It diminishes the antiseptic action of the blood on the wounded surface, and does not offer a better antiseptic or even one nearly so good in its place.

It must be especially remembered that wounds through skin that is blackened by coal dust or dirt from working about engines, are certain to be made worse by any effort to cleanse the skin about the wounds. Such a wound should be most carefully dressed dry, without washing, usually in addition to the application of iodine or the mild cauterizing of its surface with carbolic acid.

In summarizing, it may be said that simple wounds dressed dry and unwashed, or touched with carbolic acid or iodine, heal better than when they are washed with any solution whatever. Larger wounds must be treated the same way, cleansed of foreign bodies mechanically and dressed dry. If these wounds are washed they always suppurate or have matter formed in them. This knowledge of the conduct of wounds has led to the present day simple first-aid package that every soldier carries with him into battle. Regardless of the nature of a wound he receives, it is dressed with a dry piece of gauze and usually left untouched for several days. By this system results have become much better in warfare, and soldiers are returned to the front in much shorter time.

OIL PRODUCTION FIGURES of the different states for 1915 show that California ranked first with 89,000,000 barrels, Oklahoma was second with 80,000,000, while Texas, Illinois, and Louisiana follow in the order named. The old oil-producing State of Pennsylvania produced nearly 9,000,000 barrels, ranking seventh between West Virginia and Ohio; Wyoming is ninth, and Kansas tenth.

THE ALTA-COTTONWOOD area of Utah now has 70 operating mines employing 700 men, as compared to a year ago when there were 17 mines employing 100 men.

¹Doctor at the Murray hospital, Butte, Montana.

*Abstract from *The Anglo*.

Mining in Western Oregon

By E. C. Morse

THE Bureau of Mines and Geology of Oregon formerly issued a monthly publication describing the State's mineral resources. The districts touched upon included the mines of Jackson and Josephine counties in southern Oregon; north-eastern Oregon, with its Virtue mine and its production record of \$3,000,000 near Baker City; the old mines along the Mother Lode near Bourne in the same county comprising the North Pole, and the Excelesior and Eureka, better known as the E. & E.; the Columbia and the Golconda mines, with an aggregate production of over \$8,000,000; the successful dredging operations of the Yuba Construction interests (Powder River company) near Sumpter; the modern mining and milling plants of Mormon Basin and Cornucopia; the possibilities of the Susanville district; the dredging opportunities along John Day and Burnt rivers. The Bureau did not continue this work during 1915, probably because of a shortage of funds, and did not describe the porphyry dikes of the Cascade mountains in Clackamas, Marion, or Lane counties, the cinnabar prospects near Prineville, nor the lava-capped gold-bearing sand deposits along the Deschutes river. A description of these porphyry deposits is the chief purpose of the present article.

The mines of the Bohemia district were paying good dividends about 15 years ago. The Champion, Music, Helena, and Noonday were the principal groups; each had a 10-stamp mill. The Helena produced some bonanza ore and is supposed to have ore of about \$6 grade still in reserve. The Champion and Music also had rich shoots or chimneys and made profits with their small reduction plants as long as they continued to mine in the oxidized zone and the gold could be recovered by simple amalgamation. When they became deeper the ore proved refractory and low-grade sulphides appeared containing iron pyrite, arsenopyrite, galena, blende, and some chalcopyrite. The metallurgical problems were then beyond the pioneer operators, who sold their holdings to an Eastern syndicate, which consolidated the three leading groups, the Champion, the Music, and the Helena, the resulting corporation becoming known as the Oregon Securities Co. A hydro-electric plant was erected and the three 10-stamp mills were combined into one 30-stamp mill, a central hoisting-works was built, and a subsidiary company extended the local railroad from Cottage Grove to within a few miles of the property. But no serious effort was made to overcome metallurgical difficulties; so the concern failed.

Later a group of lumber-men from Kelso, Washington, operated the Champion mine under lease and made a profit. At present the West Coast Mines Co. is re-opening the mines; this company is reported to

have opened up shoots of oxidized ore and to be shipping concentrate from the sulphide zone. The management is improving the equipment, putting the stamps on concrete foundations, adding modern concentrators, and expects to be in full swing shortly.

The Lucky Boy mine has an interesting history, and also a promise of profitable production if properly equipped. It may be roughly described as a group of chimneys and shear-zones in an altered dike of porphyry within an andesite country. It paid good profits while operations were confined to the oxidized zone with a

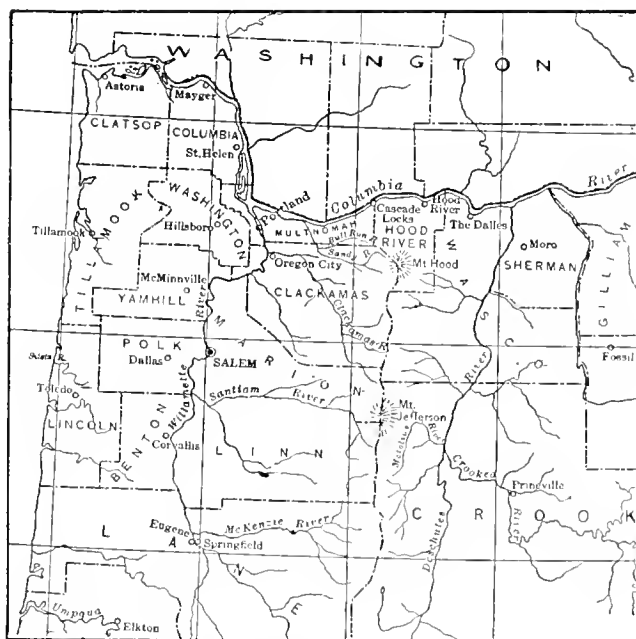

NORTH-WESTERN OREGON.

15-stamp mill. In several places in the oxidized zone it was stoped for a width of 40 ft. and yielded gold on the plates at from \$4 to \$6 per ton. About 12 years ago a 40-stamp mill with a full outfit of Wilfley tables and Union vanners was installed on the property. There was also developed a good hydro-electric power with a double Leffel turbine and a Westinghouse 250-kw. generator. The power was developed on the McKenzie river several miles above the village of Blue River. About the time this plant was put in operation, the ore changed with depth from a free to a sulphide character, yielding a bulky low-grade concentrate that would not stand the expense of the 50-mile wagon-haul necessary to reach the railroad at Eugene or Springfield. So the project failed. Before the attempt was abandoned, an effort was made to recover the precious metals in the concentrate by a so-called secret process, including re-grinding in an old Crawford mill, treatment of the

pulverized concentrate with a 'secret' solution, and the amalgamation of the gold and silver contents on shaking electric plates. Needless to say the scheme was not a success.

In 1908 I built a small cyanide plant to treat the accumulated concentrate. The plant consisted of the Crawford mill already mentioned, some small Paclinea tanks, a filter of the Helderman type, and a zinc slaying precipitation equipment. The experiment was not a complete success, owing to the inadequate grinding facilities, which were unsatisfactory not only by reason of not properly releasing the gold and silver contents for cyanide contact, but also in leaving a heavy product difficult to agitate. During this test special runs were made; these demonstrated that more than a 90% extraction was possible whenever the material was pulverized fine enough and good agitation accomplished.

Neither the quantity of concentrate on hand, nor the condition of the mine justified going farther at that time. The deeper ore of the Lucky Boy mine is for the most part altered porphyry containing streaks of spar and about 10% of pyrite with large lenses of galena and blende and some chalcopyrite. The ore is undoubtedly suited to the modern process of gravity concentration and flotation. A lead-silver, zinc, and possibly a copper product can be made rich enough to ship to the smelter, while the low-grade iron-sulphide concentrate can be ground to 200-mesh and cyanided on the ground. There are places where crude ore can be mined rich enough for shipment. The old company hardly tested the deeper ore before ceasing to operate. The present owner, the Consolidated Lucky Boy Mines Co., has spent a small amount of money on two adits, one about 300 ft. below the lowest former operations and another about 600 ft. deeper than the old workings. The latter has not yet reached the zone or dike. The former has exposed ore of low grade and some good lenses of galena. One cross-cut contains concentrating ore for a width of 40 ft. with a strong galena showing on one wall. This adit has not yet reached the ore-shoot that yielded the good ore in the upper workings and will have to be driven several hundred feet to reach the Daisy Creek intersection, where the best ore was found. Driving this 'tunnel' through to the Daisy Creek intersection would be a good speculation for a development company.

The Ogle mountain mine is situated in Clackamas county near the line with Marion county, and is about 40 miles east of Salem in the foot-hills of the Cascade mountains, not far from the base of Mt. Jefferson, between the Molalla and North fork of the Santiam rivers, two tributaries of the Willamette. By the road used at present, by way of Mt. Angel and Scott's Mills, the mine is 40 miles from a railroad. When the road by way of Gates is available, the distance from railroad transportation will be 12 miles. A fair mountain road is possible by this route.

Work has been conducted at this property by an association of local people. The mine has been opened by

three cross-cut adits. The first crosses the dike at a depth of 50 ft., the second at 300 ft., the third at about 900 ft. Drifts have been extended on all these levels. A number of shear-zones and veins have been encountered and the main dike averages about 50 ft. in width. The lower adit crosses six veins or zones with assay-values of interest in most of the dike-matter, with enrichments in the form of lenses. This 'tunnel' is 1460 ft. long. There is pyrite all through the lower orebody, this when reduced to a clean concentrate will assay \$75 per ton. Galena occurs in lenses much as in the Lucky Boy, but it carries a higher gold and silver value. In the upper workings considerable free gold is present, generally in the same form as the galena; enrichments occur in the lower workings.

There was formerly a 10-stamp mill that saved the free gold only, and a fair showing was made with it. Later a cyanide plant was built; this includes a steam power-plant, a new rock-crusher of the Traylor roll-jaw type, a Traylor 5 ft. by 22 ft. tube-mill, three agitators of the Spalding type, each 20 ft. diam. by 20 ft. deep. They were intended to be hydraulic agitators with an arrangement similar to the Parral tank, except that it was meant to be actuated by a 2-in. centrifugal pump for each tank instead of by compressed air.

Both pumps and compressors were insufficient in capacity and the agitators never worked in a satisfactory manner on the heavy sulphide contents. This material should have been separated by concentration for separate treatment. All the iron sulphide contents as well as the finer gold, after the coarse gold had been removed, are adapted to cyanidation when the material has been properly prepared.

The company was the victim of an inventor with a theory. Unfortunately when building the cyanide plant the stamps and plates were dismantled, leaving no facilities for catching the coarse gold. The omission of the 10 stamps also rendered the coarse-crushing capacity inadequate. These mistakes could have been easily corrected had the company not exhausted its financial resources before it realized its position. The outbreak of the European war made it impossible to raise money. An attempt is being made at present to resume operations on an adequate scale. Some galena has recently been exposed in the No. 2 vein in the lower adit. An effort is being made to connect the upper workings with the lower adit by a raise, to determine the continuity of the orebody as well as to improve the way of getting ore from the upper workings to the mill.

About a year ago some excitement was created in Portland by the announcement of the discovery that vast bodies of partly-cemented sand, much of it lava-capped, along the Deschutes river contained gold that could be recovered by a combination process, using concentration followed by cyanidation. Experienced mining men have been skeptical, but a mining engineer of experience who made an examination of the deposit has reached the conclusion that it is at least worthy of an investigation.

Mining in Arizona

By Charles F. Willis

A RECORD of production was reached in 1915, the aggregate output of gold, silver, copper, lead, and zinc amounting to a value of about \$90,000,000, as compared with \$60,000,000 in 1914. Yet there are still brighter prospects ahead.

During the past year the Old Dominion mine was curtailed in its production for two months by a flood, which drowned the lower workings, and prevented the operation of the plant and the production of 5,000,000 pounds of copper. The loss of about 28,000,000 lb. of copper was incurred by the shutting-down of the mines in the Clifton-Morenci district, because of labor troubles. The International Smelting & Refining Co. started to produce copper in the month of June, and has not yet reached its normal capacity of 150,000,000 lb. annually, as the Inspiration mill, whose concentrate it is to handle, is not entirely completed. Twenty-five per cent of the copper produced in Arizona will come from this plant. The smelter of the United Verde Copper Co. was blown in during the year, and although its capacity is double that of the old plant, it has been gradually increasing to its full capacity, but has not yet reached that point. During the year the Miami Copper Co. has gradually increased its tonnage from 3500 tons daily to 4200. The experimental work of this company has proved the feasibility of treating their low-grade ores, which run 1.21% copper, and it is believed that this plant will also rehandle the main tailing-piles that have been made by the Miami mill. The New Cornelia at Ajo has completed its railroad, and work will now be rushed on the construction of a leaching plant using the Greenway process, where 4000 tons per day will be treated. This and its sister property, the Ajo Consolidated, will prove great additions to the copper production of the State.

While copper in 1915 reached 450,000,000 lb., or almost 25% of the production of the United States, it should reach over 600,000,000 lb. in 1916. This alone will increase the gold and silver production, as most of the copper ores contain small amounts of the precious metals.

This, however, is but the beginning. Publicity has been the key-note of Arizona's progress for the past few months and will continue to be so during the next year. For many years it has been known that the Oatman district contained gold ore in large enough quantities to make profitable mines, and that there were large veins traversing the district. For many years two companies, the Tom Reed and the Gold Road, consistently developed, mined, milled, and earned profits, but the development of the district did not follow in the footsteps of these producers. It was known that the orebodies of the district were wide and long, and that the ore was free-

milling and cyaniding, but the knowledge of these facts alone did not mean the development of the district, in spite of the fact that there are many lodes existing under as promising conditions. Consistent, truthful, and persistent publicity told the world of the Oatman district, and in one year more development has been done, more mines have been found, more properties have changed hands, and more men have been put to work than would have taken place in several decades in the ordinary course of events. Hundreds of carpenters are at work

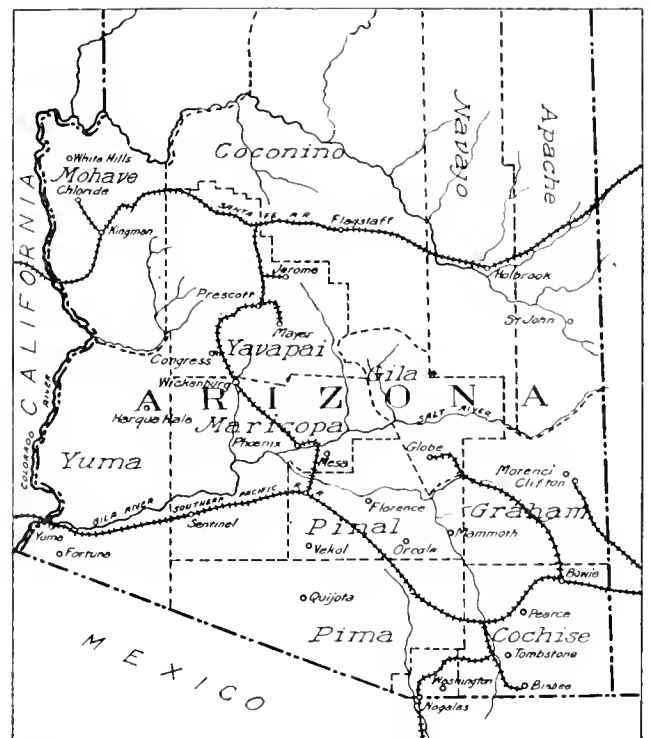

building a town; shafts are being sunk everywhere, all with the idea that development must go at least 500 feet. Many operators are complaining that they cannot get their head-frames, hoists, and compressors. It is a real boom, with four mines, the Tom Reed, Gold Road, United Eastern, and Big Jim assured.

Following in the footsteps of Oatman comes the notice of publicity work on the same lines from Yavapai and Pima counties. The advertising of their resources will bring to the attention of the investing world the possibilities of these districts. The boom at Oatman, and the fact that it has called attention to Arizona, is going to assist in the development of the wonderful resources of both Pima and Yavapai counties.

Copper and gold are not the greatest of the State's activities, however. The tungsten fever is raging, and the past few months has seen an extensive development of new properties. The old dumps of the early-day

silver chloride mines are being investigated, and in many cases the tungsten character of the product has resulted in re-locations. The many samples being sent to the Arizona State Bureau of Mines for identification indicate that there are a number of prospectors looking for tungsten, and many of them finding it. Records show that there are 26 producers of tungsten ores in Arizona, most of them in deposits of considerable size, although some will undoubtedly have to stop mining when the price of the metal drops. The Arivaca, Dragoon, and Globe districts are the largest producers.

Molybdenum is also coming in for its share of attention, and is being produced from many localities, although the greater part of the production has been from the Mammoth district, from which 30 tons of 24% wulfenite concentrate is being shipped monthly, for which a remarkably high price is being paid. Throughout the State are scattered many large deposits of molybdenite, associated with copper, and in the Copper Basin district a new process is being installed to work the ores of the Copper Hill mine. The flotation research work of the State Bureau of Mines, by H. J. Stander, has shown remarkably good results in selective flotation in separating molybdenite from the copper sulfides, using as low as 0.0025% fusel-oil.

In addition to the deposits of quicksilver that are already known in northern Gila county and at Ehrenburg, a new deposit has been found in the Copper Basin district, Yavapai county, by Messrs. Ross, Hall, and McNary. This find has created considerable excitement in Yavapai county, and has started a score of prospectors in search of mercury.

Tungsten hunters have found other things, notably a deposit of stibnite in the Turkey Creek district by Messrs. Ryan and Rogers of Mayer. It is reported that the pay-streak is fully two feet wide, and may be traced for over a mile. This is the only deposit of commercial antimony that has been found in the State.

Much placer exploration is going on in various localities, including the Lynx Creek, Dos Cabezas, Quartzite, Hassayampa, Le Paz, Old Hat, San Domingo, and Arivaca districts. There are many deposits of placer gold in Arizona that would be considered rich if water were available, and the one who can devise a method of working the great quantities of material in these areas cheaply and using little water will be rewarded by much gold.

With the stimulation of the industry in tungsten, molybdenum, quicksilver, antimony, and asbestos, Arizona is coming forward in the rare-metal production. The present high price of copper and the change in the sliding scale of wages at the larger camps to include 25-cent copper, has greatly increased general prosperity.

COPPER PRICES in New York in the summer of 1861 were between 17 and 20 cents per pound. That was at the beginning of the Civil War; prices gradually rose to 50 cents per pound in 1864-5, then declined until in 1870 they were again about 20 cents.

Copper and Aluminum

As is generally known, copper is a better electrical conductor than aluminum; and mechanically, it is much stronger; for equal cross section aluminum has about half the strength of copper; and for the same electrical conductivity the breaking point of aluminum wire is about 80% that of copper wire. This means that on a power-transmission line, the aluminum wire would break from 80% of the strain required to break the copper wire, assuming that neither wire was scratched or nicked. Aluminum, being quite soft, is more liable to slight mechanical injuries from erecting or handling. Sudden breaking of aluminum wires occurs from time to time by reason of injuries suffered during erection. An arc, due to a short circuit or to wires momentarily swinging together, may cause serious damage to an aluminum line on account of the low fusing point of aluminum, thus burning and pitting the wire, and reducing the mechanical strength. With copper, however, the arc has little or no effect. Aluminum is cheaper than copper when the two are compared merely on the basis of conductivity, and will furnish more conductivity for a dollar than copper. For the same conductivity aluminum is considerably lighter than copper, the ratio being 2 to 1. This might indicate that lighter towers could be used. Experience shows that the reverse is the case, because it is not the dead-weight of the line that determines the necessary strength of the tower, but the strains caused by winds. Aluminum has a cross-section 64% larger than the equivalent copper wire, therefore offers more resistance to the wind and causes a greater side pull. Under sleet conditions a greater area of sleet will collect on aluminum than on copper, and at such times there are generally strong winds. Aluminum, on account of its greater coefficient of expansion and low tensile strength, requires higher towers, or towers placed closer together. Aluminum is not suitable when there is abrasive action on a wire, such as trolley wire, nor is it suitable for smaller sizes of wire, such as telephone wire, which is invariably of copper. Copper is better suited for cables and insulated wires on account of its smaller diameter and equal capacity.

SPAIN, it is reported by *Ingeniería*, an engineering periodical of Madrid, is to produce platinum from deposits discovered in the southern province of Malaga. The report states that Domingo de Oructa, a Spanish engineer, made the discovery in the Ronda mountains where he had noticed a similarity to the great platinum-producing areas of the Ural mountains.

"MISDIRECTED OPTIMISM," said the manager of a large successful mining company who was in the office recently, "has been the cause of most of the mistakes in judgment made at our mines." Intelligent criticism, it should be recognized, is not pessimism; it constitutes a valuable contribution to the rewarding of real merit.

CONCENTRATES

Readers of the MINING and Scientific PRESS are invited to ask questions and give information dealing with technical and other matters pertaining to the practice of mining, milling, and smelting.

TUNGSTEN melts at 3540°C.

DIAMONDS have been found in the basket of the Simmer Deep mine, on the Rand. They are also found in the mortar-boxes in the Klerksdorp district mills.

AN AERIAL TRAMWAY at the Weedon copper mine near Weedon, Quebec, transports ore 19,500 ft. to the railroad at a cost of 6.7 cents per ton. About 10,000 tons is moved per month.

A SQUARE ACRE of land measures 208.7 ft. on each side and contains 43,560 sq. ft. In a mining claim 600 by 1500 ft. there are 20.66 acres; in a square area of $\frac{1}{4}$ mile on a side there are 40 acres.

CONCRETE tests at the Sheffield Scientific School as to the best proportion of water in concrete showed that a 1:2:4 mixture, tested after a set of 30 days, was strongest when it had been mixed with 27 $\frac{1}{2}$ % of water.

A PLAYA is a shallow, flat-floored depression characteristic of valleys having no regular drainage to the sea, in which storm-waters collect and evaporate—a wet and dry lake. It may be a shallow lake or a salt-encrusted mud flat.

ALUMINUM has the property of withstanding the action of nitric acid and sulphuric acid, either separately or combined, making the metal valuable in the manufacture of high explosives. Hydrochloric acid, however, attacks aluminum readily.

USE OF OIL in generating power is much more effective when applied to internal-combustion engines than when consumed as fuel under boilers. In the one case a barrel of oil gives power for crushing 14 to 15 tons of ore; in the other only for 1 $\frac{3}{4}$ to 2 tons.

COLLOIDS is a term now used by many chemists, especially those uncomfortable amid the complex physical problems underlying flotation, when they are at a loss to explain themselves. Much in the same way the 'geyser' was the last resort of the perplexed geologist in an earlier decade.

FIRE-BRICKS at smelters become impregnated with copper sulphide, lead sulphide, metallic zinc, and zinc oxide, and according to N. B. Davis in *Economic Geology*, the blast-furnace may be adapted to an experimental method on a large scale for the elucidating of problems of ore deposits of several important types.

THE COMPRESSION OF AIR develops heat, and if a mass of air is compressed to one-fourth of its original volume, its temperature will be raised to 376°F., if no heat is

allowed to escape. Since the air thus compressed is allowed to cool to the temperature of the surrounding atmosphere before it is used, the mechanical equivalent of this dissipated heat is work lost.

THE AMOUNT OF GOLD that a strong man could carry would probably not exceed 360 lb. avoirdupois, which in fact he would not want to carry any great distance. This amount of gold represents about \$100,000 and if formed in a solid sphere would be but 10 inches in diameter. A ton of gold (2000 lb.) is worth \$602,861.

HARDENING OF CONCRETE is accelerated by the use of calcium chloride, according to the U. S. Bureau of Standards. It was found that 4% of calcium chloride added to the mixing-water increased the strength of the concrete, at the age of one day, 100% or more. In some cases the strength of two-day old concrete mixed with calcium chloride was as much as 75% of the strength of ordinary-mixed concrete at the end of a month.

THE NITRATE INDUSTRY of Chile is of the greatest importance to that country. The aggregate exports up to 1915 were valued at \$1,702,574,394. During the last three years, the respective outputs were: 58,751,291; 32,070,714; and 46,000,000 quintals of 101,445 lb. The export duty is now 56c. per quintal. The selling price at the vessels is \$1.81 per quintal. It is said that the cost of production can be reduced. When the War started the nitrate business was affected considerably; but now there is a large demand for the product.

ENORMOUS QUANTITIES of natural gas have been wasted in the past, large quantities still are being wasted, but a reduction of this waste is taking place owing to the proper capping of wells. Probably the most novel way of conserving gas is that by the Standard Oil Co. in the Midway oilfield, California, where two wells are yielding more gas than is needed for fuel or domestic purposes in the field, so instead of permitting the gas to go to waste it is carried by pipe-lines to a hole that was drilled for oil several years ago. Under natural pressure the gas finds an outlet at about 500 ft., and apparently is being stored away in underground reservoirs at that depth.

SLIPPERY METAL FLOORS, stair-treads, elevator-landings, and manhole-covers are so dangerous that casualty insurance companies are now making extra charges for such hazards, according to *The Anode*. Owing to the nature of operations at smelters it is necessary that metal floors, stairways, etc., be used. It is, however, possible to greatly reduce the slipping hazard by roughening the metal surfaces, or by using some of the slip-proof surface materials that have lately come into use. Engineers engaged in smelter construction seem to have a weakness for designing stairways that have a steep inclination and have so far paid little attention to the matter of making them safely and comfortably usable.

REVIEW OF MINING

As seen at the world's great mining centres by our own correspondents.

BUTTE, MONTANA

WAGE INCREASE NORTH BUTTE ELECTRIC HOIST TUOLUMNE, BALLAKLAVA, AND BUTTE. ALEX SCOTT ANACONDA'S NEW ZINC MINE. ELM ORLU BUTTE & SUPERIOR DECISION.

Wages of miners working in the Butte district have been raised 25c. per day. Muckers, miners, and timbermen are paid the same amount, and all underground men now receive \$4.25 per day. There had been an agreement between the operating companies and the Western Federation of Miners that wages should be \$3.50 per day when the average price of copper was below 15c., from 15 to 17c. the scale was to be \$3.75, and above 17c. \$4. The contract was cancelled during the union troubles here, but the companies have voluntarily adhered to the terms of the old agreement. \$4 was the maximum under the old scale, but since it appears that the price of copper may be over 20c. per lb. for several months the companies agreed among themselves to share their large profit with their employees, and wages were raised to \$4.25. When copper drops below 20c. wages will again become \$4. The increase affects about 19,500 men at Butte, and raises the monthly pay-roll of the mining companies to \$2,150,000. The men working for the Anaconda company at Anaconda and Great Falls will also receive a raise of 25c. per day.

The motor of the new electric hoist at the Granite Mountain shaft of the North Butte has burned out. It was of 1750 hp., and was thought to be powerful enough for the work, but experience has shown that it could not sustain the trying conditions that a hoist of this nature is subjected to. It will require at least a month to re-wind the motor and have the hoist in working order. The old steam hoist at the Speculator shaft is again in commission, and ore is being hoisted at nearly normal capacity. Some shareholders have expressed dissatisfaction with the high costs at North Butte during the past year. Those can be attributed largely to the extraordinary expense incurred in connecting all the levels of the Speculator mine with the Granite Mountain shaft. This gives the company two fully-equipped operating shafts, and in case of accident to one, nearly full capacity can be hoisted through the other. The wisdom of the expenditure is shown clearly when one considers what the company would lose from a shutdown of a month during the prevailing high price of copper.

The Tuolumne did not meet expenses during December, and it was rumored that the mine would be shut down. However, the ore is now of a better grade, and the directors have decided to keep the property in operation until the annual meeting of shareholders held in March. The Tuolumne is a fractional claim with an area of only six acres. It is surrounded by ground of the North Butte and Anaconda companies. Negotiations have been opened for the sale of the Tuolumne, and if the price fixed by the stockholders is low enough, a sale is possible to either of the larger companies. Because of their better facilities they would be in a position to make a profit from ore that will not pay expenses under the prevailing conditions.

A cross-cut from the bottom of a winze on the 1800-ft. level of the Ballaklava has cut a vein that averages 3% copper for a width of 24 ft. The new orebody will be blocked out as rapidly as possible, and when it is in shape production will be increased from 150 to 350 tons per day. The shaft will be

sunk later to 1800 ft., but for the present the ore will be hauled through the winze.

The Alex Scott will probably be sold to the Anaconda company. The directors of the two companies have agreed on the terms of the sale, and the proposition will be put up to the stockholders of the Butte-Alex Scott for ratification. The Anaconda company offers \$50,000 cash for the property, which is a fractional claim surrounded by claims of the Anaconda. The Butte-Alex Scott owns the Edith May vein, and the Anaconda owns the Colusa vein. The veins intersect, and there are stringers running from one to the other, so that the question of ownership is difficult to decide. The sale will make unnecessary a law-suit that would be inevitable if the Butte-Alex Scott continued to operate as an independent company.

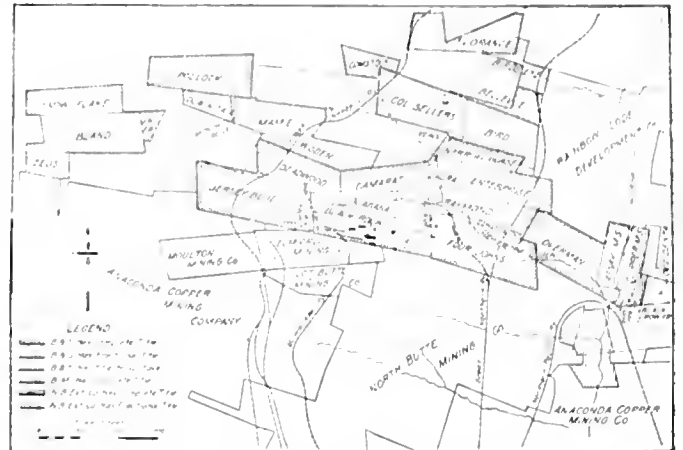

PLAN SHOWING BLACK ROCK CLAIM, THE SUBJECT OF DISPUTE.

On January 22 at Butte, Judge George M. Bourquin gave his decision in the Clark-Montana Realty Co. and others (the Elm Orlu Mining Co.) v. the Butte & Superior Copper Co. extra-lateral suit. The finding briefly was as follows, the full decision covering two pages of *The Butte Miner*:

1. That the Elm Orlu claim was located before the Black Rock claim was located.
2. That the north wall of the Rainbow vein apex crosses the common side-line between said claims 190 ft. from the southwest corner of the Black Rock claim, and that the south wall of said vein apex so crosses 301 ft. from said corner.
3. That the Pyle strand of the Rainbow vein diverges from the south side of the latter vein in the Elm Orlu claim, and there and for some indefinite distance easterly has its apex in the Elm Orlu claim.
4. That the Jersey Blue vein apexes in the Black Rock claim, does not unite with the Rainbow vein, and crosses on strike and dip the Rainbow vein on strike east of the Rainbow apex crossing of the common side-line.
5. That the Creden vein diverges from the north side of the Rainbow vein in the Elm Orlu claim and has its apex in both the Elm Orlu and Black Rock claims.
6. That the apex of the easterly strand of the Rainbow vein in the Black Rock claim terminates at a point within said claim east of the Elm Orlu east end-line projected and about 250 ft. west of the Black Rock east end-line.

7. That prior to the Black Rock location and patent entry both the Rainbow vein and the Jersey Blue vein at their apices were discovered, and known within the Black Rock claim, and at their apices appeared as a continuous east-west vein.

8. That each party has mined the orebodies of the other in the claims involved.

Therefore the court concludes:

1. That plaintiff owns all orebodies in the Rainbow vein between the Elm Orlu west end-line and a parallel line projected from where the south wall apex of said vein crosses the common side-line, or about 980 ft. of said vein.

2. That defendant owns all orebodies in the Rainbow vein between the projected Elm Orlu end-line at the south wall apex crossing of the common side-line by said vein and the east end-line of the Black Rock claim, or about 1200 ft. of said vein.

3. That plaintiff owns all orebodies in the Pyle strand from its divergence at its west end from the Rainbow vein in the Elm Orlu claim easterly as far as the apex of said strand is within said claim and between Elm Orlu end-lines projected, and defendant owns all thereof east of the projected end-line last aforesaid.

4. That defendant owns all orebodies in the Jersey blue vein between the points where the apex departs from defendant's premises across end-lines as laid or projected, throughout depth, save at its intersection or crossing of the Rainbow vein between Elm Orlu end-lines as laid and projected.

4.2. That plaintiff owns all orebodies in the Creden vein from its divergence at its east end from the Rainbow vein westerly as far as the Creden apex is within the Elm Orlu claim, between Elm Orlu end-lines there projected, and defendant owns all thereof west of the projected west end-line last aforesaid.

5. That accounting in damages be had.

6. That each party pay its own costs, and the decision herein is made a part hereof. An appropriate decree will be entered.

The Anaconda company has taken a three-year bond on the Douglas mine in the Pine Creek district of the Coeur d'Alene, 15 miles from Kellogg. An initial payment of \$1000 has been made and \$10,000 is due in nine months, after that \$50,000 will be paid every six months until a total of \$361,000 has been paid. The new owner will also pay a royalty of \$3 per ton of ore mined, the royalties to apply on the purchase price. The ore is a complex, containing 17% zinc and 6% lead. Previous efforts to treat the ore were not successful. Flotation failed to make a good separation because the sulphides are intimately mixed, and even fine-grinding will not put the ore in such a condition that the zinc and lead can be floated separately. The Anaconda company proposes to leach it with sulphuric acid and precipitate electrolytically at its new plant at Great Falls.

A mill will be erected at the mine to give the ore a rough concentration. The concentrate will have to be hauled 15 miles to the railroad, auto-trucks will probably be used for this purpose. The Douglas had 40,000 tons of ore blocked out for years, but nothing could be done with the property because of metallurgical difficulties. There are several other mines that will be able to operate at a profit when the company is ready to accept shipments of zinc ore. Heretofore a small miner has been unable to sell his product because the smelters usually insist on a 50% zinc content, and there is no custom mill to which he could send his ore for concentration. The company expects to have its zinc plant in operation this year, and will no doubt accept shipments at its sampler in Butte.

During December the Butte & Superior company produced 16,031,000 lb. zinc in concentrate from 50,500 tons of ore. The recovery was the highest, namely, 95.77%. Re-treatment of tailing is now under way, increasing the yield.

MEXICO CITY, MEXICO

THE SITUATION IN MEXICO.—THE FUTURE.

The political situation, which is of secondary interest to American miners, is still the all-absorbing topic in Mexico, as it has been since 1911. After the circulation among the Mexican chiefs, in July, 1915, of the invitation to the peace convention of the A.B.C. conference, it was thought here that the United States government had at last awakened to its duty, and was about to undertake the pacification of Mexico. What was the surprise in September at the announcement of the recognition of Carranza, the contestant who had not only refused to attend the proposed peace convention, but had repudiated the right of any foreign power to interfere in Mexico, no matter whose rights were being violated. Perhaps the failure of the plans for the convention might have been expected when the United States invited the A.B.C. powers to sit on the case of Mexico, a country in which none of them had either investments or resident citizens, and whose coercion would set a dangerous precedent in the event of their own future misbehavior. Though the Carranza faction had become



MAP OF MEXICO.

the strongest and best-behaved of the Mexican contestants, its recognition offers little hope for the speedy restoration of normal conditions. There are too many obstacles, among which may be mentioned: inflated currency, famine, pestilence, race prejudice, railroad and bank paralysis, Zapatism, and Syndicalism.

Inflated currency takes its place as the most serious obstacle to the alleviation of Mexico's economic woes. The decline in value of the legal-tender or paper peso from 30 cents in July 1914 to 6 cents in July 1915, was a heavy blow to the middle class, as it practically ruined everyone whose fortune was in money, such as loans, mortgages, bank credits, or currency. The fall completely upset the labor market, and caused misery and starvation to thousands of laborers' families, whose wages, advanced much slower than the decline in the purchasing power of money. Importation of clothing, drugs, and hardware, for which Mexico depends on the United States and Europe, has almost ceased, while the equipment of new mines or factories with foreign machinery would now be impossible, except by companies financed from abroad.

The famine, caused last spring by the wholesale exportation of food in exchange for guns and cartridges, was little alleviated by the autumn harvest, which was far below normal in quantity, because of lack of field hands and of seasonal rains. The natural scarcity has all along been aggravated by the diversion of the railroad rolling-stock for fighting purposes, and by the extortions of the military leader who in many cases refused to pass food trains until paid huge sums as toll.

Starvation in Mexico City was killing its daily hundreds in July, under the Zapatista regime, and though food became a little more plentiful when the Carranzistas entered in August, the persistent famine soon brought on an epidemic of typhus, of which there are now said to be 50,000 cases in the capital alone—without including the epidemics at Puebla and various other cities. As an indication of the sincerity of the revolutionary humane professions, it may be mentioned that Carranza refuses to admit the U. S. Red Cross society into Mexico for the relief of its famine and pestilence.

The anti-foreign group was quite influential in the Madero regime, and its first great victory was the dismissal of all the engineers and conductors on the National railways in the summer of 1912. But the rapid physical decline of the railroads did not begin until the discharge of all the American superintendents and master mechanics on the seizure of Vera Cruz in 1914. The final collapse of regular train service came with the 'intervention' of the English-owned 'Mexicano' railway by the Carranza government a year ago, and the wholesale destruction of rolling-stock and stations by the Zapatistas during 1915. At present the railways are entirely in the hands of Mexicans, and are conducted as might be expected in a country where the working-classes have no education and the educated classes are too proud to work. At present the shipment of freight has almost ceased, and even charcoal fuel has risen to unheard-of prices.

In the autumn of 1914 the banks first refused to sell drafts on other cities; in early 1915 they stopped receiving new deposits, and later in the year they refused to receive even their own checks for deposit. Since the express companies and post-office suspended the shipment of paper money or the precious metals a year ago, the only practical way to now ship such articles is by private messenger. To add to the monetary chaos the Federal treasury has just declared void the charters of most of the great banks.

The Zapatista faction, which has functioned since 1910 as a medley of reform, reaction, and rapine, has recently thrown aside the first 'R' and devoted itself mostly to the last. The plan of Ayala, which declares for the division of the great estates among the peons, has finally resulted in the concentration of the 26 former estates of Morelos into four, and these principalities are the personal property of Emiliano Zapata and three of his friends, who rule as despotically and ruthlessly as ever did Persian satraps.

Always the worst disciplined of the revolutionary armies, the Zapatistas have now thrown off the little restraint they showed during their short alliance last year with the Villistas. Besides their destruction of railroad property and the looting of defenseless villages, they have ruined scores of factories and mines. Sometimes they wreck for profit, as when they destroy vacuum-jans and alcohol-stills in order to separate the copper as junk; often they smash from sheer wantonness, as when they blow up a hoist with dynamite or sprag the fly-wheel of a moving Corliss engine with a log. As Zapatism has long made mining impossible in most of the rural districts of southern Mexico, so the rise of Syndicalism may soon hamstring production of all kinds in even such hitherto-favored cities as Pachuca. Actively preached in Mexico since 1910, the missionary centres for the Syndicalist propaganda have been located at Barcelona, Spain; Paris, France; and Los Angeles, California. In the summer of 1914, when the Carranzistas first entered Mexico City, the local Syndicalists, called the 'Casa del Obrero Mundial' were given a centrally located convent for their meetings, and in February, 1915, when General Obregon re-captured the capital, they numbered 25,000 local members. By the help of the clever Dr. Atl, Obregon was able to cajole the Syndicalist leaders into a public support of Carranza, and the first fruits of this operation was the enlistment of 5000 of their followers in the ranks of his army.

The leaders themselves, who were orators, were then organized into the 'Revolutionary Committee' and have since been

actively engaged, at Government expense, in preaching the Syndicalist doctrines among the workmen of the cities. The U. W. W. is the United States branch of Syndicalism, and its plan for Mexico was published as early as 1911 in its Los Angeles paper *Regeneration*. This plan is as simple as it is bold and merely involves the confiscation of all the productive property in Mexico by the peons, and its future administration by a communistic Syndicalist commission.

The method of the proposed confiscation was not explained in *Regeneration*, but evidently an effective scheme would be to make the operation of their properties so unprofitable for present owners that they would be forced to shut down, and then the properties could be 'intervened' by the Government and presented to the Syndicalists. How far the latter now control the Government policy it is difficult to state, but the inflation of the currency, the minimum wage and 8-hour laws for labor, the maximum price law for commodities, the laws forcing employers to provide free schools and homes for their laborers, etc., are all steps toward realizing the plan of *Regeneration*.

It may not be generally known that Syndicalism is not merely an integration of 'syndicates' or industrial unions for economic betterment, but is basically a revolutionary political movement founded on the maxim of Proudhon "all property is robbery," and on the program of Bakemin, "all existing institutions must be destroyed." It rejects all prevailing ethical standards, dubbing them "slave morality," only tolerates employees until they can be despoiled, and advocates "direct action" which menaces employers with sabotage and society with the general strike. Anyone familiar with the ignorance of the Mexican masses and the dishonesty, disloyalty, and viciousness of large sections of the workmen must view with the direst foreboding the preaching of the destructive doctrines of Syndicalism. If mining operations have been difficult in the past on account of the degraded labor, what can be done when the same miners are taught to regard their employer as their natural enemy, and are waiting only for a good chance in order to dispossess him entirely?

Of interest to mining men is the plight of Oaxaca. Declaring itself sovereign last April, this State seceded from Carranza's rule, and ever since has been cut off from the outside world, for Carranza controls the seaports and the only exit to the north, the Southern railway. On its withdrawal Oaxaca issued its own paper money and organized a State army of 4000 men under the direction of Higinio Aguilar, Mezquero, and various ex-Federal officers. The secession did not save Oaxaca from the prevailing famine, and it is now suffering, too, from the typhus epidemic. Mining is paralyzed completely, as there is now no way of exporting either mineral or bullion.

The existing woes of Mexico are really all results of the same cause, the attempt to super-impose modern industrialism upon a barbarous and medieval population and government. Not only is the bulk (80%) of the population illiterate, but it is almost identical in race and customs with the Aztec barbarians as first discovered by Europeans. Of the educated class the majority are Spaniards or Spanish *mestizos* and these are medieval in sentiment, consider work degrading, and treated the peons of the ranches and the free Indians of the communal villages so badly during the last 30 years as to bring on the present revolution. As a rule the American and English owners of the mines and railroads treated their peons liberally, but their fair-dealing was unable to prevent the catastrophe in the face of the Spanish slave-drivers and the scandalously-corrupt and oppressive government of Porfirio Diaz.

If one will survey the earth, he will discover that there are few countries where much outside capital has been invested, except in civilized nations or their colonies. Why Mexico was made an exception and succeeded in attracting a billion dollars from the United States, and as much more from Europe, between 1880 and 1910, is one of the mysteries of financial history. The Chinese are far more civilized than the Mexicans,

yet they have secured scarcely a tithe of the foreign capital obtained by Mexico, even though they harbor ex-territorial courts for its protection. The only parallel to Mexico, as a beneficiary of foreign capital, is Argentina, but its population is almost exclusively of the white race and contains more of Italians than Spaniards.

Can Mexico develop a native government sufficiently competent and honest to quell the existing anarchy and satisfy the just claims of foreigners for indemnity and future protection? Though prophesy may be rash, the outlook now indicates a negative answer. It is not a question of *form* of government—the heterogeneous and ignorant populace can only be ruled from above—but of its personnel. It is certain that no colonial power, except possibly Spain, would have given Mexico as a colony as had a government, viewed either from the standpoint of civilization or of justice to the proletariat, as she has almost continuously had to endure for the past century under her native tyrants satirically called 'presidents.' From Iturbide and Santa Anna to Diaz and Huerta, Mexico has had a list of oppressors whose crimes might make even Abdul Hamid blush. The propping of these despotic thrones by the ostensibly democratic Monroe doctrine has been one of the *querrest* anomalies of history.

LORDBURG, NEW MEXICO

BURRO MOUNTAIN, HANOVER, CARPENTER, MOGOLLON, ORGAN, STEEPLEROCK, AND LORDSBURG DISTRICTS' DEVELOPMENTS IN COPPER, ZINC, SILVER, AND TUNGSTEN.

Mining activity in New Mexico has shown no exceptionally visible increase during the past quarter, save for the opening of several copper properties, the operation of which has been warranted by the high price of copper.

Chino continues with renewed vigor. At Tyrone the Burro Mountain Copper Co. proceeds with its work preliminary to beginning production by the middle of the year. At the company's mill-site all preparations are completed for the opening of the new 1000-ton mill. It is possible that by April 15 this plant will be treating ore from the mines five miles west of the mill. The Thomas Parker hospital is completed and nearby work is being expedited on the erection of brick houses for employees. The houses will rent for \$4 per room per month. Development is being carried on in the mines, and additional units have been ordered for the Deisel engine generating plant near the Niagara haulage-adit. Tyrone has not advanced in any noticeable manner within a year's time, but with the coming spring it is stated that the management will put on additional forces, and soon improve things. It has been reported that the company has purchased the holdings of the Savanna Copper Co. for \$700,000, but further verification of this rumor has not been given out. The Savanna company owns 150 claims, or 2557 acres of ground in the Burro Mountain district, among which is some very valuable mineral ground.

At Hanover the Empire Zinc Co. is preparing for the operation of its electro-static zinc-ore concentrating plant. A Snow-Deisel engine has been installed at the Empire power-house, and the electric generating plant put in operating order. Ores from the Thunderbolt property will be milled together with some eustom ore. Work at the Nason adit and the zinc carbonate claims will continue as heretofore. Mining of zinc ores is being done by the Republic Mining & Milling Co. on the Welsh property. Hotchkiss and Gilchrist are also doing some mining in the Hanover area. At Fierro the Colorado Fuel & Iron Co. is shipping from 10 to 12 carloads of magnetic iron ore daily from the Snow Flake and Jim Fair open-cuts.

Owens Bros. of Santa Rita are doing extensive development at the Grand Central mine in the Carpenter district. It is their intention to erect a concentrating plant near the mine. Visitors to the Grand Central report that the operators are

blocking out immense bodies of high-grade zinc sulphide ore.

Stimulated by the high price of silver, work in the Mogollon district is being extended, and it is reported that there has been a resumption of operations at the Deadwood mill and also the Alberta mine. Road work from Magdalena to the Mogollons is progressing rapidly, and before many months an excellent road will have been constructed into the camp, eliminating Silver City and Gila from the route.

In the Organ district of Dona Ana county the Black Prince zinc mine has been bonded to William T. Swoyer, who will begin work at once. General Dunwoody, owner of the Oregon mines in the same district, is supervising the installation of

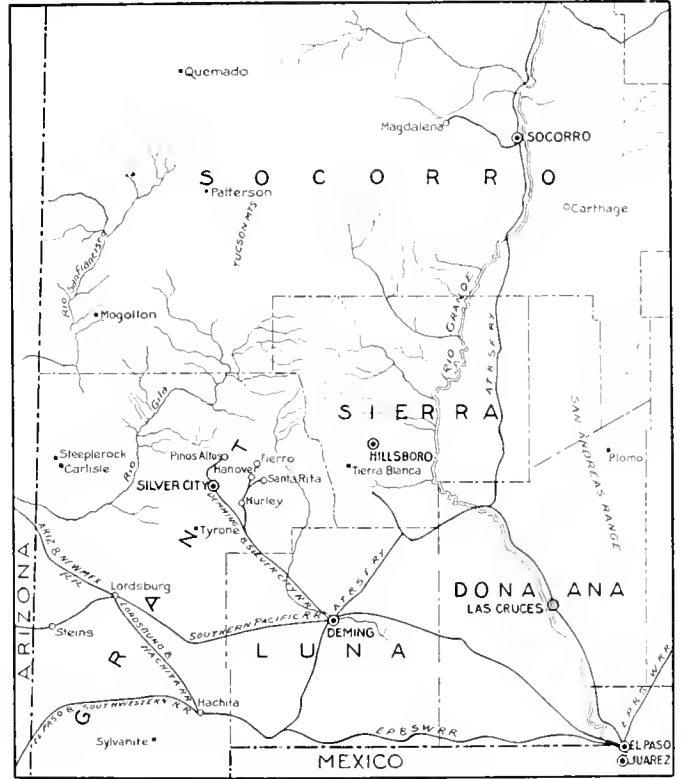

PART OF NEW MEXICO.

mining machinery, and will again operate the mines south of the Modoc claims.

The Calumet & New Mexico Co. at Phillipsburg is doing development under the management of U. G. Wolfe.

The White Oaks Mines Consolidated is mining, milling, and shipping tungsten ore from the old Abe property. Five tons of concentrate was recently shipped by the company.

Activity in the Steeplerock district of southern Grant county, has taken a new lease on life with the new year. Manager Duvall of the Carlisle mine has begun unwatering the shaft, and has opened workings to a depth of 300 ft. below water-level, revealing commercial ore in good quantity. A sale has been made of property adjoining the Utter mines, and much patenting is going on throughout the district.

Heavy shipments of silicious copper, gold, and silver ores are being made from Lordsburg. Wells and Sholly are leasing the No. 2 property of the Bonney Mining Co. and have received encouraging smelter returns. The Silver City and Santa Rita people who took over the Bonney mine are pushing development, and are getting the mine in condition for operation. The S5 Mining Co. is shipping over 400 tons of ore daily to smelters in Douglas, Hayden, and El Paso. Electric haulage is proposed for the mine. Spence and Huntington are extracting an excellent grade of ore on the Nevada lease from the S5 company. Ore is being shipped from the Nellie Bly, and also the Robert E. Lee mines in the Leidendorf part of the Lordsburg district.

SILVER CITY, NEW MEXICO

NOTES ON THE PINOS ALTOS DISTRICT MINES AND MILLS

The possibilities of the Pinos Altos district are considerable, and in addition to the properties described below there is an extensive grano-diorite deposit intersected by shoots of high-grade copper-silver ore from which shipments have been made.

The Cleveland mine of the Empire Zinc Co. is situated on the south side of the mountain, from which a fine view is had of the country south, including Silver City.

The company evidently has great faith in its zinc deposit, judging from the substantial buildings erected for its employees, including change room and mess house. In the mine and mill 100 men are employed, they are well satisfied with their treatment.

The zinc ore contains some gold, copper, and iron. It is mined from a 900-ft. adit. The output is 100 tons per day.

The mill is well constructed and equipped with the latest machinery for separating a complex ore. Eight magnetic separators produce a different size concentrate. Tailing is being conserved, and probably the company will install a flotation-plant before long, saving from 10 to 12% more of the metal than at present. The company also has large holdings in the Hanover district, and is completing a mill there similar to the Cleveland plant.

The Pinos Altos Mining & Milling Co.'s plant, known as the Wright and Stauber mill, is two miles south west from Pinos Altos. The mill and mine are both working, employing about 50 men. The company has 18 claims under lease and bond from the Savannah Copper Co., extending into the town; all produce good ore. At present, and for some time past, the company has been working on the Pacific No. 2 or the Skillacorn vein, belonging to the Pacific group. The holdings were secured two years ago. During this time it is reported that the output was \$125,000 of ore. The ore is complex, and contains copper, gold silver, lead, and zinc. Some rich gold ore has been taken from shoots near the surface to 200 ft. depth. Water conditions are reported to have prevented further working, but the company expects to deal with this effectively soon, when sinking on the high-grade will be resumed. The company will shortly begin work on the Gillette shaft, within a short distance of the mill, which is now down 500 ft. This company's mill is the only one of its kind in the south-west using the Huff electro-static machine. From the Wilfley tables the product is dried and then elevated to a series of screens. Each size is deposited in a steel storage-tank, from which it is piped to the two Huff machines. These deal with their respective size concentrate. They occupy a space of 10 ft. wide by 14 ft. high. Two products are made, namely, copper and iron, containing gold and silver, which go direct to a shipping bin; and zinc, barite, manganese, and waste. The latter goes to a wooden vat, and is thoroughly wetted with an 0.5% copper sulphate solution. In this solution a thin film of copper sulphide is precipitated on the zinc sulphide only. This makes the zinc particle an electric conductor. This concentrate is again put through the drier, the sizing-screens, and the Huff machine, the zinc being coated with the copper sulphide being pulled away by the current as it slides over the 'toboggans.' This gives a high-grade zinc concentrate, which is sent direct to a separate shipping bin. The tailing is conserved for future treatment, probably flotation. There are three bins of concentrates: first, lead with gold and silver, which comes direct from the second series of Wilfley tables, worth \$60 per ton; second, a copper-iron, worth \$60 per ton; and third, zinc concentrate, valued at \$50 per ton. The final recovery is from 60 to 85% of the original value of the ore. Shipments of concentrates total one car of lead, one of zinc, and two of copper each month. All but the zinc is shipped to El Paso, this going to Altoona, Kansas.

The Langston company, which owns an interest in the mill, and whose property adjoins that of the Stauber and Wright,

recently concentrated its ore, and made a shipment of 90 tons of zinc, 40 tons of lead, and 50 tons of copper concentrate.

Oscar Long and J. E. Trotter, practical concentrator and flotation men, at present at Hurley, are contemplating taking over the old Mammoth mill at Pinos Altos, their intention being to operate it as a custom plant. This is good news and will mean much to the small mine owner in that district. They have tested the ores of the district and consider them amenable to flotation, but they will also install an electro-static machine. A recovery of 95% is possible. The mill will be equipped to treat 200 tons per day. The transaction may be consummated within the next 60 days.

J. A. Michaels, of the firm of Hyman Michaels Co., of Chicago, arrived in Silver City on January 7. He is here to load and ship the old narrow-gauge railroad equipment of the Silver City, Pinos Altos & Mogollon Railroad Co., which eight years ago operated between Silver City and Pinos Altos. There are about 30 carloads of material, besides locomotives, cars, etc. The line was operated only a few months when the owners, the Comanche Mining & Smelting Co., went into bankruptcy. The smelter and the mining properties were taken over by the Savannah Copper Co. This was about eight years ago. Three years ago the Hyman-Michaels Co. took over the railroad equipment.

WASHINGTON, D. C.

NOTES ON THE LEASING BILL.

The bill authorizing the exploration for and disposition in the public domain of coal, oil, phosphate, gas, potassium or sodium, commonly known as the Leasing Bill, and which is not a little disapproved of in the West, where it effects the public domain, has passed the House of Representatives, and is now in the Senate where it has been sent to the Committee on public lands. The passage of the measure in the House took only a few days, and while thoroughly discussed and dissented from by Western members, it had such large support that it was deemed not even necessary to have a roll-call on the bill. It is expected that the bill will meet with more vigorous opposition in the Senate, which was the case last year when the bill was up and prevented from passing; but it remains to be seen if the bill can this year find so convenient a jam of legislation as happened last winter. The bill is one of the conservation measures before Congress. If it ever reaches the President it will be signed by him. The measure does not effect metal mining, but it is feared it may set a precedent thereto. In its general provisions as to coal it imposes a minimum royalty of two cents a ton, the Department of the Interior to adjust each lease according to conditions that are present. To insure development a rental of at least 25c. per acre will be required for the first year, and 50c. for the second, third, fourth, and fifth years, and \$1 thereafter during the life of the lease, except that the rental for any year shall be credited against the royalties as they accrue for that year. Railroads may acquire leases, but only for the production of coal for their own use. In the oil and gas sections of the bill the Secretary of the Interior is authorized to issue a prospector's permit for two years, and if any prospector discovers oil he may secure a patent to one-fourth of the area of the prospector's limit. No well shall be drilled within 200 ft. of the exterior boundaries of the lease when adjacent lands are in the Government lease or in complete government ownership. Rentals and royalties are to be charged. Mining of phosphates by means of leases is to be through competitive bidding or by other regulations. General provisions on the bill forbid any person, association, or corporation from holding more than one lease of each of the classes of deposits named in the bill, nor shall any corporation hold any interest as a stockholder of another corporation in more than one lease, nor can any stockholder in a corporation acquire interests in leases beyond the maximum fixed.

THE MINING SUMMARY

The news of the week as told by our special correspondents and compiled from the local press.

ALASKA

CORDOVA

Ore has been cut by the main cross-cut at 700 ft. in the Kennecott company's Jumbo mine. In the Bonanza a new shoot has been opened at 600 feet.

JUNEAU

The Alaska Gold Mines Co. is to issue \$1,500,000 6% debentures, convertible into stock at \$30 per share at any time. The debentures are to be known as 'series B,' callable at 110 after three years from date of bonds, March 1, 1916. The directors state that the issue is necessary to complete mine developments, mill and power construction, etc. D. C. Jackling, on January 12 prepared a brief outline of results in 1915, most of which has been published in this journal.

ARIZONA

Heavy rain and snowstorms have considerably hampered mining and treatment operations in this State during the past week or more.

COCHISE COUNTY

The daily ore output of the Calumet & Arizona is 3000 tons, producing 260,000 lb. of copper. The roof of the flue-dust chamber from the roasting plant is being repaired without stoppage.

GILA COUNTY

In December the Old Dominion produced 2,495,000 lb. of copper. On February 1 a further extension of the sliding-scale for wages at this property will become effective; also by the Miami and Inspiration companies. The latest is based on copper from 22 to 25c. per pound. All classes of labor share in the advance. Miners receiving \$1.40 per shift on 20-cent copper will get \$4.50 on 21c., \$4.65 on 22c., \$4.75 on 23c., \$4.90 on 24c., and \$5 on 25-cent.

At the Inspiration mill 14 of the 18 units are in operation, with a capacity of 10,000 tons per day. Nine units in December produced 6,000,000 lb. of copper.

GREENLEE COUNTY

On January 24 the strikers at Clifton, Metcalf, and Morenci, voted to return to work under the offer made by the managers of the Arizona, Detroit, and Shannon companies on the 8th. A sliding-scale of wages is to be in force, but no union is to be recognized.

MOHAVE COUNTY

(Special Correspondence.)—There are about 100 companies in the Oatman-Kingman district either developing properties or rushing equipment for extensive development. The companies that are most advanced in their work are the Black Range, Boundary Cone, Gold Ore, Carter, United Western, Oatman Gold Mining & Milling, Big Jim, and Ivanhoe. Through their work the proving of a number of the principal vein systems is approaching an interesting stage, and within the next four months this work should verify how correct are the theories relative to the district which have been advanced by a number of prominent mining engineers and geologists. In fact, the Oatman district seems at this time to be entering the most interesting epoch of its history.

Oatman, January 18.

The following remarks were made by Charles E. Knox of Tonopah, Nevada:

"Oatman will in a short time be known as the greatest gold camp in America. Oatman has five well-marked ore zones. There are three mines in the Tom Reed zone, namely, the United Eastern, Tom Reed, and Big Jim. The Big Jim with a 46-ft. vein of good-grade ore now leaves the prospect class and takes its place in the mining column. The owners of the Big Jim may well feel gratified at the remarkable showing and the accuracy with which this work was projected to make this development. Superintendent Keating is to be congratulated not only upon the realization of his geological theories, but the accomplishment of such a great piece of work in such a remarkably short time. I am told that work was started in July, since which time the property has been equipped, the shaft sunk 400 ft., and the cross-cut driven to and through the vein for a distance of 205 ft. This demonstrates that mining conditions in this part are most favorable for cheap and efficient work. I have been shown a number of other very promising properties in the district, some of which have excellent showings even for the small amount of work done at the present time. The best surface showing that I have seen in this, and I might add in any district, is the Times property, some distance north-west from the United Eastern. This property, with a 30-ft. vein, shows at the present time a body of ore for 50 ft. in length, all of a high grade milling character, and in places several feet, the value of which approaches the sensational. Never have I seen better preparations for prospecting and development in a new camp. Fully 25 properties have been well equipped or have that equipment in transit, with well-supplied treasuries which ensure thorough development and will undoubtedly in the near future result in the discovery of other United Easterns and Big Jims. There is every evidence that the East, particularly New York, is becoming deeply interested in Oatman."

The Cerbat Range region, north of Kingman and extending beyond Chloride, has been a great metal producer, and is still considered to have splendid prospects. The previous principal output was silver, but now copper and zinc are being produced; some of the mines being the Copperfield Porphyry, Tennessee, Golconda, Golconda Extension, Payroll, and Rainbow.

PIMA COUNTY

The New Cornelia Copper Co.'s railroad was completed on January 18. Regular service from Gila Bend to Cornelia will commence in two weeks.

CALIFORNIA

Operations in the oilfields as reported to the State Mining Bureau during the week ending January 15 show a sharp falling-off in the number of new wells proposed. There were only five reported as against nearly a dozen each week for the last two months. Other work such as deepening or re-drilling wells was also slightly below the average, but as these are more in the line of routine matters affecting the upkeep of a property less attention is attracted by them. Recent damage by storms will retard production for a few weeks in some of the fields. The work of testing water shut-off, which is carried on directly under the inspection of the Bureau engineers, maintains its usual volume. The importance of inspection is now very generally recognized by operators and the Bureau is taking steps

to maintain its standards of thoroughness in this matter without giving the entire time of its engineers to that branch of the work. The most important work that the Oil Department of the Bureau has undertaken is the study of underground conditions leading to recommendations as to what sands should be developed and what formations may be properly left exposed to water. Lack of uniformity of depth at which various wells have been protected by casing has in the past been a greater cause of damage than has poor workmanship on the part of drilling and cementing crews.

AMADOR COUNTY

The old Zeala mine at Jackson is being reopened by the Kennedy company. A new shaft is being sunk. The Kennedy mine shaft is 3900 ft. deep vertical; it is to sink to 4400 ft. where the two principal veins are expected to junction. The 100-stamp mill continues steady work.

The Argonaut incline shaft is down nearly 1600 ft. The monthly output is around \$60,000.

The South Eureka continues its development in the Oneida mine. Good ore is being mined from 3200 ft. in the Central Eureka.

COLUSA COUNTY

Owing to the high price of quicksilver it is probable that the old mines near Sulphur creek will be reopened. J. W. Cuthbert of Willow Springs is interested in some property there.

EL DORADO COUNTY

(Special Correspondence.)—A 34-ft. vein of 'ribbon-rock' quartz assaying \$14 per ton has been opened at a depth of 130 ft. in the Teddy-Bear claim, situated on the Mother Lode between the old Church-Union and the Laus Padre gold mines. The vein was cut last week while sinking a winze next to the hanging wall in the bottom of a cross-cut adit about 240 ft. in from the portal. Alden D. Fraser, manager for John W. Cover, of Seattle, was present watching sinking operations. The Teddy-Bear property, which was acquired by Mr. Cover about three weeks ago, consists of the Teddy-Bear, St. Croix, Hotspur, Hotspur-Extension, and the Oidinna, situated about five miles south of El Dorado railroad station. Mr. Fraser states that deep-level development will be pushed in a modern manner.

Placerville, January 15.

KERN COUNTY

At a meeting of the directorate of the Yellow Aster Mining & Milling Co., held at Los Angeles on January 21, E. D. Mooers, second vice-president was elected first vice-president, to succeed C. G. A. M. de Pauw, who has ceased to be connected with the concern in an official capacity. Mr. Mooers is the son of the original locator of the Yellow Aster mine, and has had many years experience in the mining business. The officials are as follows: Albert Ancker, president; E. D. Mooers, vice-president; R. L. Burcham, secretary; Carl H. Fry, superintendent; W. J. Cotton, managing director; and Ward Chapman, attorney.

NEVADA COUNTY

(Special Correspondence.)—The Mineral Hill mining district is experiencing a good revival as the result of work done during the past two years by the Queen Regent Merger Mines Co. of San Francisco. The company has contracted for a complete treatment plant to be in full operation by February 15, to treat its ore at the mine at \$3.50 per ton. A percentage of profits applies on the purchase price until the plant is paid for in full, after which it will be taken over and operated by the Queen Regent company. The engineer for the parties interested in the deal reports sufficient high-grade ore developed to pay for the plant in 90 days, as the ore averages \$50 per ton in copper, gold, and silver. The activity of the company has aroused much interest in the district, and properties have

changed hands on which active development will be started at once.

Spencerville, January 15.

The new 5-stamp mill of the Ben Franklin mine will soon be finished. C. J. Bryant is to be in charge. New York people own the property, and are also developing the Alaska adjoining. J. L. Claghorn is representative.

SACRAMENTO COUNTY

At Natoma the Natomas Company of California has constructed a dredge for leveling and re-solling the tailing. This is done by means of a double stacker; one for boulders and gravel, the other for soil. The boat is 100 ft. long, 56 ft. wide, and 12 ft. deep. The buckets are of 15-cu. ft. capacity, and will dig to a depth of 35 feet.

SAN DIEGO COUNTY

Bulletin 620-P of the U. S. Geological Survey, by Waldemar T. Schaller, discusses cassiterite in this county. The tin-bearing area is in an arid region. The claim owners are R. Carson, T. L. Harvey, and D. H. A. Fiske, of Pasadena; they hope to

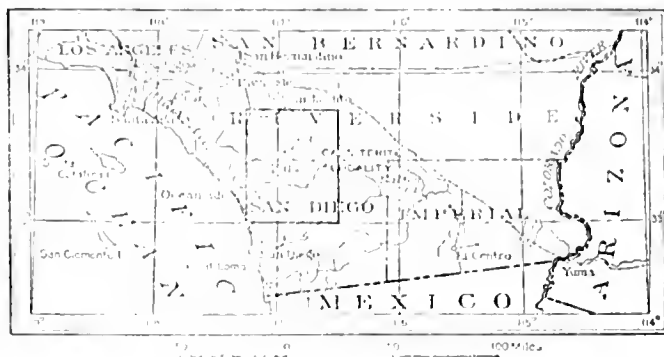

Index map showing position of cassiterite locality in San Diego county. The rectangle indicates the gem tourmaline field of southern California, throughout which are found pegmatite dikes similar to the one described in the bulletin.

do some more work this year. The handful of crystals found in the spring of 1915 was extracted from a single pocket in a flat-lying pegmatite dike, and an examination has failed to offer any hope of finding more in large quantities, although the quantity found exceeds all the occurrences of tin ore in place previously known in the county.

SHASTA COUNTY

(Special Correspondence.)—Mining on the east side of the copper district is fairly active. The drift from the lower adit at the Shasta Belmont has entered promising ore, and is expected to soon cut the vein that yielded rich ore near surface. The adit is being extended 100 ft. The management expects to start shipments in the spring. William Arps is supervising work. The property lies near Copper City.—The Greenhorn, near Tower House, is undergoing vigorous developments, with M. E. Dittmar manager. Driving of the main adit is proceeding quickly to open promising ground beyond the main workings. A good deal of ore is blocked out, and it is probable a concentrating plant will be erected next summer.—C. L. Wilson and associates are working the Arps property, a short distance from the Shasta Belmont. Ore containing copper and manganese has been opened, and development of the lower copper deposits will be done as soon as weather conditions improve. Numerous prospects in this part will be worked next summer, according to owner's statements.

It is rumored the Bully Hill Copper Co. has definitely decided on the building of a zinc smelter near Copper City, and that an offer has been made to the Afterthought Copper Co. with a view to treatment of Afterthought ores at the

plant. The Afterthought mine is near Ingot, and contains large reserves of copper-zinc ore. The company has been contemplating installation of a concentrating plant.

Driving of No. 6 adit is progressing steadily at the Mammoth mine, near Kennett. Production of zinc ore at the rate of \$80,000 to \$90,000 per month continues, and a large quantity is exposed. The Kennett smelter is producing over 1,600,000 lb. of copper per month, including the ore smelted for the Balakala company.

The vein recently encountered on the 1300-ft. level of the Gladstone mine, at French Gulch, is said to be developing well. The 30-stamp mill is running steadily, and a normal force is employed. Development of much new ground is proceeding. E. Young is superintendent.

Redding, January 24.

According to F. H. Dakin, Jr., the Virginia Mining Co., which owns the Uncle Sam mine, has 10 stamps working, and proposes to install a tube or ball-mill of large capacity, also probably a Deister slime-table and a flotation plant.

SIERRA COUNTY

The annual meeting of the Tightner company was held at Grass Valley on January 22. No details of results are available, but prospects for continued large profits are good.

TRINITY COUNTY

The Alta Bert Dredging Co.'s property near Trinity Center has been acquired by the Trinity Development Co. A large dredge may probably be constructed. Other dredging companies along the Trinity river are meeting with good results.

YUBA COUNTY

At Hammonton and Marigold the Yuba Consolidated Gold Fields Co. is constructing a dredge at each place, employing about 125 men on each, resulting in considerable activity.

COLORADO

People who have never wintered in the Rocky Mountains often wonder why some mines suspend operations when winter comes, according to *The Daily Mining Record*. Shareholders in some of these mines are inclined to criticize such action on the assumption that a mine should operate during all seasons. A winter spent in the mountains by these critics would materially change their views. There is no more bleak, lonely and forbidding site than is occupied by the mine, far up in the mountains, that is remote from a town or railway-station. With the thermometer often registering as low as 40° F. below zero, while the narrow roads are hidden under great masses of snow, the transportation of ore becomes impossible. The mine is completely snowed in pending the arrival of spring, and man is helpless to alter the conditions. The occasional miner who ventures from the camp on snowshoes risks his life, although slow to concede the fact. Like many of his kind in the past he may fall a victim to avalanches or snow-slides. Even the mine buildings, in some places, are in danger from this source, as the record of mining disasters bears testimony. Bitter cold, danger, and storms ever surround those who do whatever they can at the mine. It is safer to affirm that any unacclimated Easterner who managed to survive a winter amid such surroundings would acquire an added respect for the miner and fully comprehend why some mines are not operated in the icy winter months.

CLEAR CREEK COUNTY

The Hudson mill, using flotation, is at full capacity, treating 80 tons per day, yielding 20 tons of concentrate.—The Newton mill is treating up to 100 tons per day, producing 20 tons of \$30 concentrate.

LAKE COUNTY (LEADVILLE)

Progress at the Anderson adit into Prospect mountain is

reported to be good, the face being in 1400 ft., in fairly hard ground. Machine-drills are employed.

Within two months the Fortune mine will be producing 1500 tons of carbonate of zinc and gold-silver sulphide ore. A good tonnage is ready for extraction.—High-grade zinc carbonate is being shipped from the Ruby in the Weston Pass district.—The Matchless on Fryer hill is sending 16% carbonate to the Western Zinc Oxide plant, which is improving its metallurgical results.

A storm in the Lackawanna district interfered with work at the Mt. Champion; the aerial tram was damaged somewhat.

On January 18 a great snowslide from Mt. Elbert in Lake county, on mile above Twin Lakes, killed two men, and did \$50,000 damage to the Gordon mine.

SAN JUAN COUNTY

According to F. C. Gilbert, manager of the A. S. & R. smelter at Durango, in a letter to the *Silverton Weekly Miner*, San Juan, San Miguel, La Plata, and Dolores county mines sent the following ore to the plant; an increase in quantity, but practically the same value:

| County. | Tons. | Value. |
|------------------|--------|-------------|
| San Juan | 19,672 | \$915,523 |
| San Miguel | 25,577 | 1,398,696 |
| La Plata | 3,041 | 92,213 |
| Dolores | 13,169 | 241,211 |
| Total | 61,459 | \$2,647,643 |

This smelter is favorably situated to receive ore from La Plata, Ophir, Red Mountain, Rico, Silverton, and Telluride.

SAN MIGUEL COUNTY

A violent storm in the Telluride district last week did an immense amount of damage to mining, power, and railroad companies, especially the Camp Bird, Tomboy, Smuggler-Union, Liberty Bell, Black Bear, Western Colorado Power, and Rio Grande Southern.

TELLER COUNTY (CRIPPLE CREEK)

(Special Correspondence.)—On January 13 a new water-course was cut by the Cripple Creek deep-drainage Tunnel in Elkton ground, not far from the point where the Elkton shaft will connect with the Tunnel when the shaft has been sunk to that level. This resulted in a large increase in the flow of water, equal according to T. R. Countryman, to 2300 gal., making the flow from the portal at the present time about 14,630 gal. per minute. Just previous to cutting the last water-course a strong vein was intersected at a place about 250 ft. from a point directly under the Elkton shaft. This vein was reported to be seven feet wide. Where cut, vein matter was too poor to make it profitable to explore it at present. Later on, however, its development may open ore of commercial grade.

Victor, January 19.

A joint shipment of ore was made over the Short Line to Colorado Springs under armed guard last week by the Cresson, Portland, and Vindicator companies; the total was 175 tons, namely, 50, 25, and 100 tons respectively, averaging \$1430 per ton.

IDAHO

SHOSHONE COUNTY (COEUR D'ALENE)

In spite of bad weather prospecting for tungsten ores is being done in old placer ground near Murray. Several developments are reported.

The National copper mine and mill are employing 50 men. Working a trifle over one shift daily the plant is producing four cars of concentrate per month. The product realizes \$90 per ton. Silver is increasing with depth in the mine. The company has acquired 90% of the Homestake company's stock, adjacent property.

Ore production of the Pine Creek area increases, and a rail way is badly needed. If the steam roads do not make an effort, the mine owners may endeavor to have an electric line constructed. Antimony, lead, and zinc ores are produced.

ILLINOIS

TO DAVIDS COUNTY

(Special Correspondence.)—At Day Siding the Wisconsin Zinc Co. is developing a new mine on the Burkbeck lease. A 100-ton mill and power plant is being constructed.

At Millbrig a new zinc mine is being developed on the Graham land for the Vinegar Hill Co. New 300-ton equipment is under construction, the plant to be ready by April 1.

At Galena the Great Western Mining Co. is operating with an independent zinc ore refinery. The Galena Refining Co. has a new zinc plant ready to go into commission. Seven acres of land has been purchased for a more elaborate establishment, should new processes now being tried prove successful.

Galena, January 29.

MICHIGAN

Houghton County (The Copper Country)

(Special Correspondence.)—For 17 days steadily the district has been fighting one of the old time Lake Superior blizzards, with a continuous wind of hurricane force, a steady fall of snow and the thermometer below zero. With railways it is quite impossible to maintain steady service. Snow-piles 25 and 40 ft. high on either side of the deep cuts are common. The railway men who know how to fight these storms, from experience, say that this has been the worst in 20 years. Keeping the main lines open is not such a difficult task, but getting into the sidings that run ears under the shaft-houses causes great difficulties. The storm is preventing the shipment of ore to the mills. Ordinarily it would necessitate shutting down stamp-mills, and a storm of a few days can be cleared up in a day, but this continuous cold, with snow and wind has caused a great deal of trouble. On January 22 there was sign of abatement, but some mills will have to shut down entirely if it keeps up a few days longer. Hence the copper output in January will be fully 2,000,000 lb. short.

There is every reason to believe that the Onondaga has entered the Nonesuch formation—or the White Pine as it now generally is called—the result of the seventh diamond-drill hole indicates the 'swing' of the lode, and this verifies the geological theory on which the president of the Onondaga, R. C. Pryor, presumed when he commenced the work.

South of the Quincy No. 7 shaft, operated jointly with the Hancock, the latter has opened its best ground on No. 68, 69, and 70 levels. Over 300 men are employed at the mine, producing 400 tons daily.

On No. 22 level of the Franklin the shoot of rich ore is 700 ft. long. This lode has been opened at a lower level also.

It is rumored that the Ojibway and Oneco mines are to be re-opened; but nothing definite has been announced.

Houghton, January 22.

It is said that the Calumet & Hecla will probably commence issuing quarterly reports, similar to the great porphyry companies; also an estimate of production for each month.

At the present rate of production the Wolverine is estimated to have 20 years' life.

In 1915 the Mohawk yielded 15,800,000 lb., an increase of 4,700,000 lb. Profits were \$1,000,000 more than in 1914, equal to \$14 per share, against \$4.31.

Owing to a fire in some old workings at combination shaft No. 5 and 6 of the Calumet & Hecla, a U. S. Bureau of Mines rescue-car is at Calumet giving aid. The fire is not considered dangerous.

The New Arcadian company is to sell some of its land to the New Baltic company for \$40,000 cash and 14,000 shares in the latter.

On February 1 most of the iron-mining companies in this State will raise wages 10%. This will also be effective in Minnesota. A total of over 30,000 men will benefit.

MISSOURI

JASPER COUNTY

The 'Mining Edition' of the *Joplin Globe* for January 16 covers 70 pages, including statistics, progress, and photographs of the zinc-lead region. The output of zinc concentrates in 18 years totals 4,858,023 tons, worth \$194,535,410, and 675,828 tons lead valued at \$37,025,768.

There was not much change in ore prices during the week ended January 15. The output was 4576 tons blende, 187 tons calamine, and 778 tons lead, averaging \$94, \$73, and \$72 per ton respectively. The total value was \$498,619.

Hand-digging operations on some land near Spring City has been stopped by an order of the Court, until arrangements are made to prevent the sludge flowing on to land of agricultural value.

To drain its land the Missouri Lead & Zinc Co. may install a modern pumping plant costing \$8000 or \$10,000 at its new Paxton shaft at Joplin. A Diesel engine would be part of the equipment.

MONTANA

PARK COUNTY

The tungsten claims of N. E. Franklin, H. Schnitzel, and F. R. Baldwin at Jardine are to be developed.

SILVERBOW COUNTY

While copper remains at 20c. per pound or over, about 20,000 men employed by the Butte companies will receive \$4.25 per day, an advance of 25c. The new rise was effective on January 15. The pay-rolls are now at the rate of \$2,100,000 per month.

The Anaconda company has purchased the Butte-Alex Scott mine for \$750,000. The present output is 180 tons of ore daily.

It is likely that the Tnolunne will be closed, as the present daily output of 125 tons of 2.5% ore is not profitable. Absorption by the Anaconda or North Butte is possible.

NEVADA

ESMERALDA COUNTY

Recent development in the Jumbo Extension has given great satisfaction. The Velvet shaft is down 900 ft. New ground is yielding most of the ore. Raise 555-A is producing \$60 to \$150 ore. Within 180 ft. of the Merger boundary drifts are opening rich ore between 900 and 975 ft. The new vein, opened by a cross-cut from old workings on No. 3 level, assays \$63 per ton.

East and west cross-cuts are still being driven from the bottom of the winze from the 500-ft. level in the Sandstorm-Kendall. Fifty tons of \$22 to \$30 ore every other day is the Atlanta's output, mostly from 1580 ft. depth. Water has interrupted work in the winze below 1750 ft., where good ore is showing. Development at the Kewanas is reported to be satisfactory.

HUMBOLDT COUNTY

The late development in the Colligan workings on the Weaver No. 2 of the Rochester Mines Co. is considered by the management one of the most important since the beginning of Rochester. The vein now discloses 4 ft. of \$70 ore. It proves the extension of the west vein of the Crown Point No. 1 more than 600 ft. to the south, or an entire distance of 1400 ft. through which this vein has been opened along a strike in Rochester Mines ground. A new vein has been cut in the raise from the Friedman adit of the company, which is now showing 5 ft. of \$25 ore. It was found 100 ft. above the adit. Its extent is not known because the raise is still in ore.

Shipments are to be started from the Shepherder's Dream mine at Willard, under lease to L. J. Kaiser.

From April 1 to December 31, 1915, the Rochester Mines Co.'s mill treated 23,090 tons of ore averaging \$14.75 per ton. Bullion recovered was 3131 oz. gold, and 545,959 oz. silver, worth \$332,818. Out of the 203 days' work there were interruptions on 72 days.

LINCOLN COUNTY

During 1915 the Pioche district shipped 92,000 tons of gold, silver, lead, copper, and zinc ores to Utah smelters, a record. The Prince Consolidated produced most of this, followed by the Amalgamated Pioche, and Bristol. Freight to Utah is \$1.75 per ton. The current year will show a considerable increase.

During 1915 the new mill of the Yuba Leasing & Development Co. at Pioche was destroyed by fire. The loss is \$40,000. Arson is suspected as the cause. The plant will probably be rebuilt, according to the president, A. C. Smith. Two men were recently killed in the mine.

Regular shipments of 50 to 60% lead and 20 to 25-oz. silver ore continue to be sent from the Groom mines, in the southwest of this county, to Utah smelters. Teams haul the ore to the Las Vegas & Tonopah line, 57 miles.

NYE COUNTY

Six companies and lessees at Tonopah last week produced 8520 tons of ore worth \$178,620. The Extension and West End shipped 83,835 and 52,196 oz. bullion respectively. In the former great importance is attached to the winze being sunk from 1350 to 1540 ft. It is 19 ft. wide and 10 to 12 ft. across the vein. It is intended to make this a three-compartment winze for deeper work.

Some December returns were as follows:

Belmont, 12,706 tons averaging \$12.15 per ton, with \$80,135 profit; Jim Butler, profit of \$22,006 from 3981 tons; and Tonopah Mining, 12,225 tons averaging \$12.45, with \$56,025 profit. The last named treated ore worth \$492,637 in its last quarter, of which \$201,048 was net. Other income was \$123,210. On January 21, \$150,000 was distributed.

WHITE PINE COUNTY

According to G. L. Sheldon in the *White Pine News* of Ely, tungsten was discovered in this county 17 years ago by Charles Gaby. This was on ground of the present United States Tungsten Co., in the Snake range, 12 miles south of Osceola. Developments now consist of a 1700-ft. adit, obtaining a vertical depth of 700 ft. on one vein. An upper adit has opened a 400-ft. continuous shoot. The formation is granite, and the ore mostly hübnerite. A mill is in operation. Six years ago G. G. Sims found hübnerite 40 miles north of Osceola. An extensive deposit has been traced. A mill is working. A 20-ton plant is crushing scheelite on another property, 8 miles west of Garrison, Utah, over the line in Nevada. Scheelite has been recently found in other districts, probably the best near Mt. Washington, at an elevation of 9500 ft. The veins are small, but high grade.

NEW MEXICO

GRANT COUNTY

(Special Correspondence.)—The Royal John Mining Co., which has taken over the old Grand Central zinc and lead property, 28 miles east of Santa Rita in the Black range, is now employing 100 men. Work at present consists in developing the orebodies, re-modeling the old mill, (the jigs being replaced by concentrating tables) and constructing a ten-mile road from the mine to the Mimbres Hot Springs road. This company has just blown-in a smelter at Pittsburg, Kansas, for the treatment of concentrates from the Royal John mine. George E. Cox is geologist, and A. O. Ihlseng is metallurgist for the company.

Santa Rita, January 10.

OKLAHOMA

WASHINGTON COUNTY

The Bartlesville Zinc, Lanyon Starr, and National Zinc companies, operating smelters at Bartlesville, and employing 1200 men, increased wages by 25c. per shift on January 17. Wages vary from \$2.35 to \$4.50 per day. One reason for this raise was to avert any possible strike, as there has been labor trouble at the smelters at Caney, Kansas, a few miles north. These Bartlesville plants were described in the *PRESS* of July 11 and 25, and August 8, 1914.

SOUTH DAKOTA

LAWRENCE COUNTY

From isolated pockets in the Hidden Fortune ground the Homestake company has nearly extracted another car of wolframite. The B. & M. hoist and other machinery is expected to be ready in April.

TEXAS

ZAPATA COUNTY

(Special Correspondence.)—A new natural gas field is being developed near the Rio Grande, 50 miles from Laredo. The Boredr Gas Co.'s well has a flow of 30,000,000 cu. ft. per day. There are indications of oil. The gas is to be piped to Reiser, 18 miles, then connected with the line that already goes to Laredo.

A large gas-well was recently brought-in near Corpus Christi by the Guffey Petroleum Co. Gas was struck at 2700 ft., and the pressure is tremendous. The well is 'wild' at present.

The gas fields of north and central Texas were recently investigated by G. C. Matson and E. W. Shaw of the Federal government. They reported that the Petrolia field is 40% exhausted. The Lone Star Gas Co. supplies Fort Worth and Dallas from this field.

Other gas areas are being explored.

Austin, January 10.

UTAH

JUAB COUNTY

The heaviest fall of snow ever recorded is reported from the Tintic district during the first three weeks of January, and it is with difficulty that the railroads are operated.

As long as lead is 4.5c. per lb. and silver 56c. per oz. or over, the Chief Consolidated will pay its 300 men an increase of 25c. per day.

Continued interest is taken in the important shoot of copper at 1000 ft. in the Iron Blossom.

The Utah Minerals Concentrating Co. at Tintic is in the market for tungsten ores. At the plant of the Utah Ore Sampling Co. at Murray the former will pay \$22 per ton for 2%, \$39 for 3%, \$85 for 4%, and \$108 for 5% ore.

SALT LAKE COUNTY

The Utah Copper and other companies at Bingham have advanced wages from 15 to 25c. per day, the former effective on January 1 and the latter on February 1, to remain in effect as long as copper is 20c. or over a pound. The principal companies affected by the increase in wages are the Utah Copper, the United States, Utah Consolidated, Utah-Apex, Utah Metals, Bingham Mines, and Ohio Copper.

According to the manager of the Cedar-Talisman Consolidated Mines Co., S. S. Pond, a great deal of 11% zinc ore has been developed, apart from the richer ore. An electrolytic plant of 10-ton capacity, costing \$10,000, is proposed for experiments. Sales of zinc and lead ores in 1915 realized \$9226. Operations left a loss of \$2468. Cash amounts to \$1877.

Lessees at the Michigan-Utah at Alta last year mined 4036 tons of dry ore averaging \$9.83 per ton, a large decrease compared with 1914.

SUMMIT COUNTY

When lead is 30c per lb. and silver 55c per oz. or over the Lady Judge, Daly West, Ontario, and Silver King Consolidated, companies at Park City will increase wages 25c per day. When lead recedes to 5c, and silver rises to 70c or over, the increased wages will continue in force. When prices of both metals are less than these, wages will revert to the old scale. The Silver King Coalition is expected to offer the same rates. In the Park City district at present miners and "muckers" are paid \$7, machine men, \$1.25, shaft-men, \$4, car-men, \$3, motor men \$1.75, mill-men, \$3, and hoisting engineers \$4 per shift.

Schools and Societies

The UNIVERSITY OF CALIFORNIA has issued its Register for 1915-16 with announcements for 1915-16. It covers 236 pages in the various divisions, wherein are given the faculty, courses, colleges, names of students, etc. The second half-year in the academic colleges commenced on January 3. The publication was prepared by the U. of C. press at Berkeley.

The Southern California section of the A. I. M. E. meets at Los Angeles on February 1. The feature of the evening will be the reading of a group of valuable papers on 'Petroleum, its Geology and Technology.' The contributors will be Ralph Arnold, William F. Staunton, Robert B. Moran, and W. R. Hamilton. A full attendance is urged.

The Colorado School of Mines at Golden announces that as its first prospectors' course early in 1915 was so successful, an enlarged course will be held from January 31 to March 1, 1916. Instruction is to include 50 hours in prospecting geology, 30 in chemistry, 5 in metallurgy, 5 in placer mining, 10 in lode mining, 10 in mining claim law, and mine-rescue and first-aid work. The full course costs only \$2.

Thirty-three mining men, with experience varying from 1 to 25 years, have enrolled in the 19th annual three months' short session of the College of Mines, UNIVERSITY OF WASHINGTON, Seattle. At the annual smoker tendered the short session miners by the student branch of the A. M. I. E., R. H. Stretch of the Alaska Bureau, Seattle Chamber of Commerce, gave an address on 'The Mineral Belts of Alaska.'

The Colorado School of Mines at Golden is starting to do a good deal of work on flotation, based on the laboratory machines, up to installations that will handle from five to eight tons per day investigation work. The board of trustees has just established a new department, that of research and testing, and all such matters will hereafter be referred to that department and publications made from time to time.

THE MEXICAN MASSACRE

The following resolution was passed at the meeting of the board of directors of the A. I. M. E. on January 21:

Resolved, That this Board has learned with indignation and sorrow of the unprovoked and brutal murder of 18 American citizens on January 19 in the State of Chihuahua, Mexico, and laments especially the death of C. R. Watson, C. A. Pringle, H. C. Hase, and W. J. Wallace, who were members of the Institute. As these men and their companions were engaged in the lawful prosecution of their work, we trust that nothing will be allowed to prevent or delay appropriate action by our Government concerning the outrage by which they lost their lives.

Resolved, That the sincere sympathy of this Board and of all members of the Institute is extended to the families and friends of C. R. Watson, C. A. Pringle, H. C. Hase, and W. J. Wallace. And be it further

Resolved, That a copy of this resolution be sent to the Secretary of State of the United States, be published in the Institute's Bulletin, in the press, and be sent to the families of the deceased members.

PERSONAL

C. W. MORSE is at El Paso.

WILLIAM BRAUN is on his way to Chile.

FRANK H. PROBERT was at Batuman this week.

J. B. TYRRELL is leaving Toronto shortly to go to England.

GEORGE B. CHURCH has returned from Alaska to New York.

L. F. S. HOLLAND is examining mines at Patagonia, Arizona.

SHIRWOOD ALDRIDGE of New York is at the St. Francis hotel.

EDGAR RICKARD is due to arrive at New York today on the *Rotterdam*.

G. G. S. LINDSEY is expected shortly at Toronto on his return from China.

H. Y. WALKER, manager of the Tacoma smelter, was in San Francisco this week.

WILBUR H. GRANT has returned from examining a molybdenum property at Shultz, Arizona.

JOHN W. FISCH is in New York; he is planning to take a voyage for his health in the Orient.

ROBSON T. WHITE, manager for the Caucasus Copper Co., has arrived in New York from Batoumi.

BEN B. THAYER and L. D. RICKETTS expect to sail from New York to Valparaiso, Chile, in a few days.

WILLIAM HAGG succeeds A. D. FOOTE as manager of the Tightner Mines Co. of Sierra county, California.

K. SINGENO left Yokohama on January 8 to come to this country to investigate the conditions of the copper market.

CHARLES W. MORSE has been promoted to concentration engineer, a newly created position at the Washoe plant of the Anaconda company.

W. G. MILLER and T. W. GIBSON of the Ontario Nickel Commission are in Cuba. G. T. HOLLOWAY, chairman of the Commission, has returned to London.

M. P. BRAFFET, member of the executive committee of the American Mining Congress, has been elected president of the Salt Lake Stock and Mining Exchange.

E. L. S. WRAMPFELMIEER, formerly superintendent of the Erie mine at Gaston, Nevada county, California, has taken an office in the First National Bank Bldg., San Francisco.

GEORGE S. RICE, chief mining engineer of the U. S. Bureau of Mines, advises that his official headquarters will be at Washington, D. C., after January 15, and not at Pittsburg, Pennsylvania.

T. A. RICKARD will deliver a series of lectures on the application of geology to mining at the College of Mining of the University of California, at the following times: 4 p.m. on January 31, February 2 and 4, and 5 p.m. on February 1 and 3.

H. A. J. WILKENS and W. B. DEVEREUX, JR., have formed a partnership to carry on the general business of consulting mining engineers and mine managers under the name of Wilkens and Devereux, with offices at 120 Broadway, New York. They will be represented by O. F. WESTLUND at Mexico City and G. S. DUNCAN in London.

EDWARD N. MAGNER, president of the Aurora Mines Co., Nevada, died at Los Angeles, January 1. He was born at Paris, Illinois, June 4, 1858. He went to Leadville, and later to Creede, in the early days of those districts, and was prominent in their early development. Later he operated at Silver City, New Mexico, for 15 years, and from there he went to Salmon City, Idaho, remaining nine years. He was married at Butte, in 1897. His widow survives him.

The Idaho Mining Association met at Boise on January 25. Mining law revision, leasing, and prospecting were discussed.

THE METAL MARKET

METAL PRICES

San Francisco, January 26.

| | Cents per pound. |
|--|------------------|
| Antimony | 44 |
| Electrolytic copper | 26 |
| Pig lead | 6.35—7.30 |
| Quicksilver (per flask) | \$275 |
| Spelter | 21 |
| Tin | 43 |
| Zinc-dust, 100-kg. zinc-lined cases..... | 30 |

ORE PRICES

San Francisco, January 26.

| | |
|---|---------|
| Antimony: 50% product, per unit..... | \$2 |
| Chrome: 40% and over, f.o.b. cars California, per ton..... | 15—18 |
| Magnesite: crude, per ton, f.o.b..... | 7.50—10 |
| Magnesite: plastic, no iron and lime, calcined, per ton..... | 50 |
| Magnesite: refractory, up to 7% iron, calcined, per ton..... | 30—40 |
| Manganese: 50% metal, 8% silica, per ton, f.o.b. cars, S. F. | 12 |
| Tungsten: minimum 65% WO ₃ , per unit for spot..... | 40—50 |

Tungsten production will be less on account of the Atolia, California, mill being burned, as noted on the last page of this issue.

New York, January 21.

| | |
|---------------------------|--------|
| Antimony: per unit | \$2.20 |
| Molybdenite: per lb. | 1.40 |

Indian manganese ore, suitable for the production of 80% ferro-manganese, is quoted at 75c. per unit, Baltimore.

EASTERN METAL MARKET

(By wire from New York.)

NEW YORK, January 27.—Copper is firm owing to exports; there is a heavy export enquiry for lead; zinc is active and strong.

SILVER

Below are given the average New York quotations, in cents per ounce, of fine silver.

| Date. | Average week ending |
|--------------|---------------------|
| Jan. 20..... | 56.75 |
| " 21..... | 56.87 |
| " 22..... | 57.25 |
| " 23 Sunday | 57.62 |
| " 24..... | 57.37 |
| " 25..... | 57.00 |
| " 26..... | 57.14 |

Monthly averages.

| | | | | | |
|-----------|-------------|-------------|------------|-------|-------|
| Jan. | 1914. 57.58 | 1915. 48.85 | July | 54.90 | 47.52 |
| Feb. | 57.53 | 48.45 | Aug. | 54.35 | 47.11 |
| Mch. | 58.01 | 50.61 | Sept. | 53.75 | 48.77 |
| Apr. | 58.52 | 50.25 | Oct. | 51.12 | 49.40 |
| May | 58.21 | 49.87 | Nov. | 49.12 | 51.88 |
| June | 56.43 | 49.03 | Dec. | 49.27 | 55.34 |

The above quotations speak for themselves, a strong and rising market. On January 22 silver worth \$370,491 left San Francisco for China. Exports from England during 1915 totaled £3,781,500 to India and £7000 to China, against £5,219,500 and £12,000, respectively, in 1914.

Samuel Montagu & Co.'s 'Annual Bullion Letter' has been issued. We will abstract from it in an early issue.

According to 'The Financial Times,' London, the most striking feature of last year in silver is the fact that for the first time for a long period the normal laws of supply and demand dominated the situation, no forward business preventing speculation.

COPPER

Prices of electrolytic in New York, in cents per pound.

| Date. | Average week ending |
|--------------|---------------------|
| Jan. 20..... | 24.12 |
| " 21..... | 24.50 |
| " 22..... | 24.87 |
| " 23 Sunday | 25.37 |
| " 24..... | 25.37 |
| " 25..... | 25.37 |
| " 26..... | 25.37 |

Monthly averages.

| | | | | | |
|-----------|-------------|-------------|------------|-------|-------|
| Jan. | 1914. 14.21 | 1915. 13.60 | July | 12.26 | 19.09 |
| Feb. | 14.46 | 14.38 | Aug. | 12.34 | 17.27 |
| Mch. | 14.11 | 14.80 | Sept. | 12.02 | 17.69 |
| Apr. | 14.19 | 16.64 | Oct. | 11.10 | 17.99 |
| May | 13.97 | 18.71 | Nov. | 11.75 | 18.88 |
| June | 13.60 | 19.75 | Dec. | 12.75 | 20.67 |

Exports during the week ended January 8 totaled 18,932,168 lb., worth \$3,888,980. England secured 2,457,288 lb., and France 15,957,697 lb. Imports amounted to 3,944,438 lb., valued at \$563,194. Chile sent 1,586,803 lb., and Japan 826,671 pounds.

The Anaconda company has acquired mines and a railway in Chile and organized the Andes Copper Mining Co., and Potterrellos Railway Co. to operate them, with a capital of \$50,000,000 and \$5,000,000 respectively.

LEAD

Lead is quoted in cents per pound, New York delivery.

| Date. | Average week ending |
|--------------|---------------------|
| Jan. 20..... | 5.90 |
| " 21..... | 6.10 |
| " 22..... | 6.10 |
| " 23 Sunday | 6.10 |
| " 24..... | 6.10 |
| " 25..... | 6.10 |
| " 26..... | 6.10 |

Monthly averages.

| | | | | | |
|-----------|------------|------------|------------|------|------|
| Jan. | 1914. 4.11 | 1915. 3.73 | July | 3.80 | 5.59 |
| Feb. | 4.02 | 3.83 | Aug. | 3.86 | 4.67 |
| Mch. | 3.94 | 4.01 | Sept. | 3.82 | 4.62 |
| Apr. | 3.86 | 4.21 | Oct. | 3.60 | 4.62 |
| May | 3.90 | 4.24 | Nov. | 3.68 | 5.15 |
| June | 3.90 | 5.75 | Dec. | 3.80 | 5.34 |

QUICKSILVER

The primary market for quicksilver is San Francisco, California being the largest producer. The price is fixed in the open market, according to quantity. Prices, in dollars per flask of 75 pounds:

| Date. | Week ending |
|--------------|-------------|
| Dec. 29..... | 135 |
| Jan. 5..... | 150 |

Monthly averages.

| | | | | | |
|-----------|-------------|-------------|------------|-------|--------|
| Jan. | 1914. 39.25 | 1915. 51.90 | July | 37.50 | 95.00 |
| Feb. | 39.00 | 60.00 | Aug. | 80.00 | 93.75 |
| Mch. | 39.00 | 78.00 | Sept. | 76.25 | 91.00 |
| Apr. | 38.90 | 77.50 | Oct. | 53.00 | 92.90 |
| May | 39.00 | 75.00 | Nov. | 55.00 | 101.50 |
| June | 38.60 | 90.00 | Dec. | 53.10 | 123.00 |

The local and New York markets are bare of supplies, and \$300 is possible. Out of a recent shipment of 400 flasks by the Western Pacific line, 35 were lost off the train in Plumas county.

ZINC

Zinc is quoted as spelter, standard Western brands, New York delivery, in cents per pound.

| Date. | Average week ending |
|--------------|---------------------|
| Jan. 20..... | 18.75 |
| " 21..... | 18.87 |
| " 22..... | 19.00 |
| " 23 Sunday | 19.00 |
| " 24..... | 19.00 |
| " 25..... | 19.25 |
| " 26..... | 19.25 |

Monthly averages.

| | | | | | |
|-----------|------------|------------|------------|------|-------|
| Jan. | 1914. 5.14 | 1915. 6.30 | July | 4.75 | 20.54 |
| Feb. | 5.22 | 9.05 | Aug. | 4.75 | 14.17 |
| Mch. | 5.12 | 8.40 | Sept. | 5.16 | 14.14 |
| Apr. | 4.98 | 9.78 | Oct. | 4.75 | 14.05 |
| May | 4.91 | 17.03 | Nov. | 5.01 | 17.20 |
| June | 4.84 | 22.20 | Dec. | 5.40 | 16.75 |

Ore prices were higher at Joplin last week, averaging \$104 per ton for 60% zinc, \$76 for 40% calamine, and \$77 for 80% lead. The total value was \$937,676.

TIN

Prices in New York, in cents per pound.

| Date. | Average week ending |
|--------------|---------------------|
| Jan. 20..... | 37.85 |
| " 21..... | 37.23 |
| " 22..... | 38.10 |
| " 23 Sunday | 36.10 |
| " 24..... | 33.29 |
| " 25..... | 33.29 |
| " 26..... | 30.72 |

Monthly averages.

| | | | | | |
|-----------|-------------|-------------|------------|-------|-------|
| Jan. | 1914. 37.85 | 1915. 34.40 | July | 31.60 | 37.38 |
| Feb. | 39.76 | 37.23 | Aug. | 50.20 | 34.37 |
| Mch. | 38.10 | 48.76 | Sept. | 33.10 | 33.12 |
| Apr. | 36.10 | 48.25 | Oct. | 30.40 | 33.00 |
| May | 33.29 | 39.28 | Nov. | 33.51 | 39.59 |
| June | 30.72 | 40.26 | Dec. | 33.60 | 38.71 |

Tin is quiet at 41.87 cents.

The Wah Chang Mining & Smelting Co. quotes its 'WCC' brand antimony (99.7%) at 43c. spot; February shipment 33c. c.i.f. in bond.

Eastern Metal Market

New York, January 21

In the past week activity has been monopolized by zinc, for which there has been a good demand for both spot and first quarter deliveries. Prices have advanced day by day. Copper is higher, although the market has been very dull. Re-sale metal has been eliminated from the market and the producers control the situation. For spot copper 25 to 26c. is asked. The market was flooded January 21 with wild reports, some of these to the effect that 39c. had been offered and refused for spot electrolytic. The reports were quickly denied, but there is no question about the market being extremely strong. London is exceptionally strong, despite the plan of the Government to fix the price at a certain figure. Lead has strengthened at London, likewise in the New York market, and while the domestic trade is quiet, some big export orders are understood to be pending. Tin is almost without features of interest in a fairly strong market. Antimony is higher because of the scarcity. Aluminum is unchanged.

The steel mills are wrestling with delivery problems growing out of the pressure of demand and the railroad freight congestion. Three boiler-shops in the State of New York have been compelled to shut-down because they cannot get plates, a product for which the shipyards have created an enormous demand. Structural material is selling at 2c. and over, Pittsburg, and in view of the further fact that the prices of brick and cement have advanced, building operations are being restricted. Agents for the Allies have placed an order for 30,000 tons of steel-rounds for shells, delivery to be made after the first of July. The price of such rounds ranges from 3 to 4c. per lb. Pig-iron was quiet following the holidays, but is becoming active again. Considering the present rate of steel production there is every prospect of a shortage of ferro-manganese.

ZINC

The dullness referred to last week gave way to an excellent demand, especially for prompt and first quarter deliveries, and quotations have moved steadily upward. Prompt is quoted today at about 18.75c., New York, and 18.50c., St. Louis. An influence which led to the greater activity was the freight congestion in New England, which caused the New York, New Haven and Hartford railroad to declare an embargo on all save perishable freight. Connecting railroads did the same, with the result that shipments from the West were seriously interfered with. Some mills were in such distress that they had considerable quantities shipped to them by express. This week following the good demand for spot and first quarter, there developed a lively market for second-quarter deliveries, and sales were made at 15.50 to 15.75c., St. Louis. February is quoted at about 19.37c., New York, and March at about 17.75c. But little of the buying is attributed to the galvanizing interests. Exports from January 1 to 20 total 3262 tons.

Sheet-zinc, car-load lots, is quoted at 23c. f.o.b. mill, 8% off for cash.

COPPER

The producers of copper have a firm hold on the situation, and while business is quiet quotations are stronger at higher levels than prevailed a week ago. Spot electrolytic is held at 25 to 26c., 30 days, delivered, and Lake is quoted at the same range but is entirely nominal. There is little or no re-sale metal offered, either Lake or electrolytic. The situation at London is strong, but peculiar, as the electrolytic quotation January 20 reached £117, despite the announcement that Great Britain had fixed £100 as the maximum price for refined copper. Since the announcement appeared there have been three advances in electrolytic. Information as to what the British

government is doing is meagre. The quiet that now prevails in the domestic market is no cause for surprise in view of the vast quantities which were taken by consumers up to the end of December, and well into January. Meanwhile the producers are in a most comfortable position, and can afford to maintain prices and await the development of further requirements. An interesting announcement is that the Department of Commerce will discontinue, at the end of the present month, its weekly announcements as to the exports and imports of copper. It is explained that business is now more settled, and that the reports are not as useful or important as they were. Stocks of refined copper in Great Britain and France continue to decline. Their total on January 15 was 11,681 tons, against 12,341 tons at the end of December. Exports up to January 20 totaled 11,230 tons. Exports in 1915, as compiled by C. Mayer secretary of the New York Metal Exchange, totaled 270,701 tons, against 350,229 tons in 1911, 382,310 tons in 1912, 327,965 tons in 1912, and 336,891 tons in 1911. Mr. Mayer apportions the exports in 1915 and 1911 as follows, in tons of 2240 lb.:

| | 1915. | 1911. |
|-------------------------|----------------|----------------|
| United Kingdom | 79,585 | 87,556 |
| France | 98,200 | 66,326 |
| Germany | | 88,152 |
| Holland | 1,678 | 58,910 |
| Belgium | | 2,876 |
| Austria | | 13,809 |
| Italy | 44,705 | 26,068 |
| Denmark | 2,426 | 3,950 |
| Norway and Sweden | 19,958 | 8,619 |
| Russia | 20,456 | 425 |
| China and Japan | 119 | 1,910 |
| Sundries | 3,577 | 1,268 |
| Total | 270,701 | 350,229 |

LEAD

A week ago the market was weak because of the announcement that Great Britain would undertake the regulation of both buying and selling lead in England. The tone of the market became weak, but prices did not suffer much. Since then London has gathered strength, the quotation for spot on December 20 being £31 15s., and the better tone has been reflected here. The principal interest adhered to 5.90c., New York, until January 21, then advanced its quotation to 6.10c., an advance of \$1 per ton. St. Louis stood January 20 at 5.82½c., but in the week has been as low as 5.70c. The domestic demand has been quiet, but there are continued reports of large export inquiries. If business has resulted from these it has gone to the few larger producers. Exports from January 1 to 20 totaled 3355 tons.

TIN

The trouble with delayed cables from London lasted until the end of last week and demoralized business at New York. This week messages have come through more promptly, and on one or two days a good business has been done. The cable delays are attributed to the severity of the censor which created a congestion. Spot-tin was quoted yesterday at 41.50c. The arrivals this month total 3100 tons, and there is 6000 tons afloat, so there would appear to be no reason for consumers to worry over the sufficiency of the supply.

ANTIMONY

The market is without feature except for the continued scarcity of spot metal which has caused quotations to become still stronger. Both American antimony and Chinese and Japanese grades are quoted at 42 to 42.50 cents.

Ore and Spelter Price Comparison

The accompanying chart, from the *Joplin Globe*, shows the prices for zinc concentrate (60% metal), and zinc in the Missouri-Kansas-Oklahoma region during the past two years. The generally close agreement in market movements is easily

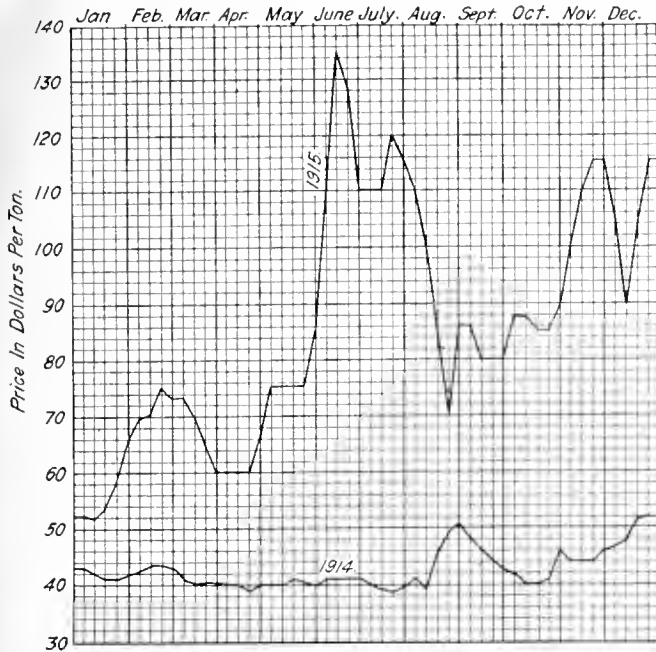

Zinc Concentrate Prices at Joplin in 1915 and 1914.

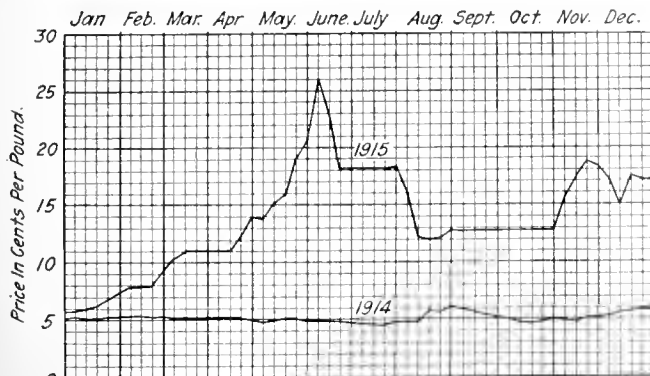

Spelter Prices in 1915 and 1914.

observed, although at two periods the two commodities did not move together as much as ore producers would have liked. The average for concentrate in 1915 was \$77.84 per ton, and spelter 14.16c. per pound.

Antimony in 1915

Antimony prices in 1915 were probably the highest known since the metal became a regular article of commerce. The high prices led to the largest production the United States has made, and probably the same statement is true for the world's production. According to preliminary figures collected for the U. S. Geological Survey by Frank L. Hess, the production of antimony ores in the United States is estimated to have been about 5000 tons containing 2000 tons of antimony, valued at about \$325,000. The largest previous domestic production was in 1892, when 150 tons of metal was produced in San Francisco from Nevada ores, and 380 tons of ore containing 55% of antimony was exported. Practically all operations of the past year were new, most were small, and they were widely

scattered so that it is difficult to obtain close figures immediately after the close of the year.

Antimony, which in July 1914 had been down to a monthly average price of 7.11c. for Cookson's, and from 5.44 upwards for other brands, rose gradually though unsteadily, to the end of 1915 when Chinese, Japanese, and American antimony were quoted at about 40c. a pound. Quotations for Cookson's antimony ceased in May, 1915, some time after an embargo had been declared against the shipment of antimony metal or ores from the British possessions, and 50c. a pound is said to have been paid for it about June 1, when Chinese was selling for about 35c. or less. In the fall, American antimony appeared on the market for the first time in many years. At first it sold slightly below Chinese and Japanese, but was soon quoted at the same price. Miners and smelters, apparently thinking that the high prices would be temporary, did not begin production as quickly as they otherwise might have done, but before the close of the year properties in Alaska, California, Idaho, Nevada, Oregon, Utah, and Washington were producing. Prices for ores ranged from \$1 to \$2.10 per unit of antimony. At first, only ores carrying 50% or more antimony were in demand, but before the close of the year 20% ores were being shipped from Nevada.

From Alaska, according to data collected by Alfred H. Brooks, about 685 tons of stibnite ore carrying 58% metal was produced in the Fairbanks district from properties on Eva, Vault, Treasure, and Chatham creeks. It is reported that 132 tons was shipped from Nome, but it seems probable that more was mined.

The largest production was made from deposits near Wild Rose springs, on the north-west slope of Telescope peak in the Panamint range, California. These deposits have been known for many years, but have been too far from railroads for profitable exploitation until the past year when prices were high and a branch railroad was built to Trona on Borax lake, within about 25 miles of them. The deposits contained considerable antimony other as well as stibnite, and were mined by the Merchants Finance Co. (Western Metals Co.) The same company operated deposits 30 miles north-east of Mojave, which are 10 miles from the S. P. R. R. at Nenralia, in Kern county. Other deposits were mined in California at many points in Kern county, in the eastern end of San Benito county, and on Moore's Flat near Grass Valley. In Nevada considerable quantities were mined at many points mostly in the north-west quarter of the State with Lovelock as a centre, but ranging from Pass canyon in the Pine Forest range southward to the vicinity of Tonopah and eastward to Joy.

Oregon, Washington and Idaho produced small quantities of ore, and in Arkansas a company was organized to work old properties west of Gilham.

The Chapman Smelting Co. of San Francisco which had been idle for a number of years again started the smelting of antimony ores. The company mined ore at Bernice, 60 miles east of Fallon, Nevada, and brought ores from other points in the Western States, Alaska, and British Columbia.

The Merchants Finance Co. built an antimony smelter at Industrial Harbor, Los Angeles. Besides operating California mines the company operated mines in Nevada and brought ores from the Western States, Alaska, and foreign countries.

The Antimony Smelting & Refining Co. of Seattle started a plant at Van Asselt the last of the year and made oxide, but metal is to be smelted also.

The International Smelting Co. bought ores to be smelted at its South Chicago plant. The Great Western Smelting & Refining Co., of Chicago, and the Pennsylvania Smelting Co. of Pittsburg, have also smelted some ores. The Magnolia Metals Co. found so much difficulty in obtaining needed supplies of antimony at a reasonable price that it bought and mined ores in Nevada, smelting them at Brooklyn.

Harshaw, Fuller & Goodwin Co., of Cleveland were in the market for pure ores from which to make antimony salts,

heretofore made from Chinese crude antimony. [Notes on antimony production in China will appear soon in the Press Column.]

The tendency has been for some companies to go to an expense for mine development, machinery, and mills, not wholly warranted by the circumstances. The present high prices are necessarily temporary. The Chinese deposits are extensive, and worked by very cheap labor, and other deposits are being developed in other parts of the world, and as soon as the War is over, and possibly before, prices will probably drop to a level with or close to those of 1914.

Tungsten in 1915

The production of tungsten ores in the United States during 1915 broke the record, and was apparently equivalent to about 2165 short tons of concentrates, carrying 60% of tungsten trioxide (WO_3), and was valued at more than \$2,000,000. These figures are based on preliminary returns to the U. S. Geological Survey. The largest previous output of tungsten ore was in 1910, when 1821 tons was produced.

Conditions and prices in the tungsten market were unsettled and somewhat anomalous. Although the price in the latter part of 1914 was \$9 or more a unit, 60% ore was sold in the early part of 1915 as low as \$5.80 a unit, so that tungsten mining did not start very briskly. Early in the summer, however, floods of orders for munitions of war caused a great demand for high-speed steels, to be used in cutting shells, rifle-bartels, etc.; an embargo was declared by the British government on the export of tungsten ores from any part of the British possessions, and there was soon a country-wide scramble for tungsten ores. Probably no one foresaw the height to which the price of tungsten would rise, and some operators contracted for ores at prices which in ordinary years would be high, but which were soon exceeded by several hundred per cent. Tungsten metal was also contracted for at prices much below those afterward reached. In the fall the prices of tungsten reached unheard-of heights; \$18 per unit was paid for numerous lots, \$50 for some, and even higher prices were reported. The prices moved upward so rapidly and unexpectedly that strenuous tungsten prospecting did not follow at once, but early in the fall a large number of men were in the field looking for deposits.

The mining activities are described by Frank L. Hess in some detail. The output of the Boulder (Colorado) field was for various reasons not increased as had been hoped. Many properties had been worked by leasing, so that there was no development of orebodies, for the ore had been removed as fast as it was exposed, and it is reported that in the Conger mine, whose shaft was sunk below the 800-ft. level, development was disappointing. Sinking is said to have been continued. The output of the district was estimated by the Boulder County Metal Miners' Association as equivalent to 960 tons of 60% concentrate.

In the Atolia (California) field there were great developments. The Atolia Mining Co. is reported to have employed more than 300 men, and many men worked the desert sands in the vicinity for float scheelite. P. J. Osdick discovered rich ore east of the Atolia Mining Co.'s property and made large profits. On and near the Baltic claim a number of men worked the gravel of a shallow gulch for scheelite and the sands on the Sunshine and other claims are also reported to have been worked at a profit. Several gold mines also produced scheelite. The Consolidated Gold Mines, in Randsburg, had found water at a depth of about 500 ft., and this has been piped to the Atolia company's mill, about five miles distant. Formerly water was hauled on the railroad for a distance of about 50 miles. The company is reported to have erected a new mill to treat its tailing.

Several discoveries of tungsten ores were reported from

Gilpin county, Colorado, but the most extensive discoveries, as indicated by the number of outcrops, were made in White Pine county, Nevada. Veins of scheelite were found at several places between the Minerva district, 30 miles south of Osceola, and Cherry creek, 50 miles north of the settlement. Some of the veins were formerly prospected for precious metals, but the scheelite was not recognized. The hübnerite mine and mill 12 miles south of Osceola were actively operated toward the close of the season; the mill at Camp Bonita, on the east side of the Snake range, was operated part of the year, and mills were erected or started by the St. Anthony Mines Co. at Toy (Browns), Humboldt county, by A. R. Shepard and associates in the Reagan district, and by the Doyle Mining Co. in Sacramento Pass, White Pine county. Some hübnerite was dry washed from desert sands at Round Mountain and Spanish Springs, Nevada.

The dumps of gold mines at White Oaks, New Mexico, were worked over for hübnerite and yielded a considerable quantity of concentrates, and at Tip Top, Arizona, a mill was under construction to work the tailing and dumps of the old Tip Top silver mine for the wolframite they contained.

Mills were erected by the Primos Chemical Co. at Dragon and by the National Tungsten Co. at Arivaca, Arizona, for treating the tungsten ores, and tungsten was produced at these places and at Camp Wood, Yucca, Oracle, and other points.

At Lead, South Dakota, the Homestake gold mine produced wolframite from the claims west of the great open-cut, and the Wasp No. 2 mine, two miles south, produced a considerable quantity of ore. It has erected a concentration plant. Only a little ore was produced in the southern Black Hills.

Small quantities of tungsten were produced in Idaho and at Silverton, Colorado, and a few hundred pounds was saved from the old concentrates of the gold placers at Nome, Alaska.

The wolframite deposits on Tungsten peak, near Cathedral peak, 45 miles northwest of Oroville, Washington, became the property of the Tungsten Mines Co., and the new owners produced some ferro-tungsten in an electric furnace at Tacoma.

The price of tungsten as metal or ferro-tungsten rose from \$1 a pound in January to \$8 in December. In the same period tungsten steels increased in price from 60 or 75c. to \$3 a pound.

(Special Correspondence.)—The new mill and equipment of the Atolia Mining Co., which was only recently completed, was partly destroyed by fire today. The plant was the only one for producing tungsten concentrate on the Pacific Coast. Atkins, Kroll & Co. of San Francisco were its managers, with Charles Taylor as superintendent. The mill began operating at full capacity of 100 tons per day about January 1, and had not stopped since then. The disaster means about 40 days' shut-down, which will affect 400 employees and every resident of Atolia, nearly 600 people. The cause is said to have been back-firing in the gasoline engine in the hoisting room, where the flames spread by contact with distillate leakage to the whole structure. There was \$56,000 insurance, and the loss is said to be \$40,000.

Atolia, California, January 24.

MANGANESE production of the United States in 1915 was nearly 6000 tons, compared with 2635 tons in 1914. Prices rose from \$12 to \$22.50 per ton for 50% ore. It is not likely that domestic deposits will make more important contributions to the supply. Imports from India were one-twelfth normal; from Russia, negligible; and from Brazil, over twice the average for the three preceding years.

CARNOTITE ORES produced in Colorado last year contained 23.4 tons uranium oxide and 6 grams radium, and 635 tons of vanadium, against 87.2, 22.3, and 435 tons, respectively, in 1914.



EDITORIAL



T. A. RICKARD, Editor

A RECOVERY of 95.77% zinc is claimed for the Butte & Superior concentrating mill in December last. This is much the highest extraction recorded at this flotation plant. At the Braden, in Chile, the copper recovery even now is only 77%.

A NACONDA is synonymous with progressive metallurgy and the courage to scrap plant when necessary. We take pleasure in publishing the first of a series of articles on the Washoe reduction works by our friend, Professor L. S. Austin, now resident at Salt Lake City.

YUKON yield of gold in 1915 is estimated at \$4,750,000. The most notable event was the working of claim No. 21 on Eldorado by one of the Yukon Gold Company's dredges. As this ground was virgin, the clean-up is reported to have amounted to \$500,000 in gold.

DISPATCHES from New York state that the financial groups have notified the administration at Washington that they "positively decline to finance the Carranza government in Mexico." This is important, if true, and will embarrass the Administration in its effort to strengthen the *de facto* government of Mexico.

VALUATION of mines is a subject that must be discussed periodically. The mathematical basis of it may not always seem vital to work in the field, but any line of reasoning on such matters should be checked occasionally by the logic of mathematics. We take pleasure in publishing a careful article by Mr. F. Sommer Schmidt on this subject.

SUNDRY people have awakened recently to find themselves rich. Among them are the operators of quicksilver mines. Thus the New Idria company which in 1911, 1912, and 1913 earned from \$50,000 to \$65,000 per annum, ran behind \$45,000 in 1914, when quicksilver was \$48 per flask, made \$100,000 in 1915 when the price averaged \$85.80, and will make nearly a million dollars in 1916 with the metal ranging from \$130 to \$300 per flask.

GOLD was produced in the Transvaal in the year 1915 to the amount of 9,093,671 ounces, worth £38,620,461 or \$187,946,473. This compares with 8,394,322 ounces in 1914, and 8,798,335 ounces in 1913. The record output was made in 1912, when it was 9,113,476 ounces. The dividends for 1915 amount to £7,617,561, which is

£455,875 less than the total in 1914, but this decrease is largely due to the large bonuses distributed in the latter year by the Robinson and Ferreira companies, as against one bonus by the Meyer & Charlton last year.

WE note that the Mining and Metallurgical Society has awarded its annual gold medal to Mr. James F. Kemp, Professor of Geology in Columbia University. The medal will have appreciated much in value thereby. As our readers are aware, Professor Kemp has had to take a rest for several months in consequence of the effects of overwork. We hope that he may convalesce rapidly and soon resume duties of great usefulness. He is the kind of man to be missed.

OATMAN has been cheered by the discovery of another important orebody on the 400-ft. level of the Big Jim mine. This apparently is one of a series of bonanza ore-shoots along the main fracture of the district, now exposed in the United Eastern, Tom Reed, Big Jim, and Black Eagle properties, a distance on the strike of two miles. The Big Jim, we hear, is under thoroughly competent management and will be developed systematically and intelligently.

TEXAS covers an area of one-eleventh of the United States, omitting Alaska and the islands, yet Texas is big enough to contain the whole of Germany and England. The foreign trade of Germany in an average year, such as 1913, was 14% larger than that of the United States, and that of the United Kingdom was 59% larger. In short, the United States "has been living commercially as well as politically largely within itself." The development of a continent has taxed its energies and created a domestic commerce that, until recently, has eclipsed its foreign trade.

IT may not be known generally to the mining public that all the publications of the U. S. Geological Survey, including professional papers, bulletins, and water-supply papers, are available for distribution at the local office of the Survey, at 303-305 Custom House building, San Francisco. Moreover, the complete library of all the publications issued by the Survey from its foundation is on file and is available for reference. A full set of the separate pamphlets on the commercial minerals of the entire country is issued annually, and copies of these may be obtained gratis. In connection with such subjects a complete bibliography is available for con-

sultation. All the maps of the entire United States, geographic and topographic, covering every State in the Union and the district of Alaska, can be seen at the same office. Besides this vast amount of minimate matter, the visitor will also be privileged to meet Mr. Charles G. Yale, statistician in charge.

KINDNESS has its reward, as wrong has its Nemesis. We have heard more than one story of escape from death in Mexico by reason of a grateful remembrance on the part of an executioner. The latest is that of an American who, with seven others, was lined up against a wall ready to go the long journey on the volley from a firing squad of bandits. Suddenly one of the latter points at our friend and calls out: "Don't kill that man, he is a good man, I worked for him as a foreman in a mine, and he treated me well!" The captain of the firing squad commands him to step forward from the edge of the grave and he is released.

WITH its total facility for faking information, the local press has published a cock and bull story alleging that ammunition is being manufactured at the Butters laboratory. This is only excused by the fact that Mr. Charles Butters is making aluminum dust, by use of the method described in our issue of January 22, this product being employed by him as a precipitant for gold and silver in cyanide solutions. It happens that aluminum dust is now being combined—in Europe—with ammonium nitrate to form the new and powerful explosive ammonal, as explained in our issue of January 8. Agents for the Russian government, being wide awake, read our paper and learned that Mr. Butters was making aluminum dust; whereupon they bought 10 tons of that substance for shipment to Russia, in order to make ammonal. These are the facts. If the *Morning Star* and the *Evening Hour* read the MINING AND SCIENTIFIC PRESS they would be better informed on technical matters in their home territory.

CYANIDE consumption in the United States at the present time amounts to about 2200 tons, of which Nevada alone requires 1600 tons. The price is 16 cents per pound for 100% KCN at New York. Thus the War has caused a rise of about 2 cents per pound. The retail price in San Francisco is 30 to 32 cents. Last year the consumption was a little larger than it is now. The whole supply comes through the Roessler & Hasslachner Chemical Company of New York, to whom, we are informed, the mine operators have the most kindly feeling, because that firm did not take advantage of them in the times of stress created by the War. A large tonnage of cyanide is reported as having been interned in Holland, when on its way from Germany to New York. As most of our readers are aware, the cyanide requirements of the mines under the British flag are being met by the Cassel Cyanide Company, of Glasgow, with whom the British government made an agreement soon after hostilities began, to furnish cyanide at 8½ pence per pound,

with an automatic reduction in the price gradually so that at the beginning of 1917 it will be back to the price, 7 pence, prevailing before the War. This arrangement has proved efficacious, the Cassel works having been enlarged in capacity so as to provide the quantity required. Fortunately for the supply of this necessary chemical, the demand from Mexico has been small, otherwise the closure of German sources of supply would have been felt more keenly. On average, a silver ore requires four times the quantity of cyanide consumed in the leaching of a gold ore.

A Professional Matter

Anything that concerns the welfare of the mining profession is our business. This journal endeavors to be a chronicle of professional activities and an exponent of professional ethics. Therefore we publish a copy of the contract made by the American syndicate representing the Minerals Separation company with metallurgists in the employ of its licensees in the use of a patented method of treating ores by flotation. We have no quarrel with the gentlemen of the Minerals Separation company except as to their efforts to stifle information concerning the technique of a branch of metallurgy now of great importance to all those engaged in mining. That policy on their part causes us to be prejudiced against them, but it does not make us unfair to them. With this preamble, we proceed to ask our readers to read the copy of a contract with a metallurgist and then the legal opinion of an accomplished member of the San Francisco bar. When we heard that such contracts were being enforced, we inquired into the terms and inferred that they were invalid, but before coming to a definite conclusion we decided to obtain a trustworthy legal opinion. As will be seen, Mr. C. Irving Wright is of the opinion that the agreement is "without valuable consideration and unconscionable." The reasons are clearly stated: a *quid pro quo* is lacking. The Syndicate does not bind itself to teach the metallurgist anything essential concerning its technical operations, for it will afford him merely "an opportunity of acquiring technical knowledge," and it can keep him "on its staff" for only just so long as it pleases; and in practice, it pleases to keep him for a very short time and to show him very little indeed. The metallurgist likewise is free both to quit this pseudo-instruction whenever he pleases and also to resign his employment with the licensee whenever it suits him. This pretense of giving an insight into the process and of binding the metallurgist not to divulge what he has learned is childish in its unreality, but the seriously objectionable feature of the whole arrangement is the obligation of honor placed upon the metallurgist not to divulge what he has seen or learned while in the laboratory either of the process-company or of its licensee. That obligation is without limit of time and therefore shackles his professional freedom indefinitely. To a careless or dishonorable man, the agreement is a scrap of paper; to an honorable man

—and we are only concerned with such—the signing of this agreement involves loss of freedom in the exercise of his knowledge and skill. He cannot go elsewhere and use what he has learned, he cannot accept a retainer from another client, because he has bound himself not to disclose any improvements even imagined by him or ideas suggesting themselves to him while under employment with the Syndicate or its licensee; he has also obligated himself for the rest of his life not to divulge or communicate any facts concerning the metallurgical operations of the Syndicate. And this professional subserviency is to be the consequence of having been placed temporarily on the staff of the Syndicate “for such a period as it [not he] deems advisable.” In short, the metallurgist sells himself for a mess of pottage. Whatever the legal value of the document, and as to that we give the decision of one qualified to pass upon it, we venture to express our opinion on the professional aspect of the matter, namely, that the signing of such an agreement is unprofessional because it cannot be fulfilled without either the loss of professional efficiency or the sacrifice of professional honor.

Getting a Job

In a recent issue of the Colorado School of Mines Magazine the youthful editor writes feelingly on the difficulty of getting ‘jobs,’ not ‘positions,’ the latter being regarded as belonging to an order of things beyond the graduate’s immediate horizon. According to our Golden contemporary, the chances of employment improved enormously during the second half of 1915, nearly as many engagements resulting in those six months as during the preceding eighteen. The improvement in the technical-labor market is imputed to the demands of the chemical and powder companies, which relieved the congestion due to the closing down of mines in Mexico. At this School of Mines there is a Capability Exchange, where the graduates register their experience, acquirements, and specialties. For each job obtained the recipient pays a fee, which, we presume, pays for the maintenance of the bureau. That is one way—and a good one—of obtaining employment. The subject, however, is a wide one and worthy of attention. Our own experience is that a young man should arrange that when he begins his career he will have a benevolent uncle engaged in the profession for which he has been trained. That is an excellent way of getting first aid in professional preferment. The next best thing to do is cultivate the acquaintance of kindly elderly gentlemen who may stand *in statu avunculi* and take sufficient interest in the budding engineer to give him employment or speak favorably of him to some friend at the club that has ‘invested’ in a mine. Another method for throwing bread upon the waters in the hope that it may return buttered after many days is for the young graduate to call upon or otherwise obtain an introduction to the mining engineers sufficiently his seniors to be patrens as regards employment. Most older men will give a few

minutes willingly to a youngster who approaches them with proper courtesy; for the senior, unless he be a bear or other brute, will remember his own troubles in the days before his career had gathered momentum. In short, we advise young men to know as many of those engaged in mining as possible. To know men is to be known of them. The knowledge of men is capital no less, if not more, than the knowledge of things. That does not mean making a nuisance of oneself by bothering busy men inopportunately. Not to be known is better than to be remembered unpleasantly. If he be in a mining community, let the youngster call on the senior members of the profession when a reasonable excuse offers. Above all, let him be willing, at any time or place, to prove himself useful. The present writer remembers making a map of a smelter gratuitously for an old and kindly duffer who reported him subsequently as a highly intelligent young man. On another occasion he gave a pretentious expert some data on the local geology without seeming to appreciate the elder’s ignorance of essentials. In a third instance he took pains to show a visiting engineer through the mine and was remembered in later years by the offer of a superintendency. Much of the success of life depends upon apparently fortuitous circumstances; to them, plus the readiness to make the most of them, we owe the opening of those doors on which is written on one side PUSH and on the other PULL. In this flux of phenomena called life, as Tyndall phrased it, the chief requisite is to have the qualities best adapted to usefulness at a given time and place. A young man must be ready to tackle anything. He who specifies the few things he cares to do and raises frivolous objections to trying this or that is likely to be sidetracked. The proper way is to state clearly the work in which you have had experience or consider yourself qualified to perform, following that with a cheerful expression of willingness to help in any way. The employer, if sensible, will not put a young man to doing something for which he is unfitted, but will either ascertain his strong points or give him a chance to acquire proficiency. One thing the recently fledged graduate should remember, and that is that his first ‘job’ is largely a gift, the chance to make himself worth his pay after a while, but not a commercial exchange between labor or brains or both and capital. Apart from purely manual work, in which immature men are not proficient at the outset, the first employment that comes to the graduate represents the offer of a chance to learn; in short, the young man is paid for more than he gives, at first; later he may give more than he is paid; finally he reaches a point where engagements are on a basis of fair exchange. The moral is that if in his third or fourth year he gets too little, he should remember that in his first and second year he was overpaid. After all, to a starter in life the pay is a secondary matter, unless he has untimely burdened himself with the responsibilities of a mate; the main thing is to learn, to amass knowledge, not money; to accumulate experience, not shekels; as against the day when both the knowledge and the experience can be capitalized to

profitable advantage. One word more: a young man casting about for a chance to place his feet on the first rung of the ladder of advancement is likely to meet with discouragement, sometimes in depressing sequence. Such an experience has been shared by most of us. Let him keep a stout heart, for such checks are often blessings in disguise, if he will use them to advantage, as, for example, by utilizing the opportunity to study during periods of non-employment. Even a blunder or a failure at first may prove good discipline as against the time when, as Mr. Woodrow Wilson has phrased it, a man "comes to himself."

Elm Orlu v. Butte and Superior

On another page we give our readers some excerpts from the opinion in this case as handed down by Judge Bourquin on January 22. We would have liked to reproduce the whole of it verbatim, but the exigencies of space did not permit. The case, in its evidence, argument, and decision, affords a timely comment on the anomalies of the extra-lateral idea of mineral ownership imputed in the mining law. The Judge himself had been a hoist-engineer at one time on one of the properties in controversy and he was not without acquaintance with the geologic structure of the mining district in which he lives. During the course of the trial he decided to go underground himself and see the evidence concerning the main points at issue, namely, whether the two veins united or crossed each other. As the preponderance of evidence did not support the idea of union, he finds that they do not unite. He concludes that the circumstances are such that reasonable and learned men may honestly differ in their interpretation of geological phenomena on account of the internal slips in the larger lode and the complexity of the faulting that has confused the rock-structure. With this conclusion most of us will sympathize. We marvel often how the learned gentlemen employed as skilled advocates in these cases can be so positive in regard to the meaning of evidence that may seem to us to be at best inadequate, contradictory, or confusing. We wonder also how half-a-dozen scientific men on one side can differ so radically from an equal number equally scientific on the other side when both have had access to the same facts. Apparently it is not good form on the stand to express the natural hesitation of the scientific observer when called upon to deliver an opinion upon insufficient evidence; that type of philosophic modesty is out of place; instead it is usual to assert conclusions with the confidence of one who was present on the occasion when the Great Architect made the veins or lodes in question. A geologist whose diagnosis left him doubtful as between a crossing and a union of veins would be considered a poor witness; yet we are frank to say that such doubt would obtrude itself into the minds of the majority of intelligent observers detached from litigation. Such observers also would confess that to define the limits of generous mineralization with a view to placing a finger on the boundaries of a lode is a

task incapable of scientific treatment, because the limit is drawn on economic rather than scientific lines, that is, it is based on the assay rather than the microscope. The Judge shows respect for the group of clever men engaged as witnesses or 'experts' in this case and gives them credit for a desire to elucidate the truth, but he is fully alive to the warping of scientific vision when subject to the distortion of partisanship. A touch of humor is injected by his remark that both parties seem to have halted development at points apparently vital to the elucidation of the chief problem, "as though fearful of results damaging to their theories." Undoubtedly a theory can be handicapped by a superfluity of facts. Probably the need of further development at specific points was more evident after, than before, the trial. Incidentally, we may remark that among the distinguished experts were one or two geologists prominent in the propaganda for a revision of the mining law, and we do not doubt that this suit will strengthen their belief that the interpretation of the extra-lateral right to complex cases of faulting and vein-crossings is beyond the ability of any judge, or even the most skillful mining geologist. Indeed the little knowledge that the court may have of practical mining and of the elements of geology may easily prove, in the case of a man less sagacious than Judge Bourquin, an obstacle rather than an aid to a correct decision, meaning thereby, one in accord with all the facts if they were known, which, of course, they never are. A recent case at Tonopah, where the judge likewise knew something about mining, afforded a good example of the undesirable introduction of geologic theory on the part of the court itself. In this case a far-fetched interpretation of the evidence on the part of the litigants was supplemented by a quasi-scientific theory contributed by the judge, who, neither by training nor by knowledge, was competent to take part in the scientific discussion, however competent to pass upon the evidence on such a subject when submitted by others. As a matter of fact the effort to arrive at the truth in a case like the one at Butte is a solemn farce, for not sufficient data are available for a clear-cut decision, as is proved by the fact that the labors of a good judge and ten clever geologists terminate in an obvious compromise. We need a revision of the mining law, and we need quite as much a change in the method of eliciting the facts on which a judicial decision can be based. Instead of ten experts, five on a side, it should be possible for the court to select three as his advisers in regard to the geologic factors. Then instead of being skilled advocates the three geologists would become real witnesses—scientific in the true sense. Such a procedure would in course of time lead to the selection of men known to be keen observers, lucid expositors, and unbiased witnesses. Employment for such duties would become highly honorable, and equally useful. Litigation would be abbreviated and rendered less costly. Law-suits would become less haphazard in their results and justice would more nearly prevail, within the limits of human fallibility.

Minerals Separation Contracts and Metallurgists

We give herewith a copy of a contract enforced upon a metallurgist in the employ of a licensee of Minerals Separation, Limited. We follow it with a legal opinion. The matter is discussed on our editorial pages.

THIS AGREEMENT made this — day of —, A.D. 1915, between MINERALS SEPARATION AMERICAN SYNDICATE (1913) LIMITED, whose registered office is at 62 London Wall, London, E. C., England, hereinafter called the Syndicate, and which expression shall be deemed to include not only the Syndicate, party hereto, its successors and assigns, but also any company or firm which may be affiliated with the Syndicate or which may take over any part of its business, of the one part, and JOHN DOE of —, of the other part, whereby it is agreed as follows:

The Syndicate shall afford said JOHN DOE an opportunity of acquiring technical knowledge and training relative to the processes and apparatus for the concentration of ores and tailings known to and exploited by the Syndicate by temporarily placing him upon its metallurgical staff for such period as it deems advisable to that end; in consideration whereof the said JOHN DOE agrees to disclose and assign to the Syndicate all inventions, improvements and discoveries made, conceived, developed or completed by him while thus employed relating to the treatment of ores or tailings or to the business of the Syndicate, and that he will from time to time, upon request of the Syndicate, make application through the patent attorneys of the Syndicate for letters patent of the United States and any and all other countries for such inventions, improvements and discoveries, and assign forthwith all such applications and the letters patent thereon to the Syndicate or to any such person or persons as it shall designate, and he hereby authorizes the Syndicate to take out foreign patents upon its own application or the application of such person or persons as it shall designate for said inventions, improvements and discoveries, should the Syndicate elect so to do, in any country or countries where such procedure is lawful, all necessary costs and expenses of making such applications and assignments and procuring such letters patent to be borne and paid by the Syndicate; and the said JOHN DOE agrees to give the Syndicate and its attorneys all reasonable assistance in preparing said applications and in drawing the claims thereof, and from time to time, on request, to execute all papers and do all things that may reasonably be required in order to protect the rights of the Syndicate and vest in it or its assigns the inventions, improvements, discoveries, applications and letters patent herein provided and give to the Syndicate the full benefit thereof. And the said JOHN DOE further agrees that he will not at any time, either while upon the metallurgical staff of the Syndicate

or thereafter, divulge or communicate to any person or persons, corporation or corporations, other than the directors or the general manager or the chief engineer of the Syndicate or any agent or attorney authorized or appointed by it, any trade or business secrets, operations or processes of the Syndicate, or any of the affairs of the Syndicate or matters relating thereto which have or may come to his knowledge in pursuance of such employment.

Signed, sealed and delivered by the said MINERALS SEPARATION AMERICAN SYNDICATE (1913) LIMITED, and the said JOHN DOE, the day and year first above written.

(Signed) Edward H. Nutter, Chief Engineer,
MINERALS SEPARATION
AMERICAN SYNDICATE (1913) Ltd.

(Signed) JOHN DOE.

The Editor:

Sir—You ask my opinion as to the legal effect and validity of the attached form of agreement imposed by Minerals Separation American Syndicate (1913) Limited upon engineers in the employ of licensees using its patented process.

By the contract the engineer "agrees to disclose and assign to the syndicate all inventions, improvements and discoveries made, conceived, developed, or completed by him while thus employed relating to the treatment of ores or tailings or to the business of the Syndicate," and that "he will not at any time, either while upon the metallurgical staff of the Syndicate or thereafter, divulge or communicate to any person or persons, corporation or corporations, other than the directors or the general manager or the chief engineer of the syndicate or any agent or attorney authorized or appointed by it, any trade or business secrets, operations or processes of the syndicate, or any of the affairs of the Syndicate or matters relating thereto which have or may come to his knowledge in pursuance of such employment."

The consideration for these agreements of the engineer is stated to be the agreement of the Syndicate that it "shall afford said" engineer "an opportunity of acquiring technical knowledge and training relative to the processes and apparatus for the concentration of ores and tailings known to and exploited by the Syndicate by temporarily placing him upon its metallurgical staff for such period as it deems advisable to that end."

It is needless to point out the embarrassment to which an engineer who signs this agreement may, if it be enforceable, be subjected during the future practice of his profession. It would always be open to the Syndicate to contend that any invention relating to the subject matter of the agreement, and brought forward by the engineer in his subsequent career, was in fact made or "con-

ceived" by him while "on its metallurgical staff." The engineer would, also, always be suspect if he should afterward give advice concerning, or be engaged in, work that could be considered as involving "any trade or business secrets, operations or processes of the Syndicate, or any of the affairs of the Syndicate or matters relating thereto."

The general prohibition against communicating any "operations or processes of the Syndicate, or any of the affairs of the Syndicate or matters relating thereto," is ineffective, and can impose no restraints upon the engineer. Only secret processes of a valuable character will be regarded by the courts, and these only so long as the Syndicate can prevent publication. See *American Stay Co. v. Delaney*, Mass., 97 N.E. 911. With respect to such processes as the Syndicate may successfully keep concealed, and while concealed, there would be an undoubted right to an injunction prohibiting publication by the engineer who enters into the relation contemplated by the contract, extraordinary and oppressive though the relation is; but, as intimated, the duty of the engineer in this regard would cease as soon as information respecting the particular process should have leaked into public channels.

The provisions of the agreement covering the case of inventions by the engineer rest on a different principle, nowhere better stated than by Mr. Justice Bradley in *Aspinwall Manufacturing Co. v. Gill*, 32 Fed. 697, as follows:

"A naked assignment or agreement to assign, in gross, a man's future labors as an author or inventor,—in other words, a mortgage on a man's brain, to bind all its future products,—does not address itself favorably to our consideration * * *. Where the inventor is connected in business with the party making such stipulation, or is interested in the profits arising from the business in which the invention is used, the arrangement seems to be altogether unobjectionable. But such a connection or interest does not seem to be necessary to the validity of such bargains. If based upon a valuable consideration, they are sustained as collateral or incidental stipulations connected with the conveyances of a principal subject."

The present form of contract pretends that the principal subject is an employment of the engineer, and that the provisions as to assignment of inventions are collateral and incidental to such employment and for the proper protection of the employer. When, however, the agreement is scrutinized it is seen that the Syndicate need only keep the engineer "on its staff" "for such period as it deems advisable." Of course, the engineer can quit at any moment. There is no obligation on the part of either that the so-called employment shall last even for an hour. There is no salary provided, nor any agreed recompense. Yet, if the words of the contract be credited, in exchange for an illusory consideration named "knowledge and training" acquirable during "such period as" the Syndicate "deems advisable to

that end," and of which, if and when required, no beneficial use will be permitted, the engineer undertakes onerous obligations and forfeits the freedom of his professional life.

It is my conclusion that, in this respect, the agreement would be held to be without valuable consideration and unconscionable.

C. IRVING WRIGHT,

San Francisco, December 18.

Gold and Silver Production of the United States

The Bureau of the Mint and the Geological Survey have issued the following joint statement as to the preliminary estimate of the production of gold and silver in the United States during the calendar year 1915:

| State or territory. | Gold. | | Silver. |
|----------------------|-----------|--------------|------------|
| | Fine oz. | Value. | Fine oz. |
| Alabama | 247 | \$ 5,100 | |
| Alaska | 894,317 | 16,626,700 | 838,100 |
| Arizona | 198,695 | 4,107,400 | 5,078,100 |
| California | 1,112,906 | 23,005,800 | 2,110,900 |
| Colorado | 1,073,499 | 22,191,200 | 7,395,100 |
| Georgia | 1,176 | 24,300 | 100 |
| Idaho | 50,726 | 1,048,600 | 10,595,300 |
| Illinois | | | 2,200 |
| Maryland | 19 | 400 | 100 |
| Michigan | | | 495,400 |
| Missouri | | | 56,400 |
| Montana | 230,415 | 4,763,100 | 12,690,200 |
| Nevada | 547,349 | 11,314,700 | 13,793,000 |
| New Mexico | 69,176 | 1,430,000 | 1,907,100 |
| North Carolina | 7,416 | 153,300 | 1,400 |
| Oregon | 84,144 | 1,739,400 | 126,500 |
| Philippine Islands. | 62,259 | 1,287,000 | 14,500 |
| Porto Rico | 4 | 100 | |
| South Carolina | 101 | 2,100 | |
| South Dakota | 357,850 | 7,397,400 | 195,400 |
| Tennessee | 406 | 8,400 | 141,000 |
| Texas | 135,000 | 2,800 | 720,400 |
| Utah | 169,061 | 3,494,800 | 11,168,500 |
| Virginia | 53 | 1,100 | 1,100 |
| Washington | 12,926 | 267,200 | 154,000 |
| Wyoming | 977 | 20,200 | 700 |
| Total | 4,783,857 | \$98,891,100 | 67,485,500 |

These figures compare with the production of 1914: \$94,531,800 in gold and 72,455,100 fine ounces of silver, being a gain in the gold production of \$4,359,300 and a loss in the silver product of 4,969,500 fine ounces.

AT A LUMBER CAMP in the Northwest, it was suggested that a lot of sanitary drinking-cups be ordered. "Good idee," said the camp boss, "we'll git some o' thim kind o' cups right away, and while we're about it we'll git a gross o' medicine-droppers so's the min kin use 'em to spit on their hands."

The Washoe Reduction Works, Anaconda—I

By L. S. Austin

This great metallurgical establishment, known locally as "the smelter on the hill," is $2\frac{1}{2}$ miles from the neat and compact town of Anaconda, where everyone lives, since there is no settlement near the works. The company's street-car line transports most of its 3600 men day and night, thus providing for the transfer of the three shifts to and fro, between the town and the smelter.

The site containing the works is on a side-hill sloping in conoidal form from the main brick stack at the apex of the hill to the north and north-east. The main flue may be regarded as its back-bone, while the high-line and main-line tracks follow the contour of the hill, thus revealing its shape. The base of the main stack is 780 ft. above the floor of the lowest structure, the converter building, and this in turn is 100 ft. above the railroad situated on the flat below. It is this flat that has afforded a dumping-ground for the last 13 years and will clearly serve for another generation. Already the nearby ground is piled high and the main-line railroad runs through it as through a cut. The tailing and the slag (all granulated) are laundered to the dump.

When the works were first constructed in 1902, the general plan of treatment was thus elaborated:

The ore, a complex sulphide, was divided into 'first-class' and 'concentrating,' principally the latter. The concentrating mill yielded a coarse concentrate, which was sent to the blast-furnace, and a fine product for roasting and reverberatory smelting. The first-class ore was screened to give a coarse product suitable for the blast-furnaces, while the first-class fine, mixed with pond-slime, was briquetted, and also delivered to the blast. Both blast and reverberatory furnaces yielded a matte of 40% and over in copper, and this was blown to blister copper at the converter plant.

The general plan has been altered in detail, for the following reasons:

At the beginning, the first-class ore contained 8% or more of copper and the concentrating ore 4%. But, as smelting was cheapened by improved practice, a lower-grade ore became profitable. Thus great masses of ore, formerly left in the stopes, or revealed by development, became available; and it was seen that the life of the mines could be indefinitely extended. The first-class ore was lowered to 5%, the concentrating ore to 3%, in copper. Nor was this all; progress had been made in cheapening operating methods until it seemed that these had been cut to the minimum. But, for the purpose of obtaining high recoveries, new methods are constantly being introduced. Where before a 75% recovery in ore-dressing was painfully attained, now, thanks to round-table work, and particularly to leaching and flotation methods, this is approaching 85 to 90% of the cop-

per entering the mill. To be sure this has called for the investment of millions in new installations and the cost of more operating equipment, but, on the other hand, it has been justified by the greater savings and the increased capacity of the works.

Referring to the general plan, it will be noted that the high-line tracks coming from Butte enter the north corner and follow the contour of the hill. Branches from this line are carried on a high trestle to connect both the sampling-mill and the concentrator, the latter being hung upon the steep hill-side, so that the ore may proceed from machine to machine by gravity. Trains of 75 cars, each of 50 tons, deliver the ore from the mines at Butte.

The main-line tracks enter from the same direction, the cars delivering ore, limestone, and fuel to the blast-furnace storage-bins. Brick, machinery, sand, lime, acid, and other supplies from the flat below enter by these same tracks. Altogether this railroad system supplies 20,000 tons of material daily.

Besides this there is the yard system for moving materials from point to point. It is handling fully 16,000 tons daily. The blast-furnace charges, the concentrate from the concentrate-dewatering plant to the roasters, the calcine for the reverberatories, the matte to the converter plant are moved about by compressed-air locomotives in trains of 5-ton cars and the matte in 10-ton ladles.

The supply of water comes from Warm Springs creek and is carried 7 miles by flume to the smelter. Part of the supply in winter is pumped over a ridge to the creek from the Silver Lake storage-reservoir, 15 miles west of Anaconda. At the flume-house movable screens are provided to remove leaves, etc., before the water goes to the supply-tanks. This means that a man is on guard on each of three shifts.

The concentrator plant has eight units, four in each building, but the lower portion adjoining the tank-house is being altered, unit by unit, for re-grinding and flotation treatment. The difference of level between the high-line track to the concentrator and the main-track into the works is about 125 ft. Below the concentrator, and adjoining the main track, nine new buildings are situated. Elsewhere are the ore-driers at the east end of the roaster building, the coal-pulverizing plant and its adjuncts at the end of the reverberatory building and the boilers and stack for No. 9 reverberatory furnace at the west end of the converter building. Besides the office-buildings are the supply buildings and several repair shops.

A mile away from the works and toward town the company has erected its acid plant and a new brick plant. In the same locality the company has a large foundry

roadwork stop with new parts and some repairs to be made both for the Washoe works and for the mines. Just at present the original material entering the works includes 13,500 tons of ore, 500 tons of coke, 500 tons of coal, and 1150 tons of lime rock, in all, 16,000 tons. With all the new construction, the pay roll includes 3000 men, of whom 2100 are now actually engaged in the operation of the works, on 8 hour shifts.

QUICK REPAIR OF MAIN FLUE

In 1911 some 80 ft. of the single flue collapsed at

single flue with its trusses, the double flue, and the stack are shown in the photograph, Fig. 2. The trusses are carried independently of the side walls upon latticed posts that just clear the wall outside. The trusses support longitudinal channels, which, in turn, are tied to the transverse rails. These rails serve as skew backs for jack arches of 3 ft. span.

THE No. 2 ROASTER PLANT

To roast the increased tonnage of sulphides, due to the installation of flotation methods of concentration, a new

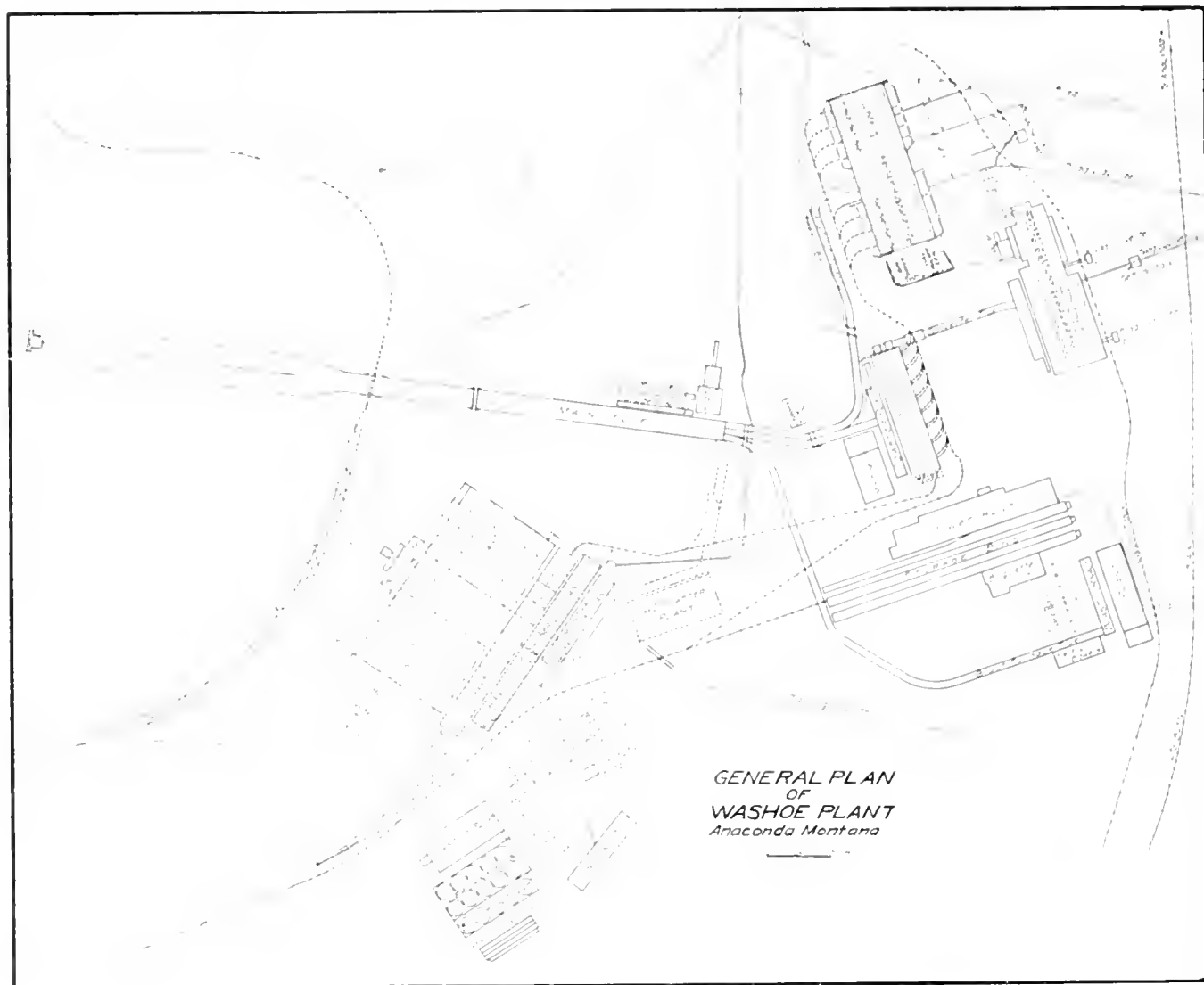

FIG. 1.

4 p.m. The works were shut-down and the repair-gang worked intermittently until 8 p.m. the following night, when the furnaces were again started. This involved the speedy ventilation of the flue, the removal of the ruined structural steel and brick-work, the re-building of the upper portion of the brick side-walls, the placing of new beams and of the brick roof over an area of 60 by 80 ft. The acetylene flame was used in cutting the steel beams for speedy removal. To prevent the recurrence of such a disaster the single flue is held up from end to end by transverse trusses spaced on 20-ft. intervals. The

roaster plant is being built rapidly with a view to its completion by the end of the year 1915. At the same time the smaller reverberatory furnaces are being enlarged, other 20-ft. converters installed, and No. 9 reverberatory added at the end of the converter building, all to take care of the expected increased production of concentrate.

This No. 2 roaster plant is close to the 'concentrate dewatering plant' and parallel with the main trackage of this part of the works (see Fig. 1). It contains four rows of roasting-furnaces, seven in a row, or 28 in all.

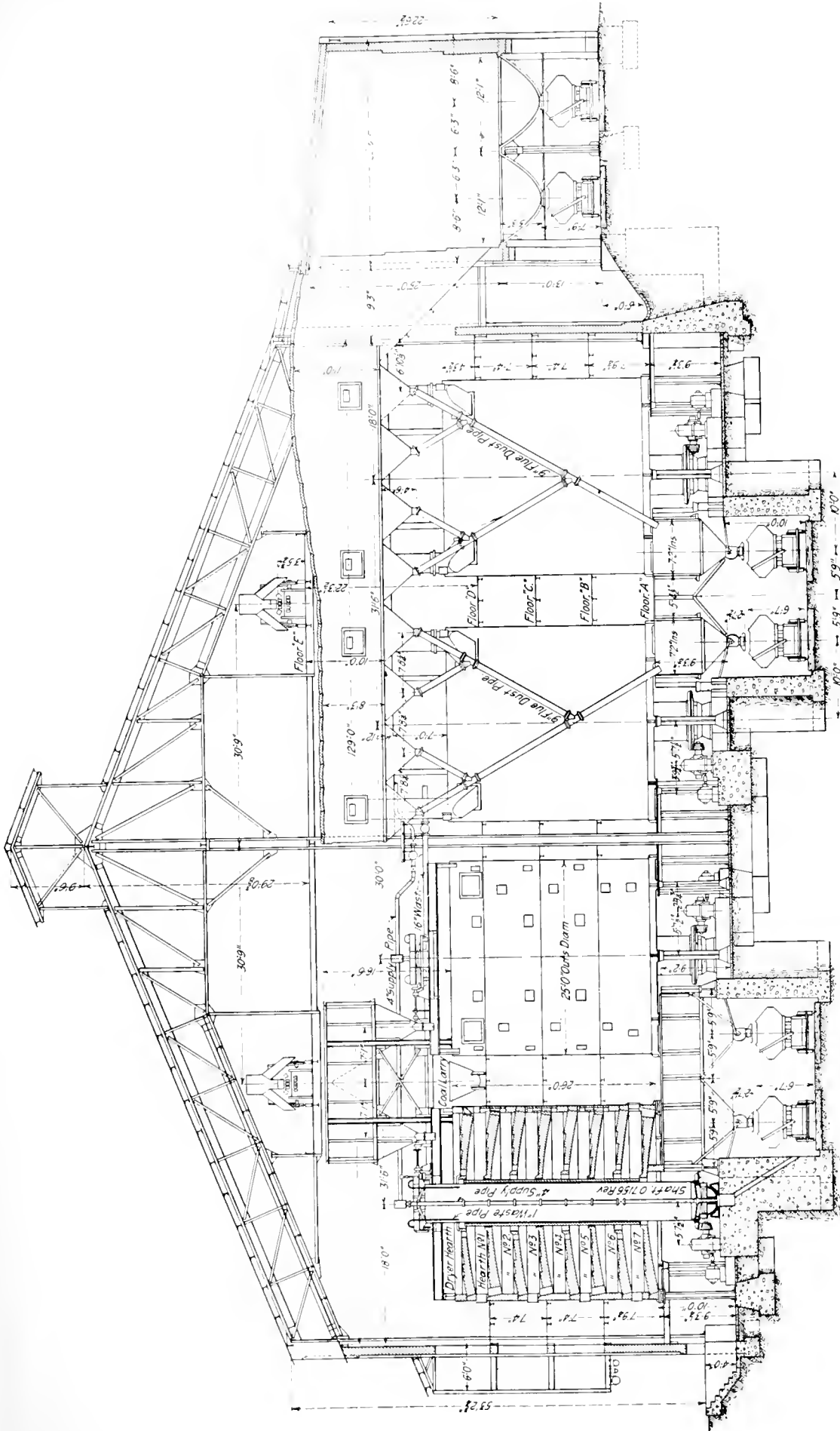

FIG. 3. TRANSVERSE SECTION OF ROASTER PLANT.

These have a shell diameter of 25 ft. and are 23½ ft. inside diameter, each roaster having seven hearths.

In Fig. 3 is given a transverse elevation of the building which is 129 ft. wide by 270 ft. long. The draft gases from each nest of eight furnaces are carried off by a transverse flue, of which there are four in all. These flues, 8 ft. high by 10 ft. wide, will deliver to a flue 28 ft. wide by 24 ft. high and this again leads to the foot of the main flue of the works. A row of hopper-bottom storage bins, set transversely at the south end of the building, but not shown in Fig. 3, receives concentrate from cars on a track that runs over them. The concentrate may be drawn from any storage-bin upon a 24-in. conveying belt, thence west by an inclined conveying belt to a chute at the other end. This chute delivers to another inclined conveyor traveling the opposite way, and running horizontally across the roaster building within the roof-structure, and high enough to deliver its load to either of the longitudinal troughed belt-conveyors shown in Fig. 3. Each of these conveyors has its own tripper, so that the concentrate can be delivered to any roaster-hopper desired. Contrast this with the method pursued at the older, No. 1 roaster building, where the same material is brought in by train-load upon an overhead track, so that a heavy structure is needed to sustain the train.

Both the cross-flues and the roaster-flue have hopper-bottoms. Pipes carry the flue-dust from the cross-flues to the furnace-discharge hoppers while the contents of the roaster-flue are drawn off periodically into cars.

Studying the roaster itself, which is of a MacDougall-Wedge type,* one notes that the top of the furnace is a drying-hearth, while there are seven others with central and side drop-holes or openings in accord with the Wedge system. The draft passes away at the side by four off-takes at No. 1 hearth-level, rather than at the top as in the MacDougall furnace. These liberal exits tend to lessen flue-dust loss.

The arms and the 5-ft. central shaft may be cooled by either air or water. This central shaft is entered by a man-hole at the side. The outside of the shaft, to protect it from the heat, is lined with tile as in the Wedge roaster. The shaft with its stirrer-arms is carried by four rollers, and is driven with spur-gear and pinion by an electric motor.

A novel feature of the building is that the four working-floors are carried outside the sides of the building and around the furnaces, so that access to any furnace is obtained by a well ventilated passage. Coal is raised in an elevator to the upper floor (and distributed to the different furnaces by means of a larry) for use in starting or in warming up as may be needed, though the concentrate has enough sulphur to be self-burning.

Altogether the building, flues, and furnaces show good design and thorough construction, the result of long experience in the older part of the plant.

COAL-DUST FURNACE REVERBERATORIES

Referring to the general plan of the works, Fig. 1, the reverberatory plant contains eight furnaces, numbered consecutively from the west to the east of the building. The large reverberatory at the west end of the converter building is called No. 9. Number 8 furnace was the first one altered to coal-dust firing, being extended to 124 ft. long, but retaining the old width of 20 ft. Reverberatories No. 1 to 7 inclusive have been, or are being, altered to approximately 144 ft. long by 23 ft. wide, and, in part, are now in successful operation.

Reverberatory No. 7 (see Fig. 7) is typical of the new furnaces, the plans having been completed after the testing of No. 8 on coal-dust firing. It is 143 ft. 2 in. long by 23 ft. 4 in. wide. The roof, 9 ft. 6 in. high at the fire-end, maintains that height half-way along the furnace, then slopes gradually to 6 ft. 6 in. at the front. The arch has a rise of 2 ft. 5 in. (1½ in. per ft.) It is a question whether the roof in the hottest zone should not be still higher, both as lessening the thrust on the skew-backs and of removing it from the close contact of the flame. This was an idea on which Siemens insisted in the construction of the open-hearth furnace. The spring of the arch is supported by a built-up channel wide enough to receive the skew-brick. These channels also serve as longitudinal ties. At the firing-end the arch-bricks are 25 in. at the spring, and 20 in. at the crown of the arch. This arrangement continues for one fourth the length of the furnace, dropping then to 20 in., and finally to 15 in. for the thickness at the front. Transverse joints in the roof, 3 in. wide and every 20 ft., allow for expansion as the furnace is heated. The last joint is but 5 ft. from the end of the roof at the verb, and makes, with the horizontal arched front edge, a structural feature worthy of note. See Fig. 5.

At the front, 3 ft. 3 in. to the left of the centre line, comes the matte-tap placed at the hearth-level, and 24 in. above at 2 ft. 9 in. to the right is the dam-plate of the slag-tap. On an output for the furnace of 600 to 700 tons per day there results a steady flow of slag over the dam-plate. Matte is tapped on an average about once in two hours, but actually, according to the demands of the converting department, which may withdraw several ladlesful in succession. The flue-bottoms converge to the tap-holes. There are two flues, each 6 ft. by 8 ft., damped in order to regulate the draft exactly. Thus the gases may be thrown to either of the waste-heat boilers, right or left. Each stack of boilers consists of two, each 300 hp., placed in series. No. 9 furnace at the converter building has its boilers in parallel, thus obstructing the draft less, and either of them may be bypassed while the other still operates; but then the gases pass to an independent steel stack 200 ft. high.

At the firing-end are the five coal-dust burners fed from a hopper-bottom bin of 63 tons capacity (Fig. 4). The coal-dust withdrawn from the bin is fed by a screw to four 1-in. drop-pipes, and falls into the burner-

*The rights for the use of the patented features of the Wedge roaster have been purchased by the company for a lump sum, and these have been incorporated into this furnace.

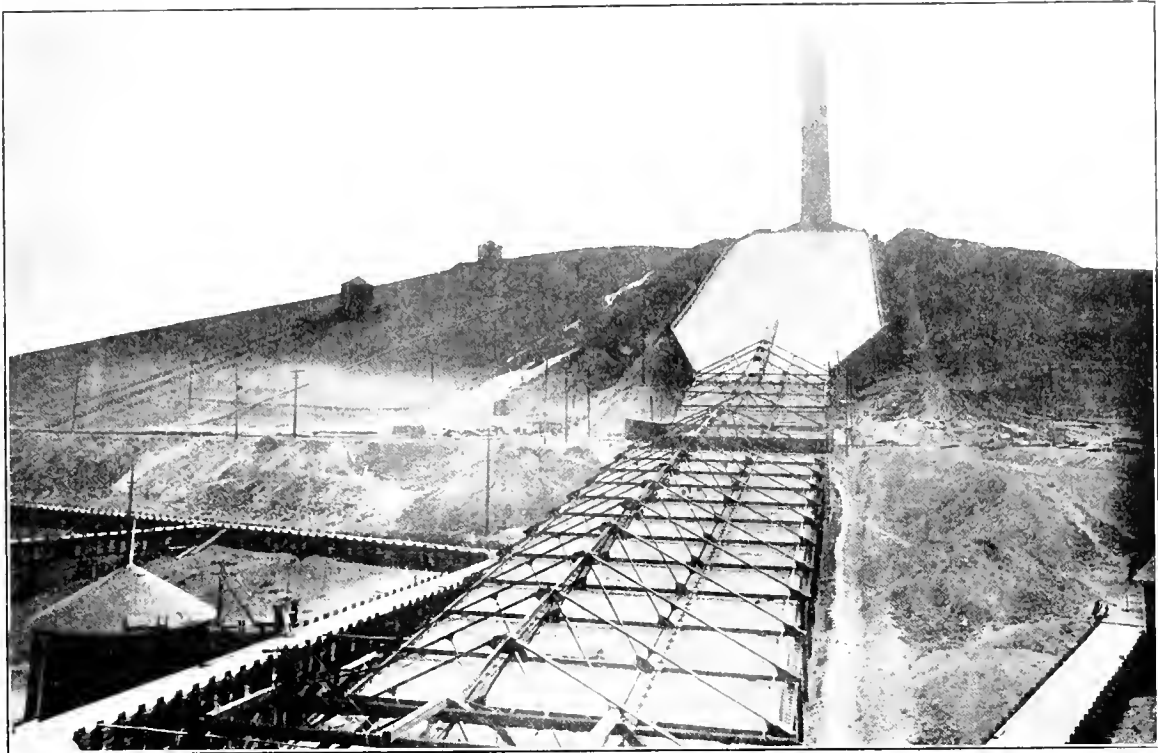

FIG. 2. THE MAIN FLUE AND STACK. THE SINGLE OR 60-FT. FLUE IN THE FOREGROUND HAS A TRUSSED ROOF. THE DOUBLE OR 120-FT. FLUE HAS A PLATE-IRON ROOF. THE STACK IS 30 FT. DIAM. BY 300 FT. HIGH.

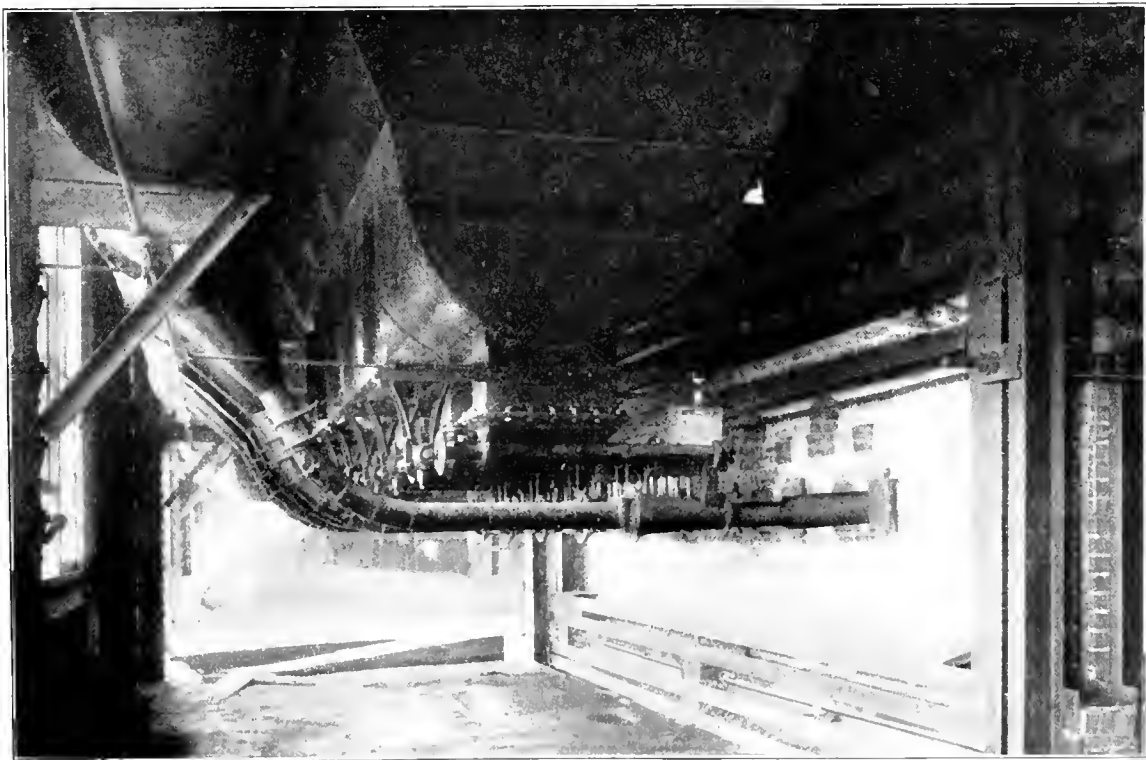

FIG. 4. THE COAL-DUST BURNERS. AT THE LEFT THE HOPPER BOTTOM PULVERIZED COAL FEED-BIN. FROM IT LEAD FIVE BLOW-PIPES, WHICH ENTER THE BACK WALL OF THE REVERBERATORY FURNACE. ABOVE THESE PIPES ARE SEEN THE SCREW-FEEDERS, ONE TO EACH PIPE, BY WHICH THE COAL DUST IS FED.

pipe where it is injected into the furnace by means of pressure of air from the 30-in. air pipe against the north wall of the building. There is a Reeves variable speed belt drive by which the coal supply can be regulated. To supplement the injector supply, there is a secondary air admission at the drop pipes, another at the tapered injector, and a third regulated by a slide on each side of the burner pipe where it enters the furnace. Thus, both coal and air, conjoined to damper regulation, ensure efficient burning of the coal. The draft pressure is watched, and constant gas analyses made to make sure of complete combustion.

There are two feed bins, one on each side; also a transverse feed bin at the firing end. From these bins come down the feed pipes set at 26-in. centres. Each feed pipe has its own slide valve. The pipe bends just before it enters the furnace, and here a peep hole enables the condition and height of the charge within the furnace to be known. Above the furnace are two parallel tracks where the trains of charge-cars enter. It is at the first and hottest half of the furnace that most of the charge is smelted, and it is accordingly at this point of the furnace that the hoppers must be most frequently replenished. The feed-pipes near the front deliver silicious ore from the hoppers into the furnace for fettling purposes only.

Fig. 6 gives a longitudinal section and the heat-intensity curves progressively from the firing end, taken in February 1915. It will be seen that a properly regulated supply of air lengthens the smelting zone and slightly increases the final temperature of the furnace. It is possible, by increasing the supply of fuel and air, to urge the furnace so that the roof will be melted, and this is one of the limitations to capacity. If we take the formation temperature of slag at 1100° C., the final furnace-temperature is well above it. There is no fear of the slag setting or solidifying as in a grate-fired furnace using natural draft. Where, using solid coal, a draft of 1.7 in. water was required under coal-firing, 0.10 to 0.15 in. is now enough, that is, to remove the products of combustion. Corrosion of the brick-work takes place chiefly in the hottest zone, that is from 20 to 60 ft. from the firing-end, both roof and side-wall being invaded. At the side-wall the bricks may be driven in and the opening newly bricked up. Once in about seven months a more serious repair is needed, since the roof near its spring has been eaten away.

Diamondville coal, dried and powdered, is used. It has the following composition:

| | |
|-----------------------------|-------------|
| | % |
| Moisture | 1 |
| Volatile combustible matter | 49 |
| Fixed carbon | 48 |
| Ash | 11 |
| Calorific power | 13,675 Cal. |

With the air 52% in excess, the intensity of the flame was more localized and the CO_2 was lower, indicating less perfect combustion. When the air exceeded the theoretical amount by 15% only, then the heat-zone was more extended, the CO_2 going to 16%, but this was done

with a higher draft. In present practice the average of the gases gives: CO_2 , 19.2%; CO , 3%; and O_2 only 0.2%.

Hydrogen is not determined. The gas analyses are constantly made, and the working of the furnaces controlled by them; besides the regular determinations, a Simmons Abady apparatus automatically registers the amount of CO_2 in the gases. A constant gas supply is drawn from near the front end, a few inches below the roof, through a laboratory size centrifugal fan, and from this the apparatus takes what it needs. It will be seen from the analysis that the combustion is nearly perfect and that there can be but little excess air.

To give an idea of the performance of these furnaces, let us take an ordinary 24-hour record:

| | |
|-------------------------|-------|
| | Tons. |
| Smelted calcine | 579.8 |
| McDougal flue-dust | 6.7 |
| Main-flue, flue-dust | 16.2 |
| Blast-furnace flue-dust | 13.6 |

| | |
|----------------------------|-------|
| Total charge smelted | 676.3 |
| Total pulverized coal used | 103.4 |

Ratio, one of coal to 6.51 of charge, equivalent to 15.3%. One may note the large amount of flue-dust, which is less easily smelted than the hot calcine.

THE NO. 9 COAL-DUST FIRED REVERBERATORY

This furnace is situated at the west end of the converter-plant and has its own blowers, waste-heat boilers, flue, and independent stack.

Inside dimensions of the furnace are 153 ft. by 20 ft. 6 in., smaller than the regular type, but large enough for its special duty. It is intended for smelting some 1200 tons of molten converter-slag daily, besides calcine, and also raw sulphides for cleaning the copper out of the slag. Pieces of ladle-skulls, sweepings, spilled slag, refining-furnace slag, matte, and other material from the converter-plant are treated. It is probable, however, that the solid material may have to be crushed and fed from the side-hoppers. I may add that this furnace has two rows of side-hoppers for charging calcine and ore, also a centre row to be used in the same way, when found advisable. The large amount of molten slag should create so large a bath that central charging can be performed, especially with fine calcine, which spreads when dropped, flowing like water on the molten surface of the slag. In No. 8, the 20 by 124-ft. furnace, this was tried, but owing to the piling up of calcine at the walls and the leaving of a trough in the centre, this central space was obstructed, and so the matte was dammed back from the tap-hole. Between the two sections of central hoppers is a 3-ft. diam. opening intended for charging ladle-skulls and other pieces, this hole being closed by a brick cover.

The furnace is so placed that there is plenty of room on the converter side for charging cranes and handling ladles. There are two tap holes for the matte, respectively 25 and 30 ft. from the front, with launders leading to the ladle in the pit. For charging on the same side there are provided three slag-openings having brick-lined lifting-doors, situated respectively 21, 30, and 39 ft. from

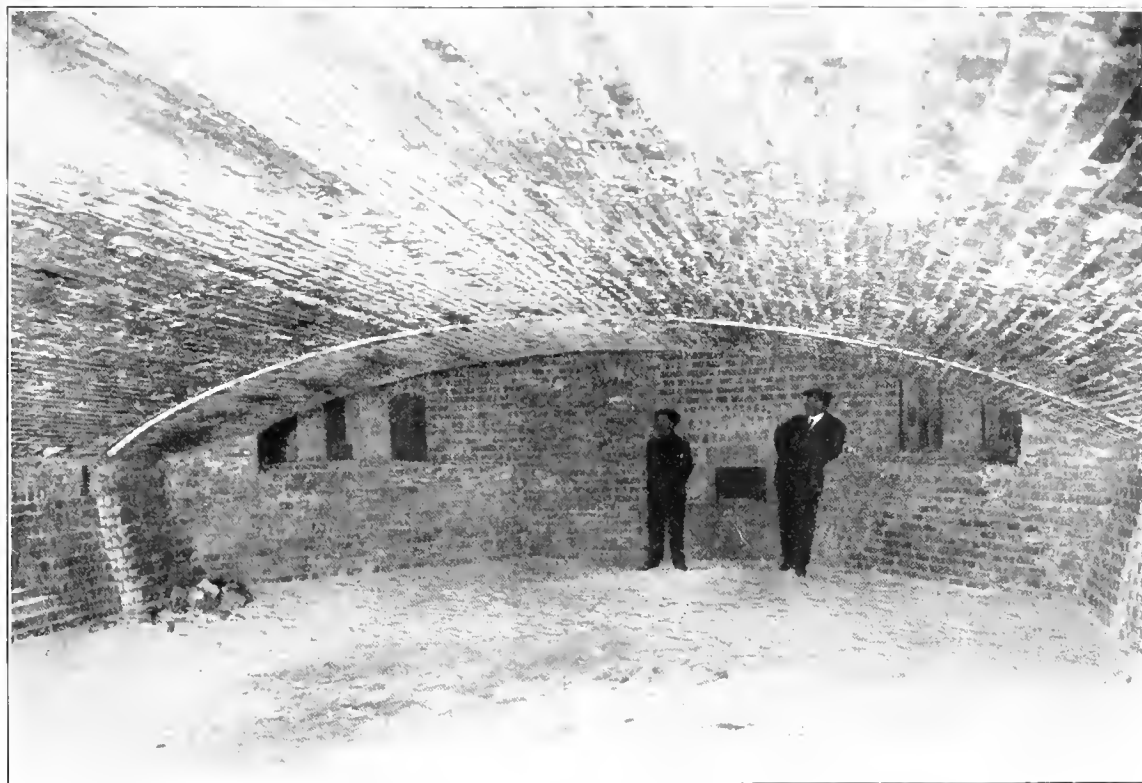

FIG. 5. FRONT END OF NO. 6 REVERBERATORY FURNACE. THE INDEPENDENT VERB ARCH IS SHOWN, SEPARATED BY A 4-INCH JOINT FROM THE REST OF THE ROOF. THIS JOINT CLOSES BY EXPANSION WHEN THE FURNACE IS HOT. BETWEEN THE MEN IS THE SLAG-HOLE OR SKIMMING-HOLE.

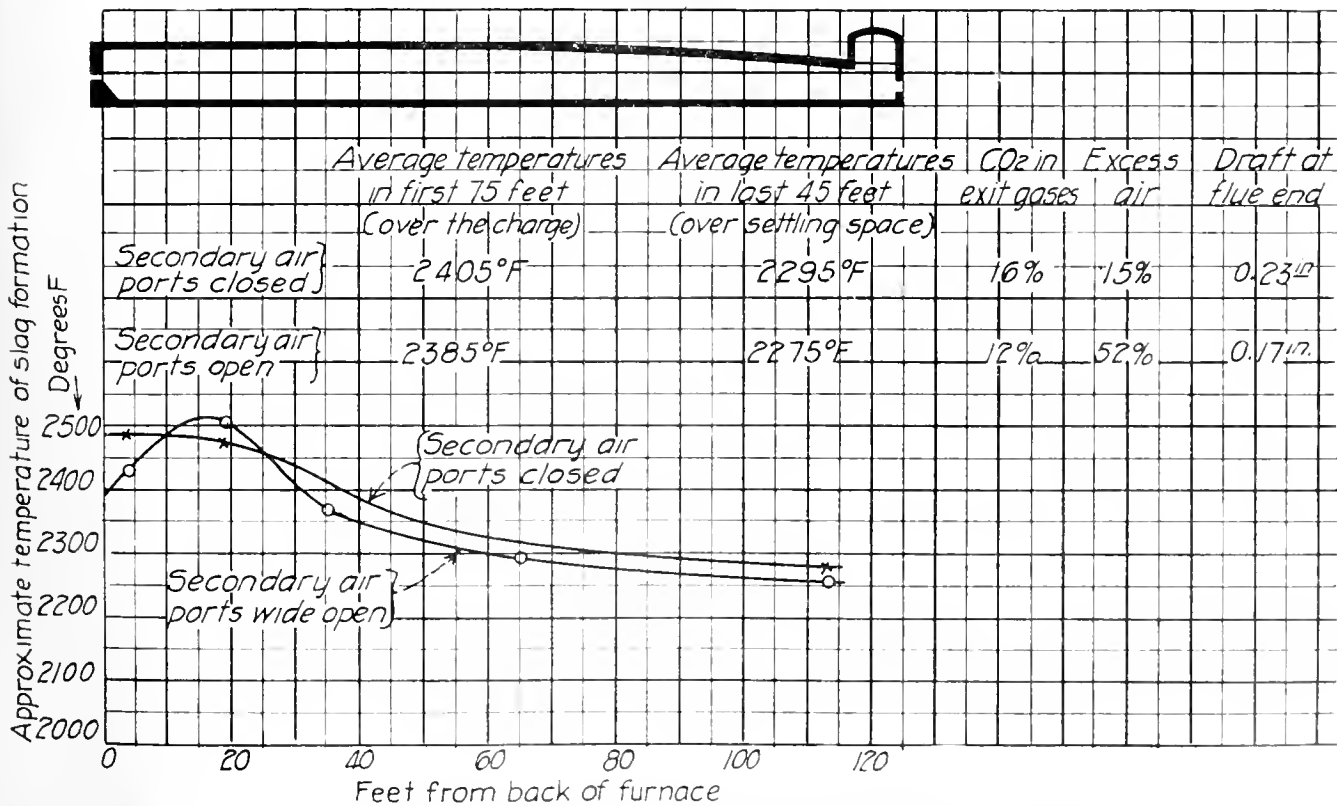

FIG. 6. TEMPERATURES AND GAS ANALYSES IN NO. 8 REVERBERATORY FURNACE.

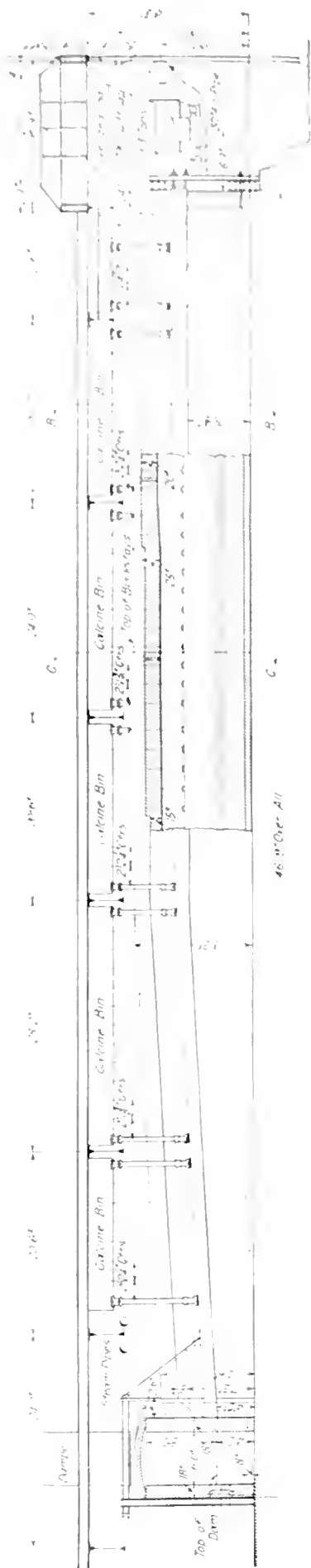

FIG. 7. LONGITUDINAL SECTION OF REVERBERATORY FURNACE

the firing end. Slag is to be charged through any one of these openings by means of any one of three funnel-carriages mounted on wheels, and shown in detail in Fig. 8. This four-wheeled carriage may be advanced or withdrawn as desired on a short standard gauge track, so that immediately after charging, it can be run back and the door of the slag opening closed. It carries a cast iron lined funnel of 5 ft. diam. with a curved spout for directing the stream of slag into the furnace when in charging position. Molten slag from the converter is poured into the funnel from the crane ladle. Two openings are provided at the front of the furnace, the higher one being the slag opening with its skin-plate, the other a tap hole at the floor either for draining the furnace or, if desired, to be used as another matte-tap.

The front end is tied centrally to the skew-back side-

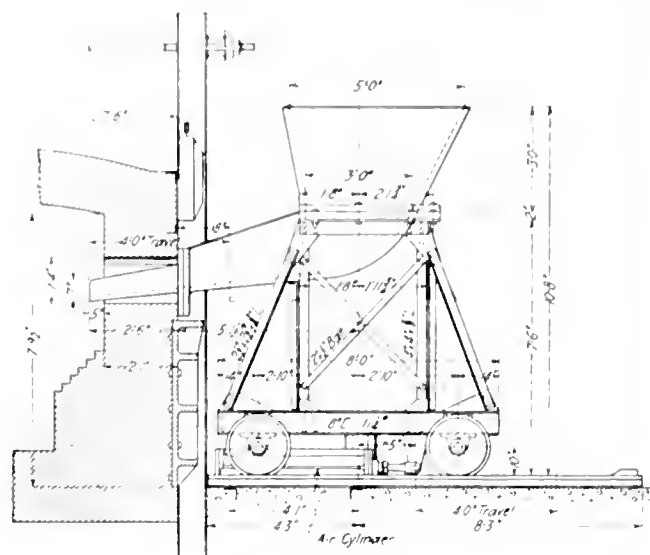

FIG. 8.

channels, which also tie the adjacent sides, as shown in the longitudinal plan. At the firing end is an inclined channel that ties the skew-back channel strongly to that end. The side-walls have concrete foundations, and the bottom will be of crushed quartz melted in. The roof has the same substantial construction as the standard furnace, being 25 in. thick at the haunches at the firing-end, 20 in. thick at the centre, and thinning to 15 in. at the front.

Since this furnace has never been thoroughly tested, openings have been made, so that any desired procedure may be adapted, until experience has shown the best methods of operation. The furnace seems to have many judiciously-planned and convenient features.

The flue itself is 8 by 6 ft. wide, enlarging toward the two boilers of 300 hp., each set in parallel, so as to afford less resistance to draft. It cannot be seen that provision for damper has been made. Older practice with a single stack places it at the top of the stack. The stack itself (unlined) is 8 ft. diam. by 200 ft. high.

THE COAL-PULVERIZING PLANT

To supply 100 tons per day of pulverized coal to each of nine reverberatory furnaces requires a large equip-

ment. The plant is placed, as may be seen, on the map, Fig. 1, at the east end of the reverberatory-building. A gallery, extending the whole length of the north side of the building, shelters the long conveyor that delivers the coal-dust to the bins of each furnace. A bridge from the coal-pulverizing house northward performs the same duty for the conveyor to No. 9 reverberatory at the west end of the converter building.

Briefly, the run-of-mine coal to be pulverized is coarse-crushed, dried, pulverized, and delivered to the feed-hoppers of the reverberatories. Use is made of the conveying-belt at first, but the screw-conveyor is the principal method of transfer.

The coal comes in hopper-bottom cars by overhead track above a 60-ton steel receiving-bin. From this it is drawn into a Blake crusher, then by a vertical elevator and a 36-in. horizontal belt-conveyor to any desired part of a 1000-ton storage-bin. When wanted for use this stored coal can be drawn off upon a 24-in. conveying-belt, thence by another belt-conveyor into the plant. Often coal from the crusher drops at once on this conveyor. The head end of the conveyor has a Dings magnetic pulley, which removes any iron or steel particles from the coal.

At this point a vertical elevator delivers by chute into No. 1 dryer, and by a 14-in. horizontal helicoid conveyor into No. 2 and 3 dryers. The dryers are of the Ruggles-Coles type, 6 ft. diam. by 40 ft. long, with inner and outer concentric cylinders, and at the fire-box end a suction-fan for the removal of the fire-gases, and incidentally a little coal-dust. The dried coal, containing less than 1% moisture, falls from the drier upon disintegrating rolls, where it is reduced to grain size. This time it is sent back to the higher 'No. 2 Elevator' for delivery to what may be termed a main-line conveyor leading over into the Raymond pulverizer-building. Transverse to this and extending the length of the pulverizer-building are two horizontal helicoid conveyors, right-hand from the main conveyor in one direction, left-hand in the other. Thus there is delivery to any of the 10 feed-hoppers on both sides of the building, these feed-hoppers supplying the ten 5-roller Raymond mills. This type of mill has its rollers hung on vertical shafts that carry the rollers around in contact with a die-ring as in a Huntington mill. The finely pulverized coal becomes so light that, separating from the coarser product, it can be drawn upward by an exhaust-fan, the material from any mill entering its own 7-ft. cyclone collector. In this collector the pipe enters tangentially and the dust, striking the walls, falls into the cone-shaped bottom, while the air, now measurably free from dust, is returned to the mill, thus completing its closed circuit. From the curved summits of the return air-pipes vertical branches rise to the 4-ft. auxiliary collectors, affording relief to the air drawn in at various joints of the Raymond mills. From the outlet-pipes of the auxiliary collectors may be noticed a thin cloud of coal-dust too fine for settlement. It is at the point of the 7-ft. cones that we have another helicoid conveyor, this

time transferring the dust to the west end of the building, and another transverse one taking the dust north to the gallery of the reverberatory-building already mentioned. It is along this gallery that extends a final helicoid conveyor supplying the reverberatory hoppers.

Counting to the fourth collector from the east end, there is a 6-in. right-hand helicoid conveyor, which can get its coal-dust from the 14 in. one above it, simply by opening a slide. The 6-in. conveyor moves the dust to the east end of the building, where it drops into another transverse one running along the wall. Thus at will coal-dust can be supplied to any of the drier fire-boxes, though at present those boxes are fired by hand with run-of-mine coal.

Copper Production of the Large Mines

The following table, from the *Boston News Bureau*, shows the increased yield of some of the great mines of this country during the past year, figures for 1915 being in nearly every case the official estimate, and for 1914 they represent actual production (in pounds):

| | 1915. | 1914. |
|------------------------------|---------------|---------------|
| Ahmeek | 22,000,000 | 13,634,605 |
| Allouez | 10,000,000 | 6,056,548 |
| Anaconda | 234,000,000 | 207,000,000 |
| Arizona Commercial | 3,500,000 | |
| Braden | 35,444,000 | 28,223,000 |
| Calumet & Arizona | 62,500,000 | 52,667,929 |
| Calumet & Hecla | 71,000,000 | 53,691,562 |
| Centennial | 2,500,000 | 2,287,130 |
| Chino | 60,000,000 | 53,999,908 |
| Copper Range* | 55,000,000 | 27,800,000 |
| East Butte | 12,668,800 | 9,175,579 |
| Granby | 42,239,734 | 22,080,005 |
| Greene-Cananea | 16,347,000 | 21,858,920 |
| Inspiration† | 20,012,073 | |
| Isle Royale | 10,000,000 | 6,601,235 |
| Kennecott | 63,000,000 | 20,000,000 |
| Lake | 967,642 | |
| Mass Cons. | 4,650,000 | 2,955,952 |
| Miami | 41,350,000 | 33,296,010 |
| Mohawk | 15,500,000 | 11,094,859 |
| Nevada Consolidated | 58,000,000 | 49,244,056 |
| North Butte | 20,000,000 | 18,421,761 |
| Old Dominion | 27,860,000 | 30,438,000 |
| Osceola | 20,000,000 | 14,970,737 |
| Phelps, Dodge & Co. | 139,432,000 | 139,500,000 |
| Quincy | 21,750,000 | 15,356,380 |
| Ray Consolidated | 62,621,947 | 57,004,281 |
| Shannon | 5,705,800 | 9,003,169 |
| Shattuck-Arizona | 15,000,000 | 10,846,918 |
| Superior | 4,500,000 | 3,217,635 |
| Tamarack | 4,100,000 | 1,074,808 |
| Tennessee | 12,900,000 | 12,871,000 |
| United States Smelting | 22,500,000 | 17,946,659 |
| United Verde | 36,000,000 | 32,449,116 |
| Utah Copper | 158,000,000 | 115,690,445 |
| Winona | 1,500,000 | |
| Wolverine | 7,400,000 | 6,055,000 |
| Total | 1,399,948,996 | 1,106,513,197 |

*Including St. Mary's 50% interest in Champion output.

†From start of new plant.

Stamps and Competitive Machinery

By H. C. Cutler*

"If gold mill operators are prepared to abandon the use of the stamp as an amalgamating device, and will send the stamp mill pulp directly to the tube mills, passing the tube mill discharge over amalgamated plates before sending it to the cyanide plant, the question may be raised as to whether it is necessary to retain stamps for the preliminary crushing of the tube-mill feed. The verdict of experience seems to be that the tube-mill is an excellent crushing device to free gold from its adhering gangue, the impact of the pebbles furnishing a sufficiently heavy blow for the comparatively small particles with which the tube-mill is fed. The logic of the situation would then seem to be that the crushing of the tube-mill feed should be done by the most efficient machine or machines, regardless of their principle of crushing action. This scheme of milling is about to be put into practice in the new large mills of the Alaska Gold Mines and publication of the results of operations there will be awaited with the keenest interest by mill-operators elsewhere."

The above extract from an editorial in the *MINING AND SCIENTIFIC PRESS*, October 3, 1914, is indicative of the situation that has confronted the milling fraternity for some time past. In the course of a trip during the past summer to some of the large copper-concentrating plants, I could not help but be impressed with the methods and costs of reducing ore from mine-run size to tube-mill feed. Without doubt the copper metallurgists have something of an edge on the precious-metal mill-men in this stage of the crushing operation, and it occasions no surprise that when a metallurgist conversant with these methods goes into gold-milling on a large scale, as has D. C. Jackling at the Alaska Gold Mines, he should use the methods by which he has been able to obtain such small costs in the reduction of copper ores. Just why the gold and silver mill-men have adhered to the use of stamps as a means of comminution in stage-reduction, especially when used to produce a product as large as 4-mesh, is hard to see, in the face of a comparison of costs with other methods. Granting that it is done, stamps must possess some advantage over other types of machinery to warrant their continued use, unless we are to make the claim that it is all a matter of prejudice. The main claims for preference as given by one operator who still persists in using stamps are as follows:

"Stamps are flexible: By a change of screens, height of discharge, and other adjustments, the product can be varied from very fine material to as coarse as desired. Stamps are obtainable in small units, each unit as efficient as another, so that the total capacity can be in-

creased cheaply and easily by the addition of units. Stamps are practically fool-proof, simple in design and operation, and easy to transport. There are plenty of men skilled in their operation. Repairs are easy. In repairing it is necessary to shut-down only one unit at a time, thus not interfering with the operation of other portions of the mill. Stamps will operate on any kind of ore, wet, clayey, hard or soft, with very little change or adjustment. In addition, there is a certain advantage when used as an amalgamating device and especially when amalgamating inside the mortar."

In a number of places, doubtless, the advantages as outlined above would outweigh the claims of any other style of crusher. For a small mill, of, say, 50-ton capacity per day, using either straight amalgamation or a combination of processes, especially where first cost is an item, there is probably no other single machine as efficient, but in larger units than this, even where amalgamation is used, and in mills where stamps are employed as intermediate crushers, their cost of operation is higher and their efficiency less than several other machines on the market.

Stamps were among the earliest of machines used in America for the reduction of gold and silver ores and they did the work without trouble. At first, however, the ores handled were usually of high grade so that a few cents more in the cost of reduction made but little difference, and in the case of a question as to the choice of crushing machinery, it is a matter of common knowledge that operators generally stick to what they are accustomed and know will do the work. This accounts for a good many installations of stamps.

With the development of the 'porphyry' copper mines, with their huge bodies of low-grade ore, the reduction of a large tonnage at a minimum cost became imperative. Better and cheaper methods of reduction had to be used to make any profit at all, and stamps would not stand the competition. Cheaper methods were devised. As the number of mines containing bodies of high-grade gold and silver ores lessened, the lower-grade ores began to create more interest and the matter of costs of metal production assumed importance. At the present time a few cents difference in crushing costs is an item scrutinized with great care, and for this class of crushing, stamps are falling behind and will be used less and less.

In the work of coarse crushing that precedes stamps the cost has apparently reached a minimum without much chance of reduction. Run-of-mine ore has been crushed to $\frac{3}{4}$ -in. size for less than three cents per ton with gyratories and disc-crushers, which is so low that the saving in costs must be made from this stage forward.

*Mining Engineer, Reno, Nevada.

The fineness required depends to a large degree upon the metallurgical process adopted in the extraction of the metals contained; again, upon the fineness required depends largely the choice of crushing machinery. The problem is to reduce the product of the coarse-crushing plant, say, a maximum of 1½-in. material, to the fineness best suited to metallurgical treatment.

For concentration of copper ores the size of this final product may vary, depending upon the size and character of the particles of mineral in the rock, and whether water concentration, oil flotation, leaching, or a combination of two or all is to be used. The same thing is true of gold and silver ores, the product desired depending almost entirely upon the character of the ore and the metallurgical process to be used. Before the introduction of the cyanide process, fine grinding was not in vogue, a 40-mesh product was considered adequate and it was for this class of work that the stamp-mill secured such a commanding position. This held true to a large extent during the time that the cyanide process was limited to percolation. When agitation with all-slimes was introduced, further grinding became necessary, and the tube-mill, which had been an efficient machine in the cement industry, was added as a finisher.

The 600-ton test-mill erected and run by the Inspiration Copper Co. attempted to solve some of the questions involved. The results desired were slightly different from those of most gold and silver mills. An ultimate product, all of which would pass 48-mesh was most suitable for subsequent treatment by flotation, while in cyanide work the finer the ultimate product the better, a product all of which approaches 200-mesh being desirable. H. Kenyon Burch had charge of the testing; he had an idea of obtaining a machine that would make the reduction from ¾-in. material to the desired 48-mesh in one operation, thus reducing floor-space, elevation, and subsequent attendance. A large number of machines of various kinds were tried and it appeared impossible to obtain one machine that would do this; so stage-crushing was adopted. The Symons horizontal 48-in. fine-disc was installed early and was a great success in reducing a maximum of 2½-in. material to 6-mesh. This feed was tried in Hardinge machines and tube-mills, but it seemed to increase their work out of proportion; hence intermediate crushers of various kinds were introduced in the circuit, taking the disc-discharge and effecting a reduction to 16-mesh, which seemed to be the best feed for the tube-mills. None of these intermediate machines was successful, and it appeared for a time as if the work would finally be done by the use of the Symons fine-disc and Hardinge pebble-mills. Almost at the last moment the Marey ball-mill was installed, taking the product of the coarse-crusher plant and reducing to 48-mesh in the one mill, using a classifier and closed circuit. That this mill and its operation proved to be the most economical of the machines tested is evidenced by the fact that Marey ball-mills were installed in the 10,000-ton mill.

It is claimed that the most desirable feed for the ball-mill is a mixed one, coarse and fine, the coarse material

filling the spaces between the balls, thus reducing the grinding action of ball on ball, and lessening the consumption of iron.

It would appear from the Inspiration experiments with the ball-mill that one-stage reduction is cheaper than multiple-stage reduction. Judging from this, the logical design for an all-slimes plant would include nothing but ball-mills working on closed circuit with classifiers, thus eliminating stamps, tube-mills, and intermediate crushers, such as Chilean mills, rolls, etc. Whether or not the ball-mill would operate as efficiently when producing a 200-mesh product, as it does when producing a 48-mesh product, is a question still open to experiment. It is quite possible that the tube-mill could be used to advantage as the final-crushing device. The question of the proper size for tube-mill feed is still undecided and probably always will be as long as the character of ores varies. The Mines Trials Committee at Johannesburg decided that from 3 to 4-mesh feed gave the best results on their ore.

In his article on the operation of the Goldfield Consolidated mill, J. W. Hutchinson says that 16-mesh feed gives the best results on that ore. In the experiments at the Inspiration, the best results were obtained on a feed that passed 8-mesh. All of the mills at Tonopah use a finer feed than 4-mesh. The reason for the difference is this: at Johannesburg an all-slimes product is not absolutely necessary; at Goldfield and Tonopah it is. Therefore it seems reasonable to believe that where an all-slimes product is desired, the tube-mill feed should be finer than 8-mesh, so that, disregarding for the moment any machine that promises to perform the whole operation of reducing from coarse-crusher product to slimes in one operation, the problem resolves itself into reducing a maximum of 1½-in. material to at least 8-mesh at the smallest possible cost.

This can be done in one operation or by stage-reduction consisting of two or more successive reductions. The most preferable is the cheapest. The following machines will accomplish this reduction in one operation: stamps, ball-mills, Huntington mills, roller-mills, Chilean mills, and various forms of centrifugal crushers.

With the exception of the ball-mill, all of these machines have been thoroughly tested in competition with stamps for one-stage reduction and the consensus of opinion is that stamps are preferable. But Mr. Hutchinson has shown in his operation of the Goldfield Consolidated mill that even with stamps a greater economy can be obtained in the preparation of the tube-mill feed by a two-stage reduction. By using the stamps as intermediate crushers and re-grinding the product in Chilean mills he saves enough in the tube-milling operation to enable him to save on the whole operation. There are few mills that have had an opportunity to try the two methods in competition on the same ore, but it is reasonable to suppose that the theory would hold true on other classes of ore.

The deductions made by Mr. Hutchinson are as follows:

1st. Ore may be reduced to 4 mesh in the stamp but try more economically than to 12 mesh.

2nd. For the reduction of particles to 16 mesh, where all slime is required, stamps followed by Chilean mills are more efficient than stamps alone.

3rd. Ore may be reduced to 200 mesh in the tube mill more economically when the mill is fed with 16 mesh than with 4 mesh.

The question now arises, can this reduction be accomplished by any other set of machines than stamps and Chilean mills? In concentrating plants it has been customary for years to use rolls for this intermediate crushing. Their efficiency over any other class or kind of crusher, with the possible exception of the Symons' disc has never been questioned. As the tendency of most modern mills using stamps, with the exception of those practising amalgamation in the batteries, is to crush coarse, using the stamp merely as an intermediate crusher, therefore there is no doubt that rolls in the majority of cases would do this work at a lower cost. But rolls, unlike stamps, are not adapted to all kinds of ore. If the ore is wet or talcose, considerable difficulty is experienced in getting capacity per horse-power. When the ore is suitable for the use of rolls, the cost of reduction from $1\frac{1}{2}$ to $\frac{1}{4}$ inch should not exceed half the cost of doing the same work with stamps. As to the resultant product it has been clearly proved that the amount of fine is greater in the stamp-mill product than in the product from rolls. This fact, in view of subsequent classification and further reduction, would counteract to some degree, but not entirely, the difference in cost of the two operations.

After nearly a year of testing by the Inspiration company and before the installation of the Marcy ball-mill, it appeared as if the Symons horizontal disc (called their fine disc) would be the machine adopted to perform this first stage of reduction of the product from the coarse-crushing plant. In the operation one 48-in. fine disc crusher was used; with an impact screen ahead of the disc to remove all undersize it was found that 35 to 50 tons per hour could be handled, crushing from a maximum size of $2\frac{1}{2}$ in. to 1 or about 4-mesh. The power consumed varied from 30 to 55 hp. and the total cost, including attendance, would not exceed 3 cents per ton with power at $\frac{3}{4}$ cents per kw-hour, charging the crusher with the time of one man.

One of these machines would do the entire work of the 100 stamps at the Goldfield Consolidated, taking the product of the coarse-crushing plant and reducing it to 4-mesh at a cost not to exceed 3.4c. per ton under their present conditions of power and labor. With no change in the operation from this point onward, using Chilean mills and tube-mills for re-grinding, at the same figures as furnished by Mr. Hutchinson, the total cost of this three-stage reduction would be 30.6c. or a saving of 10c. per ton over the present system of using stamps for the first stage.

Of course, it is impossible to give any general figure as to the cost of operating stamps; various conditions,

cost of power, character of ore, and labor vary to such an extent. The published costs range from 9 to 60c. per ton, and it is only when comparisons are made between two systems on the same ore, as Mr. Hutchinson has done, that the relative efficiency can be determined; but I believe I am safe on the estimate for the use of the Symons disc on Goldfield Consolidated ore, which is not as difficult to crush as that of the Inspiration. No doubt equally as good results could be obtained on this ore by the use of ball-mills.

Up to the time of the first installation of the Marcy machine, the ball-mill, while in extensive use as a dry-crusher, was not considered generally as a wet-crushing mill. H. W. Hardinge has been an advocate of the use of ball-mills in place of stamps for a number of years, and in a conversation with him in Arizona in 1914 he predicted the gradual abandonment of the stamp in favor of the wet-crushing ball-mill. The adoption of ball-mills by the Inspiration company after a year of testing on all classes of crushing machinery, and the recent decision by one of the large mining companies of Alaska to use ball-mills in preference to stamps would indicate that the results obtained by this machine are better than anything else on the market, both as to lowness of cost and general efficiency, considering ball-mills rather as a type and making no distinction between the different makes.

The great capacity of the Marcy ball-mill is obtained by the use of the peripheral discharge and a proper consistence of the pulp. The peripheral discharge attains a point long desired by the tube-mill, that is, a rapid discharge of particles already crushed to the desired fineness, the retention of which by the tube-mill causes a sort of mush to form from about the centre of the mill to the discharge end, furnishing a cushion for the pebbles and retarding grinding. It is also claimed that the proper consistence of the pulp effects a saving in the amount of iron consumed. A publication of the results obtained by the Inspiration company in the operation of the various machines used by them in their test-mill would be a contribution to the art well worth receiving.

Whether or not the ball-mill will replace the stamp-mill in the future, its development will be watched with much interest. One manufacturer is making a mill with a baffle back of the screen, by means of which the height of the discharge can be regulated from a straight peripheral discharge to a complete centre-discharge. The benefits claimed are a better regulation of the product, making in one operation whatever is required from 40-mesh to all-slime material.

Whether it is cheaper to make a slime product in one operation or classify and treat the oversize in a tube-mill is still a matter of experiment. With the improvement in balls, a reduction in their cost, and the better methods of using them, it is claimed by some operators that they are cheaper than pebbles. A number of experiments are now being made by several companies in the use of balls in tube-mills, cutting down the size of tube-mills by the use of screen-baffles.

The Present Value of a Mine

By F. Sommer Schmidt

The question of determining the 'present value' of an annuity yielding dividends at $R\%$ and replacing capital by a sinking fund at $t\%$ is one that arises occasionally in valuing a mining stock. When such an occasion does arise, few engineers are sufficiently conversant with this phase of mathematics to solve problems at all out of the ordinary, and then only when armed to the teeth with various tables.

Having recently been thrown against a problem of this nature that could not be solved by a simple use of tables, I was forced to originate a formula of my own. In so doing, I became interested in the question and decided that many of my colleagues would welcome such a statement of mathematical relationship as would enable them to solve these problems with the use of logarithmic tables, or compound-interest tables, or sinking-fund tables, or present-value tables, as the case might be.

In the following I use the word 'dividend' to represent the total net profit available for distribution, 'interest' to represent the annual income expected from the investment, which item is considered separate and apart from the 'sinking fund' that must replace capital. Therefore dividend = interest + sinking fund.

Let us assume that we have a table of the present value of an annuity that yields interest at $R\%$ and replaces capital by a sinking fund at $t\%$ in n years, but that the range of the table is not great enough, or that there are not sufficient decimal places. Our table is limited to 10% and 4% for 50 years, and we desire 10% and 5% for 100 years.

If we have a sinking-fund table the problem is simplified. Such tables are easily procured, reading to 10% for 100 years to 6 decimal places. Then we can figure as follows:

From our sinking-fund tables we find that we must put aside \$0.000383 each year to have \$1 at the end of the required 100 years at the required 5% . If our investment must also pay interest of 10% on the dollar each year, it is necessary to earn \$0.000383 + \$0.10 = \$0.100383 or an annuity of \$0.100383 = \$1 in 100 years under the conditions, and the value of an annuity of \$1 = $\frac{1}{0.100383} = 9.9618$, which is the P.V. (present value) of \$1 per annum yielding 10% interest and replacing itself at 5% in 100 years.

To prove this, we have 10% interest on our investment of 9.9618, or 0.99618, to be paid out of the \$1 annuity, leaving 0.00382 for the sinking fund each year. Now from the interest tables \$1 per annum for 100 years at 5% = 2610.025, which multiplied by 0.00382 gives \$9.970, which is the replacement of our capital of 9.9618.

To solve this same problem without sinking-fund tables, we note that the sinking fund is simply the reciprocal of the \$1 per annum amount under the same conditions, which can be obtained from an interest table. Instead of simply taking the factor 0.000383 from the sinking-fund table, we note that the amount of \$1 per annum at 5% for 100 years is 2610.025, the reciprocal of which is 0.000383.

To solve this same problem with only a logarithmic table, we note:

The amount of \$1 per annum = $\frac{(1+t)^n - 1}{t}$, in which t is the interest rate, n the number of years. $(1+t)^n$ is the amount of \$1 at compound interest in n years.

To apply this formula in our example, $t=0.05$, $n=100$. Amount of \$1 per annum = $\frac{(1+0.05)^{100} - 1}{0.05} = 2610$, which checks against 2610.025 as found from the tables.

We are now ready to make up a formula of our own for determining the present value of an annuity to pay interest at $R\%$ and replace capital by sinking fund at $t\%$ in n years, which can be solved by using only a log table, is applicable under universal conditions, and is simpler than any other I know.

If $\frac{(1+t)^n - 1}{t}$ is the amount of \$1 per annum and we multiply this by the annual amount available for sinking-fund purposes, after interest has been subtracted from dividends, the product will be the total accumulation of the sinking fund, and this is what we consider the replacement of our capital and can therefore be placed in equality with the present value. Now to express this factor of 'sinking fund available' in terms of one unknown quantity we note that it is $D - R \times P$, in which D is the dividend that furnishes the interest and sinking fund, R is the rate of interest expected from the investment, and P is the present value or total accumulation of the sinking fund.

Hence $P = (D - R \times P) \left(\frac{(1+t)^n - 1}{t} \right)$, in which P is the only unknown quantity.

As an example: find the present value of an annual dividend of \$1 to yield interest on the investment at 8% and replacing capital at 4% in 80 years.

$D=1$, $R=0.08$, $t=0.04$, $n=80$.

$$P = (1 - 0.08P) \left(\frac{(1+0.04)^{80} - 1}{0.04} \right) \\ = (1 - 0.08P) 551.24 \therefore 45.099P = 551.240$$

$P = 12.2228$, which checks against 12.2228 in Inwood's tables.

As this is the factor for a dividend of \$1, it would be

multipled by 100 actual number of dollars in estimated dividends

We can now attack the problem of finding the present value of a stock that will earn a certain amount per annum for a certain number of years and then increase or decrease its earnings for the remainder of the life. There are no tables covering these conditions, and I offer the following formula as my solution:

- Let P = present value
- D = dividends per share 1st period
- D' = dividends per share 2nd period
- R = rate of interest expected
- t = rate of interest of sinking fund
- Y = number of years of 1st period
- Y' = number of years of 2nd period
- $P = (D - R) \times P$ (amount \$1 per year for Y years @ $t\%$) \times (amount \$1 in Y' years @ $t\%$) $\div (D' - R) \times P$ (amount \$1 per year in Y' years @ $t\%$).

In this formula $(D - R) \times P$ = amount available for sinking fund each year in the first period. This multiplied by amount of \$1 per year in Y years @ $t\%$ is the accumulated sinking fund to end of the first period, but as this amount will stand at compound interest @ $t\%$ in the sinking fund for the whole of the second period, we multiply this by the amount of \$1 in Y' years @ $t\%$. We have now taken care of this first period and add to it the amount annually available for sinking fund during the second period multiplied by amount of \$1 per annum in Y' years @ $t\%$, which thus makes the sum total of sinking fund expressed in terms of one unknown quantity and must equal the present value.

From the same line of reasoning we would have for three stages of earnings.

- $P = (D - R) \times P$ (amount \$1 per annum Y years @ $t\%$) $\div (D' - R) \times P$ (amount \$1 in $Y' + Y''$ years @ $t\%$) $\div (D'' - R) \times P$ (amount \$1 per annum Y'' years @ $t\%$) \times (amount \$1 in Y'' years @ $t\%$) $\div (D'' - R) \times P$ (amount \$1 per annum Y'' years @ $t\%$), in which D, D', D'' represent the dividends of three periods, and Y, Y', Y'' represent the number of years of the three periods.

As an example, take a stock that will earn \$2 per share for 20 years and then \$2.50 for 15 years. What is the present value if we expect 10% interest and a replacement of capital at 4%?

From the interest tables we note that

- The amount of \$1 per annum @ 4% for 20 years = \$29.778
- The amount of \$1 per annum @ 4% for 15 years = 20.024
- The amount of \$1 @ 4% for 20 years = 1.801

Substituting $D = 2, D' = 2.50, R = 0.10, t = 0.04, Y = 20, Y' = 15,$
 $P = (2 - 0.10)P = 29.778 \div 1.801 = (2.50 - 0.10)P = 20.024,$
 $P = 5.363P \div 2.002P = 107.260 \div 50.060,$
 $P = 18,807.$

Our last equation can be put into the form:

$P = 1 - 5.363 = 2.002 = 107.260 \div 50.060$, in which the parenthesis is 1 = accumulated value @ $t\%$ of the interest @ $R\%$, and the right-hand member is the accumulated value @ $t\%$ of the dividends for total life.

We could therefore make a more concise statement of the formula as follows:

$$P = \frac{\text{accumulated value @ } t\% \text{ of dividends for total life}}{1 + \text{accumulated value @ } t\% \text{ of the interest @ } R\%}$$

I am indebted to Charles Carpenter of the Metropolitan Life Insurance Co., for this concise form, but unfortunately the same steps and figures have to be used as given in my detailed formula.

To check our result of \$18,807 as given above we figure that 10% interest or 1.881 is to be subtracted from dividends of \$2 leaving 0.119 to the sinking fund for capital redemption. This 0.119 per annum @ 4% for 20 years = $0.119 \times 29.778 = 3.543$ accumulated in sinking fund in the first 20 years which amount now stands at interest 4% for 15 years or $3.543 \times 1.800 = 6.377$ total accumulation from dividends of the first period.

The second period interest requirements being the same, 10% of 18,807, leaves as a balance from the new dividends of 2.50 the amount of 0.619 per annum for sinking fund, which in 15 years is $0.619 \times 20.023 = 12.394$ contribution from the 2nd period
 6.377 as figured for the 1st period

- 18.771 Total capital redeemed
- 18.807 Present value.

The discrepancy is simply a matter of insufficient decimal places. For simplicity, compounding of interest has been assumed to be annual.

For the benefit of those who may consult the excellent book of J. R. Finlay entitled 'Cost of Mining' (1909) on this subject, I would like to draw attention to what I consider an error, on page 16, which deals with the derivation of a 'present value' formula.

- y = annual sinking fund.
- D = rate + 1 at which sinking fund is invested.
- X = number of years life.

The statement is then made that present value = $Y (D + D^2 + D^3 + D^4 \dots D^X)$, with which I do not agree. We have not earned our annual sinking fund Y till the end of the first year, so that we cannot count our first year's sinking fund as YD and the second year's as YD^2 , but rather that our first year's sinking fund is Y and the second year's YD , the third YD^2 , etc., giving us:

Present value = $Y (1 + D + D^2 + D^3 + D^4 \dots D^{X-1})$, which is reduced to $\frac{Y(D^X - 1)}{D - 1}$ and not $\frac{YD(D^X - 1)}{D - 1}$

Therefore when an example is solved on page 17 involving this error, the value of S includes one superfluous factor, 1.04, giving 30.97 instead of 29.778. When substituting this former value and solving for Y the result is 0.994 instead of 1.02 as the annual sinking fund; giving the final result of 30.78 for the present value, instead of the correct one 30.39. The result obtained by Mr. Finlay does not check with the tables on his page 46.

Excellent books on this subject are: 'Inwood's Tables for the Purchasing of Estates,' revised and extended by Schooling, now in its 30th edition, published by Crosby Lockwood & Son, London; 'Cost of Mining' by J. R. Finlay; and 'Principles of Mining' by H. C. Hoover.

The Elm Orlu-Butte & Superior Decision

On page 174 of our issue of January 29 we gave a summary of the decision of Judge George M. Bourquin in the suit of the Clark-Montana Realty Co., which controls the Elm Orlu Mining Co., against the Butte & Superior Copper Co., both important zinc producers at Butte, Montana. The following are interesting abstracts from the Judge's opinion:

Plaintiff alleges that the Elm Orlu is the older location, and defendant alleges the Black Rock is. Plaintiff alleges that the apex of the Pyle strand is in the Elm Orlu and crosses the Elm Orlu east end-line, and that the vein on strike and dip unites with the Rainbow vein; and defendant denies all thereof at points east of the Rainbow apex crossing of the common side-line that would give extra-lateral rights to plaintiff. Defendant alleges that the Rainbow and Jersey Blue unite on strike and dip, and plaintiff denies it and alleges that on strike and dip the latter crosses the Rainbow. Defendant alleges the easterly strand of the Rainbow crosses

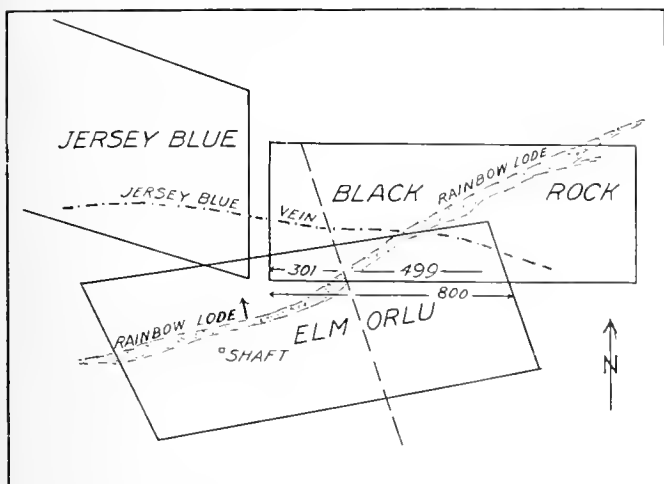

the Black Rock east end-line, and plaintiff denies it. Defendant asserts some ownership of orebodies under both claims by virtue of estoppel by deed executed by plaintiff to defendant's predecessor in interest, and plaintiff denies estoppel. Both parties allege and deny trespass and damages and accounting is desired. Appropriate legal consequences and rights are asserted by both parties. The trial consumed 16 days. There are nearly 1600 pages of testimony, and 30 exhibits. Maps and models are duplicated, save in more or less theoretical geology from which unwarranted impressions are to be avoided. The testimony is of five experts for each party, all men of eminence in geology or mining engineering or both. For plaintiff are Greene of Butte, Irving of Yale, Weed of New York, Searls of Nevada, and Winchell of Minneapolis. For defendant are Finch of Denver, Emmons of Minnesota, Salisbury of Chicago, and Burch and Wiley of California. There is some conflict of facts and more of argument, opinions, and conclusions. Most of it can be imputed to the complex geological and other problems, conditions underground, difficulties of observation, and honest differences of interpretation by reasonable and learned men. But in instances partizanship apparently impaired judgment. As a whole, however, the testimony inspires confidence and deserves careful consideration. The judge gave two days to inspection of the premises, but since some places in evidence had been stoped and others obscured by fallen ground or timbering, with intermittent crevices and small openings through which to peer and distinguish granite, altered and otherwise, slips, faults, gouges,

aplite, quartz, seams, and veins, he has not been greatly aided to determine what evidence is more credible and weighty.

* * * * *

A location and its record are different things. The Federal and most State statutes distinguish between them, the former even in authorizing local rules "governing the location" and "manner of recording." The statutory object is to protect and reward discoveries of mines. Discovery with intent to claim is the principal thing, and vests an estate—an immediate fixed right of present and exclusive enjoyment in the discoverer.

* * * * *

If the Montana statute made recording of the nature of conditions-subsequent (of feudal origin) at common law such conditions are to be but substantially performed, and no assignee of part of the premises to which the conditions attach can take advantage of their breach; and the owners of the Black Rock securing the conflict area were at most assignees of but part of the Elm Orlu premises. The United States forfeited neither claim for defective verification—if a breach of conditions-subsequent. The estate in neither, if voidable, was avoided. Both were confirmed and patented. Where Congress intended forfeiture of mining and other public land claims for breach of conditions-subsequent it plainly said so; vide forfeiture for failure to perform or contribute to annual labor. Recording acts that expressly provide forfeiture for failure to comply with them do so in favor of only subsequent bona fide claimants. Forfeitures are odious and not to be implied. Prior to patent entry of these claims, a Montana statute provided that all ambiguous statutes should be construed "in favor of natural right;" and it would not have been too far-fetched to apply it to the statute directing recordation of mining claims. In 1875 Montana was indeed primitive. Those learned in the law were few. It is doubtful if there was a lawyer in Butte. The prospectors, pioneers, and founders of this wonderful West, seeking in good faith to comply with the recordation law, for mere technical failures therein should not have been subjected to so harsh a construction of that statute and deprived, as many of them were, of their discoveries. And deprived for whom? Subsequent bona fide discoverers and locators? No; as a rule for those unspeakable creatures who search public records to discover and take advantage of defects in their neighbors' titles.

These statutes are of no more force and effect than miners' rules. Both are authorized by the one Federal statute. The better if not prevailing rule always has been that if the recordation law does not expressly provide forfeitures for failure to record, the location is valid though not recorded. Last Chance Mining Co. v. Bunker Hill Mining Co. 131 Fed. 585.

* * * * *

For plaintiff the testimony is that the latter crossing is "about" 308—"rather the extreme and indefinite limit of the mineralization which accompanies the vein"—to 314 ft.; for defendant, "about" 300 to 301 ft. All agree there is no defined wall, that it is indefinite and leaves much to judgment. Considering the evidence in light of inspection and that the burden of proof is upon plaintiff, it is believed that the concession of defendant is more nearly right and as favorable to plaintiff as the facts warrant. The exposure is in a surface trench, and it is difficult to distinguish vein matter in place from mere seepage effect in adjacent country, whether of vein solutions or surface waters, and perhaps mushrooming beyond the limits of the vein proper below. A shaft might have contributed to accuracy. Finch testified that within the limits of the 300 he included 15 ft. to the extreme limit of rock alteration, with a few little seams in it, "to be consistent with the interpretation of a vein at other points." This is admirable frankness, but imports that at vital points and to indefinite extent he characterized that as vein which in his judgment is not vein, to serve his client and avoid hazard of comparison. The difficulty is that when an expert shades his testimony

upon the principle of *do ut des*, patzianship is likely, if not certain, to favor his client, and the court cannot determine to what extent, inevitably detracting from the weight of his opinion.

• • • • •
Whether the Jersey Blue unites with the Rainbow is the most contested issue. In view of the finding that the Elm Orlu is the older location, each party contends against its own interest. During the trial and argument for the defendant, it was admitted that the Rainbow apex crosses the Elm Orlu west end-line and the common side-line; that from its apex in the Elm Orlu on its dip it extends under the Black Rock, and that the great orebody in dispute west of the apex crossing at the common side-line, under both claims and in places bisected on strike by said side-line, is in said vein; and that it extends downward to the uttermost depths. These facts are conclusively proved as well. This admission overcomes the common-law presumption that defendant owns the part of that orebody under the Black Rock west of the apex crossing, and imposes upon defendant the burden of proving by a preponderance of the evidence (1) that the Black Rock is the older location, (2) that the Jersey Blue united with the Rainbow above any part of that orebody by defendant claimed. The whole is a single orebody under both claims, the apex of the whole being in the Elm Orlu. To avoid the otherwise inevitable legal consequences, the defendant must prove the union of veins even as it must prove the estoppel by deed it alleges. And this burden cannot be sustained by leaving the issue in doubt or balance. This is clear in respect to (1) that part of the orebody above the alleged union and under both claims, (2) that part of it below the union and under the Elm Orlu. And so is it in respect to that part of the same orebody below the union and under the Black Rock. Defendant confesses and avoids. In equity, as at law if a fact is admitted and another fact is averred to avoid it, the fact admitted is proved, with all its consequences, and stands as though the fact in avoidance had not been averred, unless the latter also is proved. See *Clement v. Nicholson*, 6 Wall, 315.

• • • • •
This mineralization outside of and between the veins is of little extent and consequence. It doubtless at some places extends from vein to vein, and some thereof in transverse fissures. But little of it is commercial value, and it by no means merges the veins. Both, as Emmons testified, retain their identity by reason of a "pretty definite limiting zone outside the two master fractures" of the two veins. It is not near as extensive as painted by defendant; otherwise, and if Finch's theory is correct (all the fissuring here is steep and seems normal—of tension), it ought to also appear where it does not, north of the veins at depth, where the north country is the hanging-wall side. The fracturing may be there, but not the mineralized "horse-tail" structure; and it is fair to infer that the mineralization between the veins came in connection with the great mineralization of the Rainbow and little from the barren Jersey Blue. These two veins have points of resemblance, but more of difference. The Jersey Blue more approximates to the "Blue" vein than to the Rainbow. Defendant's witnesses are of the opinion the Rainbow and Jersey Blue are of the same age and unite, the latter a strand of the former. Plaintiff's witnesses are of contrary opinion. The latter definitely describe places where the Jersey Blue crosses the Rainbow, from observation. But it is difficult to determine whether the testimony of defendant's witnesses unite; is theory, inference from or reflection of defendant's maps or actual underground observation. Close scrutiny of the testimony disclosed that none of defendant's witnesses testified that he actually saw in the ground a union or merger of the veins, save Finch, who was evidently put forward for the specific purpose, and in every instance, and they are but three or four, that Finch testified to a "definite

junction" of the veins, or where "seen to unite," he not only did not describe the manner of the union, save in one instance that it was not along gouge, but in a "mass of ore," but he placed it in undeveloped territory or in the "horse-tail" structure and north of the Rainbow hanging wall; and he so pointed it out and measured distances on defendant's maps. Converging strike and dip are no more persuasive of union than are crossing of veins. In these premises veins are shown to cross as often if not oftener than they unite. It is a circumstance to be noted that in testimony and argument it is insisted in defendant's behalf that its maps are evidence, intended to speak for themselves, and to illustrate faults, ore, and ore structure in the veins. This may be allowed in so far as they conform to proved facts or are not self-serving. And looking to these maps, they show the Jersey Blue ore-structure at an angle to and not merging in the Rainbow structure, and abutting against faults or gouge and not against Rainbow ore. But this is largely theory. It is surprising, in view of what is involved, that so little development has been done at the points of first contact between these veins and where union or non-union or crossing ought to be more open to determination than elsewhere. It is realized development is expensive. The ground is heavy and difficult to hold. Each party did some development work for the other.

Their workings unite at many points. But in instances both parties halted development at seeming vital points, as though fearful of results damaging to their theories. To briefly review this development, it is largely post litigation. In all the years subsequent to location of the Black Rock and until this litigation threatened, no workings from the discovery shaft were on the Jersey Blue.

• • • • •
In view of all the circumstances and that reasonable and learned men may honestly differ in their interpretation of geological phenomena in these premises, the Court is constrained to say the evidence is in equipoise; and so the determination is dictated by the burden of proof. Even as defendant fails to prove the veins unite, so would plaintiff fail to prove they cross, if the burden of proof was upon it. A principle of law, however, demands that the Court shall find that the veins do cross. Defendant alleges they unite, and claims an estate by reason of it. Plaintiff denies they unite, and alleges they cross and admits a different estate in defendant by reason of it. The defendant fails to prove the union and the estate it claims, the law is it must be awarded the estate that plaintiff admits or concedes to it. And accordingly the finding is that the veins cross, and, save at the intersection, defendant is entitled to all orebodies in the Jersey Blue south of the Rainbow and wherever it goes or where plaintiff admits it goes if not otherwise found. The Rainbow strand easterly from the Black Rock discovery shaft extends about 400 ft. east and to within 250 ft. of the Black Rock east end-line, where it is cut off by a north-west fault. Even at the discovery shaft it is east of any extra-lateral rights of plaintiff. No discovery shaft was required when the Black Rock was located. Both the Jersey Blue and the Rainbow were discovered when the location was made, or at least before the patent entry. Evidently, the cropping of the two veins gave the appearance of one continuous east-west vein, and the location was made accordingly. Neither the Jersey Blue nor the Rainbow is a secondary vein. Both are primary. The Jersey Blue overlaps the Rainbow. Extra-lateral rights based on it extend east beyond where the like rights based on the Rainbow begin. Indeed, taking the course of the Jersey Blue where fixed by plaintiff south of the Rainbow, it is probable it crosses the Black Rock south side-line east of the Elm Orlu east end-line. That the Rainbow crosses both side-lines is not controlling. There can be but one set of end-lines, and if the located end lines fix extra-lateral rights upon ore-vein, as they do upon the Jersey Blue, they fix them upon all veins.

REVIEW OF MINING

As seen at the world's great mining centres by our own correspondents.

LONDON

SHAREMARKET SITUATION.—MINERALS SEPARATION TONNAGE AND CONTRACTS.

The new year opened here with a notably more hopeful spirit prevailing. Renewed confidence is making its influence distinctly felt in all the markets. In the London mining market there was the usual rise of shares in anticipation of dividend disbursements at the first of the year, with a few notable advances due to special causes. Orsk shares, for example, have responded to the natural anticipation of a dividend incident to well sustained production with greatly reduced working costs. The East Rand is attracting much attention and the financing of Daggfontein has produced a good effect. One curious result has been American buying of South African shares. A number of orders for Geduld and other Rand shares have been executed for American clients and at one time 'Tanks' was in such demand as to start rumors of impending American purchase of control of either Tanganyika Concessions or Union Minière. Actual buying in the market proved to be small and sporadic, as would have been anticipated by anyone familiar with American methods of business. Whatever negotiations, if any, were under way between principals, evidently came to nothing. Union Minière is doing well, as are indeed all the Belgian companies in the Congo, but the shares are closely held in Brussels. The Belgians are a wealthy people, despite war losses, and are likely to hold on to what they have. After the War there will undoubtedly be re-adjustments of business relations, but bargain-hunters must not count too much upon the results of the temporary occupation of Belgium by the Germans.

Minerals Separation, despite many law-suits, is doing very well and the report presented to the shareholders by Mr. John Ballot, managing director, on December 29, showed the company to be in good condition, though the final value of its holdings will be largely conditioned on the outcome of the litigation in the United States and the length of the War. The company was incorporated ten years ago, and directly or through subsidiaries has spent £340,598 in developing, maintaining, and perfecting its patents, and in defending them in the courts. The original paid-in capital was £86,036. The remainder of the expenditure, plus investments with the cash surplus in the stock of the Australian and American companies came from royalties and represents use of the companies' patents. At the end of the year the various licensees of the company were treating about 4,500,000 tons of ore per annum by flotation and early in 1916, plants capable of treating 13,000,000 tons per annum are to be in operation. Mr. Ballot paid a high compliment to the Anaconda staff on the rapidity with which the reconstruction of the Washoe plant was carried out, and he gave his shareholders interesting details regarding the contract between Minerals Separation and Anaconda. Briefly, the Anaconda company, which acts for the Inspiration and the others, agreed to pay a minimum royalty of \$300,000 between February 1, 1915, and within five days after decision by the U. S. Supreme Court of Appeals in the Hyde case. After such decision is announced, it may return its license or may continue to work under it. In case the latter be elected, it guarantees to pay royalties upon a minimum of 25,000,000 tons of ore on or before November 6, 1923.

Arizona Copper is one of the three companies which comes under the terms of this contract; the fourth has not been announced. In the new Washoe plant four standard Minerals Separation machines of 600 tons per day capacity each (three active and one spare) were allotted to each of the eight units of the mill. The recovery, it was announced, has been raised from 78 to 96% since the introduction of flotation, and tailing now contains but 2 lb. copper per ton. Anaconda is building an 'all flotation' plant to treat 1200 tons per day of zinc ore.

VICTORIA, BRITISH COLUMBIA

METAL PRODUCTION IN 1915.—PRINCIPAL PRODUCERS.—DIVIDENDS.

—METALLURGICAL IMPROVEMENTS.—SAFETY MOVEMENT.

The total value of the mineral production of British Columbia in 1915 is estimated at \$29,879,000, as follows: placer gold, \$690,000; lode gold, \$5,326,000; silver, \$1,734,000; lead, \$1,903,000; copper, \$9,909,000; zinc, \$1,395,000; coal, \$5,432,000; coke, \$1,490,000; and miscellaneous products \$2,000,000. This total is \$3,490,175 higher than that for 1914. In quantities of the various minerals produced there were the following changes: increases of 6250 oz. placer gold, 10,330 oz. lode gold, 97,820 oz. silver, 12,390,301 lb. copper, 4,133,533 lb. zinc, and 13,923 long tons coke; decreases of 5,319,048 lb. lead, 258,867 long tons coal, and miscellaneous products equivalent in value to \$852,917.

Gold was produced in largest quantity by Rosland mines, the Centre Star group and the Le Roi; other notable producers of gold were the Granby company's mines at Phoenix, and the Nickel Plate group at Hedley. Silver came mostly from Slocan mines, with the Standard far in the lead with 850,000 oz., and the Hewitt and Surprise next with from 200,000 to 300,000 oz. each. The Sullivan mine, East Kootenay, produced more than 500,000 oz. The Sullivan also made a comparatively large output of lead—about 26,000,000 lb., while of a total of 14,000,000 lb. from Slocan mines the Standard produced 8,481,000 lb. The copper output was from the Granby company's mines, nearly 22,000,000 lb. from its Hidden Creek mine, Observatory inlet, and 16,000,000 lb. from its Phoenix mines; while the Britannia added about 10,000,000 lb. to the total. Zinc was in greatest quantity from Slocan mines, the output of the Standard having been 3,789,000 lb., and that of the Surprise estimated at 2,358,000 lb. Vancouver Island mines produced 956,000 long tons of coal, and in addition slack that yielded 9300 tons of coke; Crowsnest district collieries made a net output of 495,000 tons of coal, besides the slack producing nearly 240,000 tons of coke. Miscellaneous minerals, chiefly stone, clay products, and portland cement, came in largest proportion from the Coast district.

The total amount paid in 1915 in dividends by metalliferous mining companies operating in British Columbia was \$1,522,353. The amounts distributed by the several companies were as follows: Consolidated Mining & Smelting Co., \$164,398; Granby Consolidated, \$449,955; Hedley Gold Mining, \$300,000; Le Roi No. 2, \$58,000; and Standard Silver-Lead Mining Co., \$250,000.

There was little change at gold-treatment mills, except that the Hedley company made additions to the machinery and plant at its 40-stamp mill at Hedley, Similkameen. These included a 24 by 36-in. Traylor jaw-crusher, a second 5 by 22-in.

tube mill with Montana Fenopah lining, and a Dorr classifier which working in continuous system with the tube mill, is giving satisfactory results. Four cyanide tanks, two being 34 by 16 ft. and two 34 by 18 ft. made of Pacific Coast fir, and a third Oliver continuous filter, 8 by 12 ft., of latest design. The hydroelectric generating station on Similkameen river was completed at the beginning of the year. Its twin turbines have a capacity of 2100 hp. current is transmitted over a line 17,000 ft. long to the powerhouse at the mill, where air is compressed for mine and mill uses and current is distributed to all motors operating the mill machinery.

For concentration of silver-lead-zinc ores, there were but few changes. Improvements were made at several mills in the Slocan district, and following the destruction by fire of the Ivanhoe mill at Sandon, the lessee, J. P. Keane, put in

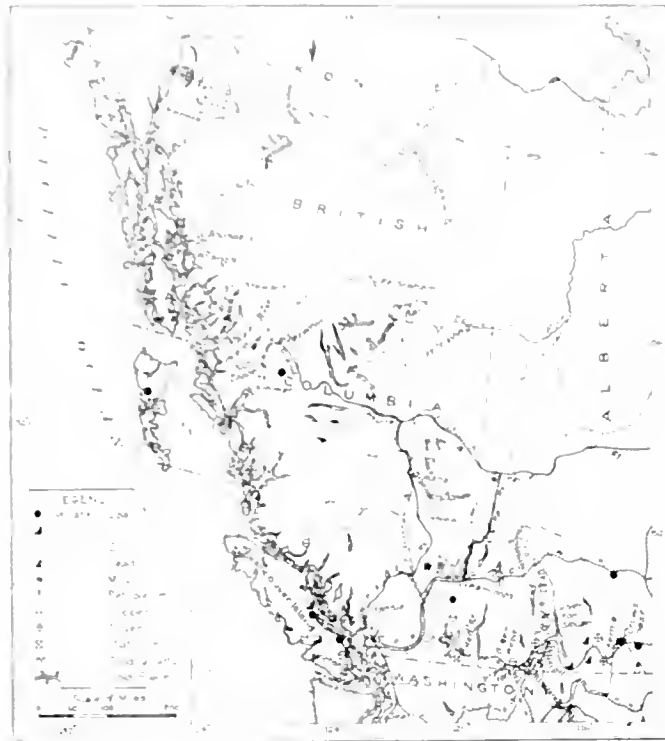

MAP OF BRITISH COLUMBIA.

operation the long-idle mill near Roseberry, Slocan lake, and kept it working on custom zinc-lead ore. Further experiments in flotation, to make a higher saving of zinc, were undertaken at the Standard company's mill at Silverton, Slocan lake. Flotation is being successfully used at the mill of the Silverton Mines, Ltd., on ores from its Hewitt-Lorna Doone mine. A mill of the old Missouri type was constructed and equipped at the Galena Farm mine, also near Silverton, to make both silver-lead and silver-zinc products.

At Trail, facilities for treatment of lead ores were extended and brought up to date. A new lead-sampling mill was built and equipped with modern plant, ore-roasting facilities were increased, a third lead-furnace of large capacity and water-jacketed throughout was constructed, and more improvements were made in the Consolidated company's electrolytic lead-refinery, including the substitution of concrete tanks for wooden ones. Experimental production of electrolytic zinc having proved successful, the erection and equipment of works to have a capacity of 25 to 35 tons of spelter per day was commenced in the autumn, and it is expected this plant will be in operation shortly. No zinc is yet being produced commercially in the province by the French process.

Copper converters of the Great Falls type were put in at Trail, with the requisite blowing-engine and other accessories. The Cottrell system for the electrical precipitation of dust in

furnace gases and smoke was used on a larger scale, two or three new Cottrell plants having been added. At Britannia Beach the Britannia Co. proceeded with the equipment of its new concentrating mill and enlarged Minerals Separation process plant for treatment of copper ore. At Anyox, Observatory Inlet, the Granby Consolidated put in a fourth copper furnace and an agglomerator, and made other changes and additions that increased the efficiency of its methods there.

Late in the year Sir Richard McBride resigned as Minister of Mines and was succeeded by Lorne A. Campbell, of Rossland, general manager for the West Kootenay Power & Light Co. and allied electric power companies, who has for years been active in connection with the supply of power to the larger mines and reduction works at West Kootenay and Boundary district, and also is president of a company mining coal in south-west Alberta.

The issue, in December, by the Geological Survey of Canada, of Chas. W. Drysdale's lengthy memoir on the 'Geology and Ore Deposits of Rossland, B. C.' is noteworthy, it being the result of several years' investigation and inquiry by the author and other well-known geologists.

Mine safety has had increased attention, and Dudley Michell, of the provincial Department of Mines, instructor in first-aid and mine-rescue work, has had the ready co-operation of some of the larger mining companies, notably the Consolidated Mining & Smelting Co., which has organized safety committees at both its Le Roi mine and Trail smelter. It is hoped that the other interior district metal-mining companies will also take a real and practical interest in this beneficent work.

SONORA, CALIFORNIA

LATEST MINE DEVELOPMENTS FROM TUOLUMNE COUNTY.

General repairs and improvements are being made at the Shawmut mine. It is stated that a new orebody of good value has been opened.

A new transformer has been installed at the Atlas mine near Tuttle town. A new company has taken hold of this property under the management of J. Whitney, and expects to be in operation by the first of February.

Lessees at the Boyle and Knox mine at Stent are extracting some good ore, the ore being crushed at the Santa Ysabel mill. The Santa Ysabel mine, under the management of C. E. Shafer, is producing good ore, and the general outlook is encouraging.

The mining claim of the John Yost property near Soulsbyville has been leased by Chas. Saunders and Wm. Luckey; they have uncovered a two-foot vein of high value.

The new addition to the mill at the Dutch-App at Quartz, covering a space of 60 by 100 ft., is completed, and the foundation has been laid for the new tube-mills, elevators, concentrators, and other equipment. The plant will be ready for operation early in February. Activities underground are considerable. From the Dutch shaft, levels are being driven south into the orebodies of the App, and north into the Sweeney, while extensive development is being done in the Dutch. Walter Foster has been awarded a contract to do a great deal of the cross-cutting in the Dutch; the total length of the drifts and cross-cuts will amount to about 5000 ft., on three levels. W. J. Loring is in charge of this property.

The Republican mine at Jacksonville, is doing considerable overhauling at the McDougal claim. The mill has been completely renovated and is ready for crushing. Electric power will be used throughout.

Sinking at the Live Oak mine at Soulsbyville is progressing satisfactorily. Air is now conveyed from the Black Oak mine to operate the hoist, and is used generally about the mine for power. The vein maintains its good quality and width to encourage the operators, Blackburn, Stage, and Macomber, a partnership.

The Black Oak mill is kept busy reducing the usual quantity

of good ore, and the mine is reported to be in excellent condition.

Operations on the Addis, Moore, and Burns property, near Soulsbyville, will soon be commenced. C. W. Hopkins of the Black Oak mine, and Mr. Sweitzer of San Francisco are interested in the development of this property.

The California Gold Mining & Development Co., organized to acquire six unpatented quartz claims in this county and an option to purchase the Chapparel patented quartz mine for \$10,000, has been permitted to issue 34,000 shares to E. Bennett and P. A. Ellis in exchange for the claims, and an option to sell 10,000 shares at par, \$1 per share, to net not less than 80c., the proceeds to be used in development and in meeting the payments, the 34,000 shares to be held in escrow pending the financing of the company.

The Springfield Mining & Development Co. last week started milling high-grade gravel. It is said that the gravel is of such value that the mill is running to capacity, which is several hundred tons per day. The management states that this is the deposit it has been looking for in the past two years. A. L. Horner is manager, and Joe. Cardamatori superintendent.

The shoot of ore that is being stoped in the Experimental mine at Columbia, is 105 ft. long with 550 ft. of backs, and will yield from \$8 to \$15 per ton. Forty feet beyond there is another shoot of the same character, though only about 40 ft. in length. Farther south, about 150 ft. from the face of the 2850 ft. adit, through which the property is worked, is the main shoot, which is 150 ft. long. This orebody, uncovered from the shaft on the surface, is rich, and it was to cut this at depth that the long adit was driven. The intervening shoots were unexpected. The adit was started in 1906, and with the exception of two seasons, has been steadily extended. The two-stamp mill has been discarded, and five modern stamps erected.

An electric pump has been installed at the Rawhide mine, and is doing good work. Water is being lowered at the rate of from 10 to 15 ft. per day, it now being below the 200-ft. level. J. Mocine is in charge.

The Hope mine near Sonora, is working its five-stamp mill on good ore. Last month No. 1 dividend was declared. New machinery has been installed, and the general outlook for the mine is promising.

TORONTO, ONTARIO

FURTHER NICKEL INVESTIGATIONS.—PORCUPINE FIELD.—NIPISSING.

Independently of the work of the Ontario Nickel Commission, which is actively pursuing its investigations as to the feasibility of refining nickel in Canada, the Dominion Government is taking action in the same direction. Experts are now studying the question, and it is not unlikely that some steps will be taken during the present session of Parliament for the establishment of this industry. The question has entered on an entirely different phase to that presented a year ago, when the principal object in view was to prevent Germany from securing a supply of the refined metal from the United States. The main objection then brought forward to the proposition to prohibit the exportation of nickel matte was the fact that the principal market was in the United States, the domestic requirements being limited. With the growth of a heavy demand at high prices for the manufacture of war munitions, the situation is considerably altered, and even if an embargo on matte and ore is considered as too drastic a proposition, the encouragement of nickel refining by similar measures to those which have resulted in the establishment of the zinc and copper-refining industries may be anticipated, provided the report of the Government exports is of a favorable character.

The International Nickel Co. has decided to erect a nickel refinery in Canada. In this respect it is stated that the company wishes to co-operate with the Canadian government in its desire to have some of the nickel ore mined in the Sudbury

district refined in the Dominion. During the last quarter of 1915 the company's earnings were 6.8% on the common stock. After paying the common and preferred dividends the quarter's surplus will be \$733,122. The general balance-sheet at the end of 1915 was highly satisfactory, much better than previously. This is according to the *Boston News Bureau*.

During December the Alexo mine shipped 1283 tons of nickel ore to the Mond plant at Cornistown.

The recent visit of a representative of one of the large English mining firms, largely interested in South African mines, to Porcupine, has given currency to a widespread report that this firm has made an offer of \$25,000,000 to the Canadian Mining & Finance Co. for its Porcupine holdings, including 51% of the Hollinger stock, and the Acme-Millerton and Hollinger Extension properties, which was refused. Whether this statement is correct or not, there is a strong feeling among mining men that Porcupine is likely before long to attract British capital on a large scale, in view of the increasing cost of deep mining on the Rand, compared with the comparatively small outlay and large profits to be made in the Porcupine field. In the earlier days here there were many engineers from British investors, which had little practical result; but it is pointed out that conditions have radically changed, as the value of the field has been proved, and undeveloped properties can now be had at much more reasonable prices than those formerly asked.—The total production of the Dome for 1915 was \$1,468,272 from 317,873 tons, or \$4.56 per ton, compared with \$1,058,629 from 219,609 tons, averaging \$4.99 per ton in 1914. The Hardinge ball and pebble section of the mill will be in operation by March, which with an increase in the cyanide capacity is expected to increase the quantity to over 40,000 tons per month. The main shaft is now down over 600 ft.—The quarterly statement of the McIntyre for the three months ended December 31 shows 26,160 tons milled averaging \$7.39 per ton, with a recovery of \$184,233, or 95.42%. Operating costs were \$4.16 per ton, and working profits \$75,485. No. 4 shaft, now down 600 ft., will be sunk to a greater depth, and No. 5 shaft is down 700 ft. Diamond-drilling from this has cut an orebody at a vertical depth of 750 ft., which is 19 ft. wide, and valued at \$18 per ton. It is expected that the unit of the mill will be ready to operate about the middle of February, making a capacity of 450 tons per day.—At the Schumacher, driving has been started at the 600-ft. level, and ore is being stoped from the upper levels. The mill is treating about 100 tons per day.—The Standard property, adjoining the Dome Lake, has been purchased by the Porcupine Premier company, capitalized at \$1,000,000. No. 1 shaft will be sunk to 500 ft.—The Dome Extension is being unwatered. The vein system exposed just before the mine was closed three years ago will be thoroughly explored, diamond-drilling will be undertaken to cut the Dome veins at depth.

The new plant of the La Belle Kirkland in the Goodfish Lake area, which cost \$20,000, is in operation.—A. M. Scott, J. P. Bickell, and associates, have purchased a claim at Boston creek, where a discovery was made showing rich sulphide ore.

Developments that promise to be important have been made at the Nipissing at Cobalt. A winze sunk on vein 490, below the fourth level of the Meyer vein system, when about 30 ft. down cut a shoot 8 in. wide assaying 7000 oz. per ton. It dipped out of the winze in a short distance. Geological investigations indicate that a fault has lowered the formation about 100 ft., and the winze will be continued down, with the expectation that the vein can be cross-cut at depth.

Ore and concentrate shipments from Cobalt last year totaled 16,156 tons, against 18,221, 20,916, 21,632, 24,922, and 33,977 tons in the previous years respectively. This shows that the district is increasingly becoming more dependent on its own mills than sending the ore and products away for treatment.

Diamond-drilling is shortly to be started by the La Rose company at Cobalt, on ground adjoining the Chambers-Ferland.

THE MINING SUMMARY

The news of the week as told by our special correspondents and compiled from the local press.

ARIZONA

MOHAVE COUNTY

The Times Mining Co. has increased its capital from 1,000,000 to 1,500,000 \$1 shares. A 25-hp. gasoline hoist, 80-hp. gasoline engine and 500-cu. ft. compressor, and drill-sharpener are being installed. Cross-cutting is under way at 150 ft. depth.—The Oatman Big Lode shaft is down 40 ft. A 25-hp. hoist has been ordered. The Times mine will supply air for machine-drills.

At the Big Jim samples taken every five feet across the 46-ft. lode at 400 ft. average \$7.44 per ton. Six feet near the foot-wall assays \$15.

Shafts at the Ivanhoe, Merry Widow, Fessenden, Lazy Boy, Gilt Edge, and Carter mines are down 40, 100, 200, 60, 55, and 250 ft. deep respectively.

At the 300 ft. in the Tom Reed mine a three-foot shoot is reported to assay up to \$1750 per ton.

ARKANSAS

Final figures of the output of the north Arkansas field show that it was 1,226,314 lb. blende, 6,841,325 lb. lump silicate, 7,222,990 lb. milled silicate, and 138,375 lb. lead, valued at a total of \$1,982,790. This is equal to about one week's production of the Missouri-Kansas-Oklahoma region.

DREW COUNTY

Since commencing work six months ago, the Yellow Rose mine at Rush has produced 450 tons of zinc ore worth \$30,000, by pick and shovel work. A large pile of 15% ore is ready for the new mill, soon to be ready. From the dump worth \$30,000 a profit of \$15,000 is expected, \$11,000 for the plant, and \$4000 for treatment.

CALIFORNIA

Oil production in December amounted to 7,397,478 bbl., a small decrease. There were 2 rigs completed, 172 wells drilling, 24 completed, 4 abandoned, and 6196 producing. Stocks are down to 55,977,189 barrels. This large reserve is of con-

siderable importance at present, as the violent storms of January 16 and 27 blew down several hundred derricks in the Bakersfield and Coalinga fields, besides doing an immense amount of other damage.

AMADOR COUNTY

The Retta mine near Plymouth is now called the Amador

Star, according to the superintendent, H. Clark. The shaft is to be sunk at once. Electric motors are being installed.

BUTTE COUNTY

An old prospector named A. Garand found a nugget worth \$1200 at the Red Hill mine near Magalia last week. The old Willard claim there yielded a 54-lb. nugget many years ago.

CALAVERAS COUNTY

Calaveras Copper shareholders met on January 31 to approve of a plan for re-financing, designed to preserve without assessment the equity in the property. This is with a view to showing if earnings may ultimately be developed on the 375,750 outstanding shares. It was proposed to extend at 6% interest debts totaling about \$750,000, provided the company agrees to pay no dividends until all indebtedness is liquidated. Holders of the bonds and of such debentures as may be issued in the extension will be given the right to vote.

The Gravel Deposits Mining Co. of San Francisco is operating a property in the Mokelumne Hill district called the Veith Pelletton placer mine. An old adit is being re-opened, and some machinery will be installed in the spring.

ELDORADO COUNTY

In a cross-cut driven from near the face of the old main cross-cut in the Pre-volcanic gravel mine, 18 miles east of Placerville, at about 1250 ft. in from the portal of the adit and 100 ft. vertical depth from the surface, gravel on bed-rock is yielding \$1 to \$3 per pan. J. H. Zimmerman had leased the mine to a Mr. Alexander of Los Angeles. Owing to snow work has been suspended.

PLUMAS COUNTY

Good progress is reported from the Walker mine near Portola in mill construction, and before long the 100-ton plant will be at work.

SHASTA COUNTY

Along the river on the east side of Redding the El Oro Dredging Co. of Oroville is prospecting with a Keystone drill. The company has an option on 400 acres.

TRINITY COUNTY

In our issue of last week it was stated that the Alta Bert company's property had been sold; this is not so.

When the Crown Reserve company of Cobalt, Ontario, acquired the Globe Consolidated property near Dedrick, the Globe Consolidated Lease Incorporated was organized to oper-



TYPICAL CALIFORNIAN OILFIELD.

ate it. The mill is treating 125 tons of \$9 ore per day. Deeper exploration is showing a good deal of ore.

COLORADO

CHAFFEE COUNTY

At Salida, a plant to treat complex zinc ore from the North Fork Power & Mines Co.'s property is being installed in the Stiver's factory building on Front street, by J. W. Emerson, and will be under the supervision of S. V. V. Zabriskie, formerly with the New Jersey Zinc Co. Ores from other mines will be treated later. A new patented process, claimed to be better than flotation, is to be used.

GILPIN COUNTY

Lessees and tributers in Gilpin county are said to be complaining about the unreasonable rates of the Chamberlain Sampling Co. at Black Hawk; sampling, freight, and treatment are considered to be much too high.

The Pittsburg mine in Russell gulch continues to produce rich ore; recent shipments settled for up to 9.43 oz. gold, 11.5 oz. silver, and 18% copper.

LA PLATA COUNTY

Snow-slides practically buried the town of La Plata on January 29.

OURAY COUNTY

The Mt. Hayden Mining & Milling Co. has been organized to operate the Thistledown Mining & Milling Co.'s property at Mt. Hayden, sold last spring at a sheriff's sale.

The new experimental flotation plant of C. R. Wilfley is in operation at Ouray. It includes crushers, vibrating screens of different mesh, a No. 5 Wilfley table, Minerals Separation flotation machine, and accessories.

SAN JUAN COUNTY

Prospectors along Cement creek last week found a boulder 10-ft. diameter that had been carried down by a snow-slide and had split, showing a wide black streak which proved to be very high-grade tungsten ore. A rush to locate the source of this ore has set in, in spite of danger.

SUMMIT COUNTY

The Tonopah Placers Co., operating three dredges near Breckenridge, reports net earnings of \$90,961 in the quarter ended November 30.

A 50-ton Dorr continuous system cyanide plant is to be erected at the Jessie mine at Gold Run in conjunction with the 40-stamp mill. The partly oxidized gold ores will be tested. The mine also produces some lead and zinc ores.

TELLER COUNTY (CRIPPLE CREEK)

At the Johnson-Mack lease of the Ella W. claim on Tenderfoot hill, a large body of rich ore has been opened in an adit. The daily output is a carload of good ore. This area is considerably active just now, in spite of cold weather.

IDAHO

SHOSHONE COUNTY (COEUR D'ALENE)

(Special Correspondence.)—Regular shipments from the property of the Coeur d'Alene Antimony Mining Co., known locally as the Antimony mine, situated on Pine Creek, about five miles west of Kellogg, are now being made. The present output is one car of concentrate and sorted ore each five or six days, but soon this will be increased to about three carloads of antimony ore per week, containing between 40 and 50% antimony metal. The ore is about as pure a stibnite as can be found, as proved by the fact that the ore has never been penalized for any impurity by the smelters. The ore-shoot, as far as opened up, is over 430 ft. long, and from 1 to 5 ft. wide. Pine Creek, January 25.

Last week the Star Antimony Co. shipped its first carload, 30 tons, of 50% antimony ore from the Brown-Finnell mine on Pine Creek. This was hand sorted and jigged.

It is reported at Wallace that the Bunker Hill & Sullivan smelter will be built at Kellogg. Also that the Chicago, Milwaukee & St. Paul railroad will be extended from Coeur d'Alene into the Wallace district. Another important bearing on the region is the suit of the Washington Water Power Co. v. the Montana Power Co., the plaintiff alleging that the defendant is doing business here in violation of the laws of Idaho. A large number of attorneys and witnesses were called to the trial, which is adjourned for 15 days.

In the Hecla mine the second ore-shoot is now 1200 ft. in depth and 800 ft. long at 900 ft. On the 1600-ft. level it is 2000 ft. long. Ten cents per share, or \$100,000, was distributed recently.

During 1915 the Success Mining Co.'s income was \$1,255,802, profit, \$898,936, and dividends, \$555,000. The surplus on December 31 was \$251,111. The mine is in fine condition. On the 1200-ft. level there is 7 ft. of 25% zinc ore.

From the Golden Chest at Murray 3737 tons of hand-jigged tungsten (scheelite) concentrate was shipped two weeks ago. Some rich ore has been found by A. Rosander on Butte creek.

The Coeur d'Alene region has been visited by severe weather, including much snow, interrupting railway service and mining operations. Snow-slides are reported from several points.

MICHIGAN

HOUGHTON COUNTY (THE COPPER COUNTRY)

(Special Correspondence.)—The Winona is making a small profit at present capacity, but costs are nearly 16c. per lb., and the output is not increasing much. The ore is different to other in the district, and some additional process is necessary to save the fine copper.

Good progress is being made with the new furnace at the Calumet & Hecla's Dollar Bay plant. The absorption of the Tamarack by the C. & H. has apparently been dropped for the present.

Two heads of stamps are under construction at the Ahmeek's mill; by July there should be eight dropping. The ore is yielding 24 lb. metal per ton. The future for many years is good.

At the Hancock 300 men are employed. The first ore to come from No. 7 shaft of the Quincy, under the joint arrangement, went to the Quincy mill last week.

The Seneca is a mine with a promising future. Ore was opened on the Kearsarge lode in 1910. The company owes nearly \$200,000 to the C. & H. The Gratiot owes the C. & H. over \$400,000. It has shallow possibilities on the Kearsarge lode. These two and other properties nearby could be consolidated to advantage.

Ore from the Lake mine is averaging 30 lb. per ton. The output in 1915 was 3,000,000 lb. Work is confined to a few levels, no ore being extracted from below No. 10.

Houghton, January 25.

MONTANA

Severe storms passed over this State last week, considerably hampering mining, transport, and ore-treatment operations.

SILVERBOW COUNTY

The Butte & Superior company's Black Rock shaft is down 2000 ft. Two new three-compartment shafts will be ready for operation by the end of the year. Part of the decision in the Elm Orlu-Butte & Superior suit appears on page 220 of this issue. On January 27 a skip containing five tons of ore fell from the 800 to the 1600-ft. level, doing considerable damage to the Black Rock shaft.

NEVADA

ESMERALDA COUNTY

Final figures of the Goldfield Consolidated for December show that from the treatment of 35,610 tons of ore the profit was \$53,029. Costs were \$4.48 per ton. Development amounted

to 2811 ft. at \$7.37 per foot. In the Red Top-Laguna, 260 ft. level, 700 ft. north of the shaft, 305 S still produced 256 tons of \$113.27 ore. Lasses mined 796 tons worth \$9274. 96 tons was treated locally and the balance shipped to smelter.

MINEIRA COUNTY

Atkins, Kroll & Co's tungsten property, 12 miles from Sodaville, is producing 20 tons of ore daily. This is concentrated at a plant near Luning. Over 40 men are employed.

LINCOLN COUNTY

Wages have been advanced 25c. per day at the Prince Consolidated at Pioche, based on 55-c. lead and 55-c. silver. The daily output is 400 tons.

NYO COUNTY

Topopah mines last week yielded a total of 8390 tons of ore worth \$176,280. The Belmont shipped 116,214 oz. bullion.

The Extension is to enlarge its 10-stamp mill by adding 10 more, a tube mill, thickener, agitator, etc., to bring the monthly total to 10,000 tons.

The report of the Monarch Pittsburg Mining Co. for 1915 shows that 1800 ft. of development was done at a cost of \$9.91 per foot, on the 850-ft. level in rhyolite. A vein was cut early in January, 1916, two feet assaying \$36.68 per ton. Cash on hand amounts to \$1559.

At Manhattan there has been some bad weather, yet important work was commenced recently.

The White Caps shaft is being deepened 100 ft. from 210 ft. The output to this depth is 19,909 tons worth \$381,051, and reserves are placed at 11,285 tons of \$11 ore. J. A. Cole is superintendent.

The Union Amalgamated mill has been overhauled, but heavy snow interferes with hauling ore from the mine to the plant. The assay-office was burned on January 9.

Open-cut mining at the Big Pine has been curtailed by the weather. The ore is of better grade lately. A new type of concave has been designed for crushing the schist ore. The Union mine water shaft caught fire, and after many schemes for putting it out failed chemical extinguishers were successful.

WHITE PINE COUNTY

Mill-men and mechanics at McGill have been given an increase of 35c. per day by the Nevada Consolidated, and 20c. for common labor. This is dependent on 20-c. copper; higher prices mean a further rise. The mines are producing 12,000 tons of ore daily, employing 3000 men in all departments.

TENNESSEE

POIK COUNTY

Following a demand for increased wages the Tennessee Copper Co's mines are closed. The acid-plant is still in operation. According to Utley Wedge, the president, the men made their demands on January 18, and struck the following morning.

UTAH

JUAB COUNTY

Following the rise in wages at the Chief Consolidated, the other companies at Tintic followed suit with a 25c. increase. Over 1300 men will benefit.

So far the shoot at 1000 ft. in the Iron Blossom has been opened for 25 ft. in width, averaging 20% copper. Some ore is being shipped, also silicious lead-silver ore, totaling 150 tons daily.

The Lower Mammoth Mining Co.'s report for 1915 has been issued. Mine development has been encouraging, and a large quantity of low-grade zinc ore has been opened. According to the general manager, J. C. Dick, 150 tons of zinc ore will be shipped per month during 1916. The output of silver-lead, zinc, and copper ore was 377, 1621, and 1113 tons respectively, worth \$54,849. A dividend of \$10,000 was paid, and the balance is \$5578.

SALT LAKE COUNTY

The president of the Alta Consolidated Mining Co., A. O. Jacobson, has issued a statement about last year's work. Adits, raises, and cross-cuts totaled 1150 ft. A shaft was sunk 105 ft., and drifts driven below the adit level on the Iron fissure. A large quantity of low grade ore was developed, which will net a good profit when the new railway is complete. The company is free of debt.

Bad weather has interfered with shipment and reduction of the Utah Copper Co.'s concentrate at the Garfield smelter.

The Utah-Apex company is expected to make a profit of \$70,000 in January, equal to \$1.50 per share per annum. The output is 35,000,000 lb. lead at 3.6c. per lb. cost.

SUMMIT COUNTY

During the week ended January 28 the Park City district shipped 1039 tons of ore. A severe storm visited the place on that day, resulting in general curtailment for the time.

Inwatering the Ontario mine, from 1500 to 1700 ft., is under way. The shaft at this depth has been full since March 1905.

TOOLIE COUNTY

At an altitude of 5600 ft., 18 miles west of Mercur, and half-way between West Tintic and Grantsville, is the O. K. silver mine, where ore was opened at a depth of 60 ft. in November last. This has been followed to 125 ft., the value increasing with depth. Thirty-four tons recently settled at 488 oz. silver, 0.235 oz. gold, and 0.15% copper. More is ready for the smelter.

WASHINGTON

The Knob Hill Mining Co., operating at Republic, paid an indebtedness of about \$13,000 during 1915 and closed the year with cash on hand amounting to \$5746, in addition to about \$2100 due for ore already shipped but not settled for by the smelter, according to reports submitted to the annual shareholders' meeting in Spokane last week. The year's shipments of ore amounted to approximately 3500 tons with a gross value of \$80,000. Smelter returns amounted to \$62,000. The gross value of the 1914 tonnage was about \$75,000. During the year the directors followed the policy of developing new ore reserves and preparing the property to increase shipments at a future time, expending \$7795 on development and \$1500 on improvements.

SPOKANE COUNTY

So far for January, companies in the North-west in which Spokane people are interested, have paid \$628,850 in dividends, or \$377,100 more than in that period of last year.

STEVENS COUNTY

The present rate of shipments of the United Copper mine at Chewelah is 1000 tons of crude ore and 500 tons of concentrate, averaging 4.42% copper and 16 oz. silver and 13.38% and 42 oz., respectively, per month. Profits in January are expected to be over \$25,000.

WISCONSIN

GRANT COUNTY

(Special Correspondence.)—At Platteville the Empire Separators, working here for six years, are being removed. The Wilson mine at Potosi, is making 60% wet concentrate, and new bodies of ore have been opened, enhancing the value of the property. Two local separating-plants restored during the summer of 1915 are working steadily on crude ore. Many drilling outfits are engaged with good results.

At Cuba the National Separating Works is handling 700 to 800 tons of raw ore per week, and shipments of refined ore are from 7 to 10 cars. Strikes with drill were made on the Dall tract, where a few years ago a big dividend payer was operating and suspended, having lost the ore. Three borings, 1000 ft. west of the old Dall mine, show massive formations of zinc ore. Exploration continues.

Platteville, January 20.

LAFAYETTE COUNTY

(Special Correspondence.)—Benton continues to lead the field in production, shipping weekly from 35 to 50 cars zinc products of all grades. The Hird is a new mine developed in 1915, and a complete new 500-ton mill and power-plant is being erected.—Serious complaints are filed by all leading operators in this section of the field against the power service being supplied by H. M. Byllesby & Co. of Chicago, station at Galena, Ill.—The New Jersey Zinc Co. has drilled the Meloy lease and a complete power and milling plant will be supplied at once.

The New Diggings district, little known early in 1915, now bids fair to become the leading producer of this region. A great deal of new work is under way, while production increases.

Benton, January 20.

WYOMING

Among the undeveloped resources of the State of Wyoming, the U. S. Geological Survey reports, are bituminous shale, volcanic ash, graphite, asphaltum, manganese ores, bentonite (a clay), tin, salt, bismuth and, perhaps most important, phosphate rock, on which the future of American agriculture may largely depend. It is estimated that more than 1,250,000 acres in Wyoming are underlain by workable phosphate deposits, a phosphate area greater than that of any other State. Its coal-fields cover about 41,500 sq. miles—two-fifths of the State's area—and contained originally an estimated 670,723,000,000 tons. Of this quantity only 178,000,000 tons, or about one-fortieth of 1%, has been exhausted.

CANADA

BRITISH COLUMBIA

Gold-bullion deposits at the Vancouver assay office in 1915 were 789 more than during the previous year, with an increased value of over \$700,000. Of this British Columbia contributed \$13,000,000, Yukon \$1,150,000, and Alberta, \$2000.

Sixteen mines, including the Centre Star and Le Roi, and several in Washington, sent 8766 tons of ore to the Trail smelter last week. The Lead Queen, in the Windermere region of East Kootenai, 18 miles from Frisco, sent a car of ore to the smelter.

The Spokane, Washington, Mining Men's club is to visit Rossland early in February.

The Sloean Star Mining Co., operating at Sandon, has issued \$100,000 first-mortgage bonds to improve the mine and mill and give the company a reserve. A recent sale of zinc concentrate liquidated all debts. The mine is opening satisfactorily.

MEXICO

SONORA

The great drawback to resumption of mining in this State is that of transport of ore to shipping points on the railroads. Labor is not as plentiful as desired. Burros and mules are in great demand for packing, but the revolution has used up many of these animals.

According to James Malcolmson of the Tigre Mining Co., conditions are normal again at El Tigre. On account of poverty in the Bavispe River towns there is plenty of labor available. There is plenty of pack animals.

NUEVO LEON

At the A. S. & R. smelter at Monterrey five furnaces are in blast.

The annual convention of the AMERICAN CONCRETE INSTITUTE will be held at the Auditorium hotel, Chicago, February 14 to 18. Among the membership of the Institute are included some of the foremost names in the United States of engineers and architects. A large number of papers are to be read.

PERSONAL

SEELEY W. MUDD is taking a holiday in Florida.

C. W. MERRILL and ALBERT BURCH are in New York.

CHARLES E. BACON has gone to south-eastern Alaska.

W. SPENCER HUTCHINSON, of Boston, is at the Palace hotel.

H. C. ANCHOR is at the Dome Extension mine, Porecupine.

C. S. HERZIG has been visiting the Joplin district, Missouri.

JAMES M. HYDE has joined CHARLES BUTTERS in flotation work.

H. S. LEE has moved from Haileybury, Ontario, to Leadville, Colorado.

W. B. DENNIS, of the Black Butte quicksilver mine, is in San Francisco.

J. K. TURNER was in San Francisco on his return from Oatman to Goldfield.

R. E. TREMORREUX, of the North Star Mines, was in San Francisco this week.

EDGAR A. COLLINS has resigned as manager for the Commonwealth Mining Co., at Pearce, Arizona.

L. F. LEBRUN is engineer-in-charge of re-modeling the Jerry Johnson cyanide mill, at Cripple Creek.

HUDSON H. NICHOLSON is returning to Lincoln, Nebraska, from an inspection in Plumas county, California.

CHARLES F. RAND was elected president of the United Engineering Society at the annual meeting on January 27.

FREDERICK BRADSHAW, of the Tonopah Belmont, is at the company's Surf Inlet mine on Princess Royal island, British Columbia.

ROBT. F. WOOD, formerly chemist at the Quincy Smelting Works, Hancock, Michigan, is with the Sandusky Foundry & Machine Co., of Ohio.

J. B. TYRRELL of Toronto, Canada, is sailing for England on the *Baltic* on February 9. His address while in England will be 208 Salisbury House, London, E.C.

DAVID H. LADD, of Houghton, Michigan, lately metallurgist and manager for the Wallaroo Smelting Works of South Australia, is secretary, treasurer, and general manager for the Sandusky Foundry & Machine Co., of Ohio.

J. W. BENNIE, NORMAN CARMICHAEL, and M. H. McLEAN, managers of the Shannon, Arizona, and Detroit copper companies, respectively, have returned to resume charge of the properties, now that the strike in the Clifton-Morenci district, Arizona, is over.

W. T. BURNS has been promoted to be superintendent of electrolytic refineries, and will have charge of the electrolytic copper refinery and the electrolytic zinc plant, which is in course of construction for the Anaconda Copper Mining Co. at Great Falls, Montana. E. E. BROWNSON, formerly chief chemist, has been promoted to be assistant superintendent of the electrolytic copper refinery.

ROBERT W. CONKLIN, New York representative of the Granby Mining & Smelting Co., St. Louis, died January 10, after an illness of ten days. Pneumonia was the cause.

The Mackay School of Mines at Reno has issued a bulletin describing the work and benefits of the State Mining Laboratory. During 1915, 1085 individuals sent in 2058 samples of ores from 172 localities, resulting in 7830 determinations, an increase of 25% over the number of persons and samples in 1914. Since 1895 a total of 6003 people have sent in 11,589 samples from 1835 localities, requiring 44,792 determinations. Instructions are given in the bulletin as to how to send specimens.

The AMERICAN ASSOCIATION OF ENGINEERS of Chicago, has issued the first number of its monthly called 'The Menad.'

THE METAL MARKET

METAL PRICES

San Francisco, February

| | Cents per pound |
|-----------------------------------|-----------------|
| Antimony | 44 |
| Electrolytic copper | 26 |
| Pig lead | 6.35-7.30 |
| Quicksilver per flask | \$290-300 |
| Spelter | 21 |
| Tin | 43 |
| Zinc dust 100-kg zinc-lined cases | 30 |

ORE PRICES

San Francisco, February 2

| | |
|---|---------|
| Antimony downward trend, 50% product, per unit | \$2 |
| Chrome 40% and over, f.o.b. cars California, per ton | 15-18 |
| Magnesite crude, per ton, f.o.b. | 7.50-10 |
| Magnesite, no iron and lime, calcined, per ton | 50 |
| Magnesite, refractory, up to 7% iron, calcined, per ton | 30-40 |
| Manganese 50% metal, 8% silica, per ton, f.o.b. cars, S. F. | 12 |
| Tungsten minimum 65% WO ₃ , per unit for spot | 10-50 |

EASTERN METAL MARKET

(By wire from New York.)

February 3 - Copper is active and strong, lead is firm owing to export demand, zinc is quiet and easier.

SILVER

Below are given the average New York quotations, in cents per ounce, of fine silver.

| Date | Average week ending |
|-------------|---------------------|
| Jan. 27 | 56.75 |
| " 28 | 57.37 |
| " 29 | 57.12 |
| " 30 Sunday | 57.12 |
| Feb. 1 | 56.87 |
| " 2 | 56.87 |

| 1914 | 1915 | 1916 |
|---------|-------|-------|
| Jan. 27 | 48.85 | 56.76 |
| Feb. 1 | 48.45 | 56.87 |
| Mar. 1 | 50.61 | 56.87 |
| Apr. 1 | 50.25 | 56.87 |
| May 1 | 49.87 | 56.87 |
| June 1 | 49.02 | 56.87 |

| 1914 | 1915 | 1916 |
|-------|-------|-------|
| July | 54.90 | 47.52 |
| Aug. | 54.35 | 47.11 |
| Sept. | 53.75 | 48.77 |
| Oct. | 51.12 | 49.49 |
| Nov. | 49.12 | 51.88 |
| Dec. | 49.27 | 55.34 |

A review of silver during 1915 appears on the last page of this issue. It is estimated that there is 2,000,000 oz. of silver at New York and San Francisco. Late last year there was over twice this quantity.

London advises that the Osaka mint, Japan, is to coin 15,000,000 roubles of Russian money in 19, 15, and 50 kopek pieces for the Russian government. This will consume more than 6,000,000 oz. of silver.

Pinley and Abell of London have issued their Annual Circular on silver.

COPPER

Prices of electrolytic in New York, in cents per pound.

| Date | Average week ending |
|-------------|---------------------|
| Jan. 27 | 20.06 |
| " 28 | 21.55 |
| " 29 | 22.85 |
| " 30 Sunday | 23.68 |
| Feb. 1 | 23.70 |
| " 2 | 21.92 |
| " 3 | 25.15 |

| 1914 | 1915 | 1916 |
|---------|-------|-------|
| Jan. 27 | 19.60 | 24.00 |
| Feb. 1 | 18.75 | 24.00 |
| Mar. 1 | 18.75 | 24.00 |
| Apr. 1 | 18.64 | 24.00 |
| May 1 | 18.71 | 24.00 |
| June 1 | 19.77 | 24.00 |

| 1914 | 1915 | 1916 |
|-------|-------|-------|
| July | 13.26 | 9.60 |
| Aug. | 12.94 | 9.27 |
| Sept. | 12.02 | 15.08 |
| Oct. | 11.10 | 17.90 |
| Nov. | 11.75 | 18.88 |
| Dec. | 12.55 | 20.97 |

Exports during the week ended January 15 totaled 27,911,635 lb., valued at \$5,602,866. England took 5,917,753, France 14,716,880, Italy 1,107,444, Sweden 1,336,421, and Switzerland 1,827,568 lb. Imports amounted to 17,241,877 lb., worth \$242,524. No copper is being smelted at Michigan smelters.

It is reported that the plant published 300,000 copper was only a sale of 27,500.

The Wai Ching Mining & Smelting Co. quotes its "W" brand antimony 99.75% at \$1 to 40. January shipment is sold out. February and March at \$2.75 to \$3.50. Market firm.

LEAD

Lead is quoted in cents per pound, New York delivery.

| Date | Average week ending |
|-------------|---------------------|
| Jan. 27 | 6.10 |
| " 28 | 6.10 |
| " 29 | 6.10 |
| " 30 Sunday | 6.10 |
| Feb. 1 | 6.10 |
| " 2 | 6.10 |

| 1914 | 1915 | 1916 |
|---------|------|------|
| Jan. 27 | 4.11 | 3.73 |
| Feb. 1 | 4.02 | 3.83 |
| Mar. 1 | 3.94 | 4.04 |
| Apr. 1 | 3.86 | 4.21 |
| May 1 | 3.90 | 4.24 |
| June 1 | 3.90 | 5.75 |

| 1914 | 1915 | 1916 |
|-------|------|------|
| July | 3.80 | 5.59 |
| Aug. | 3.86 | 4.67 |
| Sept. | 3.82 | 4.62 |
| Oct. | 3.60 | 4.62 |
| Nov. | 3.68 | 5.15 |
| Dec. | 3.80 | 5.34 |

On February 4 the Bunker Hill & Sullivan paid \$81,750.

QUICKSILVER

The primary market for quicksilver is San Francisco, California being the largest producer. The price is fixed in the open market, according to quantity. Prices, in dollars per flask of 75 pounds:

| Date | Week ending |
|--------|-------------|
| Jan. 5 | 150 |
| " 12 | 165 |

| 1914 | 1915 | 1916 |
|---------|-------|-------|
| Jan. 27 | 39.25 | 51.90 |
| Feb. 1 | 39.00 | 60.00 |
| Mar. 1 | 39.00 | 78.00 |
| Apr. 1 | 38.00 | 75.50 |
| May 1 | 39.00 | 75.00 |
| June 1 | 38.60 | 90.00 |

| 1914 | 1915 | 1916 |
|-------|-------|--------|
| July | 37.50 | 95.00 |
| Aug. | 80.00 | 93.75 |
| Sept. | 76.25 | 91.00 |
| Oct. | 53.00 | 92.90 |
| Nov. | 55.00 | 101.50 |
| Dec. | 53.10 | 123.00 |

ZINC

Zinc is quoted as spelter, standard Western brands, New York delivery, in cents per pound.

| Date | Average week ending |
|-------------|---------------------|
| Jan. 27 | 19.00 |
| " 28 | 18.75 |
| " 29 | 18.75 |
| " 30 Sunday | 18.50 |
| Feb. 1 | 18.50 |
| " 2 | 18.50 |

| 1914 | 1915 | 1916 |
|---------|------|-------|
| Jan. 27 | 5.14 | 6.30 |
| Feb. 1 | 5.22 | 9.05 |
| Mar. 1 | 5.12 | 8.40 |
| Apr. 1 | 4.98 | 9.78 |
| May 1 | 4.91 | 17.03 |
| June 1 | 4.84 | 22.20 |

| 1914 | 1915 | 1916 |
|-------|------|-------|
| July | 4.75 | 20.54 |
| Aug. | 4.75 | 14.17 |
| Sept. | 5.16 | 14.14 |
| Oct. | 4.75 | 14.95 |
| Nov. | 5.01 | 17.20 |
| Dec. | 6.40 | 16.75 |

The Butte & Superior has contracted with the U. S. Steel Corporation to supply 6000 tons of concentrate monthly at the latter's plant at Donora, Pennsylvania.

The Lanyon-Starr Smelting Co. is paying its semi-annual dividend of \$3 per preferred share. The plant is at Bartlesville, with 15,000 tons annual capacity.

Zinc ore at Joplin dropped \$8 per ton last week to \$112.50.

TIN

Prices in New York, in cents per pound.

| Date | Average week ending |
|-------------|---------------------|
| Jan. 27 | 31.60 |
| " 28 | 31.60 |
| " 29 | 31.60 |
| " 30 Sunday | 31.60 |
| Feb. 1 | 31.60 |
| " 2 | 31.60 |

| 1914 | 1915 | 1916 |
|---------|-------|-------|
| Jan. 27 | 37.85 | 34.40 |
| Feb. 1 | 39.76 | 37.22 |
| Mar. 1 | 38.10 | 48.76 |
| Apr. 1 | 36.10 | 48.25 |
| May 1 | 33.29 | 39.88 |
| June 1 | 30.72 | 40.26 |

| 1914 | 1915 | 1916 |
|-------|-------|-------|
| July | 31.60 | 37.38 |
| Aug. | 50.20 | 34.37 |
| Sept. | 32.10 | 32.12 |
| Oct. | 30.10 | 33.00 |
| Nov. | 33.51 | 39.50 |
| Dec. | 33.60 | 38.71 |

Tin is quiet at 41.25 cents.

Alaska produced 200 tons of tin oxide in 1915.

The Vulcan Refining Co.'s earnings were about 4% last year; 1916 may be 7%.

ANTIMONY

Despite continued dullness the market is strong at 12.50 to 43c. duty paid, for Chinese and Japanese grades, prompt delivery. Futures are neglected. That Great Britain has taken steps to control antimony, in much the same manner as it regulates the tin trade, has been confirmed, though the restriction is confined to the metal which comes from China or Japan in British vessels.

Eastern Metal Market

New York, January 28.

Interest in copper, lead, and zinc is largely confined to the foreign situation. In all three, domestic buying has to a great extent subsided, but the London quotations are strong, and the demand heavy. With lead, especially, it may be said, "Watch London." Russia and France have been heavy buyers of copper. The price of electrolytic continues to advance at London, and was quoted at £122 on January 27. The railroad freight embargoes that hampered consumers have been partly raised, and some large deliveries have been made, one train for New England delivery consisting of 45 cars of copper. Until the New York quotation exceeded 19c., an active business was done in zinc for domestic delivery, but the galvanizers are not heavy buyers. Business in tin has been confined to futures, consumers having learned to protect themselves. Antimony and aluminum are unchanged.

The prices of steel products continue to advance, and some eastern Pennsylvania plate-makers, where they will take business at all, are asking 3c., mill. In the last quarter of 1915 the earnings of the United States Steel Corporation were \$51,232,788, and the total earnings of the year \$130,351,296. Those in 1914 were \$71,663,615, indicating a gain of about 82%. Russian interests are inquiring for great quantities of metal-working machinery in this market, one representative alone enquiring for 3265 tools. Every branch of industry is active, and prosperity should soon permeate every part of the country, if it has not already done so.

COPPER

The market continues inactive so far as domestic buyers are concerned, and interest is largely centred in conditions abroad, especially at London, where the quotation for electrolytic advanced on January 27 to £122. The trend of the English market is confusing in view of the reported action of the British government in fixing a maximum price of £100. France and Russia have been heavy buyers of the metal, one enquiry from the French government calling for 10,000 tons for delivery throughout the next eight months. Exports in January, including the 27th, total 19,600 tons. The New York quotation for electrolytic touched 25.37½c., cash, on the 24th, for delivery in the next two or three months. Spot metal, of which little seems to be available, was quoted up to 26c., cash, New York, on that day. Lake was nominal at about the same figures. There is some evidence of easiness in quotations, but in the absence of business it is difficult to tell precisely where the market stands. It is certain, however, that the producers still control, and that any considerable show of interest on the part of consumers will quickly send the market higher. The entire trade is inclined to be bullish in sentiment. There is, temporarily at least, a betterment in the railroad-freight congestion, and some of the lines have raised their embargoes. The New York, New Haven & Hartford did so last Sunday night, and the following morning a record-breaking shipment of 45 carloads of refined copper was started from Perth Amboy to supply the needs of consumers in New England, some of whom had been in distress. Many of the rolling-mills have their copper delivered in special shapes instead of in ordinary ingot form, and the inability to ship these shapes almost halted operations in some of the mills. In several directions it is urged that the copper producers resume the publications of production statistics, such as were issued formerly by the Copper Producers' Association. The National Conduit & Cable Co., in its *Copper Gossip*, under date of January 20 says:

"Sales during the last 30 days make up an impressive total, and it is these substantial transactions which have given ap-

parent justification to the hardening movement of prices. There is, however, danger of carrying the upward tendency forward too aggressively. There is no doubt that 1916 will witness redoubled activity at producing centres. If confusion and unsettlement are to be avoided it will be absolutely necessary to give persistent attention to maintaining a healthy equilibrium between supply and demand. Since the former custom of making monthly reports of production and stocks on hand has gone out of fashion, the trade is without this official data upon which some intelligent opinion of the situation might be based. We venture to suggest that the present time is an especially favorable psychological moment for resuming that practice."

ZINC

Until two or three days ago the market was active, both spot and first-half deliveries moving well, but since then the market has become quieter, probably because of the higher prices which developed with the better demand. On January 27 prompt spelter was obtainable at 19c., New York, and 18.75c., St. Louis, but there was little interest shown. Futures were easier also, and on that day the minimum quotations were about 18.25c. for February, 17.75c. for March, and 15.50c. for second-quarter deliveries. It is notable that the galvanizers are buying little spelter, and they are the principal consumers of prime Western. The heavy business in brass-mill grades, which sell at around 21c., has been largely shared by two large producers. According to the trade the producers of prime Western are proceeding on the theory that it is better for them to limit their sales and get high prices, rather than sell several times the quantity and get much lower prices. London interests report that the English galvanizing trade is going from "bad to worse." Exports in January, including the 27th, total 4240 tons, but yet American sellers are reported to be behind in their export shipments.

The base price of sheet-zinc was advanced on January 26 to 24c., f.o.b. mill, carload lots, 8% off for cash.

LEAD

The market is strong at 6.10c., New York, and 6c. to 6.02½c., St. Louis. The foreign demand has been heavy, which is largely accountable for the strong market here. Up to the 21st, when the leading interest advanced its price to 6.10c. (from 5.90c.) the market had been growing easier, but there came a change at London, and the market here followed. Spot lead at London stood at £32 5s. on the 27th. London appears to dominate the lead situation. One reason for the strength abroad, and the great demand for American lead, is that the tight ocean-freight situation stands in the way of getting supplies from Spain and Australia. It is expected that large purchases on foreign account will continue to be made. Exports of this month, including the 27th, total 3355 tons.

TIN

Business has been almost entirely confined to futures, either tin afloat or for shipment from the Far East, as has been the case for some months. In fact the character of tin buying has been greatly changed. The uncertainties of war times has caused practically all consumers to provide for their future requirements as far as they can, and therefore, while the arrivals are of generous size at the present time, almost all of the metal is the property of consumers when it arrives, and there is little left for spot trading. Spot metal was quoted on January 22 at 42c., 26th at 41.87c., and 27th at 41.75c. Arrivals of the month, up to and including the 27th, totaled 4155 tons, and there was afloat 5125 tons.

Silver in 1915

The silver market during 1915 was affected by the exceptional conditions which attach to a state of war. It is therefore remarkable that for the first 10 months, the tenor of prices should have been so even in spite of events, which, in normal circumstances, would have left considerable impression. Throughout that period, the price showed great steadiness and violent fluctuations were practically absent. This is the more worthy of comment when it is remembered that a quotation for forward delivery has not been made since the outbreak of war, because such a quotation forms a steadying factor by affording operators an alternative method of dealing. The demand was by no means the same as in pre-war times. Trade enquiry languished, and the Indian Bazaars for a long period abstained from purchases in London owing to the high rates of insurance and other causes.

An unusual portion of the buying derived from coinage orders on account of the British and foreign mints. As these orders were launched in order to meet urgent requirements for currency, the question of price had little weight, for the profit was ample. On the other hand, sales were almost confined to the United States, Canada, and Mexico, Europe being more a buyer than a seller. The uncertainty as to things financial practically eliminated the speculative element during the period mentioned, as purchases had to be made on a cash basis in the absence of a forward quotation. Bear sales presented difficulty for the same reason. At the beginning of the year, Eastern business, both for the Indian Bazaars and China, figured fairly largely, but the buying on the part of the former was not robust, and fell off as the year advanced.

The scantiness of supplies from Mexico, owing to internal difficulties, prevented the price from easing to any great extent. Threats of submarine interference with merchant shipping, and a falling-off in sales from the United States, owing to rising insurance rates, had the effect of lifting the price to a somewhat higher level in March. Under the stress of competing coinage orders, there was a rise, but the upward movement proved too tempting to China, and selling set-in from that quarter. Throughout April the market was healthy, being supported by the Indian Bazaars and a fair amount of coinage demand. In May shipments from the United States moderated and some Indian speculators bought for a rise. This movement, however, proved short-lived and unprofitable, and prices acquired a sagging tendency; the limited extent of Continental and other demand did not provide the stimulus of competition, while China was a frequent seller. A downward course was pursued until the lowest price of the year, was reached on July 29, 46.87 cents.

A contributory cause to the weakness about this period was anxiety felt as to the course of the monsoon in India, while Mexico was able occasionally to export silver which had to be disposed of on a somewhat unwilling market. On August 9 the United States Treasury commenced to make purchases and continued to buy with some freedom, until the price rose to a higher level. The rise was assisted by the exchange with America moving unfavorably for sellers of silver from that country.

As autumn set in the French coinage demand became insistent, and an important factor in the price. Almost from the beginning of the War complaints were made from all parts of France, including the capital itself, that the amount of 2-franc, 1-franc, and 5-centime coins in circulation was insufficient for commercial transactions. Toward the end of August a mint was established at Castel-Sarrasin.

*Abstract from the 'Annual Bullion Letter' of Samuel Montagu & Co., London.

The result of the purchase of between four and five million ounces for the United States Mint, before alluded to, and the frequent demand for other mints, was to raise the price by the end of September, notwithstanding that the Indian Bazaars abstained almost altogether from operating in this market, and China reduced its holding considerably on this side of the water. In October and succeeding months the almost continual pressure on account of English coinage imparted a very steady tone, while a certain scarcity of supplies became manifest, entailing a gradual advance in the price.

In the middle of November a careful investigation of the stock in London revealed that previous estimates had been placed too high. The ascertained total—only £750,000 (\$3,600,000) in all—proved a great surprise to the East, and the Indian Bazaars, who had been inactive for many months, bought actively, and Chinese speculators were caught unawares. Buying for the usual coinage orders continued alongside the new competition, and the market got lively.

Within seven working days, November 20 to 27, the price jumped considerably. At these favorable rates the London stock was reduced further by sales on account of China, and the price became more effective as supplies became less. The rise was accompanied by a certain amount of speculative purchases by outside operators.

After the first week of December the market became somewhat depressed owing to China sales, and the price fell away. The English Mint bought largely during a large part of the year, and acquired nearly 28,000,000 ounces.

Apparent stocks of silver at the close of 1915 as closely as can be ascertained, together with the corresponding figures for the three preceding years are shown below:

| | 1915. | 1914. | 1913. | 1912. |
|--------------------|-----------|------------|------------|------------|
| Shanghai | 720,000 | 500,000 | 2,660,000 | 1,700,000 |
| Bombay | 6,900,000 | 5,000,000 | 1,320,000 | 12,000,000 |
| At sea | 3,125,000 | 1,500,000 | 2,000,000 | 5,700,000 |
| London | 6,800,000 | 11,000,000 | 15,800,000 | 15,000,000 |

Total, in oz. . . 17,545,000 18,000,000 21,780,000 34,400,000

Sycee (60-oz. shoe-shaped bars) at Shanghai for the four periods were as follows:

| | Ounces. |
|----------------|------------|
| 1915 | 62,100,000 |
| 1914 | 68,000,000 |
| 1913 | 50,300,000 |
| 1912 | 22,500,000 |

Imports and exports of bar silver at London were as follows:

| Imports. | Ounces. | Exports. | Ounces. |
|---------------------------------|------------|---------------------------------|------------|
| U. S. and Mexico | 50,062,000 | British India | 36,300,000 |
| Canada | 11,681,000 | France | 10,200,000 |
| Spain and colonies | 494,000 | Holland and colonies | 6,050,000 |
| Australia | 475,000 | Russia | 1,525,000 |
| Other American states | 270,000 | Sweden | 1,200,000 |
| Egypt | 238,000 | Portugal and colonies | 325,000 |
| Other countries | 129,000 | Denmark | 300,000 |
| Total | 93,349,000 | Other countries | 1,725,000 |

Total 60,625,000

The future of silver is very difficult to foresee owing to unprecedented existing circumstances, and that may arise. There is no reason to think that the addition to silver coinage has been excessive, so much has gold been diverted from its ordinary functions.



EDITORIAL



T. A. RICKARD, *Editor*

COPPER shares are not nearly as high now as they were in 1907, but after the boom of that year came a collapse that proved disastrous to many speculators. They don't ring a bell on the Stock Exchange when the rise stops.

TONOPAH mine-owners think they ought to get 60 cents per ounce for their silver, to compensate for a price of 23 cents per pound on sheet-zinc. The War is playing strange tricks with metals and chemicals. What the miner gains in one direction, he loses in the other, like higher wages and increased cost of living.

DESTRUCTIVE use of alcohol in the War has caused a rise in the price of that chemical. To some of our readers the lethal use of alcohol will seem most appropriate; for example, to those who have written protesting against some recent remarks made by Mr. P. B. McDonald on the subject of prohibition. In this matter, as in others, use and abuse are in constant contrast. One man's food is another's poison, just as alcohol can be used to feed the burner of a Bunsen or blow the bomb of a Buelow.

FLOTATION is to be one of the principal topics of discussion at the forthcoming annual meeting of the Canadian Mining Institute, which is convened for March 1, 2, and 3. Mr. E. P. Mathewson is to read a paper on the frothing process as used at Anaconda and Mr. H. E. Wood is to describe the concentration of Canadian molybdenite ores by his method of film-suspension. Mr. H. W. DuBois is down for a paper on 'The Flotation of Boromite,' and Mr. T. A. Rickard is expected to contribute a general paper on 'The Flotation Process.' Incidentally, we note with pleasure that Mr. Arthur A. Cole has been nominated for the presidency of this Institute.

SAFETY in mines is a subject to which we are always willing to give space. In this issue we publish an interesting letter from Mr. Edwin Higgins, mining engineer to the Industrial Accident Commission, in which he bespeaks the friendly co-operation of operators and managers of mines in California. As to that, we feel assured that there will be no lack of willingness to give a helping hand, for the members of the Commission have shown notable good sense and sagacity in their treatment of the problem so far as they have proceeded. Mr. Higgins makes an excellent point in emphasizing the need of co-operation by the miners themselves. You cannot save either the life or health of miners who proceed to expose both recklessly. We commend the matter to the friendly

attention of the superintendents, foremen, and shift-bosses in the mines of California.

WE note that the February bulletin of the American Institute of Mining Engineers contains two papers that are copyrighted by their authors. Neither of them are we anxious to re-publish in this periodical. The matter is bigger than that. Surely the acceptance of a paper under such conditions is a new departure? It used to be the custom of the Institute not only to permit re-publication, but to encourage it. We remember that articles have been reproduced in monthly technical magazines with the scantiest acknowledgment, and yet the distinguished editor who is now Secretary Emeritus used to raise no objection. This copyrighting of papers by contributors to the Transactions smacks too much of plain commercialism and accentuates unduly an apparent tendency of the Institute's policy. First came the advertising annex, then the publication of sundry obvious write-ups by machinery manufacturers, and now this irruption of an author's copyright on top of the copyright regularly obtained by the Institute itself for its bulletins as a whole.

PRICES for quicksilver exhibit what may be called a mercurial temperament. From \$139 at the end of December the quotation has risen to \$300 per flask. Part of this is, we believe, fictitious, but \$275 has been paid and is being paid for quicksilver in San Francisco. The price in London is about \$150, which is a discrepancy explained by differences of time and transport. In regard to the increased quotation, we believe it to be due largely to the demand for the fulminate of mercury, which is required for the manufacture of caps and detonators in shells and cartridges. Even in normal times nearly one-third, say, 5000 flasks of mercury, goes to the manufacturers of the blasting-caps used in mining and quarrying. Another use is in floating mines, to establish an electric contact when the mine leans to one side, as when struck by a vessel. Some of the material is required for electric appliances, but the use with which the miner chiefly associates quicksilver, namely, amalgamation, has decreased greatly, in consequence of the introduction of other processes and the greater economy in the use of quicksilver in such amalgamation as survives. Nowadays only 85,000 to 87,000 pounds, say, 1200 flasks, is diverted to this purpose. For silvering mirrors it is usual now to employ the nitrates of silver in preference to mercury. An intensified consumption of the bi-chloride of mercury as an antiseptic is another consequence of the War. We hope to ascer-

tain details concerning the present demand, which, as yet, has battered the manufacturer and the mill man more than it has benefited the mining of metal.

IN our last issue we publish a review of the silver market in 1915. Last year, as regards silver, was characterized by an increased demand of the metal for coinage purposes, by reason of the withdrawal of gold coin from circulation. In England the 10 shilling note was expected to replace the half-sovereign, but in practice silver currency proved more attractive. It is estimated that \$15,000,000 worth of silver was minted in London for coinage, the amount actually issued representing \$37,154,665, an increase of \$6,537,800. What happened in London was repeated in the capitals of the other principal belligerents, notably France and Russia. The highest price for silver in 1915 was one cent below the best quotation in 1914, while the bottom quotation was a fraction above that of 1914, but lower than the minimum in any other year since 1908. It is anticipated by authorities that the price will not decline in 1916; the demand is likely to increase, while the output of metal in Canada and the United States will remain steady. A general resumption of mining in Mexico would depress the price, but not until production from that country had grown to its former proportions. Europe will require more silver for coinage and the Orient will become a purchaser. On the whole, the outlook for the silver miner is good.

OUR London correspondent referred last week to the recent annual meeting of the Minerals Separation company and quoted some interesting statements made by the chairman, Mr. John Ballot, who said, among other things, that 4,500,000 tons of ore was being treated under the Minerals Separation patents in 1915, and that early in 1916 the total tonnage would be increased to 13,000,000. This is a modest estimate; indeed it perplexes us, for the tonnage treated at the present time by Minerals Separation licensees in the United States alone is fully double the maximum figure given by Mr. Ballot. At the end of 1915 the Anaconda was treating 12,000 tons daily and the Inspiration 8000 tons; thus these two companies alone account for 7,200,000 tons per annum. The Inspiration has increased to 10,000 tons capacity and will soon augment its flotation tonnage to 15,000; the Anaconda in a few months will be treating 14,400 tons daily; so that these two licensees of Minerals Separation will be treating fully 10,000,000 tons per annum. A big tonnage—about 7000—is being treated in the lead and zinc regions of Missouri, partly under M. S. benediction, besides which there are fairly large flotation plants distributed over Arizona, California, Colorado, New Mexico, and the Coeur d'Alene region in Idaho. The two zinc mines at Butte—the Elm Orlu and Butte & Superior—are treating 2300 tons per diem between them. The Arizona Copper is treating 700 tons, to be increased forthwith to 3000. The Humboldt treats 600 tons per day, the Miami about 4000 tons, and the Jackling group of copper companies about 20,000 tons. In-

deed those outside the pale of Minerals Separation, and regarded by that company as infringing its patents, are treating fully 25,000 tons per day. Altogether we estimate that at the end of 1915 about 50,000 tons was being treated per day by flotation in the United States alone, a half of this being done by licensees of Minerals Separation. By the middle of the current year the tonnage treated will be 75,000 tons daily, equivalent to 27,000,000 tons, of which more than half will be tributary to Minerals Separation. Thus our last estimate would appear to approach that of Mr. Ballot, but it does not, because he includes operations all over the world, notably Australia, Canada, and Chile, while we confine our estimate to the United States alone.

Changing the Mining Law

Location of mining claims is the subject of a bill, introduced by Senator Smoot, whereby locators are given "the exclusive right of possession and enjoyment of all the surface included within the lines of their locations and of such veins, lodes, ledges, and deposits of mineral or minerals in place as lie within the block of ground bounded by vertical planes passing through such surface lines, and no such locator, his heirs or assigns, shall have the right under such location to follow any vein, lode, ledge, or other deposit outside of the limits of such claim."

This bill, S. 3762, has been read twice in the Senate and referred to the Committee on Public Lands. If passed, of course, it withdraws the extra-lateral right from all future locations. But it looks like a hasty bit of legislation, for it leaves the size and shape of locations the same as before, namely, 600 by 1500 feet. This is putting new wine into old bottles. Obviously, if vertical boundaries are to be the rule, the locator should be able to take as much or as little of his area on the dip as geologic conditions require. Since the present claim represents 900,000 square feet, why should not the new claim be 1,000,000 square feet, that is, 1000 feet square? Whether the locator should be able to vary the proportion while not exceeding the superficies is another interesting point. This bill of the Senator from Utah warrants the apprehension of the mining public. It seems to anticipate and prejudice the work of the commission that Congress has been asked to appoint with a view to a systematic revision of the mining law. The bill creating the commission has passed the Senate, but, we understand that it is likely to meet unfriendly treatment in the House; although it is an administration measure, and much desired by the Department of the Interior, it is by no means certain to pass. If it does not, and this bill of Senator Smoot should survive, the mining law will remain an excavated anachronism. If vertical side-lines are to supersede the extra-lateral right, then the pre-requisite of discovery should be abolished. That has not met with as much condemnation as the apex idea, but it is equally unscientific. If discovery must continue to be made from the surface, the practical result

might be to withdraw from mining that part of the vein in depth which is beyond the vertical planes of the man who has the top of it. Thus confusion will be worse confounded. The subject is much too complex for piecemeal legislation and we hope therefore that Senator Smoot's activity will be restrained pending the passage of the bill creating the commission, the members of which will be fitted to attack the whole subject in a scientific manner, and with a sincerity of purpose likely to command the confidence of the mining public.

Checking Fraud

Our compliments to the Commissioner of Corporations! In California, in Arizona, and in other States the passing of laws to check fraudulent promotion, by restrictions upon the grant of a charter to companies newly organized, is operating beneficially in protecting mining from many of the performances that injure its good name. We note that the other day Mr. H. L. Carnahan, the Commissioner of Corporations in this State, refused to pass the incorporation of a mining enterprise in which it was clear that the promoters were offering a large block of shares in a venture to which they themselves had contributed very little of their own money. The promoters of a company wanted to sell 20,000 shares at 75 cents per share; but they themselves had taken 125,000 shares in return for an investment of \$13,200, and had declined to deposit their stock in escrow pending the financing of the company. The Commissioner informed them that "if the enterprise is sufficiently sound or affords such speculative inducements as to justify the sale of shares to the public, there should not be such reluctance on the part of the promoters to share the risk with the investors whom they ask to pay in cash more than one-half the total investment for less than one-seventh of the property and profits. Neither should they hesitate to give a reasonable assurance that it is not their purpose to unload their private holdings, either in competition with the company itself or to purchasers who may assume that they are securing treasury stock." This is sound doctrine. In another case, Mr. Carnahan laid it down as a rule that henceforth all reading matter issued by a stock-selling corporation must be submitted to him prior to publication. This will hinder misrepresentation of facts for the purpose of beguilement. In the case last cited, the promoters had published a display advertisement clearly misrepresenting the condition of the company and the character of its property. The Commissioner threatened to revoke the permit previously granted to the promoters unless they published a display advertisement in the same newspaper correcting the misstatements and advising the public to disregard them. This was done, the misdemeanor being attributed to "the enthusiasm of our advertising writer." In these matters the Commissioner is enforcing the provisions of the Investment Companies Act and the Blue Sky Law. So far as we know, the interference with the business of promotion has, as

yet, only proved irksome to the organizers of illegitimate enterprise. In the hands of a fair-minded official the operation of the law will subserve the best interests of mining, for it should be the aim to render wrong dealings difficult and right dealings easy. Legitimate mining suffers continually by the diversion of capital from modest and reasonable ventures to impudent and impossible schemes. All business that is not mutually profitable is bad business.

Opportunities in Siberia

One of the consequences of the War has been an intensified study of geography, a subject in which our people are deficient, chiefly because the American continent hitherto has afforded more than enough scope for the exercise of intelligent enmity. However, there is a geography that is parochial in its limitation and there is one that is equatorial and inter-polar in its amplitude. With the blockading of sundry trade-routes, and the diversion of commerce resulting therefrom, there has arisen a lively interest in regions outside our common ken, leading to intelligent inquiry into the characteristics and products of localities that until recently were not much more than names on maps or spots at which the globe-trotter sampled hotels. To those who live on this coast, particularly to the dwellers beside the Golden Gate, it is natural to look westward and to anticipate the possibility of improving the trade relations already existing with the opposite shore of Asia. To us, therefore, Vladivostok is more than a name, it is the portal to a continental area rich in resources; to a mining region made known to us during recent years by the professional travels of engineers educated in the universities of this State. We sense the possibilities of a larger business between our manufactories and the gold, copper, and zinc-lead mines of the Altai, the Bodaibo, and the Ural regions. Most opportunely, therefore, we are enabled to give our readers a graphic description of industrial opportunities in Siberia by a mining engineer requiring no introduction. Mr. Chester W. Purington is as well known at Boston as in Alaska, at Denver as in California. He writes frankly and freely on a subject concerning which his professional work in Siberia permits him to speak with assurance. We desire to second his appeal to the American manufacturer. Many of our people still retain the impression left by lurid melodramas of the 'Michael Strogoff' type, wherein Siberia is depicted as a land of perpetual snow and ice, populated chiefly by convicts, police, and wolves, where the knout rather than the alarm-clock spurs the laggard to productive activity. Mr. Purington supplies the corrective to this nightmare. He gives a picture of a genial land, rich in agricultural and mineral resources, a region of big perspective but not lacking an attractive foreground. As yet the products of Siberia are those of the soil, not of the factory; it is a country where hides are plentiful and shoes scarce, where furry animals abound but fur-coats are few. It is a country of unful-

tillment, beckoning for help across the Pacific to the enterprising among us. That the invitation should have been disregarded so long needs no roundabout explanation; our readers know that nothing but the spur of necessity, the inability to win enough dollars at home, will cause the average American to seek a foreign market or to go abroad to create one. His own country has afforded ample opportunity heretofore. But now the perturbation of War and the sundering of old lines of business has caused him to stand up and look beyond the immediate horizon. He hears voices from afar, and gives heed to them. Quite recently we have had several visitors coming to San Francisco from Petrograd to purchase mining machinery and supplies. Some of these have represented big mining companies in Siberia. The signs of new business are gratifying, but it has also been made evident how much is to be learned on both sides before such business can be expedited and rendered mutually satisfactory. One of the first blocks of stumbling is the question of credit. As in his dealings with South America, so in his business with Russia, the American manufacturer must learn to grant credits. The Russian is not accustomed to cash payments. Of course, the American can insist on his own way of doing things, and close the door, but we are assuming a real desire to transact business with a solvent customer. In this case, as in South America, the first step is the establishment of banking relations, if not branch-banks, in Russia, followed by the acquirement of some knowledge concerning affairs in that country. For a representative of the Lenskole, for instance, to have to explain to an American manufacturer of machinery where and what his mines are is as absurd as for a Japanese to have to tell a Californian merchant what the Mitsu Bishi is. Another error is that of filling orders in accordance with the ideas of the manufacturer, not to please the foreign customer, particularly as regards the handling of shipments. For instance, an order was placed with a hardware jobber for some thousands of bolts, of assorted sizes, for shipment to Korea. The instructions specified that all goods were to be packed in cases made of $1\frac{1}{2}$ -inch lumber, banded with heavy strap-iron, endwise and lengthwise. The cases, in addition to having the usual mark, were to be striped with red paint, on the ends and on all four sides. When the order was sent to the shipping department, everybody had a good laugh at the 'foolishness' of the instructions. They had never shipped bolts that way before, so why should they begin now? Consequently the bolts were tied with bale-rope in bundles, not even wired; ordinary tags were attached and the shipment was started on its long journey. In the course of a month or two the hardware company received a letter from the purchasers informing it politely that in future they would place their orders elsewhere. Thus an account worth \$50,000 per annum was lost. And this is what happened to the shipment: the loosely tied bundles of bolts were first chucked into the hold of a Pacific Mail steamer alongside the dock in San Francisco. They were discharged at Kobe and

trans-shipped to Chinampo. From that point they were sent up the river in native boats, again discharged, finally reaching their destination in ox-carts. The fate of those bundles of bolts can be guessed; the entire lot was distributed along the trail of the setting sun. The object of the heavy cases and the strong bands is obvious. The red stripes were meant to enable the water-front coolies to pick out the freight readily, for the natives do not read English, much less the cryptic marks adorning shipping-cases. It is just as important for goods to arrive in good condition as it is for them to leave in that condition. We have recited this case in some detail in order to emphasize a mistake commonly made. To those who have no desire for foreign trade, it furnishes a method for ending such unnecessary extension of business, but to those on the look-out for new markets the tale bears a moral not to be disregarded. In Mexico they like green, red, and yellow paints on shipments; in Siberia they prefer other colors. Let them have what they want. Also credit. Also such sympathy and understanding as comes from better acquaintance. The manufacturers on this coast, if prepared to open trade with the Siberian mining companies, need go to no great trouble or expense to obtain the necessary preliminary information. Among the managers of mines and superintendents of smelters in Siberia are several of our own countrymen; most of these come to San Francisco periodically; it is for the manufacturer to make proper use of the opportunity to obtain hints and ideas directly applicable to the conduct of his business, if he desires any, with the Russian mining companies. In his article Mr. Purinton makes a number of sensible suggestions. In a recent paper issued by the Federal Trade Commission we note the recommendation that manufacturers co-operate in taking the initial steps intended to develop trade with any particular region, as is done by the cartels in Germany and the comptoirs in France. Such co-operation will diminish the selling cost. That is why the so-called German rings have obtained so large a hold upon Oriental business. Such an organization facilitates scientific study and the assiduous cultivation of commercial relations, besides the establishment of complete banking connections, prepared to finance local enterprise and so win a strong position in the foreign community. The Japanese have done much the same thing in Korea and in China. We do not see why a number of manufacturers of mining machinery and supplies, each covering a separate branch of the business, should not co-operate to this end and be prepared either to meet the buyer from Russia or send their agents to Russia, and make all the banking arrangements likely to facilitate quick and safe dealings. Having some knowledge of Siberia ourselves, we can lay stress on the attractiveness of the opportunity offered to our people on this coast to develop business opportunities and professional openings in that enormous country, rich with a great diversity of mineral products, and affording a scenery and a climate that reminds one of the plains of Dakota, the valleys of Oregon, and the parks of Colorado.



DISCUSSION

Our readers are invited to use this department for the discussion of technical and other matters pertaining to mining and metallurgy. The Editor welcomes the expression of views contrary to his own, believing that careful criticism is more valuable than casual compliment.

Extra-Lateral Right

The Editor:

Sir—The article on this subject in your issue of December 18 agrees in general with opinions that I have stated when asked about the rights in specific cases, but there are a couple of questions relating to the cases

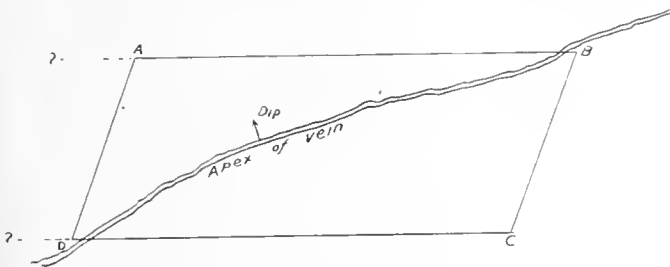

FIG. 5.

given which either you or the author may be willing to answer.

A. Where the vein cuts both side-lines, are there any limits to the application of the rule that the original side-lines become the end-lines that limit the extra-lateral

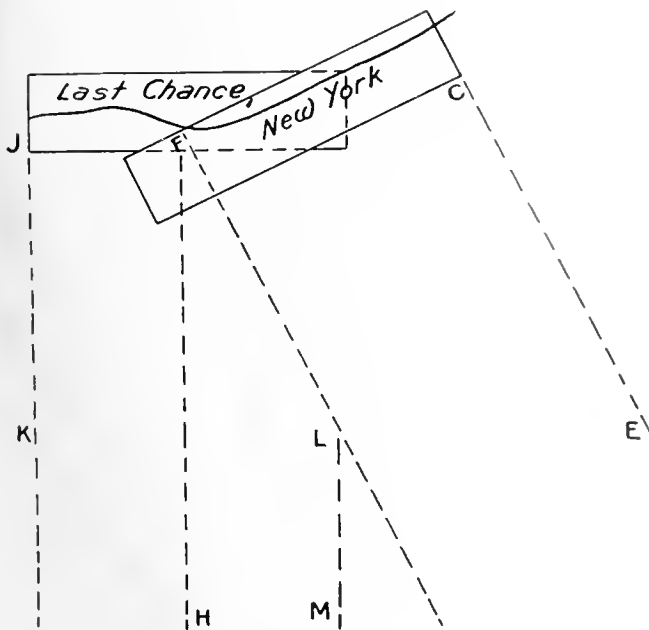

FIG. 6.

rights? Suppose in Fig. 5, the vein crossed line AB near B and the line DC near D and dipped north, that is, parallel to the line BC; then if the rule held, the

extra-lateral rights would be nearly on the strike and also the width of the claim might exceed the maximum of 600 ft. provided by the U. S. law.

B. Where there is a conflict between two claims, the rule given by Lindley in the next to the last paragraph seems reasonable. If Fig. 6 is drawn with the boundary lines extended, as per sketch herewith, in accordance with the rule given, there is a triangle *MLG* on the vein, with its apex *L* far underground which has no owner. How can ownership be acquired to this piece? My idea is that, additional claims would have to be located along the outcrop of the vein adjoining the Last Chance with their end-lines parallel to the line *LM*; these might have no surface rights and their extra-lateral rights would not commence until the vein had passed beyond the rights of the New York claim.

E. B. DURHAM.

Berkeley, January 26.

A distinguished lawyer replies, on our behalf, as follows:

Replying to *Case A* propounded by your correspondent: the courts have not as yet placed any limitation on the application of the side-end line doctrine illustrated in Fig. 5 of the article contained in the issue of December 18, 1915. The enclosed diagram illustrates the hypothetical case suggested by your correspondent. The courts have not as yet been required to pass on an extreme situation of this sort. It is conceded that it would place a severe test on the side-end line doctrine; in fact, there are many who believe that the King-Amy Silver-smith case announcing this doctrine was an unwarranted piece of judicial legislation, placing upon the Mining Act an interpretation which certainly was not contemplated by its framers.

It has been suggested* that "Where the vein crosses the location in such a way as to cut the side-lines at an angle of less than 45 degrees, the regular end-lines remain the end-lines."

There is no authority, however, for placing such an arbitrary limitation upon the side-end line doctrine.

Case B. While the junior claimant might exercise rights up to the plane *LM*, according to the so-called 'stemwinder doctrine,' there is good authority to the contrary, which would limit the extra-lateral right of the junior claim to the plane *FH*. However, for the purpose of answering the query of your correspondent, it is

*John M. Zane, 'A Problem in Mining Law,' 16 Harvard Law Review, page 94. See Costigan on Mining Law, page 424.

immaterial whether the extra lateral boundary plane of the junior claim be the plane FH or LM . The ownership of the underground wedge of vein LMG or HFG —whichever interpretation of the junior claim's extra-lateral rights be correct—cannot be attached to any free apex, and it would be unavailing to locate additional claims on the outcrop, for the courts have never gone so far as to award an extra lateral right to a claim that did not own at least some length of free apex. It has been suggested that locations made covering the edges of the wedge LMG might be considered as including a 'theoretical' apex or 'conventional' apex, but the courts have been disinclined to grant extra-lateral rights based on such constructed apices, and the suggestion has not met with favor. The courts have, however, many times held that this wedge would fall by gravity to the overlying surface owner, who would, according to well-known principles of law, own all mineral vertically beneath his surface, which is not included within a valid extra-lateral right asserted by an owner of a portion of the apex.

Prohibition in the West

The Editor:

Sir—The question of prohibition has been an extensive one, discussed for two or three generations, and it seems to me that Mr. McDonald's attempt to summarize his ideas upon it is much like teaching a system of theology at a sitting, learning French in twelve easy lessons, or telling us all about cyaniding in a column article. Probably, however, his intention rather was to draw out a wise discussion than to give a balanced idea of the merits or demerits of this important matter.

We have heard of the imperfect application of prohibition laws in some places, the better observance of them in others; but at least these laws, imperfect as they are, are better than no attempt at all, and, as experience indicates, conditions improve when such laws back up a healthy public opinion. One may always have advocates of the continuance of our most deplorable conditions. That the influence of the saloon is pernicious, in spite of its being the "poor man's club" will be conceded by any fair-minded observer when he reflects upon its ruin of manhood and the distress brought upon the innocent.

Mr. McDonald's simile regarding the eating of pancakes or red pepper is hardly convincing, since Fletcher will tell him that the first are harmless if not gobbled down, and our Mexican neighbors appreciate the second. I agree with him that there is a tendency to exaggerate various social reforms, and to set them ahead of the eternal realities, but in order to carry out reforms, the leaders must have enthusiasm, and so will exaggerate that with which they are most deeply impressed. As respects individual liberty, has not Mr. McDonald found out that in a social community, even in the United States, we are all circumscribed, and are not altogether free, that we have mutual obligations which tie us? Be not therefore discouraged; no doubt nation-wide prohibition

may work effective reforms, just as it already has done in Russia.

Salt Lake City, January 29,

L. S. AUSTIN.

The Editor:

Sir—Mr. McDonald's letter concerning prohibition has interested me considerably, although I think that to advocate moderation in the use of temperance shows an excess of caution. His experience with 'squirrel-whiskey' seems to me to have been unusually unfortunate. Personally I have always been able to get just as good whiskey in a 'dry' town as in a 'wet' one.

Generally speaking, communities have been voted dry, not because the majority of the citizens disapproved of drinking in itself, but because the saloons have thus far been either unable or unwilling to free themselves from association with 'tin-horn' gamblers and other social parasites. In addition, many voters have come to resent the domineering attitude assumed by the saloon element in the political affairs of most license communities. In fact, as a method of dealing with the liquor problem, the saloon has been a flat failure, morally and economically. It is doubtful whether there is any general solution of the problem that can be applied to all cases. Each community, or collection of communities must find for itself what is the best solution for its particular local conditions. Meanwhile, I notice that Mr. McDonald has chosen to reside in the largest dry town in California, and the only one of any size near San Francisco.

A. T. PARSONS.

San Francisco, February 2.

Safety in Mining

The Editor:

Sir—Copies of 'Mine Safety Rules,' adopted by the Industrial Accident Commission of the State of California, have been mailed recently to Californian mine operators. Included with these rules were sufficient copies of 'Miscellaneous Rules for Underground Men' to supply those employed underground.

Mr. H. M. Wolfelin, the former mining engineer of the Commission, spent about two years investigating the mines in this State and laying the foundation for the Mine Safety Rules through co-operation with the U. S. Bureau of Mines, the California Metal Producers' Association, mine operators, miners, and others prominent in the mining industry. On January 1, Mr. Wolfelin, who had been working in co-operation with the Federal Government and the State of California, was promoted to the position of Mine Safety Engineer of the U. S. Bureau of Mines, with headquarters at Pittsburg. At that time, I was assigned to the California co-operative work under the title of Chief Mine Inspector.

As to the duties of the Chief Mine Inspector, and the method of performing those duties, I am in hearty accord with the policy established by the California Industrial Accident Commission, namely, that every effort should be made to lessen the dangers connected with all

classes of mining work, and that no pains should be spared in lending assistance to mine operators in the carrying out of the Mine Safety Rules. It is believed that an appreciable reduction in the hazards of mining in California can be brought about by equitable administration of the rules, and a continuation of the co-operation of operators and miners, which has already laid the foundation for effective safety-work.

There has been collected in the office of the inspector a vast number of data referring to safety methods and devices. This is being classified and filed, and will be augmented from many and varied sources. These data include many suggestions, with working sketches, for the cheap and efficient construction of safety-devices for all branches of work in and about the mines. It is proposed to send out, at intervals, to the operators in this State, the most interesting and valuable of these suggestions in bulletin form.

It is my belief that the equipment of mines with safety-devices is only a small part of the work of reducing the number of accidents. Co-operation of mine operators, mine officials, and above all, of the miner himself, are absolute essentials of a successful safety campaign. Assuming that this office has the co-operation of mine operators and officials and that the mines are properly equipped with safety-devices, little can be accomplished unless the miners themselves will put their shoulders to the safety-wheel and aid in turning it. It is the belief of those engaged in safety-work in mines that the co-operation of the miner is the all-important factor. A mine without safety-devices, but worked by men who are careful and who are constantly on the look-out to avoid mishaps will have far less accidents than the mine fully equipped with safety-devices but worked by careless miners.

This is intended as an appeal to the miner to lend his assistance in the work of lessening the hazards of mining in the State of California. Possibly it has never occurred to him that the establishment of the Mining Division by the Industrial Accident Commission was brought about solely to protect him; that the expense of operating this division is incurred by the State for his benefit; and that the money which operators must spend in complying with the Mine Safety Rules will bring about better conditions for him. In view of the activities of the State and Federal governments, mine operators, and others to protect the life and limb of the miner, it is believed that the miner will respond to this effort with an equal amount of interest.

The miner might ask: "What can I do to increase safety in the mines?" There are a great many things that the miner can do to help in this work.

He can be on his guard to prevent injury to himself and to his fellow workman.

He can use his knowledge and experience in preventing a greenhorn from doing something that will result in an accident.

He can lend a helping hand to his fellow workman who has a job that is too heavy for one man.

He can familiarize himself with his working-place, and with the conditions in and about the mine in which he works, so that he can intelligently avoid accidents.

Remembering that the greatest number of accidents are caused by falls of rock and ore, by falling down or into unprotected open places, and through haulage and tramming, he can be continually on his guard against such accidents.

By doing these things the miner will not only benefit himself and those dependent upon him, but he will perform what is due of every man toward his fellow.

EDWIN HIGGINS.

San Francisco, February 2.

Libraries in Mining Towns

The Editor:

Sir—This is an appeal on behalf of the traveling engineer to his more fortunate brother whose home is somewhere besides the particular place where he happens to hang his hat.

Those of us who travel can carry few technical books with us. Frequently we wish to look up some point, and naturally have recourse to the public library of the city in which we happen to be staying. I have been much surprised to find that very few, in fact practically none of the libraries in the mining towns have any books, to speak of, of technical interest to a mining engineer. The same is true of mining magazines.

Recently I went into a library which had an unusually large number of books on its shelves and a building that would have been a credit to a town three times its size, and asked for Lindgren's 'Tertiary Gravels.' I knew from the way the librarian answered me that she had never heard of the book, and when I explained what it was, she referred me to their books on geology and mining, not over 10 volumes all told. And this was in the largest gold-producing county in California and the town that has probably shipped more placer gold than any other in the world.

The visitor usually seeks local information, the kind that is embodied in the reports of the Geological Survey and State Mining Bureaus. Most of these can be obtained without cost or at a nominal figure. I have no doubt that the libraries would be glad to put these books on their shelves if the matter were brought to their attention. Cannot some of the engineers living in the different mining centres take this up with the librarians and assist them in preparing a list of the geological reports and water-supply papers of local importance?

LEROY A. PALMER.

San Francisco, January 24.

[We second this appeal, having had almost exactly similar experience in the public libraries of mining towns that should know better. On occasion we have not been able to obtain even copies of the better mining or technical weeklies, although the reading-tables would be littered with lugubrious magazines on social topics.—EDITOR.]

A Glossary of Flotation

PULP is powdered ore mixed with water.

FILM—A coating or layer, a thin membrane.

ABSORB—To drink in, suck up, like a sponge.

MODIFY—To change in character or properties.

CONTAMINATE—To make impure by contact or admixture.

SKIN—An outside layer, coat, or covering. From A. S. *skin*, ice.

NASCENT—Coming into being, beginning to develop. From L. *nascens*, being born.

OCCUDE—To shut or close pores or other openings. From L. *ob*, before, *claudo*, close.

PINE-OIL is a derivative of wood-tar, as phenol and cresol are derivatives of coal-tar.

LEVITATION—The act of rendering light or buoyant. L. *levitas*, lightness, from *levis*, light.

FROTH—A collection of bubbles resulting from fermentation, effervescence, or agitation.

GANGUE—The non-metalliferous or non-valuable metalliferous minerals in the ore; veinstone.

GREASE—Animal fat when soft. Also anything oily or unctuous. From the French *graisse*.

SURFACE TENSION is the contractile force at the surface of a liquid whereby resistance is offered to rupture.

GRANULATION is the state or process of being formed into grains or small particles. From L. *granum*, a grain.

FLOTATION is the act or state of floating, from the French *flottaison*, water-line, and *flotte*, to float, to waft.

ADSORB—To condense and hold a gas on the surface of a solid, particularly metals. From L. *ad*, to, and *sorbere*, suck in.

VESICLE—A small bladder-like cavity or hollow sphere of liquid. From L. *vesicula*, diminutive from *vesica*, bladder.

COAGULATION—The state of a liquid resulting from clotting or curdling, the act of changing to a curd-like condition.

OILY and **GREASY** are substantially equivalent terms. All oils are greasy. Greasiness suggests more viscosity than oiliness.

BAFFLE—That which defeats or frustrates, hence the projections or wings that divert or interrupt the flow of pulp in a vessel.

BUBBLE—A globule of air or other gas rising in a liquid; also a vesicle of water or other liquid inflated with air or other gas.

AGITATION is the act or state of being shaken, stirred, or moved with violence. From L. *agitatus*, *agito*, the frequent of *ago*, to drive.

SAPONIFICATION—Conversion into soap; the process in which fatty substances form soap, by combination with an alkali. From L. *sapo* (*n*-), soap.

OIL includes (1) fatty oils and acids, (2) essential oils, mostly of vegetal origin, such as eucalyptus and turpen-

ting, (3) mineral oils, such as petroleum products, including lubricating oils.

OSMOSE—The tendency to mix of two liquids or gases by passing through a membrane or porous wall separating them. From G. *osmos*, pushing.

SCUM—Impure or extraneous matter that rises or collects at the surface of liquids, as vegetation on stagnant water, or dross on a bath of molten metal.

METALLIC—Of or belonging to metals, containing metals, more particularly the valuable metals that are the object of mining. From L. *metallum*, ore.

COAL-TAR is a thick, black, viscid, and opaque liquid condensed when gas is distilled from coal. Such products consist of soluble and insoluble substances.

FLOCCULENT means resembling wool, therefore woolly. Coalescing and adhering in flocks. A cloud-like mass of precipitate in a solution. From L. *floccus*, a lock of wool.

CONCENTRATE—To draw or gather together to a common centre. To reduce to a purer state by the removal of non-essential matter. From L. *con* or *eum*, with, and *centrum*, a centre.

EMULSION—Milkification. A liquid mixture in which a fatty or resinous substance is suspended in minute globules. From L. *emulgeo*, to drain out, in turn from *e*, out, and *mulgeo*, milk.

VISCOSITY is the property of liquids that causes them to resist instantaneous change of their shape or of the arrangements of their parts; internal friction; gumminess. From L. *viscum*, birdlime.

FAT is a white or yellowish substance forming the chief part of adipose tissue. It may be solid or liquid; it is insoluble in water; when treated with an alkali, the fatty acid unites with the alkaline base to make soap.

MOLECULE—The smallest part of a substance that can exist separately and still retain its composition and characteristic properties; the smallest combination of atoms that will form a given chemical compound. From F. *molécule*, diminutive from L. *moles*, mass.

OLEIC ACID is fatty acid contained in olive oil combined with cresoline. Although called 'acid' it is an oily substance and functions as oil in flotation operations; it is contained in most mixed oils and fats, from which it is obtained by saponification with an alkali. From L. *oleum*, oil.

MINERAL—Inorganic constituent of the earth's crust. As used in flotation the terms 'mineral' or 'metallie' particles hark back to the French (*minerais*, ore) and Spanish (*metal*, ore) meanings. Both terms refer to those valuable constituents in the ore that it is the object of the process to separate from the non-valuable constituents, or gangue. Sometimes 'metallie' has reference to metallic lustre, one of the chief characteristics of metals and more particularly of those metallic sulphides that are especially amenable to flotation.

The Influence of Technical Journalism on Mining Education

By T. A. Rickard

*THE subject allotted to me is a big one; in order to treat it with any hope of success I must restrict my scope to the journalism that concerns itself with the mining of minerals other than coal and to the metallurgy of minerals other than iron. The industry of coal and iron covers a wide range of human effort, quite apart from ordinary metal mining.

Under technical journalism are included the periodical publications—usually weekly, rarely monthly—that furnish articles on current technology, accompanied by editorial comment and supplemented by news concerning the progress of the mining and metallurgical industries. In order to understand the relations of this phase of the publishing business to the work of mining it is necessary to recognize, in the first place, that it is done for gain; it is supported by the advertisements of the manufacturers engaged in supplying the needs of an industry to the scientific and ethical sides of which the journal is supposed to minister. Success in this form of business depends not upon the number of subscribers, but the number of actual readers connected directly or indirectly with the selection and purchase of the machinery and supplies offered for sale on the advertising pages. The proceedings of the technical societies do not come under the heading of journalism, because they furnish neither comment nor news concerning current events, they are bound volumes or paper-covered bulletins composed of essays on technical subjects. Those that attach advertisements to their bulletins are neither amateur nor professional; they are hybrids. Journalism is a profession, just as much as mining engineering. The two professions flourish best when each is kept true to its function.

In the United States the journalism of mining has been co-existent with the application of science to the exploitation of minerals. The MINING AND SCIENTIFIC PRESS was founded at San Francisco in 1860; the *Engineering and Mining Journal* at New York in 1866. While others have come into existence, and gone out of it, during the last half-century, these two represent such educative factors as journalism has given to the mining industry in the United States.

An educative effect was barely possible 25 years ago when the best technical journals consisted of a dozen pages of heterogeneous information, including one technical article, and editorial comment so brief as to fail in creating any mental impression. It may not be gracious to say so, but it is encouraging, at least, to realize that

in this field of human activity, as in others, there has been progressive development. To this may be added the postscript that the best of existing technical papers is so far behind the ideal that there remains unlimited scope for further endeavor. When some nearer approach to that ideal has been made, then indeed technical journalism may be powerfully educative; at present it is content usually to be intensely instructive. Education is the 'drawing out' of the best faculties of the mind; instruction is the conveyance of knowledge. The French distinguish between these two words much more closely than we do. We use them almost as synonyms. The technical journal sets itself to give information to those engaged in the application of science to industry. It also furnishes news concerning actual progress in the operations of the particular industry to which it is devoted. It chronicles events of technical importance and comments upon them. All of which is usually instructive, and but rarely educative.

The foregoing characterization is true, but I hope to provoke a demurrer. In so far as journalism is scientific it is also educative. The two great commandments of Science are (1) Thou shalt observe carefully; (2) Thou shalt state accurately. In so far as technical journalism respects or inculcates, by example or by precept, the fundamental principle of science, namely, truthfulness, it cannot but be an instrument of education to the human intelligence. Indubitably the recognition of the verities of fact in nature promotes a respect for veracity of thought and deed throughout human affairs. There be those that play tricks with their arithmetic as with their conscience, but, in the main, the ways of science tend to the development of intellectual honesty. And that is a gift of transcendent value to mankind. Beyond all other men, the engineer must perform his work with intellectual honesty; without it, not only does he stultify his mind but he destroys his work. The dilettante of Science may please himself with incorrect deductions without manifest injury to himself or others, but the engineer applies his reasoning to physical facts, and any blunder in the logic entails a failure in visible achievement. Therefore engineering, whether of mines or railways, is based on devotion to the truths of Nature as ascertained and systematized by Science. Hence the technical journalism that is devoted to mining engineering must, in a measure, spread scientific principles among the mining population and thereby prove educative through the inculcation of essential truth. Of course, there are some mining papers that have so sacred a regard for truth as rarely to use it, but

*A paper read before the Pan-American Scientific Congress, Washington, D. C., December 1915.

these do not come within the purview of our present discussion. On the whole, we may conclude that the exploitation of technology by journalism must contribute to the development of such a mental attitude, toward both man and nature, as is favorable to education.

So far we have considered an effect that is unconscious. Technical journalism has not posed as an educator. The intention has been to interest those directing or taking part in mining or metallurgical operations, with a view to securing them as habitual readers. If these are won, then the journal becomes an effective medium for publicity to manufacturers having machinery or supplies for sale. This practical basis of the business of journalism must be kept in mind if the discussion of the higher function of such periodical publications is to be anything more than academic. While the basis may be earthy, that is, commercial, it leaves room for a large measure of independence in the editorial sanctum. A water-tight partition is possible between the business end, which looks to the advertiser only, and the editorial end, which looks to the reader only. So long as the editor prints matter that is interesting to those engaged in mining, he is free to print what he likes, for his immediate duty, unexpressed, is to publish matter that will catch the eye and hold the attention of that particular public, mainly professional, which uses the machinery and supplies pictured on the advertising pages. With these he himself has nothing to do. In order to be interesting, that is, to merit confidence in what is written, the editor and his staff must be as detached as possible from the buying and selling of machinery, as also of mines or shares in mines—in short, aloof from anything that may undermine the intellectual honesty and the consequent trustworthiness of the reading matter, more particularly the editorial comment. In this respect the journalism of mining is more free and independent, I believe, than the daily press. The big bias of politics is largely eliminated as a factor of error. Appeal is made to a public of more than average intelligence. Independence of attitude is facilitated by the fact that subservience to any particular interest is so quickly detected and resented by the readers as to endanger the value of the paper as a medium of publicity. This tends to give the successful technical journal a character that may fit it eventually to assume the function of education consciously. As yet, its effect in this direction is incidental.

Technical descriptions of methods and processes, together with accounts of current operations, are instructive only. Except in their respect for truth, they are not educative. That function devolves upon the editorial comment and upon the discussion—in the form of correspondence—that it may evoke. When the editor's remarks were limited to short paragraphs there was little chance for the ventilation of those more subtle questions of professional conduct, civic duty, or economic insight that lie at the base of a mining engineer's education. But as the business of mining grows, the successful mining periodical expands into more pages of reading matter and reaches a size furnishing adequate space

for the reasoned consideration and discussion not only of the technology of the physical operations, but also the philosophy of mining, including the ideals of conduct obtaining among all those engaged in such operations, the relations of capital and labor, the ethics of the engineers, the duties of the directors, the vagaries of the speculative public, and the other human aspects of a worldwide industry. This, of course, is truly educative.

As yet, however, these delicate and knotty problems, and the whole subjective side of the industry, cannot be said to furnish the frequent topic of technical journalism. The reasons for such infrequency or disfavor are fairly obvious: in the first place, the average reader asks for information rather than opinions, he wants the facts and data that he can use in his daily work as a consulting engineer, manager of mines, appraiser of mines, metallurgist, superintendent of mills or smelters, assayer, surveyor, economic geologist, prospector, and so forth. Just as the man who goes to the theatre expects to be amused first of all, and may accept a moral lesson incidentally, if it does not kill his amusement, so the average reader wants useful information first, and then, if the editor has space and the reader has time, the latter may give his attention to 'the great imponderables' as discussed on the editorial page. In short, a paper must succeed in giving valuable information on the concrete affairs of the mine, mill, and smelter before it can hope successfully to discourse on the abstract matter of human relationships. Moreover, such subjects provoke antagonism, which is good proof that they touch interests that are vital, both commercially and intellectually. They are controversial because the readers of the technical press are to be found on both sides of the chief issues involved, those of the buyer as well as the seller of mines, those of the shareholder as well as the director of mining companies, those of both employer and employee, those of the engineer and of his client. It is impossible to discuss the complexities arising from such relationships without offending some, that is, if it is done frankly and fearlessly—and if done in any other way it is offensive to everybody. Yet it is done, and my own belief is that it can be done not only so as to increase the usefulness and prestige of the mining press as an organ of public opinion, but also in such a manner as to advance the financial interest of the publisher, if it be assumed, as we may do confidently, that those in control of the complex activities of mining are serious and thoughtful men. Man does not live by bread alone. The men of most consequence, the capable and the successful, recognize that the more interesting and the more important aspects of engineering are beyond the scope of the slide-rule. Such men, when the day's work is done, may not desire a dose of technology; they are more likely to find satisfaction in a discussion of the principles that give life to the dry bones of fact and of the ideas that give direction to the lives of men.

Thus we come to the conclusion that the educative function of technical journalism is, as yet, sub-conscious, if not wholly unconscious; it reflects the spread of real

education among the larger part of the population engaged in mining and its related professional or industrial activities. The tremendous growth of technical training as given in the mining schools and colleges of this country is the consequence, of course, of the extraordinary increase in the production of metals, itself the result of a demand created by the rapid development of our material civilization. The increase in the metal production of the United States during 20 years is shown by the following figures:

| | 1894. | 1914. |
|-----------------------------|------------|------------|
| Gold, in ounces | 1,923,619 | 4,440,904 |
| Silver, in ounces | 49,846,875 | 67,929,700 |
| Copper, in short tons | 176,752 | 546,442 |
| Lead, in short tons | 156,530 | 512,794 |
| Zinc, in short tons | 74,004 | 353,049 |

Complete statistics of attendance at the Schools of Mines are not available, largely because many new schools have been started during the last two decades, but judging from the records available to me, I conclude that instruction for mining was being given to more than twice as many young men in 1914 as was the case in 1894. Thus it is readily understood why technical journalism is finding a larger and more discriminating public, and has arrived at a point when it may begin consciously to perform its educational function.

If this function is to be performed effectively, it will be not by the printing of chronicles and comments only, but by the furnishing of criticism and ideas. Literature is a criticism of life; journalism is a criticism of daily life; technical journalism must become a thoughtful criticism of all that concerns the technical man—the man who does things, the engineer, the exploiter, and the explorer. The mere compilation of descriptive articles and the recording of detailed results will be left to the technical societies, the publication of which are now so voluminous as to insure mental dyspepsia to the man who tries to assimilate them omnivorously. Even such intermittent opportunities for the exchange of ideas as are furnished by congresses and conventions cannot perform the function of journalism because they are too sporadic and too ephemeral. An educative effect can be achieved best by iterative effort. A public meeting may be stimulating momentarily, but to exert persistent influence it is necessary to use persistent methods, to present the same idea many times in various guise, to awaken interest and to hold it until a given idea has been grasped, considered, received, or rejected in favor of others that are better.

Technical publications today suffer from being too numerous and too voluminous. Twenty-five years ago a man of active mind could read all that was written on his branch of technology and could keep in touch with the allied subjects, but today the output of the technical societies, congresses, and press is beyond the compass of any individual. We shall agree that the quantity of printed matter on technical subjects is enough, and to spare. Not much of it is educative, because so little of it is critical. What is needed henceforth is to ensure that the output of new facts, new records, and new ideas

shall be accompanied, checked, and disciplined by wholesome criticism. That is the duty of journalism and in the performing of that duty journalism will render the truest service to the cause of education.

Antimony in Inyo County

Antimony claims have been patented in Wild Rose canyon, on the north side of Panamint range, Inyo county, California. The vein of ore, stibnite, is said to be 3 ft. wide, and to have been developed by open cut for 1000 ft. Estimates of ore in sight have varied from 10,000 tons of 30% to 5000 tons of 50% ore; one authority claims to see a resemblance to the well-known deposit near Wadley, San Luis Potosi, Mexico. A disadvantage to the commercial development of this Californian deposit is that the nearest railroad station is 72 miles away at Searles. However, a good wagon road is said to exist and a railroad to borax deposits nearby will reduce the haul, so that the cost of transporting the ore to railroad will be less than \$10 per ton. There is an antimony smelter at Los Angeles, as well as at San Francisco. Production of antimony in the United States has been almost entirely from antimonial-lead. New uses are being found for antimony, such as a proportion of antimony sulphide in match-heads and in the smear on match-boxes. Antimony ores imported into this country are subject to a duty of a cent per pound, and antimony metal $1\frac{1}{2}$ cent per pound.

THE ECONOMICS OF SHOVELING was the subject of a recent lecture by L. E. Young, professor of mining in the University of Illinois delivered before the mining students of the University of California. In the Flat River lead-mining district of Missouri, said Mr. Young, the men receive a bonus of 10 cents per ton for each ton over 20. A case is on record of one man who shoveled over 55 tons per day for a week. In the Homestake gold mine, practically every ton of ore produced is shoveled by hand. A shovel deteriorates rapidly in mining work, particularly when used on a rough surface rather than on a smooth plate. After two or three weeks of hard use a shovel will be worn so much that the efficiency of the shoveler is lowered, for instance from 24 tons to 20 tons. In money value, this may be worth 50 cents, which loss, it is evident, would nearly pay for a new shovel in one shift. Claude T. Rice pointed out several years ago that in western mining districts long-handled shovels are the rule, where a man saws off the handle to suit himself, while in the Lake Superior region the short D-handled shovel prevails. He contended that the use of the long-handled shovel permitted a man to utilize his legs in shoveling, thus distributing the work among a number of muscles. The short-handled shovel, he maintained, throws the strain almost entirely on the back, making the movements slower and more laborious. Mechanical shovelers, belt-conveyors, and electric steam-shovels are being adapted increasingly for underground use in drifts and stopes.

Molecular Forces in Flotation

Surface Compression

By Dudley E. Norris

AT the meeting of the local membership of the American Institute of Mining Engineers on December 14 last the question was asked by one of the speakers: "Why does the greased needle float on the surface of a tumbler of water and the wetted needle sink?" Did one or another of the experts present rise and say that it was due to 'surface tension' and then in a few well chosen words explain just exactly what 'surface tension' is? Nothing of the sort happened. The question was not only not answered, but it was unanimously avoided. It is a fair question, however, and deserves an answer.

The fact is that 'surface tension' is a misnomer. Tension is a stretching, whereas the phenomena in question are those of compression. In 'surface tension,' a bubble of air or a drop of water is pictured to the imagination as being actually of the form that it would have if it were contained in a film like that of a soap-bubble or a toy-balloon. That grasped, the substance of the bubble or of the drop is ignored and we are asked to occupy our minds only with the imaginary film. The reasoning appears to be: "There might be such a film, there must be, there is. Otherwise, we are not able to explain it at all." In what follows, I shall attempt to explain the phenomena discussed in terms of molecular attraction and of heat.

If you will fill a tumbler with water or other liquid and then continue carefully to pour in more; instead of running over the side, there will be a heaping up of the liquid in the tumbler and a rounding of the surface, the centre of the liquid being as much as a sixteenth or even an eighth of an inch higher than the rim of the tumbler. That is the phenomenon of your 'surface tension' pure and undefiled. The same phenomenon is seen when mercury is contained in a glass vessel, even when the vessel is only partly filled. Mercury does not wet glass and where the liquid metal meets the side of the glass vessel the mercury is convex. Where, however, the tumbler is only partly filled with water the surface of the water is concave where it meets the inside of the tumbler, and the glass is wetted.

In the Miami flotation case it was stated that surface tension is a force existing in the surface of a liquid that tends to draw the liquid into the form of a sphere, this being the most compact form that a given volume can assume and the form in which it presents the least surface. This is a lovely specimen of the logical fallacy known as *post hoc ergo propter hoc*. In short it was said in the Miami case, that because the most compact

form that a given volume can assume and the form in which it presents the least surface is a sphere, therefore the volume assumes that form and does so at the behest of surface tension; but as to the why and how, nothing was said, nor can they be imagined. It reads as if there had been a mass-meeting of the molecules looking to 'preparedness.' The molecule acting as chairman states the business before the assembled molecules: "Owing to the war in Europe and a hard winter coming on, the molecules must decide on some form that will be the most compact and which will present the least possible surface to an unsympathetic world. The sphere comes highly recommended. It is moved and seconded therefore that the molecules form a sphere. So ordered."

The calculus proposition that two homogeneous spheres attract each other as if their masses were collected at their centres of gravity is as true as anything human can be. It is also true that in a single homogeneous sphere, if acted on by no outside force, the cohesive attraction of its molecules for each other will act radially toward the centre and form a sphere; and it is this radial attraction and not an imaginary film or a non-existent tension, that causes the phenomena and it is probably some similar molecular attraction that causes mineral flotation.

In James Clerk Maxwell's article on capillary action, in the Encyclopedia Britannica (11th edition), vol. 5, p. 258, he says: "Plateau, who made an elaborate study of the phenomena of surface tension, adopted the following method of getting rid of the effects of gravity. He formed a mixture of alcohol and water, of the same density as olive oil, and then introduced a quantity of oil into the mixture. It assumes the form of a sphere under the action of surface tension alone." That it assumes the form of a sphere is granted. That surface tension does it is denied.

The toy-balloon has a place in a rational explanation of the phenomena under discussion; but the alleged film around a drop of water or around a bubble of air, or as the top layer of a body of water, like the film of a toy-balloon, has no existence in nature. The vendor of toy balloons has each one of his gayly colored stock fastened by a string, which serves the double purpose of keeping the gas in the balloons and of keeping the balloons themselves down to earth. The free ends of the strings are brought to a common knot. There is a pull on each string along the hypotenuse of a right-angle triangle; this can be resolved into a vertical

component, tending to make the balloon float off, and a horizontal component, tending to crowd the balloons together.

The same thing happens in surface compression. The water in the tumbler is subject to the cohesive attraction of its molecules, to the attraction of gravitation, and to heat. The water, if free from the attraction of gravitation, would tend to form a sphere, but gravitation causes it to conform to the shape of the containing vessel. Heat, by tending to drive the molecules apart, acts counter to the attraction of cohesion and their equilibrium fixes the specific gravity of the water, its bulk, and its state of aggregation—making it solid, liquid, or gaseous as the case may be. If gravitation be neutralized or be not opposed, the water takes a spherical form under the influence of cohesion, as is shown in raindrops, in Plateau's experiment, and in drops of water on a hot stove, in conformity with the rule of homogeneous spheres.

Let us suppose each molecule of water in the tumbler

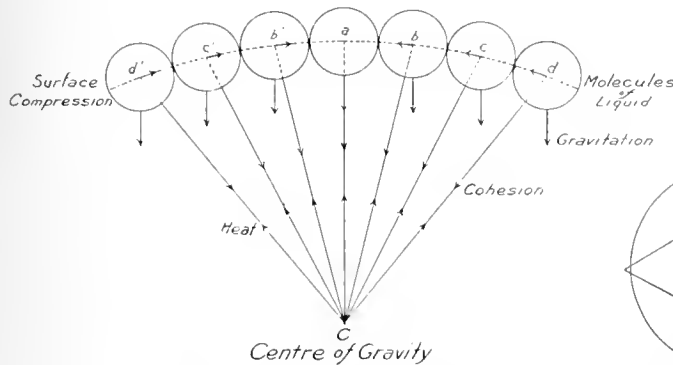

FORCES AFFECTING SURFACE OF WATER.

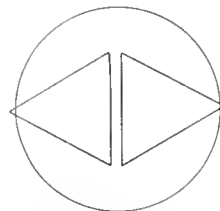

VOLUME ABOVE 4° C.

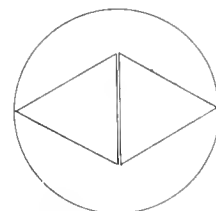

VOLUME AT 4° C.

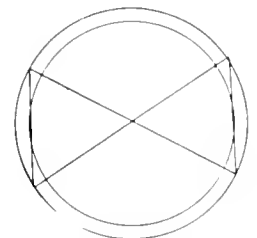

VOLUME AS ICE.

to be free from the attraction of gravitation and in the form of a sphere, then the vertical section of the surface layer would look like this:

There you have the stock of toy-balloons with the strings connecting each with a common central point. *C* is the centre of gravity of the water in the glass. The lines diverging from *C* show the directions of the forces of cohesion. The short vertical lines downward from each molecule indicate the lines of the force of gravity and the arrowheads on the cohesion lines mark the opposing forces of heat and cohesion. In the triangle, *Cad*, for example, the hypotenuse *Cd* represents the total force of cohesion; *Ca* is its vertical component, and *ad* its horizontal component. The resultant of all these horizontal components, *ad*, *ac*, *ab*, etc., is a force effecting a compression of the surface of the water. A good idea of the structure of surface compression is shown by the ripe seed-tuft of the common dandelion.

Oh, but water is not compressible. True enough, to any sensible degree by an exterior force; but the interior forces at work in water do many wonderful things. For instance, they cause water to expand on cooling and to contract on heating, between 0° C. and 4° C., and all the water phenomena of oceans, rivers,

and rain-fall, of hydraulic and of steam powers, and of the irresistible force of freezing, are caused by the molecular activities existing in a drop of water.

One reason for lack of a clearer understanding of these phenomena is the failure to perceive the fact that the tendency of the water in the tumbler to form a sphere is incessant, whether the attraction of gravitation acts on the mass of the water freely, as in falling; is warded off, as in Plateau's experiment; or is superimposed upon the attraction of cohesion, compelling the water to conform to the interior shape of the tumbler and rendering the ever-present cohesion inconspicuous.

The action of water from the higher degrees of temperature, through 4° C. to ice is shown by the accompanying drawings. A molecule of water, composed of three atoms, is plausibly represented by a triangle. Two such molecules are separated a certain distance by a corresponding amount of heat and this distance fixes the volume of the mass of water, which increases and diminishes as the degree of heat is raised or lowered. At 4° the volume of water is at a minimum and it is a fair inference that the molecules of water are at that point nearer to each other than at any other point. Below 4° C. the molecular forces react in such a manner

as to cause a change in the relations of the molecules themselves, causing them to turn and—in the state of ice—to assume the positions shown in the third figure, with a lower specific gravity than the water had before freezing. No other forces are necessary to the causation of the phenomena indicated than those of cohesion and heat.

Here, then, is the answer to the question asked at the meeting: By reason of the horizontal components of the attractions of cohesion which draw each molecule of water toward the centre of gravity of its mass, the surface of the water is compressed, made more dense, and offers a resistance to the needle greater than the weight of the needle. That weight is not sufficient to break apart the surface molecules but only makes a slight indentation on the surface. When the needle is wetted, capillary attraction raises the compressed surface above the needle which, no longer resting upon the denser surface, but in water not under surface compression, obeys the attraction of gravitation and sinks.

Attention was called above to the two cases of simple surface compression where the entire surface of both liquids, the water in the brim-full tumbler and the mercury in the partly filled glass vessel, are convex, whereas in the tumbler partly filled with water, the

edge of the water, where it meets the glass composing the tumbler, is concave and the water wets the glass. Thus there is added a new force which modifies the surface compression of the water and draws the water at the edge upward on the glass, forming a concavity tangent to both the surface of the water and the inside of the tumbler. It makes no difference here and now what this force is called, whether cohesion or adhesion; whether it is the same molecular attraction that exists between the molecules of the water or whether it is the cohesion of the glass acting at sensible distances, or neither, or both. The water is drawn up, not pushed up, and any drawing up is attraction, and acting on molecules it is molecular attraction.

In a tumbler $2\frac{1}{2}$ inches in diameter the horizontal concavity against the glass seemed to be about $\frac{1}{16}$ of an inch wide, perhaps a little more, leaving about $2\frac{3}{4}$ in. of convexity to $\frac{1}{2}$ in. total concavity, out of the diameter of $2\frac{1}{2}$ in. The vertical concavity seemed also about $\frac{1}{16}$ of an inch along the inside of the glass. With glass tubes of smaller diameter the horizontal concavity seemed to remain about the same, but the vertical concavity increased as the diameter diminished. The convexity at the centre of the surface decreased with the diameter of the circle and in a tube of $\frac{1}{2}$ in. diameter the surface of the water was an inverted hollow sphere with no convexity at all and its height above the level of the water in the tumbler was $\frac{1}{2}$ of an inch. With a tube of $\frac{1}{4}$ in. diameter the water came up $\frac{1}{4}$ inch.

The surface compression at the edge of the water in the tumbler is less than nearer the centre, being practically zero, and offering no resistance to the upward attraction upon the water. If a glass tube be partly immersed in the water in the tumbler, the water in the tube, even if open at the lower end, forms a separate cohesive mass, independent of the rest of the liquid with all the phenomena of capillarity.

It has been said above that the cohesion of the water varies inversely as the temperature, being greater at the lower than at the higher temperatures, and at the boiling point there is no cohesion. With the same changes in temperature the attraction between the water and the glass sides of the tumbler varies exactly as the cohesion varies, and there is every reason to believe that the forces elevating the liquid are those of cohesion of the water and the glass acting at sensible distances. These phenomena between the water and the mercury on one hand and glass on the other are, of course, those of capillarity. They seem to fit in with the above theory of surface compression.

Then what is there left of true surface tension? Well, there is the soap-bubble. I made some experiments in this direction a few days ago with 50 or 60 soap-bubbles from 4 to $6\frac{1}{2}$ inches in diameter. These were burst over a dark hardwood table about 30 inches square, so that the resulting wet spots on the surface of the table could be examined. Care was taken in every case in blowing the bubbles to remove the usual drop of water at the south pole of the bubble, so that all the wet spots

came from the wreck of the distended film. After each bubble burst the table was wiped dry for the next one. When inflation ceased, one bubble 5 inches in diameter shrank an inch before it burst; another shrank from $6\frac{1}{2}$ to 5 inches. In both cases the air was expelled by a real surface tension of the bubble's film. Most of the bubbles were blown until they burst, at from 1 inch to 2 feet above the table. The ones at 1 inch spread wet spots in circles from 7 to 13 inches in diameter. Of the bubbles that burst at greater distances from the table, at 6 inches above the table the wet spots extended to the edge of a circle 15 inches in diameter; at 12 inches above, 20 inches; at 20 inches, 24 inches; and at 24 inches, 30 inches. Counting a quarter circle, there were from 175 to 260 wet spots, or 700 to 1000 for each bubble.

It was evident that the force throwing these drops of water such great distances was not the air pressure inside the bubble. When the bubble burst the attraction of cohesion of the water composing the film acted to re-unite the distended watery molecules and, as the shortest distance between two points on the circumference of a sphere is measured on the great circle that joins them, the re-uniting molecules took that route, traveling over the spherical surface of the bubble, and when a number of them met and formed a drop, all the molecules were attracted with a certain force. The tangential components of these cohesive forces, acting in the substance of the spherical film and at right angles to the bubbles' radii, neutralized each other, while the centrifugal components united to shoot the drops away from the centre of the late bubble, in the direction of the prolongation of the bubble's radii, and they fell in a wide circle, as already stated.

This is a true statement of the phenomena of the effect of surface tension on a soap-bubble. By what stretch, by what torture, of the imagination can these phenomena be brought into identity or even the least resemblance with those of the placid floating of the greased needle upon the compressed surface of the water in the tumbler?

Mr. Charles T. Durell in an article in the *MINING AND SCIENTIFIC PRESS* of September 18, 1915, entitled 'Why Is Flotation?', dissects the rising of a bubble through a liquid and says: "Surface tension causes the molecules of the liquid to form a film around the bubble and remain with it to the exclusion of like molecules during the time the bubble remains in the liquid. To all intents and purposes, this film is seen to be the same as if it were a membrane of some solid. The air in these bubbles can no more come in contact with the liquid through which it is passing than it could were it inside a toy-balloon, for instance. The bubble may be said to be enclosed in a 'liquid skin'." As a proof of his argument he cites in a footnote the following: "A striking experiment to show these liquid films is as follows: To a beaker partly filled with a colorless oil, add a small quantity of permanganate solution. Blow air through a finely drawn-out glass

tube into the permanganate solution now on the bottom of the beaker. Air bubbles enclosed in the colored liquid film rise through the oil and break at the surface, because of the expansive force of the gas. The colored water drops back through the oil exactly in the same manner that a balloon, bursting, drops to the earth."

With these instructions the following experiments were made: A layer of water, half an inch thick, colored dark blue with a dye not soluble in kerosene, was put into a tumbler and three inches of white kerosene poured upon it. With a medicine dropper having a rubber bulb and a $\frac{1}{16}$ -in. hole in the end of the glass tube, bubbles of air were blown into the blue water, the end of the glass rod resting on the bottom of the tumbler. At first the pressure on the bulb was made very gentle, the idea being to have the bubbles as small as possible. As many as 200 of these tiny bubbles were blown and they rose to the surface and formed a group. Some burst, some were incorporated with others, and finally, of course, they all burst. Every one of these 200 bubbles burst within a circle of half an inch, and that circle from the time of the first bubble until the last one, was not free from bubbles, one touching another and all forming a single compact group; but at no time, in the strong sunlight, was there the slightest trace of blue in the circle nor anywhere in the kerosene. The upward bound bubbles were perfectly white and there were no return passengers. The bubbles had no films but were simply holes in the water. When they came to the joint surface of blue water and kerosene, they slipped into the kerosene, made holes in that, and burst at the surface with no trace of a film.

Then, with greater pressure on the bulb, larger bubbles were blown, and with them, small quantities of the blue water were forced up into the kerosene. When these came separately the air rose to the surface and the water dropped back but where they came together the air buoyed the water up to the surface where the air escaped and the blue water sank through the kerosene and disappeared. With greater pressure the bubbles became still larger, as did also the size of the drops of water forced out with the air. Where trapped together the larger masses of air and blue water joined and rose to the surface, as a single entity, sometimes very rapidly and sometimes very slowly. But in no case, whatever the size of the constituent parts, was the air-bubble blue. There were never any water-films. The rising combined air and blue-water drops in the cases of the larger bubbles were in shape as if the bubble were sitting on a tiny blue feather bed. In every case the blue water was below and the white bubble above and the bubble was pulling the drop to the surface. Sometimes the drop was too heavy for the bubble to float and both sank to the water layer and remained stationary until the drop merged in the blue water and the bubble was released.

When the smaller bubbles rose to the surface of the kerosene they did not break as quickly as in water but seemed to strike against the under side of the

surface stratum and rebound downward and moving over to the edge of the tumbler. On nearing the glass they seemed to rise as if attracted upwardly, like the part of the surface stratum around the edge under capillary attraction.

Some other interesting phenomena of capillarity were noticed. In the blue-drop-kerosene experiment the sides of the glass were wetted by the kerosene, even below the joint surface of the liquid; but notwithstanding this fact there was observed the concavity of the blue water under the oil, seemingly warranting the belief that the attractions between the water and the glass took place through the intermediate film of oil.

With a body of mercury, a glass tube pushed below the surface showed a rounded surface of mercury within the tube, with no capillarity, the rounded surface being due solely to surface compression. With the tube floating in the mercury the level of the outside mercury was exactly the same as the top of the rounded contents of the tube; but when the tube was pressed down into the mercury the level of the mercury in the tube was lowered. It seems likely that the indentation of the floating needle, and the lowering of the level of mercury in the glass tube are both due to the resistance of the surface compression to the entrance of foreign bodies.

In the experiment of the blue water, the bubbles, and the kerosene, we come most unexpectedly upon flotation, or its counterfeit. If it is flotation, like the mineral flotation, how is it to be accounted for? If it is different, what is the difference? Will an explanation of the blue drop-kerosene flotation be that of mineral flotation, or will it help in that direction? There is surely an attraction between the air-bubble and the blue drop, or why should they stick together? The blue drop is heavier than the kerosene and the bubble of air lighter. One pulls up and the other pulls down. Why do they not separate unless there is a positive molecular attraction between them? Why does the bubble, resting upon the blue drop, buoy both to the surface of the kerosene, except for some molecular attraction between blue drop and bubble? Where this attraction is manifested, even slightly, it is helped by the static pressure of the liquid medium in which the flotation takes place.

The great unsolved problem in flotation is the identity of the forces that do the floating. Some say that it is surface tension, some electricity, and some molecular attraction between the air-bubbles and the metallic particles; and there is always the mystery as to exactly the part played by the oil. In this article it is intended to show that there are certain molecular attractions between widely different substances which would seem to be nothing more or less than the force of cohesion acting at sensible distances, but for the circumstance that such an interpretation runs counter to our preconceived opinions as to molecular attractions; but these attractions are shown in this article to exist between glass and oil, between glass and water, directly and

through an intervening film of oil, between glass and air, and between water and air. The impression remains that a thorough examination of our pre-conceived opinions may show that they are fallacious.

There are strong reasons for believing that the state of science today is not unlike that of learning at the end of the 12th century, at the time of the great awakening, when the world dropped the scholasticism of Rome and went back to the philosophy of ancient Greece. We have lost the faculty of studying phenomena, we are ignorant of the first principles of logic, and we have degenerated into mere juggling with names.

Proof of this indictment is found in Vol. XXIV of the Encyclopedia Britannica, at page 4012, where it is stated that the passage of electricity through liquids had been explained as a transference of a succession of electric charges carried by moving particles of matter or 'ions.' Then it was discovered that the moving particles that carried the electric current were much smaller than the atoms of hydrogen, and they were re-named 'corpuseles.' They enter into the structure of all matter. The only known properties of these corpuseles are their mass and their electric charge. There is reason to believe that the whole apparent mass is an effect of the electric charge. "The idea of a material particle thus disappears and the corpusele becomes an isolated unit of electricity—an electron." This is a typical 'scientific explanation.' It starts out inventing the word 'ion', which it immediately re-christens 'corpusele' and then 'electron,' and the only meaning that can be extracted from the argument is that electricity is supposed to be made up of units, a purely gratuitous assumption. Here is another on the same page 402: "Maxwell and Hertz showed that the velocity of propagation of light and electro-magnetic waves was identical and that their other properties differed only in degree. Thus light becomes an electro-magnetic phenomenon. But light is started by some form of atomic vibration and to start an electro-magnetic wave requires a moving electric charge." Here are three sentences all fallacious.

The peculiar tendency of the human mind which substitutes empty names for real phenomena and then plays with the names is the same that makes religious peoples worship idols instead of fixing their minds on principles. It is easier. A pilgrimage to a shrine where one may worship a rag, a bone, or a hank of hair, and be absolved, is less trouble than leading an exemplary life. So that when the question is asked "Why does a drop of water that falls upon dust take the form of a sphere?" it is easier to say "Oh, surface tension" and let it go at that than to think about it. It is all very well to say that a snark is a boojum, if you first define your boojum; but when you scratch the boojum and find the same old snark the pursuit of knowledge seems in vain.

The general subject will be continued with a discussion of electricity and magnetism, explaining their phenomena in terms of molecular attraction and the

undulatory theory of light with the hope that some real and adequate solution may be found as to the problem of the identity of the forces that effect flotation.

Differential Flotation at Broken Hill

*The new zinc plant erected by the Sulphide Corporation at its Central mine, Broken Hill, is now at work. The principal feature of the works, which has a capacity of about 4000 tons per week, is the adoption of the Hebbard-Harvey under-drive machine in place of the original Minerals Separation apparatus. The plant treats tailing from the lead mill, and the aim is to extract the lead remaining in the tailing after table concentration. The pulp is brought by elevators from the mill to the zinc-plant boxes, into which a small quantity of eucalyptus or other suitable oil is introduced. These boxes are fitted with special stirrers to agitate and aerate the pulp, creating a froth which is really a lead concentrate. Having removed all the lead possible by this means, the pulp passes to other boxes where sulphuric acid and oil are added. Agitation and aeration take place as before, and the zinc blende is recovered. There are 10 boxes, three for lead and seven for zinc.

The feed averages about 4.2% lead and 18% zinc, while the lead concentrate assays 57% metal. The residue from the first three boxes assays 3% lead and 18.5% zinc. The zinc concentrate assays 6% lead and 47.5% zinc. The residue assays 1% lead and 2% zinc.

The mill superintendent, R. J. Harvey, states that not only is the process worked in the cold, that is, the use of steam has been discarded altogether, but that it is possible to extract an additional 15% of lead and silver as compared with the process previously in use. Before, there was about 10% more lead mixed with the zinc than is the case now.

There is also another not unimportant factor to be borne in mind: the new plant will probably enable the fine tabling in the lead mill to be discarded. The rhodonite forms the chief difficulty in tabling, as its gravity is about midway between zinc-blende and galena. Flotation gets rid of all gangue, including rhodonite, and there is, therefore, a clear-cut issue between the two sulphides in the subsequent tabling operations.

DURING January the Mint at San Francisco received 221,392 oz. gold and 237,440 oz. silver in various forms. Coinage amounted to \$6,140,000 in double eagles. Coin, bullion, etc., on hand at the end of the month totaled \$365,017,927.87.

SPITZKASTEN. A pointed box or inverted pyramidal vessel, with an outlet at its point for the separation of the components of an ore by gravity. German, *spitze*, point, *kasten*, chest.

*Abstract from *Min. and Eng. Review*, Melbourne.

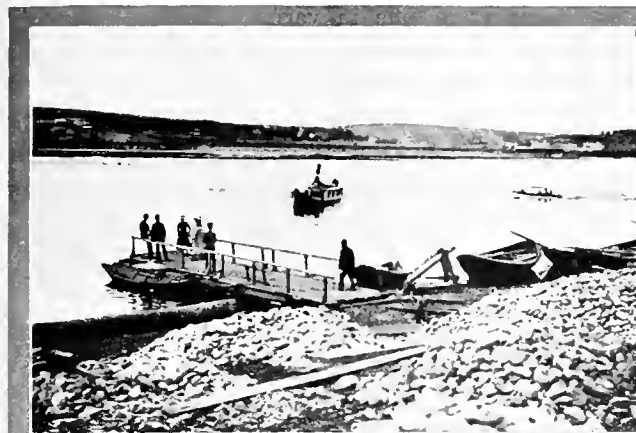

ON THE BODAIBO RIVER.



GOING DOWN THE LENA.

Industrial Opportunities in Siberia

By C. W. Purlington

* ONE of those literary gems found in the old-time school-books relates that four blind men attempted to describe an elephant after having become familiar with this animal solely by the sense of touch. As nearly as I can remember, one referred to it as a tree, one a blanket, one a rope, and the fourth a wall.

The anecdote may serve to illustrate what impression four tourists from a foreign land, having no previous knowledge of the Russian empire, its customs or language, might derive from visits respectively to the Chukotsk peninsula opposite Alaska, to the cities of Petrograd and Warsaw, to the Russian Riviera in the Crimea, and to the cotton-fields of Russian Turkestan.

One characteristic explains some of the otherwise incomprehensible features of that hitherto mysterious land of Russia. The spirit of the Russian empire has been developed in the flat lands. The Russian does not understand the mountains. Neither does he understand the sea. As the Spaniard builds his village on the hillside, so the Russian builds his settlement on the river-flat. Trekking east on his never-ending trail, the Russian finally reached the Pacific. Two hundred years ago he made an attempt to cross it, but it finally baffled him. I give full credit to those intrepid men of the 17th and 18th centuries who carried and maintained the Russian flag in Alaska, even on the Yukon river, and established a Russian colony at Fort Ross in California before the days of '49.

Daring Russian traders built and outfitted their tiny ships at Petropavlovsk on the peninsula of Kamchatka two hundred years ago, and made voyages of two years' duration to the Alaskan shore after the sea-otter. Russian axe-heads have been found on the beach of Resurrection bay, the terminus of the Alaska railway, and

it is said that Russian brass *ikons*, or sacred images, of antique manufacture have been cleaned up on the tables of the gold-dredges in the Klondike. But those *ikons* probably antedate the discovery of gold in the Ural, in the middle of the 18th century, and the gold of the Klondike was to await its allotted time.

Baranof and the Russian-American Company remained the dictators of Alaska until the sale to America. The Alaska Commercial Company succeeded to the trade. The Russian retired, leaving only the lone churches and the desolate hamlets on the Alaskan coast, and on the shores of the Anadir, Kamchatka, and the Oehotsk seas.

But if the Russian retired commercially, he still kept up his exploration of the Pacific border of Asia, and the pioneer Muravief Amursky succeeded in acquiring from China those vast and fertile regions known today as the Pacific Coast and Amur provinces. Nikolaievsk, Habarovsk, and Vladivostok were founded about the time of the discovery of gold in California, but remained villages until the coming of the railway. The most modern and prophetic monument I have ever seen is the colossal bronze statue of Muravief Amursky on the palisades of the city of Habarovsk facing that mighty river, the Amur. Behind him is Manchuria, and before him lies the Ussuri province, nearly as large as California, and rich in timber, grain lands, and minerals. At his feet is being constructed a steel railway-bridge two miles long, and every day the Amur railway is coming, coming from the north from Blagoveshensk to join the railway that connects with Vladivostok, 400 miles to the south.

Each year more ships of the Volunteer Commercial fleet carrying the Russian flag are to be seen on the Pacific, bringing goods from Odessa, and carrying them

*Abstract of an address before the Boston City Club.

as far north as Anadir, less than 250 miles from Cape Nome. Thus it appears that the Russian is beginning to take notice of this thousands of miles of sea coast on the Pacific, and so far as possible the Government is assisting development by lenient customs regulations. No duties are imposed on machinery entering any Pacific Siberian port, and at present all articles are free of duty that enter Siberian ports north of Lat. 54°. Thus a Havana cigar entering Siberia through Ochotsk and transported 500 miles on sleds may be bought today at Yakutsk on the Lena river at a less price than in Boston.

I have said that Russians do not like the mountains, and this fact to some extent accounts for the lack of the development of the gold-quartz mining industry in Siberia. But we must not forget that those long-distance adventurers, the Siberian placer-miners, were mining gold at the rate of over \$5,000,000 annually in the Yenesei forest at 58° north latitude before the discovery of gold in California; nor should it be forgotten that a gold stamp-mill was operating at Bereozovsk in the Ural mountains at the time of the American Revolution.

The industries commenced in Siberia are mainly those of a pastoral and agricultural character. The butter export business from Omsk, Novo-Nikolaievsk, and Barnaul in West Siberia now amounts to \$20,000,000 annually. Much of this butter goes to England by way of Denmark. This business has apparently only commenced. It has all developed within the past 10 years. It is said that this butter is already beginning to find its way as far as Mexico. I can bear evidence that it is of excellent quality, as I have used it for the past two seasons, in one-pound tins. Under ordinary conditions the butter is transported to Riga on the Baltic sea in refrigerator-cars, a distance from Omsk of 2000 miles.

My friend August Heid of Chicago has been at work for several years as manager of the business of the International Harvester Co. in East Siberia, building up a business in agricultural machinery. This machinery is shipped from Portland, Oregon, to Kobe and thence to Vladivostok, to be there distributed to various centres such as Harbin, Blagoveshensk, Habarovsk, and the Trans-Baikal region, as far as Irkutsk. There it comes in competition with freight-rates from New York and Liban. It is a common sight in traveling on the Vladivostok-Habarovsk branch of the Trans-Siberian railway through the fertile Ussuri valley to see American reapers, harvesters, traction-engines, and mowing-machines used by the small peasant-farmers. Please do not, however, get the idea that this business was started without difficulty. The Harvester company sends no young Americans into that country who cannot speak the Russian language. That is the first step. In addition to this accomplishment, these young salesmen must have infinite patience, must be able to take long rough journeys by Siberian cart and sledge, must be able to live largely on tea, black bread, milk, eggs,

cucumbers, and soup. They must be able to sleep and pass days at a time in vermin-infested huts, without fresh air in winter time. These, after all, are mere personal difficulties and are surmountable. What appears nearly insurmountable are the difficulties of convincing the people of their need of a new article. I enlarge on this feature here, as the Harvester company has initiated its business by establishing actual working exhibits of its machinery. Small traveling shows, similar to a country circus, were sent from village to village both in European Russia and Siberia, with a full equipment of tents, wagons, etc., and types of the machinery useful to the people. Working tests were made before the assembled villagers until the people were convinced that such machinery would be useful to them.

The Siberian peasant is emphatically "from Missouri." He must be shown. The only way to sell him your wares is to show him how they work. Curiously enough the best purchasers hitherto of American agricultural machinery have been what may be called the outside religious sects who, or whose ancestors, were exiled to Siberia. Of these the Malakans, who live in the great grain region of the Zeya valley surrounding Blagoveshensk on the Amur river, are the most notable. A more curious sect are the Skopsi, who live in an extremely fertile region surrounding the town of Yakutsk. Yakutsk is on the Lena river, some 1200 miles in a straight line north-east of Irkutsk, the nearest railway point, and as the traveler goes, nearly 2000 miles. It is in the latitude of the Great Slave lake of Canada. In October 1914 I met two Englishmen who had just come from Yakutsk, where they had purchased a large quantity of mammoth ivory. They informed me that the Skopsi are able farmers and almost without exception use modern agricultural machinery.

I do not think it an exaggeration to say that the grain resources of Siberia are beyond comprehension. Parallel with these resources are the live-stock possibilities. The number of horses in the Russian empire is estimated at 35 millions as against 24 millions in the United States, sheep at 80 millions as against our 50 millions, and cattle at 51 millions as against our 59 millions. I am safe in saying that a considerable proportion of the cattle enumerated are in Siberia. One must bear in mind that Siberia possesses numerous pastoral tribes, such as the Kirghese and Bashkirs of West Siberia, the Kalmycks and Buriats of Central Siberia. The sole subsistence of some of these people comes from their flocks and herds. The Kirghese are perhaps the nearest modern representative of the pastoral peoples of the Bible. While coming from the Lena in the fall of 1913 my automobile was stopped for some time to allow the passage of the herd of several hundred cattle from Mongolia, 1000 miles away, that were being driven to the river to be transported by barges a distance of another 1000 miles to Bodaibo, the centre of the Lena gold mining district.

The Lenskoi company, with which I happen to be

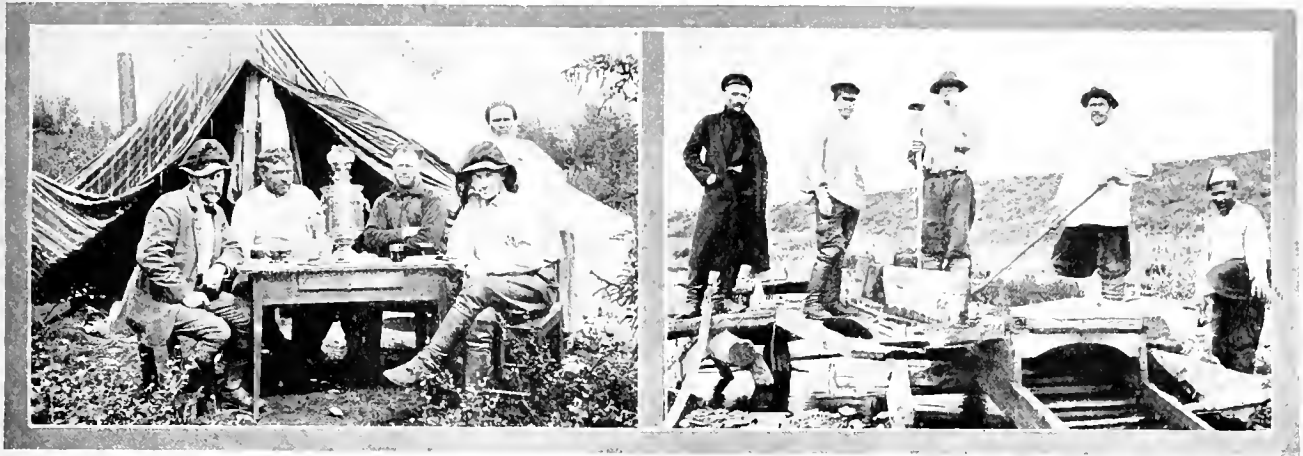

AROUND THE SAMOVAR.

ALLUVIAL MINING.

connected at the present time, operating 1000 miles north of the railway at Irkutsk, sells annually from 3 to 4 million pounds of beef to its workmen, about 7000 in number. This beef on the hoof comes by barges in summer to Bodaibo from Yakutsk, several hundred miles to the north, and in smaller quantity from Mongolia. It may be mentioned that frozen meat sells at Bodaibo at about 9 cents per pound in winter and fresh meat at 10c. in summer.

During the year 1907 and following I was engaged in conducting a small mining enterprise near Nikolaievsk on the Amur river. An average catch of 10,000,000 salmon of 10 lb. each is taken at this point annually. For 30 miles above and below the town on both banks of the river nets are extended across the water for about 1000 ft., and about September 1, when the short salmon-run is on, the river presents a lively sight. I have never been fortunate enough to be in town when the actual run happened, but it is said that the five-mile width of the river is transformed from the black water to a shining plate of silver from the flashing of the millions of salmon-backs.

Practically no canning is done; the fish are either bought by Japanese schooners, which bring their own salt from Hakodate, or frozen and shipped to Europe in refrigerator-steamers. Some 40 graceful Japanese boats lie at anchor off the town at this time, and several big freighters from Hull and Hamburg are near-by. Previous to the War I understand that cargoes of salt were even brought from Germany to Nikolaievsk, such was the demand for this commodity.

You will see by the map that Siberia possesses nearly 6000 miles of coast-line bordering the Pacific and its inland seas. This coast is comprised between the Korean boundary and Behring Strait. Many rivers, the Amur, the Ud, the Lantar, the Okhot, the Kamchatka, and the Anadir, and hundreds of small creeks and streams, debouch on this coast. Three of these exceed 1000 miles in length, and the Amur 2000. Salmon, sturgeon, porpoise, herring, and a multitude of other fish swarm in these waters. I have no need to tell New England men of the whaling industry of the Ochotsk sea, celebrated in New Bedford legends. But

if the whales are largely gone, the salmon are hardly touched and one may look for great canning industries eventually on the Ochotsk shore of Kamchatka, to say nothing of the herring fisheries of Chukotsk. But you will say that this is a frozen coast and useless. In this you will be entirely wrong. The coast extends from 42° to 67° north latitude, or, let us say, from the northern boundary of California to Behring Strait. Any house dealing in mining supplies will tell you that they will deliver 10-ton castings at Nome, in an open roadstead, by lighters through the surf during July, August, and September. There is no worse sea exposure in the world than Nome beach, surely nothing worse on the Siberian coast to which I have referred. So much for the northern end of it.

On the southern end you may walk through fields of poppies and tobacco, bordering the shore. You may pluck orchids amid groves of cork and black walnut trees. Within 30 miles of Vladivostok on the shores of American Bay, you may sit at night in camp listening to the droning of semi-tropical insects, and fascinated by the indescribable beauty of the glow-worm's lantern.

Russia's finest harbor on the Pacific, as yet practically undeveloped, lies 300 miles north of Vladivostok, namely Imperial. For the past six years the Oriental Timber Company of Australia has been shipping tamarack and spruce lumber to Australia from this harbor. Navigation the year round can easily be maintained from both Vladivostok and Imperial harbors. Men like Capt. Bartlett, who tells me that he would hesitate to take a cargo from San Francisco to the mouth of the Lena through the Behring Sea, would probably consider it a pleasant excursion to take a steamer from Boston to Vladivostok in the month of December. Mail service by the Russian boats, *Riazan* and *Simbirsk*, and the Japanese boat *Hozan Maru* is maintained all the year round in connection with the Trans-Siberian express, from Vladivostok to Tsuruga, in Japan. To say, therefore, that Siberia does not possess all-the-year-round ports is incorrect.

The Russian government, ordinarily a slowly-moving body, occasionally acts with unparalleled suddenness. It has recently done so. It has transformed a drink-

solden peasantry into a virile and watchful people. The flower of Russia is in Siberia. Its population of 30,000,000 is steadily increasing. It is always the experience that the best men and women go to the frontier. These people need your commodities, they need your saw mill machinery to cut their vast forests of tamarack, your Studebaker wagons, your motor-cars and motor lorries to get about and to haul their goods. Siberia with its 15,000 miles of navigable river-ways needs your flat steamers, and your steel plates for barges. Your machine-tools, your cement-making machinery, your ten thousand mechanical contrivances, your excavating and conveying machinery to dig ditches, to deepen rivers and harbors, to compete with hand labor in building automobile roads through the interminable forests. Siberia needs your concentrating machinery to work the lead and zinc ores of the Trans-Baikal, the Altai, and the vast low-grade copper deposits of the Sayan ranges on the border of Mongolia. Your rough and practical clothes for frontier life, rubber boots, leather boots and shoe-packs, your Levi Strauss overalls, your Mackinaw shirts, even your fur-coats, sleeping-bag, and reefers. Strange is it not? You cannot buy a decent fur-coat in Siberia, or a practical one for work. This, in Siberia the home of the bear, of the fox, and the millions of sheep and horses. Siberia has the furs, but she has not yet made the clothes. Absurd as it may seem, the only two American commodities, outside of agricultural machinery, in general use in eastern Siberia are Taylor's fly-paper and Carnation condensed cream. What has Siberia—in fact, what has the whole of the Russian Empire, to drop into the vernacular of the moment, been up against? She has been up against the German. And she has been up against the German good and hard. Russia was Germany's best commercial colony.

In my various trips through the Siberian communities I have frequently inspected small steam and electric installations, and have found the electric ones almost without exception of German manufacture, while the steam units are usually of the German locomobile type. In the city of Vladivostok a large and handsome building stands facing the harbor on one of the main streets. The entire building was occupied by a great electrical firm of Berlin. From this office the company directed not only the civil installations throughout the Primorsk or Coast province of Siberia, but also the principal electric installations of the Russian government. In order to install a 450-kw. American generator at Nikolaievsk in 1910, special permission was necessary from a firm of German manufacturers. Is this incident likely to be repeated? I think not. The building of that German company to which I refer is, I have no doubt, boarded up as tight as the German embassy at Petrograd and the German staff of the company are in safe-keeping until the close of the War.

I can give one example of the former use of German electric machinery by a gold-mining company using some 20 generators and over 100 electric motors for mining purposes in connection with five hydro-electric

plants that are almost exclusively of German manufacture. This company has now decided not to purchase another pound of German machinery of any shape or description. Centrifugal pumps, direct acting pumps, hoists, electric and steam industrial locomotives, excavating and conveying machinery are subject to the same comment. Fuse, caps, quicksilver, special steels, tools of all descriptions have been for years purchased by the Siberian gold-mining companies from Germany. The Russians say "Never again."

Let American manufacturers abandon now, once for all, the idea that they can sell any more machinery to Russia by means of German agents or German affiliations. Russia is finished with Germany, for a decade, and perhaps for longer.

In Vladivostok in 1908 I purchased a few tools that looked as if they were American: claw-hammers, railway-lanterns, monkey-wrenches, small jacks, etc. A superficial inspection showed that these were not of American manufacture, but imitations. They all proved almost worthless. These were the celebrated 'Hamburg seconds': remember that name, good enough for the Far East and for South America, where the American manufacturer does not penetrate but where his goods are in demand. The goods in this case were supposed to fool the Chinese, but in reality they proved useful as models by which I had similar tools made locally, roughly, but of good material.

In the eastern cities of Vladivostok, Habarovsk, Blagoveshensk, and Nikolaievsk on Amur, were the large department-stores of Kunst & Albers of Hamburg. This firm, possessing many Russian shareholders, was practically in the same commercial relations to the Russian Far East as the American trading companies to Alaska. The Rickmers line of steamers from Hamburg, and boats chartered by the firm itself, brought European goods every year to stock for the needs of the country. The firm maintained its own German club at Vladivostok. The stores are closed, the club is closed, the staff is in safe keeping. When the War is over the firm will be Russian in fact as well as in name, and will afford a market for American goods.

The Russian firm of Churin, which is the successor of that pioneer of Siberian trade, the Cape Cod merchant, Enoch Emery, has always been a powerful competitor of Kunst & Albers, but the management of the former was not so enterprising. The goods were of the rougher sort, and of good quality, for I have myself paid them many thousands of rubles on behalf of mining companies. But American goods they knew not, and apparently could not obtain. Few of the employees of this great Siberian firm, which has even stores at Anadir, opposite Cape Nome, could speak anything but Russian. Would that we had today in America more men of the type of Enoch Emery, that indefatigable pioneer, of the type of Captain Niebaum of San Francisco, and of the former New England traders of Petropavlovsk, hustlers who are willing to face the East and to learn its secrets, in place of that self-satisfied and small-scale individual whose

ideal of foreign commerce is limited to correspondence with foreign agents whose faces he has probably never seen, whose language he cannot speak, and of whose business methods he is ignorant.

The Keystone Driller Co., of Beaver Falls, the Allis-Chalmers Co. of Milwaukee, the Sullivan Machinery Co.,

cial arrangements of English houses have, however, been far inferior in Russia to those of German, Danish, French, and Swedish firms. But the England of after the War will be a far different one commercially from the England before the War, and she will offer a keen competition with America for Russian and Siberian business. Moreover, she has the inestimable advantage of possessing ships, which we have not.

At the National Convention for Foreign Trade held at St. Louis on January 21, John J. Arnold, vice-president of the First National Bank of Chicago, said that there should be an amendment to the Federal Reserve Law which would give the banks of the United States authority to use 5% of their capital stock in forming banks in foreign countries. In connection with this, Mr. Arnold spoke of the desirability of subscribing to loans issued in these countries. Not only the Government of Russia, but the municipalities of that country, such as Moscow, Kief, Ekaterinoslav, Baku, Harkof, Saratof, Odessa,



A SIBERIAN HORSE-WHIM.

and the Bucyrus Steam-Shovel Co. have, it is true, found a good agency at Petrograd, a Russian firm whose manager was for several years in America. But these agencies are difficult to find. The Singer Sewing Machine Co. is probably the most notable example of a firm that has established itself in Russia, and others that may be mentioned as having their own organizations are the Westinghouse Air Brake, the Eastman Kodak, and the Walkover Shoe companies.

Typewriters, phonographs, scales, office fixtures, small machinery, and supplies of all kinds of American origin are sold by agents, when they are sold at all. Competition is severe, and the European having his representatives in the country, his Russian office established, his banking correspondents close at hand who thoroughly understand the long credit system, and who are ready to make him advances, this European, I say, gets the business.

I would here say a word about England. England, like our own country, has been asleep. It is true she has banking arrangements with Russia, whereas we have none. I believe that her banks will greatly extend their operations in the Russian Empire after the present war, and long credits will be easy to arrange. The commer-

cities in the midst of a great agricultural district, in some of the finest coal and petroleum districts of the world, have issued loans of from one to five million dollars and even more which have been plentifully subscribed in London during the past five years. Even

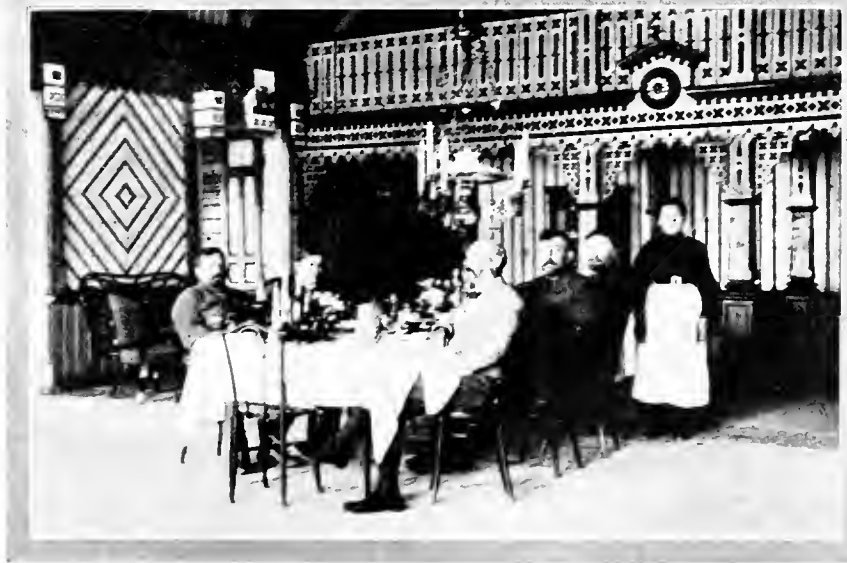

AT HEADQUARTERS.

these cities in the old part of Russia, must continue to build, and to extend railway, tramways, city improvements, water and drainage systems, and they will need foreign money. Why should not these loans be subscribed in New York and in Boston as well as in London?

Like the old Scotch lady who refused to show the conductor her ticket because she did not wish him to know where she was going, the American banker and the American merchant have apparently carried their caution of doing business with Russia to the extent of child-ishness. The credit of the Russian Empire needs no apology from me. The establishment of the Russian American Bank at Petrograd, with branches in the principal Russian and Siberian cities, offers one of the world's great banking opportunities, and would be of unquestionable assistance in the establishment of American trade on a permanent basis.

As regards stock exchange transactions, the Russian bourse labors under legal disadvantages, as official dealings are limited to Russian securities exclusively. I have, however, reason to believe that a change in these restrictions is under consideration, and one may look forward to the day when shares of international standing may be dealt in as freely at Petrograd as at London.

I have got rather away from Siberia, in trying to impress on you that you are not dealing, so far as getting your money from the Russians, with a frontier country, with a wilderness, not with wild men dressed in skins, but with a country far advanced in development and in finance, probably farther in what pertains to international finance and exchange than you are yourselves.

By the trade-routes that I have pointed out, it is likely that you can supply Eastern Siberia with commodities at a cheaper freight-rate than they can obtain them at Petrograd, Moscow, or from western Europe. The difference is that between a rail haul of at least 5000 miles and an ocean freight of not more than double the distance.

I have been responsible for the importation of some \$200,000 worth of American machinery into East Siberia, including gold dredges, machine-shop equipment, wagons, motor-vehicles, and boats, excavating machinery, wagons, harness, clothes, etc., and I am compelled to say that the knowledge possessed by American manufacturers of how to pack goods for foreign shipment, and their knowledge of foreign shipping routes and shipping rates is primitive in the extreme. There is a crying need in this country of school-courses, not only in Russian, Spanish, French, and German languages, but also to teach commercial geography, and the commercial methods used by our world competitors.

When I was a boy in Boston I used to take delight in frequenting an establishment known as the Windsor theatre, celebrated for the hair-raising dramas there performed. One of these, as I remember, was called 'In Darkest Siberia,' or words to that effect. I am afraid that most of us derived our impression of that country from the information afforded by similar productions. I cannot give you impressions of Siberian prisons, as I have never been in one, excepting one that I gave orders to have built to confine certain obstreperous workmen while they awaited the arrival of a steamer to take them to the nearest police-station. I have been at the Government mines in the Nerchinsk districts where convicts are

employed, and beyond a certain feebleness of activity, which would not be permitted on a privately-owned gold mine, I did not notice any special difference between the treatment of these men and of other laborers. This was a gold-gravel drift mine, where the convicts worked underground and most of the surface-men were Chinese. The most evident feature was apparently an understanding between the convicts and the Chinese business man on the hoist by which the latter purchased gold panned surreptitiously by the convicts in the drifts on the night-shift. The fact is that convict labor does not pay in Siberia, and although convicts are sometimes offered to the mine-owners at a normal wage by the Government, free miners are always preferred at a considerably higher wage.

Our good friend Kipling refers in the 'Rime of the Three Sealers' to Siberian "mines of mercury, that loose the teeth in yer jaw." If Mr. Kipling can find a quicksilver mine in Siberia and get an option on it, I shall be glad if he will communicate with me. But if Siberia has no quicksilver, so far as known, it has other metals in abundance, and it may be mentioned that the mining world is now looking to Siberia as perhaps the greatest untouched field for gold, for copper, lead, and zinc. Russia gives the copper miner a bounty of five cents per pound over the market price outside the Empire, and within a few years it is expected that the mines of the Ural and Southern Siberia will add a considerable quantity to the world's output of copper. The simple introduction of the process of pyritic smelting in the copper mines of the Ural by Americans has transferred unprofitable deposits into important producers. Deposits of the disseminated copper type and other low-grade deposits that can be mined in open-cuts by the steam-shovel are being investigated. Figure to yourselves a mineral-bearing mountain system with peaks up to 12,000 ft. in height, three times as long as the entire north and south extent of the states of Utah, Arizona, and Sonora, and you will get an idea of the extent of territory in the Alatau, Altai, and Sayan ranges of Siberia, which remain to be explored. That entire belt is mineral-bearing, with volcanic rock associations; and history shows that the base metals have been worked by primitive peoples throughout this backbone, so to speak, of Asia for a period commensurate with the age of the Buddhist religion.

THE RUSSIAN EMPIRE comprises one-seventh of the land area of the globe. Russia in Europe has 2,000,000 square miles, while Siberia exceeds 6,000,000 square miles, a total of over 8,000,000 as compared to the 3,025,600 square miles in the United States. The population of the Russian Empire is estimated at 170,000,000. The topography is that of great undulating plains, diversified by broad plateaus and mountain ranges. A number of large rivers drain the country, and there are extensive areas of fertile black soil, highly productive where tilled. There is an American consul at Vladivostok, and at a half-dozen cities in European Russia.

Smelting Flotation Concentrate

IN the November issue of *Tecnica Topica*, the monthly publication of the Braden Copper Co., Chile, a member of the staff briefly outlines the development of the smelter from 1909 to the present time. Metallurgical difficulties have been many, but were overcome, in spite of being 6000 miles from the base of supplies. The plant now treats 350 tons of concentrate daily, yielding 60 tons of copper, during which operation 60 tons of coke and 10 tons of fuel-oil are burned, employing 350 men and 1500 hp. This quantity of concentrate is recovered from 4000 tons of ore crushed per day. The concentrate consists of 19% copper, 17% silica, 23% iron, 2% lime, 8% alumina, and 28% sulphur. It is sandy and slimy, and contains 20% water. Of the 350 tons of concentrate, about 215 tons is dumped from V-shaped steel cars into bins, which supply the nodulizing kilns. This concentrate is then fed to conveyor-belts, thence into kilns, heated by oil-burners to a temperature of 1750°F. In the kilns, the sandy concentrate is quickly heated by the burning of the oil, and also by the combustion of a part of the sulphur content, to a sticky consistence, in which state the rolling motion tends to ball it into nodules of varying size. The kilns are sloped an inch per foot toward the discharge-end, out of which the red-hot nodules pour onto an endless chain of cast-iron pans, which convey the product to hoppers ready to charge into the blast-furnaces. The nodules have about the same chemical content as the original concentrate, except that the proportion of sulphur has been reduced from 28 to 18%, and, of course, the moisture has been evaporated.

A by-product of the nodulizers is flue-dust, that is, a small proportion of the concentrate blown out by the draft in the kilns and caught in dust-chambers, removed, and hauled to the bins for re-treatment.

Another 50 tons of the original concentrate is sent to bins that discharge to the sinter-plant, of four units. Each unit is a concrete box, 4 ft. wide by 50 ft. long. In place of a top there is a cast-iron grate similar to that of a stationary boiler, but with smaller air-holes. An exhaust-fan is connected to the box, creating a strong down-draft of air through the grate. A 4-in. layer of raw concentrate is spread on the grate with an inch layer of saw-dust ignited with kerosene or gas-line torches, after the fan has been started. The saw-dust starts the combustion of the sulphur in the concentrate. This then continues to roast for an hour, when the sulphur is reduced to 12% and the loose layers are reduced to hard cake. The cake is broken into pieces six to eight inches in diameter and raked into cars that go to the blast-furnaces.

The remaining 85 tons of concentrate received daily is discharged into bins, thence fed by conveyors into cars directly to the blast-furnaces; this amount being smelted

raw. Thus 62% is nodulized, 14% sintered, and 24% of the concentrate is reduced direct.

The two blast-furnaces are 25 and 30 ft. long, respectively, 4 ft. wide, and 9 ft. deep, with hollow-steel water-jackets. The furnaces are fed with a charge consisting of varying proportions of nodulized, sintered, and raw concentrates, together with converter-slag (containing 60% iron) as a flux, and coke as fuel. The proportion of coke to concentrates averages about 15%, and is dependent directly on the amount of raw and nodulized concentrates. This mixture gradually sinks in the furnace, becoming hotter and continually melting, until in the bottom it is liquid at a temperature of 2500°F., and runs into the settler. The matte, containing 45% copper, 30% iron, and 25% sulphur, remains in the settler until removed through a hole near the bottom and poured into the converters through a brick-lined launder.

The converters are of the Pierce-Smith basic-lined type. Each consists of a horizontal cylindrical sheet-steel shell 25 ft. long by 10 ft. diameter, inside of which is a lining 18 in. thick of magnesite brick. This material is not attacked by the chemical reactions in the converter, and consequently lasts for a long time, unless allowed to over-heat. The cylindrical converter-shell rests on heavy rollers, and can be revolved around its axis so as to empty its contents through a hole in the side when necessary. The converter is pierced by a horizontal row of blast-pipes through the steel shell and lining, for the entrance of compressed air. These holes are in a line parallel with the axis of the cylinder somewhat below the centre-line, and point down toward the bottom of the converter. A large hole in the top receives the charge of matte, and serves as a chimney for the escape of gases.

When ready to receive a charge, the converter is revolved until the mouth is under the end of the matte-launder leading from the settler mentioned; this position places the tuyeres at about the centre-line of the cylinder. A stream of matte is run by gravity into the mouth, until the converter is filled almost to the level of the tuyeres. There is also added a small amount of quartz. Compressed air at 10 to 12 lb. pressure is then forced through the tuyeres and the converter is revolved until the tuyeres are submerged about 12 in. under liquid matte.

The elimination of the iron and sulphur leaves practically pure copper as the only remaining constituent of the matte; after 12 hours of alternate blowing-in air and pouring-off slag a bath remains of 25 to 30 tons of molten copper. This goes into ladle-cars and is hauled to a receiver, which is simply a huge brick-lined kettle capable of lifting and pouring its contents into a line of moving cast-iron molds.

Queer Mine Accidents

By P. B. McDonald

In the MINING AND SCIENTIFIC PRESS of October 23, last a peculiar blasting accident was recorded in the Deadwood news letter. Three men in the Ore Hondo shaft had lit the fuses of a round of 15 holes, and climbed into the bucket. Owing to a delay in starting the hoist-engine which was on dead-centre one man became excited, jumped from the bucket, his light went out, and the bucket was hoisted. His companions missed him, and grabbed the bell-cord, giving the signal to stop; but the man in the shaft, not knowing that, started to climb the bell-cord, thus giving another signal which carried the bucket and two men to safety on the 1500-ft. level. Of course the bell-cord broke, leaving the man in the midst of 15 holes, loaded heavily and about to explode. Getting in a corner he barricaded himself with planks and heard eight of the holes fired; he says he heard no more until his companions dug him out intending to take his remains to the undertaker. Aside from a few slight bruises, and a nervous shock, he was not harmed and in a few days was as before. The fault, in this case, was carelessness in not having kept the ladder extended to the bottom of the shaft. A somewhat similar case occurred in a gold mine at Grass Valley. The hoist refused to work, leaving several miners in a shaft among a round of holes with lit fuses. All but one of the men tried to climb the timbered sides of the shaft. That one, with a praiseworthy coolness, cut all the fuses with his knife, and succeeded in beating the round.

In another instance in the Lake Superior iron region, during the sinking of a vertical shaft, the bucket had been removed to enable the cable to lower timbers, etc., held with a chain. On one occasion when the empty cable was being hoisted, a miner caught hold of it, foolishly thinking to ride up the shaft by hanging from the end of the chain. Of course the cable swayed so much that he was dashed against the timbers, killing him.

At the Tioga mine, Bodie, Mono county, California, in 1879, a man escaped death in a remarkable manner. The story as told by a prominent mining engineer of New York, and verified by the man who was his foreman at the time of the accident, is as follows: Nine men of the night shift were being lowered in the cage down a vertical shaft; contrary to orders the hoistman in the engine-room did not throw in the clutch of the hoist in advance, but began to lower the cage holding it merely by the brakes, probably intending to throw in the clutch later. The cage fell rapidly, so that the hoist-man could not stop it; the amount of friction he was able to give it only served to keep the cable taut so that the safety-catches did not work. In fact, it would have been better had the cable broken, as in that case the safety-catches would have caught and stopped the cage. The cage and men fell 520 ft., went through a bulkhead of 8-in. square timber, and dropped 20 ft. into a dry sump. Six of the men were killed, two were mangled and crippled,

so that they subsequently died of the injuries, but the ninth man in some miraculous way received only a few insignificant abrasions. When rescued he was speechless but not unconscious.

The same authorities vouch for the truth of the following equally marvelous escape. In early days on the Comstock Lode, a miner named Tom Oliver fell 170 ft. in the Yellow Jacket shaft, went through a 2-in. wooden platform into a sump of water, and was uninjured.

At a mine in Colorado, another engineer was being lowered in a bucket down a rough exploration shaft inclined at 75°. Ice had formed in the shaft, particularly on the peeled poles along which the bucket slid, to such a degree as to constrict the opening. The bucket caught and stopped, the cable piling up there. No one was within sight or hearing, and quick action was necessary. The engineer jumped out, clung to the timbers, kicked the bucket loose, slid down the rope into the bucket and rode on with nothing worse than torn hands. In a recent blast of 11 tons of powder at a gravel mine in Sierra county, California, the fume spread about so widely that four men were asphyxiated; and the smell of the fume was noticeable several miles away. Ten tons of the charge was black powder and one ton, the primer, was 40% dynamite.

Similarly a great many queer accidents take place around a mine; accidents in the hoisting, to engineers carrying transits underground, from electric trolley-wires, during roof-sealing, on ladders, in sumps, around steam, air and water lines, at loading-chutes, etc. Some are seemingly unavoidable, but others if better understood would not happen again.

MAX is a social animal; is he also essentially a gambling animal? Is it true, as many allege, that fewer things would be done, fewer things ventured upon, were it not for the gambling chance of profit? Speculation, gambling, is looked upon as the risking of a little on the chance of making much. Without such an incentive, it is often argued, enterprise would languish and material civilization would forthwith decline. Is all this so? Does not the argument arise from a confusion of ideas? The spirit of enterprise is not quite the same thing as the gambling spirit. Properly viewed, enterprise is not the risking of little to make much. It is something better than that. The man who lays down a dollar hoping that the turn of the wheel will give him a hundred is risking a little on the chance of making much—he is gambling. If he got the hundred he would have done nothing for it. The man who spends his little on some invention, who puts his all in some business venture, who prospects for gold—none of these is gambling in the real meaning of that word. All of these devote to their task their labor and their intelligence—man cannot give more. The gambler despises labor; he seeks only, if by chance he may, to divert to himself the fruits of the labor of others. The gambler in whatever field he operates is but a parasite; he need not delude himself into believing that he is a useful member of the community.—*The Annalist*.

Recent Patents

1,161,886.—REMOVING CADMIUM FROM ZINC ORE. Gilbert Rigg, Palmerton, Pa., assignor to The New Jersey Zinc Company, New York, N. Y., a corporation of New Jersey. Filed July 27, 1915.

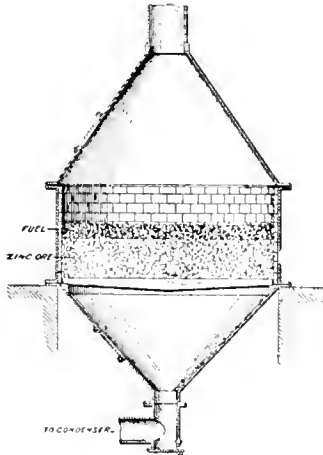

1. The method of removing cadmium from roasted or naturally oxidized zinc ore, which comprises superposing, the one upon the other, a layer of fuel and a layer of cadmium-containing zinc ore, igniting the fuel and passing a body of air through the fuel and then through the ore until the ore is raised to the reduction temperature of cadmium but not of zinc, and continuing the passage of air through the fuel and ore, for the removal of the cadmium, without substantial removal of the zinc; substantially as described.

1,160,621.—PROCESS OF SMELTING ORES. John H. Klepinger, Milo W. Krejci, and Charles R. Kuzell, Great Falls, Mont. Filed January 21, 1915.

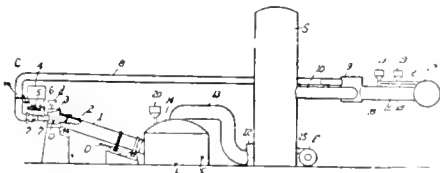

1. In the treatment of metallic oxides, the process of spraying a charge of the oxides in a finely divided state into a treatment chamber, surrounding the particles while in the chamber with a gaseous reducing medium, maintaining the temperature of the mixture in the chamber to effect a reduction of the oxides and a smelting of the metallic constituents of the charge while still in a finely divided state, precipitating the fused particles, causing the precipitated particles to advance under agitation and in the presence of a reducing medium to a suitable settling chamber, and finally removing the same from said last mentioned chamber.

ORE-SEPARATING PROCESS. Arthur J. Moxham, Wilmington, Delaware. Filed April 6, 1912, serial No. 689,038. Renewed January 22, 1915, serial No. 3836.

1. In the process of separating solid constituents of different specific gravities, first treating the solids by coating them with a definite percentage of material adapted to reduce the specific gravity of each of the solid constituents to a predetermined degree, and then immersing them in a liquid separating medium.

2. In the process of separating solid constituents of different specific gravities in a heavy liquid, first treating the solids to reduce the specific gravity of each of the solid constituents to the extent required to cause the separating liquid to have the desired specific gravity relative to the specific gravity of each of the solid constituents, and then effecting the separation of the solid constituents in such separating liquid.

1,160,550.—GOLD-SAVING MACHINE. John T. Voigt, Richmond Beach, Wash. Filed October 22, 1914.

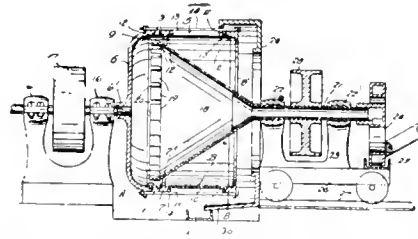

1. In apparatus of the class described, a drum rotatable on a horizontal axis and having intermediate its length a cylindrical portion formed of an amalgamable material and circumferentially unobstructed, said drum being closed at one end and with an opening at the other end of less diameter than the aforesaid cylindrical portion, and means extending into the open end of the drum adapted to feed auriferous material directly to the inner peripheral surface of the drum, said means being at all times unconnected with respect to the drum and removable therefrom for cleaning the interior of the drum while the same is rotating or otherwise.

1,166,142.—CALCINING, DESULFURIZING, AND AGGLOMERATING ORES. &C. Franz Meyer, Englewood, N. J., assignor to Dwight & Lloyd Metallurgical Company, New York, N. Y., a corporation of New Jersey. Filed November 9, 1907.

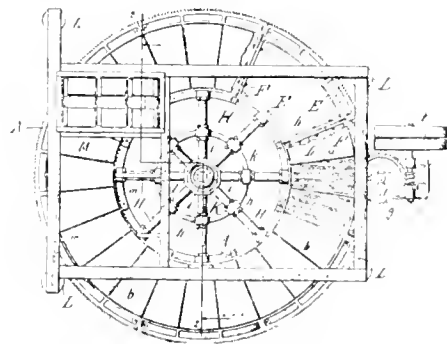

1. Apparatus for the metallurgical treatment of ores and the like, consisting of a receiving grate for supporting the charge, means for revolving the grate bodily about an upright axis, means for feeding the charge to the grate in a uniform layer, means for causing aeriform fluid to traverse the charge, and means for automatically removing the treated charge from the grate as it passes a predetermined point in the grate's revolution, said means consisting of a scraper located at said point and having a plow front which detaches the charge from the grate and a diverting abutment in the rear of the plow front; substantially as described.

1,166,067.—PROCESS FOR SEPARATING COBALT FROM ORES OR BY-PRODUCTS. Philip M. McKenna, Washington, D. C., assignor

to Chemical Products Company, Washington, D. C., a corporation of West Virginia. Filed September 25, 1914.

1. The process of separating cobalt from a spess containing the same, which consists in effecting fractionation by fusing the spess with boron trioxid.

2. The process of separating cobalt from a spess containing cobalt and nickel, which consists in fusing the spess and boron trioxid and causing the nickel arsenid spess to separate from the boric cobalt slag by reason of the difference in their specific gravity.

1,167,076.—ORE CONCENTRATING APPARATUS. Thomas A. Janney, Garfield, Utah. Filed August 10, 1914.

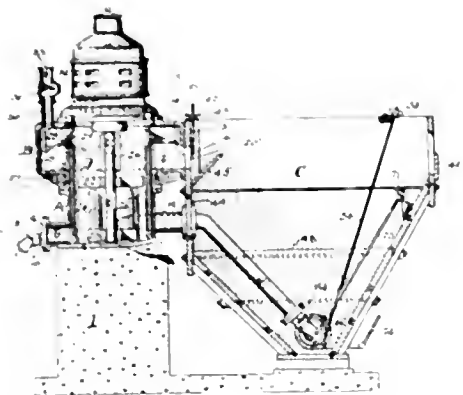

1. In a device of the class described, an agitation vessel, a separating box having admission and discharge chambers provided with admission and discharge ports respectively, admission chamber and discharge chamber circulation ports connecting said chambers respectively with the lower part of said agitation vessel, and means for moving an ore pulp upwardly in said vessel and into said box.

2. In a device of the class described, an agitation vessel, a separating box having admission and discharge chambers provided with admission and discharge ports respectively, admission chamber and discharge chamber circulation ports connecting said chambers respectively with the lower part of said agitation vessel, said separating box having an overflow lip, a duct connecting said vessel and box at a point above said overflow lip, and means for impelling an ore pulp upwardly in said vessel.

1,162,532.—METALLURGICAL FURNACE. Uley Wedge, Ardmore, Pa. Original application filed May 3, 1911, Serial No. 624,792. Divided and this application filed July 11, 1912; renewed July 1, 1915.

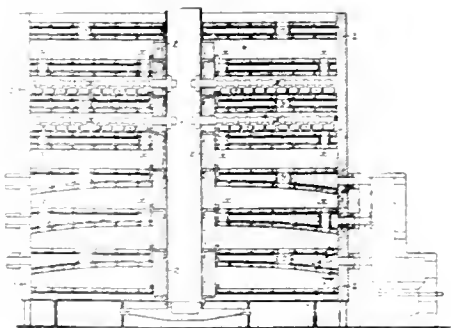

A furnace having superposed annular hearths some provided with discharge openings both at their inner and outer portions while alternate hearths are provided with discharge openings midway of the widths of the same, and a central rotating shaft having thereon rabble carrying arms projecting over the hearths, the rables on those arms which project over the

hearths having inner and outer discharge openings being so disposed as to move the material from the middle of the hearth toward the inner and outer portions of the same, and the rables over those hearths which have the openings midway of their widths being so disposed as to move the material from the inner and outer portions of the hearth toward the middle of the same.

1,163,341.—CONCENTRATOR. John F. Isbell, Los Angeles, Cal., assignor to Orren Allen, Denver, Colo. Filed September 8, 1913.

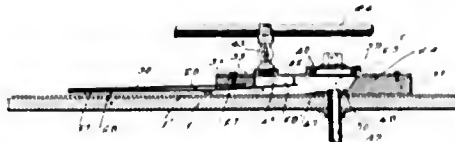

1. In a concentrator, the combination with a concentrator table, of a cut-out device thereon, comprising a casing with a chamber, discharge means leading from said chamber, said chamber having an inlet at one end, a horizontal separator plate extending forwardly from the inlet of said chamber to direct the material passing below said separator plate into said casing, a supplementary horizontal plate extending above said separator plate and spaced therefrom to serve as a guide for the fluid passing over said separator plate, side walls extending divergently rearward from said cut-out casing beneath said separator plate, and side walls extending divergently rearward beneath said supplementary plate and spaced from the casing to form passages between the said plates, the casing, and the said last named walls.

1,160,502.—ORE-JIG. Frank Franz and Eugene R. Day, Wallace, Idaho. Filed May 8, 1914.

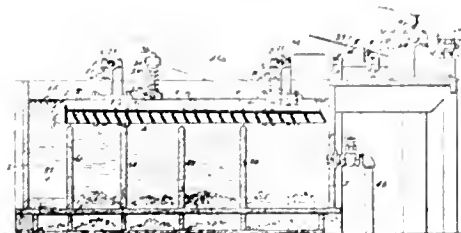

1. The combination with a clutch having a series of independent transverse compartments, a screen hung over the said compartments, the said screen being formed in sections of progressively different mesh, one of the said sections being provided for each of the said compartments, the said screen including slats on their under face that incline diagonally toward the receiving end of the screen, vibratory hanger devices from which the screen is suspended, and means for imparting reciprocating motion to the screen in a plane parallel with the diagonal angle of the screen slats.

1,165,692.—PROCESS OF EXTRACTING VANADIUM, URANIUM, AND RADIUM FROM ORES. Richard Bishop Moore, Denver, Colo. Filed October 7, 1913. (Dedicated to the public.)

1. The herein described process of extracting values from ores containing vanadium, uranium and radium, which consists in leaching the ore with a solution containing an alkali carbonate and an alkali hydrate, recovering vanadium from the solution, leaching the residue with an acid solution and recovering uranium and radium from the solution.

2. The herein described process of extracting values from ores containing vanadium, uranium and radium, which consists in leaching the ore with a solution containing sodium carbonate and sodium hydrate, recovering vanadium from the solution, leaching the residue with a hydrochloric acid solution, and recovering uranium and radium from the solution.

REVIEW OF MINING

As seen at the world's great mining centres by our own correspondents.

CRIPPLE CREEK, COLORADO

MILLS OPERATING AND OUTPUT.—DELMONICO, EL PASO, ISABELLA.

Only three treatment plants were in operation on low-grade ore in January, all of the other mills being closed on account of repairs, change in method of treatment, or experiments being conducted to determine the best way to extract the gold. The production in January, as reported by the mills and smelters, is as follows:

| Plant and location. | Tons. | Average value. | Gross value. |
|----------------------------------|--------|----------------|--------------|
| Smelters, Denver and Pueblo..... | 4,500 | \$55.00 | \$247,500 |
| Golden Cycle, Colorado City..... | 32,500 | 20.00 | 650,000 |
| Portland, Colorado City..... | 12,000 | 20.50 | 246,000 |
| Portland, Colorado City..... | 18,419 | 2.64 | 39,416 |
| Portland, Independence | 11,925 | 2.04 | 24,327 |
| Caley-Jerry Johnson | 450 | 4.00 | 1,800 |
| | 79,794 | \$15.15 | \$1,209,043 |

The Delmonico property, south-east from the Isabella, and west from the Victor mine, has been leased to Denver people for a long term of years. From the upper levels this property

A strike of rich ore is reported from No. 15 level of the Lee shaft of the Isabella. In three rounds of driving the content increased from 12 to 800 oz. per ton. The stock immediately responded to the reported discovery, and sold at a higher price than for many months.

JOPLIN, MISSOURI

SHORT LAND & DEVELOPMENT CO. PLANS CONSTRUCTION OF NEW MILLS.—WORK STARTS ON ADMIRALTY COMPANY'S LAND IN MIAMI DISTRICT.

In addition to important development already under way, the Short Land & Development Co. contemplates the construction of several large concentrating plants. Recently the company undertook the re-opening of the Pocahontas mine, on a 10-acre lease of the Margaret Murphy land, at Thomas station, north of Joplin, and large 'turn-ins,' aggregating 180 tons per week, are now being recorded from this property, which for more than a year had been idle due to a fire that broke out in drift timbering. The shaft, at the time of the fire, had to be sealed to prevent spreading of the flames. Water rose in the mine, and the pumping problem became so serious that work

was not resumed until the present company took charge several months ago. The name has now been changed to the Olive-Cherokee Mining Co., and an interesting feature of development is that present operations are in hard sheet-ground, at a depth of 200 ft., whereas previous work was all in very soft, timbering ground. A stratum, 100 ft. wide, 12 ft. high, and of undetermined length, is now being worked, and the recovery is from 9 to 10%. The mill has a capacity of 200 tons per shift of 10 hours.

On a 20-acre lease of the Madison Land & Leasing Co.'s property, immediately north of the Pocahontas, the Pennsylvania Lead & Zinc Co., one of the Short companies, has begun drilling and will drain the ground. It is planned to

do 3000 ft. of drilling, and construct a 250-ton concentrating plant on the site of the old Powhattan mill, which was removed soon after operations were suspended there following the shutting-down of the Pocahontas. A lease developed by the Short company several months ago will soon have a mill. This is a 40-acre lease of the James Luke land, adjoining the H & F mine, a producing property, north-east of Joplin. Four drill-holes show ore from 186 to 205 ft. in very soft ground, although operations on all sides are conducted in hard ground. R. E.

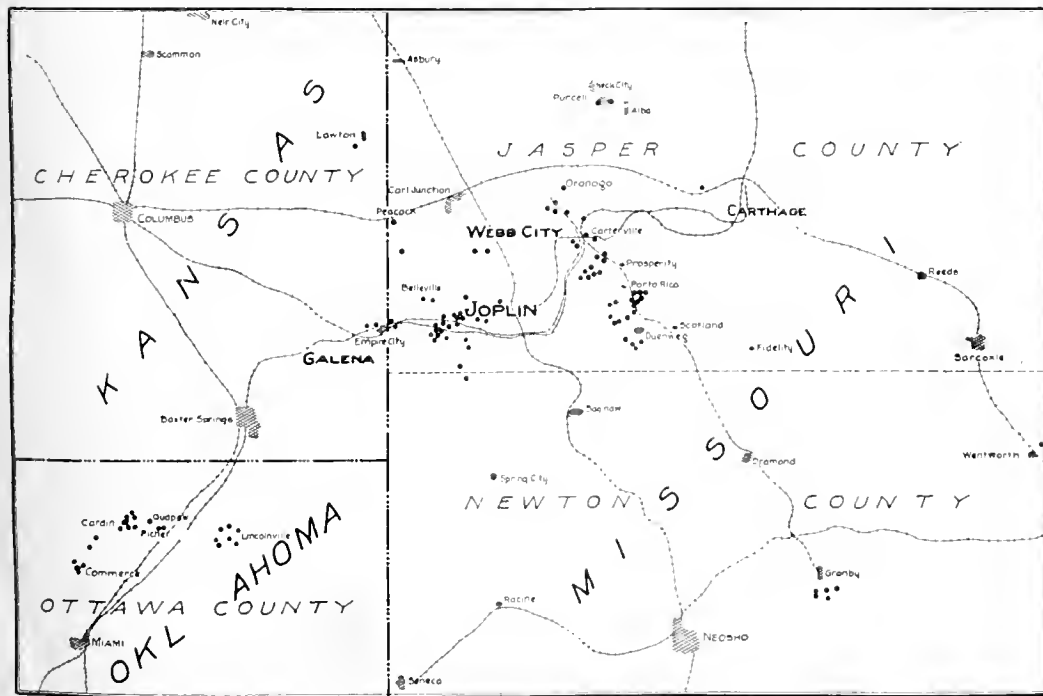

THE MISSOURI-KANSAS-OKLAHOMA ZINC REGION, SHOWING, ACCORDING TO THE *Joplin Globe*, THE MILLS (BLACK DOTS) NOW WORKING WHICH WERE NOT IN EXISTENCE OR WERE IDLE A YEAR AGO.

produced ore of good grade in the early days. At present the machinery is being overhauled. The Delmonico should be on the active producing list in the near future.

The quarterly report of H. McGarry, president of the El Paso Consolidated Gold Mining Co., shows that net earnings for the nine months beginning with April 1915 were \$35,673. The indebtedness of the company during this period has been reduced to \$2500. On January 1, 1916, there was \$8454 in the treasury.

Holt and H. A. Moore of Louisville, Kentucky, and Kansas City people are associated with the Short company in this development. A shaft is into ore, and driving has started. Work on the new plant of 200-ton capacity is to begin within a month. The largest mill contemplated by the company will have a capacity of 350 tons a shift, and will be situated on a 40-acre lease of the James Lake land, west of Joplin. The lease lies south of the Muskingum mine, which is a big producer, and north of the A. W. C. group of three mills with a fourth now under course of construction near the proposed new plant of the Short company. Two shafts are into ore, the extent of which has been fairly well blocked out in 14 drill-holes. The company has appropriated \$30,000 for development work and mill construction.

Foundations are in for two concentrating plants to be constructed by the Admiralty Zinc Co., five miles north-east of Miami, Oklahoma, in a district that only recently has sprung into prominence as a producing area. Mining will be conducted in a disseminated formation at a depth of 150 ft., although drilling has shown deeper ore. The mills will have a capacity of 250 tons each. They are situated near the Welsh Mining Co.'s plant, where new work is under way, and at which place a heavy flow of water is encountered below a depth of 180 ft. At the Welsh mine, pumps have been lifting 3500 gal. per minute for the past three months. Other new work in this district consists of plant construction at Picher, where two mills are now completed, a third is well under way, and a fourth has been started. The Blue Goose mine, some distance west of Picher is also a new property that is attracting attention because of the extreme richness of the ore now being milled. All these properties are on lands owned by Quapaw Indians, who usually receive 5% royalty.

The Warren Brewer Mining Co., on a lease of the Rex Mining & Smelting Co., in the east part of Joplin, has begun construction of a 100-ton concentrating plant on a lease that has been productive for some time. The poor custom-milling facilities in that part of the district necessitated the construction of the new plant. Drifts are heading into some good lead and zinc ore at a depth of 110 ft. Tarrant and Gill, also on the Rex land, are building a 50-ton plant to treat calamine that they are mining at a depth of 73 ft., and which they have been cleaning on hand-jigs. The new mill of the Little John Mining Co., on the Rex land, is nearing completion. It has a capacity of 150 tons.

D. D. Hewing has completed the construction of a 250-ton concentrating plant on a lease of the Zinc Corporation of Missouri property at Webb City, Missouri. Sheet-ore is mined from a depth of 220 ft. Two shafts will supply ore to the mill. Not far distant is the new plant of the National Lead & Zinc Co., now nearing completion.

AUSTIN, TEXAS

DIFFERENCE OF OPINION ON THE STATE MINING LAWS.

Precious metal, oil, and all other mineral substances that have been found on land sold by the State of Texas since 1882 belong to the Government of the commonwealth, according to the official decision of J. T. Robinson, state land commissioner. A contrary view is held by B. F. Looney, attorney-general, who in a recent opinion stated that it is only on land that had been classed, prior to sale, by the State land department as mineral-bearing that the minerals are reserved to the State. In western Texas much of the former public domain was classed as grazing and agricultural, and on parts of these areas, valuable minerals and oil have been discovered. If Mr. Robinson's opinion holds good, the resources that are found upon privately-owned lands revert to the State. In order to determine the controverted question a test-case is to be made in the Courts. The attitude of Mr. Robinson as to the State's reservation of minerals on all lands that formerly belonged to the public domain has been adhered to for many years, and has caused

the development of these resources to be greatly retarded. If Mr. Looney's interpretation of the law is upheld by the Courts, it will mean a large increase of mining and oil operations. It is stated that many men own land on which they have found minerals, but they do not care to make the fact public for the reason that the State would derive the benefit of the discovery, and the property would be open to filling by anybody.

ATLANTA, IDAHO

REVIVAL OF MINING AND MILLING IN AN OLD DISTRICT

Mining and metallurgical operations in this part of Idaho (Elmore county) show considerably more activity than a year ago. There are some notable old producers in the district; a year ago they were practically all idle. As a result of the active policy started, principally by the Boise-Rochester Mining Co., a revival has set in, and new life has been infused into the little town of Atlanta, the centre of business. Mining conditions are favorable, excepting transportation facilities. For six months of the year heavy traffic with outside points is suspended on account of the roads over the mountains becoming impassable. During the other six months freight charges are excessively high. A year ago an effort was made to construct a road along the river valley communicating with Boise, the nearest supply base. This road would have been available for any kind of traffic the whole year, and sufficient money was raised from various sources for its construction. As a result of bad judgment in laying it out, portions were subsequently carried away by floods and the communities and mining companies most interested continue to suffer complete isolation for at least half of the year. Considering the known and prospective resources of this region that is a state of things which should be rectified in the near future.

The Boise-Rochester company, with headquarters at Boise, of which Leo J. Falk is president, is the principal operating company. It recently took over the property and 49-stamp mill formerly owned by the Bagdad-Chase Gold Mining Co. Work was started on the claims in the fall of 1915, and is being advanced on an increasing scale as the winter advances. A Bleichert aerial tram, capable of carrying 120 tons in eight hours, now connects the lower workings of the mine with the mill. Recent development in the mine has opened a considerable quantity of ore worth from \$10 to \$20 per ton. At the present time 20 stamps are dropping continuously on this grade of ore. Under the former owner's management the method of extracting ore was by the caving system, but this proved unsuitable under the conditions prevailing, resulting in an excessive quantity of waste being mixed with the ore sent to the mill. The vein material is exceedingly soft and friable, and the country rock swells whenever it is left exposed. These conditions necessitate heavy timbering and continued working of the ground, and it was probably to avoid expenditure under these heads that the former system was adopted.

Another obstacle to successful operations heretofore was the difficulty of treatment. Amalgamation was followed by fine grinding, and an elaborate system of classification and concentration extracted a fairly high percentage of the bullion, but trouble was experienced in handling the concentrate. Transport charges preclude the shipment of anything but very high-grade product, and local treatment by roasting followed by cyanidation was only partly successful. An auxiliary plant has now been installed, and is ready to commence operations. In it the concentrate will be ground fine in tube-mills, agitated with cyanide solution in a Pachuca tank, and the gold precipitated from solution by zinc-dust. It is confidently anticipated that this treatment will be a complete commercial success, in which case it is intended to remodel the main plant with a vein treatment of the whole ore by a similar process. R. H. Richardson is superintendent.

The property of the Monarch Gold Mining Co., adjoining the Boise-Rochester on the west, is under lease. The lessees have been engaged during the late summer and fall treating the dump ore by fine grinding in Huntington mills, amalgamation, and concentration. A recent clean-up is reported to be satisfactory.

The Overlook Gold Mining Co. at Black Warrior, some 14 miles from Atlanta, is busy. Ten additional stamps were sent in while the roads were still open, and these are in course of erection. An aerial tram has also been erected. Mr. Work is superintendent.

LEADVILLE, COLORADO

RESULTS OF DREDGING IN THIS DISTRICT

The Derry Ranch Gold Dredging Co. has under lease 2000 acres of ground, known as the Derry ranch, which is situated 12 miles south of Leadville and in the Arkansas valley, at an altitude of about 10,000 ft. The ground was originally drilled by W. H. Radford, and about 150 acres has been proved to contain profitable gravel, and subsequent dredging is indicating that these estimated values are being exceeded by about 50%. The dredge has operated just two months and handled a total of 143,000 yards. However, the first 15,000 yards consisted of clay, with no gold, thereby reducing the actual gravel yardage to 128,000, from which was extracted \$69,291. Operating costs for this period amounted to \$6953, which is less than 5c. per yard for all the yardage handled. This working cost is claimed to be as low as any boat of the same size, especially when one considers that the local cost of electric power is rather high, 1.65c. per kw-hour. The ground is also difficult, containing many large boulders.

One thing that tended to keep the working cost down was the small amount of power consumed and it is interesting to note that the dredge only required on an average a total of about 155 hp., whereas formerly this dredge, when operating in Montana, required over 250 hp. The saving was caused by the re-modeling and re-designing, and the many changes made by the New York Engineering Co. with a view to reducing the power consumption and securing large yardage.

The dredge was shut-down on January 10, on account of the severe climatic conditions, which would have increased operating expenses unduly, and rather than do this, it was decided to wait until spring. The total cost for building the new hull and reconstructing the entire dredge was just about \$100,000, so that with one more month's operation, this amount of money will be won back, and the rest will be all velvet.

The good work done by this dredge is due largely to the efforts of Robert F. Lafferty, vice-president and general manager, who was formerly an Oroville dredge operator, and whose experience has stood him well in the management of this enterprise. A. C. Ludlum is the president and principal owner of the Derry Ranch Gold Dredging Co., as well as the sole owner of the New York Engineering Company.

After several months' shut-down the Castle View mine on Carbonate hill is being re-worked. A large quantity of 22% zinc carbonate is available, but a peculiar market made it

difficult to secure a contract. This has been arranged, and the output is 50 tons per day.

ATOLIA, CALIFORNIA

LATEST FROM THE TUNGSTEN REGION

Notwithstanding the fire which destroyed the new mill of the Atolia Mining Co. on January 25, causing a temporary suspension of nearly all mining operations by that company, work has been resumed, and the old Huntington mill is again crushing night and day. There has been a resumption of work in the mines, relieving the situation. Already the frame-work, super-structure, and roof-timbers are in position for another and much better mill than the one destroyed.

Production of scheelite is increasing from lessees and operators of claims that adjoin the Atolia company's property. Most of this product is derived from placer ground. A number of discoveries of scheelite in quartz are reported from the west slope of the Rand mountains. On the road between Atolia and Randsburg, the main gulch is cut-up by placer workers with every manner of contrivance, both wet and dry.



DREDGING NEAR LEADVILLE, COLORADO.

for saving the gold, tungsten, and black-sand concentrates.

There are ten ore-buyers here who take ore from 2% WO₃ up. The ruling prices are \$2 to \$2.50 per pound cash on the ground, or about double that if money is not available until returns come from shipments outside. High-grading continues, as detection and conviction are difficult.

WASHINGTON, D. C.

PROGRESS OF THE MINING LAW BILL.

Legislation in Congress on the codification of the mining laws has simmered down to the point that it is to be done, not by a commission, as mining men had hoped and proposed, but by a sub-committee of the committee on mines and mining of the House of Representatives. Action to that effect has been taken by the committee, which, at a recent meeting by the close vote of seven to six, decided not to report on any of the bills before the committee on the codification. The bills were those of Representative Taylor of Colorado and that of Senator Smoot of Utah, which latter had come to the House on being passed by the Senate, where there had been no opposition whatever. The committee at the same time voted to have the revision and codification done in the committee itself, by a sub-committee composed of its own members.

THE MINING SUMMARY

The news of the week as told by our special correspondents and compiled from the local press.

ALASKA

CHILKATAGU

The Chiklagof Mining Co. is installing a flotation plant in its 20-stamp mill and concentrator.

COPIVOK

According to George W. Sias of Boston, the Valdez Creek Placer Mines Co. will spend \$125,000 this year for supplies and equipment. This includes 139 tons of Bonery steel pipes for 1400 ft., 1000 ft. of 15-in. and 1000 ft. of 18-in. pipe and fittings, derrick and boom with hoist and motor, and 100 No. 6 double jointed, ball-bearing giants with nozzles and deflectors. Supplies already purchased at Seattle are on their way to the property. The new equipment should be erected by May 20 when there will be plenty of water for starting. Two Pelton wheels will drive a generator for power, saws, etc., while an Ingersoll-Rand compressor will supply air for the jackhammers. A Keystone drill is used for prospecting. The company's property covers 5000 acres. It will be an important producer this season. The new Government railroad will go through Broad Pass, 30 miles from Valdez creek. The ditch for water-supply is 6200 ft. long, 8 ft. wide at the bottom, 15 ft. at the top, and 3 ft. deep. The main pipe is 1000 ft. long, with a 5-ft. intake, and branches 1000 ft. long. In the season of 100 days a profit of between \$200,000 and \$200,000 is expected from \$1 gravel. Pierre Bouery, for 15 years at the Lagrange mine, California, is manager.

In connection with the supplies mentioned above, it may be stated that they are paid for, the freight paid for, and 40 horses, 68 bol-steds, and 20 men are almost at the property with about 450 tons of freight.

FAIRBANKS

If the work proposed, and that being started on Goldstream, is continued, that area will be very busy next season, there being more plants than during last year.

JUNEAU

Juneau has been suffering from storms and cold weather, but little damage is reported.

December returns of the mines on Douglas island are as follows:

| | Alaska Mexican. | Alaska Treadwell | Alaska United. |
|-------------------|--------------------|---------------------|-------------------|
| Stamps dropping | 120 | 540 | 300 |
| Ore crushed, tons | 19,425 | 80,693 | 28,510 |
| Gold yield | \$29,750 | \$141,866 | \$91,881 |
| Average per ton | 1.53 | 1.76 | 1.90 |
| Expenses | 25,931 | 6,112 | 70,666 |
| Construction | 19,728 | 19,476 | 24,310 |
| Profit | | \$30,859 | |
| Loss | \$7,207 | | \$4,014 |

A certain amount of development was done by the companies for one another in accordance with the general scheme of operations.

The owner of the Jersey City claim, M. J. O'Connor, states that his property, under option to the Alaska Treadwell two years ago, is almost bonded to an Eastern syndicate.

In the suit of certain bondholders of the Alaska-Ebner Gold Mines Co. v. the United States Smelting, Refining & Mining Exploration Co. and others, Judge J. M. Mayer in the

Federal District Court of New York decided that the deposit agreements made on June 30 and December 30, 1913, complained of as usurious, are void. Certain shares of the bondholders' committee are subject to a lien of defendants of \$170,072, but the latter must not sell them until given permission by the Court.

ARIZONA

COCHISE COUNTY

During 1915 the Copper Queen properties produced about 771,000 tons of ore, yielding 83,000,000 lb. copper, exclusive of lessees' and other supplies. Development amounted to 70,013 ft. There has been an increase in the sulphide content of the ores, resulting in changes at the smelter. Pyrite smelting tests are under way. Churn-drilling on Sacramento hill added considerably to the oxidized reserves; more is to be done. Increased efficiency underground is reported by the use of different rounds in different ground, better stemming, and water-drills. Steel-sharpening charges were reduced in the central plant. At the Sacramento shaft 350 ft. of concreting was accomplished from October 1 to December 31. Fifteen sets of lessees are at work. Larger fans greatly improved ventilation. The safety-first department is satisfied with the year's accident results.

From the Shattuck the daily output is 150 tons of copper ore, and 100 tons of lead ore; these go to Douglas and El Paso respectively. Development generally is very satisfactory. At 200 ft. depth is high-grade silver-lead ore; at 300 ft. rich copper glance; and at 600 ft., 2% vanadium and some lead ore.

GHA COUNTY

During 1915 the Globe-Miami district's production of copper was approximately as follows, in pounds:

| | |
|--------------------|------------|
| Miami | 12,000,000 |
| Old Dominion | 27,731,272 |
| Inspiration | 22,000,000 |
| Arizona Commercial | 3,500,000 |
| Iron Cap | 1,436,000 |
| Warrior | 3,800,000 |
| Gibson | 1,200,000 |
| Superior & Boston | 550,000 |
| Other sources | 200,000 |

Total 102,417,272

All these mines had busy periods with splendid results. The new Inspiration mill gradually came into commission, while the International smelter was completed late in May. It produced 51,718,845 lb. of copper, 31,912,916 lb. from the Miami, 18,783,450 lb. from the Inspiration, the remainder from custom ores. The district is expected to make a much larger output in 1916, largely from the completed Inspiration mill and the many lessees and small syndicates extracting ore.

GREENLEE COUNTY

In discussing the late strike, *The Copper Era* of Clifton makes the following remarks:

"After a loss of approximately \$2,000,000 in wages to the employees, to say nothing of the heavy losses sustained by the mining companies, the unauthorized strike in this district called by Guy E. Miller, organizer of the Western Federation of Miners, is at an end. By an almost unanimous vote of the

men involved, a decision was reached on January 24 to return to work on the proposition submitted by the mine managers on the 8th through Henry Hill and R. R. Webster of Clifton, who for the past two weeks have been acting as mediators. In their efforts to secure an acceptance by the men of the proposition the mediators have received the assistance of the Sheriff, local labor leaders, and the Federal investigators, and to all of those who assisted in bringing about the termination of the deplorable conditions, which have existed in this district for the past four months, the thanks of the community at large is due. Lack of financial support from labor organizations throughout the country played an important part in the termination of the strike. It became known towards the end of the struggle that Guy Miller never was authorized to start a strike in this district. In this particular the strike was illegal, and was not recognized as entitled to support through assessments, although the strikers received liberal contributions from various parts of Arizona, notably from Miami. The strike is over and everybody is happy. The *Era* believes in letting the dead bury its dead. This is not a time for re-cremations on either side, and we believe good for all concerned will be the outgrowth of the disturbed conditions through which we have just passed, and that we are now entering upon an era of better feeling and general prosperity than ever known before in the Clifton-Morenci district."

MOHAVE COUNTY

After two years' idleness the Frisco Gold Mines, 24 miles west of Kingman, in the Union Pass district, has resumed work in charge of S. Brethour. A 50-ton mill was previously operated. Finances were the cause of shutting-down.

At a depth of 665 ft. in the United Eastern the cross-cut has opened the vein, where it is of high value.

The following remarks were made by J. K. Turner of Goldfield, Nevada, concerning the Oatman region:

"The district is vastly greater than Goldfield, where all the area of attractive production was included within 250 acres. In the Tom Reed-Gold Road district there is a margin of two miles from the Times group, where ore was recently encountered, to a point west of the Tom Reed, where all development is encouraging. There are more than a dozen properties in the district which should make good, in addition to those that have already been mentioned. Their success is based, of course, on efficient management and continued development. Along the central or main vein it probably will be necessary to go to a depth of from 400 to 500 ft., but there has been more erosion in the southern section, and here the gold may be expected much nearer the surface."

The Tom Reed-United Eastern merger has fallen through.

The Chloride district is considered, by people who have recently been there, to be worthy of the interest of capital. Some good mines are already large producers.

CALIFORNIA

AMADOR COUNTY

It is definitely announced that the old Eureka mine at Sutter Creek has been sold by Mrs. Hettie Green to a strong group of mining men. The transfer was made formally in San Francisco on February 7. The consummation of this important business is due to the initiative and energy of T. Walter Beam, of Denver, who has been working on it since 1912. The new management consists of Mr. Beam as president and general manager, J. B. Mackie as vice-president, and Frank Swed as secretary. The board of directors includes the three foregoing, together with J. C. Gorrie and John B. Farish. Mr. Beam is proceeding to Sutter Creek to commence the work of rehabilitation and equipment. A suitable plant will be erected at once, including new shaft-house and hoisting-engine, mill, and tramway. In regard to the sale-price, the actual figure is not known, but it is over \$500,000. The deal has

created a great deal of interest, for it indicates the confidence shown in the productiveness of this part of the Mother Lode.

CALAVERAS COUNTY

(Special Correspondence.)—The Royal Gold Mines Co., operating the Royal mines, is now treating 140 tons of ore daily, and employs 100 men. The managing director, F. N. Page, is now planning to make important changes. Twenty of the present 50 stamps will be taken out, and re-grinding machines for fine grinding used in their place. Oil flotation will take the place of present tables and vanners. It is also expected that some process—cyanidation or chlorination—will treat the concentrate on the ground, and avoid the present shipment to smelters.

Hodson, February 1.

The new 350-ton mill of the Calaveras Copper Co. is expected to be ready within 60 days. Flotation will be part of the process. According to F. W. Royer ore reserves available at once amount to 149,220 tons, averaging 3% copper, also 151,200 tons of a lower grade; this is down to No. 6 level. Some good ore is said to have been opened on No. 10 level. Crude ore and concentrate was shipped during 1915, paying for many expenses. The finances are now being re-arranged.

ELDORADO COUNTY

A nugget worth \$590 was found last week in the well-known Jones pocket-mine, five miles south of Placerville. A good deal of development has been done, and a two-stamp mill is kept busy.

SIERRA COUNTY

(Special Correspondence.)—The vein on the 200-ft. level of the Monarch Con. has been opened for over 300 ft. by the west drift. It averages seven feet in width and is of milling grade. The shaft is to be deepened to 400 ft., and a main working adit will be driven later. Twenty stamps are dropping, with most of the ore coming from the 200-ft. level. A rock-crusher and other machinery is being installed. Forty men are on the pay-roll. Tailing is being stored in a recently constructed pond for future treatment. At the Cleveland mine, controlled by the same people, shaft-sinking has reached 350 ft., and is progressing rapidly. The 10-stamp mill is working one shift. An Ingersoll-Rand compressor is being installed to facilitate more rapid shaft work. Twenty-five men are employed. Dan McGonigal is manager of both mines.

Ore averaging \$10 per ton is going through the Keystone mill, which is running one shift per day; 10 stamps are dropping. Mine developments continue to open fair-grade ore. The property is operated on a lease by Bigelow and Gilbreath.

Snow-slides have caused some damage in this district, but many of the reports recently published have been grossly exaggerated. The Phoenix mill has not been damaged, although recent reports were to the effect that the plant had been swept into the canyon. Repairs to the Sierra Butte mill will be made as soon as weather conditions allow.

Sierra City, February 7.

SISKIYOU COUNTY

Yreka people expect that the coming season will be a busy one for this county, as many engineers have been examining properties. The copper mines on the Klamath river and Clear creek will continue their work. On Greenhorn creek the El Oro Dredging Co. moved 994,742 cu. yd. in 16 months. The ground is somewhat difficult to dig.

TRINITY COUNTY

A long adit, to open the orebody at a vertical depth of 900 ft., has been started at the Golden Jubilee, near Carrville. A large treatment-plant is to be erected. Other properties in this and the Trinity Center district are preparing to resume work in the spring.

COLORADO

CLEAR CREEK COUNTY

(Special Correspondence) The property of the Dorle Trust Ltd. of London, situated on Saxon mountain, just below the depot at Georgetown, will pass to the Ruler Mining Co. on April 1, negotiations for transfer are nearly complete. The Dorle adit has been driven 3009 ft., and it is proposed to extend it to intersect at depth the mines in what is known as the Highland Park section.

Six inches of ore containing 18 oz. gold per ton has been opened for a length of 35 ft. in the Crockett vein, just above Idaho Springs. A shipment of 15 tons was made last week.

The Argo mill has resumed work after a 10 days' shut-down to permit installing a flotation annex. It is reported that a high recovery is being made on the by-products, consisting of silver, zinc, and copper. J. A. Pearce is superintendent.

Large shipments are being made from the Comstock mine on Seaton mountain to the Combination mill. The product is low grade.

Idaho Springs, January 24.

LAKE COUNTY (LEADVILLE)

Higher prices for silver have stimulated ore extraction at several properties.

The Penrose shaft pumps gained eight feet last week. At 750 ft. a drift connects the shaft with the Star workings, which hold a large quantity of water. In the General Electric Review for February, W. H. Horton, Jr., describes the un-

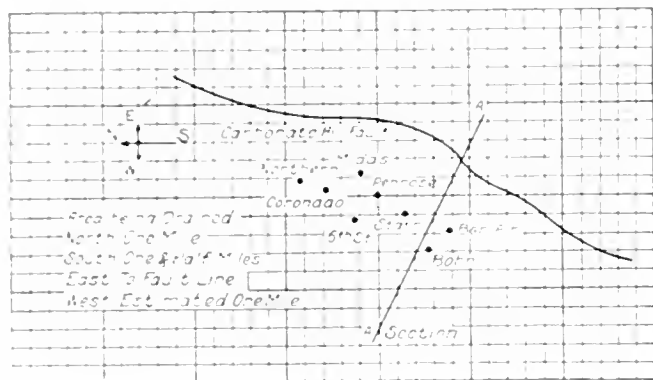

SKETCH OF THE DRAINAGE-AREA OF THE DOWN TOWN DISTRICT, SHOWING THE RELATIVE POSITION OF THE VARIOUS SHALTS LOCATED THEREIN.

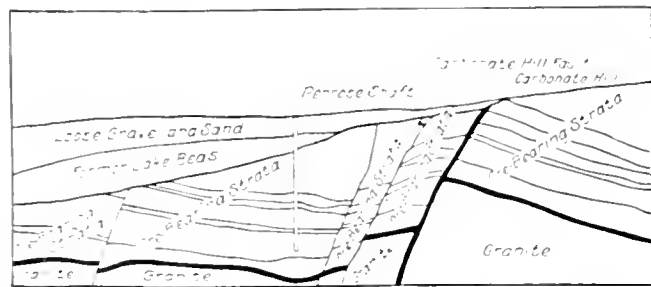

CROSS-SECTION OF THE DRAINAGE-AREA OF THE DOWN TOWN DISTRICT.

watering of the Down Town district in an interesting and well-illustrated article, from which the accompanying plans are taken. Considerable space is given to notes on the pumps and motors, especially comparing the cost of operation with the old steam-plant, and the modern motor-driven centrifugal pumps, showing a marked decrease in cost of installation and operation.

Owing to what is suspected to be 'surges' in the power supply to the Penrose shaft pump motors, the coils of the machines are burning out occasionally, resulting in delays.

Prospecting for manganese ores is under way on Carbonate and Treece hills.

The Anderson adit is in 1300 ft. in Prospect mountain in hard rock, a mixture of white porphyry and quartz.

The First National mine in Iowa gulch, where good bodies of lead-silver ore and zinc carbonate are said to exist, is being unwatered.

The Fortune mine in Evans gulch is sending gold-silver-copper ore to the Salida smelter; this comes through the Yak tunnel. Zinc carbonate has been developed also.

From the Gordon-Tiger mine at Twin Lakes to its 100-ton mill a new tramway has been constructed.

OURAY COUNTY

During December the Camp Bird mine produced 2468 tons of ore with a profit of \$43,000.

IDAHO

SHOSHONE COUNTY (COLEER D'ALENS)

The following announcement has been posted at Kellogg:

"To all employees of the Bunker Hill & Sullivan Mining & Concentrating Co., Caledonia Mining Co., Sierra Nevada Consolidated Mining Co., and Ontario Mining Co.: Hereafter when lead is 5c. per lb., or higher, a profit-sharing bonus will be paid in addition to the regular or minimum scale of wages, as follows: 25c. per shift when lead is 5c. per lb. and under 5.5c. per lb., 50c. per shift when lead is 5.5c. per lb. and under 6c. per lb., 75c. per shift when lead is 6c. per lb. and over. The price of lead applying to be the average New York price for the preceding month. During January, 1916, the average New York price of lead was 5.81c. per lb. and accordingly for February, 1916, a bonus of 50c. per shift will be paid all employees, and subsequent months in the same manner. When the average price of lead at New York is less than 5c. per lb. no bonus will be paid, and the regular scale applied."

Development at the Hypotheek has been so good that a mill is contemplated. At 1100 ft. depth a two-foot shoot assays 80% lead.

During December the Caledonia mine produced 197 tons of shipping ore and 961 tons of concentrate, valued at \$125,482, the latter product from 3764 tons of ore. This yielded a profit of \$79,973. In 1915 the company's output was 15,001 tons of ore containing 11,344,000 lb. lead, 1,212,730 oz. silver, and 659,660 lb. copper, worth \$1,216,860. The profit from this was \$766,324. According to the manager, Charles McKinnis, there is enough ore developed to operate for three years at the present capacity. Sixty-five men are employed. A car, 39 tons, of ore on January 7, gave \$6832 net.

The town of Wallace is to pave certain streets at a cost of \$120,000.

MICHIGAN

THE COPPER COUNTRY

The first of five shafts is being sunk at the White Pine Extension. Some of the machinery has arrived. At 200 ft. a short cross-cut will be driven to the lode, which will then be opened. Some drilling is being done, two miles from this shaft. Diamond-drilling is nearly complete on the property. A number of buildings have been erected. In the spring a 100-ton mill may be built.

The Isle Royale three-stamp mill is crushing up to 2200 tons of ore daily, the largest recorded. An interest has been acquired in the Point Mills plant, so that the daily output can be increased to 3000 tons.

All of the Champion tailing is to be re-ground, and more Wilfley tables installed. Manganese-steel balls are used in the Hardinge mills. The Baltic and Trimountain tables will be added to later on. A turbo-generator, taking exhaust steam from the Champion stamps, will drive all the re-grinding plants of the Copper Range companies.

The ore railroads are preparing for a busy summer, and

new cars and equipment are being made for the Mineral Range, Copper Range, Calumet & Hecla, and other lines.

Improvements to the Mohawk and Wolverine mill at Gay will not be started until spring. The Wolverine produced 7,194,015 lb. copper in 1915, a fair increase. The average yield was 17.79 lb. per ton.

The Champion company has declared \$2 per share, making \$5 for the current year.

MISSOURI

JASPER COUNTY

What is thought to be a record zinc-content in concentrate is reported from the 1915 company's Missouri Standard mine at Klondike, a carload recently assaying 64.70% metal. Pure blende contains 66.66% zinc. This company also had a record settlement for concentrate at \$139.90 per ton.

The Granby district is mainly a calamine producer, but the Golden Rule company recently sold 700 tons of blende at a base price of \$105 per ton, the largest sale, in value, for that district.

The National Lead & Zinc Co. is increasing its output from the Googie and Lucky Tom mines; its new mill is nearly complete.

Twenty-five tons of high-grade concentrate daily is the Bradley Lead & Zinc Co.'s output from the A. B. C. ground at Chitwood. At its Lincolnville property another mill will soon be working.

Owing to a fire that destroyed the bag-house of the Galena smelter, an old smelter at Webb City has been re-started. The Picher Lead Co. owns both plants, also a large one at Joplin. The Galena plant will be repaired.

MONTANA

GRANITE COUNTY

After being idle for many years, the Montana-Frisco mine at Tower is to be unwatered. Prospects are considered good.

JEFFERSON COUNTY

The Boston & Corbin company has resumed work at its Bertha mine, one mile from Corbin. Previous work was unprofitable with low copper prices, and the mill did not recover a high percentage. The mine has to be unwatered first.

LINCOLN COUNTY

The Snowstorm Mining Co. of Idaho has acquired the Banner and Bangle lead-zinc mine near Troy, from the Greenough estate. Leo Greenough is manager of the Snowstorm. The 250-ton copper mill at Larson, Idaho, will be moved to Troy in March. Few changes will be required in treating the new ore. The Banner and Bangle is already employing 200 men.

SILVERBOW COUNTY

Owing to ore freezing in storage-bins at Butte mines, blasting had to be resorted to last week.

After completing work between 1700 and 1900 ft., work has been resumed at 1400, 1500, and 1700 ft. in the Davis-Daly. A new hoist, costing \$50,000, has been ordered. The company has \$5000 cash at Butte, and \$20,000 due on ores sent to the smelter.

Butte & Superior is employing 1850 men, the pay-roll in January being \$240,000.

NEVADA

ESMERALDA COUNTY

The estimated production of the Goldfield Consolidated company for January is as follows:

| | |
|--------------------|-----------|
| Ore mined, tons | 31,000 |
| Gross extraction | \$209,000 |
| Operating expenses | 149,000 |
| Net realization | 60,000 |

Stopping at 1580 ft. in the Atlanta shows considerable improvement and 4½ ft. of ore now assays \$158 per ton, mostly in copper, so that it must be sent to the smelter.

Copper produced by the Jumbo Extension in 1915 amounted to 1,259,388 lb., from 22,562 tons of ore, which also contained 39,480 oz. gold and 99,459 oz. silver. The mine is in fine condition, yielding 100 tons daily.

HUMBOLDT COUNTY

At the St. Anthony tungsten mill at Toy, 18 miles southwest of Lovelock, new rolls have been installed. The daily output is 50 tons of ore. A wide vein is being opened down to 100 ft. depth, averaging 4% WO₃. Fifty-five men are employed in the mine, mill, and transport.

Owing to deep snow the Nevada Packard company is having difficulty in hauling its bullion between the mill and the Nevada Short Line, a distance of four miles occupying seven hours. The town of Packard, about ¾-mile from the mine and mill, and inhabited exclusively by employees of the company, is the only mining camp in Nevada that has no saloon. Neither are there dance-halls or other places of ill-repute. Gambling is not tolerated. The town has a population of almost 100 men, women, and children. It is electric lighted, and has water from the mountains piped to each house. It is the intention of the company to build a club-house for its employees. It will be placed under the immediate control of the men, and the profits will be divided among them in ratio to the length of service. During the recent storms Packard was isolated for about two weeks, and fuel was brought in with much difficulty from Lovelock, just as the last had been consumed.

MINERAL COUNTY

Renewed activity is reported from the quicksilver deposits east of Mina. A furnace has been ordered for the Pepper and Keough mine, and one is contemplated for the Red Devil.

NYE COUNTY

Eight mines at Tonopah last week produced a total of 8445 tons of ore worth \$177,270.—Raise No. 5 above 800 ft. in the Belmont is up 106 ft. in 4 ft. of rich ore; this is considered of importance. Work generally on this level is highly satisfactory.—None of the other mines have anything new to chronicle, save that development continues as good as desired.—Lessees at the Montana are extracting good ore for the West End mill.

WHITE PINE COUNTY

In its statement to the county assessor, the Nevada Consolidated announced that during the last quarter of 1915 it mined 831,944 tons of ore yielding \$3,904,890. This gave \$1,837,022 net, on which the tax was \$26,271. The Giroux, whose ore is treated by the Nevada Con., mined 22,027 tons, for a profit of \$23,158. The tax was \$3312.

The Aurum district promises to have an active season when the snow clears; many minerals occur there.

NEW MEXICO

SANTA FE COUNTY

During seven months ended December 31, 1915, the Santa Fe Gold & Copper Mining Co. produced 3,376,246 lb. matte, assaying 51.75% copper, containing 2104 oz. gold, and 24,579 oz. silver. The profit was \$141,430, against a loss of \$279,592 in 1914.

OKLAHOMA

OTTAWA COUNTY

Near Commerce the Acme Mining & Development Co. controlled by W. S. Pate of Joplin, has leases on 2000 acres of land, which is to be drilled and sub-leased. The Leolla and Henderson lead and zinc companies, under the same control, are to drill, and the former will erect a mill.

UTAH

BEAVER COUNTY

(Special Correspondence) The Beaver Gold and Silver Co. reports that it is negotiating with Los Angeles people for a sale of its property.

At the Whalen lease, the Davis lease vein has been opened in an adit at 60 ft. depth. There is six feet of quartz and one foot of manganese, and 30 ft. of formation.

Owners of the Nevada Wonder and Golconda Extension claims have sold an interest to J. M. Murdock, of Beaver. Development has been resumed at the latter property.

The Davis lease, the original rich discovery at Fortuna, is to be developed with greater speed from now on in both the upper and lower levels. The U. S. Smelting company has secured the right to work and mine the ores below the 125 ft. level of the Davis lease shaft, providing it will permit the use of its own shaft as an exit for the lease ores between the 50 and 125 ft. levels.

Fortuna operators and promoters, G. A. Kenrick, E. D. Dart, and C. W. Whalen figure in a recent transaction in the western part of this county. They have agreed to take over the White Pine copper-silver-lead property adjoining the St. Mary mine in the Star district near Milford, on a bond for \$25,000. Ore of a good shipping grade is exposed in three places in an adit and winze, and the new operators have already put men at work developing these orebodies and extracting ore.

At the Copper Granite mine, five miles west of Fortuna, the ore has cut four feet of good silver-lead ore.

Six companies are busy near the Sleep Rock mine, five miles east of Fortuna.

Surface vents at the Magnolia are five feet wide, and assay from \$11.57 to \$19 per ton in gold and silver. A shaft is being sunk on ore.

Fortuna, January 26.

At the Whalen lease on the Davis vein a six-foot shoot of lead ore has been opened at 60 ft. depth. This is the fourth shoot opened in this vein. It occurs at a junction.

JEAR COUNTY

Only 70 cars of ore were shipped from Tintic last week, due to snow-storms.

SUMMIT COUNTY

During January Paoli City mines shipped 7379 tons of ore.

KOREA

The Seoul Mining Co., operating the Swan concession in Vhanghae province, Chosen, reports the following results for January:

| | |
|----------------------|-----------|
| Ore treated, tons | 16,745 |
| Mill operating, days | 28 |
| Recovered: | |
| Bullion | \$ 83,250 |
| Concentrate | 77,809 |
| Total | \$161,059 |
| Expenses | 59,000 |
| Operating profit | \$111,059 |

Copper is calculated at 12¢ per pound.

The U. S. Civil Service Commission, Washington, D. C., announces an open competitive examination for chief of editorial division. From the register of eligibles resulting from this examination, certifications will be made to fill a vacancy in this position, in the Bureau of Foreign and Domestic Commerce, Department of Commerce, at Washington, at a salary of \$2500 per year, and vacancies as they may occur in positions requiring similar qualifications. Applications must be in by March 7.

PERSONAL

H. R. BOSTWICK is at Denver.

W. MOTHERWELL is at Victor, Colorado.

CHESTER A. FULTON is examining mines in Cuba.

W. H. LANDERS is examining quicksilver mines in Oregon.

JOHN W. FINCH is ill with typhoid in a New York hospital.

E. J. HOWARD WRIGHT has returned from London to Bolivia.

V. H. HIGGINS has returned to Tulsa, Oklahoma, from a trip to Tampico, Mexico.

T. WALTER BRAM has gone to Sutter Creek as manager of the old Eureka mine.

C. H. JAMES has opened offices in Kingman, Mohave county, Arizona, for general consulting practice.

ALEX. J. M. ROSS has been appointed general mine foreman for the Homestake Mining Co., South Dakota.

H. G. RAYSONS, chemist with the Old Dominion company at Globe, Arizona, has accepted a position in Siberia.

ARTHUR R. WRIGHT has been at Anaconda, Butte, and Salt Lake City. He is expected shortly in San Francisco.

LOUIS WIM succeeds PRIMA ROTRY as superintendent of the Lagrange hydraulic mine, Trinity county, California, the latter going to the Valdez Creek mines in Alaska.

ARTHUR C. COLE, recently superintendent of the Cananea Consolidated Copper Co.'s smelter, Sonora, Mexico, has been appointed manager of the R. M. Stone Mines Co., Phoenix, Arizona.

H. H. STORK, head of the department of mining engineering of the University of Illinois, has been appointed by Governor Dunne as a member of the State Mining Investigation Commission.

WILLIAM GALLAGHER, formerly mechanical engineer with the Cleveland-Cliffs Iron Co. at Ishpeming, Mich., is now in charge of the mechanical and electrical work of the Mohawk and Wolverine mines, at Calumet.

FRANK H. PROBERT is to lecture to mining students at the University of California on February 21, 23, 24, and 25, at 4 p.m. each day. The subject will be 'Oxterops and the Zone of Oxidation.' Lecture 1 will discuss the Anatomy of the Earth's Crust, Physical Forces at Work. No. 2, Life History of the Oxterop. Contributory Causes to the Constant Change. No. 3, Chemical Forces at Work. Migration of the Metals. No. 4, Significance of Surface Signs. Types. These lectures are open to the public.

W. H. RICE lost his life when the *Persia* was sunk in the Mediterranean; he was on his way to Burma.

Schools and Societies

The eighteenth annual meeting of the Canadian Mining Institute will be held at Ottawa on March 1, 2, and 3. Application is to be made for a royal charter. A. A. Cole is nominated for president. Nineteen papers, including four on flotation, are to be read. Visits will be made to the Mint, ore-dressing laboratories, etc.

The United Engineering Society of New York has issued the annual report of the Library Board for 1915. The revenue was \$17,445, and expenditure \$16,380. There were 12,826 visitors. Periodicals received totaled 17,591. The equipment was increased, and gifts were received. Some interesting library notes are given.

The committee of management of the International Engineering Congress, 1915, announces that the volume on 'Mechanical Engineering' is ready for distribution, and members who have subscribed to this volume will soon receive it. The other volumes will be issued as quickly as possible. W. A. Cattell is secretary, at 125 Foxcroft building, San Francisco.

THE METAL MARKET

METAL PRICES

San Francisco, February 9.

| | |
|--|-----------|
| Antimony | 44 |
| Electrolytic copper | 27.75 |
| Molybdenum: dull, 90% MoS ₂ , per pound..... | \$1.40 |
| Pig lead | 6.50—7.45 |
| Platinum; soft metal, per ounce | \$85 |
| Platinum: hard metal (containing iridium), per ounce | \$89 |
| Quicksilver: per flask | \$290—300 |
| Spelter | 21 |
| Tin | 43 |
| Zinc-dust, 100-kg. zinc-lined cases..... | 30 |

ORE PRICES

San Francisco, February 9.

| | |
|---|---------|
| Antimony: stronger, 50% product, per unit..... | \$2.25 |
| Chrome: 40% and over, f.o.b. cars California, per ton..... | 15—18 |
| Magnesite: crude, per ton, f.o.b..... | 7.50—10 |
| Magnesite: plastic, no iron and lime, calcined, per ton..... | 50 |
| Magnesite: refractory, up to 7% iron, calcined, per ton..... | 30—40 |
| Manganese: 50% metal, 8% silica, per ton, f.o.b. cars, S. F. | 12 |
| Tungsten: minimum 65% WO ₃ , per unit for spot..... | 40—50 |

So many operators of chrome, tungsten, molybdenum, and other properties write to use asking where they may dispose of their ores that we call attention to the 'Buyers' Guide' on the last page of each issue. Under 'Metal Buyers and Dealers' are listed the firms with which we recommend that mine operators open negotiations. These dealers buy, or will refer you to buyers, of practically all ores at present in increasing demand.

EASTERN METAL MARKET

(By wire from New York.)

February 10.—There is a strong upward move in copper, prompt metal is scarce; lead is likely to become scarce; zinc is strong.

SILVER

Below are given the average New York quotations, in cents per ounce, of fine silver.

| Date. | Average week ending | | |
|-----------------|---------------------|--------------|-------|
| Feb. 3..... | 56.75 | Dec. 29..... | 54.95 |
| " 4..... | 57.00 | Jan. 5..... | 55.67 |
| " 5..... | 57.00 | " 12..... | 56.62 |
| " 6 Sunday..... | | " 19..... | 56.68 |
| " 7..... | 56.75 | " 26..... | 57.14 |
| " 8..... | 56.62 | Feb. 2..... | 57.02 |
| " 9..... | 56.62 | " 9..... | 56.79 |

| Monthly averages. | | | 1914. | 1915. | 1916. | |
|-------------------|-------|-------|-------|------------|-------|-------|
| Jan. | 57.58 | 48.85 | 56.76 | July | 54.90 | 47.52 |
| Feb. | 57.53 | 48.45 | | Aug. | 54.35 | 47.11 |
| Mch. | 58.01 | 50.61 | | Sept. | 53.75 | 48.77 |
| Apr. | 58.52 | 50.25 | | Oct. | 51.12 | 49.40 |
| May | 58.21 | 49.87 | | Nov. | 49.12 | 51.88 |
| June | 56.43 | 49.03 | | Dec. | 49.27 | 55.34 |

Business has been less active in London, but the Mint and Continent have bought steadily. There have been Indian bear sales. America is rather a hesitant seller. There is about 5,500,000 oz. in London. The general undertone is good.

On February 5, silver worth \$567,483 left San Francisco for China. Last week the Nipissing, Ontario, sent 157,607 oz. to London.

Pixley and Abell have issued their annual chart, covering 82 years, showing the important phases of the silver market.

COPPER

Prices of electrolytic in New York, in cents per pound.

| Date. | Average week ending | | |
|-----------------|---------------------|--------------|-------|
| Feb. 3..... | 25.87 | Dec. 29..... | 21.55 |
| " 4..... | 25.87 | Jan. 5..... | 22.85 |
| " 5..... | 25.87 | " 12..... | 23.68 |
| " 6 Sunday..... | | " 19..... | 23.70 |
| " 7..... | 26.37 | " 26..... | 24.93 |
| " 8..... | 26.37 | Feb. 2..... | 25.45 |
| " 9..... | 26.62 | " 9..... | 26.16 |

| Monthly averages. | | | 1914. | 1915. | 1916. | |
|-------------------|-------|-------|-------|------------|-------|-------|
| Jan. | 14.21 | 13.60 | 24.20 | July | 13.26 | 19.99 |
| Feb. | 14.46 | 14.28 | | Aug. | 12.31 | 17.27 |
| Mch. | 14.11 | 14.80 | | Sept. | 12.02 | 17.69 |
| Apr. | 14.19 | 16.61 | | Oct. | 11.10 | 17.90 |
| May | 13.97 | 18.71 | | Nov. | 11.75 | 18.88 |
| June | 13.60 | 19.75 | | Dec. | 12.75 | 20.67 |

Owing to bad weather the Michigan output in January was

only about 75% of normal. Anaconda produced 23,200,000 lb. in January, a decrease of 2,400,000 lb. Old Dominion yielded 3,095,000 pounds.

December outputs were 6,302,045 lb. from Chino, 6,201,247 lb. from Nevada Cons., 6,912,360 lb. from Ray, 14,197,485 lb. from Utah, 3,900,000 lb. from Miami, and 4,000,000 lb. from Cananea.

Phelps, Dodge & Co.'s mines produced 139,432,879 lb. in 1915, a decrease of 700,000 lb., accounted for by trouble at the Detroit and Moctezuma mines. The Copper Queen's increase was 10,000,000 pounds.

Formerly the American Brass Co. consumed 100,000,000 lb. copper in 12 months; now it uses this quantity in two months.

LEAD

Lead is quoted in cents per pound, New York delivery.

| Date. | Average week ending | | |
|-----------------|---------------------|--------------|------|
| Feb. 3..... | 6.10 | Dec. 29..... | 5.10 |
| " 4..... | 6.10 | Jan. 5..... | 5.58 |
| " 5..... | 6.10 | " 12..... | 5.87 |
| " 6 Sunday..... | | " 19..... | 5.90 |
| " 7..... | 6.10 | " 26..... | 6.07 |
| " 8..... | 6.10 | Feb. 2..... | 6.10 |
| " 9..... | 6.25 | " 9..... | 6.12 |

| Monthly averages. | | | 1914. | 1915. | 1916. | |
|-------------------|------|------|-------|------------|-------|------|
| Jan. | 4.11 | 3.73 | 5.95 | July | 3.80 | 5.59 |
| Feb. | 4.02 | 3.83 | | Aug. | 3.86 | 4.67 |
| Mch. | 3.94 | 4.04 | | Sept. | 3.82 | 4.62 |
| Apr. | 3.86 | 4.21 | | Oct. | 3.60 | 4.62 |
| May | 3.90 | 4.24 | | Nov. | 3.68 | 5.15 |
| June | 3.90 | 5.75 | | Dec. | 3.80 | 5.34 |

QUICKSILVER

The primary market for quicksilver is San Francisco, California being the largest producer. The price is fixed in the open market, according to quantity. Prices, in dollars per flask of 75 pounds:

| Date. | Week ending | | |
|--------------|-------------|--------------|-----|
| Jan. 12..... | 165 | Jan. 26..... | 275 |
| " 19..... | 225 | Feb. 2..... | 295 |
| " 9..... | 225 | " 9..... | 295 |

| Monthly averages. | | | 1914. | 1915. | 1916. | |
|-------------------|-------|-------|--------|------------|-------|--------|
| Jan. | 39.25 | 51.90 | 222.00 | July | 37.50 | 95.00 |
| Feb. | 39.00 | 60.00 | | Aug. | 30.00 | 93.75 |
| Mch. | 39.00 | 78.00 | | Sept. | 76.25 | 91.00 |
| Apr. | 38.90 | 77.50 | | Oct. | 53.00 | 92.90 |
| May | 39.00 | 75.00 | | Nov. | 55.00 | 101.50 |
| June | 38.60 | 90.00 | | Dec. | 53.10 | 123.00 |

The quicksilver market is rather quiet, though steady. The product of many outlying mines is held up on account of bad weather.

Imports into England last year were 40,579 flasks, an increase of 3011; exports were 13,020, a decrease of 9955 flasks.

ZINC

Zinc is quoted as spelter, standard Western brands, New York delivery, in cents per pound.

| Date. | Average week ending | | |
|-----------------|---------------------|--------------|-------|
| Feb. 3..... | 18.62 | Dec. 29..... | 17.44 |
| " 4..... | 18.87 | Jan. 5..... | 17.42 |
| " 5..... | 19.00 | " 12..... | 17.47 |
| " 6 Sunday..... | | " 19..... | 18.10 |
| " 7..... | 19.25 | " 26..... | 19.02 |
| " 8..... | 19.25 | Feb. 2..... | 18.67 |
| " 9..... | 19.50 | " 9..... | 19.08 |

| Monthly averages. | | | 1914. | 1915. | 1916. | |
|-------------------|------|-------|-------|------------|-------|-------|
| Jan. | 5.14 | 6.30 | 18.21 | July | 4.75 | 20.54 |
| Feb. | 5.22 | 9.05 | | Aug. | 4.75 | 14.17 |
| Mch. | 5.12 | 8.40 | | Sept. | 5.16 | 14.14 |
| Apr. | 4.98 | 9.78 | | Oct. | 4.75 | 14.05 |
| May | 4.91 | 17.03 | | Nov. | 5.01 | 17.20 |
| June | 4.84 | 22.20 | | Dec. | 5.40 | 16.75 |

In January the Butte & Superior yielded 15,700,000 lb. zinc from 54,000 tons of ore.

TIN

Prices in New York, in cents per pound.

| Monthly averages. | | | 1914. | 1915. | 1916. | |
|-------------------|-------|-------|-------|------------|-------|-------|
| Jan. | 37.85 | 34.40 | 41.76 | July | 31.60 | 37.38 |
| Feb. | 39.76 | 37.23 | | Aug. | 50.20 | 34.77 |
| Mch. | 38.10 | 48.76 | | Sept. | 33.10 | 33.12 |
| Apr. | 36.10 | 48.25 | | Oct. | 30.40 | 33.00 |
| May | 33.29 | 39.28 | | Nov. | 33.51 | 39.50 |
| June | 30.72 | 40.26 | | Dec. | 33.60 | 38.71 |

Tin is steady at 11.25 cents.

Eastern Metal Market

New York, February 4

Copper is at present held at 26 to 27c., producers are sold up for months to come, and it seems probable that 30c. may yet be reached, despite the fact that a part of the trade deplors what really are famine prices. Foreign stocks are diminishing, and the demand from abroad is heavy. Zinc has had a quiet, uneventful week, but after an easier trend in prices, is taking on more strength in sympathy with copper. The lead market is strong, largely because of the heavy demand from abroad. Tin is easier in price, and the large deliveries into consumption indicate the extent to which consumers bought for their pure needs. Antimony is scarce and firm at higher levels. Aluminum has continued quiet and unchanged as to price.

The iron and steel industry continues to break records both in production and prices. Some eastern Pennsylvania mills are asking and getting 3c. for steel-plates, and are so busy that they declined to consider an order for 7000 tons from the Pacific Coast, despite the fact that plates of but one size were called for, and that such an order would ordinarily be considered most desirable. In January, 3,188,344 tons of pig iron (192,850 tons per day) was made. The number of furnaces in blast is being increased. In some steel products certain of the mills are sold up for the year. Prompt 80% ferro-manganese (used in the manufacture of steel) commands about \$200 per ton, and material running less in manganese has been sold at \$2.70 per unit of manganese.

COPPER

With the producers of electrolytic sold up until April, and deliveries in that month becoming more scarce; with the Lake producers sold up to June, 30c. copper seems not far off. Practically no sale lots are offered at the market or under it, and it can be repeated that the producers have things in their own hands. Late last week, and up to February 2, the market was quiet, but nevertheless steadily growing firmer, and on that date a flurry of activity sent the price of nearby deliveries to 26c., 30 days, delivered, or 25.87½c. cash, New York. Since then May copper has reached 26.50c. full terms. Most of the inquiry was for February and March positions. Buying for export has been active, and some particularly heavy inquiries have come from Italy. One producer was forced to turn down an inquiry for 9,000,000 lb. of electrolytic, inasmuch as immediate delivery was wanted. The London market has advanced almost from day to day, despite the effort of the British Minister of Munitions to keep electrolytic down to £100. To this end circulars were issued to the consuming trades requesting them to refrain from making purchases of electrolytic amounting to anything over 50 tons, and at not above £100, without reference to the Ministry. The effort has been futile, however, probably because of the great need of the local for munitions work, and the fact that stocks abroad continue to dwindle. The New York Metal Exchange cables reported the total stock of fine copper in Great Britain and France, on February 1 to be 17,523 tons, a decrease of 1833 tons as compared with January 15. Electrolytic was quoted at London on February 4 at £128. Exports in January totaled 21,863 tons. The railroad-freight embargoes continue to make it difficult to ship into New England where immense quantities of copper are used. When the embargo was raised a few days ago there was such a rush on the part of shippers that the railroads were forced to again stop acceptances of freight. It now looks as if the embargoes will be alternately lifted and lowered for some time to come. One wire-mill in the Naugatuck valley was compelled to shut-down for a few days, and other mills were near the danger-line because of low stocks. Reverting to domestic prices again, it can be said that not all

of the trade is pleased with the way prices are soaring. They realize that the higher prices go, the greater will be the drop when the slump comes, and they remember the year 1907 when copper exceeded 25c., but dropped in the course of a few weeks to about 13c. Such declines are demoralizing.

ZINC

While some interest has been shown in nearby deliveries the market has been quiet for the past week. Until February 2 quotations eased off until 18.50c., New York, could have been done on that day. With the greater strength in copper, however, the spelter market showed more strength, and prompt was quoted on the 3rd at about 18.75c., New York. February was obtainable at about 18.50c., March at about 18c., and second quarter at 17.75 to 17.87½c. Prime Western is to be had easily enough at the ruling prices, but brass-mill special and the higher grades are scarce. January exports totaled 4812 tons.

Sheet-zinc is quoted at 24c., base, carload lots, f.o.b. mill, 8% off for cash.

LEAD

The lead market has been ruled by the strong foreign demand. While the New York price stood at 6.10c., New York, on February 3, sales for export were made at over this figure, and the trade was expecting an advance by the leading producer. Shipments against contracts are heavy, both foreign and domestic munition makers taking all they can get. The British munitions' authorities have tried to curb speculation in the metal and a slightly easier feeling has been created in London, where the spot quotation on February 3 was £31. All the producers are well sold ahead. January exports totaled 1210 tons.

TIN

Except for fair activity on one or two days the tin market has been quiet, and the trend of quotations has been downward. For spot tin 41.25c. was quoted on the 3rd. The situation is one where consumers' needs are covered. January deliveries totaled 4452 tons, and there was in stock and landing on the 31st 2101 tons; deliveries in January, 1915, amounted to 2480 tons. Of the January, 1916, arrivals, 1052 tons came *via* Pacific ports. On February 3 there was afloat 7670 tons. The British trade is quiet, and while there is a good demand in Europe, shipments to French and Italian ports is difficult because of the lack of ocean-freight room.

ANTIMONY

The market has gained considerably in strength because of the scarcity of prompt-delivery metal and occasional activity. At the beginning of February quotations were advanced to 43.50 to 44c., duty paid, for Chinese and Japanese grades.

ALUMINUM

In a quiet market, quotations are unchanged at 53 to 55c. for No. 1 virgin aluminum, 98 to 99% pure.

ZINC AND LEAD ORE PRICES

Prices for zinc-blende at Joplin last week were stronger, sales being up to \$115.50, basis 60% metal. Production of the Missouri-Kansas-Oklahoma region was 6650 tons blende, 196 tons calamine, and 918 tons lead, averaging \$110, \$61, and \$78 per ton, respectively. The total value was \$819,062. For the first five weeks of 1915 the value is \$3,802,945. A total of over \$28,600,000 is expected for the current year, against \$26,000,000 in 1915.

COMPANY REPORTS

VINDICATOR CONSOLIDATED GOLD MINING CO.

The report of this Cripple Creek company for 1915 is of considerable interest, which is increased by the plans and photographs. An important transaction was completed in March whereby the company purchased the mining property of the Golden Cycle Mining Co., of 43.5 acres, adjoining Vindicator ground, which now totals 130 acres, for \$1,300,000. The assay, mine office, and engineering staffs were consolidated, also the air-compressing plants, while the machine-shops, boiler-plants, etc., will be, resulting in reduction of charges. Improvements at the ore-house enabled an average of 10,527 tons of ore to be handled monthly against 6358 tons before. Early in 1915 the new concentrating-plant, to handle reject from the ore-house and make a shipping product, was at full capacity; it is a complete success, treating 250 tons per 8-hour shift. Concentration is 11 to 1; the recovery from \$2 ore was 55%. Profits from this plant are double what was expected from tests. Costs are 20c. per ton according to the report of Irving T. Snyder, vice-president and general manager.

The usual development and stoping operations were con-

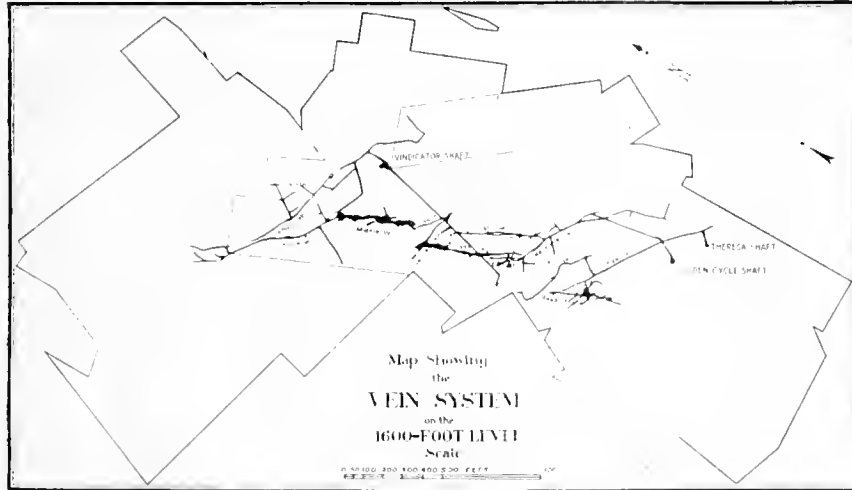

tinued, with uniformly satisfactory results. Stopping on the large orebodies at 1600 ft. was vigorously prosecuted. The middle vein at this depth is 400 ft. long and 35 ft. wide. It is in ground previously regarded as barren. Its position is shown in the accompanying plan. So far at 1500 ft. this lode is 225 ft. long of good value.

The Golden Cycle shaft was sunk from No. 18 to 20 level, a depth of 2210 ft. The principal orebody, the Ready Money, was cut on No. 18 in April. On this level it is larger than on No. 17, but not so wide or high in grade. Since acquiring this mine the company has done a great deal of exploratory work. Lessees in both mines have done several thousand feet of development. The extension of the Roosevelt drainage-tunnel will cut the Golden Cycle shaft 65 ft. below No. 18 level. This will relieve the pumps at No. 18 and 20. A heading will be started from No. 20 to meet the drainage-tunnel. Pumping cost \$41,273 last year.

Twelve months at the Vindicator and ten months at the Golden Cycle resulted as follows:

| | |
|-------------------------------------|--------------------|
| Crude ore extracted, tons | 218,487 |
| Shipping ore from above, tons..... | 125,397 |
| Average gold-content, per ton | \$23.73 |
| Company's share (76,209 tons) | \$2,164,669 |
| Lessees' share (49,188 tons)..... | \$15,183 |
| Total | \$2,979,852 |

| | |
|--------------------------------------|-----------|
| Freight and treatment (company)..... | 416,647 |
| Gross proceeds for company | 1,718,022 |
| Net royalties from leasing | 251,624 |

| | |
|-------------------------------------|-------------|
| Total revenue at mine | \$1,969,646 |
| Mining, development, mill, etc..... | 703,784 |

| | |
|--------------------------|-------------|
| Profit from mining | \$1,265,862 |
| Sundry receipts | 84,302 |

| | |
|--|-------------|
| Total profit | \$1,350,164 |
| Paid on account of Golden Cycle purchase (\$960,000) and other charges | 1,046,939 |

| | |
|-------------------------------|-----------|
| Balance | \$303,225 |
| Cash on January 1, 1915 | 208,270 |

| | |
|-----------------------|---------|
| Total available | 511,495 |
| Dividends paid | 225,000 |

| | |
|------------------------------|-----------|
| Cash on January 1, 1916..... | \$286,495 |
|------------------------------|-----------|

Liabilities include \$340,000 Golden Cycle purchase notes outstanding.

Not less than 2,000,000 tons of \$2 ore remains on the dumps, also large blocks of low-grade material in the mine, all profitable if a process for treatment can be devised. Since July two metallurgists have been experimenting with flotation and cyanidation. A 10-ton flotation plant is in operation. The tests resulted in the recommendation that the old Golden Cycle plant at the mine be re-modeled into a 300-ton flotation plant, sufficient to treat all the reject material from the Golden Cycle ore-house, as well as to experiment on all grades of ores. A recovery of 90% at a cost of less than \$1 per ton is expected. Later a 1000-ton mill will be erected.

Workmen's compensation, a new law, has been carefully studied, and additional benefits were offered and accepted by the employees.

SHATTUCK ARIZONA COPPER CO.

This company operates at Bisbee, Arizona, and the report covers 1915. Development aggregated 14,978 ft. The orebody opened in the Southwest claim was the most important work; the shoot is 400 ft. long, 12 ft. wide, assaying 6% copper. The silicious gold-silver ore, with a small value in copper, is of importance, and is required at the Calumet & Arizona smelter. Large bodies of lead ore, distinct from the copper, have been opened also. Tests on the lead-copper-vanadium ores show good results.

The output was 11,154,211 lb. copper, 3151 oz. gold, and 201,869 oz. silver, a little higher than in 1914. The cost of copper was 8.45c., and average price 17.31c. per pound. The revenue was \$2,368,548; profit, \$1,174,028; dividends \$875,000; and surplus, \$267,664, compared with \$1,660,573, \$587,497, \$525,000, and \$31,865, respectively, in 1914.

The present monthly yield is 1,500,000 pounds.

PREMIER (TRANSVAAL) DIAMOND MINING CO.

Owing to the War this great diamond producer remained closed during 1915. An improved but limited demand set in early in the year, and some stones on hand were disposed of. It has been decided to resume washing operations on a small scale. During the year ended October 31, 1913, a normal year, there was 10,434,680 loads (1600 lb.) of ground washed, yielding diamonds worth 78 cents, at a cost of 60 cents per load.

BOOK REVIEWS

THE CORROSION OF IRON. By E. C. Wilson. P. 178. Index. The Engineering Magazine Co., New York, 1915. For sale by MINING AND SCIENTIFIC PRESS. Price, \$2.

In recent years considerable investigation has been directed to trouble from corrosion, involving chemical research of no simple character. Results of these tests have been published in technical journals and societies, and are therefore difficult to obtain. This book contains a collection of the more important facts connected with the corrosion of iron and steel, and their protection from it. The rust problem is of great importance to constructing engineers and others. The three principal theories of corrosion are the hydrogen peroxide, carbonic acid, and electrolytic; these are well discussed. Various elements added to iron help to prevent corrosion, so do the many processes of coating with metals and paints. Engineers of all professions will find this volume of practical value.

INDUSTRIAL USES OF FUEL OIL. By F. B. Dunn. P. 232. Ill., index. Technical Publishing Co., San Francisco. For sale by MINING AND SCIENTIFIC PRESS, San Francisco. Price, \$3.

The use of petroleum as a commercial fuel is still a comparatively new thing and there is but little technical literature upon the subject. The first chapter of the present volume discusses the heating value and other physical properties of fuel oil, comparing it especially with coal. The next chapters consider general arrangements and devices for oil burning, including pumping and storage systems, arrangement of furnaces, oil burners, strainers, and heaters. The use of oil in particular industries is then discussed, the clay, lime, cement, sugar, gas, rubber, and steel industries are taken up in turn, besides the use of oil in smelting and other metallurgical work, for locomotives, steamships, and for domestic purposes. The use of crude oil in Diesel engines is not considered. Considerable data are given regarding comparative costs of the use of oil and other fuels, and there are directions given for tests and reports on fuels.

ENGINEERING AS A CAREER. Edited by F. H. Newell and C. E. Drayer. P. 214. D. Van Nostrand Co., New York, 1916. For sale by MINING AND SCIENTIFIC PRESS. Price, \$1.

This is a symposium on a much discussed subject, the contributors being A. J. Hines, Franklin De R. Furman, Worcester R. Warner, A. W. Johnston, Chester W. Larner, J. H. Herron, W. H. Abbott, M. C. Whitaker, S. T. Wellman, J. C. Workman, R. Winthrop Pratt, Robert Hoffmann, Rudolph Blankenburg, Frank C. Osburn, Benjamin S. Hubbell, F. B. Richards, Henry S. Munroe, Ernest McCullough, James F. Barker, Waldemar Kaempffert, David Edgar Rice, and John Ritchie, Jr., who discuss the engineer, boys becoming engineers, mechanical, railway, hydraulic, metallurgical, electrical, chemical, marine, sanitary, municipal, bridge, architectural, and mining engineering, also iron and steel opportunities for mining engineers, the lure of private practice, vocational guidance, income of technically trained men, and the technical man in business. Most of these articles were published in the *Cleveland Plain Dealer* and *Scientist & American*. The inspiration for the book came in response to numerous inquiries from high school teachers and others who are frequently called upon to advise young men in their choice and preparation for a professional life. It was found from experience that many youths who planned to study engineering had only the most hazy ideas of what is involved, nor were their teachers and parents much better informed. The book should prove of special value to professional advisers in vocational guidance work and to parents who have the opportunity of continued observation and intimate acquaintance from which may be learned the aptitudes of their sons.

INDUSTRIAL NOTES

The AMERICAN MANGANESE STEEL CO., of Chicago, has opened an office at 202 Oliver building, Pittsburgh.

The TURKEY STEAM TURBINE CO., of Hartford, Connecticut, announces that Maynard D. Church has been appointed chief engineer.

Bulletin No. 19,200, from the Sprague electric works of the GENERAL ELECTRIC CO., discusses electrical theatrical devices, equipment, and accessories.

Catalog D, 1916, of the BROWN HOISTING MACHINERY CO., Cleveland, Ohio, describes tram-rail systems, trolleys, and electric hoists, made by the firm. In the 63 pages of illustrated matter there is a lot of useful information.

A 200-ft. thickener for the Inspiration mill, Arizona, some 50-ft. acid-proof thickeners for the Anaconda company, Montana, and six 10-ft. thickeners for the New Modderfontein mill, Transvaal, are being made by the DOMA CYANIDE MACHINERY CO., Denver.

In Bulletin No. 60, the DENVER ROCK DRILL MANUFACTURING CO. describes its model No. 60, Denver 'Dreadnaught' driving drill. This is a machine weighing 83 lb. unmounted, and 110 lb. mounted, and suitable for one-man operation. It has a number of interesting devices to ensure good work. A few notes are given on the Waugh valveless stopper.

At the Wheeler copper mine of the Queen Regent Mines Merger Corporation, two miles north of Spenceville, Nevada county, California, Allen R. Partridge and M. M. Johnson are erecting a 11 by 18-in. new Partridge smelting furnace made by the PACIFIC FOUNDRY CO., of San Francisco. The daily capacity is 12 tons of ore, to yield 1.5 tons high-grade matte.

At Apollo, Pennsylvania, the Apollo Electric Steel Co. has been organized with a capital of \$500,000 to make steel. Two SNYDER ELECTRIC FURNACE CO.'S Chicago furnaces are to be installed, each of 12 tons holding capacity, and with a daily output of 100 net tons each per full day. They will be basic lined. The Snyder company has opened a branch in England.

The New Cornelia Copper Co., at Ajo, Arizona, has recently placed an order with CHALMERS & WILLIAMS, of Chicago, for twelve 48-in. Symons fine-reduction disc-crushers, which will be the only crushers used in its plant to reduce 4000 tons per day from 4 to $\frac{1}{4}$ in. The firm also has on order one of the same kind of crushers for each of the following concerns: Chile Exploration Co.; Hollinger Gold Mines, Timmins, Ontario; and C. S. Christensen, Kristiania, Norway.

The Veteran Employees' Association of the WESTINGHOUSE ELECTRIC & MFG. CO., at its third annual banquet, held on January 29, at Pittsburg, presented to the company a handsome bronze memorial tablet of the late George Westinghouse, founder of the numerous industries bearing his name. Though only three years old, this organization, composed of those who have been in the employ of the company for 20 years or more, is one of the most active of the numerous Westinghouse organizations. About 450 veterans were present, and officers and men from the shop mingled freely with each other and discussed old times when the electrical industry was in its infancy. The tablet is 3 by 4 ft., of solid cast bronze, weighing 300 lb., showing in true bas-relief a likeness of the late master workman, inventor, founder, and organizer, from 1846 to 1914.



EDITORIAL



T. A. RICKARD, Editor

NOW that tungsten is in such demand, the scheelite that used to annoy the gold diggers on Snow and Glacier creeks, in the hills behind Nome, ought to be exploited to advantage.

COST of producing copper in the mines of North America may be taken at about 11 cents per pound of refined metal, including the expense of development. The cost ranges from 7 to 20 cents.

CARRANZA'S *de facto* government is being flouted every day that Villa remains on the rampage. Mining in Chihuahua continues to be menaced by Villa and his band. It would seem proper for Secretary Lansing to remind Señor Don Venustiano of his duty in the matter.

AT Cripple Creek the Vindicator Consolidated Company is to erect a flotation plant of 300 tons daily capacity, to be increased later to 1000 tons, for the treatment of the reject from the Golden Cycle ore-house. It is worth noting that the cost of this larger plant will be \$200,000, as against \$750,000 for a cyanide mill of equal capacity.

OUR friend *The Mining Magazine* has made the mistake—so it seems to us—of changing the name of its *Précis of Technology* to 'Mining Digest.' Of the latter there are many, and most of them furnish indigestible scraps of technical information highly provocative of mental dyspepsia, while the *Précis of Technology* prepared by Mr. Edward Walker for the pages of our London contemporary always seemed to us to be so peptonized as to permit of easy mental assimilation. Indeed, as we have said before, it represents an effort of good and sincere journalism, which it is a pity to label with a name so little distinctive as that which has now been substituted.

QUICKSILVER is a metal much in demand just now and the search for it is being stimulated in California by the abnormal price. We take pleasure in publishing a timely article by Mr. W. H. Landers, resident manager for the New Almaden Company, which is operating the famous old group of mines in Santa Clara county. He lays stress on the backwardness of mercury metallurgy and the lack of interest in the technique of the subject. Undoubtedly the stimulus given lately to the production of the metal will induce greater interest in the matter, for many deposits hitherto too low-grade to be mined will now attract exploitation. In this connection we may mention that cinnabar is one of the non-

lustrous minerals that are amenable to flotation, so that we shall expect to hear of notable results. Our news columns this week make several references to the re-opening of quicksilver mines.

ANOTHER uncommon mineral that has come into prominence by reason of the War is ozokerite or 'mineral wax.' As noted by Mr. L. O. Howard, in his Utah correspondence, the only two districts where ozokerite is mined in noteworthy quantity are Boryslaw in Galicia and Utah county in Utah. The devastation of Galicia, and the absence of exports from that province, has caused the price of the mineral to rise to 45 cents per pound. A mill for treating the Utah ore is to be erected at the Soldier Summit mine. In 1913 the quantity imported was 7,141,540 pounds valued at \$549,990, or slightly over 7 cents per pound. Ozokerite is used largely for the manufacture of phonographic records.

METAL MARKETS continue to rise. Our correspondent at New York emphasizes the intensified demand for copper, and the reckless buying of this metal. A price of 30 cents is likely soon. Zinc also is soaring to new records. Lead is higher. Antimony is scarce. The tin smelter of the American Smelting & Refining Company at Perth Amboy has started to work, but operations are crippled by the interruption to shipments from Bolivia owing to the blocking of the Panama Canal. As we have said before, any mining company selling metals on the quotations of our New York contemporary should, at least, protect himself by taking heed to the prices we quote. Our source of information is wholly independent of the metal-selling agencies at New York.

LEGISLATION likely to injure the Bureau of Mines is threatened by the bill H. R. 153, which seeks to create a Bureau of Labor Safety in the Department of Labor, and by H. R. 9420, which aims to transfer the Bureau of Mines bodily from the Department of the Interior to the Department of Labor. We urge the friends of the U. S. Bureau of Mines not to overlook the danger of a hasty change that will end or cripple all the good work now under way. Important legislative measures do occasionally slip through owing to mere oversight on the part of those having real interest in the subject. The Mann bill, H. R. 153, passed the House on January 19, after it had been amended by a provision stating that "nothing in this act shall be held to repeal, modify, or affect any other Act of Congress" already in force. This proviso is supposed to save to the Bureau of Mines its labor-safety work, but it would not prevent the Bureau of Labor Safety from duplicating a great deal of

the work being done by the Bureau of Mines, and thereby undermining its status. In the bill making appropriations for the Bureau of Mines this year it was provided that no part of the \$100,000 appropriated for metal mining work should be used "for work authorized or required by law to be done by any other branch of the public service." It is obvious, therefore, that there are influences at work inimical to the Bureau of Mines, which has won the cordial esteem of the mining public and deserves to be upheld in every way possible. Write to your Senators and Congressmen and tell them what you think about it.

AMONG the ailments to which the miner is subject is hookworm. In bringing about an investigation of this disease in Californian mines the Industrial Accident Commission is giving further proof of its great usefulness. Thanks to the Commission, the State Board of Health and the Federal Government have been prevailed upon to join hands in an effort to stamp out this disease in the mining camps of this State. The Board of Health has assigned Dr. J. G. Cumming, of the Bureau of Communicable Diseases. He will have charge of the medical part of the work, which will consist largely of making diagnoses and working out the system of treatment. The U. S. Bureau of Mines has assigned Mr. Joseph H. White, sanitary engineer, whose work will be chiefly that of examining mines with a view to devising means for combating insanitary evils. Mr. White arrived in San Francisco some days ago and is now at work in the Mother Lode region. Dr. Cumming recently made a short trip through several of the larger Mother Lode mines for the purpose of determining if hookworm infection existed. While the report on this preliminary investigation has not been published, it appears that at one large mine 40% of the miners were found to be infected. Should this percentage hold elsewhere, obviously it will be a most serious matter. The cause, effect, and cure of the hookworm disease are no longer obscure or hidden from the scientific eye. During recent years the subject has received a great deal of attention from various sources, the Rockefeller Institute having spent in the neighborhood of a million dollars in its work of investigating and eradicating the disease. The cure is well known and is quite inexpensive.

STANDARDIZATION of screens has not been accomplished as yet, apparently. Among the reforms brought forward for discussion by the Mining and Metallurgical Society of America by its committee on standardization is that of a scale for measuring screen-openings. At the recent meeting of the local section of that small but energetic society, it was voted to adopt the suggestion brought forward by Professor E. A. Hersam, of the University of California. We publish a letter from him on the subject, so that it may be properly ventilated. Hasty action is to be deprecated, for the adoption of any new standard means the upsetting of the good work done by the Institution of Mining and Metallurgy. Not that the decisions of the latter are to be

accepted as beyond cavil, but it is well in these matters of international usage to take pains to obtain a consensus of responsible opinion. In the December issue of *The Mining Magazine*, Mr. Walter McDermott writes suggesting that the Mining and Metallurgical Society consult with the Institution before committing itself to the adoption of a new scale of wire-cloth screening. The choice of a standard by the Institution followed a ballot of its membership after consultation with the representatives of other societies abroad, and it has been found most useful in practice. In short, if any change is to be made, it should be made deliberately and considerately, with the view to general adoption in all the English-speaking mining regions. We venture to express dissent from a suggestion appearing in the Canadian Mining Institute bulletin, that the two engineering organizations mentioned above are "the two representative societies of the mining profession in the English-speaking world." This is a pardonable error. The 250 members of the M. & M. Society are gentlemen of unusual intelligence and distinction, but to assume that any group of 250 men represents or expresses the activities of the mining and metallurgical profession in the United States, let alone the not inconsiderable remainder of this continent, is a gasconade. The American Institute with its membership of 5000 may be too inclusive to be select; certainly the M. & M. Society with its 250 is too exclusive to be representative.

Physics of Flotation

A notable turn of interest has been manifested during the last six months in regard to this subject. It remains a remarkable omission on the part of the International Engineering Congress and the American Institute of Mining Engineers that the meetings of these organizations in San Francisco last August should have passed without the presentation of any paper on the particular metallurgical process that then, as now, commanded the attention of wide-awake technicians. However, that curious omission has been remedied since then. We have done a little ourselves, but the more important fact is that the local sections of the American Institute have shown commendable initiative in bringing the subject forward. Our friends at Salt Lake City did something worth while in December, the Arizona section is to follow suit, while the San Francisco division has devoted three meetings to discussions and demonstrations on the same topic. On the evening of the 15th instant, Dr. Joel H. Hildebrand, of the University of California, gave us a lecture on the 'Physical Phenomena Underlying Flotation,' accompanying his speaking by lantern exhibits. This was followed by a general discussion, in the course of which many interesting questions were asked and answered. The latter method of eliciting information is most to be commended, especially when it relates to a scientific study that is so far from being crystallized.

This meeting was also noteworthy in being a joint session of the 'miners' and the 'chemicals,' the local sec-

tion of the American Chemical Society having joined with the American Institute membership for the occasion. It is well for those who exploit one branch of science to go for help to the specialists in another department of knowledge. Just now the metallurgist happens to be in trouble; he has been called upon suddenly to face problems outside his ken. Hitherto his work has been based mainly on a knowledge of chemistry, but in flotation he faces phenomena the understanding of which involves such a familiarity with physics as he does not possess. Here we suggest that in the schools of mining, it will be well if the students make use of the instruction and laboratory facilities afforded by the physics department, and do not attempt to study flotation problems under the direction of professors of geology, mining, or metallurgy alone. We also commend to them, and to their seniors, a serious attempt to understand the terminology of the subject. The first step in any intelligent grasp of a scientific problem is the definition of terms. A phenomenon is an unusual appearance, and inferentially one hard to explain. When we don't know what a thing is, we are too apt to call it a 'phenomenon' and think that in so doing we have settled the matter. These Greeco-Latin terms are the mere smoke of intellectual exchange. We need, for instance, to understand clearly what is surface-tension, what is emulsification, even what is oil. The test of our knowledge will be the ability to explain any of these in Anglo-Saxon words of not more than two syllables.

Stoping Methods

No part of technical literature is so incomplete and unsatisfactory as that relating to the actual mining of ore underground. Such work is usually done by men not given to writing and it involves procedures not lending themselves easily to description. Moreover, it is a part of the operations that is apt to escape criticism because so few are equipped by knowledge or experience to pass judgment. The average director and mine-owner can see for himself if the books are kept properly, if the assay-office is clean, and if the mill is running smoothly, but when he goes underground he becomes merely a passenger. On the other hand, the actual conditions modifying the extraction of ore vary so much, both as regards lode-structure and metal-contents, as to check a hasty opinion on the part of any intelligent visitor, no matter how experienced he may be. While the simpler methods of attacking a plain problem in mining are well understood, it is recognized by the initiated that the larger and more complicated systems of excavation involve a variety of considerations far beyond the scope of any text-book knowledge or even conventional practice. It is difficult to depict or describe an elaborate scheme of stoping because all the phases of it cannot be seen at any given date in any single mine. The element of time is involved. Thus the technology of the subject is unavoidably incomplete. Yet it is one that should be brought forward for discussion at intervals. We are

glad therefore to be able to publish an article by Mr. F. W. Sperr, Professor of Mining in the Michigan College of Mines. As will be seen, we give the information in the form of question and answer, believing that thereby it is possible to get more quickly at the root of the matter. It is proper that this article should emanate from Michigan, for in the iron and copper regions of that State have been evolved most of the methods of big-scale stoping that are now in vogue. The Professor divides stoping methods into three classes, according as whether (1) the stope is kept open, (2) filled with broken material on which the miner can stand, or (3) caused to cave. This is a logical classification. It is true also, as he contends, that several variations of open-stope methods are assumed incorrectly to belong to the much-abused 'caving' type. Such an idea frequently prevails in regard to sub-level stoping. Other points made clear in the article are the real significance of the term 'shrinkage' and the essentials of block-caving. This last system of stoping has the excellent characteristic of grinding a big orebody of medium-hard ore into small fragments and so entailing the consumption of a minimum amount of explosive, because, when it is under-cut, on the bottom and one or more sides, a block of ore several hundred feet square will crush itself by force of its own weight so as to be ready for shoveling. This process of grinding into small fragments requires an interval of several months after the under-cutting has been done, during which time this part of the orebody is let alone, while operations are being pushed in some other part of the mine. Incidentally, these big-scale methods demand enormous orebodies for their effective application, as the units of space and time are large. Just how the self-reduction of a block of caving ground is accomplished automatically is not entirely understood, for it is dangerous for the inquisitive to watch Nature in the art of mining. It is only known that in the sequel, when the ore is drawn, the crushed material settles down fairly uniformly.

The square-set system was introduced in the Ophir mine, on the Comstock lode, by Philip Deidesheimer in 1860, but this method of holding ground, like many other extravagances adopted at Virginia City in the boom days of an early decade in Western mining, has been superseded by the better methods evolved out of Lake Superior practice in the big iron and copper mines of Michigan and Minnesota. From the Lake country they have been borrowed by those exploiting the disseminated copper type of ore deposit in Utah, Arizona, and New Mexico. What the German or the Cornish miners gave to the American superintendent has been covered long ago by later accretions of knowledge. Big-scale mining methods are now truly American. They represent a scientific effort to exploit huge orebodies of irregular shape but relatively uniform composition so as to avoid the use of timber and shovel. No finality of procedure has been reached and every new problem has to be tackled on its merits, so that the subject continues to be one well worthy of frank discussion. We hope that some of our readers will contribute comment and criticism.



DISCUSSION

Our readers are invited to use this department for the discussion of technical and other matters pertaining to mining and metallurgy. The Editor welcomes the expression of views contrary to his own, believing that careful criticism is more valuable than casual compliment.

The Designation of Screen Sizes

The Editor:

Sir—The action that is being taken by the Mining and Metallurgical Society of America for the betterment of practice, and the adoption of standards, is deservedly drawing attention to the proper use of screens for sizing. The activity of this Society will be welcomed by many who have undertaken to use screens for exact purposes. All those who have attempted to compare and check their own results upon sized products with like results obtained by other men, will find the appeal of the Society a timely one. The outcome of the movement should be a clearer understanding and better agreement in everything that relates to the sizing of products.

To disturb present fixed practices, however, is unwarranted, if there cannot be seen a way clear to an end that will be satisfactory and permanent when attained. The inconveniences which people are now experiencing in the use of screens are not restricted to a single item, but are general and varied. There is doubt if many are aware of the benefits, in detail, to be secured by a movement in which many men are to take a part. When all is done, much will still be left to common-sense in the use and selection of screens, and much left to personal preference.

The method of manipulating screens in sizing, the choice of the metal composing them, the preference for type and make, and many minor matters in selection and operation that a locality might require or an individual prefer are not details to be prescribed off-hand. The understanding of terms, however, and the general use of such designations as can be understood are advantages to be secured by public interest at this time, and these alone will justify the movement.

We are at present using specifications and terms that are indefinite. Many of us are unaware of the inaccuracy of the screens that we employ. Some of us have never properly taken into account the diversity there is in the size of particles when separated by the best of screens in the best possible way. Some of us would consider inaccurate the results of tests properly qualified by the percentage of error that work with screens actually demands. Our attention to the arrangement of a graded series, in great detail, must not lead us to forget that a limited degree, only, of accuracy is possible in the use of screens, nor lead us to suppose that we have fulfilled all that requires to be done in perfecting and designating screens when we have adopted a standard. In

order to know of the degrees of accuracy, and to have methods of gradation and comparison capable of adaptation and improvement, we need results, not in the empirical numbers of screens, but in terms of the dimensions of orifices. In such terms as give results in actual orifice dimensions, and only in such terms, can a tangible and comprehensible expression of the coarseness of a sized product be obtained.

We describe loosely, at present, a material as being, for example, of the coarseness of 80-mesh. The statement is simple: It carries to most people a definite idea. The idea, however, is not definite in any material result it represents. It is true that '80 mesh' suggests a screen in which there are 80 openings per linear inch. No one now grades his screens by the openings numbered in a square area. General usage, moreover, would prompt one to interpret the statement as implying that there are 80 openings to the linear inch measured in a direction parallel with the wires.

Whether the material understood as sized by this so-called 80-mesh screen would barely pass the screen, or whether this screen on the other hand would obstruct the material after it had passed the next coarser size, we are not so certain. We generally infer that the material could pass an '80-mesh screen,' but that by the 90-mesh it would be retained. There is, however, always the possibility of misunderstanding in designating sizes in this way.

While we are sure that the openings of the screen are not larger than one-eightieth of an inch, since there are 80 of these openings to the linear inch, we do not know how much smaller than one-eightieth of an inch such openings may be. The space for the wire must be deducted to show this dimension. The size of the wire thus becomes a factor in designating the coarseness of a sized product or of a crushed ore.

Wire must be large for strong screens, for rough service, or for the weaker metals. Thus it is not suitable to adopt one size of wire for screens universally, nor for screens of one mesh or coarseness. Knowing the number of meshes to the inch and the size of the wire, it is possible to divide and subtract, and finally to arrive at the real dimension of the openings. The operation necessary in order to find the dimensions of the openings, of a screen one is contemplating, becomes a distraction from the real purpose. It is a troublesome and needless detail, and should be so dealt with as to be avoided. It is the opening, and not the wire, that is the real and important feature of the screen. The effect of the size of the wire

throws the critical and essential feature of the screen into a secondary consideration. The apertures of the screen become repositories for errors; and the essential dimensions become distorted to suit the possibility in combinations.

Knowing the size of the openings of the screens that are used for sizing, and designating the coarseness of sized products by these sizes is, without question, the most exact, adaptable, and direct means of expressing sizes. An attempt to measure particles under the microscope, or to weigh numbers of separate particles, and to average the weights, leads to error in corresponding ways as great as is met by sizing with good screens.

Angular pieces of crushed material are generally considerably smaller than a theoretical cube would be of a given dimension. The variation of the actual mass from the size of this cube depends upon many conditions into which the establishment of standards can never enter. Among many of the conditions influencing these sizes will be the dampness of the material, the cohesion, and the angularity; and when results come from questionable sources allowance must be made for the possible incompleteness of manipulation upon the screen, for the spread of wires, and for the imperfect condition of the screen.

The universal expression of the coarseness of material, as time goes on, will come to be in terms of the coarseness of the screens that were used in sizing it. To number such screens in any way other than in the dimensions of their openings will therefore be found needlessly indirect. Numbers arranged for any special series or limited to any special trade interpretation will be found without convenience or justification. The expression of screen sizes by the dimensions of the aperture is simple, direct, and sufficient, and the establishment of a general custom of so representing screens should be the prime object in the present movement.

Our present standards are under the English system, and common agreement appears to have adopted the units of this system for trade and common measurements. The unit of the thousandth of the inch is convenient in magnitude for the measurement of fine screen-openings. Upon this basis, all results of work with screens, all tabulations of their sizes, all designations of any series of screens, and all specifications of screen sizes should be expressed in whole numbers representing the thousandth of the inch, adding, if desired, or if necessary, any needed fraction of the thousandth thereto in the same manner in which use is made of inches and quarter-inches in larger measurement. It is desirable, permanently, to discontinue allusion to the number of openings to the inch as an expression of the coarseness of the screen. Allusion to the size of the wire properly should be for reference to the strength, or the wear, or the metal, or the ratio of discharge-area to structural substance, but not to the coarseness. A screen having openings 0.050 inch in dimensions, as thus considered, would be one designated by the number 50. This number being the dimension of the opening in standard units commensur-

ate with the magnitude of the openings to be considered. With these numbers, and with the variety of screens the trade now supplies, we can secure such a series of screens as may be desired. Our idea of the coarseness of products will then rapidly take form in terms of these dimensions.

ERNEST A. HERSAM.

Berkeley, January 10.

Simple Problems in Flotation

The Reader:

Sir—On another page Mr. Durell objects to a statement of mine in regard to the floating of an ungreased needle on water. He is measurably right. An ungreased needle will float, but not nearly so easily as the greased one. The latter will float if placed on the water without special care, but if the former is handled in the same way it will sink. My reference to the matter was quoted from the 'prior art,' which in this regard, as in many others, I know now to be a dangerous guide. Some time ago, but since my first writing on flotation, last summer, I made several experiments to find out for myself what happens. To be certain that the needle was free from grease, I dipped it in a hot solution of washing-soda and then dried it, taking care to use a clean cloth and to not touch it with my fingers. Then I placed a piece of tissue-paper on the water in a cup and laid the needle upon it by aid of a pair of pincers. The tissue-paper was depressed into the water, becoming wetted gradually, until it was all soggy and finally sank, leaving the needle floating. Without such care I could not make the needle float.

Next I used the camphor test to ascertain if the water had been contaminated by grease. If camphor is whittled with a knife above the water, the shavings will dance on the water in a life-like manner suggesting insects in a fit. This phenomenon, as shown by Marangoni, is due to the dissolving of the camphor, preferably at its pointed end, where a maximum surface is presented to the water. The solution decreases the surface tension of the water in contact and thereby causes the uncontaminated water, with its stronger tension, to pull away from the spot affected by the camphor. In order to produce this activity of the camphor, the surface tension of the liquid must be greater than that of the camphor solution. Hence if grease be introduced into the water, thereby lowering its surface tension, the camphor becomes inert. If, while the camphor particles are active, the water is touched by a greasy finger (all fingers are a little greasy) the camphor becomes quiet immediately. This furnishes a good test for the presence of even a trace of grease. No ordinary 'clean' cooking utensil is sufficiently free from grease to allow an exhibition of the camphor dance.

To return to the floating ungreased needle. I introduced some camphor shavings, and they were lively. Then I repeated the experiment with a needle that was slightly greased, and the camphor seemed to be unaffected thereby. Finally, I smeared the needle with olive oil: an iridescence on the surface of the water

indicated diffusion of the oil. This time the camphor chips fell dead on the water, and remained wholly inert. Apparently therefore the needle will hold to itself a limited amount of oil or grease, which adheres so selectively as not to contaminate the water. But any excess of oil, more than the needle can hold, will be set free to modify the water and lower its surface tension.

Of course, there is a limit to the size of needle that can be floated. When the needle is floating it lies in a dimple or depression; if the needle is so heavy as to overcome the surface cohesion, the sides of the depression meet, and the needle is engulfed in the water. Bubbles of air can be seen attached to the needle when floating. The film of air is not continuous. Apparently the flotation is due to the resistance of the water surface to rupture, this resistance being caused by an elastic force that permits the water to yield in the form of a dimple. Moreover the air bubbles add to the buoyancy, both by their less specific gravity and by preventing the curved walls of the dimple from meeting overhead, that is, by widening the angle of contact. As the proverb says, "oil and water will not mix"; the adhesion of air to a metallic surface is matched by the molecular repulsion between the oil and the water.

As Mr. Durell suggests, the fact that grease is not essential to the floating of the needle is symptomatic of the trend of the flotation process. The oil is important chiefly as a means of lessening the surface tension of the water and so yielding air bubbles that will last long enough for the work of buoying the mineral particles.

In regard to the experiment described and discussed by Messrs. Durell and Norris, I have tried it and I recommend every student of flotation to try it, watch it, and cogitate on it. If kerosene oil is poured over colored water and air is blown into the lower liquid, a number of interesting phenomena can be observed. Mr. Durell sees bubbles enclosed in a film of the colored water rising through the oil and breaking at the surface, while the colored water of the bubble-film drops back through the oil exactly as a balloon on bursting drops to the earth. Mr. Norris conducts the experiment in two stages; in the first, he blows air gently and sees colorless bubbles rising through the colored water to the surface of the overlying oil; he says that these bubbles show no trace of color, and they are unaccompanied by a return passenger of colored water. He concludes that the bubbles have no film, but are simply holes in the water and oil successively. In the second stage of his experiment, he injects air with greater pressure, making larger bubbles, which pull the colored water to the surface of the oil. The bubbles are not colored, but they take with them flat portions of the colored water, which fall back when the bubble reaches the surface of the oil.

I have conducted the experiment many times, and my report is as follows: when the air is injected into the oil, the bubbles are short-lived, but they last long enough to prove, as we know already, that the oil is not a pure and perfectly homogeneous liquid. In such a liquid bubbles would not survive. The fact that two bubbles can touch

without coalescing proves that there is a film or membrane separating and surrounding them. When I blow air gently into the colored water, the rising bubbles are colorless. They accumulate at the surface of the oil, and show an attraction for each other, and for the sides of the glass vessel. These bubbles appear to last longer than those blown in the oil. Next, when I inject air more rapidly into the water, a bubble appears at the point of a cone or mound, as if it were dragging the water-surface with it. This bubble will remain poised for awhile at the peak of the mound of water before breaking away, and rising, while the water falls back. If the air be injected still more rapidly, the bubble breaks through the water-surface, appearing to tear it, and takes with it a portion of water. This is attached to the south pole of the bubble and may accompany it to the surface, where, on arrival, it drops away in a curious crescent form. If I introduce air still more rapidly, the water-surface is torn into pieces of odd shape.

The bubbles in oil are round or spherical; those generated in the water, as seen in their passage upward through the oil, are flattened; they are oblately spheroidal. The colored-water drop that leaves the south pole of the bubble, on its arrival at the surface, is also flattened; if small, it is crescent-shaped; if larger, it is oblately spheroidal.

It will be noted that I have said that this and that "appears" to take place. The difference in description by various observers indicates how difficult it is to see correctly. These are truly 'phenomena,' or appearances that are unusual and hard to explain.

As to Mr. Norris's idea that the bubble is simply a hole in the liquid, I would suggest that a globule of air takes to itself a film when in an impure liquid, that film consisting of some impurity or contaminant in concentratable form. Thus the hole becomes a sac. As the colored water and the kerosene are both impure liquids, we may infer the existence of a film on the globule of air, as indeed is proved on its arrival at the surface, where bubbles remain in contact without coalescing. The next question arising is as to what change the film of the bubble undergoes in the passage of the bubble from one liquid into the other. The watery film would, I suppose, be affected by coming in contact with the oil, and it would seem to me *a priori* that the bubble would arrive with a film of the liquid having the lower surface tension. This is a point I would like to refer to our friends, Messrs. Ralston, Durell, Norris, and Coghill, all of whom have contributed so generously and so usefully on the theory of the subject. That theory is no mere academic exercise; it is at the very base of any reasoned understanding of the flotation process.

T. A. RICKARD.

San Francisco, February 11.

RUTILE (titanium dioxide) production of the American Rutile Co., the only producer in the United States, was 250 tons in 1915, worth between \$25,000 and \$30,000. It is mined in Virginia.

Stoping Methods

By F. W. Sperr

[Descriptions of methods of stoping are usually dry and involved; it is frequently the case that a reader starting to read such an article abandons his good intention and decides to leave the perusal of the weighty treatise until he has more time—which never comes. Yet stoping methods are a matter of great importance. More than one mine manager has casually assumed that such-and-such a system of ore extraction would work out satisfactorily (perhaps the only method with which he was acquainted) only to face the fact later that the method is not practicable to the conditions, and that perhaps large blocks of ore have been lost through getting irremediably mixed with sand or waste. Then it is necessary to adapt another method of stoping to an underground development that was intended for some other system; the changing of stoping methods at an operating mine resembles “swapping horses while cross-

for danger of falling fragments, and which is too wide for the use of props or stulls; or a wide deposit under a strong and clean hanging-wall or capping, which becomes dangerous soon after it begins to ‘take weight,’ when the timber merely indicates what is coming. Sometimes such walls or cappings settle gradually without danger and no timber is used under them.

Do you consider that the square-set system or method of mining is being used more than is warranted; that is, where some less expensive method would seem to be better adapted?

The square-set system has been crowded out of many

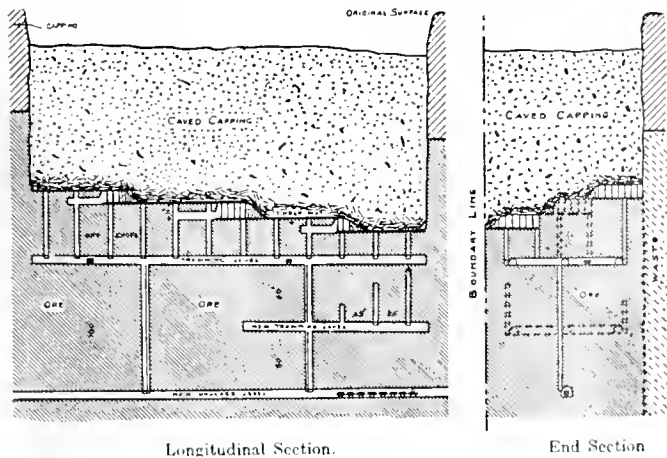

Longitudinal Section.

End Section

TOP-SLICING IN THE HUMBOLDT MINE, ARIZONA.

(From P. B. Scotland's paper, Bulletin A. I. M. E., Feb. 1915.)

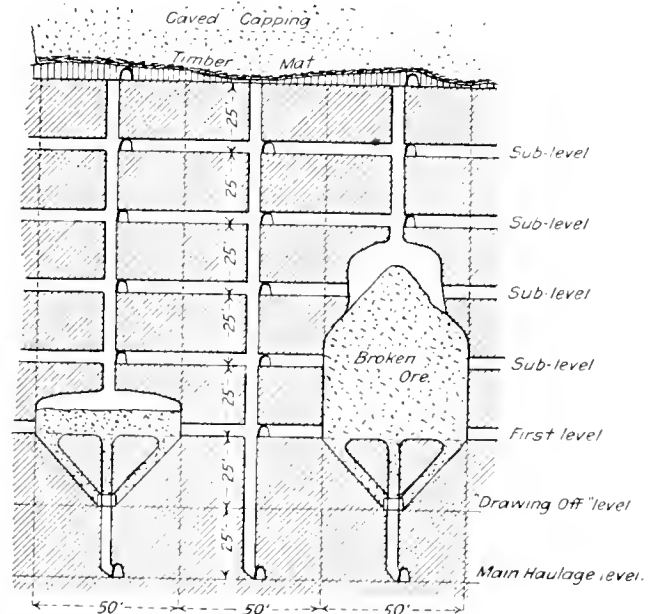

AN EARLY STOPE AT THE MIAMI.

ing a stream.” The difficulty in disseminating knowledge about stoping methods lies in putting it in shape so that someone will read it. To bring out a few essential points about methods of stoping, we invited Mr. F. W. Sperr, the Professor of Mining in the Michigan College of Mines and an acknowledged authority on the subject, to answer several questions. The questions with the answers are as follows.—EDITOR.]

To what kind of an ore deposit is mining on square-sets most applicable?

Square-sets are competent to form a skeleton-work in an open stope for the purpose of preventing fragments of rock falling out of the walls and back; and also to serve as an index in case any heavy movement of rock is likely to set in. As to what kind of an ore deposit mining on square-sets is most applicable, I would say a deposit which can best be mined in open stope, except

mines by better systems, and undoubtedly needs to be crowded out of many more. But a change of any system usually means a change of supervision, because the underground foreman knows what to expect from the method in use, and very naturally dislikes to try a new method with the behavior of which he is unfamiliar, unless the new method is one which he has thoroughly worked out for his own.

Should a distinction be made between the terms, ‘stopping method’ and ‘mining method’?

Yes, properly speaking. For example, we have the block-caving method of mining by cave-stoping; the top-slicing method of mining by cave-stoping; the top-slicing method of mining by open-stope; the sub-stoping method of mining by open-stope; the sub-stoping or sub-slicing method of mining by cave-stoping; the square-set method of mining by open-stope or filled-stope; the

room and pillar method of mining by any of the methods of stoping, etc.

It would appear that the use of the term 'caving' applied to mining is much overdone. What is the proper meaning of 'caving' as used in mining?

The term 'caving' is about as distinctive as the term 'stopping,' and perhaps it may as well remain so. It is comparatively new, to be sure; but people will soon learn that when they say "the mine is worked by the caving method" they have not expressed themselves definitely. The term now covers every method by which the overburden, or the ore, or even the filling in the stopes, is made to move downward by means of cutting the support from underneath. In 'top slicing' we have the caving of the overburden; in 'sub-slicing' we have the caving of the ore and overburden; in 'block-caving' we have the caving of the ore with or without caving the overburden; and in 'back-filling on floor-pillars' we have caving the filling when the floor-pillars are being mined out. Room-and-pillar stoping, followed by caving the pillars and overburden, is recognized as caving.

Does that mean that you divide underground methods of stoping into three classes based on whether: (1) the stope is open; (2) partly filled with broken ore or rock on which the miners stand to reach the back; (3) filled by rock or ore that follows or caves as extraction proceeds?

In that case we would have the 'open stope,' 'full stope,' and 'caving' as the primary subdivisions of stoping methods. But what shall we do with the 'full-stope-and-caving-the-filling' method? There always will be hybrid methods that cannot be distinctively classified. Perhaps, however, you should add a fourth class, depending on whether the stope is divided into chambers by pillars of ore; and let it go under the designation of the 'room-and-pillar' method. This should include the method of mining the Treadwell lode, as described by T. A. Rickard;¹ the methods of mining at Miami, described by R. L. Herrick;² the method of mining at Ray, as described by Lester A. Blackner;³ and many other methods. Properly speaking, however, the 'room-and-pillar' system is a 'method of mining' in which any or all of the methods of stoping may be employed. In reality there are but three methods of stoping: 1) the open stope; 2) the filled stope; and 3) the caved stope.

What is the significance of the term 'shrinkage' as applied to stoping methods and to what variety of ore-body do you consider a shrinkage system best adapted?

The term 'shrinkage' has been invented to signify what was long known as 'overhand stoping on broken ore' or simply as 'back-stoping on ore.' I prefer the older expression, because its significance is at once obvious to mining men. The newer term has led to such expressions as "we are mining the ore by shrinking it," and "we are shrinking the stopes," which, I think, are absolutely in-

defensible. What could be more lucidly expressive than "we are back stoping on ore?" (The evolution of terms is often interesting; and right here I would like to record one which is just now in the making; the use of the term 'hanging wall' has been well established, but it is in danger of being displaced by a new term. For short, it is called the 'hanging;' the Cornish miner calls it the 'angin'; our Italian miners, not quite catching the full enunciation of their English-speaking fellow-workmen call it the 'angle-wall,' and already now and then, one will hear a Cornish miner call it the 'hangle.')

The method of back-stoping on ore is best adapted to ore-bodies with strong walls, tough backs, and enough dip to allow the broken ore to follow down freely when drawn off at the bottom. The term 'shrinkage' to designate overhand stoping, or back-stoping, on broken ore, I believe, was first used by F. Percy Rolfe in a paper presented to the Institution of Mining and Metallurgy and published in Bulletin 55, February 11, 1909. It may have been suggested by the miners' explanation that they 'shrank' the pile of ore when it got too high in the stopes for their convenience. In the discussion of the paper Edward Hooper regrets that the subject has not been dealt with by some one with more intimate knowledge of methods, but admits that the paper is a most creditable one to have been written by a student; and proceeds to apply the term 'shrinkage' to the method in use at the Alaska-Treadwell mine as described by Robert A. Kinzie in a paper presented to the New York meeting of the American Institute of Mining Engineers in October, 1903. But we note that Mr. Kinzie had not yet learned that he was describing the 'shrinkage' method. In all the discussion there appears one protest against the use of the term; Henry Louis points out that the method differs but slightly from the one he has described as 'magazine mining.' It is truly wonderful how generally the old hands fell in with ('fell for' to be more modern) the use of Mr. Rolfe's term. It is a pleasure to see a student get his dues. Le Neve Foster, in his excellent book, 'Ore and Stone Mining,' 1894, page 330, and in subsequent editions, refers briefly to the method as the obvious thing to do in overhand stoping when there is nothing except broken ore conveniently at hand to stand on. But it was left for a student to whom it was new (and no doubt wonderful) to make an elaborate description and give it a name in literature. Of course, 'magazine mining' could hardly hope to meet with popular favor; but every English-speaking miner catches the idea when he hears such an expression as, for instance, "we b'long to shrink the pile." In the Lake Superior region, the term 'shrinkage' has come a little into use among practical mining men, but apparently it has come in 'from the surface' through some of the men who read technical mining literature.

What common systems of mining would you classify under the open-stope method?

Back-stoping on timbers, and without timber where the dip is not too great to allow the miners to work up-

¹MINING AND SCIENTIFIC PRESS, Vol. 97, p. 85.

²Mines and Minerals, Vol. 30, p. 751.

³Bulletin of the A. I. M. E., June, 1915.

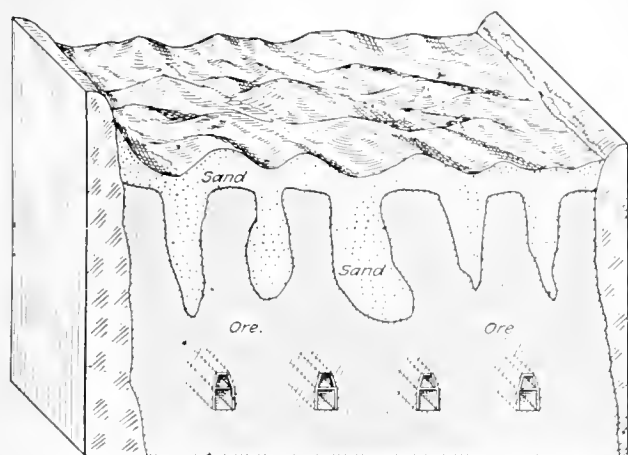

FIG. 1. THE EFFECT OF PROMISCUOUS CAVING.

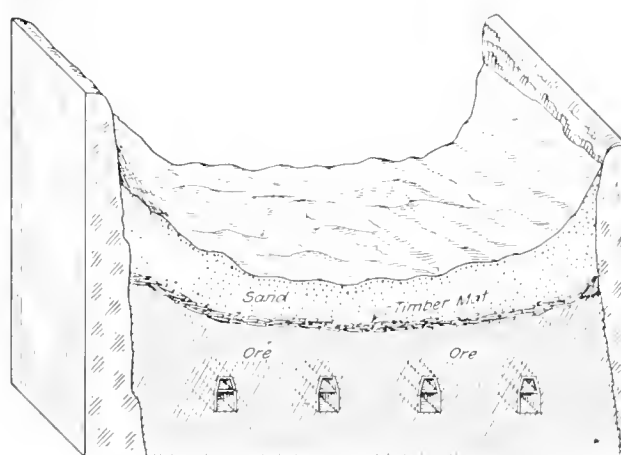

FIG. 2. BLOCK-CAVING CORRECTLY DONE.

ward on the foot-wall, which is commonly called 'back-stopping on the foot;' underhand stoping; sub-stopping; top-slicing and sub-slicing without caving the overburden.

Although it is impossible to generalize rigidly for hypothetical orebodies, what would be probably the most satisfactory method of stoping for a vertical orebody 100 ft. wide with firm walls considering that the ore is firm and homogeneous with no 'horses' of rock and that no underground sorting is necessary?

Either room-and-pillar or block-caving, or possibly sub-stopping, depending upon the texture of the ore. Block-caving would be given the preference if the ore would break fine enough in the process of caving and settling in the time that could be allowed between cutting-

off and drawing-off. The sub-stopping method would be preferred if the ore is free from slips, rather tough, not so hard as to make the sub-drifts too expensive, and if the walls and capping are strong enough to allow large panels to be stoped. The room-and-pillar method permits of going through the orebody and breaking it up as fine as may be desired with drill and powder, provided that the backs are safe. The Miami system as originally laid out, was an elaborate room-and-pillar system where block-caving would probably have served to better advantage, see sketch. The Zimmerman mine in the Iron River district of Michigan, attempted block-caving without proper preparation, with the result something as illustrated in Fig. 1. The Ray system is room-and-pillar stoping, followed by caving pillars, broken ore and overburden,



CAVING OF THE SURFACE AT RAY, ARIZONA.

where the block-caving system might have found most excellent adaptation without any preparation of timber mat under the capping.

With the same reservation as to generalization what would be probably the best method for a similar orebody 10 ft wide?

Back stoping on ore. Either on arches or on stulls and lagging.

If the 100-ft. orebody were composed of soft wet ore of no firmness at all and the walls were not much better, what would be probably the best system?

Block-caving, preceded by drainage and proper preparation, and accompanied by skillful supervision; see Fig. 1 and Fig. 2.

What are the significant features of block-caving which is generally understood to be a comparatively new method?

The block-caving method of mining was introduced about twenty years ago in the Pewabic iron-ore mine at Iron Mountain, Michigan. The method was described by E. F. Brown at the meeting of the Lake Superior Mining Institute at Iron Mountain in 1898, under the title of "A System of Mining Orebodies of Uniform Grade." It may be said, however, that uniform grade of ore is not essential, but rather that a close selection of grades is impossible. The method soon became known as block-caving. It is distinguished from other caving methods by the depth of ore caved to the undercut. This depth of ore caved grades from zero in top-slicing, through sub-slicing, to the full depth from level to level in block-caving.

Block-caving methods may again be distinguished from each other by the different methods of making the undercut. In the Pewabic mine the conditions were favorable for making the undercut on the sill floor without timber; but timbered drifts through the caved material were used for the drawing-off. The capping was a strong, hard sand-rock that gave no trouble in becoming mixed with the ore. Under a different type of capping with a similar texture of ore, it has been found better to make the undercut on an arch above the haulage level in much the same manner as it is made in the other case on the sill floor.⁴ The caved material is then drawn uniformly from all parts of the block through chutes closely spaced in the arch over the drifts and cross-cuts on the level. If the capping is of a certain texture like hardpan, it may follow downward without mixing with the ore; but if it is loose material like sand or gravel, a top slice of ore is removed and the space filled with timber to form a mat between the ore and the capping.

The difficult part of the operation, when the undercut is made on the sill floor, comes in the opening and maintenance of the timbered drifts through the caved material, for drawing off the ore. The chief difficulties in the operation when the undercut is made on a sub-level,

come in maintaining the haulage ways and in breaking the large pieces that block the chutes. For removing a block of ore that has been caved to the sill floor, nothing better has been devised to take the place of the timbered drifts that have been used in the Pewabic mine from the beginning of block-caving. But for removing the caved ore through chutes, some modifications have been made, both for breaking the large pieces of ore and for maintaining the haulage ways. At first it was the custom to break the chunks in the chutes by attacking them through the gates. This process has been facilitated in some of the mines by means of the double-deck timbered drift, and in others by means of sub-drifts between the haulage level and the under cut, thus giving access to the sides of the mills and allowing much of the breaking to be done with hammers which would otherwise have to be done with drill and powder at greater expense, loss of time, and often danger to the miner as well as to the chute.

The ordinary rigid method of timbering by means of legs, caps and studdles, requires a great deal of repair work in heavy ground. To alleviate this difficulty, a system of timbering has been devised on the theory of yielding supports. Instead of legs with the weight coming on the end-timber, blocking is used with the weight coming on the side-timber, with the result that a considerable downward movement can take place without destroying the drift. Instead of supporting caps and chute-gates by the same set of legs, the thrust on the caps is transmitted to the floor through independent sets of compressible blocking, preventing the lip of the chute being pressed below the top of the tram-car.

Furthermore, the method of timbering the drawing-off drifts on the yielding principle, not only reduces the cost of repairs, but also makes possible the maintenance of the drifts in heavier ground. Thereby a wider field is opened for the block-caving of orebodies that are too soft to stand undercutting without timber and are covered by a capping that does not permit the use of the Pewabic method of drawing the ore. Under an unfavorable capping that requires the ore to be drawn uniformly from all parts of the block, this method of timbering makes it possible to provide and maintain chutes in sufficiently close proximity to each other under the whole block, provided that excavations in the soft ore in its original, undisturbed position, will stand open in sufficient dimensions for a length of time to permit placing the timber. The existence of such a condition will be indicated by the manner in which the drifts stand without support when a level is first opened. Before movement sets in, an excavation in many soft-ore bodies will stand open for a long time without artificial support.

On first impression it appears that an excessive amount of timber is required for the yielding supports, but in fact the repair work is so little that the total consumption of timber is ultimately less by this method than by any other. The method of timbering described makes it possible to provide and maintain chutes in sufficiently close proximity to each other. It then becomes only a

⁴Described by F. C. Roberts at the meeting of the Lake Superior Mining Institute in 1911.

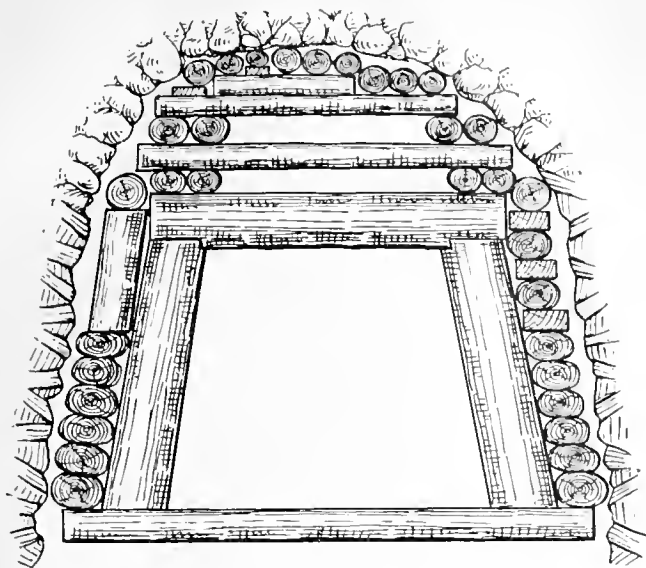

THE UPPER BENT IN TIMBERING FOR BLOCK-CAVING.

matter of finishing the undercut near the top of the timbers by barring operations through holes provided for the purpose; after caving begins, the ore must be drawn off fast enough to keep excessive weight off the timbers. Soft orebodies in their natural position are often able to hold in place without movement until they are almost completely undercut. By the block-caving method there is greater safety, greater production per man per day, a higher possible percentage of extraction, and the ventilation is better, beyond all comparison, than with any of the slicing methods.

What would be the probable best method for a similar orebody 10 ft. wide?

Top-slicing.

To what variety of orebody do you consider the dry-

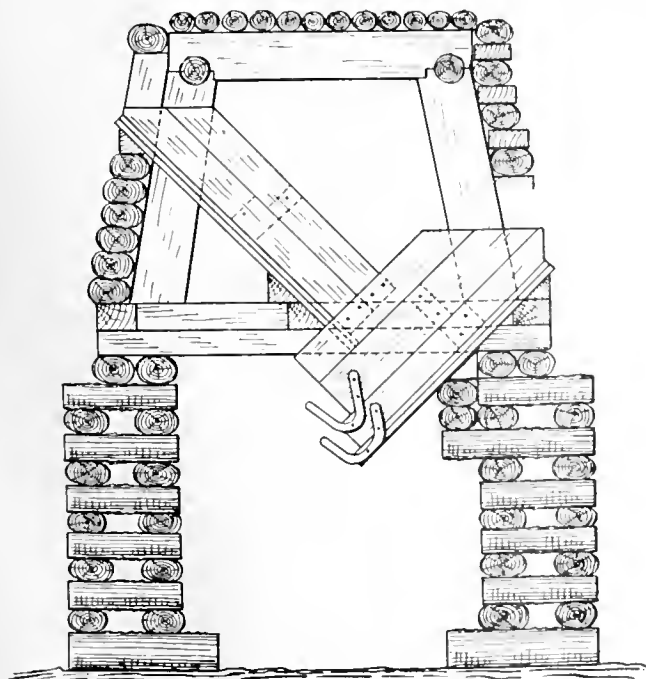

THE NEW TIMBERING FOR BLOCK-CAVING.

wall method as practised on the South Range of the Copper Country best adapted?

In the first place, there must be available suitable waste-rock for building dry walls. Then the orebody should be 15 ft. or more wide and steep enough to allow the selected ore to run readily through the chutes that are built upward from the dry-wall and surrounded with

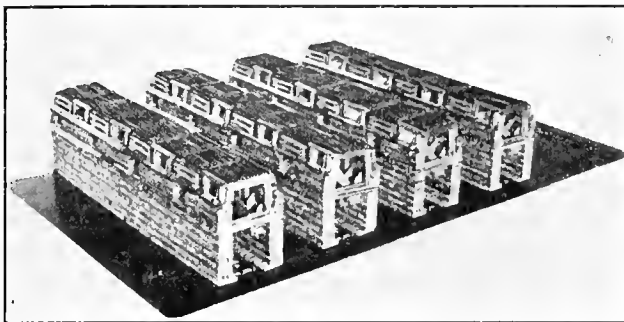

A MODEL OF THE NEW TIMBERING.

filling material. The backs should be tough and strong, although protection against falling fragments can be provided by means of cribs and props.

Safety-First Exhibit

There will be held in Washington, D. C., during the week of February 21-26 inclusive, a safety-first exhibit in which all of the Government departments are taking an active part. This exhibit will take on a National aspect, as manufacturers and operators from all over the country are invited to be present, in order that they may see what the Government of the United States is doing in safety-first work. Franklin K. Lane, Secretary of the Interior, has sent a letter to the governor of each State inviting him to send a delegate, and asking that the chief mine inspector, a representative of the industrial commission, or of other agencies engaged in compiling statistics relating to the various mineral industries, also attend this exhibition. It is hoped that all interested persons will visit the safety-first exhibit, and will attend the conference of State mine inspectors, which will be held at the office of the U. S. Bureau of Mines, on February 24.

THE TAVOY DISTRICT, lower Burma, India, exported 1631 tons of wolframite concentrate in 1914. The ore occurs in arenaceous and argillaceous schists, pierced by granite, forming domes, which contain the richest deposits. Oxidation or decomposition, due to heavy rain, is extensive. Cassiterite occurs in the lodes, also molybdenite. The yield of over 18 months was 2.4%. The best product averaged 72.8% WO₃. Chinamen do most of the mining. In 1913 there were 2368 laborers. Machine-drills are not used yet. Selection of ore is done in the mine. Hammers and eradle concentrators are used to dress the ore, with much loss. Some alluvial wolframite is found. A royalty is paid to the Government.

Refining Cupriferous Precipitate

By Jackson A. Pearce

THE Argo mill, Idaho Springs, Colorado, is a custom mill treating ores assaying from a trace to as high as 3 or 4% copper. In the cyanidation of these ores much copper is taken into solution, and later precipitated along with the gold and silver in the zinc-boxes. While the copper has been no obstacle to satisfactory precipitation, it has greatly interfered with the refining of the precipitate.

In the ordinary method of refining, namely by treating with acid, drying, and melting, the bullion is never better than 750 fine in gold and silver, and frequently as low as 550, copper constituting the greater part of the 450 of base metals. The accompanying analysis of a sample of the untreated precipitate shows the high percentage of copper, and the normal ratio of the silver to the gold; the percentage of copper is not uniform, varying from 15 to 30%.

| | % |
|--------------|------|
| Gold | 4.3 |
| Silver | 13.8 |
| Copper | 21.6 |

This high proportion of silver precludes the application of the usual methods for the removal of the copper. The process of roasting with subsequent leaching of the oxidized copper is not only a tedious operation, but one in which the loss by dusting and by volatilization is high. The use of oxidizing agents, for example, manganese dioxide or nitre, for the purpose of slagging the copper is not applicable, since an appreciable amount of the silver is likewise oxidized and dissolved by the slag. Copper can be, and frequently is, removed as a matte, but as copper matte is an excellent solvent for gold and silver, the formation of sufficient matte to remove the 15 to 30% copper of the precipitate would remove a prohibitive amount of the gold and silver. Occasionally matte is formed in spite of efforts to prevent it, and the prevalent practice of converting it to an iron matte by the addition of scrap-iron would remove a large proportion of not only the gold and silver, but of the copper as well.

For 18 months I have been using successfully a wet method for the elimination of the copper. It consists essentially of the oxidation of the copper with the subsequent dissolution of the copper oxide by sulphuric acid. For oxidation I am at present making use of the time-honored action of sulphuric acid on manganese dioxide. Commercial manganese dioxide (pyrolusite) is used on account of its convenience and cheapness, although several of the higher oxides, including hydrogen peroxide, have given good results on an experimental scale.

The equipment necessary for the operation of the process is common to nearly all the refineries, namely,

vats, filter, and furnace. The sludge from the zinc-boxes is treated with an excess of acid until action ceases. Pulverized pyrolusite then is added, in proportion to the amount of copper to be removed. I find that with this precipitate, 4 to 6 pounds of pyrolusite removes one pound of copper. A rough estimate is made of the amount of copper to be removed, and a quantity of pyrolusite considerably less than the estimated amount required is added to the charge. The charge is kept distinctly acid and in agitation. Evolution of oxygen proceeds immediately upon the addition of the dioxide to the acid. The nascent oxygen at once oxidizes the finely-divided copper, which, being oxidized, is immediately dissolved by the excess of sulphuric acid. Equations representing these reactions may be written as follows:

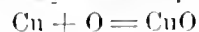
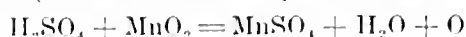

Inasmuch as silver is analogous to copper, in that it is easily oxidized and the oxide is readily soluble in sulphuric acid, we should expect to have an appreciable amount of the silver oxidized and subsequently dissolved. Doubtless the oxidation and dissolution of the silver are among the many chemical changes taking place in the vat, but, owing to the presence in suspension of the finely-divided electro-positive copper, the silver at once is re-precipitated as metallic silver. The cycle of the silver may be expressed in this way:

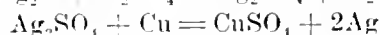
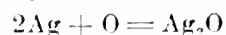

Accompanying a continuous evolution of oxygen there is a constant oxidation and dissolution of both copper and silver with a continuous replacement of the dissolved silver by the copper, until the metallic copper has been removed from the sphere of action. With the removal of the copper, the silver makes its permanent appearance in the solution and constitutes an end-point, so to speak, of the process.

Usually the first addition of manganese di-oxide is not sufficient to oxidize all the copper. If the manganese di-oxide is finely powdered and the solution hot and distinctly acid, the reactions are complete within a few minutes. When all action has ceased, the solution is tested for silver, using bromine water. With a precipitate containing as much as 20% copper the solution should be strongly colored with copper sulphate. If there is no indication of silver in solution, another, but smaller, portion of manganese di-oxide is added together with sufficient acid to maintain the acidity of the solution. A few applications of the chemicals in this manner

are usually sufficient to bring the silver into solution. All the copper now, except the few coarse massive particles that are generally found in the sludge, together with some of the silver, is in solution. Gold will not dissolve under these circumstances, notwithstanding the ease with which the silver dissolves. A solution assaying as high as 64 oz. silver per ton shows only a trace of gold. It is now a matter of importance to remove this silver from the solution before removing the solution from the sludge. Continued agitation of the charge would bring the coarse particles of copper to react with the silver sulphate, and in due time would precipitate the silver. But time is an object in refining, and, as this action requires more time than can be spared conveniently, it is better to use some other method for the precipitation of the silver. A small amount of hydrochloric acid, salt, or other soluble chloride may be added to precipitate the silver as a chloride, or a small amount of zinc-dust may be used. A portion of the original cupriferous sludge may be employed. Usually I set aside a small portion of the sludge, taken before the addition of the oxidizing agent, to be used as a silver precipitant.

The use of chlorides to effect the precipitation of the silver is open to the objection that a chloride, sulphuric acid, and manganese di-oxide generate chlorine, and that chlorine speedily attacks the gold. This is true except when the oxygen generated is in large excess of the chlorine, or when there are sufficient silver ions present to remove the chlorine ions thus formed. As a matter of interest it may be noted that a mixture of salt with a large excess of manganese di-oxide and sulphuric acid does not dissolve gold, but, on the contrary, is an active gold precipitant. The explanation of this apparent anomaly lies in the mutual or auto-reduction of two oxidizing agents, gold chloride on the one hand, and hydrogen peroxide or nascent oxygen on the other. Equations representing these reductions probably would be as given here. With gold chloride and hydrogen peroxide:

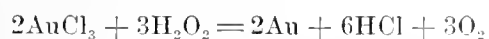

And in the case of atomic or nascent oxygen:

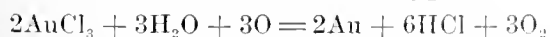

As the object in adding the chloride is to remove the silver, and as the generous evolution of oxygen has ceased, the two safeguards against the dissolution of the gold are absent, so that extreme care should be exercised in the use of the chloride as a precipitant. It is safer practice to use a small amount of zinc-dust, or, even better, a small quantity of the cupriferous sludge.

Having precipitated the silver by some convenient method, the charge is drawn into the filter, washed, dried, and melted. Some precaution should be taken against the solution coming in contact with the iron of the press, pumps, etc., as the iron precipitates the copper, and in the course of a short time the machinery will be destroyed. Triplex pump-cylinders quickly deteriorate, and any iron parts of the stirring mechanism are soon destroyed. Lead-lined or wooden tanks should be used, and where necessary to pump the solution, lead-

lined centrifugal pumps with brass runners should be used; also lead-lined pipes. For a filter we are employing a rectangular wooden vacuum-pan, 3 ft. wide by 6 ft. long, with a sludge compartment 15 inches deep and a filtrate compartment 20 in. deep. A 4 by 6-in. triplex pump serves as a vacuum-pump. This pump is attached to the filtrate compartment immediately below the filter-bed, by which arrangement it is possible to filter the sludge without drawing the filtrate into the pump. To maintain a wet vacuum the pump is allowed to draw a small amount of water from an independent source.

The filtrate assaying 0.005 oz. gold, 0.03 oz. silver per ton, and from 3 to 4% copper is treated with scrap-iron for the removal of the copper, and is discharged to waste. The filtrate compartment of the vacuum-pan contains scrap-iron upon which the copper is precipitated. The solution being hot, precipitation proceeds rapidly.

Formerly I removed the zinc sulphate solution by decantation, filtration, and washing previous to applying the copper treatment, but as the results are equally as good by treating for copper without removing the zinc sulphate, and as considerable time is saved thereby, treatment for copper follows immediately upon the acid treatment. The time consumed by this extra refining operation is from one to two hours.

A 20-30% copper sludge is reduced to 2-4% copper within a couple of hours. The bullion that formerly assayed 550-750 fine now assays better than 900. The saving in fluxes, crucibles, and time of melting is appreciable, but the greatest saving is in transportation and mint charges. Whereas formerly the mint charge on bullion containing 1000 oz. gold and silver was from \$75 to 85, it is now less than \$25.

To show the effect of this oxidation process on the quality of the bullion, I am here giving the assays of two bars, bar No. 25 refined in the ordinary way, and bar No. 31 refined with the aid of oxidation:

| BAR No. 25 | | BAR No. 31 | |
|------------|------------------|------------|-----------------|
| Gold |207.35 fine | Gold |298.5 fine |
| Silver |561.84 " | Silver |624.5 " |
| Copper | 22.1% | Copper | 0.6% |

The particular method of applying the oxidizing agent is of small consequence, since the copper is attacked with avidity. Results obtained by adding the powdered manganese di-oxide to the sludge with an excess of dilute acid are as good as when it is added to the thickened sludge from which the excess solution has been decanted, provided only that sufficient water is present to dissolve the copper sulphate formed. Good results may also be obtained by incorporating the oxidizing agent with the sludge-cake from the press and leaching it with an acid solution. The temperature should be high to accelerate the action, otherwise it works well in a cold solution. It should be borne in mind that the rapidity of the action depends also upon the fineness of the manganese di-oxide. The mineral pyrolusite is ground for commerce and sometimes contains an appreciable amount of coarse material. The dissolution of this coarse material by sulphuric acid may not take place within 24 hours. All

that is not dissolved within the time of treatment must be slagged off in the melt. If it is not decomposed in the process of drying it is available in the melt to oxidize some of the remaining copper, also some of the silver. This residual manganese dioxide makes dangerous the use of chloride for the precipitation of the silver as has been noted elsewhere. It is more quickly acted upon by hydrochloric acid than by sulphuric acid. Were there no residual oxidizing agent the chlorides could be used with impunity.

An interesting point in the process is the amount of zinc dissolved aside from that dissolved by the acid treatment. Four separate laboratory tests showed that almost twice as much zinc was removed as copper. Some of the sludge direct from the zinc-boxes was treated for three days with several changes of acid both hot and cold, of varying concentration, and the residue washed until the wash-water showed no zinc by the ferro-cyanide test. The treatment for copper was then applied and

the filtrates assayed for copper and zinc. The results are shown in the table.

| Test No. | Copper, | | Zinc, | |
|----------|---------|------|-------|--|
| | % | | % | |
| 1 | 0.86 | 1.15 | | |
| 2 | 0.56 | 1.24 | | |
| 3 | 1.51 | 3.85 | | |
| 4 | 1.00 | 9.60 | | |

In explanation of this it might be recalled that precipitation is due to a large extent to electrolytic action and it might be that small particles of zinc are entirely coated with copper, sufficiently to prevent the contact with acid until the copper has been removed by oxidation and dissolution.

In this process the lead is not removed; the finely-divided lead is probably oxidized and then transposed to the sulphate, but the sulphate is not dissolved appreciably in the dilute acid. At the present time about 95% of the base metals in the bullion is lead.

The Sons of Gwalia Mill, Western Australia

*To a depth of 3100 ft. the ore in this mine, situated 150 miles north-east of Kalgoorlie, consists of 68.4% silica, 9.71% alumina, 1.85% ferric oxide, 3.61% calcium oxide, 11.04% calcium carbonate, 2.15% magnesium oxide, and 3.15% iron pyrite. Its specific gravity is

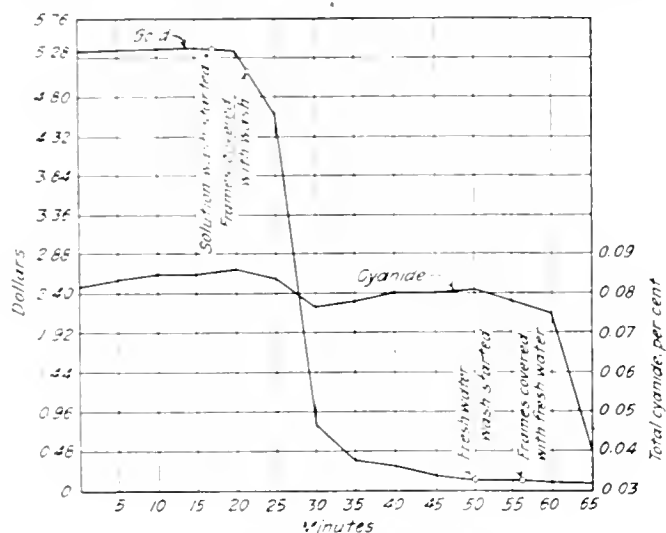

Gold solution \$5.49 per ton 0.085% total cyanide
 Solution wash 8 cents per ton 0.08% total cyanide
 Water wash 2.5 cents per ton 0.12% total cyanide.

FILTER-CHART FOR SONS OF GWALIA PLANT.

2.69. The gold value is \$7.20 per ton, this metal being very fine, alloyed with $\frac{1}{12}$ its weight of silver. Pyrite in schist is the richest part of the ore. Fine-grinding and amalgamation extract 85% of the gold, according to Thos. B. Stevens. When this ore is crushed a concentration of both mineral and gold takes place in the fine

sandy portion. For successful cyanidation, fine crushing is essential. Sand-leaching gives a low recovery. The economical limit of grinding is 150 mesh; on the Rand, with a similar ore, this point is 90. All the Gwalia ore requires sliming, including the pyrite. The reduction plant consists of a No. 6 Gates K crusher; fifty 1150-lb. stamps with 108 drops of 7½-in. per min.; screens, with an aperture of 0.097 sq. in.; ten 5-ft. diameter grinding-pans making 60 r.p.m., fitted with Freeman pipe-classifiers, and three 4½ by 18-ft. tube-mills, working at 27 r.p.m. The intermediate accessories are a 53-ft. tailing-wheel, diaphragm-cones, and spitzkasten.

From three 28 by 10½-ft. mechanical thickeners the slime goes to agitators 28 by 6½ ft., constructed from old leaching-vats, consisting of mechanically-driven arms and a distributing air-lift. Five horse-power is required and 70 cu. ft. of free air per minute. Of the total, 72.5% is extracted by cyanide, only 28.7% is dissolved in the agitators, while 19.4% is dissolved in the pans, 8% in tube-mills, 1.5% in launders, classifiers, etc., and 1.5% in the mortar-boxes.

The pulp is porous, and the vacuum-filter has a high duty. With 27-in. vacuums and 40% solid pulp, a 3-in. cake containing 28% moisture and 20.5 lb. dry slime per sq. ft. can be obtained in 20 min., while an hour is required for washing with barren solution and water. The accompanying chart shows the rate of filtration and value of solution. Cloths last six months.

Solution precipitated amounts to 1.6 tons per ton of ore treated. Zinc-shaving is used for precipitation, aided by 0.3 oz. lead acetate per ton of solution. Clean-up is done twice a month, there being nothing unusual in the method. The bullion contains 799.3 parts gold, 81 silver, 32.5 lead, 64.8 copper, 9.3 iron, and 12.1 zinc.

On an average of 13,534 tons of ore per month for six months, the cost of treatment was \$1.39 per ton, divided as follows: crushing and transport 9; stamping 26; tube-mills 19; agitation and filtration 55; precipitation and melting 15 cents per ton.

*Abstract from *Monthly Journal of the Chamber of Mines of Western Australia*.

Flotation Principles

By C. Terry Durell

IN attempting to start a discussion on flotation by setting forth my osmotic hypothesis, the main objects were (1) to firmly establish fundamental laws and definitions and (2) to bring out and classify new phenomena. Flotation terms have been misused and jumbled in the same way that the so-called expert makes a mining report ridiculous by the use of geological terms. Litigation has made the subject more confusing, and it is still an indefinite cloud to most people. Now that first principles and definitions are being agreed upon, concerted effort is starting experimentation along definite lines that will lead to far-reaching results instead of the heretofore duplication of efforts leading to nothing. Before the final solution of a problem can be accomplished, the problem must be stated properly. It is therefore quite gratifying to see that the discussion is fulfilling the two main purposes and that the flotation problem now stands out more clearly.

A man can never learn from one who agrees with him entirely. For this reason I was pleased to see exceptions taken to my article 'Why Is Flotation?' O. C. Ralston thinks I used rather loosely the two words 'nascent' and 'occlusion.' It took me a long time to realize the prime essential for an effective froth. This can only be described clearly by the word 'nascent.' It also required several years of patient effort to convince myself that the whole subject depends on gas 'occlusion.'

Being unable to learn anything more in this country concerning flotation, some four years ago I made a trip to Australia, the home of flotation. There I saw for the first time copper concentrate won by flotation. At the Lake View, in the Kalgoorlie district, I saw one of the old bulk-oil flotation plants.

It was at Broken Hill, however, that I had plenty of time and opportunity to study flotation. Companies using different processes were naturally adverse to entertaining a stranger who might be gathering information to be used against them in one of the various law-suits. As soon as the managers or officials in charge were assured that I was not there for that purpose, they afforded me ample opportunity to learn everything concerning flotation, giving me access to figures and data. In this country, it is seldom that a comparative stranger receives such courteous treatment as was shown me by the cordial company officials there.

At the Proprietary mine, where the Delprat process was in operation, no oil was being used, yet there was practically the same persistent froth as at other plants using the Minerals Separation process. This fact then eliminates the two hypotheses for flotation advanced

by Mr. Ralston¹, who says that "The first hypothesis is based on some academic work done by Reinders, who deduced the following inequalities as applying to a case where a powder, or the particles of a colloid, is suspended in a liquid to which is added a second liquid that is immiscible with the first." There at the Proprietary mine, where 500 tons per day was being treated by a single 'cell,' no such liquid was used. Therefore, according to Mr. Ralston's hypothesis, froth-flotation could not take place. Yet the records show that thousands of tons of zinc concentrate have been recovered by froth where no oil was used. I quite agree with Mr. Ralston when he says "It hardly needs to be said that here we find something very close to the conditions obtained in the flotation process." "In fact, the old Elmore bulk-oil flotation method fulfills exactly the conditions that Reinders had in mind." By basing the whole subject of flotation on gas occlusion, as I have done in my article, 'Why Is Flotation?' in *MIXING AND SCIENTIFIC PRESS* of September 18, 1915, all flotation processes may readily be explained.

On seeing for the first time a single spitzkasten being fed 700 lb. of ore per minute by means of a 'push-feeder' as is done at the Proprietary, one can but marvel at the simplicity and rapidity of action of this froth-flotation process, which makes a marketable zinc concentrate with high recovery without re-treating. As no oil was used, I summed up as follows the essential elements: gas, acid, and heat, in addition to ore and water. There is nothing else essential to this treatment. Studying the conditions there, I soon became convinced that the function of the acid was not only to produce bubbles for froth-formation, but also for the creation of selective action. Since the solution was kept as near the critical temperature of 80° C. as possible, no air from the solution could aid in froth-formation because the solution was under a hydrostatic head and was admitted at the bottom of the spitzkasten instead of by means of a jet above the surface. It was easily seen that the function of gas was for froth-formation and that the persistence of the bubbles was mainly due to the enveloping net of mineral particles. What then was the function of the heat? The cold ore dropping into this hot solution carried some air with it which the heat expelled. This was not the essential factor. The heat expelled enough of the occluded gas from the ore particles to form nuclei for the attachment of nascent gas to form flotation bubbles.

Studying the Elmore vacuum process at the British

¹ 'Why Do Minerals Float?' by O. C. Ralston, *M. & S. P.*, Oct. 23, 1915.

Broken Hill plant at a later date, I summed up the essential elements there as follows: vacuum (to liberate the air), acid, oil, and alkali. At a first glance it was seen that here was another method of making bubbles and froth. This froth was perhaps more persistent, as the envelope for the bubbles seemed tougher. The difference was so slight that it is best described as that between the froth formed during the early stage of the clean up in the acid or 'cutting down' tank of a cyanide plant and the froth formed during the later stages. It was natural, therefore, to assume that the principle or cause of this Elmore process of flotation was identical with that of the Delprat at the Proprietary. I was told there, and have been repeatedly told since, that the oil was the cause of the selective action. I never will believe this, with all the evidence against it, although on account of adsorption—not occlusion—of gases by the ore particles, they are more easily wetted with oil than with water. The results at these two mines were practically the same. The grade of the concentrate at the British plant was higher, by reason of mechanical refinements, and not the difference in process. Therefore the oil could not be the essential element for selective action, because no oil was used at the Proprietary. The oil was an essential element only in that it toughened the froth. Owing to mechanical means of operation, the froth could not be removed so quickly nor could it be carried in such a deep layer. Therefore oil was added to toughen it. Using Mr. Scott's words², "This froth rises and floats much the same as a board would" while the Delprat bubbles "float over, if we get them over before they break"; and "if they do break, the mineral drops and is caught by the bubbles below." Oil, then, can be eliminated in making the following comparison between the essential elements of these two processes. Acid creates the selective action as in the Delprat method; lime is then added to neutralize it, because the vacuum machines are of cast-iron. Acid was found to be necessary in the Delprat process to create the bubbles. It was necessary for these bubbles to form as they "came into being" on mineral particles as nuclei. Nascent bubbles of air are formed in the same way, so that the vacuum of the Elmore process takes the place of the acid in the Delprat.

At the British plant, in making a froth, the solutions were not heated, for the reason that the vacuum which drew the dissolved air from the liquid, in accordance with the law of Henry, also drew a sufficiency of occluded air from the mineral particles to form nuclei for the air "coming into being" from the liquid. The acid had already acted as previously described. The small slow-speed mixer, just ahead of the vacuum machines, used for stirring oil into the thickened pulp, could in no way super-saturate the mass with air as is the case with a Minerals Separation machine, which process will be taken up later.

When I began the study of the De Bavay process at

the Amalgamated Zinc plant, I was at a loss, at first, to see how the same principles underlying the other two processes just mentioned could apply there. The following essential elements were separated out: gas (in the form of air), acid, and oil. Mr. Meredith told me the object of the acid was to clean the mineral particles. While it undoubtedly does this, my contention is that it acts as an electrolyte, as I have described, to create the selective action afterward manifest during the oiling and aerating stages of the process.

Oiling of the mineral particles is the next stage and can only take place in liquid pulp, as I have explained, when particles themselves contain gas. It required a careful study of the apparatus at the Amalgamated plant before I was able to understand that the same underlying principles applied here. Air was necessary; yet where and how was it introduced? This is best described in T. J. Hoover's³ words: "Throughout this manipulation, including the acid-washing, the oiling, the raising with compressed air, and the flowing over the corrugated cone, the sulphide particles are repeatedly aerated, and as a result, especially after the oiling, take up their adhesive air-films and float." They were not using corrugated cones when I was there. Instead, the cones were covered with concentric rows of staggered triangular obstructions. These were made by bending the triangular burrs from holes punched in galvanized sheet-iron cones until they were perpendicular to the surface. These cones were then fitted down tightly over similar cones not punched. A montejus was used to lift the prepared pulp to these cones. As Mr. Hoover says, "The subjecting of the oil pulp to compressed air may be an essential part of the operation." It undoubtedly is, and this method is patented by Dudley H. Norris,⁴ although opposed by Minerals Separation Ltd. when application for patent was made in England.

The De Bavay float is caused by air. Why is it not a froth? Norris turns his super-saturated liquid directly into the pulp-mass and a froth is formed. The pulp-mass at the Amalgamated Zinc plant, super-saturated with air, was turned on to the top one of each series of four cones. There was no chance for froth to form while spreading in a thin stream over the surface of a cone. This float, however, is entirely different from the unstable float on the Henry Wood type of machine, which depends on surface tension entirely. It is best described in the words quoted from De Bavay: "When the contents of the receptacle were emptied into a beaker, a thick clean layer of 'black-jack' sprang to the surface of the liquid, while the white clean gangue was precipitated to the bottom."⁵

Upon studying several plants using the Minerals Separation process, the following essential elements of flota-

² 'Concentrating Ores by Flotation,' by Theodore J. Hoover. Second edition, page 117.

³ U. S. Patent No. 864,856, Nov. 19, 1906.

⁵ 'Flotation in Australia,' by Charles S. Galbraith, *M. & S. P.*, July 17, 1915, page 85.

² Walter A. Scott, counsel for defendants in the case of *Minerals Separation v. Miami*.

tion were easily recognizable: air (beat in by stirrers to super-saturation), acid, oil, and heat.

It is to be noted that these are the same as described in the other processes. Practically the only difference is that the froth is more persistent, because there is more slime with which to armor the bubbles. The violent agitation coagulates the exceedingly fine metallic particles in the same way that butter forms in a churn. These coagules are then taken up in the froth the same as larger metallic particles. As Mr. Hoover⁶ states, "Large quantities of air are beaten into the pulp. By running the machine for a few minutes on water alone, it will be observed that the quantity of air so beaten into the pulp is enormous, for the clean water will be milk-white." This air, as it "comes into being," uses the mineral particles as nuclei from which to grow into bubbles.

The résumé of these commercial processes is to show that nascent gas is necessary. The only explanation of single selective action for all processes is that gas is held in the solid particles.

A theory that will not explain all of these processes is of no value whatever. Both of Mr. Ralston's hypotheses depend upon the use of oil, which is not an essential element to flotation, as was shown above. Also these hypotheses assume that bubbles, existing as such in a liquid pulp, can then have mineral particles attached to them. If this be so, and it is not necessary to grow, as it were, the bubbles from the nascent gas in the liquid, why is it necessary to beat air into solution beyond the saturation point as is done in all froth-flotation machines using air as an adjunct except in the Callow machine? It would be much simpler to turn in a stream from a compressor or blower. If electrification is then all that is needed to produce attachment of the mineral particles, surely there are plenty of ways to electrify the bubbles. Thomas M. Bains⁷ says, "It would seem easier, therefore, to electrify a bubble than to keep it from being electrified." No; something more than electrification is required of the bubble, as all who have tried to produce a float in this manner well know. James A. Block⁸ in his criticism on my article says: "I cannot see how the water in a Callow or other pneumatic machine can become greatly super-saturated." This is best answered by Mr. Callow⁸ himself: "The bubbles composing the froth are generated under a hydraulic pressure varying from 15 to 40 in." It matters not whether the water be saturated "with air at a pressure of several atmospheres," as was done by Norris, or under a hydraulic pressure of 15 inches, because, as I pointed out, it is not the air that is held dissolved, but it is the air that comes out, which is available for mineral attachment. A hypothesis based on nascent and occluded gas explains all kinds of flotation as well as all flotation machines.

More flotation experiments have been carried out in

Australia than in any other country. No publication of systematic experiments to learn the reasons for flotation is so complete as that in the proceedings of the Royal Society of Victoria, by Kenneth A. Mickle.⁹ His experiments (many of which I have verified in the laboratories of the Colorado School of Mines while experimenting in the new testing plant there some three years ago with the Horwood process) showed nascent gas necessary and also that the particles must contain gas. He showed by experiments that (1) heat or reduction of pressure to liberate gas, that (2) generation of gas by means of acid, or that (3) super-saturation of solutions with gas, will cause minerals to float or tend to float without the aid of oil. He showed the effect of gases occluded by minerals to be (1) the particles are not wholly wetted when immersed in water; (2) the particles tend to float when sprinkled on water; (3) the particles when immersed collect bubbles as the solution is heated or exposed to vacuum and float or tend to float; and (4) the particles in gas-saturated solutions collect the bubbles evolved. He says, "In my earlier paper, it was shown that mineral particles absorb gases to an extent not previously suspected and that they retain the gas adsorptions with such persistency that they could neither be easily separated by mechanical means nor much affected by gravity and gas expansion." He also says, "In previous investigations, I found that carbon dioxide was obtained from all sulphides by the aid of heat and exhaustion in the presence of water. It is probable that the gas film can be expanded for removal in appreciable quantities only in the presence of water and that exhaustion in the dry state does not remove all the gas present."

With a view to further investigating the gas held by solids, he conducted the following experiments:

1. Copper and silver foil were cleaned with sodium hydrate and distilled water and dried. These and uncleaned pieces were treated in a vacuum-flask. Few bubbles formed on cleaned foil with distilled and air-free distilled water, but more on the uncleaned. All foil floated in tap-water.

2. Six steel needles were cleaned in the same way as the foil and allowed to stand one half-hour in alcohol and then dried in a desiccator. They would not float on distilled water until it had been exposed for some time to the air. Another set of needles and iron wire were similarly cleaned, but would not float until allowed to stand in a desiccator for two days. The same results were obtained with sulphides cleaned with sulphuric acid.

"These experiments show that perfectly cleaned needles and iron wire will float on the surface under the following conditions: (a) if the water is allowed to stand for some time in contact with the air; (b) if the needles and wire are allowed to remain exposed to the air for sufficient time."

⁶ 'Concentrating Ores by Flotation,' 2nd ed., p. 136.

⁷ 'The Electrical Theory of Flotation,' by Thomas M. Bains, Jr., *M. & S. P.*, Nov. 27, 1915, page 824.

⁸ 'Notes on Flotation,' by J. M. Callow, *M. & S. P.*, Dec. 4, 1915, page 852.

⁹ Vol. XXIII and XXIV (N. S.) Part 2, 1911. Abstracted in *Eng. & Min. Jour.*, p. 307, Aug. 12, 1911 (vol. 92), and p. 71, July 13, 1912 (vol. 94).

3. Cleaned and uncleaned pieces of iron wire, on being immersed in a saturated solution of carbon dioxide showed the following results: (a) clean pieces collected very few bubbles, while (b) uncleaned pieces were covered with a froth of bubbles.

I have confirmed these experiments, therefore I am positive of the incorrectness of Mr. Rickard's statement, "If you place an ordinary needle, say, a lace needle suitable for use with No. 80 thread on the surface of a bowl of water, it sinks at once to the bottom, in obedience to the law of gravity. If, however, you pass the needle through your hair, so that it becomes greased, it will float on the water."¹⁰ This is the same old false assumption that oil is a necessity instead of an aid to flotation.

Swinburne and Rudorf¹¹ say, "A way of demonstrating the presence of gaseous envelopes is to sift some powdered substance which easily sinks, such as sand or ferrous sulphides, upon the surface of hot water, previously freed from gas by boiling. Bubbles of gas rise from the surface of solid particles." "It seems necessary that the gas should be produced at the surface of the particles themselves." "The air-film always plays an important part; and if the ore is thoroughly washed or boiled in water to remove the air-film, it cannot be concentrated with acid."

There are many other references all showing the same thing: that the mineral particles to be floated must contain gas so as to act as nuclei for the gas as it "comes into being" from the liquid. Therefore, in my former article, I did not present this evidence to prove my statement, which seemed a self-evident fact in view of the present knowledge of the subject.

Mickle collected gases from concentrate made from Broken Hill material some of which gas contained:

| (1) | (2) |
|-----------------------|-----------------------|
| N | N |
| O | O |
| CO ₂ | CO ₂ |

It is seen that these gases obey Henry's law, each existing independent of the others and not displacing the others as Mr. Block¹² says undoubtedly would be the case. An analysis of a sample from the Horwood process gave:

| | |
|-----------------------|-----|
| N | 95% |
| O | 1 |
| CO ₂ | 4 |

These three samples of gas became disengaged from three samples of concentrate which were allowed to stand. Afterward a vacuum applied to No. 1 sample (70 gm. sulphide) gave a further amount of 1.7 c.c. gas analyzing:

| | |
|-----------------------|------|
| N | 27% |
| O | 14.1 |
| CO ₂ | 58.8 |

On raising the temperature to the boiling point and subjecting this sample to vacuum, there was then given off 8.9 c.c. of gas, which was found to be practically all carbon dioxide.

From the No. 2 sample he obtained 18.5 c.c. gas of which practically all was CO₂. On subjecting minerals to reduced pressure and heat, he found that he could obtain more gas from calcite and quartz. This was mostly CO₂. He proved in all these cases that the CO₂ obtained was not from the decomposition of carbonates. This shows that minerals in general occlude gas, although Mr. Ralston¹ says that "good cases of occlusion have been found thus far only in amorphous substances." Mr. Block is quite right when he says: "that it would be liberated with sufficient rapidity to float the particles does not seem probable."¹² Also Mr. Ralston¹ is correct in saying "How the tightly-held gas could be liberated fast enough to compare with the exceedingly short time which it takes to accomplish flotation of a sulphide particle is difficult to explain physically." I simply stated that "if this gas be expelled from them, when they are in a liquid, at a time when the gas is expelled from the liquid, they become the nuclei for the formation of gas bubbles." On the other hand, if bubbles are not formed from nascent gas of the liquid in contact with the mineral particle there can be no adhesion because the bubbles are surrounded by liquid films; or, if the particles contain no occluded gas, there can be no adhesion because the particles are surrounded by liquid films.

That these two words 'nascent' and 'occlusion' were objected to shows the necessity of extreme care in the choice of terms, and I am glad that Mr. Ralston brought up this point. 'Nascent' is defined in Webster's New International dictionary (3rd), 1915, as follows: "Being born; coming into existence; beginning to grow; commencing, or in process of, development." The Century dictionary, 5th edition, 1911, gives practically the same definition as follows: "Beginning to exist or to grow; commencing development; coming into being; incipient." The following usage is given: "Wiping away the nascent moisture from my brow; Barham, 'Ingoldsby Legends'." Available gas of any kind for flotation must "come into being" in this way. Mr. Bains¹³ excellently describes this, as follows: "If powdered galena ore, with a limestone gangue, be dropped into pure water, most of the powder will immediately sink to the bottom. As the air enclosed by the particles is expelled gradually, one sees the formation of 'armored' bubbles, some of which may last for days. Here is flotation without oil or acid. If nitric acid be added, the gas bubbles formed by the action of the acid on the gangue, will carry up particles of galena." I have placed ½-inch pieces of quartz, galena, and other minerals in a beaker filled with water saturated with air at atmospheric pressure. The purpose was to watch the formation of the

¹⁰ "What Is Flotation?" by T. A. Rickard, *M. & S. P.*, Sept. 11, 1915, page 384.

¹¹ Paper read before the Faraday Society, Dec. 12, 1905, by J. Swinburne and G. Rudorf, Abstracted in *Eng. & Min. Jour.*, Feb. 10, 1906.

¹² James A. Block, *M. & S. P.*, Oct. 30, 1915, page 659.

¹³ "The Electrical Theory of Flotation," by Thomas M. Bains, *M. & S. P.*, Nov. 27, 1915, page 824.

bubbles. More small bubbles formed on the metallic minerals when heat was applied. The bubbles formed on all minerals apparently in the same way that moisture forms on one's brow. I wish to describe this. There is only one single word in the English language that can be used to do it—"nascent." This is not "the dissolved gas that can be liberated," but it is the dissolved gas at the instant of liberation.

Regarding occlusion, Mr. Ralston has been kind enough to mention three ways by which gases can be held in solids, and I should have used more care in the choice of these terms. I used the word 'occluded' as a general term to denote either surface adsorption or solid solution. As Mr. Ralston says, "this is a term the meaning of which has been much disputed." Trying to show that the gas in the mineral obeys the same laws as the gas in the liquid, as proved by Mickle, I spoke of the gas being dissolved in the solid and thus led up to the term 'occlusion,' having in mind the following: "The amount of gas which dissolves in a given quantity of water is proportional to the pressure, and from this experimental result, Van't Hoff showed mathematically by the principle of thermo-dynamics that, when in solution, this same gas must exert an osmotic pressure";¹⁴ and that "Substances dissolved by solids have an osmotic pressure as shown by Van't Hoff, so we can speak of solid solutions";¹⁵ also that "the greater the pressure to which the gas is subjected, the larger the quantity which will be adsorbed by the solid."¹⁶

Viscosity is another word that has been incorrectly used in connection with flotation. Mr. Rickard¹⁰ in his article, 'What is Flotation?' states: "The combination of low tension and high viscosity enables a bubble of gas, rising through the liquid, to lift the surface film of the liquid, which the tension of the bubble-film is not strong enough to break, so the bubble endures"; and cites 'A Text Book of the Principles of Physics,' by Alfred Daniell, 1911. Also Mr. Rickard states: "Pure water has great surface tension, it also has no superficial viscosity."

Viscosity as known today is an entirely different property of matter from that which Daniell in 1885 confused with surface tension.

Perhaps the best definition of viscosity is by Harry C. Jones,¹⁷ as follows: "We need simply mention here the works of Poiseuille, Pagliani and Battelli, Slotte, Gartenmeister, and Traube" * * * "The monumental works of Thorpe & Rodger merit more careful attention." * * * "They prove conclusively, what has been hinted at before, that * * * viscosity may be taken as the sum of the attractive forces in play between the molecules; * * * It is, therefore, made evident that viscosity or inter-molecular attraction is in reality a

property of the atoms of which the molecules are composed." This 'superficial viscosity' is well explained in the Encyclopedia Britannica,¹⁸ as follows: "The varying of contamination to which a water surface is subject are the causes of many curious phenomena. Among these is the 'superficial viscosity' of Plateau." * * * "Plateau attributes these differences to a special quality of the liquids named by him 'superficial viscosity.' It has been proved, however, that the question is one of contamination and that a water surface may be prepared so as to behave in the same manner as alcohol." Mr. Rickard, in his second article, page 517, MINING AND SCIENTIFIC PRESS, October 2, 1915, says: "To make bubbles, the surface tension of water in the flotation-cell must be decreased by a contaminant and at the same time the viscosity of the liquid must be strengthened." As shown above, it is not the viscosity but the general surface tension effect that must be strengthened. As I pointed out, a soluble or partly soluble oil will decrease the surface tension of water because it dilutes the water, which has the greater surface tension. By reason of this cause alone, the tendency to float is decreased and the bubbles burst more easily. Using a volatile oil in a M. S. machine, I have had the bubbles burst so violently that the cement floor was blackened with zinc sulphide at a distance of several feet from the machine. At the same time I was making a very clean zinc concentrate from Leadville mixed sulphides after a Horwood roast. As no other contaminant was used, this was only made possible by having the mineral particles well oiled with the thinnest possible film to aid cohesion in armoring the bubbles well with the zinc sulphide particles. In this case the surface tension was still further reduced by the sulphuric-acid electrolyte.

Most oils, however, aid modern flotation in three ways, as I tried to point out in my former article, by (1) decreasing the force of adhesion of water for mineral particles by forming films around them, (2) increasing the cohesive force of the mineral particles for each other to aid in the formation of a network of mineral particles around the bubbles to toughen them, and (3) toughening the bubbles by forming films of oil around the bubbles in addition to those of the water. 'Toughen' is not a good word whereby to express the meaning. Mr. Ralston explains this very well and at length on page 624, MINING AND SCIENTIFIC PRESS of October 23, 1915, under his inter-facial tension hypothesis. He claims, however, "It is doubtful if the air bubbles could be completely mantled by oil." This is contrary to the experience of others. The colors on the bubbles indicate that they are mantled." This shows that Mr. Callow is right when he says "The bubble-mantles in a flotation-machine are undoubtedly composed of oil, or oil emulsion."¹⁹ The sum of these tension effects cause persistent bubbles, even though the surface tension of the water has been reduced. These undoubtedly are ex-

¹⁴ 'The Recent Development of Physical Science,' by W. C. Dampier Whetham, page 113, 2nd ed., 1904.

¹⁵ 'Zeit. Phys. Chem.' 1890, 5, 322.

¹⁶ 'Elements of Physical Chemistry,' by Harry C. Jones, 1902, page 267.

¹⁷ 'Conductivity and Viscosity in Mixed Solvents,' Carnegie Institute, Publication No. 80, 1907, page 19.

¹⁸ 11th edition, under 'Capillary Action.'

¹⁹ 'Notes on Flotation,' by J. M. Callow, *M. & S. P.*, Dec. 4, 1915, page 854.

tremely thin films, at least approaching one molecule in thickness.

Therefore molecular forces must be taken into account in dealing with them, as Mr. Ralston says, "The underlying cause of the tensions and of electric charges is the same thing—some strange molecular, atomic, or other force manifested in 'adhesion,' 'cohesion,' or even 'gravitation,' if you please." In dealing with these interfacial tensions, the drop weight method cited by Mr. Coghill²⁰ for determining surface tension is of no value to flotation.

The interfacial hypothesis of Mr. Ralston explains very well indeed the persistency of bubbles, but I am not so easily satisfied as is Mr. Block,²¹ who says, "T. J. Hoover, for instance, in his book, 'Concentrating Ores by Flotation,' presents a consistent theory." Mr. Hoover (2nd edition, page 72) says: "There has been no satisfactory theory yet propounded as to why acid does promote the preferential adhesion of water to gangue particles." Even the late electrical theory fails to answer all the questions asked by Mr. Hoover, on page 100 of his book. I answered the above question in my article by showing that an acid or any electrolyte creates osmotic pressure, by trying to enter the solid particles, of which their surfaces act as septums. If this pressure be sufficient to drive most of the gas out from the gangue particles the metallic particles can be floated, for the reason that there is still left sufficient gas in them to become nuclei for bubble formation by the nascent gas of the liquid.

As shown by Mickle's experiments, mentioned above, there is more gas in sulphides than in other minerals and it is held more persistently in the sulphides. Thus a selective flotation is created. I have confirmed these tests.

Everyone who has experimented with flotation has seen how too much acid will 'kill' the float. That is, the greater osmotic pressure drives the air from the metallic particles as well as from the gangue particles.

This effect is not to be confused with that caused by substances such as tannin or saponin mentioned by Mr. Callow²² as colloidal impurities or volatile oils and the like, which destroy bubbles by reducing the surface tension to the extent that the gas pressure from within breaks or even explodes them. This weakening of the surface tension by a colloid is an entirely different phenomenon from that shown when the osmotic pressure is increased by a crystalloid.

"The crystalloids when dissolved in water change in a marked degree its properties; for example, they diminish the vapor pressure, lower the freezing point, and reduce the boiling point."²³

And as Dr. Lupke²² states, the four laws in speaking of

dilute solutions, are "Equimolecular solutions of any substances, prepared by using equal weights of the same solvent, exhibit equal osmotic pressure, equal relative depressions of vapour-pressure, equal risings of boiling point, and equal lowerings of freezing point."

In maintaining that osmotic pressure of an electrolyte is the cause of selective flotation, it is well to look into the motive power of osmosis. Kahlenberg²³ states it "lies in the specific attractions or affinities between the liquids used and also between the latter and the septum employed. These affinities have also at times been termed the potential energy of solution, etc.; they are, to my mind, essentially the same as what is termed 'chemical affinity'." Or, as F. H. Garrison²⁴ put Taube's theory: "The driving force in osmosis is a superficial (or interfacial) pressure obtained by subtracting the surface tension of one fluid from the tension of the fluid into which it diffuses." Or again as Van't Hoff and his followers contend "The molecules of a dissolved substance exert the same pressure against a semi-permeable membrane, during osmotic processes, as they would exert against the walls of an ordinary vessel were they in the gaseous state at the same temperature and the same concentration."²² Since these authorities do not agree on the motive force of osmosis, investigation must rest for want of further data.

However, all theories of flotation, be they electrical or otherwise, must come to osmosis for their solution. This is not to question the fact shown by electrolysis that every atom of matter is capable of uniting with a definite quantity of electricity. Nor is it to question that corpuscles (later termed electrons by Dr. Stoney) do not revolve around atoms which are thousands of times larger. But it is to question any hypothesis that does not take into account the fact that particles will not float when all the gas is driven from them. Osmotic pressure can free particles of their occluded gas. Whether osmosis is caused by electricity or whether a current of electricity is caused by osmosis has no bearing on flotation. However, in passing, it may be of interest to mention that Dr. Robert Lupke, in his book 'Elements of Electro-Chemistry' devotes Part III to 'The Osmotic Theory of the Current of Galvanic Cells.'

As mentioned above, extreme dilution of the electrolyte affects the osmotic pressure and selective flotation. With complete dissociation, as Arrhenius has shown, the ionized molecules are free to obey electric forces. It may be freely granted that air driven from a particle by osmosis may effect a change in the 'contact-film' mentioned by Mr. Callow and leave the particle negatively charged, so that it would sink as described by him. Also it is granted that the mineral particles are all either negatively or positively (?) charged. Assuming the electric charges, there then enters the important question mentioned by Mr. Callow in stating his theory that "the

²⁰ 'Surface Tension,' by Will H. Coghill, *M. & S. P.*, Oct. 9, 1915, page 543.

²¹ 'Text Book of Physics,' by J. H. Poynting & J. J. Thompson, 3rd edition, 1905, page 186.

²² 'The Elements of Electro-Chemistry,' by Robert Lupke, 2nd edition, 1903, page 119.

²³ *Jour. Phys. Chem.*, 1906, 10, page 208.

²⁴ 'A Note on the Taube's Theory of Osmosis and Attraction Pressure,' by F. H. Garrison, Army Medical Museum, *Science*, vol. 32, 1910, page 283.

particles possessing them will migrate when placed in an electric field." There is no question but that with an electric field, flotation can be produced in such a manner as described by Bothe Schwerin in his 'Electro-Osmotic Process'²⁵ as follows: "My invention consists of adding electrolytes to the liquids containing the substances to be separated, the nature of the electrolyte depending upon the character of the substance. If the latter is of such a character that they would be deposited by the electric current on the cathode, electrolytes of acid character are employed; and if the substances would be deposited on the anode, electrolytes of basic character are used." Speaking of finely-divided substances, sometimes indifferent to the action of an electric current, he continues: "I have found that such substances can be made electrically active by causing them to adsorb [here used as defined by Mr. Ralston] colloidal substances of a strong electro-positive or electro-negative character." Of the recent electrical theories advanced, none explains how this important electrical field, mentioned as necessary by Mr. Callow, is created by any flotation machine. Mr. Block²⁶ shows this on a clay machine.

After selective flotation is created by osmosis, it matters not whether the particles be spoken of as being held together or to the bubbles by electric charges or by cohesion and adhesion in the way I mentioned. Sir Oliver Lodge,²⁷ after saying that "the force of chemical affinity has long been known to be electrical" goes on to say that "there is another kind of adhesion or cohesion of molecules, not chemical, but what is called molecular. This occurs between atoms not possessing ionic or extra charges, but each quite neutral, consisting of paired-off groups of electrons." However great this attraction may be, the mineral particles will not adhere to bubbles already formed, as was shown above; but, using them as nuclei, the nascent gas will form into bubbles to float them. Such gas formation is excellently described by Duhem²⁸ as follows: "From this, a bubble of vapor will never be formed in a region where the liquid is continuous; in fact, if such a bubble could begin to form, its radius would be at first infinitely small—less than the limiting radius of which we have spoken; whence, instead of continuing to grow, it would collapse." On the next page he continues: "These considerations do not apply merely to boiling; they completely explain a great number of phenomena."

The electrically-charged mineral particles may aid in bubble formation although they cannot effect attachment of mineral particles to bubbles already formed. Regarding this, Dr. Thompson²⁹ says that "the charged par-

ticles act as nuclei around which small drops of water condense, when the particles are surrounded by damp air cooled below the saturation point." "Experiments were made with air, hydrogen, and carbonic acid and it was found that the ions had the same charge in all the gases." Also, "Thus by suitably choosing the supersaturation, we can get the cloud deposited on the negative ions alone so that each drop in the cloud is negatively charged." Electricity may manifest itself in various ways, but flotation cannot take place without nascent or occluded gas.

Accident Compensation

California, like several other states, has had a workmen's compensation law for about two years. The law in this State provides that liability for compensation shall exist against an employer for any injury received by workmen without regard to negligence, providing the accident is not due to intoxication or wilful misconduct. Compensation is usually on a basis of 65% of the wages of the workman. The measure was opposed by employers, particularly by the gold-mine operators who contended that, unlike other lines of industry, they could not add the cost of their insurance directly to the selling price of their product.

The report of the Industrial Accident Commission for the last fiscal year indicates that a total of 6858 employers had accepted the compensation provisions of the law. A change of sentiment is apparent, as the employers realize the benefits of the system.

An important decision was rendered in the case of the appeal of the Great Western Power Company against the decision of the Industrial Accident Commission. It was held that James Mayfield met his death as a result of wilful misconduct and the court laid down this rule: "it cannot be doubted that a workman who violates a reasonable rule made for his own protection from serious bodily injury or death is guilty of misconduct and that where the workman deliberately violates the rule, with knowledge of its existence and of the dangers accompanying its violation, he is guilty of wilful misconduct."

The success of the State Compensation Insurance Fund has been noteworthy. At the close of the first year, 1914, the fund had written \$547,161 in net compensation insurance premiums, approximately \$144,000 in excess of the writings of its nearest competitor. A refund to policy-holders of 15% of earned premiums was allowed as policies expired and actual payroll expenditures of insured employers were ascertained. The total amount of this refund was approximately \$75,000. It is estimated that an additional refund of 28% will be returned to policy-holders, or a total dividend of 43%. At the end of the first year (1914) the rate schedule was readjusted, resulting in an average reduction of 10%.

The Industrial Accident Commission of California has issued a pamphlet of 'Mine Safety Rules' effective January 1, 1916.

²⁵ U. S. Patent No. 993,888.

²⁶ 'Notes on Flotation,' Discussion, Bulletin A. I. M. E., Dec., 1915, page 2337.

²⁷ Chapter 16, 'Nature of Cohesion,' in book 'Electrons,' by Sir Oliver Lodge, Principal of the University of Birmingham.

²⁸ 'Thermodynamics and Chemistry,' by P. Duhem, 1903. Art. 275, page 366.

²⁹ 'The Atomic Structure of Electricity,' Chapter 4, 'Electricity and Matter.' By J. J. Thompson. Lectures at Yale, May, 1903.

Mining in Utah

By L. O. Howard

MINING has been conducted under unusual difficulties during the past month, a heavy snow-fall hampering operations in districts formerly free from serious interruption to traffic. At Park City the hauling of ore has been suspended several times. Slides have blocked roadways and damaged surface equipment. The train service from Salt Lake has been intermittent. Railroad transportation in the Tintic district has been suspended for days at a time, tending to keep shipments down. In Beaver county prospecting has been difficult, and activity diminished. Even in the desert country in Grand, Emery, and San Juan counties there has been a heavy fall of snow. Coal shipments from the eastern part of the State have been infrequent, owing to the congestion of freight at Soldier Summit. The Cottonwoods have been inaccessible at times. Slides began to run early in numerous places that have formerly been immune. Big Cottonwood was blocked to ore-teams during the first week of February and at this time of writing no ore is coming out. In Little Cottonwood occasional shipments are being made. The Maxfield in Big Cottonwood has been flooded for the second time this year, owing to the loss of power. This time a slide took out the line. A new line is being run up the canyon, so as to ensure continuous service.

Increasing metal prices continue to favor a rise of wages in the three principal districts, where most of the companies have adopted a sliding scale that enables employees to share the good fortune of the operators. Seven thousand men will be affected and about \$600,000 added to the pay-roll.

Park City shipments fell from 9746 tons in December to 7370 tons in January, the Silver King Coalition, Daly-Judge, Daly West, Ontario, Silver King Consolidated, and Naildriver contributing. The Three Kings Silver continues driving in an effort to cut the fissures known in adjoining properties. It is reported that the Silver King Consolidated will drive a 14,000-ft. adit, erect a 100-ton mill, and build an aerial tramway. The mill-site chosen is at the mouth of Thaynes canyon. The Ontario is well up in the shipping list, being in third place. This mine was idle for many years.

At Bingham the recently consolidated Utah Metals-Bingham New Haven properties are producing 400 tons of silver-lead ore per day, and must henceforth be counted among Bingham's big mines. The Utah-Apex, which paid its first dividend last year, is producing 100,000 lb. of lead monthly and the profit for January reached \$70,000. The company has an efficient mill combining gravity concentration with flotation. Utah Copper has announced its production for December as 14,497,485 lb. of copper, compared with 6,795,567 lb. a year ago,

bringing the total for 1915 to 156,207,568, against 121,779,716 in 1914. Since May, production has been at the rate of 176,000,000 lb. annually.

The Tintic district is witnessing a revival; several old and new properties are being developed. Shipments average 100 to 120 cars per week, or 25,000 tons per month. The ore is of four kinds, lead sulphide, silver-lead carbonates, zinc carbonate, and copper-silver ore.



THE MINES OF TINTIC.

Regular shippers include, in order of tonnage, Chief Consolidated, Iron Blossom, Centennial-Eureka, Mammoth, Grand Central, Eagle & Blue Bell, Dragon Consolidated, Beek Tunnel, Colorado, Gemini, East Tintic, Bullion Beek, Lower Mammoth, Victoria, May Day, Carisa lease, Uncle Sam, and Ridge & Valley. In the eastern part of the district, the Tintic Central and the Tintic Standard are developing; the Crown Point, East Crown Point, Utah Con., Iron King, and United Tintic are planning extended exploration. The Gold Chain, Scranton, Diamond Queen, and Golden Sunset are also being worked. The Utah Minerals Concentrating Co. is treating low-grade ore from the Bullion Beek, Chief Con., and the May Day dump, the latter averaging \$4 to \$5 per ton. Some of this tailing has had two previous treatments. The mill is also treating tungsten ore from California, Nevada, and Utah, and is in the market for ore as low as 2%.

Deep Creek is attracting attention as a producer of tungsten. It is reported that 8000 lb. of 72% ore has

been shipped by parcel-post. The district has a number of developed properties, with large low-grade deposits of lead, silver, and copper, but lack of transportation keeps it from realizing its possibilities. Occasional shipments of high-grade ore are made.

From the district about Lucin, in the north-west of the State, shipments of low-grade tungsten ore are reported.

In the West Tintic district, between Tintic and Deep Creek, there is renewed activity. The O. K., Scotia, and Sharp properties are attracting favorable notice. They, too, are handicapped by poor transportation facilities. The Scotia is expected soon to ship a car of ore per day. It is held under bond and lease by the Chief Consolidated, now the leading producer of the Tintic district.

With the payment of another dividend early in February, the record of the Lake View at Promontory reaches \$75,000; it is a property that was unknown a year ago.

Several districts in Beaver county are active. In the Star district, the Cedar-Talisman has realized enough on shipments of zinc ore to pay off all indebtedness, install electrical equipment, and accumulate a large reserve. The Moscow, another shipper, is sinking to 1000 ft., after completing the installation of an electric hoist. Among the other companies developing are the Monzonite, Cedar Extension, Paloma, Silver Gulch, Majestic, Leonora, Wild Bill, Rough Rider, Red Warrior, and Salt Lake groups. In the Lincoln district, the Creole and Croff are now well equipped, and ready to begin shipments. In the new Fortuna-Sheep Rock district, development is in strong hands. The U. S. S. R. & M. Co. is working its property, and occasional discoveries of high-grade ore are reported from neighboring leases. Other properties being developed in the Sheep Rock end of the district are the Beaver Butte, Keystone, Gold Hill, Beaver Gold, and Rob Roy. At Fortuna work is being done on the Gold Queen Fraction, Mohawk, and Copper Granite.

The War has resulted in direct benefit to another Utah industry, the mining of ozokerite, commonly called 'mineral wax.' Only two districts where ozokerite may be mined are known. That of Boryslaw in Galicia ceased to produce on the outbreak of the War, leaving the market to the Utah district about Colton and Summit in Utah county. The price has risen from 15 to 45 cents per pound. Two years of experimental work have resulted in the perfection of a simple process for extracting the ozokerite, former difficulties in profitable operation being due to the unsatisfactory methods used. A mill has been assembled and will be shipped to the Soldier Summit property of the Wasatch Ozokerite Co. Production is to start on a large scale early in spring. It is expected that other properties in the same belt will be exploited.

GOLD PRODUCTION of India in 1915 totaled 602,359 oz., the largest since 1905, and compared with 602,006 oz. in 1914, 589,353 oz. in 1913, 584,838 oz. in 1912, and 573,525 oz. in 1911. Most of the yield is from the Kolar

field of the State of Mysore. December outputs were as follows:

| Mine. | Tons. | Ounces. |
|-----------------------|--------|---------|
| Balaghat | 3,002 | 1,992 |
| Champion Reef | 17,366 | 10,835 |
| Anantapur | 2,900 | 797 |
| Mysore | 26,500 | 20,609 |
| North Anantapur | 2,600 | 1,066 |
| Nundydroog | 8,000 | 7,260 |
| Ooregum | 12,850 | 8,100 |

A Simple Dynamite-Thawer

The following convenient method of thawing dynamite was written by J. H. Carse from the experience of ten years in thawing frozen dynamite. The excerpt is from the *Du Pont Magazine*. Take an old barrel, bore one or two ½-inch holes in the bottom, place a little straw, hay, sawdust, or anything that will allow water to filter through easily, to a depth of about two or three inches. Secure an old oil-can, capable of holding at least five gallons, fill this can with boiling water and place it in the centre of the barrel on top of the filling. The purpose of the half-inch auger-holes in the bottom of the barrel is to allow any water to drain out that might

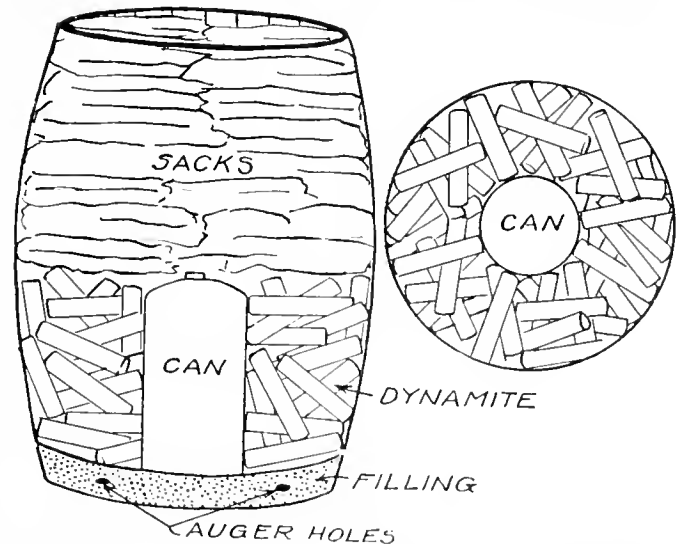

accidentally be spilled. In filling the can with boiling water, it is a good plan to leave an air-space of about two inches for the steam that will arise. In case the weather is not very cold, the can of hot water should be wrapped in a sack to prevent the dynamite from coming in direct contact with it. Place the dynamite around the can in such a manner that the heat will circulate about the cartridges; fill the rest of the barrel with sacks, or anything convenient to retain the heat. If the weather is exceedingly cold, sink the barrel in the ground. In this way the dynamite will keep thawed for at least 48 hours. A 5-gal. can of boiling water is sufficient to thaw at least 50 pounds of dynamite. This plan of thawing has proved safe, for the reason that it requires 356 F. to explode pure nitroglycerine, while by this method it is impossible for the heat to exceed 212° F. Tests that have been made have shown the highest temperature in the barrel not to exceed 80 degrees.

Quicksilver Mining in California

By W. H. Landers

THE high price for quicksilver, at present some-
 thing over \$300 per flask, has drawn attention to
 its production. So much has been written on the
 occurrence and geology of the quicksilver deposits of the
 United States that it seems a waste of good time to dis-
 cuss the geologic features. Suffice it to say that cin-
 nabar, the principal ore of mercury, is found as a rule
 at or near the contact of sandstone or serpentine, the
 most notable deposits in the United States being in the
 Coast range of California. Cinnabar ores are distributed
 far more widely than is generally supposed; but the low
 price in recent years naturally has removed the stimulus
 to prospecting. This explains the decline in the Ameri-
 can production. Present prices have caused a renewal
 of activity in mining, and it is my belief that they will
 never reach as low a level as that obtaining before the
 War checked the importation of this metal into the
 United States.

The mining of quicksilver ore does not differ ma-
 terially from that of any other contact deposit. Much
 the same conditions of hard and soft rock are offered
 and the same questions arise as to handling of water, the
 timbering of the drifts and stopes, the economic break-
 ing, and the transportation of the product.

Cinnabar ore is generally rated in terms of mercury
 percentage, and this in itself is not calculated to excite
 interest as much as if the value were quoted in terms
 of dollars and cents per ton of ore. Statistics indicate
 that the average ore mined in California for the last
 three or four years contains 0.6% mercury. It is quite
 true that such ore may be considered low-grade in com-
 parison with that formerly mined or from a money
 standpoint, 0.6% just prior to the outbreak of the War
 being worth only \$6 per ton. However, the present price
 of \$300 per flask means that the same yield is now worth
 \$48 per ton. Compare this with the value of a com-
 paratively rich gold mine, and the reason for the pres-
 ent public interest is evident. It is surprising what a
 number of promising surface showings of cinnabar ore
 exist in certain districts, and more surprising still that
 after a year of high prices, most of them remain un-
 developed. It is hard to believe that any other form of
 mining could have attracted so little interest. This may
 be explained locally by the fact that there is no market
 for cinnabar ores as such, and that to convert even high-
 grade cinnabar ore into money, it is necessary to have
 access to a furnace. Few, if any, of the larger com-

panies purchase outside ores. Another reason is that,
 as far as most of California is concerned, quicksilver ores
 are found only on agricultural patented land, so that
 the prospector, the forerunner of any new mining in-
 dustry, is not permitted to search for mineral on such

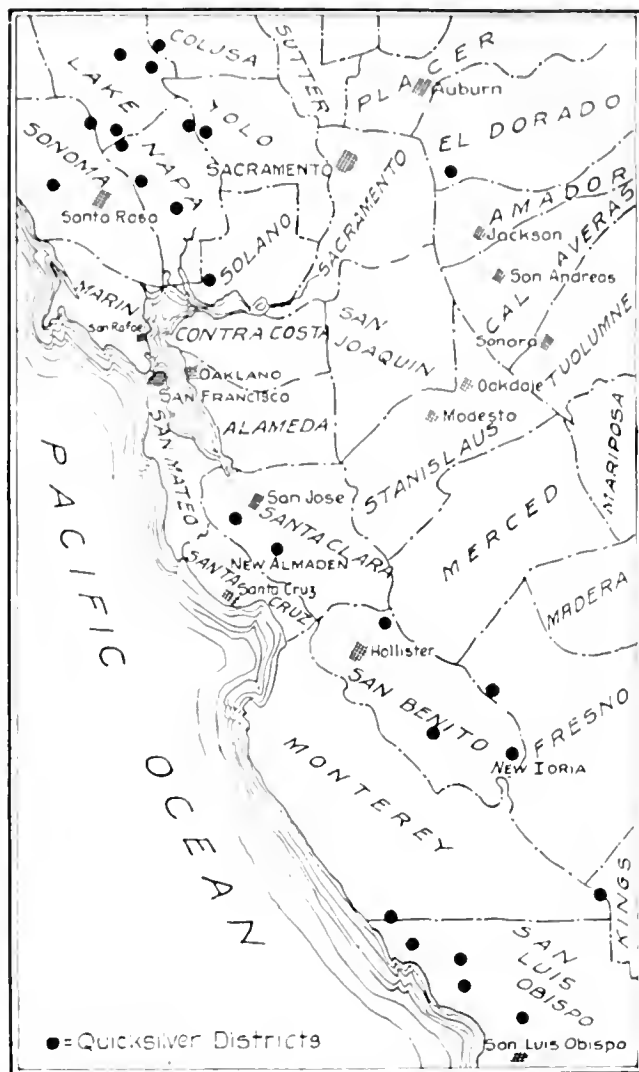

MAP SHOWING QUICKSILVER DEPOSITS OF CALIFORNIA, AND THE
 REASON WHY SAN FRANCISCO IS THE PRINCIPAL MARKET FOR
 THE METAL IN THE UNITED STATES.

land, nor could he, should he find a valuable deposit,
 gain any of the advantages of which he continually
 dreams, and which are necessary to keep him on his
 quest. An advantage enjoyed by most of the Pacific
 Coast operators is that their mines are in localities where
 weather, labor, and supplies are satisfactory.

Cinnabar ores are reduced by a process of distillation,
 that is, the ore is heated to such a temperature (about
 625°F.) as is necessary for the oxidation of the sulphur

*Manager for the New Almaden Company.

†George F. Becker, U. S. G. S. Monograph, XIII, 1888,
 'Quicksilver Resources of California,' by William Forstner,
 J. W. C. Maxwell, Charles G. Yale, and E. P. Preston, California
 State Mining Bureau Bulletin No. 27, 1908.

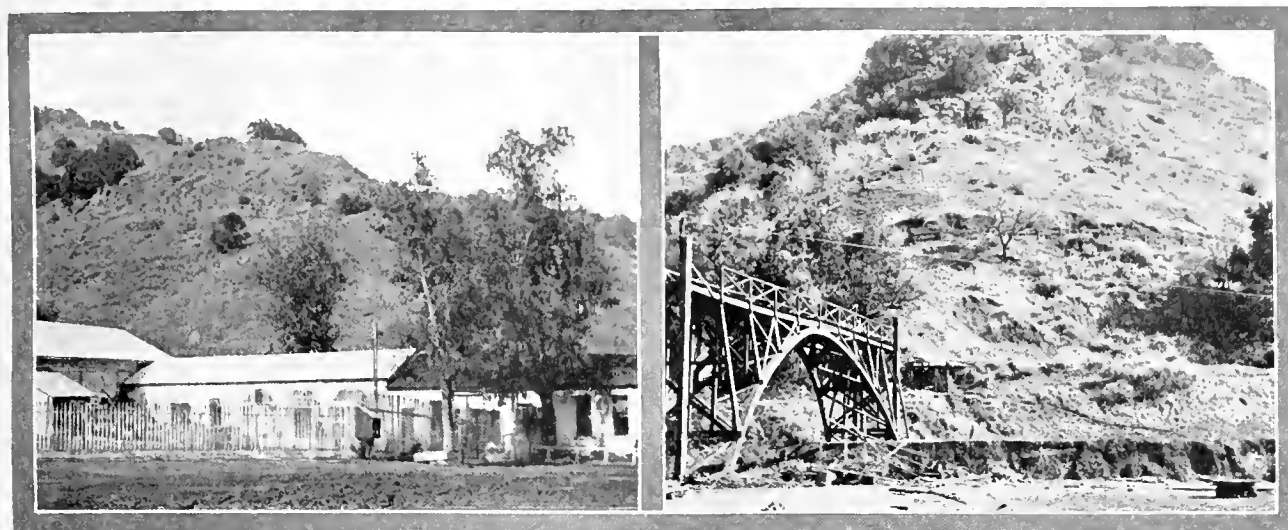

OUTCROPS OF QUICKSILVER LORE AT NEW ALMADEN.

and the vaporization of the remaining mercury. These vapors must then be cooled below the boiling point of mercury and condensed in an apparatus that is both costly and inefficient. The method of treating cinnabar ores as at present practised has undergone practically no change or improvement since 1871, when Robert Scott and his co-workers developed what is known as the tile furnace at New Almaden. Prior to that, only coarse ore, larger than a hen's egg, could be successfully reduced in the various types of furnace, it being necessary, in order to handle the fine, to press it into bricks and burn these in the coarse-ore furnace. The Scott furnace permitted the treatment of material the largest of which did not exceed two inches, and has made possible the persistence of the quicksilver industry. Modifications of the Scott furnace have been attempted, but no really new type of furnace has been developed beyond the experimental stage. The small operator has favored the retort-furnace, on account of its low first cost; but the small capacity, together with the high fuel consumption and the danger to the workmen has caused them to be abandoned by all of the larger operators, with the possible exception of those who still use some sort of retort for treating mercurial soot.

It would seem to be an easy matter to heat an ore to the proper temperature, reducing the sulphide and distilling the resulting metal, but a little investigation will indicate that while the theory is simple, the many mechanical difficulties tend to make the final result unsatisfactory. The bringing of the ore up to the proper temperature does not offer any particular difficulties, and, as it is not necessary to add any additional reducing agents or fluxes, the process is further simplified, but the resulting vapor gets into crevices in the brick-work about the furnace and condensers: in fact, it will escape through the pores of the apparatus. It is one of the most penetrating vapors known, and after being cooled below its condensing point, it exists as a fog, extremely heavy to move by ordinary draft. While hot, it will penetrate even concrete until it reaches so near the outside of the

wall that it is sufficiently cooled to condense its mercury. I have even known it to penetrate to the centre of the walls of vitrified tile-pipe without apparently destroying the glazed surface. The mortar-joints in the brick-work become literally saturated, and it can be readily imagined the enormous value that is locked up in the modern furnace and condenser, where 400,000 to 500,000 bricks are used. Like all furnaces, it is necessary to have a dust-chamber either connected with the furnace or immediately adjacent; this chamber will confine a large amount of mercury vapor in the dust, which on being cooled is either lost in the atmosphere or condensed into microscopic globules of mercury difficult to separate from the dust.

As to the gases escaping from the furnace, they consist of products of combustion with the usual hydrocarbons derived from the burning of wood or oil, namely, N, NH₃, CO₂, SO₂, SO₃, H₂O, CO, and lastly the vapor of mercury. The sulphurous gases attack any material of which furnaces or condensers can be made, and the soot deposit from the burning of the fuel mechanically holds most of the condensed mercury. Crude oil, as burned in many of the large furnaces, makes a particularly greasy soot that prevents the small globules of mercury from coalescing and must be handled in a different way from the soot resulting from the burning of wood for fuel. As soon as the furnace-gases are cooled below the boiling point of water, the SO₃ becomes sulphuric acid and quickly eats out any of the metal-work with which it comes in contact. Such mercury as collects in the bottom of the condensers, on account of its extraordinarily high specific gravity, is forever seeking a crevice in which to hide, and it is not uncommon to find a condenser-bottom consisting of several feet of apparently solid masonry or concrete allowing the quicksilver to escape while retaining the water that is condensed with the quicksilver. Attempts have been made to prevent the ultimate loss of this mercury by putting iron plates across the entire top of the foundations on which the condensers and furnaces are built, and this method

is successful up to the time that the sheet iron is eaten away by the acid waters. Where ores containing a comparatively low percentage of sulphur are treated, cast-iron even in moderate thicknesses lasts very well and a good grade of redwood or pitch-pine is apparently resistant to acid, but the difficulty of fastening such wood without the use of metal nails, bolts or screws is obvious. Most condensers have been built out of brick or masonry, and it will be immediately realized that the non conductivity of such material tends to prevent the very object for which it is erected, that is, the carrying away of the heat from the enclosed vapors and their consequent condensation. Cast-iron condensers have been tried and in most cases are ideal when properly designed for this purpose. The high cost of cast-iron prevents its general use.

Condensers built of ordinary window-glass have been employed, and it is difficult to understand why the use of them was discontinued. Water-backs of iron have been tried, and while they assist in cooling the gases, this very fact results in their being rapidly corroded by acid waters. Vitrified tile-pipe makes a successful condenser, and should be more generally employed. The difficulty of cleaning many pipes of comparatively small diameter, no doubt, has prevented a more extensive use of such designs. Mercurial vapors will stick to the walls of a condenser to such an extent that it is necessary, in order to secure an adequate clean-up, to brush or wash these walls. This suggests immediately the difficulty of transporting the liquid mercury and condensed waters to the point where they are collected, and brings prominently to the front one of the sources of considerable loss, namely, the question of the finely divided mercury, which insists on floating on the water.

Even the largest companies seldom make any attempt to determine the efficiency of their operations. Assaying and sampling of ores, or of the cinder going over the dump, are seldom practised, it being usually deemed sufficient to estimate roughly the number of tons of ore 'burned,' and figure its value from the resulting number of flasks of quicksilver cleaned up at the end of a given period. The use of such metallurgical devices as pyrometers and gas analysis is practically unknown, and sampling of the material discarded from the furnace is usually done by means of an ordinary miner's pan. When panning the cinder or tailing, it is customary to take a random sample, discarding all of the coarser lumps after a casual inspection, and panning out the remaining fine to see if any cinnabar or metallic mercury is being lost. No doubt, there are many times when larger pieces are not thoroughly 'cooked' and the operator remains in ignorance of the fact that his furnace is not doing all that is required of it, simply because on panning the fine, little or no cinnabar or mercury is found. This haphazard method was all very well when quicksilver was worth 50 cents per pound, but when each pound is worth \$4, the question of recovery becomes insistent. The New Almaden company is making a careful study of this problem. We have found it necessary to

discard many existing methods and attack the proposition on an entirely different basis. When experiments now being tried are completed, a further contribution to the subject will be made.

Work of San Francisco Mint

The local Mint's business showed an increase of \$72,000,000 in 1915 compared with that of the previous year, according to the superintendent, T. W. H. Shanahan. The source of the gold was as follows:

| | |
|--|---------------|
| British Columbia | \$18,689.24 |
| Northwest territory | 439.99 |
| Mexico | 488,975.95 |
| Central America | 218,121.22 |
| South America, exclusive of Peru | 12,293.35 |
| China | 9,573,342.04 |
| Russia | 1,921.59 |
| New Zealand | 3,378,614.70 |
| Japan | 19,408,110.75 |
| Other countries | 183,487.56 |
| Australia | 35,006,290.55 |
| Peru | 1,398.74 |

| | |
|---|-----------------|
| Total foreign coin and bullion | \$68,291,685.68 |
| United States, including Alaska and California .. | 51,577,823.99 |

| | |
|----------------------|------------------|
| Total receipts | \$119,869,509.67 |
|----------------------|------------------|

The superintendent, T. W. H. Shanahan, reports that from its organization to December 31, 1915, there has been executed at the United States Mint at San Francisco, coinage amounting to \$2,000,591,286.87, of the following denominations:

| GOLD | |
|----------------------------------|--------------------|
| Double eagles | \$1,443,920,520.00 |
| Eagles | 141,974,060.00 |
| Half eagles | 138,940,040.00 |
| Quarter eagles | 1,861,255.00 |
| Three dollars | 186,300.00 |
| One dollar | 90,232.00 |
| P. P. I. E. octagonal \$50 | 75,450.00 |
| P. P. I. E. round \$50 | 75,500.00 |
| P. P. I. E. quarter eagle | 25,042.50 |
| P. P. I. E. one dollar | 25,934.00 |

| | |
|---|--------------------|
| Total gold coinage to end of 1915 | \$1,727,173,433.50 |
|---|--------------------|

| SILVER | |
|--------------------------------|------------------|
| Dollars | \$109,523,073.00 |
| Trade dollars | 26,647,000.00 |
| Half dollars | 32,587,445.50 |
| P. P. I. E. half dollars | 30,000.00 |
| Quarter dollars | 11,465,534.25 |
| Twenty cents | 231,060.00 |
| Dimes | 8,637,218.90 |
| Half dimes | 119,100.00 |

| | |
|---|------------------|
| Total silver coinage to end of 1915 | \$189,240,371.65 |
|---|------------------|

| MINOR | |
|------------------|--------------|
| Five cents | \$426,350.00 |
| One cent | 333,060.00 |

| | |
|--|--------------|
| Total minor coinage to end of 1915 | \$759,410.00 |
|--|--------------|

| | |
|--|--------------------|
| Total U. S. coinage to end of 1915 | \$1,917,173,215.15 |
| Total foreign coinage to end of 1915 | 83,418,071.72 |

| | |
|--|--------------------|
| Grand total coinage to December 31, 1915 | \$2,000,591,286.87 |
|--|--------------------|

REVIEW OF MINING

As seen at the world's great mining centres by our own correspondents.

LEADVILLE, COLORADO

DRAINAGE AND DEVELOPMENT OF ANOTHER IMPORTANT AREA, THAT OF FRYER HILL. THIS, WITH THE DOWN TOWN SCHEME, WILL MAKE AVAILABLE A LARGE AREA.

Fryer hill, the scene of the most famous ore-shoot of Leadville's early days, is again to be exploited on a large scale. The United States Smelting, Refining & Mining Co., well known in North America, is behind the enterprise. The entrance of this company into the Leadville district marks its first venture in Colorado, and the Fryer Hill undertaking, which will be in the direct control of the United States Smelting, Refining & Exploration Co., a subsidiary of the U. S. S. R. & M. Co., will be known as the Leadville Unit. This company has for its particular object the examination and purchase of metal mines, and the operation of properties which it controls under lease or by option.

Two of the company's engineers, Messrs. Funston and Enos, came to Leadville in December to investigate the Fryer Hill territory, and on receipt of their report C. W. Van Law, vice-president and general manager of the Exploration company, and A. P. Anderson, general manager of the Pacific Coast hold-

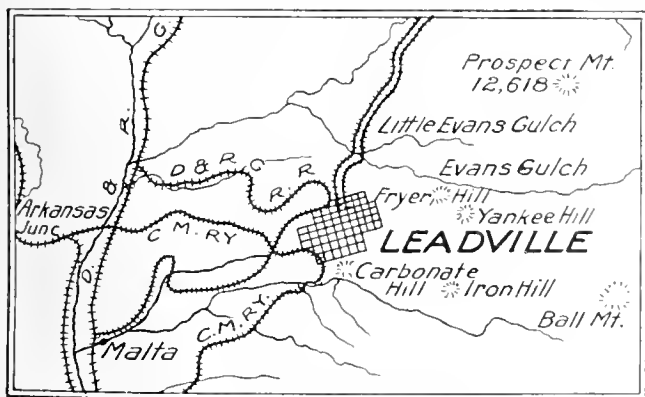

PART OF THE LEADVILLE DISTRICT.

ings of the company, visited Leadville for several days and decided to undertake the exploration of the property. Mr. Van Law spent several days studying the situation, and its exceptional possibilities appealed to him. The first work is the draining of the area included in the Fryer Hill basin. Machinery for unwatering the ground was ordered, preparations were made for the erection of new surface buildings, and repair of the old ones at the Harvard shaft, through which the water will be pumped. The company has opened offices at Leadville in the Vendome, in charge of H. S. Lee, resident manager of the Leadville Unit. Mr. Lee has been with the company for the past eight years and is a mining engineer of wide experience. So rapidly and well were the plans effected that a large electric hoist, one of several that will be used by the company, has already arrived here, awaiting removal to the Harvard shaft.

The mechanical and construction work is under the supervision of E. A. Hamilton, also of considerable experience, who has recently been associated with Mr. Lee in mining operations in Oregon.

The successful promotion of the Fryer Hill enterprise is

the fruit of a long, concerted, and determined effort on the part of two Leadville mining and business men to bring the undertaking to a head. Several previous attempts to operate the territory failed, as the promoters were unable to secure all of the ground included in the Fryer Hill basin, without which the scheme could not succeed. These repeated failures served to impress mining men who were most familiar with the situation with the exceptional possibilities and the immediate resources of the area. Over a year ago, John Harvey and Norman H. Estey outlined a plan for obtaining leases on the desirable properties in the Fryer Hill basin. Mr. Harvey enjoyed a wide acquaintance in mining and business circles, and was able to make such rapid headway that by the end of the year he had most of the territory controlled; Mr. Estey had operated several large properties on Fryer hill, and with his father, the late Robert B. Estey, derived an intimate knowledge of the geology of the area. The data he was thus able to give enabled the partners in promoting the enterprise to present the facts with accuracy and completeness. The entire area comprising the Fryer Hill basin was secured under lease early in January. In the meantime the promoters were busy endeavoring to interest people in the scheme for the purpose of financing it. Not until six weeks ago was this question settled, when Mr. Harvey came in touch with some of the prominent mining men identified with the U. S. S. R. & M. Co. The result is as described above.

The Harvard shaft, on the north-west slope of Fryer hill, is the scene of the present operations of the company. This is a 4½ by 14-ft. three-compartment shaft 407 ft. deep. It is flooded from the 250-ft. level, and the work now underway is preliminary to the unwatering of the property and surrounding territory.

Pumping equipment will consist of one seven-stage, deep-well, electrically-driven centrifugal pump by a 75-hp. motor. The deep-well or 'shoe-string' pump discharges directly into the suction of two five-stage Kroggh centrifugal station-pumps, which will lift the water to the surface. The pumps are manufactured in California, and have been used with great success by the company in its operations at Pachuca, Mexico. They are expected to lift from 1200 to 1300 gal. per minute. In order to expedite drainage, bailers will be used, working in counter-balance, in two compartments of the shaft. These will haul an additional 500 gallons.

It is estimated that the installation of machinery and the complete equipping of the surface-plant will require a month. Three months is the time that has been set for the drainage of the ground, so that by the first of July active mining should be underway. This will consist largely of exploration work at the 400-ft. level, which is in the upper or blue limestone contact. The first step will be the sinking of the shaft a distance of 300 ft. through the parting quartzite into the white lime, a zone that has proved remarkably productive on Carbonate hill, but which has never been explored on Fryer hill. Other shafts controlled by the company will be put into operation as they are needed. Drill-holes will be put down at certain points and a thorough campaign of prospecting will be carried out during the rest of the year.

The territory controlled by the company comprises 200 acres of the choicest mineral ground in the Leadville district. In the past it has produced millions of dollars by development that went no deeper than the parting quartzite. The possi-

bilities of the zone under this division will cannot be estimated.

However, the development of Fryer hill is not the greatest factor or the most important feature in the entrance of the U. S. S. R. & M. Co. into the Leadville district; the policy of the company is one of expansion. It plans an exhaustive inspection of mining territory not only in the Leadville district, but also in the other large mining centres of the State. It contemplates the development of large enterprises like the one now underway throughout Colorado. Following the campaign of exploration, the company has outlined plans for the erection and operation of large mills and smelters for the treatment of all ores taken from its holdings. Leadville is looked on as the site for the first of the smelters to be built in Colorado, and it will come as a part of the work now in progress. Should the orebodies that are to be uncovered in Fryer hill prove as extensive as is anticipated, the smelter will be erected as soon as the company finishes the work of prospecting the territory.

Mining men look for big things in the Leadville district during the coming summer. The Down Town basin is being drained through the Penrose shaft, where very satisfactory progress is being made. Fryer hill, considered by experienced miners the richest piece of territory here, is assured of draining and extensive development. There are bright prospects for the unwatering of East Carbonate hill, the only large area yet to be drained. Following the pumping of water from these areas there will be an extensive campaign for deep mining throughout the district. All of this gives an optimistic feeling at Leadville.

WASHINGTON, D. C.

MINING LAW REVISION.—NEW SAFETY BUREAU PROPOSED.

Legislation in Congress over the proposed revision and codification of the mining laws proceeds slowly. The latest information is that Representative Foster, chairman of the committee on mines and mining of the House, is preparing a bill revising and codifying the mining laws, which he will complete with all speed and introduce into Congress, probably before March 1. The bill is to be wholly tentative, and it is intended to be the nucleus out of which shall grow the true bill the House committee will recommend for passage to the House of Representatives, and which shall comprise the codification Congress will enact, subject to such changes as the Senate may decide to make, if any.

A piece of legislation that has passed the House and is now before the Senate, creates a Bureau of Labor Safety. It is of importance to mining men. It was introduced by Representative Mann, the Republican floor leader of the House. Mining men have fought it on the ground that, written as it is, it would supplant the department of safety now in the Bureau of Mines, or at least establish a superior direction of that Bureau, thus robbing it of its present independence. It is declared that, while it is true that the bill carries wording that its contents shall not be held to repeal any previous legislation appertaining to labor safety, the safety provision in the Bureau of Mines being thus seemingly attended to, the provision does not cover the situation, and that left as it is it means trouble for the Bureau in its enforcement of its own will regarding the safety of labor in mines. It looks as if a dual field was being created with all its attendant rivalry, to say nothing of expense. Mining men want explicit declaration in the bill that the existing safety of labor laws appertaining to the Bureau of Mines shall be excepted from the purview of the Bureau of Labor Safety bill. Mining men are for co-operation with that Bureau, but want the present establishment in the Bureau of Mines to be absolutely independent. In the Senate the Mann bill is known as the Kern bill, and it is thought that it will be passed there; but mining men still hope to have it amended in accordance with their desires.

BUTTE, MONTANA

FROZEN ORE TROUBLES. ZINC.—ANACONDA IN SOUTH AMERICA.—
ELM ORLU ELECTRIC HOIST.—SINKING THE COLORADO MINE.
—PILOT-BUTTE.—ALEX SCOTT SALE.

The Anaconda company's copper production decreased 20% during January on account of the excessive cold weather at Butte. The ore froze in the bins and railroad-cars, and the thawing facilities at the smelter proved to be inadequate. These have been improved, and 100 additional steel hopper cars have been ordered, so the company is better prepared to operate through a long cold season if the necessity again arises.

The old Lexington shaft at Walkerville has been pumped out to a depth of 1000 ft. The upper levels are being prepared and 100 tons per day of zinc ore is being hoisted.—At the Alice, which is near the Lexington, a large number of men are at work in spite of the appeal of the minority stockholders who attempted to have the sale to the Anaconda company set aside. The water is down to 800 ft., and the shaft is being re-timbered.

The East Colusa, at Meaderville, will soon begin operations as a zinc mine. It is an old copper producer, and has been shut-down while the shaft was being re-timbered. Its output will be shipped to the leaching plant at Anaconda.

It is planned to have the new zinc concentrator at the Washoe plant completed by July 1. It will have an initial capacity of 2000 tons per day, and will treat ore from the Lexington, Alice, East Colusa, Nettie, Emma, East Gray Rock, and Poulin mines. An oil-flotation process will be used on the slime, and the concentrate will be shipped to the leaching plant that is now under construction at Great Falls.

The Anaconda company's new operations in South America have attracted considerable attention. Through subsidiaries it has undertaken the development of the Potrerillos copper property in Chile. Three companies have been organized to continue the work, namely, the Andes Copper Co., with a capital of \$50,000,000; the Andes Copper Mining Co., with a capital of \$50,000,000; and the Potrerillos Railway Co., with a capital of \$5,000,000. The preliminary work has been done through the medium of the Andes Exploration Co., which has a nominal capital controlled by Anaconda. An 80-mile railway will be constructed by the Potrerillos company from Pueblo, Hundida, on the Government railway in Chile, to the side of the proposed reduction-works and mines. Actual ownership and operations of the mining properties will be vested in the Andes Copper Mining Co., while the Andes Copper Co. will hold stock of both the railway and mining companies. The Anaconda Copper Mining Co. will hold the majority stock of the Andes Copper Co., while the minority interests is held by William Braden and associates, who brought the property to Anaconda's attention. It is understood that 75,000,000 tons of ore averaging 1.8% copper has been developed so far, with indications of far greater quantities. Mill tests have been made to demonstrate the best methods of treatment, and it is probable that flotation will be employed. Surveys for the railroad and reduction plant have been made, but it will be several years before Potrerillos enters the producing ranks.

The new hoist ordered for the Elm Orlu will have an 1800-hp. direct-current motor driven from a fly-wheel motor-generator set. It will hoist five tons of ore in counter-balance from an ultimate depth of 3500 ft. at the rate of 2500 ft. per minute. The hoist can haul the same load out of balance at about half this speed. In case the main line switch opens from an ultimate depth of 3500 ft. at the rate of 2500 ft. per hoisting by using the energy stored in the fly-wheel.

The Butte & London shaft is down below the 1300-ft. level; it will be sunk 200 ft. more, and the cross-cuts will be driven on the 1500-ft. level.

The Colorado mine of the Davis-Daly now has a three-com-

partment shaft from the surface to the 2500-ft. level. While it was being sunk, a sinking engine was used at 1500 ft., and a solid rock bulkhead was left in two compartments between 1700 and 1900 ft. to protect the miners working in the bottom. From 1900 ft. the shaft was carried down full size to 2500 ft. The removal of the rock bulkhead interfered with hoisting operations, and the production had to be curtailed until the work in the shaft is completed. Full shifts have been resumed and production is again normal. A recent rumor to the effect that another assessment would be called caused shares to drop from \$2 to \$1.25; the rumor is officially denied and sufficient working capital is on hand for all needs. A new hoist will be installed, as the old one is not large enough to hoist from a depth of 2500 ft. The company's Hibernia claim is one of the most promising of the old silver mines that are being prospected for zinc. It adjoins the Nettie of the Anaconda company, which has been unwatered to a depth of 500 ft., and it is probable that arrangements will be made to explore the Hibernia from the Nettie shaft.

At the Pilot Butte about 60 tons of ore per day is being mined that will average about 5% copper. From this the company is receiving sufficient to pay for not only mining expenses, but also the cost of the development now being carried on in the lower levels. Driving at 2500 ft. has opened an orebody that will materially add to the ore reserves. The property is on a paying basis, in spite of the fact that no ore is being taken from any of the disputed orebodies that were tied up by litigation with the Anaconda company.

The sale of the Butte-Alex Scott mine to the Anaconda company has been ratified by the stockholders of the smaller company. The purchase includes the little Annie claim, and the east 500 ft. of the Alex Scott claim. The Alex Scott adjoins the West Colusa, which is owned by the Anaconda company. The consideration was \$750,000 cash. This sum, together with the money in the treasury, will make each of the 79,311 issued worth about \$10.

PLATTEVILLE, WISCONSIN

CONDITIONS IN THE ZINC REGION DURING JANUARY.

Severe winter weather made milling operations extremely difficult, and free delivery of ore to rail sometimes impossible during January, resulting in a considerable tonnage of zinc concentrate piling-up at some points, and a curtailed output at others. Recent work in refining crude concentrate is resulting in high efficiency at times, 62% zinc concentrate now being regular at three of the new plants started within the last 90 days.

Blende of all grades continued in excellent demand during the month, except in the closing week. The base then had receded to a point under \$100 per ton, the highest going at \$110; \$55%, \$80 to \$90; 50%, \$70 to \$80; 45%, \$50 to \$55; 40%, \$45 to \$50; and 35%, \$35 to \$40. Less than two years ago zinc producers said that fair profits were realized with 'jack' on a basis of \$40 per ton for 60% metal content. This price was easily obtained for the lowest grade now recognized in the current quotations on graded stuff.

Regarding the future status of zinc ore the Press correspondent secured interviews with leading officials, east and west. One prominent man of the New Jersey Zinc Co. confidently expressed the opinion that zinc-ore prices will be maintained for the next two years. Another smelter of national reputation observed that prices would be well maintained until well along into the autumn of 1916, when they would weaken; but he did not think the low standards prior to August 1914 would come for several years. A third, representing a large eastern mining syndicate, largely engaged in the production of zinc ore in both the Wisconsin and Missouri fields, and an ore-buyer of no small pretense, pointed with satisfaction to the situation in the galvanizing trades, declaring that about 60% of capacity was idle, and that a forward

buying movement must soon take place in volume, since much dissatisfaction exists in sheets and painted materials offered as substitutes for galvanized material. This last mentioned source of information conveyed encouragement to all producers predicting higher prices for blende. The end of the month saw the range widened, running from \$85 to \$105 per ton, and giving buyers wider latitude in submitting bids. The reserve in the field at the close of the month exceeded 3000 tons, but this newly-accumulated output was not due to prices so much as to bad roads, which at times entirely isolated outlying producers.

The lead-ore demand was good, opening at \$72 to \$78, and receding, only to gain the ground lost quickly and coming back stronger than before when the high price of \$82.50 was reached. This is near the high mark of 1906, when the price reached \$90 per ton.

Producers of pyrite experienced slight advances in the price of fines, recovered at separating plants. Deliveries were made under contract, but statements from buyers showed that sales were made uniformly on a basis of \$4 per ton, 30% basis.

Miners in the northern section of the field suffered more on account of weather and roads than did those in the south half of the field; the former are farther removed from rail. Producers of carbonate zinc ore are at a greater disadvantage than jack miners, since milling is confined more to open-air wash-places. Prices for zinc carbonate ore ruled high, rising steadily at \$70 to \$80 per ton, 40% base. Several hundred tons of ore was carried over. Shipments were light, on the whole, and prices sadly out of tune with the ruling quotations.

Building operations at all points in the field suffered no setbacks during January. Several new producers with entire modern equipment were ushered into active existence. Drilling operations were given impetus at several points in the field by the introduction of new drilling outfits brought-in from other parts of the country. Road building in the southern districts made substantial gains. New capital came into the field, several cash transactions being responsible for the transfers of newly-developed properties. The gross turn-in of crude concentrates for the month was 27,012,000 lb., and net deliveries to smelters 15,310,000 pounds.

For the first time in the history of this mining region, strikes of a rather serious nature developed. Shovelers receiving 8c. per can per shift record of 50 cans or more, walked out in three districts, demanding a uniform rate of 8c. per can. Operators not only refused to meet the demand, but promptly shut-down their mines and plants. New gangs of men were hastily recruited, and operations resumed under police surveillance. Trouble was brewing, but no disturbances were manifest aside from individual encounters, two resulting in stabbing affrays. The foreign element of miner is principally involved.

TORONTO, ONTARIO

SILVER AND MINING SUPPLIES.—QUEBEC MINING LAW.

Notwithstanding the recent increase in the price of silver, profits of the Cobalt companies have been lessened owing to the considerable increase in the cost of mining supplies. Since the beginning of the War, blasting-powder has about doubled in price and all steel products have advanced considerably. In fact, prices all round have risen so that the question of keeping down operating costs has become a serious problem. At some of the mines drastic measures of economy are being enforced.

The Quebec mining law is being amended to facilitate operations by small prospectors. The minimum size of a mining concession will be reduced from 100 to 40 acres. The price of lots on the north shore of the Gulf of St. Lawrence, where blacksand deposits hold out good prospects for iron mining, will be reduced.

THE MINING SUMMARY

The news of the week as told by our special correspondents and compiled from the local press.

ALASKA

ANCHORAGE

In January the Alaska Gastineau mill treated 119,914 tons of ore averaging \$1.37 per ton, against 114,183 of \$1.36 in December.

ARKANSAS

Bad weather reduced zinc production in north Arkansas in January, the roads between Rush and Yellville being considerably cut up. The output from 12 mines was 40 carloads.

ARIZONA

COCHISE COUNTY

Tombstone is considerably busier than for a long time. At its Bunker Hill property Phelps, Dodge & Co. are employing 400 men. The old mill is working at part capacity. A good deal of manganese ores is being shipped. Wages were increased 10% on February 16. Emil Grebe is superintendent.

After over a two years' lease, the property worked by the Higgins Leasing Co. in the Warren district, has reverted to the owner, Thomas Higgins of Los Angeles. During the lease a considerable quantity of copper ore was extracted, and good dividends were paid.

GHA COUNTY

At the Inspiration mill 17 units are in operation. Additional men have been taken on underground. On account of trouble with the railway, shipments of silicious ore from the Live

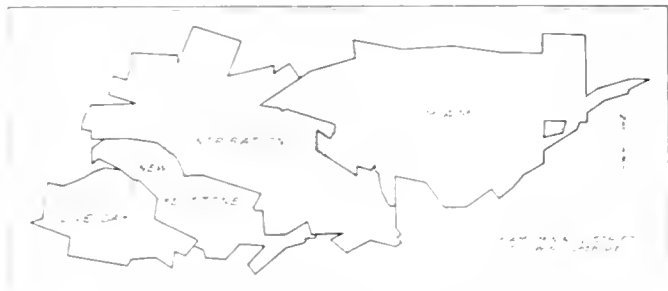

PROPERTY MAP OF MIAMI, ARIZONA.

Ore mine to the International smelter have been interrupted lately.

At the Old Dominion the flow of water has increased to 11,000,000 gal. per day. No. 12, 14, and 16 levels are producing 1,000 tons of ore daily through the A shaft. The Kingdon shaft will be down to No. 16 within a month. At the smelter three furnaces are in blast, and two converters. Over 100 tons of fine concentrate is briquetted per day for the furnaces. Some concentrate goes to the International smelter. The mill treats 700 tons daily.

GREENLEE COUNTY

The Shannon mine is reported to be operating at nearly full capacity again, and the February output will be 750,000 lb. copper. The effects of the strike were soon smoothed over.

Trouble between unionists and non-unionists at the Detroit mine on February 11 resulted in 900 men going out on strike again. Similar trouble at the Shannon also led to 100 men

walking out. It is alleged that the union men threatened the others, and the superintendent discharged the unionists.

The strike was settled on the following day by re-instating the discharged men. The union officials considered the walk-out premature. Non-union men are to be kept out, 20% of employees do not belong to the union.

MOHAVE COUNTY

According to the Chloride Mining Bureau the Chloride district produced gold, silver, lead, zinc, and copper worth over \$3,000,000 in 1915. The Bureau has been organized for reliable publicity purposes, with L. V. Carothers as secretary. The new mill at the Galeonda zinc mine has electric power service now. The 200-ton flotation plant will treat tailing as well as current mine ore.

At 665 ft. in the United Eastern at Oatman the cross-cut shows 27 ft. of ore assaying from \$15 per ton up.

YAVAPAI COUNTY

From the 1400-ft. level of the United Verde Extension 15% copper ore is reported to have been opened; while another cross-cut at that depth has passed through 30% ore, the downward extension of the 1200-ft. shoot. The new hoist of 1000 tons' daily capacity is working well, also the new 5000-ft. tramway from the mine to the Clarkdale railway.

Encouraging developments are reported from a score of mines in the Zonia district.

A flotation plant is to be installed at the old Tiger mine to treat 10,000 tons of \$8 tailing. The Flotation Recovery Co. is in charge.

CALIFORNIA

CALAVERAS COUNTY

(Special Correspondence.)—The manager of the Calaveras Copper Co., S. M. Levy, reports that during the past year the principal work in the mine has been done in extending levels along the lode, mostly on the fourth. Marketable ore has been opened for 1500 ft. along this level. The sixth level has also been opened, but not so extensively as the fourth. Considerable work has also been done on No. 10, the lowest, a vertical depth of 800 ft. The character of the ore to this level is unchanged from that near the surface, being principally chalcocopyrite. During the year a rock-breaking and sorting-plant was erected at the Union mine, one of the company's properties, the plant having a capacity of from 200 to 250 tons per day. The ore is broken here and passed over a belt from which some of the ore of shipping grade is hand-sorted, the remainder going to the mill by an electric tramway, a half-mile long. The mill has a small flotation plant installed for experimental work. This mill is now being replaced by one of larger capacity. The first unit of 250 tons daily is nearing completion, and it is anticipated that this mill will be equipped with ball-mills, Dorr classifiers and thickeners, and Oliver filters, all driven by motors. It is expected that if this initial unit operates satisfactorily another of 250 tons capacity will be installed during the late spring or summer.

Copperopolis, February 1.

INYO COUNTY

High prices of zinc and lead, substitution of an aerial tram in place of haulage by teams, electric-power service, and encouraging development, have combined to make prospects at the Cerro Gordo mines, near Keeler, very satisfactory. Seventy

men are employed. The output in 1915 was 4,440,666 lb. zinc, 121,510 lb. copper, 748,952 lb. lead, 126 oz. gold, and 112,541 oz. silver. Old workings and dumps contain a large quantity of material for treatment.

LAKE COUNTY

Efforts are being made to finance the Abbott quicksilver mine in the Sulphur Creek district. The mine has been extensively opened, and has produced a good deal of mercury. A Scott furnace forms part of the equipment. Dumps contain a good quantity of ore.

SANTA CLARA COUNTY

The old Guadalupe quicksilver mine, 10 miles south of San Jose, has been purchased by H. C. Davey and others for a high price. They were lessees from the Coleman estate, and bought the property when the lease expired. A complete reduction plant is in full working condition.

At New Almaden a considerable amount of new work is under way, especially metallurgically.

SHASTA COUNTY

As long as copper is 20c. or over, the Mammoth, Mountain Copper, and Balaklava companies will pay their men 25c. per shift extra. A total of 1830 men are affected.

It is proposed to enlarge the Uncle Sam mill and try flotation. The ore is mostly gold-bearing.

The U. S. S. R. & M. Co. has acquired 2000 acres on Big Backbone creek, adjoining the Mammoth holdings, from Charles Butters and others for \$75,000.

YOLO COUNTY

The old Reed quicksilver mine, in the western part of this county, has been sold to Breed and Bancroft of Oakland for \$5000. The adits and plant are in bad order, and must be renewed at considerable cost. The mine has produced several thousand flasks of mercury.

COLORADO

CONEJOS COUNTY

(Special Correspondence.)—The old Summitville-Platoro mining district in southern Colorado is on the eve of a great revival. The large orebodies opened years ago, too low grade to ship from this isolated district, and too refractory for treatment by cyanidation, are now being tested by flotation processes from several of the old properties. Preliminary tests show a far better recovery of metals by flotation than by any other method. It is reasonably certain that flotation is especially adapted to these ores, and that mills employing this process will be installed on some of the most developed properties this year. There are a number of undeveloped claims in the district showing good bodies of low-grade milling ore on the surface, that only need development to open a large tonnage of good-grade ore. The greatest need of this district at the present time, is the erection of a custom-mill to treat the ores from these smaller properties at reasonable charge.

Platoro, February 5.

IDAHO

SHOSHONE COUNTY (COEUR D'ALBINE)

Following the increase of wages announced by the Bunker Hill & Sullivan and other companies at Kellogg and Wardner last week, all of the other companies in the Coeur d'Alaine have adopted the sliding-scale. About 5000 men will benefit, while metals are high, making a total increased pay-roll of over \$1,000,000.

High-grade tungsten ore (scheelite) continues to be shipped from the Golden Chest mine near Murray.

MICHIGAN

THE COPPER COUNTRY

(Special Correspondence.)—Owing to the blizzards during January, the worst for 30 years, the copper output of the

region was 7,000,000 lb. below the yield of December, and 9,000,000 lb. under what was anticipated, the total being 20,000,000 lb. February also started badly.

The White Pine mill is working two shifts daily, yielding equal to 6,000,000 lb. of copper per year. The ore contains 30 lb. per ton.—At the White Pine Extension 75 men are employed. Recent diamond-drilling shows rich ore, the best being in shale.—Other companies are busy in the area adjacent to White Pine.

Houghton, February 12.

Owing to the water of Lake Linden freezing around the suction-pipe of the Calumet & Hecla dredge, there has been considerable trouble in lifting sand for the re-grinding plant. A 1250-hp. pump has replaced that of 750 hp. The sand nearest the shore is of better grade than that farther out.

By the increased bonus of 5 to 10% monthly, 1500 men at the Wolverine and Mohawk mines will benefit.

MONTANA

SILVERBOW COUNTY

(Telegraphic Correspondence.)—Fire broke out near air-shaft of 1200-ft. level of the Anaconda company's Pennsylvania mine on February 14, where 220 men were working. Gas and smoke quickly filled the upper levels. Fourteen men were asphyxiated; seven are missing. Station-men and foremen quickly hoisted the shift, saving 200 lives. Mine rescuers with helmets did good work; pulmotors revived many. Water was poured down air-shaft. The big exhaust-fan installed makes the air-shaft upcast, hoisting shaft is downcast. It is expected to clear the mine of smoke and gas to permit of an examination. The fire is burning fiercely. Openings to adjoining properties are bulkheaded. Many deeds of heroism are recorded. Assistant-foreman wearing helmet and one member of helmet squad are dead. Helmet-men are working 10-minute shifts.

Butte, February 16.

A cross-cut at 2600 ft. in the Anaconda company's High Ore mine has reached the boundary of the Butte-Balaklava, equal to the latter's 2200 ft. level, showing 4 ft. of 4% copper ore. A cross-cut from the Balaklava winze below 1600 ft. has opened 24 ft. of 2% ore.

NEVADA

CLARK COUNTY

According to the U. S. Geological Survey a massive deposit of magnesite of unusual character has been identified in the valley of the Muddy river, a few miles above the town of St. Thomas. Railroad service is available three miles away at Kaolin. The mineral has been known as kaolin for sometime. The deposit is included between tilted beds of conglomerate and sandstone below and shale above. It is not a vein. Analysis show 36.72% magnesium oxide, 5.36% lime, 11.12% silica, 44.15% carbonic acid gas, and 0.98% alumina and iron oxide.

ESMERALDA COUNTY

On March 6 the Reorganized Booth Mining Co. will pay 5c. a share, equal to \$50,000.

The Pittsburg Silver Peak Gold Mining Co. has dismantled its mill near Blair. The company is examining the Rawhide mine at Sonora, California.

The Jumbo Extension company reports as follows for January: Ore shipped was 3123 dry tons, with a gross value of \$81,500; freight, treatment, and sampling cost \$28,250; smelting losses were \$12,500; and operating costs \$17,500, leaving a net realization of \$23,250.

ELKO COUNTY

Since January 1 the Clover Mining Co., near Wells, has shipped 24 cars of zinc carbonate assaying from 28 to 39% metal.

HUMBOLDT COUNTY

At a depth of 1500 ft. in the Seven Frouths Coalition mine the shoot has widened to 16 and 20 in. of \$500 ore.

NYE COUNTY

Tenopah mines last week produced 8451 tons of ore worth \$177,032. Silver and concentrate shipments amounted to \$245,867.

OREGON

Minerals of Oregon is the title of a University of Oregon bulletin by Graham John Mitchell. The publication consists of 60 pages, and was prepared to give students in economic geology as complete a list as possible of the minerals found in the State, together with their situation, and to give the people generally some idea of the minerals found in Oregon. The minerals are arranged alphabetically. Prospectors and others should secure a copy of this bulletin.

UTAH

JEAR COUNTY

Better weather allowed increased shipments from Tintic last week, the total being 123 carloads.

SUMMIT COUNTY

Park City shipments last week amounted to 1075 tons.

During January the Snake Creek tunnel at Park City was extended 410 ft., 90 ft. of which was bad ground. The total length is 11,122 ft., a depth of 3730 ft. from the surface. The Daly-Judge property will be entered in a few weeks. The flow of water is 9000 gal. per minute.

MEXICO

The Department of State at Washington, D. C., has issued under date of February 7, 1916, the following notice relative to the shipment of munitions of war into Mexico:

In order to avoid confusion and delay in submitting to the Department of State applications for permission to ship munitions of war into Sonora, Chihuahua, and Lower California, the following mode of procedure is stated for the benefit of those who contemplate making such shipments: No munitions of war, such as powder, dynamite, blasting caps, mining fuse, guns, and ammunitions, etc., will be permitted to enter any of the sections mentioned without specific authorization of the President. Those desiring to take or ship munitions into any of the territory specified must make application directly to the Department of State, except that persons making shipments of munitions for the *de facto* Government of Mexico should submit their applications to the Washington representative of General Carranza. Full details as to amount, destination, American border port through which the shipment is to be sent, purpose for which intended, and names of shipper and consignee should be given with all applications. Mining companies should make note of this regulation.

El Oro

Fernando Allan and Alfred F. Main of the El Oro Mining & Railway Co. recently had an interview with Pablo Gonzalez in Mexico City, the result of which was a decree from General Obregon repudiating overt acts of El Oro strikers, which will probably put an end to strikes there. The Esperanza company has received enough cyanide and other supplies to last a year, and it is rumored it will resume on February 15. The other companies will probably soon follow. Dos Estrellas is also receiving some supplies.

HIDALGO

During December the Santa Gertrudis mine produced 19,841 tons of ore with a profit of \$67,000.

SONORA

In order to prevent poor people entering this State without means, the Carranza government states that with the passports issued, everybody must have \$50 in cash.

PERSONAL

H. C. BOSWORTH has returned to Mexico City.

MARK L. REQUA has returned from New York.

A. E. DRUCKER is still at La Sulada, Colombia.

H. VINCENT WALLACE is now living in New York.

HOWARD D. SMITH has returned from New York.

H. W. EDMONDSON is in Madison county, Missouri.

W. J. LORING has returned to town from Tuolumne.

SCOTT TURNER has returned from London to Lansing.

R. M. GERRIT is at the Esperanza mine, El Oro, Mexico.

J. H. FARMER, of Los Angeles, is at Marquette, Michigan.

A. J. EVELAND, recently at Pachuca, has gone to South America.

S. S. ROGERS is superintendent of the Anaconda company's zinc concentrator.

D'ARCY WEATHERIE crossed in the *Adriatic* to New York on his way to Cobalt.

FRED HELLMANN, manager of the Chuquibambata, has arrived in New York from Chile.

WILLIAM FORSYNER is investigating quicksilver deposits in Siskiyou county, California.

EDGAR RICKARD spent the week in San Francisco, and is now returning to London, by way of New York.

BURR J. FRENCH is engineer for the Cinco Minas, Magdalena, Jalisco. These mines have operated steadily during the past year.

THOMAS N. MILLER has resigned from the staff of the Oriental Consolidated Mining Co., Unsan, Korea, to go to the Philippine Islands.

REGINALD E. CALLOW is at El Tigre, Sonora. He reports that all the mines and mills in that part of Mexico are resuming operations.

GEORGE A. CAMPBELL, of the firm of Camphuis & Rives of El Paso, is operating copper properties for Eastern interests in Pima county, Arizona.

L. D. GORDON, well known at Cerro Gordo, California, has been elected president and general manager of the Round Mountain Mining Co., Nevada.

WALLACE E. PRATT, chief, Division of Mines, Bureau of Science, Manila, P. I., has resigned and has been engaged in private work in Mexico since February 15.

ARTHUR B. FOOTE read a paper on 'Engineering Features of the North Star Mines' before the local section of the American Society of Civil Engineers at the Palace Hotel on February 18.

FRANK M. ESTES, manager of the Creston-Colorado mines, Minas Prietas, Sonora, has re-opened that property for the Mines Company of America. A full staff accompanied him to the mines.

FRANK H. PROBERT is to lecture to mining students at the University of California on February 21, 23, 24, and 25, at 4 p.m. each day. The subject will be 'Outcrops and the Zone of Oxidation.' Lecture 1 will discuss the Anatomy of the Earth's Crust. Physical Forces at Work. No. 2. Life History of the Outcrop. Contributory Causes to the Constant Change. No. 3. Chemical Forces at Work. Migration of the Metals. No. 4. Significance of Surface Signs. Types. These lectures are open to the public.

THE COLORADO SCHOOL OF MINES announces that the U. S. Bureau of Mines will move its laboratory from Denver to Golden early in June. The two institutions will co-operate in investigation work. R. B. Moore and 10 assistants comprise the Bureau staff.

THE METAL MARKET

METAL PRICES

San Francisco, February 16.

| | |
|---|-----------|
| Antimony, cents per pound..... | 44 |
| Electrolytic copper, cents per pound..... | 27.75 |
| Molybdenum: dull, 90% MoS ₂ , per pound..... | \$1.40 |
| Pig lead, cents per pound..... | 6.55—7.50 |
| Platinum: soft metal, per ounce..... | \$85 |
| Platinum: hard metal, 10% iridium, per ounce..... | \$89 |
| Quicksilver: per flask..... | \$300 |
| Spelter, cents per pound..... | 21 |
| Tin, cents per pound..... | 43 |
| Zinc-dust, 100-kg. zinc-lined cases, cents per pound.. | 30 |

ORE PRICES

San Francisco, February 16

| | |
|---|--------|
| Antimony: 50% product, per unit..... | \$2.25 |
| Chrome: 40% and over, f.o.b. cars California, per ton..... | 11 |
| Magnesite: crude, per ton, f.o.b..... | 8 |
| Magnesite: plastic, no iron and lime, calcined, per ton.... | 30 |
| Magnesite: refractory, 11% iron, dead-burned, per ton.... | 35 |
| Manganese: 50% metal, 8% silica, per ton, f.o.b. cars, S. F. | 12 |
| Tungsten: minimum 65% WO ₃ , per unit of 20 lb. for spot.. | 45 |

Tungsten ore has advanced \$12 per unit in Colorado, \$57 per unit being paid.

So many of those mining chrome, tungsten, molybdenum, and other ores write to us asking where they may dispose of their products that we call attention to the 'Buyers' Guide' on the last page of each issue. Under 'Metal Buyers and Dealers' are listed the firms with which we recommend that mine operators open negotiations. These dealers buy, or will refer you to buyers, of practically all ores at present in increasing demand.

EASTERN METAL MARKET

(By wire from New York.)

February 16.—Copper has a runaway tendency; lead is firm owing to foreign buying; zinc is active, there being a great scarcity of spot metal.

SILVER

Below are given the average New York quotations, in cents per ounce, of fine silver.

| Date. | Average week ending |
|------------------|---------------------|
| Feb. 10..... | 56.62 |
| " 11..... | 56.62 |
| " 12..... | 56.62 |
| " 13 Sunday..... | 56.62 |
| " 14..... | 56.62 |
| " 15..... | 56.50 |
| " 16..... | 56.75 |

Monthly averages.

| 1914. | 1915. | 1916. | 1914. | 1915. | 1916. | |
|-----------|-------|-------|-------|------------|-------|-------|
| Jan. | 57.58 | 48.85 | 56.76 | July | 54.90 | 47.52 |
| Feb. | 57.53 | 48.45 | | Aug. | 54.25 | 47.11 |
| Mch. | 58.01 | 50.61 | | Sept. | 53.75 | 48.77 |
| Apr. | 58.52 | 50.25 | | Oct. | 51.12 | 49.40 |
| May | 58.21 | 49.87 | | Nov. | 49.12 | 51.88 |
| June | 56.43 | 49.03 | | Dec. | 49.27 | 55.34 |

A good undertone characterizes the silver market. London sees a healthy future for the metal, judging by the statistical position, as there have been large reductions in metal held at the chief silver using centres of the world since a year ago, especially in India, Shanghai, and London. In India the gold holdings are increasing, and silver decreasing, therefore purchases for Indian coinage are likely.

COPPER

Prices of electrolytic in New York, in cents per pound.

| Date. | Average week ending |
|------------------|---------------------|
| Feb. 10..... | 26.87 |
| " 11..... | 26.87 |
| " 12..... | 27.00 |
| " 13 Sunday..... | 27.12 |
| " 14..... | 27.25 |
| " 15..... | 27.25 |
| " 16..... | 27.25 |

Monthly averages.

| 1914. | 1915. | 1916. | 1914. | 1915. | 1916. | |
|-----------|-------|-------|-------|------------|-------|-------|
| Jan. | 14.21 | 13.60 | 24.30 | July | 13.26 | 19.09 |
| Feb. | 14.46 | 14.38 | | Aug. | 12.34 | 17.27 |
| Mch. | 14.11 | 14.80 | | Sept. | 12.02 | 17.69 |
| Apr. | 14.19 | 16.64 | | Oct. | 11.10 | 17.90 |
| May | 13.97 | 18.71 | | Nov. | 11.75 | 18.88 |
| June | 13.60 | 19.75 | | Dec. | 12.75 | 20.67 |

On April 16 the Guggenheim Exploration Co. will distribute \$12 per share in cash, and one share of beneficial interest in the Yukon-Alaska Trust for every four shares of Exploration stock.

Copper Range is paying \$1.50 per share for the quarter; earnings are \$17 per year.

Cerro de Pasco will pay its initial quarterly dividend of \$1 per share on March 1. The monthly output is 6,000,000 pounds.

LEAD

Lead is quoted in cents per pound, New York delivery.

| Date. | Average week ending |
|------------------|---------------------|
| Feb. 10..... | 6.25 |
| " 11..... | 6.25 |
| " 12..... | 6.25 |
| " 13 Sunday..... | 6.25 |
| " 14..... | 6.25 |
| " 15..... | 6.25 |
| " 16..... | 6.30 |

Monthly averages.

| 1914. | 1915. | 1916. | 1914. | 1915. | 1916. | |
|-----------|-------|-------|-------|------------|-------|------|
| Jan. | 4.11 | 3.73 | 5.95 | July | 3.80 | 5.59 |
| Feb. | 4.02 | 3.83 | | Aug. | 3.86 | 4.67 |
| Mch. | 3.94 | 4.04 | | Sept. | 3.82 | 4.62 |
| Apr. | 3.86 | 4.21 | | Oct. | 3.60 | 4.62 |
| May | 3.90 | 4.24 | | Nov. | 3.68 | 5.15 |
| June | 3.90 | 5.75 | | Dec. | 3.80 | 5.34 |

Lead concentrate, 80% metal, averaged \$85 per ton at Joplin, Missouri, last week.

Provided prices of lead, zinc, silver, and copper keep up, the mines of the Coeur d'Alene region in Idaho will distribute \$12,000,000 in dividends in 1916, an increase of \$2,500,000.

QUICKSILVER

The primary market for quicksilver is San Francisco, California being the largest producer. The price is fixed in the open market, according to quantity. Prices, in dollars per flask of 75 pounds:

| Date. | Week ending |
|--------------|-------------|
| Jan. 19..... | 225 |
| " 26..... | 275 |

Monthly averages.

| 1914. | 1915. | 1916. | 1914. | 1915. | 1916. | |
|-----------|-------|-------|--------|------------|-------|--------|
| Jan. | 39.25 | 51.90 | 222.00 | July | 37.50 | 95.00 |
| Feb. | 39.00 | 60.00 | | Aug. | 80.00 | 93.75 |
| Mch. | 39.00 | 78.00 | | Sept. | 76.25 | 91.00 |
| Apr. | 38.90 | 77.50 | | Oct. | 53.00 | 92.90 |
| May | 39.00 | 75.00 | | Nov. | 55.00 | 101.50 |
| June | 38.60 | 90.00 | | Dec. | 53.10 | 123.00 |

The quicksilver market is firm.

ZINC

Zinc is quoted as spelter, standard Western brands, New York delivery, in cents per pound.

| Date. | Average week ending |
|------------------|---------------------|
| Feb. 10..... | 19.75 |
| " 11..... | 19.75 |
| " 12..... | 19.75 |
| " 13 Sunday..... | 19.75 |
| " 14..... | 19.75 |
| " 15..... | 20.25 |
| " 16..... | 20.25 |

Monthly averages.

| 1914. | 1915. | 1916. | 1914. | 1915. | 1916. | |
|-----------|-------|-------|-------|------------|-------|-------|
| Jan. | 5.14 | 6.30 | 18.21 | July | 4.75 | 20.54 |
| Feb. | 5.22 | 9.05 | | Aug. | 4.75 | 14.17 |
| Mch. | 5.12 | 8.40 | | Sept. | 5.16 | 14.14 |
| Apr. | 4.98 | 9.78 | | Oct. | 4.75 | 14.05 |
| May | 4.91 | 17.03 | | Nov. | 5.01 | 17.20 |
| June | 4.84 | 22.20 | | Dec. | 5.40 | 16.75 |

Zinc concentrate, 60% metal, sold as high as \$125 per ton at Joplin, Missouri, last week, the market being strong. The Missouri-Kansas-Oklahoma region produced 7457 tons blends, 583 tons calamine, and 1147 tons lead, averaging \$105, \$83, and \$85 per ton, respectively. The total value was \$933,191.

The new electrolytic plant of the Anaconda company is expected to make a net profit of \$1,000,000 per annum, provided the price of spelter does not decline.

Butte & Superior is producing 140,000,000 lb. of spelter per year, yielding a profit of \$14,000,000, equal to \$50 per share, that is, if prices are maintained.

TIN

Prices in New York, in cents per pound.

| Date. | Average week ending |
|-----------|---------------------|
| Jan. | 37.85 |
| Feb. | 39.76 |
| Mch. | 38.10 |
| Apr. | 36.10 |
| May | 33.29 |
| June | 30.72 |

Monthly averages.

| 1914. | 1915. | 1916. | 1914. | 1915. | 1916. | |
|-----------|-------|-------|-------|------------|-------|-------|
| Jan. | 37.85 | 34.40 | 41.76 | July | 31.60 | 37.38 |
| Feb. | 39.76 | 37.23 | | Aug. | 50.20 | 34.37 |
| Mch. | 38.10 | 48.76 | | Sept. | 33.16 | 33.12 |
| Apr. | 36.10 | 48.25 | | Oct. | 30.40 | 33.06 |
| May | 33.29 | 39.23 | | Nov. | 33.51 | 39.50 |
| June | 30.72 | 40.26 | | Dec. | 33.60 | 38.71 |

Tin is steady at 41.75 to 42.25 cents.

Eastern Metal Market

New York, February 11.

Spot copper has sold at 28c. June shipments are quoted at 27c. and July, August, and September at 26.50c. The market to-day deals principally with forward deliveries. London shows feverish strength, and has advanced to £134 for electrolytic. The situation is due to the enormous demand for copper to be worked into munitions of war, the manufacture of which is now at its height. The trade is simply bewildered by the extent to which the metal is being consumed, and at the indifference to high prices. No other period in the history of trade offers comparisons. Zinc has been in good demand in the past few days, and its quotations are steadily rising. Lead has gone up \$3 per ton, following good export and domestic buying, in which premiums were paid. The tin market has been uneventful, despite perilous shipping conditions. The metal is arriving in generous quantities. Antimony is scarce and higher, and small consumers are in a quandary because of the guarantees exacted by the British government. Aluminum quotations are on the upward trend. Exports of the metals appear to be somewhat smaller than they have been, but this is because they are now going abroad in manufactured form more than in the raw state.

The steel situation may be summed up with the statement that many mills, both in the East and West are sold up for the war, with consumers looking into 1917. Ship-yards especially have sought to cover their needs for 1917, as well they might, with two and three years' work in their yards. The French government has purchased steel-rounds in the past few days, amounting to over 250,000 tons. Some mills have gone in so heavily for the War business that they cannot properly take care of their domestic customers; others have kept the interests of their regular trade in mind. The quotations of finished products vary so with deliveries that it is difficult to keep track of them.

COPPER

Both in the United States and abroad a most extraordinary situation exists in copper. In both New York and London prompt and nearby deliveries are difficult to obtain, and prices are soaring. Their level is entirely determined by the delivery specified. The real market is almost entirely in future positions. June shipments of electrolytic are quoted at 27c., while for a few carloads of spot metal 28c. has been paid. For July, August, and September 26.50c., 30 days, delivered, or 26.27c., cash, New York, is asked. Lake prices range about the same. Day after day the London market for electrolytic has advanced, demonstrating the futility of the effort of the Government to control prices there. By February 10 the London quotation had mounted to £134. The explanation of the whole situation is the tremendous consumption of copper in the manufacture of munitions of war. Millions of pounds are being worked into one form or another by consumers, new and old. Perhaps the two heaviest uses are in the production of cartridge brass, and in the extrusion of large rods from which the nose pieces and timing devices of shells are made. With practically all of the war contractors, price seems no object, and for the following reason: when they figure on a war inquiry involving copper, their first move is to ascertain what the copper will cost. They then base their estimate on the cost of material and manufacture, adding, of course, a generous profit. A producer of copper recently said in a quiet way, which carried conviction: "We can get almost any price for copper." However that may be, the 30c. level is near. France has been an especially heavy buyer. Canada is using great quantities as might be expected. Sheet-copper is quoted at 33c. base, and high sheet-brass 36 to 38c., and brass rods and

wire at the same prices. In the week ended January 29 manufactured brass was the largest item of export, amounting to \$1,597,029, according to figures compiled by the export department of the National City Bank of New York. Exports, up to and including February 10, totaled 6331 tons.

ZINC

All this week there has been a steady and strong demand for zinc, and quotations have advanced from day to day. The quotation on February 10 was about 19.50c. St. Louis, and 19.75c., New York. The scarcity of prompt metal lends strength to the market, and it is made stronger by reports of serious floods in the Joplin district, Missouri, which threaten to reduce the production of ore. The London market is strong. It was quoted yesterday at £92 for spot, an advance of 1 over the preceding day. Export up to and including the 10th totaled 990 tons.

The base price of sheet-zinc is unchanged (February 10) at 24c. carload lots, f.o.b. mill, 8% off for cash.

LEAD

The expected advance in the A. S. & R. Co. quotation for lead at New York came late on the afternoon of February 9, when the price was put up \$3 per ton, or to 6.25c. per lb. (from 6.10c.) The advance was no surprise to anyone, in view of the fact that the independents had been getting premiums for the metal, especially where sales for export were made. Both the domestic and foreign demand has been good. The St. Louis quotation, following the advance, went up to 6.17½c., a figure which the outsiders shaded a couple of points. Lead is rapidly approaching the situation which exists in copper, and should the heavy demand be sustained it will not be long before a shortage will develop. The London supply is none too large. Exports this month up to and including the 10th totaled 3121 tons.

TIN

The quotation for spot tin has not varied far from 41.25c. this week, in a market that has been quiet and easy. Buyers are well covered, at least for the near future, and this fact, with the large arrivals and easy market at London, makes conditions dull. Up to and including the 10th, 2455 tons arrived this month, and there was afloat on that day 5870 tons. The total visible supply on January 31 was 17,941 tons, against 13,961 tons, on that date of 1915. The Welsh tin-plate mills are working far under their capacity, Great Britain needing the steel for other purposes, consequently there is a surplus of tin for export from England.

The A. S. & R. Co. reports that it has just started its tin smelter at Perth Amboy, N. J., and that three months probably will elapse before any definite results can be announced. Delay in receiving the first shipment of Bolivian concentrate, held up by the failure of the Panama Canal, has hindered operations. The brokers importing Straits tin regard the project most seriously, as they have faith in the outcome of what the A. S. & R. Co. undertakes.

ANTIMONY

Prompt Chinese and Japanese grades are scarce, and quotations range from 43.50 to 45c., duty paid. The British antimony regulations, similar to those prevailing in tin, are now effective, and antimony which arrives in British ships and consigned to the British Consul is not released until the dealer who seeks to get the metal gives a guarantee from the ultimate consumer.

ALUMINUM

The demand has quickened and quotations are higher at 55 to 58c. for No. 1 virgin aluminum, 98 to 99% pure.



EDITORIAL



T. A. RICKARD, Editor

OBREGON is reported to have been married at Hermosillo and General Carranza is said to have given him away on that auspicious occasion. The talk of friction between them, is thus negated. We note also that the increased taxes on mining property must be paid until the end of July, by which time it is to be hoped that more genial conditions will supervene both in the political and fiscal departments of Mexican administration.

WITH the completion of the 18 sections of the mill, the Inspiration Consolidated Copper Company will be treating 14,000 tons daily by flotation at Miami, Arizona. As one of the pleasant features of flotation plants is that they exceed their estimated capacity, it is expected that 15,000 tons will be treated daily in this mill, making it the largest copper-flotation plant in America. The metallurgical extraction is not nearly so complete as at Anaconda because a part of the ore subjected to flotation at Miami is oxidized. Published statements give the recovery as 83 per cent.

SEVERAL months ago we hazarded the opinion that the prices of the chief base metals would continue to benefit from the intensified demand created by the War, and that when hostilities ceased there would come a supplementary demand for the work of reconstruction and rehabilitation in the countries devastated by warfare. We note with satisfaction that an authority so likely to be well informed as Mr. John D. Ryan, the president of the Anaconda Copper Mining Company, has stated recently that it is the belief of himself and his co-directors that "during the continuance of the War, the consumption [of copper] will at least maintain its present level, and that peace in Europe will bring an enormous demand for copper in all the countries now at war, to replace depleted stocks and restore industries in which the metal is indispensable." It is said that while the German Chancellor was asserting that the supplies of copper in Germany were ample, his speech was nearly drowned by the noise made by workmen engaged in removing the copper roofing of the Reichstag. This, of course, is apocryphal, but many a true word is said in jest. There is the other story that German purchases of copper in large amount have been made in New York during the past six months with a view to storage until shipment becomes possible. As to that also we do not know, but such action would be quite in accord with German foresight. The Japanese also are reported to be storing copper. It does seem highly probable, almost certain, that the withdrawal of copper from necessary

use and the destruction of metal during the War, whether in ships, machinery, munitions, or utensils, will require to be replaced, while at the same time the resumption of industry will renew a large part of the normal consumption.

EVIDENTLY the recent meeting of the American Institute of Mining Engineers at New York was most successful, thanks in large measure to Mr. D. H. Browne, the chairman of the local section, who made arrangements that promoted better acquaintance and good fellowship among those in attendance. Mr. W. L. Saunders, in retiring from the presidency, was able to announce a gain of 546 in membership, bringing the total to 5221. He spoke with pardonable pride concerning the co-operation of the Institute with the Naval Consulting Board to which it contributed two members, the president and an ex-president, Mr. Ben. B. Thayer. This innovation has proved so successful as to cause the Government to ask the Institute to nominate a member from each state in the Union to collaborate with the representatives of other engineering societies in a campaign of industrial preparedness. The new president of the Institute, Mr. L. D. Ricketts, is on a professional journey to South America, so he was not able to accept his honorable responsibilities in person, but that did not prevent a general expression of satisfaction that he should have succeeded to the titular leadership of the profession in America.

DURING recent weeks we have been glad to record the increase in wages granted to miners in the West. Some of these concessions, consequent upon the greater gains being won by the mining companies, have been in the form of bonuses, a method suggesting unusual conditions and recognizing the possibly ephemeral character of the high metal-prices now obtainable; but, whatever their form, they represent a wise, because just, policy on the part of the mine and smelter managers. Last week our news columns recorded the profit-sharing bonus distributed to employees of the principal group of mines at Kellogg, Idaho. This is arranged on a sliding scale based on the price of lead at 5 cents per pound and going up to a price of 6 cents, the maximum bonus or increased wages being 75 cents per shift. We note that the Federal Mining & Smelting Company promises a dollar extra when lead is above \$6.50 per hundred pounds, but this savors of the theatrical, for \$6.50 is a highly improbable quotation, having regard to the fact that the price of lead is fixed largely by the Guggenheim group, which controls the Federal company. However,

we smile when we say it. Our readers will be interested to see a comparison between the copper and lead schedules.

| Copper | | Lead | |
|------------------------|------------------------|------------------------|------------------------|
| Metal price, Cents. | Labor bonus, Cents. | Metal price, Cents. | Labor bonus, Cents. |
| 17-17 | 25 | 5-54 | 25 |
| 17-20 | 50 | 54-6 | 50 |
| Over 20 | 75 | Over 6 | 75 |

The average price of lead during the last 30 years has been 4.22 cents at New York, as compared with an average price of 13.84 cents for copper during the same period. Thus the Butte base is 8.1% above the average price of copper, and the corresponding lead base would be 4.57 at Kellogg or 5.86 at New York. The 17-cent basis for copper would correspond with lead at 5.18 cents, which would require a New York quotation of 7.08 cents. In short, the lead miners in the Coeur d'Alene start 10% better than their comrades at Butte, but it is fair to add that the prospects of bonuses based on rising prices of metal are more favorable for the men digging copper than those digging lead ore. Moreover, the bonuses to the latter apply to all the workers, while those in Montana are variously distributed among the different kinds of employment. These, however, are petty details; the point that we desire to emphasize is the good sense of the mining companies in recognizing the propriety and fairness of giving their employees some share of the abnormal profits they are making just now. Whether at Butte or Kellogg, in California or Arizona, the increased payment to miners has been made, not as a belated concession, but as a frank acknowledgment of the fact that the higher cost of living and the booming metal markets alike justify a higher pay to employees. We trust that the idea will be applied to the members of the technical staffs also. It is a rank fallacy to assume that manual labor is the only kind of work worthy of consideration in times like these.

Pyritic Copper Deposits

Current technical literature has been enriched by a paper on 'The Pyritic Copper Deposits of Kyshtim, Russia,' by Mr. A. W. Stickney, appearing in *Economic Geology*. Profitable mining in that part of the Ural region is based upon the exploitation of pyritic copper orebodies in a belt of schist resulting from the metamorphism of a basic igneous rock, intrusive among Devonian sediments, also highly metamorphosed, and appearing now as limestone, schist, and quartzite. This complex series of older rocks has been further modified by more recent intrusions of peridotite or pyroxenite, now largely altered to serpentine, itself also foliated. All these are cut by dikes, which, however, are nowhere found in association with the pyritic orebodies, themselves confined to one of the belts of uralite-schist where that rock has been changed to a highly fissile chlorite- and epidote-schist. The orebodies are found in series, arranged *en échelon*, with intervals of one-fourth to two miles sepa-

rating them. It would not be unreasonable to regard this longitudinal succession of orebodies in the schist as a lode eight miles long. In depth, as far as yet ascertained, the masses of ore become narrower and appear to be shortened, as is not unusual in this type of deposit. The largest orebody has been exposed for a maximum width of 90 feet, a depth of 400 feet, and a length of 1500 feet. A bore-hole has proved it to 320 feet deep. The ore consists of a homogeneous mass of granular pyrite, containing 38% iron, 2.5% zinc, 3.5% copper, 0.12 oz. gold and 1.2 oz. silver per ton. Mr. Stickney has made clear the changes occurring between the outcrop and the primary sulphide ore, and emphasizes the relation of these to the level of groundwater. The gossan ends just short of this level and the primary sulphides do not appear until 25 to 95 feet lower. A remarkable feature is the baritic sand, consisting of loose grains of barite and quartz, stained by limonite; this sand has been leached of its copper, zinc, sulphur, and nearly all its iron, and forms a zone between the true gossan and the loose impoverished sulphides capping the primary ore. These impoverished sulphides appear as an incoherent aggregate of pyritic grains, with grains of barite and quartz, increasing in richness with copper in the approach to the primary ore. It is noteworthy that the impoverished sulphides persist slightly deeper along the walls of the lode than in the medial portion of the orebodies. In the unaltered ore the massive pyrite near the walls of the lode carries most copper, zinc, gold, and silver; and the longitudinal extremities of the orebodies likewise show a concentration of valuable contents. All of these observations are highly suggestive. The gold maintains a definite ratio to the barite and in this respect reminds us of the ore-shoots of pyritic copper in the Red Mountain district of Colorado. No defined zone of secondary-sulphide enrichment by descending water is evident. Apparently the rate of denudation caused the groundwater-level to be depressed so fast that the oxygenated surface-water was unable to create economically important secondary enrichments by dissolving at a higher level and precipitating at a lower level; instead, the copper sulphate became diffused in the body of groundwater and into the relatively permeable wall-rock enclosing the lode. Such secondary enrichments as Mr. Stickney records have the form of veinlets and film-like coatings of sooty chalcocite and covellite. These, however, are significant by their insignificance. We commend this study of Kyshtim to mining engineers as the work of a careful observer. We are reminded thereby of the paper by Mr. A. M. Finlayson in the June 1910 issue of *Economic Geology* and of the second paper by the same author in the transactions of the Institution of Mining and Metallurgy. In both of these papers Mr. Finlayson described the significance of secondary enrichment on the famous masses of pyrite in the Rio Tinto mines, in the province of Huelva, Spain. He showed that in this case the economic value of the orebodies was due directly to secondary processes, without which the pyrite would have been too poor in copper to be mined for that

metal. The primary ore contains only $1\frac{1}{2}\%$, while the average content of that being exploited in 1910 was 2.26%. There appears to be no doubt that the thin zone of enrichment immediately under the gossan was the object of the mining operations conducted by the Romans. In one of the ancient stopes there was found a deposit, about a foot thick, of iron ore overlying solid unaltered pyrite, indicating the rate of oxidation during the two thousand years that had elapsed since the pyrite had been stripped of its oxidized crust. As the workings at Rio Tinto are deepened the content of the secondary and of the primary ore decreases until the pyrite becomes valuable only as a source of sulphur. Another interesting example is afforded by the gossan outcrops of cuprif-erous pyrite in the Urals, described by Mr. H. W. Turner in the *Mining Magazine* of November 1912. Mr. Turner shows how limonite outcrops, mined in the first instance as a source of iron ore, were then exploited for their gold, by cyanidation of the silicious ironstone, and finally were proved in depth to be chiefly valuable for their copper. At Kyshtim, as at Rio Tinto, the paragenesis of the sulphides, that is, their order of original deposition, was pyrite, chalcopyrite, blende, and galena, exhibiting a sequence that has been proved in the laboratory to follow their relative solubility. The distribution of the ore and the shape of the orebody have been determined by the nature of the fracture along which the mineral solutions have circulated and the permeability of the wall-rock. The leaching of the latter has enlarged the orebody, sometimes to a lowering of its average contents, but apparently aiding the deposition of the precious metals, with quartz. In these mines, when once well opened to the drainage from surface, the presence of copper in the mine-water to the extent of economic value, as at Kalata, and as at Butte, suggests a process complementary to that by which they were formed, just as the acid-leaching methods simulate other natural reactions. Nevertheless there remains a curious discrepancy between the formulae of the metallurgist and those of the economic geologist, proving that there are many dark places yet to be illumined in this branch of geology.

Anaconda

In this issue we publish another of the series of articles by Professor Austin on the Washoe reduction works of the Anaconda Copper Mining Company. All Americans are proud of this plant as an expression of commercial enterprise and metallurgical progressiveness. Assuredly the editor of a technical periodical is apt to say kind things about it, not only because they would be true but because the management has been singularly generous in giving information useful to the profession, while, of course, always reserving the right to withhold details such as it may be undesirable, for business reasons, to publish. These necessary reservations, however, have not served to impose any serious embargo on knowledge. In consequence, a great deal of suggestive and instructive technical information has been forth-

coming, from time to time, from this great metallurgical centre. The goodwill manifested has been further emphasized by the personal courtesy and mental hospitality accorded to properly accredited visitors. Metallurgical students and teachers—for the latter must also be the former—who have visited Montana, whether from New York or London, Berlin or Tokio, will have grateful memories of their visits to Anaconda, as the establishment above all others where they were permitted to enrich themselves by collecting up-to-date information on the concentration and smelting of copper ores. We envy Mr. E. P. Mathewson, the resident manager, the friends he must have made in many countries during the 14 years of his association with the Washoe works.

In 1915 the Anaconda smelter turned out 254,800,000 pounds, equal to 127,400 short tons of blister copper, say, about 126,300 tons of refined copper, from the treatment of $4\frac{1}{4}$ million tons of ore. This output compares with 225,400,000 pounds in 1914 and 272,300,000 pounds in 1913. The year just ended was important to the Anaconda because in 1915 this company succeeded to the assets of the Amalgamated Copper Company, and thereby took first rank among the industrial enterprises of North America. During the same period the company also extended its operations outside the United States in the form of exploratory work in Chile, under the name of the Andes Exploration Company, which is reported to have opened up 75,000,000 tons of copper ore in the Potrerillos mine. Previously, in 1906, the Anaconda company had acquired a large interest in the Greene Cananea copper mines, which are just over the American border in the Mexican state of Sonora. Another important feature of 1915 was the beginning of a large zinc reduction plant at Great Falls, where operations involving leaching and electrolytic precipitation are to be conducted on a scale of 6,000,000 pounds monthly, equal to 35,000 tons of spelter per annum. This plant is expected to cost \$2,000,000 and to be completed by September next.

The descriptive articles of Professor Austin indicate three principal lines of development. The first is the burning of coal-dust in reverberatory furnaces, accompanied by longitudinal charging. For this purpose the coal is dried to less than 1% moisture and then finely pulverized by rolls, before being passed to a burner susceptible of delicate adjustment and control. At the burner it is mixed with the proportion of air required to effect efficient combustion, resulting in a high temperature at the point where it is most needed. The burning of this kind of fuel resembles that of producer-gas. With the introduction of coal-dust as a fuel the blast-furnace, in which department Anaconda has done wonders, has been superseded by the reverberatory. The old furnaces of this type have been enlarged and remodeled to enormous dimensions, being now 23 by 143 feet inside, and from $8\frac{1}{4}$ feet high at the back to $5\frac{1}{2}$ feet high at the skimming-end, giving a capacity of 700 tons per day when burning 100 tons of coal-dust. Longitudinal hoppers permit of banking the charge and ex-

posing a minimum surface to the action of the hot gases, while protecting the walls of the furnace from corrosive action. Formerly the furnace would smelt $1\frac{1}{2}$ tons of ore per ton of lump coal; now it treats as much as $7\frac{1}{2}$ tons per ton of coal-dust. This enlargement of capacity has met the need created by the making of a continually increasing quantity of fine concentrate, due to the success of the flotation process. So long as the smelting was done in the blast-furnace, it was obvious that the adoption of flotation would yield an unsuitable product, which had to be sintered, agglomerated, or briquetted in order to render it fit for the passage of the draft essential to blast-furnace smelting. Undoubtedly the extending use of flotation and the consequent production of a steadily increasing proportion of fine-grained concentrate will have a powerful effect on the development of smelting, as has been anticipated apparently by the wide-awake staff at Anaconda.

In regard to flotation, the first experiments with this process at Anaconda were made in 1913 and the first trial plant was erected in 1914. At the present time 11,100 tons of copper ore is being treated daily by flotation, and within a month an additional 1000 tons of dump-slime will be treated, besides 300 tons of slime at Great Falls. This refers to copper ore only; to it must be added the zinc ore being subjected to flotation. Of this 100 tons is being treated and a concentrator to treat 2000 tons more is being erected, so that the grand total undergoing flotation treatment will shortly be 14,400 tons daily. In our issue of August 28 we published an article by Mr. Mathewson himself describing the flotation equipment, and Mr. Austin in his second article gives further details, including a flow-sheet, which will be studied with keen interest. Formerly the tailing from the wet-concentration mill assayed about 0.62% copper; now the residue assays only 0.15%, that is, out of the 60 pounds of copper per ton of ore only 3 pounds goes to waste, as against 12.4 pounds formerly. The recovery by milling therefore is 95%.

The flotation concentrate is drained by Oliver filters before passing to the roasters, which have been developed from well-known types of furnace, the latest modification being the Wedge-McDougall, which combines the best features of two familiar designs. Each of the seven super-imposed hearths is 25 feet in diameter, these being rabbled by water-cooled arms radiating from a central shaft. From these furnaces the calcine goes to the reverberatories, fired by coal-dust, as already described.

Another salient feature is the zinc plant. Butte is becoming an important source of spelter, the Butte & Superior Copper Company being one of the leading zinc producers of the country despite its name, which now merely records the metal it was originally intended to exploit. Anaconda is up to date in this respect also, that is, the Washoe works provide for the treatment of zinc ore. At present only 100 tons of such ore is being treated daily, but a flotation concentrator to treat 2000 tons daily is being erected. The original small unit was started for experimental purposes, to discover a prac-

tical method of extracting the zinc from the concentrate, by leaching and electrolytic precipitation. This has been successfully elaborated by Messrs. Laist and Frick, as mentioned in our issue of December 25. Gentle roasting of the zinc ore is followed by leaching with dilute sulphuric acid, made on the premises. Impurities in the resulting solution are eliminated by precipitating the iron by means of limestone, and doing the same to the copper and cadmium by means of zinc. The purified solution of zinc sulphate is electrolyzed, using insoluble lead for the anode and either aluminum or starting sheets of zinc—stripped from deposition on aluminum—as the cathode. This experimental work, on a scale of 10 tons of zinc daily, has been so successful as to justify the erection of a big plant, on similar lines, at Great Falls, as already mentioned. Needless to say this new departure is of the greatest significance, for it means the discarding of the old distillation process of smelting zinc, with its small units in the shape of retorts and its relatively impure metallic product. Thus in the coal-dust firing of reverberatories, in the prompt recognition of the usefulness of the flotation process, and in the development of a wet method of zinc extraction, the Anaconda staff has shown all the initiative and resourcefulness that has given it honorable fame in the world of technology. It remains to add that normally 3200 men are employed, at a monthly pay-roll of \$400,000, to treat 16,000 tons of ore per day, the net recovery being about 90%. Besides the copper and zinc, the plant yields 12,000,000 ounces of silver and \$1,500,000 in gold as by-products.

What such metallurgical resourcefulness will accomplish is indicated further in the annual report of Mr. John D. Ryan, the president of the company. He states that by reason of the improvements made during the past year the company will be enabled to increase its annual production of copper by 55,000,000 pounds "without increasing the tonnage or grade of ore that has been mined in the past." We give this deeply significant and most interesting statement in Mr. Ryan's own words. Further he states that "approximately 40,000,000 pounds of this increased production will be made without adding to the cost per ton of ore treated." The more experienced metallurgists and engineers will appreciate with what proper pride such an assertion must be made. This 10 million pounds of copper is equivalent roughly to the annual output of such splendid mines as the Miami, the Braden, or the United Verde. The slight increase in the cost of concentration at Anaconda, due to the interposition of flotation in the general scheme of treatment, will be offset by a decrease in the cost of smelting, so that the additional yield of copper will be 'on velvet.' The amount of metal thus won will represent a profit that under previous conditions could have been secured only by increasing the tonnage mined by nearly 50%. This is a magnificent achievement. It gives us keen pleasure to record it, and to express the hope that good luck may be joined to skill in bringing the plans of the management to complete fruition.



DISCUSSION

Our readers are invited to use this department for the discussion of technical and other matters pertaining to mining and metallurgy. The Editor welcomes the expression of views contrary to his own, believing that careful criticism is more valuable than casual compliment.

Mill-Men's Mistakes

The Editor:

Sir—The mistakes of mill-men, when they occur, sometimes prove costly and should serve as a warning to others who might err in the same way. While I believe that not many mill-men would make the mistake I am about to record, yet there are a few who seem to believe in a liberal use of potassium cyanide in the ordinary free-gold amalgamation in a stamp-mill. To these the following incident may be useful and instructive:

I was once called to investigate a case where a 10-stamp mill was being run on free-gold ore, without any concentration after the plates. The ore assayed \$10 per ton, and the tailing around \$1, showing apparently a good percentage of saving, but the bullion won did not check this estimate by a considerable amount. It looked as though the mill-man was allowing some of it to stick to his fingers, yet the superintendent was loath to believe this, though he could not otherwise account for the discrepancy in the yield of bullion.

A friendly interview with the mill-man revealed the fact that he was using potassium cyanide in the mortar and on the apron-plates, apparently on the principle that if a little was good, more would be correspondingly better. In fact he was feeding it in the mortar in pieces as large as a man's two fingers every half-hour. As a result, he was cyaniding so much of the gold that his reputation for honesty was being dissolved as well as part of the gold. The latter, being in solution, escaped sampling of the tailing, and so the source of the loss had not been discovered.

We gathered all the cyanide in the mill, locked it up, and proceeded to demonstrate that the mill could be run without any at all, even as a wash for the plates. This seemed impossible to the mill-man, but when the bullion began materializing to the right amount, he was compelled to admit that it could be done. His reputation for honesty was also saved, which seemed to please him most. During the remainder of the season's run, the bullion continued to check all right; in fact, the superintendent stated that he had never known a case where it checked so closely with the assays, and it had been demonstrated that it could be done without the use of cyanide. In this case cyanide had proved an expensive method of keeping the plates bright and clean. As most mill-men know, and the rest should know, its continued use will make the plates so hard that they will not absorb and hold the mercury properly, to say nothing of the

solvent effect upon the gold and silver-plating on the plates as well. Some years ago I tested the results of its use, by dividing a plain copper apron-plate lengthwise, by means of a wooden strip, using cyanide solution for dressing one side of the plate, and none on the other side. The results, after a run of two weeks showed a marked difference. On the side on which cyanide was used, the copper oxide persisted in showing through the mercury, except for a small space near the head of the plate, and but little gold amalgam had formed as a permanent coating. The clean bright appearance of this side of the plate, after having been dressed with the cyanide solution, was soon followed by a reaction of copper oxide that seemed to have been intensified by the cyanide wash, when compared with the other side where none had been used. On this side, the plate was in better condition to hold the mercury, and it had gained a permanent coating of gold amalgam that kept the copper oxide down completely. It had actually saved more gold than the other side, where the cyanide had been used in moderate quantity.

San Francisco, January 31.

W. H. WASHBURN.

Mine Accidents

The Editor:

Sir—In your issue of November 27 I note a letter on 'Mine Accidents.' We have been much interested in this phase of the subject from this angle: Are there any accidents in the mines due to a not-understanding of the orders given? We have quite a number of men working in the mines who cannot speak or readily understand the English language. Does an accident ever occur because the miner did not understand the order given by captain or shift-boss because he (the miner) does not know English? If so, can you give me an idea as to the percentage of such accidents?

Gwinn, Michigan, January 6.

S. ADLER.

The Editor:

Sir—There are no statistics that precisely emphasize the occurrence of accidents in mines, due to a misunderstanding of the orders given. In the nature of the case, it would seem that if orders serve any purpose at all they must be understood by those who are expected to perform the specific functions regarding which they have been issued. If that were not the case it would obviously be useless to publish and disseminate definite instructions regarding conformity to precisely defined rules

and regulations. There are no conclusive statistics, however, as far as I know, concerning this matter. Coroners' inquests are notoriously superficial and the details are rarely made public. It would require an extended study of the available information to make answer to your inquiry by reference to specific instances of accidents due to ignorance of rules or misunderstanding of orders, chiefly on account of the employee's inability to readily understand the English language. It is not necessary, however, that the employee should be able to fluently converse in English. It is, however, absolutely essential that he should understand in English the usual short orders or definite directions which apply to his own safety and the safeguarding of the mine. Some experiments have been made to develop a concise teaching plan of English, having reference chiefly to the work done and the rules and regulations to be obeyed. Discipline cannot be enforced where there is ignorance of rules and regulations based upon past experience and an intelligent understanding of inherent hazards and safety requirements.

Newark, N. J., January 23.

F. L. HOFFMAN.

Employer and Employee

The Editor:

Sir—In your issue for January 8 you publish an address by John P. Irish on 'The Relation of Employer and Employee.' After reading the address one has the impression that nearly every word of it is true. If you are an employer you sense a halo hovering above your head and remark: "That man knows what he's talking about." If you are a union man you frown, "All very true, but there's something wrong somewhere."

The trouble lies in the fact that Mr. Irish cited a single instance of abuse by unionism and let that stand before his audience as a true example of all organized labor as practised at the present time. He carefully refrains from citing any examples where the employer has abused his power over his employees, although if he read the reports of the California State Labor Commission he would find many. Probably it is to such oversights that he owes his present success?

The speaker was somewhat premature in his statement that unions cannot be reached by process of law. The Wilkes-Barre, Pa., railway is even now suing the union of its employees for \$200,000 for damages caused by 'picketing,' the Clayton Act notwithstanding.

It is true that many abuses are perpetrated in the name of organized labor. But are they made better by spreading the impression that all unions are bad? Only bitterness on the one hand and intolerance on the other result from such propaganda. Would it not be far better in speaking of the abuses by unions to mention also some of their good features? Ask any union man who has been sick and unable to support his family for a time, and he will tell you how his 'local' kept his family and himself. Or, if the treasury happened to be depleted, how his fellow-members dug down into their scantily-filled pockets and kept him going until able to work.

It is also true that those who are in power in the various labor organizations often abuse the power invested in them, and for which the organization is more or less rightly blamed. The members are usually aware of the harm done them by their officers, but because they are busy making a living, the changes for the better come slowly and are not generally noticed.

An instance of distrust of union officials may be cited of the Western Federation of Miners. In November 1915, the striking miners at Morenci and Clifton sent out an appeal for help to the 'locals' of the Western Federation. Nearly every 'local' gave generous response. In December the officers of the Federation sent out a resolution to assess every member two dollars to help the same strikers. The resolution was voted down by the 'locals,' because the money was to be handled by the head office, instead of going direct to the strikers. Such a condition cannot exist for long, and a change in this union is already overdue.

A man of Mr. Irish's long experience must certainly know that the responsibility for the controversy between employers and organized labor does not lie wholly with the unions, any more than it does with the employers. Both sides must make concessions and a feeling of mutual understanding cultivated. Since the employer usually has the higher education and broader understanding, this spirit must start from the office. Mutual understanding will be easiest attained by making the employee feel that he has an interest in the firm. Each firm should have a minimum wage—for an employee has no capital or credit to fall back on in time of a non-living wage—and the employer should voluntarily raise wages in proportion to a rise in profits. The sliding-scale system of wages, as used in many American metal mines, is a step in the right direction.

Once the employees attain confidence in the square-dealing of their employer, the unions will exist only as recreation clubs and the walking delegate will die of starvation.

Skidoo, Cal., January 18.

A UNION MAN.

Shrinkage Stopping

The Editor:

Sir—I observe that Professor Sperr credits F. Percy Rolfe with having first employed the term 'shrinkage stopping' to designate overhand stopping, or back-stopping on broken ore, in a paper presented to the Institution of Mining and Metallurgy and published in Bulletin 55, February 11, 1909.

I am of the opinion that this term originated in Western Australia; you will find the term used and the method of working described in a series of articles entitled, 'West Australian Mining Practice,' by E. Davenport Cleland, and published in the Monthly Journal of the Chamber of Mines of Western Australia, February 29, 1908, and in the issue of March 31, 1908, in which latter the method is described at length.

Berkeley, February 19.

W. H. STORMS.

Mining in Arizona

By Charles F. Willis

THE chief event has been the settlement of the Clifton-Morenci strike. This strike of 5000 employees, of whom 75% were Mexicans, caused a loss in production of 30,000,000 lb. copper. The main contention was the recognition of the Western Federation of Miners. It was evident that the companies had determined to fight to a finish; fortunately both sides feel that they have won. The high price of copper allows the companies to pay higher wages, which, however, are not greater than they would have been had the men continued work. Much dissatisfaction among the strikers ensued from the losing of this benefit of high copper. They agreed to give up the Western Federation of Miners, although retaining affiliation with the State organization, and returned to work for a period of 15 days, during which time conferences were to be held relative to their grievances. No concessions were made by the companies previous to the men returning to work.

A very few days after the opening of the mines two non-union workers were threatened by union men if they did not secure union cards. This was reported to the company and caused the discharge of the union men, which precipitated a walk-out at the Detroit Copper mines. The fact that this lasted but 24 hours is in itself evidence of the fact that disagreements will be settled by conference. During the time of the strike, the companies maintained what was known as the 'refuge camp' at Duncan, 40 miles from the strike zone, where faithful employees were housed and fed, awaiting the return to work. As negotiations for the settlement of the strike neared an end, one of the principal pleas seemed to be that the 'refugees' be not allowed to return in a body, as it was evident that the strikers did not wish to feel the humiliation. While the companies have undoubtedly gained more points in the strike than the employees, it will probably mean better conditions and a better understanding between employers and employees in the Clifton district.

The general rise in the scale of wages broke all records for Arizona mining, when, with 25-cent copper, the larger companies announced \$4.85 per day for shovelers and \$5.10 for miners. This was followed by an announcement by Phelps, Dodge & Co. of a general increase of 10% at all their mines.

Interest has been created by the Arizona Venture Corporation's shipment of the so-called wireless-crystals of 'lenzite' to England, from its Waldron mine in the Cedar Valley district, 56 miles south-east of Kingman. This shipment of 400 crystals packed in an ordinary match-box was reported to be valued at \$4000. These crystals are said to be superior to any previously used

by the British government in its wireless telegraph stations. 'Lenzite' is reported to be an intimate mixture of molybdenite, zincite, stibnite, and other minerals, in such proportion as to make good wireless cohera.

According to the Arizona State Bureau of Mines it is not very generally known that within the boundaries of the State are some of the largest and richest gold placers in the country. The early prospector discovered them, and worked the richest spots with his pan and rocker. Considerable sums of money have been spent

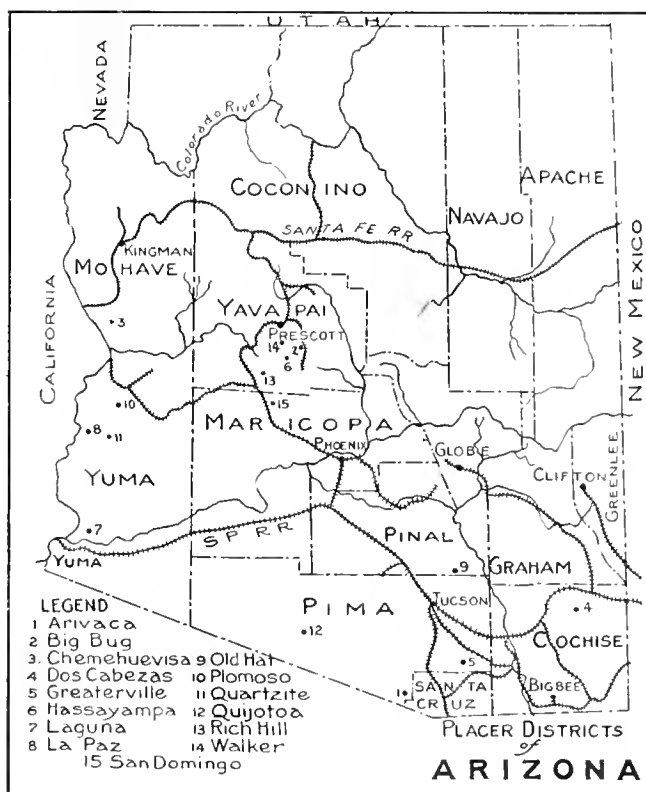

in attempts to develop certain deposits, but through various causes few of these ventures have been profitable. In the exploitation of placer ground the question of an easily available supply of water is important; it is pre-eminently the great problem in the development of Arizona placers where there is so little rainfall and so few permanent streams.

In 1915 the Copper Queen had one of its largest outputs, despite the fact that during the first few months of the year production was reduced approximately one-third. This was due to the company's inability to recover its stride after the curtailing of production in 1914. In addition, the company produced the largest tonnage of lead ore in its history. A notable change at the Copper Queen is the decrease of oxidized ore and an increase in sulphides. This necessitates changes in the

smelter. Seven McDougall roasters have been added, and experiments in pyritic smelting are being conducted in an effort to take care of the excessive sulphide. Development for the year included 44,637 ft. of drifts and 25,376 ft. of raises, a total of 70,013 ft. No large ore bodies were discovered, but continuations of known deposits were continuously uncovered. Churn drilling on Sacramento hill has added several million tons of porphyry ore. The output of copper by the Copper Queen and the Calumet & Arizona smelters in Douglas for January amounted to 20,000,000 lb. The Copper Queen produced 12,000,000 lb., an increase over the month previous, while the Calumet & Arizona produced 8,000,000 lb., the same as for December. In this total is included ores received by the Copper Queen from its own mines, the concentrate from the Moctezuma Copper company at Nacozari, Mexico, and custom ores. The output from the C. & A. includes custom ores and the ore from the Shattuck mine.

Increased prosperity is indicated in the gift by the mining companies to the University of Arizona of \$100,000, to be applied with the \$75,000 appropriated by the legislature for the erection of the Mining Engineering building. The contributions were apportioned according to the annual production of the companies.

After two years of exploration and the spending of \$200,000 for development, Young Bros. of the Great Western Copper Co., who have been exploring the Mammoth-Collins gold mine at Schultz, have decided to quit. While much ore was found, it is understood to be too poor to justify milling. The Old Mammoth mine has been known not alone for its gold, but for its excellent specimens of wulfenite. Lessees on the dumps at the Old Mammoth mill have been supplying a large proportion of the wulfenite produced in the United States for two years. It is reported that a representative of the United States Smelting & Refining Co. has been investigating the Mammoth properties.

Oatman is much alive, and now that the proposed merger of the Tom Reed and the United Eastern has definitely failed, the United Eastern will erect a mill with an initial capacity of 200 tons of ore daily, to be the first unit of a larger plant. The Big Jim encountered much water below the 400-ft. level, and, pending the installation of a pumping plant, a drift was run in the foot-wall of the vein recently cut, showing 46 ft. of good ore.

Some interest is being directed to Yavapai county because of its adequate railroad facilities, and mines that made history in the day of Geronimo are being reopened.

The Tucsou, Gila Bend & Cornelia railroad is now completed to the Ajo mine of the Calumet & Arizona Co., and train service was started on February 20. This will mean the rapid construction of the 4000-ton leaching-plant to produce commercial electrolytic copper directly. Experiments made during the last two years have evolved the "Greenway" process of leaching and precipitation for low-grade copper ore.

Tombstone, which has a history typical of the early days of the West, is again active. In 1878 a detachment of United States soldiers were marching from Wickenburg to Fort Huachuca, accompanied by a prospector named Ed. Shieffelin. While crossing the San Pedro valley, Shieffelin took his burros and went into the hills to the east. By day he hid from the Apaches and by night he prospected. Returning to Globe, he showed his samples to a brother and a partner, and they secured a grub-stake. Shieffelin was told of his recklessness in going into the Apache country, and was warned that he would find a tombstone rather than a mine. He did both. In the 80's a heavy influx of water drove the miners from the workings, and for seven years the owners made efforts to develop the properties on an adequate scale. Later most of the larger mines were acquired by the Tombstone Consolidated Copper Co. The early work of this company, a subsidiary of the Development Company of America, was highly profitable, and for many years Tombstone was the big camp of the territory. The Development Co. supplied nearly \$2,500,000 to its Tombstone subsidiary in addition to funds realized by the sale of bonds before it came to the end of its resources. Then, with \$1,670,000 of its notes protested, and water again in command of the situation, the collateral security for these notes was sold at auction. This caused the downfall of the Development Company of America. Years of litigation ensued and the town of Tombstone, with its wide streets, large business-houses, and neat residences, declined to a population of a few hundred. Finally the mines were offered at bankruptcy sale. On June 23, 1914, when the trustee, Col. A. L. Grow, asked for bids on the property, a profound silence prevailed until in the midst of the large crowd a voice called out, "I bid \$500,000." This was Walter Douglas, of the Phelps-Dodge interests, to whom the property was sold. Work was started by Phelps, Dodge & Co. in July 1914. Prospecting proceeded in the upper levels, houses were built, and pumping machinery installed. Dr. Emil Grebe was put in charge; he had been associated with the geological and engineering division of the Copper Queen for years. His slogan seems to be 'Make haste slowly,' for the work is going on consistently and with a constantly increasing number of employees. Four hundred men are now employed, and ore valued at \$4 per ton is to be treated. Tombstone has come back.

The chief sources of accidents in Rand mines in 1914 were as follows:

| | Separate accidents. | Persons Killed. | Persons Injured. |
|-----------------------------|---------------------|-----------------|------------------|
| Explosives | 188 | 146 | 167 |
| Falls of rock | 451 | 204 | 371 |
| Traveling in shafts | 61 | 38 | 27 |
| Machinery | 114 | 19 | 95 |
| Various (surface) | 193 | 27 | 168 |
| Various (underground) | 982 | 174 | 887 |
| Total | 1989 | 608 | 1715 |

Gold-Milling in Amador, California

By Edward B. Durham*

INTRODUCTORY. The usual milling process along the Mother Lode in Amador county, briefly stated, is

(1) to screen the run-of-mine ore on grizzlies at the head-frame; (2) reduce the coarse ore in a jaw or gyratory crusher; (3) tram the fine from the grizzlies and the product from the crusher to the mill-bins; (4) feed the mixed crushed and fine ore to stamp-batteries, where it is crushed to pass a screen of about 20-mesh (mercury is usually added in the mortar to amalgamate the free gold, but no inside plates are used); (5) pass the

of San Francisco. I found the plant operating practically as he described it.

A gyratory crusher at the shaft takes the run-of-mine ore, coarse-crushes it and delivers it to a series of belt-conveyors which deposit it in the mill-bins; from these it goes to 30 stamps and is crushed through a coarse screen at the rate of 300 to 350 tons per day. The stamp product is split by cone classifiers, the coarse is ground in two Hardinge mills and, uniting with the overflow of the cone-classifiers, passes over amalgamating

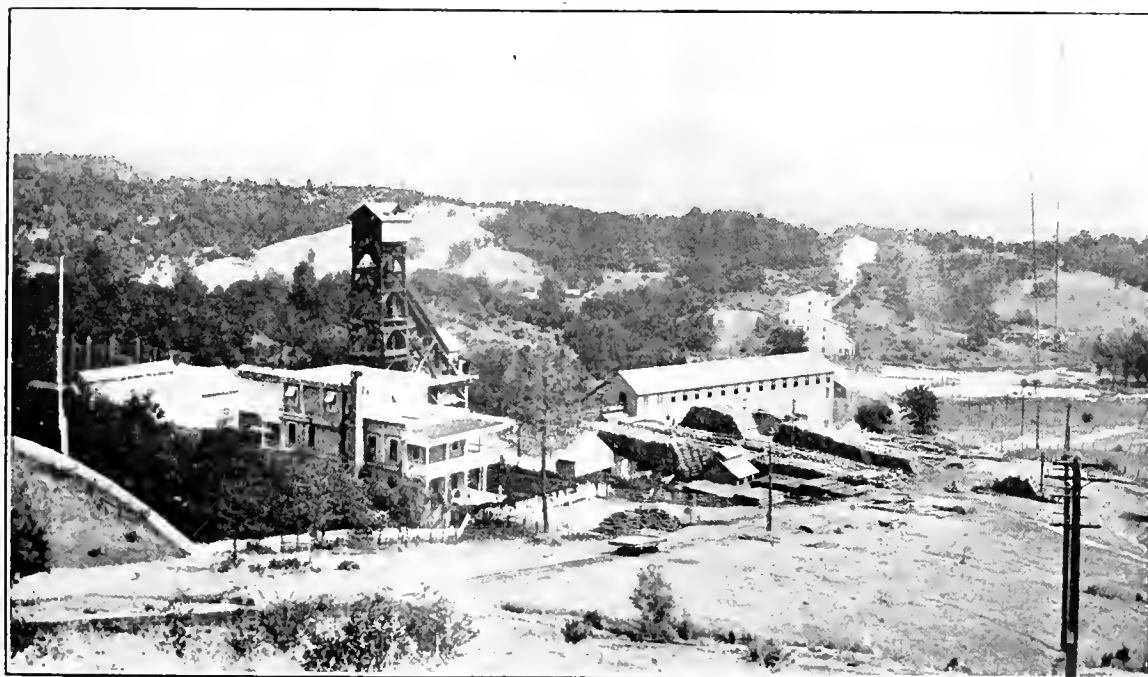

THE KENNEDY SHAFT, 100-STAMP MILL, AND TAILING-DISPOSAL PLANT.

pulp over outside amalgamating plates, which catch the amalgam discharged from the battery and any possible free gold; (6) concentrate the sulphides on vanners; (7) sack and ship the concentrate to smelters.

A review of the 'Metallurgy of the California Mother Lode' was given by M. W. von Bernewitz in the *MINING AND SCIENTIFIC PRESS* of January 3, 1914, covering the process in use at that time at each mill. The present article covers the changes that have occurred since Mr. von Bernewitz wrote. E. S. Pettis has also written on this subject in the issue of September 18, 1915.

THE PLYMOUTH CONSOLIDATED, five miles north of Amador City, is operating the northernmost active mine on the Mother Lode in Amador county. A new mill was erected during 1914 and was described in the *PRESS* of October 31, 1914, by the designer, Gelasio Caetani

plates. The pulp is then classified, the overflow is treated on 30 vanners and the bottom product is concentrated on two Wilfley tables and their middlings are returned to the Hardinge mills to be re-ground. Mr. Caetani gave a flow-sheet and a detail discussion of the operations in his paper.

The characteristic features of the plant are: (1) the use of the belt-conveyors to carry the crushed ore from the shaft to the mill; elsewhere in this district the ore is moved in cars by man or by mule power; (2) the use of stamps as an intermediate crusher to prepare the ore for the Hardinge mills and the omission of amalgamation in the batteries; (3) the use of classifiers to remove the coarse sand and deliver a uniform pulp to the vanners. The concentrate is shoveled from the boxes at the vanners into an iron car. At the sacking-room, the concentrate is settled in this car by running it over

*Mining engineer, 2227 Ward St., Berkeley, California.

an air hammer stoping drill, standing vertically in a pit between the rails and arranged to hammer against the heavy plate on the bottom of the car. The tattoo settles the concentrate and causes the water to rise to the top, whence it is removed.

The FREMONT MINE, about two miles north of Amador City, is the next mine south of Plymouth. The milling follows the usual practice of the district, but the tailing from the vanners is re-treated in a separate plant operated by W. E. Darrow and P. T. Hambrie. The

are rigidly attached to the shaft and slope outward. The shaft with the attached pans revolves slowly; the pulp is fed to the pans during a half-revolution; the sand collecting on their surface is washed with clean water during a quarter-revolution, and the concentrate is washed off during the remainder of the revolution. The tailing and the concentrate fall on a cement floor, which is so sloped that each runs to appropriate channels. The pans on the first pair of machines are covered with asphalt roofing-paper, which is painted and sanded; those on the second pair of machines are covered with felt, which catches the coarse sand that escapes the trays on the first machines. The mill-tailing is said to carry gold amounting to about 50 cents per ton and the concentration system builds this up to \$5 to \$10 per ton. The gold is extracted by cyanidation.

THE BUNKER HILL CONSOLIDATED is working less than a mile north of Amador City. The milling is in accord with local practice. The tailing from the mill goes to a re-treating plant, run by Mr. Darrow, at which the process is said to be different from that used in treating the Fremont tailing; I did not visit it.

THE ORIGINAL AMADOR CONSOLIDATED is operating at Amador City. The old mill was described by Mr. von Bernewitz in the article previously mentioned, in which he noted that the mill was handling 90 tons of ore per day. The mill was re-modeled in the spring of 1915; the new process of milling was briefly described in the MINING AND SCIENTIFIC PRESS of June 19, 1915, and a complete description with flow-sheet was given by the superintendent, T. S. O'Brien, in the *Engineering and Mining Journal* of August 14, 1915.

The crushed ore is screened in four trommels with 2-in. openings; the oversize goes to 20 stamps, which discharge through 1/2 to 3/4-in. openings, depending on the hardness of the ore. (The fine screen is used with the harder ore so as not to overload the Hardinge mills which follow. The fine ore from the trommels and the discharge from the stamps is classified in two Dorr machines; the coarse sand goes to two Hardinge mills with amalgamating drums attached to their discharge; the ground pulp passes over amalgamating plates to two hydraulic classifiers with three spigots each; the product of each of the six spigots goes to a separate double-decked table made by the Deister Concentrator Co.; the various concentrates are passed over amalgamating plates, de-watered, and transferred to the cyanide plant for further treatment. The overflow from the two Dorr classifiers and from the two hydraulic classifiers below the Hardinge mills goes to a thickening-tank, the overflow of which is used for mill-water and the thick pulp passes to four double-decked Deister slime-tables and their concentrates are united with those from the other tables for cyanide treatment.

The advantage of using some other type of crusher than stamps for the intermediate crushing was apparent, and later I learned that the management proposed to do so. The cyanide plant is described in Mr. O'Brien's article but was not visited by me. The re-modeled mill

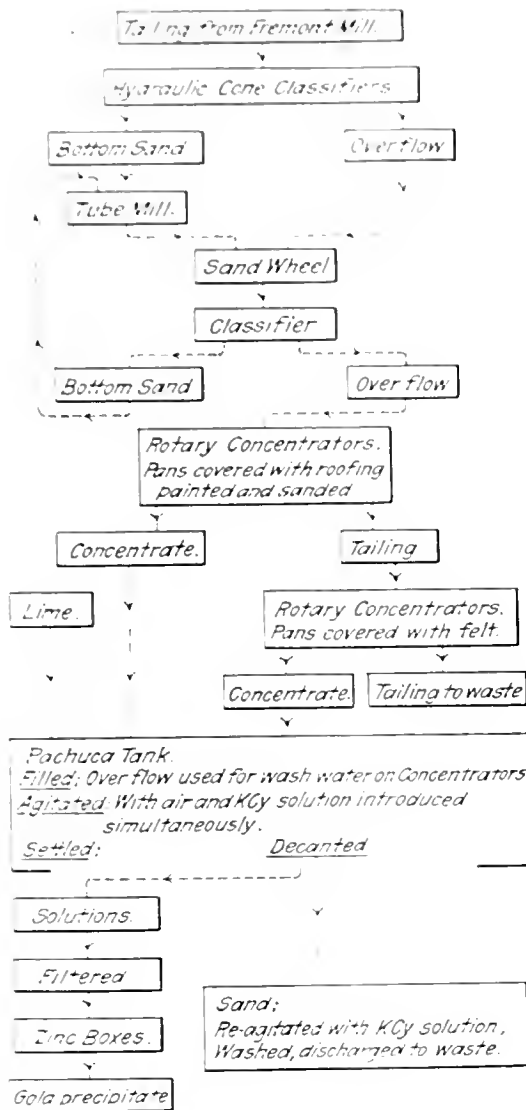

FIG. 1.

principle of their process is shown in the flow-sheet, Fig. 1.

The tube-mill for grinding the coarse portion of the tailing was being installed at the time of my visit and was not an active part of the process, the plant was running with the bottom product of a thickening cone going directly to the first pair of 'rotary' concentrators.

These concentrators consist of tiers of slightly inclined pans held by radial arms from a central shaft. The number of pans in one tier depends on the diameter of the machine, each machine having 10 tiers. The pans are approximately 2 ft. wide by 6 to 8 ft. long, they

is expected to handle 300 tons of ore per day. The 20 stamps are the same as in the old mill where only 90 tons of ore was crushed per day.

THE KEYSTONE MINE is also situated at Amador City. The run-of-mine ore is dumped on a grizzly; the under-size is treated at the 'old mill' by 20 light stamps; the oversize is crushed in a gyratory crusher and is treated in the 'new mill' by 20 heavy stamps. In both mills, the stamps are followed by amalgamation and the collection of the sulphides on vanners, as is usual in this district.

THE CENTRAL EUREKA is the next active mine to the south, along the Mother Lode. It is about midway between Sutter creek and Martell. The mill has 40 stamps and 16 vanners, but only half of the equipment is in use. The process is the one customary in this district. The tailing from the mill is carried across

is being used to raise water by means of two tanks working in balance; it is equipped with flat ropes. The mill is idle.

THE KENNEDY is over the hill to the south of the Oneida or about $\frac{3}{4}$ of a mile from Martell and near the road to Jackson. The mill is situated near the East shaft, which is the main opening. It has 100 stamps and the process is the usual one. The tailing is carried across the valley by a flume and then is raised by four sand-wheels in series until it passes over the ridge to a ravine to be impounded; see photograph. The wheels are each housed in a separate building; I estimated them to be 60 ft. in diameter and to have a net lift of about 45 ft. each. The canvas plant mentioned by Mr. von Bernewitz is idle and apparently abandoned. The sulphide concentrate from the vanners is chlorinated in a separate plant, as noted by Mr. von Bernewitz.



THE ARGONAUT MAIN SHAFT.

the main road in a flume on a high trestle and impounded in a ravine where it cannot get into the streams.

THE SOUTH EUREKA property lies a little farther south. The milling process is the usual one but the mill is divided into four units of 20 stamps each and their product goes to 12 Frue vanners (each battery supplying three vanners) and each unit of the mill is driven by a 50-hp. motor placed in a separate room back of the ore-bins. The arrangement of the driving machinery and the launders is unusually neat. The mill is well lighted with skylight, is roomy and orderly and presents a pleasing appearance. The tailing is conducted by a flume through the top of an adjacent hill and impounded in a ravine beyond.

THE ONEIDA MINE is situated a little east of Martell; it belongs to the South Eureka Mining Co. The workings of the two mines are connected. The Oneida hoist

THE ARGONAUT plant is distributed on both sides of the road leading from Martell to Jackson; see above. The milling process is the usual one, with rock-crushers, stamps, plates, and vanners. The tailing from the vanners is classified, the bottom sand goes to the pond, the overflow is concentrated on a Darrow rotary concentrator about 20 ft. in diameter. The concentrate from this is further concentrated on three vanners. The sulphides collected in this way from the mill-tailing are very fine and the amount appears to be small.

THE ZEILA MINE to the south-east of Jackson, idle for some time, is now being re-opened by the Kennedy Mining & Milling Company.

AMADOR COUNTY in 1914 had 23 mines producing 630,993 short tons of ore from which \$3,082,002 in gold was recovered, an average of \$4.87 per ton. Silver content averaged only 2½ cents per ton.

The Washoe Reduction Works, Anaconda—II

The Coarse Concentrator and Flotation Plant

By L. S. Austin

THE concentrator contains 8 units, each of 2000 tons daily capacity, in two buildings, with a power house between. The power house, with its engines and boilers, is no longer in operation, steam having been supplanted by electricity, so that individual motor-drives are common throughout the mill.

From the Anaconda classifiers down, the mill is being altered for flotation. Above, the system consists of graded crushing with jig concentration for the removal of coarse concentrates, and a tailing that is progressively crushed, no part of the tailing being wasted, but all of it finally re-crushed for flotation. In the process of concentrating of 2000 tons, 500 tons is removed as coarse concentrate, including all over $1\frac{1}{2}$ mm. and 400 tons overflow, leaving 1100 tons for re-crushing.

Beginning now with the second-class or run-of-mine ore; this comes by the train-load in hopper-bottom cars, just now at the rate of 13,000 tons daily. One car in ten is dropped into hopper-bottom bins at the sampling-mill, where it is crushed coarsely and raised by a big elevator to an overhead belt-conveyor, whence it joins the nine cars that have been directly distributed into the ore-supply bins as indicated on the flow-sheet, Fig. 2.

From the ore-bin a chute with regulating slide delivers onto the perforated feed-shoes, these taking out fine of less than 2-in. size, while a 12 by 24-in. Blake crusher breaks the coarse lumps. These go to 2-in. trommels, the oversize from which is crushed, and then passing over a trommel having inch-holes. This furnishes a product between 2 and 1 in. diameter for a couple of two-compartment Hartz jigs. These yield per day 20 tons of coarse concentrate, 665 tons of middling, and a fine-hutch product of .15 tons going to Hancock jigs in the 'Jig division.' It is the middling that chiefly concerns us; this, after passing over a dewatering screen, is crushed in 54 by 24-in. rolls to yield an undersize for the already mentioned 1-in. round-hole trommel. Here then we have a total product of 2520 tons (more than the original ore— all of which must be screened through four trommels having $\frac{3}{4}$ -in. holes. These trommels yield an oversize of 800 tons, being all between 1 in. and $\frac{3}{4}$ size, for the fine Hartz jigs and an undersize of 1720 tons now going to eight trommels having slotted holes of $1\frac{1}{2}$ by 12 mm. It is the 1020 tons oversize, namely, all between $\frac{3}{4}$ in. and $1\frac{1}{2}$ mm. that is treated on the Hancock jigs while the undersize, some 700 tons, goes to the Anaconda classifiers. The Hancock jigs give 185 tons of concentrate, a quantity of middling to be returned to the machine but principally a middling product of 1050 tons. This is dewatered and raised to trommels

having $1\frac{1}{2}$ by 12 mm. slots, yielding an undersize suited to the classifiers, and an oversize of no less than 2100 tons in weight, all of which must be crushed in the 54 by 24-in. rolls until fine enough to go to the classifiers.

Let us now go back to the fine Hartz jigs, which had taken a product 1 to $\frac{3}{4}$ inch in size. These jigs yield 45 tons of concentrate; 200 tons of a hutch-product sent to the Hancock jigs, and finally 550 tons of a middling, which, after dewatering, is crushed by 54 by 24-in. rolls, returned to the 1-in. round-hole trommel to travel through the system largely by way of the Hancock jigs.

Finally, at the classifiers, we note that the Wilfley tables, provided with Butchart riffles, remove what concentrate they can, some 250 tons that settles in the dewatering bins, situated, as may be seen on the general plan, immediately below and adjoining the concentrator, and where the other concentrates are unwatered and stored. It is the middling (really tailing) from these tables, some 1100 tons daily, that passes to the flotation system.

One may notice, by the rounded appearance of the coarse concentrate, that it has been subjected to much wear in the operations of crushing, elevating, and jigging. It is sad to think what would happen were the slime, consequent upon this wear, turned over to the tender mercies of water concentration. Oil flotation is indeed its guardian angel.

In 1906, I find by my notes that the output per section was 900 tons. As above stated, it has risen to 2000 tons. This is due in part to the speeding up of the machines, in part to the replacement of 42x15-in. rolls by those of 54x24-in. face.

The treatment of the sand from the Wilfley tables by flotation is described herewith.

SLIME TREATMENT AT THE ROUND-TABLE PLANT

The overflow from the Anaconda classifier in the middling division of the concentrator still retained 2 to 2.5% copper, but owing to its fineness (approximating 200-mesh) and to the accompanying colloids, it could not be practically treated by the water-concentration method then employed. Accordingly, in despair it was run to waste, being impounded in slime-ponds on the flat below the works for future possible recovery.

Of all the tables used in the treatment of slime the round table, in which the pulp is spread out in a film and then washed to remove its gangue, has been the most successful. But to treat the large quantity of slime made in this plant it was necessary to use a more compact machine than a single-deck or even a quadruple-deck table. This was accomplished by the use of the

INSTALLATION OF FINER GRINDING AND FLOTATION EQUIPMENT IN CONCENTRATOR
FLWSHEET FOR SECTIONS NO. 2-8.

Note: The following quantities of oil and acid will be added thru automatic feeders to the boat of the flotation Division feed elevator (N24): Sludge acid Kerosene 3lbs per ton of orig flat feed. Crude Wood Creosote 5lbs and 4 1/2 (50-84) 82lbs (The creosote may be added ahead of Hardings mills) To neutralize the free acid in the flotation Conct about 10lbs (total) cao per Sect must be added to Spig. Prod of 50' Conct dewatering tanks.

Original Ore (2000)
 Ore-Bin
 2" Rd hole Shaking Screen
 Oversize (100)
 12"x24" Blake Crusher
 2" Rd hole Trommel (3'x4')
 Oversize (900)
 8"x20" Blake Crusher
 Oversize (1100)
 2" Rd hole Trommel (3'x6')
 Oversize (900) [250,000]
 3" Trommel (3'x6')
 Undersize (2520) [765,000]

1) 12"x24" Blake Crusher
 2) 2" Rd hole Trommel (3'x4')
 3) 8"x20" Blake Crusher
 4) 2" Rd hole Trommel (3'x6')

5) Anaconda Classifiers (7'dia)
 Spigot (350) [378,000]
 6) Willey Tables Burchart-riffing
 Midd. (1100) [665,000]
 7) Elevators N23
 Hard. Mills (10'x4') (4400) [1,175,600]
 8) Simplex Dorr Classifiers
 Sand Discharge (3300) [2,900]
 9) Elevator N24
 M.S. Flat. Moch 15'x9' 14 Boxes (1841) [865,960]
 Boxes 4-9 [55,000]
 Rough Conct. (53) [2,180]
 10) Elevator N26
 Double Collow Cleaner Cells
 Middling (241) [402,960]
 11) Elevator N25 (381) [505,360]
 12) Dorr Tanks 50'x12'
 Spigot Product (157) [22,000]
 13) Conct Elevator N24
 Overflow Water [2,392]

Note
 Figures in parenthesis show Tons of Solid per 24 hours
 Figures in brackets show Gallons of Water per 24 hours
 Figures in circles show number of machines
 Data by A E Wiggins
 #Phoguer 5-8-15

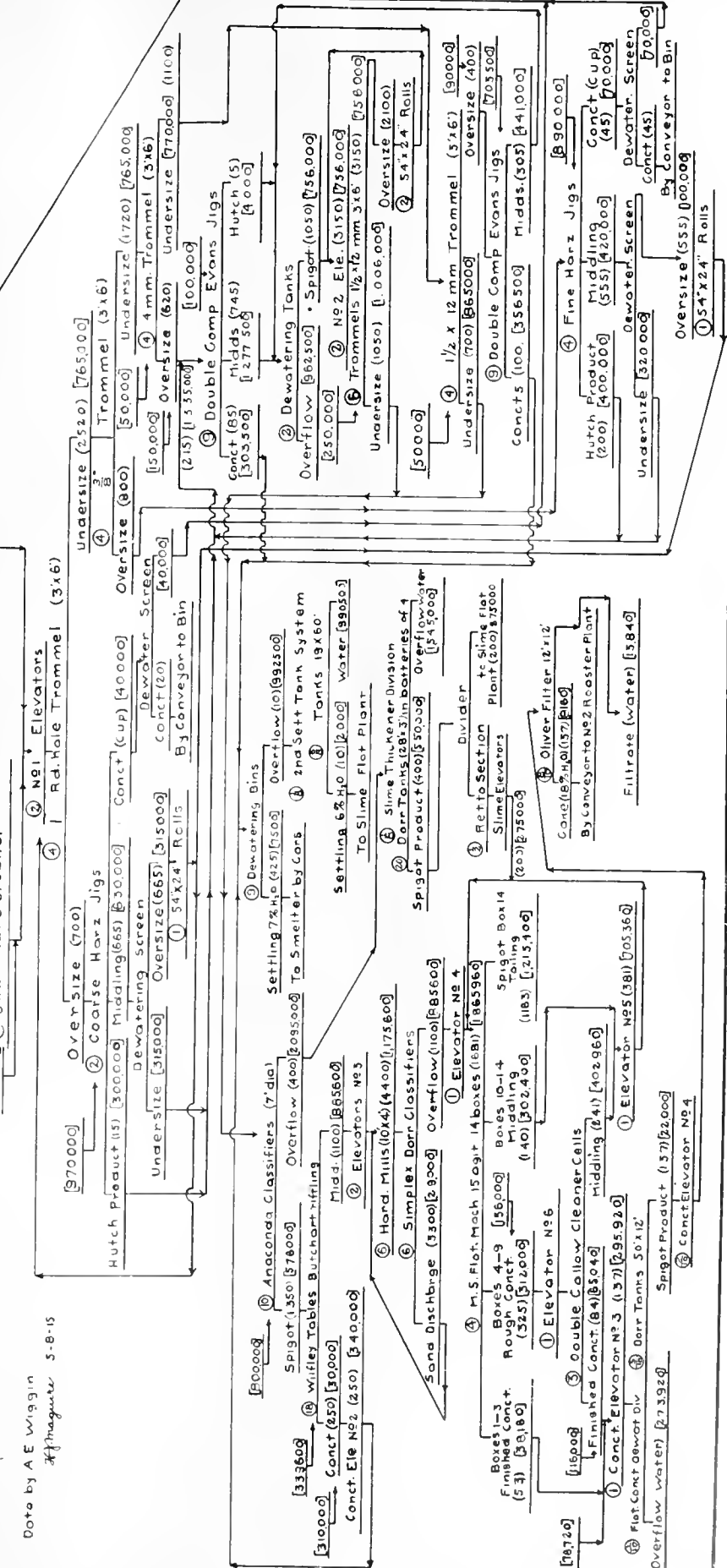

FIG. 2. FLOW-SHEET.

20-deck machines, the decks being 18 ft. diam. Here, in a moderate sized building, could be installed 20 of these machines or 400 decks in all, affording a treated area equal to two acres.

The overflow from the Anaconda classifiers has been thinned to 2% solids, due to the use of the hindered settling water, so that it must be thickened before treatment on the round tables. This is done at the Dorr thickener plant (see the general map, Fig. 1). The plant contains 160 thickener tanks, each 28 ft. diam. by 3 ft. high. To place so many tanks in a building of reasonable size it was necessary to pile them in tiers four high, each taking its share of the flow from all the mill and giving a thickened underflow of 10% solids suited to round-table work, while from the peripheral overflow launder the nearly clear water runs to waste.

Fig. 4 shows in elevation the round table building, 275 ft. by 57 ft. in area, which receives its feed from the Dorr thickener division. This, delivered to a revolving general distributor at the top of the building, is distributed equally to each of the 20 machines. A similar,

but smaller, distributor delivers equally to each of the 20 decks of each machine.

The patented distributor is quite simple and effective. It consists of a circular trough divided by 20 radial partitions, each partition taking off by pipe to one of the 20 machines. The whole launder flow to the plant discharges into the bent distributing pipe revolving on its axis and spilling into the cells of the annular trough as it revolves. Each 20-deck machine has a similar distributor, also shown in Fig. 5.

The 20-deck machine has no central shaft, but is carried by eight wheels that travel smoothly upon the circular track. Since no central shaft is needed, a central circular opening of 4 ft. diameter is left through each deck. Up and down through them the operator can easily move in order to inspect and regulate the flow of wash-water. The ladder is a square frame with transverse bars for steps and the 20 flows, as well as the clear water, are carried down to the individual decks just outside the ladder-frame. The space is also illuminated by electric light.

The products from the tables are three, each delivered

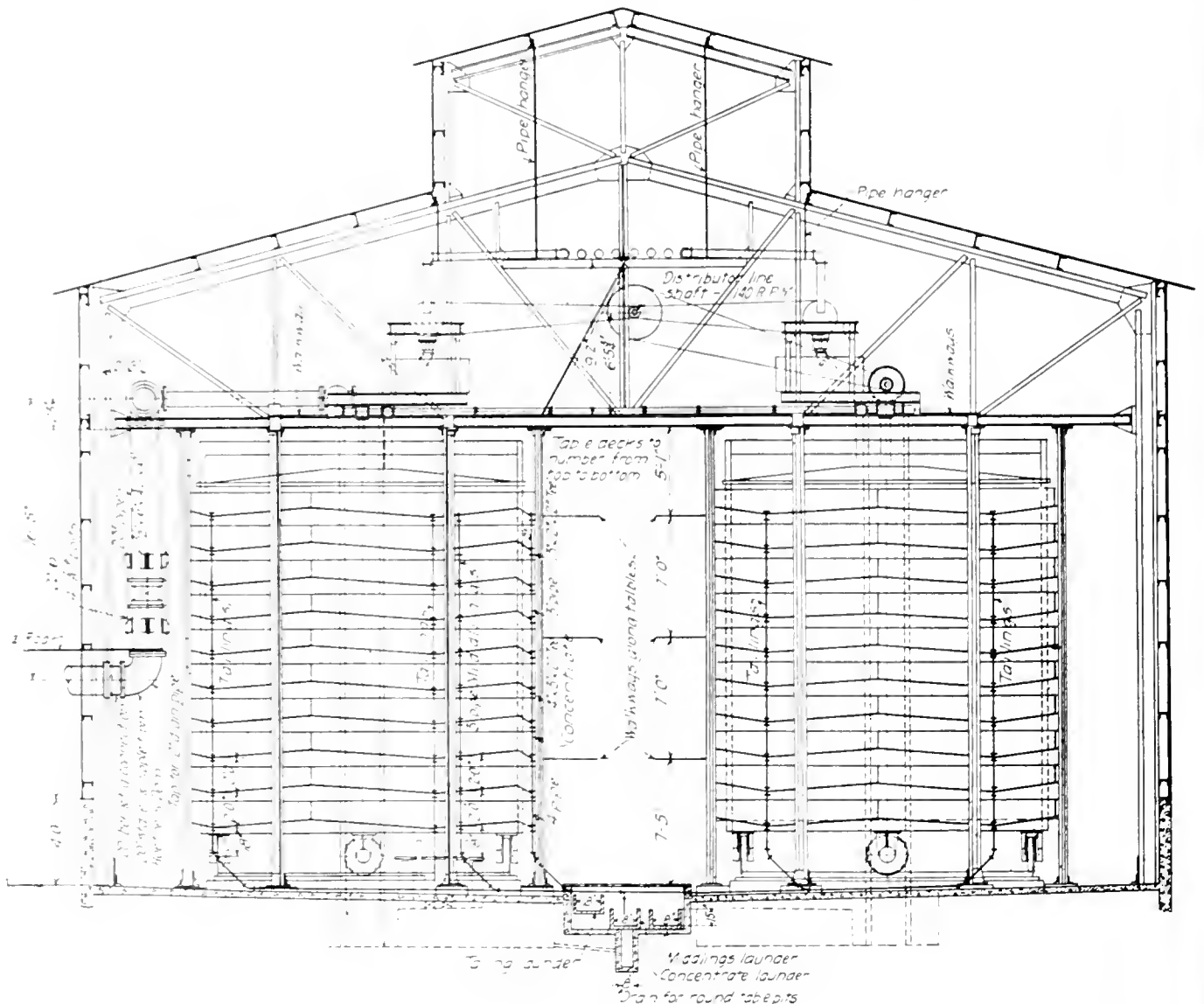

FIG. 4. ROUND-TABLE PLANT.

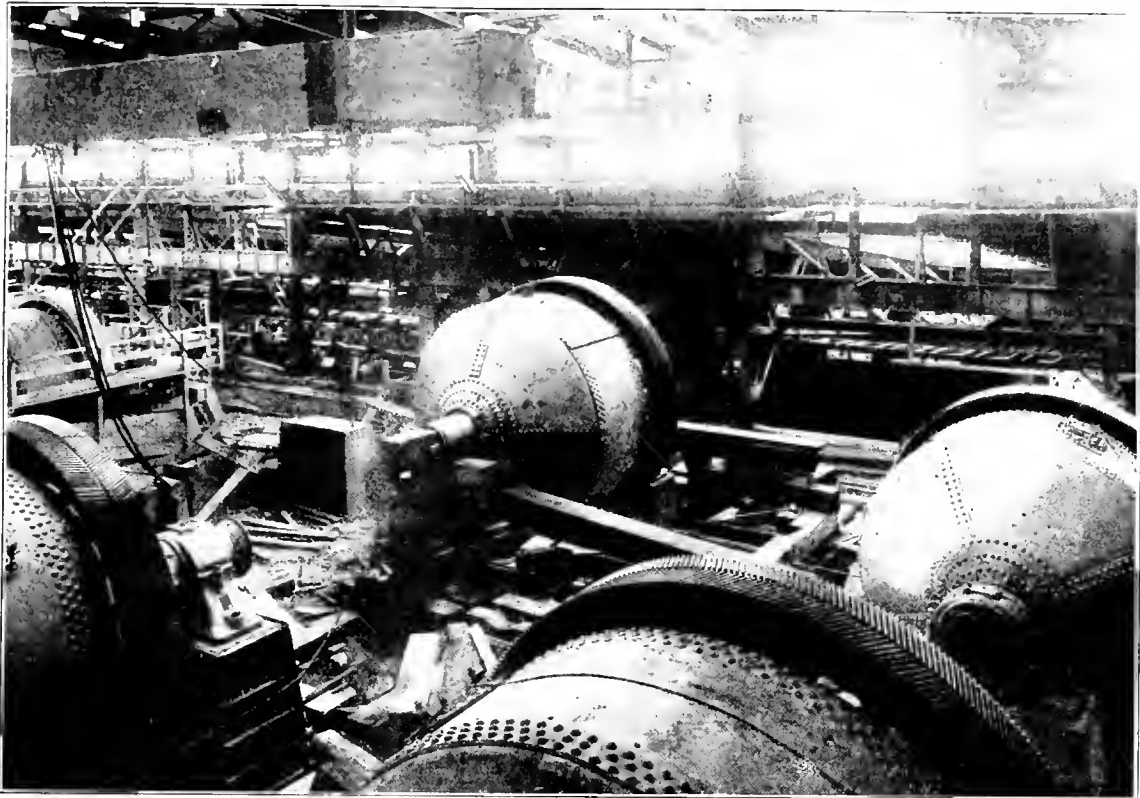

FIG. 6. HARBIDGE MILLS, RE-GRINDING DIVISION.

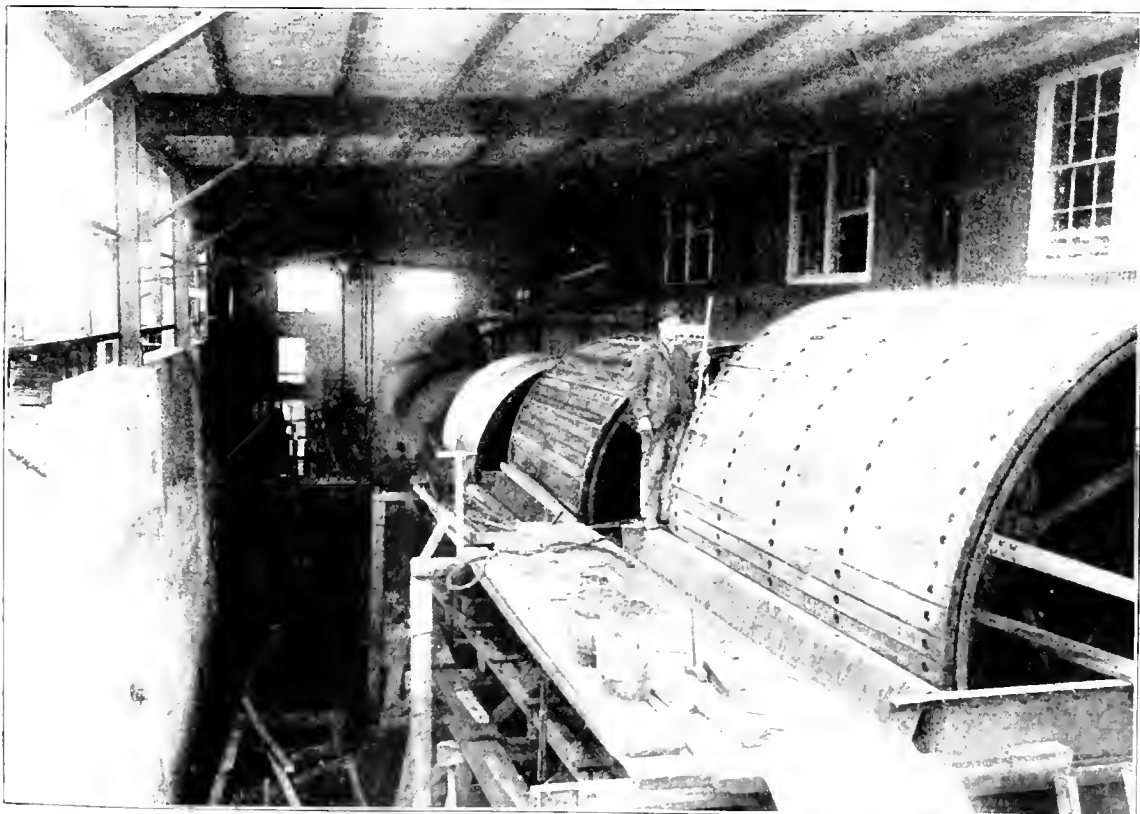

FIG. 7. OLIVER FILTERS. THE CANVAS FILTERCLOTH HAS NOT BEEN PUT ON THE NEAREST FILTER DRUM.

to its own launder, namely, concentrate, middling, and tailing. The concentrate is run outside the building to a settling tank, the middling product is pumped to the feed launder, the tailing descends by launder to the slime pond, where it is at present impounded in the hope that it may, some day, pay to re-treat by flotation. The heads or feed to the tables contain 2% copper, the concentrate 7.25% with 55% insoluble, the tailing 1% copper, equivalent to a recovery of 53%.

For particulars of the 20-deck round table, see paper by Messrs. Laist and Wiggin, Trans. A. I. M. E., Vol. XLIX, page 470.

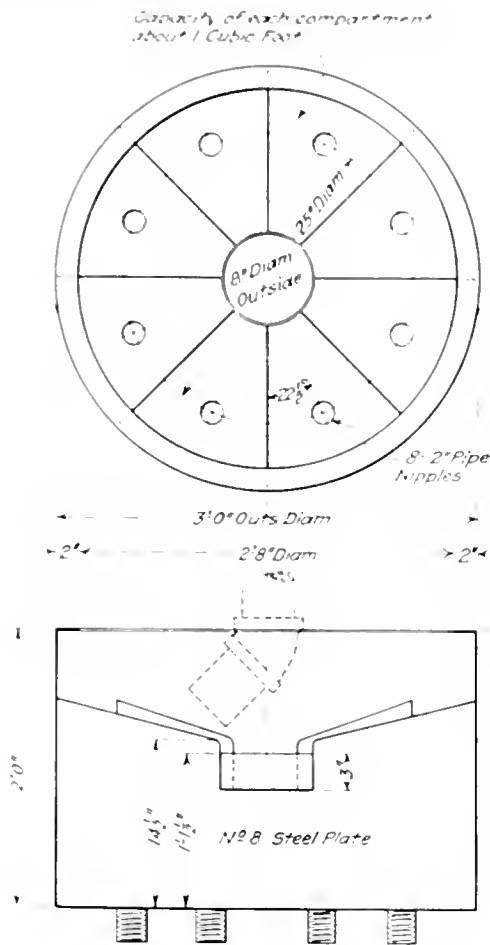

FIG. 5. ROUND-TABLE DISTRIBUTER.

THE FLOTATION PLANT occupies the lower part of the concentrator building, which is being dismantled, unit by unit, and the space thus cleared being replaced by machines for re-grinding and making flotation concentrate.

Adjoining the Dorr thickener plant (see general plan, Fig. 1) is the concentrate-dewatering plant and the Oliver filters, all parts of the flotation system.

In brief, the process consists in finely grinding the concentrator-tailing, adding oil and acid to the pulp, agitating this mechanically (finally with the aid of air), skimming the mineral-bearing froth produced (this being the concentrate), settling it out in Dorr thickeners, and from them removing the thickened underflow for filtration by the Oliver filters. The resultant product,

still retaining 10% moisture and containing 6% copper, is sent to the smelter.

On the right-hand bay of the 'middling division' of the concentrator are ten 7-ft. Anaconda classifiers, which take the screened undersize from trommels of 12 by 1.5 mm. opening (Fig. 2). This is really the collected tailing from all the water-concentration operations. It amounts to 1,750 tons, the 250 tons out of the 2000 tons capacity having been already removed as coarse concentrate. Classification gives two products, a slime overflow of 400 tons of -200 mesh and a spigot-discharge of 1350 tons, which would include all sizes between 1.5 mm. and +200 mesh, and is nearly slime-free. The overflow is now treated on round tables, but these will be eventually discarded in favor of flotation. The spigot-discharge passes to Wilfley tables provided with the curved Butchart riffles and these take out 250 tons of concentrate, leaving 1100 tons of so-called middling.

It is this middling product that has to be finely ground either in tube-mills or in Hardinge mills. These are situated in the 're-grinding division.' (Fig. 6.) One unit is supplied with tube-mills, 8 ft. diam. by 12 ft. long; the other units are to have each six Hardinge mills, 10 ft. diam. with the cylindrical part 4 ft. long and 11 ft. between bearings. The middling product of the Wilfley tables flows by launder directly to these mills.

Alongside and parallel with each mill is a Dorr classifier of the rake type, which receives the flow from the mill, returning the coarser sand for re-grinding, while the classifier-overflow, now sufficiently fine, passes to the agitators. It is a mixture of sizes, mostly below 60-mesh, experience indicating that it is fine enough to have released most of the included grains of copper sulphides. This mixture of sizes down to the finest is regarded as being better than one in which the grains are uniform. It is held that the fine particles fill in spaces between grain and grain, so increasing the film attraction. To each mill is fed a small amount of wood creosote ($\frac{1}{16}$ lb. per ton), and this is ground into the sand as it passes through the mill. A mineral particle, at the instant of fracture, and before it can be in any way oxidized, may be at once filmed with creosote, the oil thus choosing the favorable instant when the freshly-broken nascent surface can receive it. At any rate it has been practically found that this homeopathic dose aids in the subsequent agitation. For grinding, not only pebbles but iron and steel balls have been tried. Local pebbles and those from the Pacific coast have been tested, but the imported selected Danish pebbles have proved to be the most satisfactory in spite of their price. Pebbles of a flattened spheroidal form do not last, since they wear thin and eventually break in two.

The Jeffrey Co. is furnishing a cast manganoid ball of 1 to 3 in. diam. that serves quite well. It is made from any scrap cast-iron, to which has been added ferromanganese to bring minimum content to 1.5% Mn. Cast in a sand mold, if perchance venting is omitted, then a bubble forms on the top of the sphere, and when the thin scale over the bubble breaks, the remaining depression slowly wears in cup shape. Manganese-steel

balls have also been tried, and owing to their toughness, they are quite durable. As between the various metal balls it is a question of price, or of cost per pound per ton treated. Metal balls as compared with pebbles strike more effective blows. The metal liner is another feature that is being tried. These are of the ribbed type bolted to the shell of the mill. Between the ribs the pebbles or balls are expected to lodge, thus protecting the liners from wear. A type of liner, now being introduced, consists of pieces of 4 to 6 in. long, sawn from 60-pound rails. The cutting of the rails is done with a rapidly-revolving cold saw, which will sever a piece in a few seconds. These pieces are packed on end against the shell of the mill and the interstices filled with cement mortar.

In the tube-mill, at the discharge end, is placed a perforated-plate diaphragm to hold back the pebbles from discharging. In the Hardinge mill, which has no such diaphragm, by reason of selective action, small pebbles (perhaps only sand) escape. Any such pieces, of course, are returned to the feed-end by the Dorr classifier.

Turning to the flow-sheet, it will be seen that the 'flotation division' consists of four Minerals Separation agitators, each of 350 tons capacity. Two machines are placed back to back; the other two are single. Each machine has 14 divisions where the re-ground pulp is treated in series. The Dorr classifier overflow is brought by a distributing launder to the heads of the four machines, a deflector serving to cut out what is needed at each. The pulp, with the addition of 5.5 lb. of 52°B. acid and 2.5 lb. of mineral-oil residue (sludge from the oil-refinery) is agitated in the compartment in series from No. 1 to No. 14. There results at each compartment a froth that is scraped into a launder, while the unaffected tailing is drawn off at the bottom, to enter the feed division of the next compartment. The supply to any compartment is regulated by a flap-valve actuated by a rod with a screwed end and a hand-wheel at the front of the machine.

Referring to the flow-sheet, it will be seen that the darker finished concentrate from the first three boxes or compartments of the M. S. agitators is ready to send away, that the rich middling from boxes No. 4 to 9, inclusive, goes to the Callow machines for further treatment, that the product from boxes No. 10 to 14 (the dirty middling) is to go through the M. S. agitator again, and that the final clean tailing, the spigot-discharge, now containing 0.10 to 0.12% copper can be sent to waste.

The Callow machine aerates the rich middling from the M. S. machines, giving a mass of froth that joins the other concentrate, but the tailing cannot be sent to waste, and this goes back to the primary machine to again go through it in series.

We see then that the M. S. machines give a clean tailing, the Callow machines a clean concentrate. The two machines work in a closed circuit except that there is a point of escape for the tailing in the first one. The Callow machine may be regarded as affecting a further saving of concentrate due to aeration, such as the primary machine will not give.

We now come to the question of how this final bulky and light product is to be collected and brought into solid form for smelting. This is effected at the concentrate-dewatering plant (see the general plan of the works) where there are six 50-ft. Dorr thickening tanks, each 14 ft. high.

In studying the flotation methods of this establishment one must be careful to not become confused by the two buildings interposed between the concentrator and the concentrate-dewatering plant. These two are devoted to other purposes independent of our present study.

If Dorr thickeners of the ordinary type were used, the frothed material, falling at the centre of the tank, would float across to the overflow-launder that encircles the edge of the tank and would be lost in part. To prevent this, a frame 16 ft. square and about 4 ft. high, surrounds the centre, its lower edge dipping into the liquid. This holds back much of the froth. Another diving-board encircles the tank two feet within its edge, also tending to hold back the bulky product while permitting the water to escape at the circular overflow-launder. The froth thickens, gets heavier by standing, and eventually sinks. One may note, though, that it sometimes misbehaves and manages to climb under the skimming edges into the overflow-launder, causing some loss. How to more speedily thicken the material is a practical question. In a vacuum-pan I have seen the contents, when they happen to foam, beaten down by the sudden admission of some air, which at the same time breaks the vacuum.

The pulp has now sunk beneath the water and has been ploughed by the bladed arms of the thickeners, to the centre, to be discharged thence as a thickened product by launder to the Oliver filter-machine. (Fig. 7.) An addition of 125 lb. of quicklime per shift is made here. It flows inside the filter-drum, thence finding its way beneath to the hopper of the machine, where it is kept stirred by an agitator. The reader will remember that this type of machine draws its supply of pulp from the bath of pulp beneath, sucking it against the exterior filter-surface of the revolving drum. By the time the filter-surface begins to rise above the bath it has been coated with a layer of material an inch thick, and this is being sucked drier as the revolution continues. It is not necessary, as in cyanide practice, to wash the layer, since the object in this case is merely to remove the water. When the product has been scraped off on the discharge side, not more than 10% of moisture is left. The moist concentrate of the machine falls upon a conveying-belt to be taken away by hopper-bottom cars to the smelter.

AMERICAN ROCK-DRILLS were employed recently in driving two tunnels in Tuscany, Italy. American air-compressors were also used. It will be recalled that power rock-drills were first introduced in America for driving the Hoosac tunnel in Massachusetts, in consequence of the results attained with similar machines in the driving of the Mont Cenis tunnel in the Alps. Then they were introduced in the mines of Colorado.

Clay: Its Effect in Ore-Dressing and Cyanidation

By A. W. Allen

* CLAY is indispensable in brick and pottery manufacture, while in the treatment of ore it is generally a nuisance. Some clays in ores are not troublesome, but others greatly hinder filtration. In some cases settlement and dewatering of slime is only possible in highly alkaline or acid solutions. Old slime allows decomposition of pyritic and other minerals associated with clay, resulting in decreased efficiency of the cyanide solution.

There is a distinct difference between colloidal and non-colloidal clay, the former being undesirable when treating ore. The weathering of clay has a marked effect on the physical properties of the mineral. Original clay is practically non-absorbent, but the weathered material is highly absorbent.

In its non-colloidal state it is completely unplastic, whereas after decomposition it becomes highly plastic and capable of intricate manipulation. These alterations during weathering are fully utilized in the ceramic industry, where plasticity is, at times, of considerable importance in the manufacture of chinaware. The retentive or absorption powers of certain clays is well known. Adsorption has been defined as the power that clay possesses of removing, from solutions, substances with which it is in contact.

The adsorption of metallic gold is an improbability when consideration is paid to the fact that the gold-potassium-cyanide compound is dissociated in the presence of water into K ions and AuCN_2 ions. If the latter act as electrolytes by which gold is deposited in place of calcium, then the action is the result of milling in gold-bearing cyanide solution in place of alkaline water; and may be suggested as an explanation to account for the experience of J. W. Hutchinson,[†] borne out by myself and others, that treatment, after crushing in cyanide solution, necessitates a longer time for the recovery of the gold than required when the ore is crushed in water and given a preliminary alkaline treatment. It is also interesting to note that the problem of clarification of solutions after milling-in-cyanide is invariably obtrusive, whereas after milling-in-water trouble is seldom experienced in this direction. In other words, the electrolytic value of gold-bearing cyanide solution is inferior to that of lime water; and when once the slime particles are charged with the former no addition of lime will materially hasten coagulation.

A further, and perfectly reasonable assumption may be made, that the gold in the finest condition and associated with the ore may be in the colloidal state. Any

clay may actually absorb gold either during or after the process of water absorption. Marshall and Welker[‡] have shown that colloidal aluminum hydroxide in the form of a thin jelly is capable of completely absorbing gold from its colloidal solution. This aspect of gold absorption may not need more than passing mention, although it may have a greater bearing on gold recovery processes than we are inclined to admit at present.

In the selective absorptive qualities of clay it is more than likely that gold and silver compounds are absorbed into the structure of the colloid. Their complete recovery may be either impossible or impracticable. Theories regarding dissolved and undissolved gold and silver may have to be modified. Metals that cannot be rapidly washed from colloidal clay may not necessarily be undissolved; it is very likely that they were partly dissolved and later adsorbed. Experiments have proved this. When colloidal clay in emulsified form is milled in lime-water, the colloid assumes a temporary equilibrium as far as absorption of water and salts of water is concerned and absorption and adsorption have occurred. Any further interchange of solution will then be a matter of slow dialysis. Hence, when this clay substance comes into contact with cyanide solution, it may be less likely to abstract the dissolved or undissolved metals associated with the ore during the limited time of agitation and treatment.

On the other hand, if a clayey ore is milled in an alkaline cyanide-solution carrying gold, or into which gold immediately dissolves, there is no reason to assume that the colloid will exhibit any selective action to the exclusion of the gold compounds. Absorption equilibrium will then be reached with a gold-bearing solution which can only be displaced with difficulty, or not at all.

Colloids may be divided into suspension colloids and emulsion colloids. The former may be coagulated by mechanical means; they possess marked electrical properties; they can be precipitated by very small quantities of electrolyte; and they possess little or no viscosity in solution. In emulsion colloids, on the other hand, the hydrosols show an absence of electrical phenomena; they form viscous solutions; and are not coagulated until the concentration of the electrolyte in the solution is comparatively high. The common action of emulsoid clay is probably one of absorption. Colloids may be liberated during ore reduction, but not produced; actual observation at the Miami mine, Arizona, proves this.

In wet processes of ore reduction, and when clay compounds are milled and treated in a cyanide solution containing gold, it would seem probable that an absorption

*Abstract of paper read before the Institution of Mining and Metallurgy, London, December 16, 1915.

[†]E. & M. J., July, 1912.

[‡]Jour. Amer. Chem. Soc., 1913.

of such solution occurs in the honeycomb cells of the colloid, and that subsequent displacement of this metal must necessarily occupy a much longer time than did its absorption. The absorption is due to direct imbibition, but displacement under normal conditions is probably due to a slow-acting osmotic pressure when the colloid slime is surrounded with wash solution or water. It is also probable that any absorptive equilibrium is only temporary under such conditions, and that cell content varies with the composition of the surrounding medium.

The question arises as to the relative merits of a slow decantation as compared with a rapid filtration process for the removal of the dissolved metal. It would seem that a combination of the two, in the order stated, would be the most efficient.

It is generally recognized among metallurgists that a considerable time of contact is necessary in washing operations with certain classes of ores; and that theoretical displacement figures do not hold good in practice. From what has already been said, it is apparent that time of wash should not always be based on estimates of gold in solution which is apparently dissolved, as compared with gold associated with the ore which is apparently undissolved. In practical work it is generally found that, although the metal which has been dissolved may be apparently replaced fairly rapidly by ordinary means, a further abstraction of metal from ore occurs after prolonged contact with wash solution. This fact would furnish additional evidence that the gold solution so recovered is, in part at least, being drawn from the cells of the colloid slime, and not merely washed off the surfaces of the slime particles.

At some of the Kalgoolie mines the value of prolonged washing in filtration treatment is not so obvious, and comparatively short washes are given that abstract a high proportion of recoverable gold from the ore. In this instance it may be assumed that previous roasting treatment has, in some cases, destroyed the colloidal envelope, thus reducing the possibility of absorption to a minimum.

It is obvious that the absorption by clay of bases in solution must affect density of sp. gr. estimations; and the water may contain water of combination that should not be destroyed. Such water is part of the ore. The hygroscopic moisture, on the other hand, must be completely displaced. It is almost impossible to calculate a true hygroscopic moisture percentage in unground rock, or to estimate the actual quantity of dry ore in a large sample with any degree of accuracy. The correction for such moisture in cases where the ore is automatically weighed, or calculated from mine-car content, are often at fault.

He emphasizes the ill-effects on the efficiency of classification and concentration processes when colloid clay forms a constituent of the pulp. To this I agreed in the same journal of July 19, 1913, on the benefits of desliming prior to classification; and also with the question of the accretion of viscous clay on the sides of classifiers, settlers, and similar apparatus. As a remedy in the case

of settling-apparatus, I drew attention to the benefits arising from the general adoption of vertical-sided settlers in place of those of the spitzkasten type; and of vertical-sided classifiers in place of cones. Both these types of apparatus are arranged for the mechanical displacement of settled solids.

The viscous nature of settled colloidal clay is sufficiently obvious, and any comparative illustrations would be superfluous. On the other hand, the rapid decrease in the fluidity of a pulp, which results from the inclusion of clay in suspension, is considerable. A recent experience in connection with the settling of clay pulp may be of interest to others as it was of anxiety to me at the time. In this instance the amount of clay passing through the mill delivered intimately associated with the ore, and also in the form of pellets and balls of plastic and highly decomposed material, on more than one occasion caused an overload of the settling plant. The result was that the thickening efficiency of the settlers decreased as the amount of colloid material increased, and as soon as the fine slime commenced to overflow from the thickener, practically all the de-watering had stopped. The underflow then contained almost as much water content as the feed into the thickeners.

A further effect of the viscosity of the pulp was then noticeable. Classification became completely disorganized, and the fine sand escaping from the grinding plant was so buoyed up by the viscosity of the pulp that it traversed the radius of the settling tanks with apparent ease, and overflowed at the edges.

Examination of the clay pulp showed that the particles were in the gel form; that no addition or reduction in the amount of lime added had any appreciable effect in hastening settlement; and that the failure to settle was due to the preponderance and accumulation of this material which had absorbed large quantities of water and swelled accordingly. Although the clay entered the plant as unavoidable waste, it left on the residue carrying gold from which it could not be dissociated with ordinary washing methods.

In conclusion it may be said that:

1. The paper has been compiled to explain several points that have obtruded themselves from time to time in practical work. These include: (*a*) the fact that a complete extraction of gold from even the finest slime is impracticable; (*b*) the difficulty in the treatment of clay ores, as well as of ores with which clay is associated; (*c*) the fact that the cyanidation of accumulated clay slime often results in a lower extraction than would have been the case had it been treated direct from the battery; and (*d*) the fact that the milling of clayey ore in a gold-bearing cyanide solution invariably necessitates a longer time for treatment, and results in a higher residual metal content than would have been the case had it been milled in alkaline water.

2. The facts adduced indicate the highly absorptive properties of colloidal over non-colloidal clay, and show the powers which clays possess of retaining liquids and dissolved salts.

Drill Shanks and Bits

By P. B. McDonald

THE matter of drill steel shanks is not clearly understood by many mine superintendents, particularly as applying to steel for the increasingly popular mounted hammer-drill type of drills. Obviously it is not possible to use the same sort of chuck with a hammer-drill as is employed in a piston-drill, because the pounding by the hammer on a steel that is rigidly held would only waste the effort. The so-called 'standard Leyner drill-steel' is $1\frac{1}{4}$ or $1\frac{1}{2}$ -inch round steel; each drill-steel has two lugs on its shank, as shown in Fig 1. These lugs, when the steel is shoved into the drill-chuck and given a fractional turn, serve to hold the steel in the chuck, both to facilitate rotation and in order that, if the steel gets

E. M. Weston, in discussing South African drilling practice in the *Mining Magazine*, stated that "the whole theory of the design of rock-drill bits as formerly expounded is wrong. The point most insisted on has been the necessity for allowing ample clearance between the wings of the bit for the ejection of cuttings." That is why the four-point cross-bit has been the standard for so long. It is now being demonstrated that the four-point cross-bit is by no means so efficient as more blunt bits properly designed to drill a rounder and more even hole while holding their gauge to better advantage. Hollow steel, as now used with hammer-drills, effects satisfactory removal of the rock chippings or mud by forcing water or

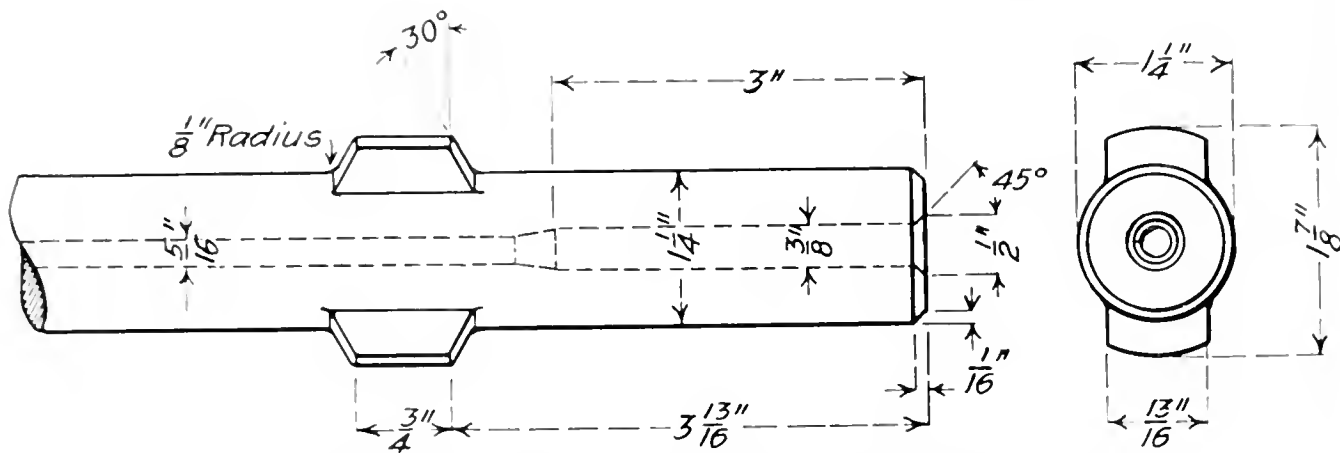

FIG. 1. A DRILL-SHANK ON ROUND STEEL FOR MOUNTED HAMMER-DRILLS. NOTE THE TWO LUGS.

stuck in the hole, the cranking back of the machine will extricate the drill. But some superintendents do not like these lugs, which, they say, are difficult for the blacksmith to make. To avoid the use of lugs on drill-steel for a mounted hammer-drill, hexagon drill-steel can be employed to insure rotation, as with stopper or sinker drills; this, however, necessitates a chuck somewhat different from the regular Leyner type. If the steel gets jammed in the hole, it is pulled out with a wrench; a sinker-drill, like the 'Jackhammer,' has a special 'puller' attached to it, being an ostentatious feature of that machine.

Drill-steel without lugs is likely to get pushed too far into the machine, injuring the efficiency by shortening the stroke of the hammer. To obviate this a collar is made on the steel, as shown in Fig 2. This limits the distance that a steel can be pushed into the machine. However, one of the best methods is to use a tappet or anvil-block between the steel and the hammer of the machine; an additional advantage is that the anvil-block saves the hammer from becoming battered against the drill-steel.

air against the bottom of the hole. As Mr. Weston points out, "the more we make the bit into the shape of a piston with small openings for the escape of water and cuttings, the more violent will be the ejection of cuttings, which are thus not pounded up at all, greatly increasing the drilling speed," and again, "it is quite feasible to use $1\frac{1}{4}$ -in. steel with a hollow core of $\frac{1}{2}$ -in. diameter, or $1\frac{1}{2}$ -steel with $\frac{3}{8}$ -in. hollow core, such that the rock in the centre of the hole would be drilled around to form a core and broken off in large pieces, reducing the cutting necessary."

It does not require much perspicacity to see that the ordinary four-point cross-bit with its comparatively fragile edges soon dulls and wears away. This is where the new blunt-looking bits, such as the II and Carr, show to advantage. They hold their gauge much better than a cross-bit while drilling as fast or faster. The special feature of the design of the II-bit is its two parallel cutting edges, as compared to the one edge of the Carr bit. In the course of trials at the Gastineau mine, near Juneau, Alaska, two mounted water-hammer drills

secured to a single cross-bar were tried with an H-bit of the International High Speed Steel Co. in competition with an ordinary cross-bit. The results showed a small advantage in the actual speed of drilling of the H-bit over the cross-bit, and a much greater advantage in not fitchering in bad ground. Furthermore the blunt and dull-looking H-bit did not require sharpening nearly so often, one set of steel out-drilling and out-lasting two sets of the cross-pointed steel. Variations of the chisel types of bits have their advocates, on account of the room allowed for the escape of mud. In reality the Carr bit is of the blunt-chisel variety, while the H-bit

bit; any method of reinforcing the peripheral edges, while not impairing the cutting speed or impeding the ejection of cuttings, is salutary, and represents the goal as at present recognized.

Geological Survey Cannot Make Assays

The U. S. Geological Survey calls the attention of mining men and others to the fact that it is not equipped for making assays or analyses of rocks, its laboratory being in fact overloaded with official work. Many specimens and samples are received by the Survey, accompanied by requests for such treatment, with which it is impossible to comply. The force of chemists employed is small, and their time is fully occupied by their regular official duties. The Geological Survey has no facilities for making gold and silver assays. The most

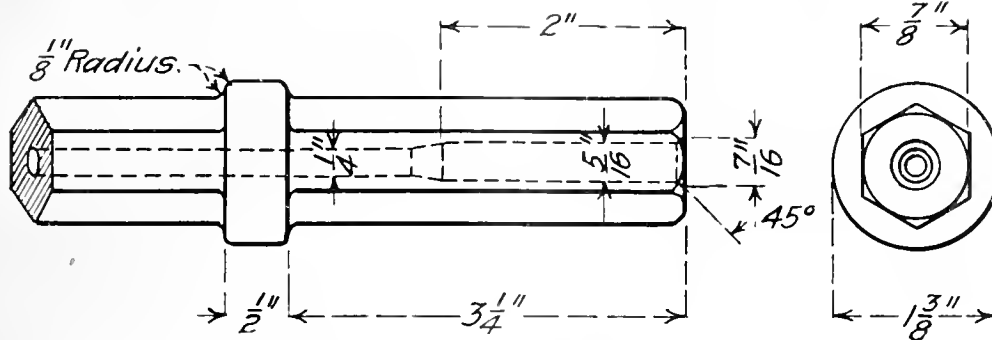
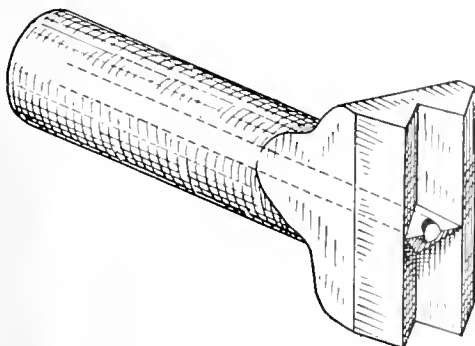

FIG. 2. COLLARED HEXAGONAL STEEL.

may be called a double-chisel type. However, while the simple chisel-bit may be effective in some rocks with hammer-drills, it has definite limitations particularly with piston-drills. That the introduction of improved drill-bits is a matter of no small consequence is indicated by a statement by James MacNaughton, general manager for the Calumet & Hecla Co.; he said, "the use of the one-man drill and Carr bit resulted in an increased output per miner equivalent to his total production of a few years ago."

Regarding the so-called flat cross-bit—or low-centre cross-bit, which soon wears to the same shape—that is,



THE H-BIT.

with edges slightly flattened in proportion to the distance from the centre (illustrated in the MINING AND SCIENTIFIC PRESS of Nov. 6), it is clear that the additional metal in the wings makes reinforced edges that stand up to the work in hand, giving a stronger and more resistant bit than the ordinary cross-bit, because holding its gauge much longer. The whole idea is to get a bit that will not wear on the edges as quickly as the cross-

the Survey geologists can do is to give an off-hand opinion based on a simple examination of the specimens. It might be a matter of surprise to know the large number of answers prepared daily by the Geological Survey, similar to the following:

"In reply to your letter, etc., * * * the material you send is merely a fragment of a quartz pebble. I regret to say that it has no probable value."

A great many other samples received prove to be iron pyrites, or "fool's gold," the shiny particles being taken by the writers for gold.

If an assay is desired, the proper course is to employ a private assayer or to send the specimen to one of the Government assay offices, where a regular charge is made for such work. When specimens are sent to the Survey for examination, applicants should be particular to state whether they wish them returned, as otherwise they will be destroyed. There are Government assay offices at Carson, Nevada; Seattle, Washington; Boise, Idaho; Helena, Montana; Salt Lake City, Utah; Deadwood, South Dakota; or New Orleans, Louisiana; and the Mint at Philadelphia for gold, silver, lead, tin, zinc, and antimony.

DRILL-HOLES 7 ft. deep in a tunnel of the Catskill aqueduct near New York were started 2 in. diameter and bottomed 1 1/2 in. diameter, changes of steel being made every 2 ft., says Charles A. Hirschberg in a recent article on drilling practice. That is, the reduction on successive changes of steel was only 1/2 in. This is an example of the increasing tendency to reduce drilling by decreasing the differential in diameters of successive bits. In the tunnel job mentioned, four mounted hammer-drills on two columns were employed.

On the Science of a Froth

By Will H. Coghill*

THE paragraph on the character of froth in Mr. Cal- low's article in the *MINING AND SCIENTIFIC PRESS* of December 4, 1915, page 852, led me to refer to some notes that have been pigeon-holed for some months. I think that a little mathematics can be applied to good advantage.

Before taking up the mathematics, however, I wish to mention some principles that I think have not been sufficiently emphasized in the articles on flotation; that is, a distinction between the properties of aqueous and non-aqueous films.

The little book on 'Surface Tension and Surface Energy,' by Willows & Hatschek, shows how the elastic film analogy in the study of froth will get one into no end of trouble if not handled with care. It is the characteristic of analogies to break down when pressed too far, though they are useful up to a certain point. This one is no exception. In the case of india-rubber it is obvious that a given weight can only stretch this to a definite extent. To further enlarge the rubber film, an additional weight would be required; while with a liquid film this is not true. Reference to a recent article¹ shows that the measure of surface tension is not when the film breaks, but at the instant when the wire is pulled away from *AB*. If the wire is pulled a great distance without breaking the film, the total energy of the surface is increased, of course, but the energy per unit-area and surface tension are unaffected. Whether or not the film breaks, depends not upon the surface tension, but whether or not there is enough liquid to supply the added area. The difference between a non-aqueous substance and a liquid film is, that in stretching the former the molecules are distorted or separated while in stretching a liquid film molecules come from within the liquid to occupy the new area. According to Devaux,² the surface tension phenomenon disappears as soon as there is no more liquid to come from within. The same laws apply to surfaces that are allowed to contract. The rubber has a constantly decreasing force of contraction as it approaches its original dimensions, while a liquid film always tends to contract with the same force independently of its size. Now, it is a common practice in demonstrating physical principles to omit certain qualifying conditions until the main features are outlined. This method must be pursued here. The qualifying statement is, that, in the case of a contaminated liquid, the film may not contract with a force independently of its

size"; that is, after learning to look upon surface tension as a constant force we must now view it as a variable force. Take, for example, the explanation of the effect of oil on waves.³ When a small wave is formed on the surface of water the surface is stretched; for, obviously, the wavy surface has greater area than the plane surface. Owing to the stretching of the surface the oil film is made thinner so that the contamination due to oil is reduced, and hence the surface tension is increased; this increase in surface tension tending to oppose the production of the wave.

Again, Edser⁴ discusses variable surface tension under the heading 'Stability of a Liquid Film.' He shows that when a film is on a vertical rectangle⁵ equilibrium is impossible unless the surface tension is greater at the top than at the bottom of the film. This is obviously due to the weight of the film itself. For pure water, the surface tension is nearly constant, and therefore, a water film more than two or three millimetres in height cannot be formed. A slight trace of grease will give the water a variable surface tension; if the surface tension at any point on the film is insufficient to produce equilibrium, the film stretches at this point, and the concentration of grease is diminished, so that the surface tension increases automatically and equilibrium is maintained.

He concludes by saying that the great stability of a soap film is due to the wide variation in surface tension between freshly formed and long exposed parts of the surface and that any stretching of the film, due to insufficient strength, immediately increases the surface tension. Now it seems to me that it is time for us to get away from the idea that low surface tension *per se*, is necessary for the formation of a froth, for Edser has made it clear that the contamination of the film with something that will give a variable surface tension is the essential. To be sure, this amounts to reducing surface tension, because contamination of water, with some exceptions, has this effect. The attorney who discoursed at great length upon surface tension and said that the longevity of a bubble was increased by decreasing the contractile drawing force of surface tension, was merely riding too far the willing horse that many of us have ridden so freely.

It is quite easy to accept the statement that soap contaminates water enough to afford a variable surface tension, but it is not quite so clear how a very small fraction of 1% of oil will give the same results, until we have considered adsorption.

Adsorption has been described several times in the

*Professor of Mining and Metallurgy, Oregon Agricultural College, Corvallis, Oregon.

¹T. A. Rickard, *Mining and Scientific Press*, September 11, 1915, p. 383.

²Henri Devaux, 'Oil Films on Water and Mercury,' *Mining and Scientific Press*, July 31, 1915, p. 156.

³J. W. Watson, 'General Physics,' page 113.

⁴Edwin Edser, 'General Physics for Students,' page 348.

⁵The cut of the rectangle was shown in the article previously referred to in the *Mining and Scientific Press*, September 11, 1915.

technical journals, but I believe I am justified in taking it up again and quoting 'Surface Tension and Surface Energy,' because here we find the generalized statement describing adsorption in a liquid and its effect on surface tension. It says: "If the dissolved substance diminishes the surface tension of the solution, an excess of concentration in the surface layer diminishes surface energy. If, on the other hand, the solute increases the surface tension, the surface energy will be reduced if the concentration in the surface layer is lower than that of the bulk of the solution. This difference in concentration between the surface layer and the bulk of the solution is called adsorption and is a physical fact. The factors tending to produce adsorption are opposed to the factors tending to establish uniform concentration. The final distribution of a solute is the resultant of adsorption and two other effects, namely, osmotic pressure and electric charge. Important qualitative conclusions are drawn from theoretical considerations already developed. A small quantity of dissolved substance may reduce the surface tension very considerably, but it can only increase it slightly. Thus, sodium chloride increases surface tension of water to a small extent; the concentration in the surface layer is accordingly smaller than in the bulk, and the effect of the solute is thus partly counteracted. On the other hand, many organic salts reduce surface tension, and therefore accumulate in the surface layer; so that in extreme cases, the whole of the solute may be collected there and produce a considerable effect, although the absolute quantity may be exceedingly slight."

Adsorption is of such unmistakable importance that we will refer to 'The Chemistry of Colloids,' by W. W. Taylor, for a different perspective of the same thing. Here I quote freely, for I am not intending to advance my own theories, but to bring out what seem to me to be pertinent physical facts. And here I wish to state that I fear that the premise for my recent calculation⁶ of the carrying capacity of the surface of a liquid is not correct. It was an attempt to elaborate on a weak statement in a text-book, and hence the calculations themselves cannot be credited.

Adsorption, in its most general sense, implies the unequal distribution of substances at the boundary between two heterogeneous phases: solid-gas, solid-liquid, and liquid-gas. We are concerned just now with only the last.

The surface layer of a liquid is under great compression, due to the big difference of the molecular forces on the two sides of the interface, and consequently the concentration in the surface of a solution must be different from that in the bulk of the liquid. For just as unequal temperatures in a dilute solution cause an unequal distribution of the solute, so from the same law unequal pressures must also produce an unequal distribution. This pressure (due to surface tension) always, in time, adjusts itself to the minimum, for a component which lowers surface tension is always increased in the

surface layer whether the component be present as solvent or solute.

We now have a new principle to apply to a bubble, to wit: on account of adsorption a fresh surface always has a greater surface tension than an old one; thus if it is stretched locally by conditions tending to break it, it is automatically reinforced at that point.

It is now obvious that without adsorption it would be impossible to realize a variable surface tension, for if the solution were contaminated uniformly throughout, a fresh surface exposed by the stretching of the film would have the same energy as the old surface, and the ultimate result would be identical with the case cited where pure water was used.

In this argument I have assumed that the contaminating substance is soluble in water. I realize fully that many of the flotation oils are said to be insoluble in water, but I maintain that solubility is only relative, and further, we know nothing about the multiplicity of chemical reactions possible in a pulp which might release contaminating substances that would produce the adsorption phenomenon. If graphite, for instance, acts as a frothing agent, it might have to be treated as a special case and could not be taken as proof that the above arguments are invalid. If the flotation oil is extremely insoluble in, and lighter than, water there would be an oil film at the liquid-air interface and over the liquid film containing adsorbed oil. It might be well at this point to drop the subject of variable surface tension and undertake to get a better idea of the absolute value of these forces. One physicist has spoken of them as being enormous.

As far as surface tension is concerned it is theoretically possible to blow a soap bubble as big as a house.

Take the formula:

$$(1) \quad P = \frac{4T}{r}$$

Where T = pull due to surface tension in grams of a film of one surface and 1 cm. long.

P = excess pressure inside per unit-area, and r = the radius of the sphere.

This formula takes into account the pull on both the internal and external surfaces. It needs no demonstration, as it is derived in the same manner as the old familiar formula used in calculating the thickness of boiler-shells, etc.

In case of a liquid drop or a bubble submerged in water, the formula is:

$$(2) \quad P = \frac{2T}{r}$$

Now let us use these formulae to make a little study of the mathematics of a bubble to see how much variation of surface tension and external pressure amount to when numerically expressed and see if Mr. Callow's argument is good.

He states: "The bubbles * * * being generated under hydraulic pressure varying from 15 to 40 inches, on rising above the water * * * burst by reason of the lower surrounding atmospheric pressure." This pictures the emerging bubble as expanding like a bladder when suddenly inflated by increased internal, or de-

⁶"Surface Tension," *Mining and Scientific Press*, October 9, 1915.

creased external pressure, and is a misconception. To make the steps more simple we will first study the bubble in the air and then when submerged.

Assume 1 cc. of free air taken in form of a sphere.

$$3 \quad V = 42r^3 = 1 \\ r = 0.620 \text{ cm.}$$

Now suppose this air to be enclosed in a liquid film in air where the liquid air surface tension is 70. The new radius can be calculated by the application of Boyle's law, which is, that the pressure varies inversely as the volume, where absolute pressure is of course understood. The free air is, in round numbers, under a pressure of 1000 gm. per sq. cm. and a surface tension of 70 dynes per cm. exerts a pull equivalent to a weight of approximately 0.07 gm. per cm. of length.

The proportion used to calculate the new radius is:

$$1000 : 1000 + \frac{0.7}{r} :: 4.2r^3 : 1$$

$$4 \quad 4200r + 1.176r^2 = 1000 \\ r = 0.619$$

$$P = \frac{11}{r} = \frac{11}{0.619} = 0.453 \text{ gm. per sq. cm.}$$

The second term of equation (4) is the only one that contains a function of surface tension, and since it is of such small numerical value, it is plain that any variation of surface tension has very little to do with the radius of an individual bubble in air. Even when the surface tension varies between zero and a maximum, as in (3) and (4), the change of radius is, in fact, too slight to be calculated on the slide-rule—only from 0.620 to 0.619 cm. It is interesting to note that P has a value of 0.453 gm. per sq. cm., which equals 0.006 lb. per sq. in. This is the order of magnitude of the forces that cause a spray above the froth.

Suppose again that the bubble is 1 cm. below surface. We then have:

$$5 \quad 1000 : 1001 + \frac{11}{r} = 4.2r^3 : 1 \\ r = 0.618$$

$$P = \frac{11}{0.618} = 0.226$$

Total pressure = 1 + 0.226 = 1.226 gauge.

Finally take a depth of 75 cm.

$$6 \quad 1000 : 1075 + \frac{11}{r} :: 4.2r^3 : 1 \\ r = 0.561$$

$$P = \frac{11}{0.561} = 0.250$$

Total pressure = 75 + 0.250 = 75.250 gauge.

These results are shown in the appended table:

ONE CUBIC CENTIMETRE FREE AIR

| No. | Description. | r | P | Gauge pressure. | Absolute pressure. |
|-----|--------------------|-------|-------|-----------------|--------------------|
| 3. | Free air | 0.620 | 0.000 | 0.000 | 1000.000 |
| 4. | Liquid film in air | 0.619 | 0.453 | 0.453 | 1000.453 |
| 5. | Submerged 1 cm. | 0.618 | 0.226 | 1.226 | 1001.226 |
| 6. | Submerged 75 cm. | 0.561 | 0.250 | 75.250 | 1075.250 |

Column r shows that a bubble emerges with an infinitely small change of radius. In fact the change is on the side of decrease because of the surface film being doubled. Now, since there is practically no expansion or contraction upon emerging from the liquid, it seems to me that "low surrounding atmospheric pressure" has

nothing to do with bursting Mr. Callow's bubbles. Of course it is well known that if a gas bag is burst under water the gas remains under confinement; whereas if it is burst in air it is evanescent, but it is necessary for the metallurgist to study the texture of these bags.

Since a bubble does not expand, how are we going to account for "4-inch bubbles"? By coalescence (unless electrification plays a part). Sometimes they cohere but do not coalesce. When they coalesce the large one robs the small one because pressure varies inversely as the radius (see Equation 1). The little one 'pumps' its gas into the large one. We shall have to learn how to control coalescence.

Viscosity is another important factor that must be considered along with variable surface tension and coalescence. It is not surface tension that breaks bubbles, but it is blows upon a surface that lacks viscosity or toughness and variable surface tension, that cause rupture. They rupture easily on account of lack of friction of the molecules. With low friction a blow is likely to cause the molecules to be separated a distance at which surface tension phenomena disappear before other molecules have time to come from below and reinforce the area with their greater surface tension.

The books all emphasize the importance of great superficial viscosity and small internal viscosity for the persistence of a froth. It is said that alcohol which has a superficial viscosity less than the internal viscosity, when mixed with superficially viscous liquids, will neutralize the relative surface viscosity and make frothing impossible. Hence the practice of adding a few drops of alcohol to check frothing in pharmaceutical work. We know that tannin sometimes interferes with flotation work and also that it may form a colloidal solution with water. May we not add that alcohol and tannin are deterrents because adsorption is checked on account of internal viscosity produced by them? For, without adsorption, one of the leading factors tending to produce a stable froth is nullified, that is, variable surface tension.

My best thanks are due to Dr. W. B. Anderson, professor of physics in the College, for his helpful suggestions and critical reading of these notes.

THE STRAITS OF MAGELLAN are known to contain gold in placers, and 15 dredges were built in Tierra del Fuego several years ago to recover gold from that remote district. However, only one dredge worked intermittently during the past three years. T. C. Earle, writing in the London *Mining Journal*, states that the production of gold in the Magellanes declined from 6300 oz. in 1904 to 1000 oz. in 1912. "It is," says this writer, "a land of perpetual tempest, dreary, bleak, treeless. The apathetic attitude of the Chilean government is not conducive to industry there. The settlement of Porvenir, ten years ago a flourishing mining town, is today a collection of empty shanties with boarded-up windows."

A PIECE of drill-steel, 2½ ft. long, preferably solid, may be handy on a supply-clerk's or foreman's desk for obstreperous or threatening visitors.

CONCENTRATES

Readers of the MINING and Scientific PRESS are invited to ask questions and give information dealing with technical and other matters pertaining to the practice of mining, milling, and smelting.

ONE TON of tungsten metal will make filaments for 18,000,000 electric incandescent globes.

IN CUTTING rubber for gaskets the work will go much easier if the blade of the knife is kept wet.

GYPSUM is soluble in 500 parts of water, and completely soluble in boiling hydrochloric acid.

SCHEELITE is soluble in nitric or hydrochloric acid, leaving a yellow residue that is soluble in ammonia.

CINNABAR is amenable to flotation. In fact, its ready tendency to float was the cause of failure in treatment by water concentration.

THE BELT-CONVEYOR is an efficient method of transportation, requires little power, is relatively moderate in cost, and needs few repairs.

THE FIRST PIECE of gold found in California by James W. Marshall was worth 50 cents, and the second, \$5. They were paid out for provisions and all trace of them was lost.

DRILL-BITS are improved, several authorities say, by being hammered while sharpened. The advocates of hammering claim that the steel is thereby toughened and strengthened.

ABANDONMENT OF A MILL-SITE results as follows: if the required work is not performed upon a lode-location it becomes forfeitable, following which the attached mill-site is also forfeitable.

BONUSES to miners are frequently paid by a check separate from the regular pay-check, in order to visualize more conspicuously, to the men, that they are receiving extra pay for extra effort.

A TRAM-CAR will hold more broken rock and take longer to load when the rock is fine than when the pieces are large and fewer. For that reason miners who tram their own rock on contract are likely to blast so that the rock is not broken too fine.

FATIGUE of drill-steel is worth providing against by having on hand an amount considerably in excess of requirements so that each steel will receive a longer rest between drilling periods. The same phenomenon is common with razors or safety-razor blades for shaving.

THE BRADEN was the first of the large low-grade copper companies to introduce oil flotation on a complete scale, being a pioneer in this direction. According to a recent report by Pope Yeatman, in any new process difficulties are encountered, the chief in this one being due to the

variability of the oils, especially of the wood-tar varieties. Thus it may be mentioned that by reason of the low extractions in April and May last, caused by proper oils not being available, recovery decreased to a little over 69%, and immediately on receipt of the correct oil, in the latter part of May, it jumped to over 75%.

ENRICHMENT of the upper or superficial parts of a gold-quartz vein is often the result of simple concentration. The leaching and removal of the pyrite is effected without the shifting of the gold, which remains behind in a honeycombed mass of iron-stained quartz. Thus this part of the vein loses weight without reduction of volume, so that the ore is so much the richer per ton.

IN some cases the leaching of the upper portion of a gold vein may produce solutions in which the gold is soluble sufficiently to cause it to migrate downward and to be precipitated near the water-level, which not infrequently coincides with the base of the zone of oxidation.

OXIDATION of the pyrite in the outcrop of a gold vein renders it soluble in surface-water, while the gold, which is relatively insoluble, survives to make 'specimen' ore. In the cubes formerly occupied by the pyrite will be found crumbly native sulphur and fine crystals of gold that are easily shaken loose.

THIS applies also to gold when associated with copper pyrite and other copper minerals. The superficial leaching may so concentrate traces of gold in the vein as to make the outcrop valuable for that metal, while the leaching of the copper leaves a gossan, or sintery mass of ironstone, enriched as to gold but impoverished as to copper. This is exemplified by the early mining at Butte.

MINE TIMBER deteriorates from several causes, but perhaps the most unique was an instance on the 1300-ft. level of the Knights Deep mine on the Rand, where white ants had bored into the caps of some sets. If these insects should spread through the mines they might become a menace to the timbering.

ROCK-DRILLING by contract, with payment made per foot of hole drilled, has not usually worked out satisfactorily. The miners place the holes where they are drilled most easily rather than where the smallest number of holes will break the greatest amount of ground. A price of 6 or 8 cents per foot of hole drilled was paid in hard limestone in Missouri.

RUTILE AND ILMENITE are both used in the manufacture of ferro-titanium, which is employed in making steel and cast iron. Both are used in making electrodes for arc lamps. Rutile is the source of titanium for making cupro-titanium for use in brass and other copper-bearing alloys, and for making potassium titanium oxalate, used in dyeing leather and textiles. A little rutile is also used in ceramics.

REVIEW OF MINING

As seen at the world's great mining centres by our own correspondents.

BUTTE, MONTANA

NOTES ON THE RECENT FATAL FIRE—ELECTRIC LOOS.

As mentioned in a telegraphic dispatch to the Press, published on page 289 of the February 19 issue, fire broke out on the 1200-ft. level of the Anaconda company's Pennsylvania mine on February 14. Nineteen miners and two members of the rescue parties were asphyxiated. The Pennsylvania has two openings, the main hoisting shaft, down 2800 ft., and an air-shaft, 1800 ft. deep. The fire apparently started on the 1200-ft. station of the air-shaft. The station-tender was the first to notice the fire, the place then being a mass of flames. Quick work on the part of the station-tenders and foremen was responsible for saving the lives of the 200 men who were hoisted to safety. An old fire has been smoldering for many years in some of the adjoining mines that are connected underground with the Pennsylvania. When the alarm spread, the impression was given that one of these old fires had broken out. This misapprehension no doubt was the cause of most of the deaths, as the men in that part of the mine where the smoke was thickest naturally ran toward the air-shaft, and in doing so they ran right into the source of the gas and smoke. The assistant foreman and a member of the first-aid crew put on Draeger helmets and made several trips into the smoky depths. A carbide lamp would not burn in the smoke and electric flash-lights were used. Later an electric extension cord 50 ft. long was fitted with 20 globes, and it was impossible to see from one globe to the next. The last trip these two men made was to the 600-ft. level. They were in some distance from the station when the first-aid man dropped. Some hours later when the next rescue-party was able to get off on the 600-ft. level they found the assistant foreman and the first-aid man lying on the track near the station. Heroic efforts were made to revive these men when they were brought to the surface, but the gas has the effect of hardening the lungs, and artificial respiration was tried for four hours without effect. It is thought that in the dense smoke the first-aid man unconsciously pulled at his goggles, as one will when his vision is poor, and thus loosened his mask, which would allow the helmet to fill with gas. The assistant foreman was known to have a weak heart, and he had been warned not to wear a helmet. He probably died of heart failure. Several miners and some members of the rescue-parties who were found shortly after being overcome, were brought to the surface and revived without much trouble. A big exhaust fan was quickly installed at the head of the air-shaft, in an effort to clear the workings of smoke and gas. The timbers in the air-shaft were on fire between the 1200 and the 1000-ft. levels, and water was poured down the shaft in an effort to extinguish the blaze. The fire weakened the timbers and the shaft started to cave. Blocks of ground and timbers could be heard falling through the shaft. As soon as all the bodies had been brought to the surface, and it was certain that no one was trying to escape through openings to adjoining mines, these connections were sealed with concrete bulkheads. The gas had already spread to some of the other mines, so that the regular shifts could not work. Several of the men engaged in building bulkheads were overcome, but they were all revived. The origin of the fire is not known. There is a large electrically-driven fan at the 1200-ft. air-shaft station, and more or less oily waste and grease might have accumulated

here, and the careless use of a lighted candle or a short circuit would have started a blaze. An effort is being made to confine the fire to as small an area as possible with bulkheads, but it is still burning fiercely and the thick smoke makes all operations difficult. The miners had left their dinner buckets and hats behind in their scramble for safety. Some of the bodies bore marks that indicated that they had been kicked by the half-crazed horses running through the drifts. The Pennsylvania is one of the old mines of the Anaconda company, and one of the few that has not been entirely equipped with electric haulage. Eight horses perished. The removal of their bloated carcasses was a difficult job. The fire has spread to the drifts and stopes, and the ore is burning. The U. S. Bureau of Mines telegraphed that it would send its rescuers if they would be of assistance, but the rescue equipment and organization of the company are so complete that help was not needed. Ore will not be extracted from the Pennsylvania for some time, but this will not curtail production, as the other mines can supply all the ore needed for the smelters.

The electrified division of the Chicago, Milwaukee & St. Paul railroad from Three Forks over the continental divide to Deer Lodge, a distance of 115 miles, gave excellent results during the recent cold weather that prevailed all over Montana. The great electric locomotives had no difficulty in dragging their loads over the mountain through the snow. Twenty-one miles of this distance has a grade of 2%. Four hundred and forty miles will eventually be electrified at a cost of \$12,000,000. The electric energy is generated by water-power. The new locomotives will operate over two of the old steam divisions, and thus eliminate round-houses and yards at intermediate points.

It is rumored that the Anaconda company will take over the Pilot Butte holdings on a basis of \$14 per share, or \$1,400,000 for the property. The situation at the Pilot Butte is similar in some respects to that which prevailed at the Butte-Alex. Scott, previous to the sale of the latter to the Anaconda company. There has been considerable litigation, and as a result ground belonging to both has been tied up, with resulting high expense. The easiest way out of it is by an absolute sale of the Pilot-Butte to the Anaconda, as the latter with its greater facilities can operate the property to better advantage.

ATOLIA, CALIFORNIA

SMALL TUNGSTEN PRODUCERS AND LARGE COMPANY CLASH.

The pent-up friction which has developed for nearly a year between the Atolia Mining Co. and the outsiders who have opened adjoining claims in the Atolia tungsten district, broke out on February 13. A temporary truce was agreed upon by the opposing factions.

Last year James M. Rice staked a claim adjoining the Atolia company's holdings on the south side, at a point where another claim, not owned by the same company and known as the Toboggan, also meets the company's southerly side-line. The Toboggan is being worked by its owner, Geo. B. Landers, of Bakersfield, who has several lessees working, extracting rich ore. Rice also has been working continuously since last summer, and his rich finds have attracted much attention ever since.

The rich float marketed by the lessees and workers of these and other newly-developed claims in this district has found

its way into Eastern markets in competition with the Atolia's product. The small miners are selling in small quantities, for cash, to agents on the ground, at such prices as the exigencies demand, in order to get funds to open their properties.

It is not, therefore, a very intricate problem to note the causes leading to probable friction between the representatives of the company which controls a hundred or so claims in one 'blanket' location, and the many small individual miners who have lately been responsible for the development of what means a promising centre in the tungsten industry.

On February 13 a surveyor is said to have re-located the original lines of the Atolia company's boundaries, and what portends an open row and, possibly, a big law-suit, become apparent. The 'potato patch' has proved a wonderful producer of high-grade scheelite, discovered as alluvial on top of bedrock. Pieces weighing over a 100 lb. have been found, and the



ATOLIA, CALIFORNIA.

company has over three score men digging for this float at \$3 per day, while the product is worth \$2 to \$6 per lb. in the East.

The contention of the American miners—the company hires mostly Italian miners—is that many of the company's claims have been located not as placer but lode claims, describing a certain lead, lode, or vein, and in many instances, it being 15 to nearly a 100 ft. to bedrock, there was no evidence of a lode on the surface, it being requisite that a showing of mineral in place is necessary to constitute a valid location of quartz claims. It is also contended, that in the area of 2000 acres, taken up and claimed by the Atolia company, many claims have been patented as lode or quartz claims on which no lodes or veins are manifest. The influx of new miners to the district, who are thoroughly prospecting it, is apparently responsible for increased development and an exposé of these conditions.

In the truce arranged, there is talk of the Atolia company entering as a purchaser of the claims conflicting with its rights. In the great area claimed by the company are many individual claims lying like so many islands entirely surrounded by it, which will ultimately bring about similar conditions manifested by the complications of yesterday.

In the January *Mining and Oil Bulletin* of the Chamber of Mines and Oil of Los Angeles, J. W. Glasgow briefly describes tungsten mining at Atolia. The mineral was discovered there in 1910 by A. D. Ray. The town is a place of tents, as shown by the accompanying photograph.

On account of the burning of the Atolia mill, tungsten ore has risen throughout the United States to over \$60 per unit.

TORONTO, ONTARIO

DOME, PORCUPINE CROWN, BEAVER CONSOLIDATED.—NICKEL REFINERY.

The new ball-mill at the Dome mill, Porcupine, is in full swing, crushing 1200 tons per day. Another similar machine is to be installed. The January output was \$176,590. Recent developments include a cross-cut through 27 ft. of ore averaging \$9.60 per ton, in addition to 58 ft. of \$4.30 ore.

The annual report of the Porcupine Crown for 1915 shows a production of \$615,537, with net profits of \$299,116. The surplus on hand was \$269,977.

The Triumph Mining Co., which has taken over the Success, has encountered a shear-zone in a cross-cut at the 100-ft. level.

At the Kirkland Lake, now worked by the Beaver Consolidated, the vein with 4 to 6 in. of high-grade ore, that came into the shaft at a depth of 110 ft., persists as sinking pro-

gresses. The shaft will be sunk to 200 ft.; it is being put down for prospecting purposes, and a main shaft will be sunk at a point where it is expected that the Teck Hughes vein system will be cut.

An important development has been made at the Patterson shaft of the Adanac on the claim adjoining the Ophir, in a winze put down from the 200-ft. level. The vein, which at first was low in silver, became much richer at a depth of 265 ft., showing native silver.

At the Foster a number of stringers have been picked up in the cross-cut which is being driven to cut the Lawson-Bailey vein system.

The Seneca Superior has declared a 10% dividend and a 10% bonus, making a total of 225% on the capital.

The Dominion Reduction Co. has taken a six months' option on the Big Master, Laurentian, and H. B. 298 properties in the Maniton Lake gold area in the Lake of the Woods region. The properties, which have been closed down for many years, are now being unwatered and sampled.

In pursuance of the policy of establishing the nickel refining industry in Canada the Dominion government has made an arrangement with the International Nickel Co., which now refines most of the output of the Sudbury mines in New Jersey, under which they will construct and operate a refinery at some point on the Canadian seaboard, probably Cape Breton. Some details yet remain to be settled. The plant will be operated under Government supervision, and the British government will have the first call on the output.

The Consolidated Mining & Smelting Co. of Canada has increased its capital stock from \$7,500,000 to \$15,000,000.

THE MINING SUMMARY

The news of the week as told by our special correspondents and compiled from the local press.

ALASKA

BETHEL

(Special Correspondence.) The Canyon Creek placers yielded a good deal of gold last summer from small scale operations. In the summer freight costs from 20 to 25c. per lb., in the winter, 5c. Bear creek contributed a quantity of gold to the output from this region on the few claims that were operated. The best claims are under bond. Miners on Aralik river near Gwinhagamut, got satisfactory results. Julian and other creeks near the George river, about 200 miles from here up the Kuskokwim, are producers of coarse gold. Nuggets worth as much as \$15 and over are found. New York creek is also a producer. Candle creek near Tacotna keeps up its last summer's reputation of yielding a considerable quantity of gold. Mone creek contributes its share. One or two parties have been working on the Aniak river, but results are not known yet. Good reports are received from prospectors on other tributaries of Kuskokwim, especially from Hohohitna. More interest is taken in quartz prospecting, as some large veins containing gold, copper, and antimony have been discovered. It is reported that George J. Shoup of San Francisco is interested in eight antimony claims at the head of the Togiak river. Somewhere in the vicinity of Kwisluk river, Mr. Keeler, an old-time miner and prospector from Idaho, informed me that he has discovered a large lode of high-grade copper, lying between slate and limestone.

There seems to be no doubt that there will be great activity in auriferous lode mining on Kuskokwim in the near future, as soon as transportation facilities improve. With the bay and river charted up to the Bethel, the most difficult problems are overcome. On the gasoline schooner *Bender Brothers*, which arrived from Seattle yesterday, is apparatus for a Government wireless-station which will be established at Tacotna, with sufficient power to make connection with Seward. A wireless-station at this place certainly would be a godsend for the population on the lower Kuskowim, as we have had no mail service since the *Bender Brothers* left last spring. Letters dated June 3, 1915, at San Francisco, arrived October 8, but we hope that this matter will improve when the country develops.

Bethel, October 9, 1915

(Special Correspondence.)—Windy creek, which was discovered in the latter part of last winter, and which is about five miles south from Canyon creek, is also a tributary of the Kwisluk river. Three claims have been prospected this summer with encouraging results. Some gold was extracted from one of the claims; it is coarse, and similar to that of Canyon creek. This adds one more creek to the producing list in this district, and as there is some prospecting going on this winter, there may be some more discoveries made before spring. A new strike is reported on the Aralik river near Gwinhagamut, which is supposed to be better than any previously made in this district. Aralik River placer mines produced \$40,000 or over, so there is a good chance for some rich ground.

The boat *Bender Brothers* froze-in here this fall, and the *Abler*, according to reports, was wrecked, so there is the same old story of shortage of provision. At present writing there is no bacon, lard, butter, or potatoes in town, so it does not look very bright for the miners, who depend on the supply to

be brought up in the winter to the different camps. As mining is steadily progressing, and the gold output increases considerably, it seems that there should be some one who would take the opportunity to send in a supply of provisions, which would be sufficient at least until navigation opens in the spring, and double their investment in six months time.

The town of Bethel improves with the development of the country, several new buildings having been erected this fall. Among the most noted is the Government public school building, which was built by the Bureau of Education. W. McMillan from the Kinak school is teacher.

Bethel, November 26, 1915.

JUNEAU

Information received at Juneau from Leonard Lehlbach at New York states that the Alaska Taku mine, five miles down Gastineau channel, is practically bonded to Eastern people for nearly \$500,000.

On February 5 connection was made between 1600 and 1700 ft. in the new Ready Bullion shaft on Douglas Island, making the total depth 2450 ft. at 70'. The four-compartment shaft will be finished within two months. A 100-ft. steel head-frame and electric hoist are to be erected.

There is a surplus of labor at Treadwell, a notice being posted to this effect.

ARIZONA

COCHISE COUNTY

(Special Correspondence.)—Up to a year ago little attention had been given to that portion of the Warren mining district north-west of Bisbee, on the Escabrosa ridge at the head of Moore canyon. It was said to be out of the zone, and other than a few assessment holes sunk mostly by miners of the Warren district, little has been accomplished toward prospecting and developing the area.

The Mule Mountain Mining Co. started to sink in an abandoned shaft on its lease last September, but as gas was encountered operations were slow and uncertain. The company stopped work in the shaft until machinery could be installed. This shaft is now 50 ft. deep with a 10-in. vein of \$20 lead-silver-gold ore in the face. Several stringers of ore have been uncovered, assaying as high as 53% lead, 79 oz. silver, and \$2 gold per ton. In a drift, lead, silver, and gold, have assayed as high as that in the shaft, but in less quantity. A stringer of sulphide was found in the drift, and a winze sunk on it eight feet. The sulphide contained 0.5 to 1.5% copper, and widened from 1 to 4 in. in 8 ft. The company has installed machinery, and at present is driving a lower adit which will give a depth of about 350 ft. on the shaft workings.

The Blair and Grant property in Moore canyon is being prospected, and shows splendid indications.

The Pinole Exploration Co. holds a group of claims in this vicinity and will begin to develop them within 60 days.

Bisbee, February 8.

GILA COUNTY

Work has been stopped at the Inspiration 600-ton test-mill, which has been operating since early in 1914. The plant is to be dismantled.

The Superior & Boston is to unwater its levels below 800 ft. depth.

The Iron Cap company's shaft is to be enlarged from the

surface to 600 ft., and then deepened to 1200 ft. The output of copper ore in January was 28 carloads.

MOHAVE COUNTY

The Union Basin Mining Co. at Golconda has completed the installation of a 100-ton addition to its mill. This will bring the capacity up to 200 tons daily. Rolls, concentrators, tube-mills, and oil flotation are being used. The shaft is nearing 1000-ft. depth; sinking will continue to 1200 feet.

At Chloride a 20-room hotel is being constructed.

The Tennessee company is still sinking its main vertical shaft, four six-hour shifts being employed. Sinking will continue to the 1500-ft. level. The orebodies are larger and better at the 1200-ft. level than in the upper levels.

The Tennessee, Union Basin, and Kingman Zinc companies continue to make their regular daily shipments. Many other properties will soon be added to the shipping list.

The Golconda Consolidated Mines, operating the Gem claims at Cerbat in the Wallapai district, 12 miles north of Kingman, and the Fredonia property at Golconda, about 1 1/2 miles farther north, is about to begin driving north on the 500-ft. level of the Gem on a vein which is four feet wide of good value. The drift will be advanced 200 ft. or more to catch the downward extension of what is known as the Ayers ore-shoot, which is credited with a past production of nearly \$200,000 in the upper levels. There still remains on these levels a large tonnage of milling ore, upon which successful mill tests have recently been made, a total saving of from 85 to 87%, 80% by amalgamation. The ore extracted on the new levels will be treated in a reduction plant already on the ground, consisting of a 20-ton Nissen mill and concentrators. It is the intention of the management to increase the capacity of the plant to 50 tons daily as soon as conditions in the mines justify. It is also the plan to install at an early date a large compressor and machine-drills.

YAVAPAI COUNTY

Twelve miles south of Prescott is the Big Pine Consolidated company's property. Seven adits, No. 5 being in 1400 ft., have opened 70,000 tons of gold ore. A 100-ton mill, including rolls, tube-mill, and cyanide-plant is to be erected.

YUMA COUNTY

It is reported that for \$1,000,000 cash, San Francisco people acquired the manganese property of E. E. Schellenger at the west end of the McCoy mountains. Estimates place reserves at 50,000 tons of 70% ore. Roads are being constructed to connect with the railway between Blythe and Blythe junction.

ARKANSAS

SEARCY COUNTY

The first electric-light plant in the north Arkansas field was recently started at the Big Hurricane mine near Pindall.

The first shaft in the north Arkansas field is at the Bear Hill company's mine, five miles west of Yellville. A 250-ton mill is ready to crush the high-grade 'jack.'

CALIFORNIA

Operations in the San Joaquin Valley oilfields will for the next few weeks be confined largely to repairing the damage done by the recent wind-storms. The work of rehabilitation has already been actively commenced, and the weekly report of the State Mining Bureau clearly shows that it is going forward at the expense of proposed new work which falls considerably below the weekly average. Authentic reports of the storm damage indicate that nearly 2000 derricks were blown down, which is about 25% of the total number of producing wells in the San Joaquin valley. A small portion of the derricks were at idle or incompletd wells. February may therefore be expected to show a shortage in oil production over the entire State, amounting to possibly 40,000 bbl. per day, or

over 15% of the recent monthly totals. Derricks can probably be replaced at a cost of about \$400 each, or a total of about \$750,000, of which about one-third will be spent for labor. There seems to be but little possibility of reconstructing the derricks to avoid similar loss in the future, and operators must find such comfort as they may in the fact that such storms are unusual. Increased drilling activity is to be expected in the next few months.

AMADOR COUNTY

Following are the preliminary figures of output and costs of the Plymouth Consolidated company in January:

| | |
|-------------------------------------|----------|
| Ore milled, tons | 16,350 |
| Value of output | \$57,000 |
| Working expenses | 22,706 |
| Development charge | 7,465 |
| Depreciation and construction | 4,312 |
| Surplus | \$22,517 |
| Other capital expended | 119 |

SHASTA COUNTY

(Special Correspondence.)—Some good ore has been opened in the Bell Cow mine, on Arbuckle mountain, and arrangements have been made to place the 10-stamp mill, formerly

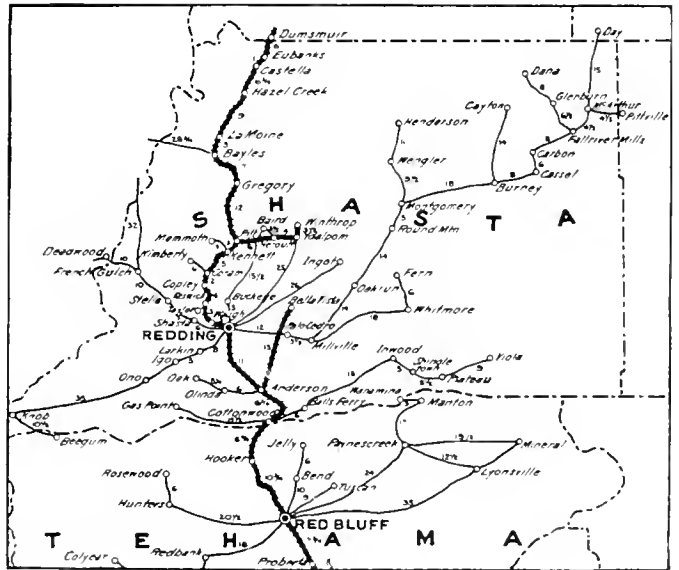

SHASTA COUNTY, CALIFORNIA.

operated at the Gambrinus, near Stella, on the property. Frank Green and associates of Ono are operating the Bell Cow.

It is reported that a rich discovery has been made in the Midas mine, at Harrison Gulch. Good ore is going from the Midas and Gold Hill workings to the 20-stamp mill. H. L. Waste is superintendent.

Arrangements have been made to work the Sulphide group of copper claims near Copper City. It lies on the east side of the Shasta copper belt, and is controlled by W. T. Casson, of Carson City, Nevada, who is operating the nearby Shasta Belmont mine.

Redding, February 7.

CALAVERAS COUNTY

(Special Correspondence.)—The Columbia Mines Co. has been operating here about a year. A two-compartment shaft has been sunk to a depth of 250 ft. on an incline of 62°. At the 100-ft. level a drift has been driven 80 ft. At the 200-ft. level a drift is in 100 ft., and cross-cutting is now being done on that level. The property is equipped with a five-stamp mill, and compressor driven by electric power, also a gasoline hoist. The mine is situated in a line between the Melones and Gold Cliff properties.

J. S. Rear of Vancouver, B. C. is president of the company, and F. M. Woods of Colorado Springs, vice-president.

Angels, February 15.

MADERA COUNTY

(Special Correspondence.)—The Kroromick Mining & Smelting Co. operating the Texas Flat and Waterloo claims, has decided to increase its capital from \$60,000 to \$250,000, for larger operations. All shares are held by Phillip Rowe and Maurice McMicken of Seattle, and H. A. Krohn of Coarse Gold, who have spent \$100,000 in development and improvement. Three new shafts are to be sunk, and the treatment-plant will be overhauled.

Coarse Gold, February 1.

SERRA COUNTY

The Gold Star and Young America lode and gravel properties near Alleghany and Forest have been consolidated by S. L. Bright of San Francisco, and A. D. Foote, L. P. Larue, W. Hague, C. F. Clinch, and A. H. Tickell of Grass Valley. The new company is called the Mugwump Mines Company.

YUBA COUNTY

On February 16 the Marysville Dredging Co. launched its No. 5 boat at Marigold on the Yuba river, 10 miles east of Marysville. The dredge is generally similar to No. 14 of the Yuba Consolidated, having 16-cu. ft. buckets. It will be entirely motor driven. The Marysville company will soon have three boats at work; No. 1 and 2 are out of commission.

COLORADO

CLEAR CREEK COUNTY

(Special Correspondence.)—Work has been resumed at the French Flag mine in Gilson gulch. The 200-ft. shaft is being unwatered. C. H. Ripley has secured a working fund of \$50,000, and extensive development is planned.—A contract has been awarded for the extension of the Wyoming Valley adit, the present objective being the French Flag mine which lies 750 ft. distant.

The Friedman lease on the Edgar mine on Bellevue mountain shows a 5-ft. shoot that averages a mill settlement of \$50 per ton in gold, silver, and lead. The mine is now capable of producing 100 tons daily.—The Boston Leasing Co., operating at the Edgar, and controlling ground below that of Friedman and associates, has followed a shoot in the 100-ft. winze that varies from 1 to 5 ft. width. Recent shipments have given \$40 per ton. The Hudson mill is treating 100 tons in three 8-hour shifts. A. H. Roller is manager.

The Jackson mill will probably pass over to J. P. Ruth within the next 30 days, the consideration being given at \$25,000.

Hawes and company, leasing at the Golden Edge mine through the Argo adit, have cut a two-foot shoot of smelting ore that is yielding \$70 per ton in gold and silver.

Shipments of mill and smelting ore are going out from the Lake mine operated under lease by the L. D. L. Co. G. K. Kimball is manager.—Shipments have been started from the Black Eagle mine on Chicago mountain. The yield is \$25 per ton.

Idaho Springs, February 5.

SAN JUAN COUNTY

The Silverton district has been little heard of lately, but this is due to the enormous fall of snow late in January, and only recently were trains able to get to the town.

SUMMIT COUNTY

At 1999 ft. depth in the Wellington mine at Breckenridge the Great Northern vein is 12 ft. wide, averaging 42% zinc.

TELLER COUNTY (CRIPPLE CREEK)

During 1915 the Doctor-Jack Pot Mining Co. shipped 14,382 tons of ore worth \$19.98 per ton. Including lessees' royalties of \$38,500, the profit was \$47,271.

IDAHO

In his report for 1915, the State mine inspector, Robert N. Bell, discusses the prosperous conditions of the industry, with special reference to the Coeur d'Alene region, the lead districts of Gilmore, Dome, and Wood River, the Seven Devils copper district, and the phosphate deposits.

CLEARWATER COUNTY

Development of the Richmond mine near Adair continues at a good rate, opening copper carbonate ore. A shipment of 150 tons averaged 8.87% copper and \$4.80 per ton in gold. When the lower level is completed reserves will be increased to 40,000 tons. A wagon-road is being constructed, but an 8000-ft. aerial tram is to be ordered.

SHOSHONE COUNTY (COEUR D'ALENE)

During January the Caledonia mill treated 3026 tons of ore, yielding 891 tons of concentrate; 548 tons of crude ore was shipped. Metal contents were 885,740 lb. lead, 133,347 oz. silver, and 79,402 lb. copper, worth a total of \$149,315. The net profit was \$100,264.

MISSOURI

JASPER COUNTY

On February 5 the A. W. C. Mining Co. sold 1000 tons of zinc-blende to the Granby Mining & Smelting Co. at \$117.50 per ton. As the concentrate assayed 63% metal, a total of \$121,000 is expected in settlement. The smelting company also purchased 500 tons from the Carmean & Squires company for about \$55,000. The A. W. C. mine is on west 7th street, Joplin. It has three mills working, and the above product was nine weeks' work. The Carmean & Squires has five mines in sheet-ground around Webb City. Its output was from two weeks' operations.

Remarkable activity is reported from the South Cartersville area. Five mills have been built since September, five others are under construction, and others are proposed. The Zinc Corporation of Missouri is the most important property.

For \$125,000, the interests of C. R. Strong in the Dick Turpin mine, west of Joplin, were purchased by Senator E. Wilkerson of Kansas. Mining is done in sheet-ground from 180 to 200 ft. deep. A new motor-driven 350-ton per shift mill is part of the equipment.

The large flow of water in the north Webb City sheet-ground district requires heavy pumping, although the mines continue to operate.

MONTANA

FERGUS COUNTY

The January clean-up of the Barnes-King Development Co. was \$53,078.

PHILLIPS COUNTY

(Special Correspondence.)—The eastern half of Montana is mostly level country and generally devoid of conspicuous topographic features. A number of small buttes rise above the plains, and here and there rise small groups of mountains. The Little Rocky mountains form such a group. They are in Phillips county, between the Missouri and Milk rivers. They are 10 miles long and 8 miles wide, the longer axis trending north-east. The highest peaks are about 6000 ft., while the surrounding country is approximately 3000 ft. above sea-level. The range is 35 miles south of the Great Northern railway, and directly south of the Fort Belknap Indian reservation. The principal mining centres are the Ruby Gulch at Zortman, the August mine at Landusky, and the Beaver Creek on Beaver creek.

The Ruby Gulch cyanide mill is in the heart of the Little Rockies. Its capacity is 600 tons per day, and it was built in 1905. Electricity is employed to operate the machinery. An adit has been driven into the mountain for a distance of about two miles, and all hauling is done on this by electric loco-

tives. The power-plant of the Ruby Gulch is situated on the bank of the Missouri river, 35 miles from the mill. One hundred and forty men are employed. Mining and milling the ore costs the low figure of 98c. per ton. The bullion is hauled to either Malta or Dodson by autos; thence to Helena. The shareholders of the Ruby Gulch mill, B. D. Phillips, B. M. Phillips, Charles Whitcomb, A. L. Smith, and W. Woods are contemplating doubling the capacity of both the power-plant and mill in the near future.

The August mill at Landusky is also working at capacity and treating about 500 tons of ore daily, assaying from \$4 to \$20 per ton.—The Beaver Creek mine, like many others in the adjacent district is producing ore in commercial quantities.

Zortman, January 25.

SILVERBOW COUNTY

At the Pennsylvania mine at Butte, where the fatal fire occurred last week, all of the victims have been found and the fire is under control. Ten horses were asphyxiated. The Anaconda company's loss will be heavy. Relatives of twenty-one men will receive \$4000 each, spread over 400 weeks, or \$3380 in a lump sum. The damage to the mine will entail a large expenditure.

The North Butte Mining Co. reports that during the last quarter of 1915 development totaled 5224 ft. The principal work was opening the Sioux Chief vein at 700 ft. Where cut it was 4 ft. wide of 5.3% copper and 2.5 oz. silver, and 13 ft. of 2.9% copper and 2 oz. silver. The Granite Mountain shaft was sunk 74 ft., and a large skip-chute cut at 3000 ft. Results generally on the Edith May, Hancock, Jessie, South and North Croesus veins was satisfactory. There was treated 123,555 tons of ore and 9.7 tons of copper precipitate, yielding 5,713,746 lb. copper, 366 oz. gold, and 256,695 oz. silver.

NEVADA

During 1915 the Nevada Industrial Insurance Commission received \$560,248. Compensation amounted to \$134,071. Nye County employers contribute 24% of the income, followed by White Pine, Esmeralda, and Washoe.

During February and March dividends amounting to \$463,050 will be paid by companies in this State, as follows: Jim Butler, \$171,802; Jumbo Extension, \$116,250; Princee Consolidated, \$25,000; Reorganized Booth, \$49,998; and Yellow Pine, \$100,000.

CLARK COUNTY

Every mine at Goodsprings is being worked either by companies or lessees; prosperity is evident on all sides. The Yellow Pine company's mill produced zinc concentrate that allowed of \$450,000 being paid in dividends last year, making \$983,008 to date. There are also three 60-ton and one 30-ton mills at work. Prospects at the Boss platinum mine are good.

HUMBOLDT COUNTY

(Special Correspondence.)—The Rochester-Packard Annex Mines Co. which was recently incorporated with W. P. Hartman, president and general manager; W. B. Moynagh, vice-president, and superintendent; Alex. Egenes, secretary and treasurer, C. J. Abrams, consulting engineer; and M. Moynagh, John E. McGovern, W. B. Borland, J. W. Kremer, and L. H. McGarrah directors, owning seven full claims between the property of the Rochester Mines Co. and the Nevada Packard company, has been developing since December 9, 1915. Two adits have been driven to cross-cut veins that assay well on the surface. The A adit will give a vertical depth of more than 900 ft. on the veins. The B adit, intended principally for prospecting purposes, is 250 ft. above the floor of the canyon, that cuts through the property. It has penetrated a 21-ft. vein of mixed quartz and rhyolite of low-milling value. The adit being continued through the rhyolite hanging wall to intersect a large vein farther west which carries high silver content, in bromide and chloride form on the surface, has cross-cut a

two-foot vein, which, according to assays at the Lovelock assay-office carries \$48.80 gold and \$28.61 silver per ton. This was a surprise to the management. It appears from its trend to be a branch or spur connecting the veins mentioned. No driving has been done on either vein, but when the objective point is reached by the adit, driving will be started on all of them. All ore extracted is being saved, and will be treated at the Nevada-Packard mill. The necessary equipment is either on the ground or in transit, and development will be pushed as rapidly as possible in order to block-out sufficient ore to justify the construction of a mill.

Rochester, February 1.

NYE COUNTY

The Nevada Cinnabar Co. at Ione is treating 50 tons of 2% quicksilver ore daily.

Last week Tonopah mines produced 8700 tons of ore worth \$181,860.

During January the Belmont made a profit of \$86,564 from 12,863 tons of ore. The Jim Butler's profit from 4682 tons was \$28,746. The Tonopah company's mill treated 7413 tons for \$27,270 profit, a large decrease. The Extension is to pay 10c. per share.

Certain ground of the MacNamara mine is to be developed from the West End workings, an agreement having been made to that effect. Good results are expected.

WHITE PINE COUNTY

In the PRESS of January 29 it was stated that tungsten was discovered in this county by Charles Gaby 17 years ago; also that G. G. Sims found hühnerite in the Eagle district 6 years ago. According to M. E. Bassett of Aurum this discovery is a re-discovery on the part of Sims, as Bassett discovered and worked the principal claims credited to Sims in 1873, with his brother. Sims did not at that time know of tungsten, but claims that it was not his fault as samples were pronounced by local assayers to contain zinc in place of tungsten. The ore carried \$50 silver, and some lead and still carries these metals.

TEXAS

BREWSTER COUNTY

(Special Correspondence.)—The old Marfa & Mariposa Mining Co., a pioneer in the production of quicksilver in this State, will re-open its properties about February 1, under the management of Alfred A. Newell who was associated with the company for several years prior to closing-down on account of the low prices of metal then prevailing.

The Study-Butte Mining Co., which recently re-opened the Big Bend quicksilver properties, has its furnace working, and reports the property is opening well.

There is some talk of other properties in the district re-opening in the near future.

Terlingua, January 25.

UTAH

BEAVER COUNTY

For some unknown reason the U. S. S. R. & M. Co. has stopped work indefinitely at Fortuna. Gold-bearing ore has been opened, but the two claims rather limit operations. The McGarry-Hodges lease on the ground has 400 tons ready for treatment at the Sheep Rock mill, five miles east.

BOXELDER COUNTY

On February 5 the Lakeview Mining Co., of Ogden, operating at Promontory, will probably pay 3c. per share, equal to \$15,000. The present output is a carload of zinc ore every other day. The mine manager, Samuel S. Arentz, has made a report for the term August 1, 1915, to January 1, 1916. Production has been from an area 200 ft. along the strike and 200 ft. on the dip, from the surface above No. 4 workings to the bottom of shallow winzes below No. 3 adit. Development

as done at other points. Ore is not confined to the upper meshale contact. Ore is exposed in the face of No. 1 adit, early 100 ft. from the portal. In about 10 weeks, when certain work is finished, the output of 800 tons per month will be increased. Lessors and sublessees have done considerable work. Generally, the orebodies are persistent, and the future is good. According to the business manager, W. A. Perkins, on July 31, 1915, 281 tons of ore returned \$26,853 net. From that date to the end of 1915 the company and lessees shipped 941 tons, giving \$117,681 net, a total of \$144,537. Dividends absorbed \$57,000, and wages, \$22,993, while other charges made a total of \$107,880. On January 1 cash on hand amounted to \$6983. The A. S. & R. Co. held an option on the property for \$625,000, but this was not completed.

A preliminary survey is under way for a five-mile narrow-gauge railway from Salina, on the Union Pacific, to the Lakeview mine.

JUAR COUNTY

The report of the Chief Consolidated Mining Co. for 1915 has been issued. The superintendent, Cecil Fitch, states that development totaled 6690 ft., down to 1800 ft. depth. Results were fair. The output was 36,412 tons of ore containing 4634 oz. gold, 493,854 oz. silver, 8,232,606 lb. lead, 5648 lb. copper, and 622,465 lb. zinc. The average gross value was \$20.55 per ton. Sampling, freight, and treatment cost \$10.50. The net profit was \$122,114. Two dividends absorbed \$88,053. Cash on hand at the beginning of 1916 was \$219,034, an increase of 22,286.

The May Day company pays 3c. per share on February 26, equal to \$24,000.

Improvements to the Utah Minerals Concentrating Co.'s plant have made a 250-ton capacity possible.

Good zinc ore is being extracted from the Bullion Beck, New Bullion, and East Tintic Development mines.

From its Homansville claims the Chief Consolidated company is to mine manganese ore which averages 12% metal.

SALT LAKE COUNTY

'A Reconnaissance of the Cottonwood-American Fork Mining Region, Utah,' is the title of U. S. Geological Survey Bulletin 626-1, by B. S. Butler and G. F. Loughlin, with notes on history and production by U. C. Heikes. A reproduction of the geologic map will appear in an early issue of the Press. The altitude of the area is from 5000 to 11,500 ft.; Alta, around which are the principal mines in Little Cottonwood canyon, is 700 ft. high. Recent glaciation is strongly evident. Heavy snowfall interferes with winter work. Snowslides are a menace since the timber was cut. Water is abundant for all purposes. Ore was first discovered in Little Cottonwood in 1864. Some early smelting was done, and a concentrating mill worked at the Emma in 1874. The Big Cottonwood district was organized in 1879, as was also the American Fork. From 1887 to 1913 inclusive, the Cottonwoods produced 21,474 oz. gold, 19,778,917 oz. silver, 7,323,726 lb. copper, and 138,477,448 lb. lead, worth a total of \$29,652,919, from 302,159 tons of ore. Large dividends were paid. In the same years American Fork yielded 12,839 oz. gold, 1,791,987 oz. silver, 194,062 lb. copper, 7,328,828 lb. lead, and 2712 lb. zinc, valued at \$3,716,918. The main types of deposits are contact, fissure, and bedded, of common origin, showing complete mineralogical gradation. At several places contact deposits pass into fissure deposits.

The South Hecla Mining Co. has issued its report for 1915. Exploration covered 222 ft. of shaft-sinking and 1353 ft. of drifting; the total is now nearly 25,000 ft. Development of ore was mostly confined to the Wedge vein. Five blocks of ground were let to lessees. Regular ore shipments commenced in August. The company and lessees produced 3478 and 1306 tons respectively, containing a total of 161 oz. gold, 144,966 oz. silver, 914,491 lb. lead, 567,842 lb. zinc, 33,151 lb. copper, and 199,905 lb. iron, yielding a profit of \$39,206. Cash on hand

amounted to \$36,524 on January 1, 1916, with \$6648 bills payable.

The North Star, South Star, Silver Star, and Lucky Star claims of 30 acres, owned by Moylan C. Fox, were purchased last week by the Emma Copper Co., which now has 69 acres. Possible litigation has been avoided by this transaction.

WASHINGTON

Mining companies operating in the northwestern territory tributary to Spokane, by March 1 will have paid \$1,146,173 in dividends for the current year, increasing the grand total of the corporations now distributing dividends to \$66,183,439. Of this amount the Coeur d'Alene concerns will have distributed \$983,750 for 1916, making the total \$51,875,896, and British Columbia will contribute \$162,423 for the year to that date, making the aggregate disbursements \$14,307,534.

STEVENS COUNTY

While the Bunker Hill & Sullivan company will soon begin shipping ore to the smelter at Northport, there is nothing in this bearing on the company's smelter-construction plans, according to word received in Spokane from Stanley A. Easton,

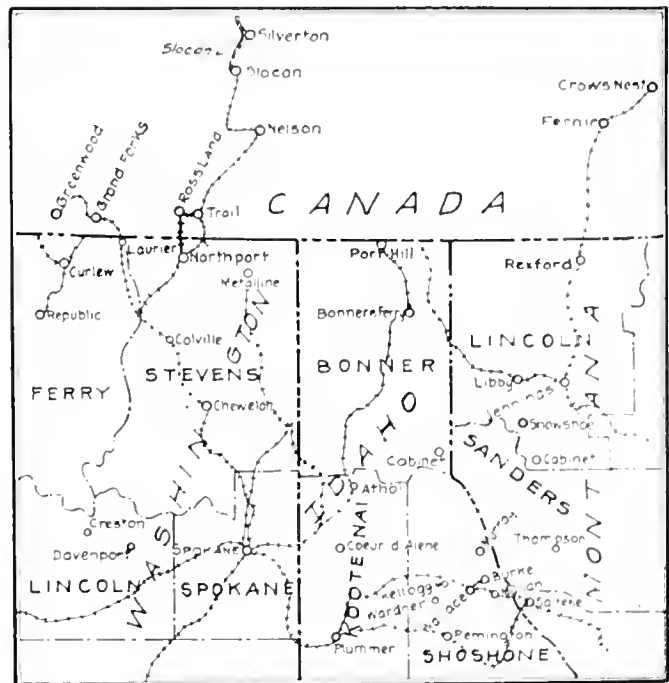

PART OF MONTANA, IDAHO, WASHINGTON, AND CANADA, SHOWING SITUATION OF THE COEUR D'ALENE REGION, THE NEW SMELTER AT NORTHPORT, AND THE SMELTERS IN BRITISH COLUMBIA.

general manager at Kellogg. The material to be sent to Northport is for fluxing purposes, high in iron and containing from 7 to 8% lead. Quantities of this grade have been dispatched to different smelters in the country for years, and it in no way violates the contract with the American Smelting & Refining Co.; in fact, it is a grade of ore this concern does not want, and is a sort of waste product that the Bunker Hill is glad to dispose of anywhere it can. At the request of the Northport Smelting company it is to be sent to the new plant.

The smelter at Northport, being constructed by the Northport Smelting & Refining Co., financed by the Hercules and the Tamarack & Custer mining companies of Idaho, will be ready to blow-in on March 1, according to H. V. Croll of Allentown, Pennsylvania, sales engineer for the Traylor Engineering Co., who was in Spokane recently after spending four months at Northport superintending construction and installation of equipment. The plant, which will represent an ex-

penditure of approximately \$500,000 when completed, is of the most modern type. It is provided with all labor-saving devices, and should prove highly efficient. Practically nothing remains of the old plant, and that part utilized in the new construction has been entirely re-built. The equipment consists of two lead furnaces 42 in. wide and 16 ft. long, with a smelting column 18 ft. high. Each has a capacity of 250 tons of ore daily, or 15,000 tons per month, and it is thought that this will be adequate to deal with the ores of the allied Coeur d'Alene properties that will supply the material. In addition, three of the six copper furnaces used in the former plant have been renovated for operation at any time, but this may not be for several months. Four Dwight-Lloyd sintering-machines have been installed, an entirely new crushing and automatic sampling-plant built, and a new charging system has been devised, including pit, cars, trackage, and other accessories. All the ore is carried by belt-conveyors. The changes in the system have necessitated a re-arrangement of the railway-tracks serving the plant, and this has caused delay in beginning operations, as the furnaces are ready for their charges as soon as the cars carrying the concentrate can be transferred to the unloading bins. The cold weather has interfered with constructing the new spurs and sidings, and it is not possible to have the track connections completed in less than 30 days. The material from the mines will reach the smelter in the shape of concentrates, both coarse and fine, together with the slimes as they come from the mills. The concentrates are crushed to particles averaging one-fourth inch, and, when mixed with the slimes, are sent to the sintering-machines. Their product is broken into smaller pieces and sent in cars to the charging-pits, where the sintered material is mixed with coke, limestone, iron, and oxidized ores, drawn from adjacent bins in which this is stored. A locomotive then is attached to the car, pushing it into the top of the charging-furnace, where it discharges its load, averaging four to five tons. The resulting lead bullion will be molded into pigs, averaging about 100 lb. each, sampled, and then loaded into railway cars for transportation to the Pennsylvania Smelting Co.'s refining plant at Carnegie, which has been taken over by the Northport company.

FERRY COUNTY

(Special Correspondence.)—The mill, machinery, and other buildings of the North Washington Power & Reduction Co. were recently sold by W. S. Bailey, trustee in bankruptcy, to R. E. Clark, of Spokane, for \$6500, to satisfy the claim of the Chicago Title & Trust Co. This property had been previously sold to the same buyer for \$25,000 but reverted on default of payments after about \$8000 had been paid.

A 225-hp. Bessemer oil-burning engine has been installed at the Surprise mine by the Republic Consolidated Mines Corporation, which expects to operate on a more extensive scale and sink to 1000-ft. depth. The shaft of the Lone Pine mine will be sunk 100 ft. to 400 ft. depth.

In the San Poil district, W. E. Malm, engineer for the Walla Walla Mining Co., operating at Keller, has finished surveys and will soon install machinery and a diamond-drill to prospect the company's property.

High-grade scheelite is reported to have been found in the Silver Leaf mine, situated $1\frac{1}{2}$ miles west of the Columbia river, in the Troy district. The property is under bond to James Keith, of Spokane, who is said to have shipped 15 tons of ore to the Granby smelter, containing about 200 oz. silver per ton. The report is confused by the statement that the smelter paid \$1 per pound as advance settlement.

Republic, February 10.

PIERCE COUNTY

The duplicated refinery at the A. S. & R. smelter at Tacoma is complete at a cost of \$750,000. Its capacity is 6000 tons of metal per month. There was no increase in the smelting capacity.

PERSONAL

WILLET G. MILLER is on his way to London.

F. W. BRADLEY is to visit Kellogg, Idaho, early in March.

A. J. EVELAND, recently at Pachuca, has gone to South America.

H. W. TURNER has been examining quicksilver deposits in Lake county.

JOHN T. REID has recently returned to Lovelock, Nevada, from New York.

W. MOTHERWELL has gone to the Santa Gertrudis mine, Pachuca, Mexico.

G. F. TRETHERWEY is now manager of the West Dome mine, Porcupine, Ontario.

FRED SEARLS and KARL HOFFMANN are accompanying W. W. Mein on his professional journey to South Africa.

R. R. LESLIE, manager of Butters Divisadero Co., is expected to arrive in San Francisco early in March.

GEORGE E. FARISH is now at Oatman, Arizona. He expects to return to New York during the first week in March.

CLAYTON L. KOHLHAAS, Michigan College of Mines, 1910, is with the Denver Rock Drill Co., at Houghton, Michigan.

ROBERT M. BETTS, manager of the Cornucopia Mines, has been examining quicksilver properties in southern Oregon.

ROBERT E. CRANSTON has been placed in charge of the gold-mining department of the Anaconda Copper Mining Co., at Butte.

C. H. SHOEMAKER, general superintendent for the Asbestos & Asbestic, Ltd., has returned to Asbestos, Quebec, from Arizona.

JAMES RICHARDS, superintendent of the Isle Royale mine, Michigan, is in Florida on an extended vacation for his health. A. H. Wohlrab is acting superintendent during Mr. Richards' absence.

W. W. MEIN sailed on February 26 by the *New Amsterdam* for London, on his way to the Rand, where he will report on some important mines.

ATKINS, KROLL & Co. have resigned the management of the Atolia Mining Co. E. C. VOORHEIS has been appointed general manager with headquarters in the Humboldt Bank building, San Francisco.

Schools and Societies

Copper companies operating in Arizona have contributed \$100,000 towards the construction of a school of mines at the State university at Tucson. There is also available \$75,000 appropriated by the last Legislature.

The MONTANA SECTION OF THE A. I. M. E. held its annual meeting at Butte on February 4. There were 49 members and guests present. The following officers were elected for the ensuing year: chairman, J. L. Bruce, manager of Butte & Superior Copper Co.; vice-chairman, W. C. Siderfin, manager W. A. Clark interests in Montana; secretary-treasurer, M. H. Gidel, assistant geologist Anaconda Copper Mining Co.; and executive committee, N. B. Braly, superintendent of mines of the North Butte Mining Co., and W. T. Burns, superintendent of electric refinery of the Boston & Montana reduction works, Great Falls. Following the banquet, a paper entitled 'Present Status of Oil Prospecting in Montana' was read by D. C. Bard, who is joint author of the paper with Chester Steele. Frederick Laist of the Anaconda company gave a talk on the metallurgy of zinc, explaining briefly the method employed by the company for the treatment of complex zinc ore from the Butte district. The secretary's report shows 177 active members in the State, an increase of 17 over that of last year.

THE METAL MARKET

METAL PRICES

San Francisco, February 25

| | |
|---|-----------|
| Antimony, cents per pound | 44 |
| Electrolytic copper, cents per pound | 27.75 |
| Molybdenum, 99% MoS ₅ , per pound | \$1.40 |
| Pig lead, cents per pound | 6.55-7.50 |
| Platinum soft metal, per ounce | \$85 |
| Platinum hard metal, 10% Iridium, per ounce | \$89 |
| Quicksilver, per flask | \$300 |
| Spelter, cents per pound | 22 |
| Tin, cents per pound | 43 |
| Zinc dust, 100-kg zinc-lined cases, cents per pound | 30 |

ORE PRICES

San Francisco, February 25

| | |
|--|--------|
| Antimony, 50% product, per unit | \$2.25 |
| Chromite, 40% and over, f.o.b. cars California, per ton | 41 |
| Magnesite, crude, per ton, f.o.b. cars California | 8 |
| Magnesite, plastic, no iron and lime, calcined, per ton | 30 |
| Magnesite, refractory, 11% iron, dead-burned, per ton | 35 |
| Manganese, 50% metal, 8% silica, per ton, f.o.b. cars, S. F. | 12 |
| Tungsten, minimum 60% WO ₃ , per unit of 20 lb. | 60-65 |

New York, February 18.

| | |
|-------------------------|--------|
| Antimony, per unit | \$2.50 |
| Tungsten, per unit | 70 |
| Manganese, 50%, per ton | 20 |

Carlisle & Company, 74 Broadway, New York, have prepared for free distribution a booklet entitled 'Tungsten, Its Properties and Uses.' It is very complete and contains extracts from the U. S. Geological Survey.

The February issue of 'The Palasapa Quarterly' (South Dakota School of Mines) is a tungsten number and worth securing.

EASTERN METAL MARKET

(By wire from New York)

February 25—Copper is quieter though strong, prompt metal is scarce. Lead is quieter, there is a good demand for zinc of choice grades.

SILVER

Below are given the average New York quotations, in cents per ounce, of fine silver.

| Date | Average week ending |
|--------------|---------------------|
| Feb. 17 | 56.62 |
| " 18 | 56.62 |
| " 19 | 56.62 |
| " 20 Sunday | 56.62 |
| " 21 | 56.75 |
| " 22 Holiday | 57.00 |
| " 23 | 57.00 |

Monthly averages.

| 1914 | 1915 | 1916 | 1914 | 1915 | 1916 | |
|------|-------|-------|-------|-------|-------|-------|
| Jan. | 57.28 | 48.85 | 56.76 | July | 54.99 | 47.52 |
| Feb. | 57.28 | 48.45 | 56.41 | Aug. | 54.25 | 47.11 |
| Mar. | 58.01 | 50.61 | 57.14 | Sept. | 52.75 | 48.77 |
| Apr. | 58.52 | 50.25 | 57.02 | Oct. | 51.12 | 49.10 |
| May | 58.21 | 49.87 | 56.79 | Nov. | 49.12 | 51.88 |
| June | 56.42 | 49.03 | 56.62 | Dec. | 49.27 | 55.31 |

The silver market continues steady. European coinage orders continue to be the chief support, though England and India have been buyers. Stocks at Bombay are lower, and Bazaar support is probably. Shipments of silver from London to India to February 2 were only one-sixth of those of last year.

On February 18, silver worth \$356,500 (say 600,000 oz.) was shipped from San Francisco to China.

COPPER

Prices of electrolytic in New York, in cents per pound.

| Date | Average week ending |
|--------------|---------------------|
| Feb. 17 | 27.45 |
| " 18 | 27.45 |
| " 19 | 27.45 |
| " 20 Sunday | 27.45 |
| " 21 | 27.45 |
| " 22 Holiday | 27.25 |
| " 23 | 27.25 |

Monthly averages.

| 1914 | 1915 | 1916 | 1914 | 1915 | 1916 | |
|------|-------|-------|-------|-------|-------|-------|
| Jan. | 14.21 | 13.60 | 24.20 | July | 12.26 | 13.99 |
| Feb. | 14.46 | 14.38 | 24.20 | Aug. | 12.24 | 15.27 |
| Mar. | 14.11 | 14.80 | 24.93 | Sept. | 12.02 | 17.89 |
| Apr. | 14.19 | 16.64 | 25.15 | Oct. | 11.10 | 17.90 |
| May | 13.97 | 18.71 | 26.16 | Nov. | 11.75 | 18.88 |
| June | 13.60 | 19.75 | 27.06 | Dec. | 12.75 | 20.67 |

Shipments of copper from the Michigan smelters by rail in

December and January totaled 10,000,000 pounds.

January output of Kennecott, Alaska, was 10,000,000 pounds.

LEAD

Lead is quoted in cents per pound, New York delivery.

| Date | Average week ending |
|--------------|---------------------|
| Feb. 17 | 6.30 |
| " 18 | 6.30 |
| " 19 | 6.30 |
| " 20 Sunday | 6.30 |
| " 21 | 6.30 |
| " 22 Holiday | 6.30 |
| " 23 | 6.30 |

Monthly averages.

| 1914 | 1915 | 1916 | 1914 | 1915 | 1916 | |
|------|------|------|------|-------|------|------|
| Jan. | 4.11 | 3.73 | 5.95 | July | 3.80 | 5.59 |
| Feb. | 4.02 | 3.83 | 5.95 | Aug. | 3.86 | 4.67 |
| Mar. | 3.94 | 4.04 | 5.95 | Sept. | 3.82 | 4.62 |
| Apr. | 3.86 | 4.21 | 5.95 | Oct. | 3.60 | 4.62 |
| May | 3.90 | 4.24 | 5.95 | Nov. | 3.68 | 5.15 |
| June | 3.90 | 5.75 | 5.95 | Dec. | 3.80 | 5.34 |

Lead ore, 80% metal, averaged \$84 per ton at Joplin, Missouri, last week.

The Hecla company, Idaho, paid 10c. per share, or \$100,000, on February 20.

QUICKSILVER

The primary market for quicksilver is San Francisco, California being the largest producer. The price is fixed in the open market, according to quantity. Prices, in dollars per flask of 75 pounds:

Week ending

| Date | Price |
|---------|-------|
| Jan. 24 | 275 |
| Feb. 2 | 295 |

Monthly averages.

| 1914 | 1915 | 1916 | 1914 | 1915 | 1916 | |
|------|-------|-------|--------|-------|-------|--------|
| Jan. | 39.25 | 51.90 | 222.00 | July | 27.50 | 95.00 |
| Feb. | 39.00 | 60.00 | 222.00 | Aug. | 26.00 | 93.75 |
| Mar. | 39.00 | 78.00 | 222.00 | Sept. | 26.25 | 91.00 |
| Apr. | 38.90 | 77.50 | 222.00 | Oct. | 25.00 | 92.90 |
| May | 39.00 | 75.00 | 222.00 | Nov. | 25.00 | 101.50 |
| June | 38.60 | 90.00 | 222.00 | Dec. | 23.10 | 123.00 |

The Nevada Cinnabar Co. recently sent 750 flasks to the East.

ZINC

Zinc is quoted as spelter, standard Western brands, New York delivery, in cents per pound.

| Date | Average week ending |
|--------------|---------------------|
| Feb. 17 | 21.00 |
| " 18 | 21.50 |
| " 19 | 21.50 |
| " 20 Sunday | 21.50 |
| " 21 | 21.50 |
| " 22 Holiday | 21.50 |
| " 23 | 21.25 |

Monthly averages.

| 1914 | 1915 | 1916 | 1914 | 1915 | 1916 | |
|------|------|-------|-------|-------|------|-------|
| Jan. | 5.14 | 6.30 | 18.21 | July | 4.75 | 20.54 |
| Feb. | 5.22 | 9.05 | 18.21 | Aug. | 4.75 | 14.17 |
| Mar. | 5.12 | 8.10 | 18.21 | Sept. | 5.16 | 14.14 |
| Apr. | 4.98 | 9.78 | 18.21 | Oct. | 4.75 | 14.05 |
| May | 4.91 | 17.03 | 18.21 | Nov. | 5.01 | 17.20 |
| June | 4.84 | 22.20 | 18.21 | Dec. | 5.40 | 16.75 |

The zinc ore market at Joplin was strong last week, the top price being \$120 per ton for 60% product. The output of the Missouri-Kansas-Oklahoma region was 7674 tons blende, 281 tons calamine, and 924 tons lead, averaging \$112, \$87, and \$84 per ton, respectively. The total value was \$973,672, and for seven weeks \$5,708,908.

TIN

Prices in New York, in cents per pound.

| Date | Average week ending |
|------|---------------------|
| Jan. | 37.85 |
| Feb. | 39.76 |
| Mar. | 38.10 |
| Apr. | 36.10 |
| May | 32.29 |
| June | 30.72 |

Tin is firm at 12.50 to 42.75 cents.

ALUMINUM

A growing scarcity of stocks and a more active demand has caused quotations to advance, and 57 to 60c. is now quoted for No. 1 virgin aluminum, 98 to 99% pure.

Antimony imports into the United States during 11 months of 1915 were 2,334,003 lb. in ore, and 14,477,162 lb. metal, compared with 1,787,922 lb. and 12,019,613 lb. in that period of 1914.

Eastern Metal Market

New York, February 18.

Conditions in the metal market are such as never before existed, especially with regard to copper. Prompt metal has sold at 29.62½c., the highest in 43 years. There is a strong and sustained demand for second-quarter deliveries, which range from 27.25 to 27.50c., March also being in good request. Conservative sellers fear that the price may go too high to be healthy, if it is not there already. Never before, however, was there such a demand to stimulate buying. London continues high and strong, and foreign stocks continue to decrease. Zinc is advancing under the stimulus of a good demand which is calling more for future positions. Foreign buying of lead is heavy, and explains an advance of \$1 per ton, despite comparative inactivity on the part of home consumers. The tin market has pursued a serene course, despite the dangers of the times. Supplies are arriving in good volume, and business has been good in the past week. Antimony is scarce and strong, the only feature being that plans have been perfected to care for the requirements of jobbers. Aluminum is again advancing because of its scarcity.

There seems to be no end to the demand for steel, and in numerous lines of products there have been further price advances. The mills are turning-down business, even when it is offered at premium prices. The total of iron and steel exports for the calendar year 1915 was 3,513,453 gross tons, compared with 1,540,574 tons in 1914, and 2,730,483 tons in 1913. Machinery exports in December, 1915, totaled \$13,228,450, against \$6,372,041 tons in the same month of 1914; and for the calendar year 1915, totaled \$134,128,862, compared with \$91,818,664 in the preceding year.

COPPER

Not since 1873—43 years ago—has copper been so high as it is today; in that year the average price was 29c. per lb. In the past week prompt electrolytic has been sold at 29.62½c., New York, and there is nothing to indicate that the top notch has been reached. The conservative element of the trade is not only wondering when the advances will cease, but is actually worried over the abnormal situation. They point out that the greater the height, the greater will be the fall, and they are afraid that men's minds may run away as well as the market. The London market for electrolytic was quoted on February 16 at £136 10s. Statistics cabled to the New York Metal Exchange give the combined stocks of Great Britain and France, as of February 15, as 8777 tons, against 9998 tons, January 31, a decrease of 1221 tons. In this market spot and near-by is difficult to obtain even when fancy premiums are offered. Most of the business continues to be in second-quarter deliveries which can be had at about 27.25c., 30 days, delivered. For prompt metal 29.62½c. appears to have been the highest figure paid, while some has been taken at 29.50c. The buying has been almost entirely of electrolytic, over which the price of Lake ranges slightly, but its quotation is nominal. For deliveries to the end of the year, 27c. has been quoted. Positions from prompt to June, range from 29.50 down to 27c. March and April electrolytic has sold at 28.50c., and May at 28c. The steady buying has been mostly on account of the manufacturers of war munitions. Industrial consumers have yet to come into the market to a considerable extent. It is stated on good authority that the largest producer of brass and copper goods is turning out its products at the rate of 2,000,000 lb. every 24 hours, and it is safe to assert that most of this is for war purposes. John D. Ryan states that the demand up to the present time has been such that the Anaconda company's product is sold ahead for a longer period than ever before. Exports, February 1 to 17,

totalled 8805 tons. Exports in January totalled 23,663 tons, against 26,193 tons in that month of 1915.

ZINC

The market has been continuously firm, with an active demand for February, March, and April metal. Seemingly there are more buyers than sellers of these positions, and this has had the effect of accentuating the demand. The London market was strong, February 16 at £99, having advanced £6 the preceding day, and lending corresponding strength to the New York market. Futures have been more active, a pleasing fact to producers, inasmuch as some of them are entirely sold out for the first quarter, and have been for some time. Second-quarter deliveries now range from 18 to 18.25c., St. Louis. Prompt metal was quoted on February 17 at 21c., New York. With all the activity the operations of the sheet galvanizers continues at low ebb, not much above 50% of capacity. John D. Ryan states that the Anaconda company's new electrolytic zinc plant is a success, and that its product has been sold for a year ahead at a profit of about \$4,000,000, and that the company is erecting a plant with a capacity of 10,000,000 lb. of zinc per year, which probably will be in operation next fall. Exports of zinc this month, including February 17, total 1806 tons. Sheet-zinc is unchanged at 24 cents.

LEAD

A strong demand from abroad, with buyers willing to pay premiums, preceded an advance of \$1 per ton, or to 6.30 per lb., New York, which was announced by the A. S. & R. Co. on February 16. Russian interests have taken large quantities, and other European countries have been good buyers as well. The strange feature of the situation is that the domestic demand has been almost dull, a phase which sellers are unable to understand. They say if domestic consumers believe they can cause the market to come down by remaining aloof from it they are doomed to disappointment, as long as the present heavy foreign demand continues. The St. Louis market is strong at 6.22½c. The indications point to still higher prices. Exports this month, including February 17, total 4109 tons.

TIN

Of this metal there is little to say, except that there has been some heavy buying in the past week, various days having seen aggregate sales of 250, 500, 600, and 800 tons. With the activity, prices advanced, but in no abnormal way. From 41.12½c., on February 9, quotations gradually went up to 42.12½c., on the 16th. An interesting circumstance is that the steamship *Bolton Castle*, which, with two other steamers, was partly destroyed by fire while lying at a Brooklyn pier this week, had but a short time previously discharged 1300 tons of tin. Supplies continue to arrive freely, despite what is now regarded as a precarious journey. Arrivals of the month, including the 16th, total 3567 tons, and there was afloat on that day 5118 tons.

ANTIMONY

Since the last report a plan has been accepted whereby jobbers in antimony can continue to do business. It provides that stocks may be carried in public warehouses in the name of the British Consul, and that these may be drawn upon in any quantity when the jobber presents to the Consul a satisfactory guarantee from his customer. The consumer must stipulate that the antimony wanted is for his own manufacturing needs, that he will not re-sell, or ship products abroad without the consent of the Consul. The price is unchanged at 43.50 to 45c., duty paid, for prompt, metal is scarce, despite some rather large recent arrivals. These, however, had been sold while afloat.

COMPANY REPORTS

NEVADA CONSOLIDATED COPPER CO

The report of the Nevada Consolidated Copper Co. for the last quarter of 1915 has been issued. The mill treated 820,157 tons of 1.59% ore, 92% from the pits, and 8% from the Ruth mine. In addition there was treated 22,927 tons from the Giroux mine. The yield was 18,287,930 lb. copper, at a cost of 7.15c. per lb. Metal was sold at 21.699c. per lb. Total net earnings were \$2,739,196. Dividends absorbed \$999,728, depreciation, \$112,724, and ore extinguishment \$8,228, leaving a surplus of \$1,511,516. Assets include metals at all points \$1,998,829, and cash \$311,129.

BUTTE & SUPERIOR COPPER CO

The last quarter's (1915) operations of this zinc producer show the following results:

| | Quarter. | Year. |
|-------------------------------------|-------------|-------------|
| Ore treated, tons | 150,150 | 522,300 |
| Recovery, per cent | 95.97 | 92.06 |
| Zinc production, pounds | 17,563,144 | 163,956,791 |
| Cost of mining and milling, per ton | \$5.13 | |
| Net income | \$3,093,798 | \$9,125,912 |
| Net per share | | \$33.92 |

The output of metal for the year was an increase of 56,128,112 pounds, net income \$7,598,814 more, and net per share \$28.71 greater. Ore reserves are approximately the same as before.

CHINO COPPER CO.

The report of Chino Copper for the last quarter of 1915 contains the following data:

| | |
|---------------------------------|-------------|
| Overburden removed, cubic yards | 823,695 |
| Ore treated, tons | 691,200 |
| Average content, per cent | 2.11 |
| Extraction, per cent | 66.92 |
| Metal output, pounds | 19,560,215 |
| Cost per pound, cents | 7.20 |
| Average price received, cents | 20.476 |
| Profit | \$2,161,716 |
| Dividends | 869,980 |
| Surplus | \$1,591,736 |

Dividends increased \$217,525, and the surplus \$688,777.

RAY CONSOLIDATED COPPER CO.

The report of Ray Consolidated for the last quarter of 1915 includes the following:

| | |
|--------------------------------|-------------|
| Ore treated, tons | 797,162 |
| Average content, per cent | 1.688 |
| Metal from all sources, pounds | 17,195,333 |
| Cost per pound, cents | 9.625 |
| Price received, cents | 20.213 |
| Profit | \$1,897,983 |
| Dividends | 777,482 |
| Surplus | \$1,001,985 |

The daily ore tonnage was 879 greater than in the previous term, and the yield was 2,260,000 lb. more. The profit was more than double. The year's total of 62,541,196 lb., was an increase of 3,496,496 pounds.

MT. MORGAN GOLD MINING CO.

This Australian company has issued its report for the half-year ended November 28, 1915. The general manager, A. A. Boyd, states that the mine was worked for 155 days, during

which time 2868 ft. of development was done, and 203,767 tons of ore extracted down to the 950-ft. level. The average was 1290 tons per day. There was also mined 98,202 tons of waste for filling stopes, silica, smelting ore, and fireclay. Reserves are estimated at 999,393 tons of high, and 1,723,364 tons of medium-grade ores.

Two blast-furnaces worked continuously, but owing to higher silica content costs increased. The plant treated 119,051 tons of ore, 18,431 tons of concentrate, 25,197 tons of pyrite ore, and 188 tons of other material, 162,867 tons in all. This yielded 9,651,400 lb. of copper, and 62,779 oz. gold. The average was 2.617% copper and \$7.70 gold per ton. The concentrator treated 83,985 tons of ore for 21,023 tons of concentrate, with 88.49% recovery of the copper, and 72.58% of the gold.

Total working costs were \$10.20 per ton. The revenue was \$3,092,000, and profit \$800,000, of which \$720,000 was paid in dividends. The surplus is \$970,000.

UTAH COPPER CO.

The report of Utah Copper for the last quarter of 1915 shows the following:

| | |
|---|-------------|
| Overburden removed, cubic yards | 1,651,860 |
| Ore treated, tons | 2,384,364 |
| Average content, per cent | 1.4694 |
| Extraction, per cent | 63.11 |
| Metal produced, pounds | 44,224,715 |
| Cost per pound, cents | 6.10 |
| Price received, cents | 21.408 |
| Profit from all sources (including Nevada Con. dividends) | \$6,919,203 |
| Dividends paid | 2,426,735 |
| Surplus | \$4,482,468 |

The output for the year was 156,207,376 lb., against 121,779,404 lb. The surplus is \$1,692,395 greater.

JIM BUTLER TONOPAH MINING CO.

The report of this Nevada company is for the year ended September 30, 1915. The general superintendent is Frederick Bradshaw of the Tonopah Belmont Development Co., who states that the period was the most profitable of any, in spite of lower-grade ore, which was mostly due to the lower price for silver.

Mine development amounted to 8569 ft., of which 4460 ft. was in the Desert Queen, and 4199 ft. in the Wandering Boy, at an average cost of \$7.482 per foot, a decrease of 42c. This work resulted in the development of 45,124 tons of new ore. Reserves are estimated at 40,319 tons, a decrease of nearly 10,000 tons, but future prospects are good. A considerable amount of construction was done at the Wandering Boy shaft. The Ophir King claims were purchased during the year for \$1750. They have an area of 92 acres.

The Belmont mill at Millers treated 48,146 tons averaging 0.301 oz. gold and 26.42 oz. silver per ton at a cost of \$5.92. The metal recovered was 13,544 oz. gold and 1,158,335 oz. silver. A new and more favorable treatment contract has been arranged.

The net revenue from all sources was \$506,086; expenditure, \$319,365; dividend No. 1, \$171,802; and cash at September 30, 1915, \$250,698. The balance at the end of the previous term was \$235,780.

Operating costs were \$10.46 per ton, a reduction of \$1.87. Mr. Pike is mine superintendent, and Mr. Robins, engineer.

The Isabella Mines Co.'s report for 1915 shows that development totaled 17,289 ft., 1590 ft. by the company, 8368 ft. by company lessees, and 7331 ft. by royalty lessees, a large increase. At 1275 ft. depth good ore is being extracted. The output was 24,698 tons of ore worth \$507,792. The company's net earnings were \$42,573, and surplus \$85,999. Lessees are operating the mill on dump ore.



EDITORIAL



T. A. RICKARD, Editor

ANNOUNCEMENT is made that the Northwest Mining Convention will meet at Spokane on March 20 and the five days thereafter.

“**C**OPPER reaches £92.” we read in *The Financial Times* of February 1. This causes a mental jar, until we realize that the London quotation, equivalent to 19.92 cents per pound, is for ‘standard’ copper, an impure brand containing about 97% metal. The retention of an obsolete term like ‘standard’ for low-grade copper seems unnecessary and objectionable.

STATISTICIANS have a hard time, when conscientious; but most of them sleep easily, having few qualms. To the real student of figures we give a warning. At the present time Mexican pesos are being brought into this country for sale as bullion and are finding their way to the mints. Again, small lots of bullion stolen from Mexican mines are being shipped to American smelters, even as far from the border as Pennsylvania. Any of these consignments of silver will vitiate the statistics of domestic silver production unless care is taken.

AT this season of the year a great deal of mining machinery is bought for immediate use. It is required for unwatering workings, for resuming work in open-cuts, for starting new enterprises. We recognize the timely interest of the subject by publishing comment and criticism of various types of machinery, endeavoring always to obtain it from unprejudiced sources, neither from the manufacturer nor from his rival, but from the mine-managers who use the machinery and are willing to give information useful to other managers. Such information is difficult to obtain for publication, although freely circulated as gossip. A great deal of mining is wasted for lack of detached criticism; it will never be possible to obtain much of it for publication, but such of it as is made carefully and fairly is of inestimable value.

IN a recent issue we referred to the Mexican branch of the Industrial Workers of the World, commonly known as the I. W. W., a socialistic, but anti-social, organization. This Mexican branch is called *La Casa Obrero Mundial*; it has become obstreperous; a general strike was threatened to begin on February 27 unless an increase in wages equivalent to 60% gold was granted. Whereupon the Government made it known through General Fredo Rodriguez, at Mexico City, that any interference with public order would be met by force. The workmen were warned against an attempt to paralyze industry by a general strike and they were advised to

make their demand in a rational manner, in which case the Government would prove not unfriendly. So far no outbreak has been reported, from which we infer that Señor Carranza has observed the Mexican rule that the first duty of the executive is to execute.

GOLD was being won by dredging in the Klondike valley during the coldest weather in January. Our worthy contemporary the *Dawson Weekly News*, in its issue of January 28, makes boast of the fact. And no wonder; it is much to the credit of all concerned, particularly Mr. Joseph W. Boyle, the manager of the dredge in question, known as No. 2 of the Canadian Klondyke Company's fleet. When the alcohol thermometer registered anywhere from 56 to 66 degrees below zero, the No. 2 was in full action, digging vigorously to a depth of 37 feet below the surface, and 32 feet under water. No artificial means is employed to keep the pond warm, the dredge is her own ice-breaker, but her interior is steam-heated. Steam-pipes warm the entire mechanism, maintaining a temperature of 60° F., or 120 degrees warmer than outdoors. The gold production of the Yukon is reported as \$4,500,000 in 1915, but if dredging can be conducted throughout the year, we may expect a healthy increase for 1916.

PAPER-MAKING is another industry affected by the War. The production of white paper from wood-pulp involves the use of bleach, or chlorine, of which Germany produces one-third of the world's consumption by the electrolysis of common salt. Bleach was worth \$28.50 per ton at New York before the War; it is now selling for more than ten times that price, namely 15 cents per pound. Most of the American supply is made at Niagara Falls, in Michigan, and Pennsylvania. Many new factories have been started to make it, but the supply is insufficient. Much of the chlorine is diverted to the manufacture of explosives; therefore the paper-makers find this chemical increasingly costly and are compelled to raise the price of white paper. Hence our newspapers are becoming yellower and tend increasingly to resemble the Hearst productions. Colors too, owing to the scarcity of dyes, also mainly a German product, are rising in price to the point of being prohibitive. Unbleached wood-pulp has risen from \$40 to \$58 per ton; bleached pulp from \$55 to \$100. The export of pulp from Norway and Sweden is subject to embargo, although some of it is allowed to go under restrictions, but in this trade as in others the scarcity of shipping renders the supply precarious. We ourselves have had to pay rising prices for the paper we use. Perhaps out

of this evil some good will arise, for instance, the cost of paper may curtail the fungoid exuberance of the Sunday editions of the daily press, which represent an enormous waste of a useful commodity. The 50, 60, 70, or 80 pages of the Sunday paper consist of 90% rubbish, and enforced thrift in the squandering of pulp and print might serve to discipline the purveyors of piffle.

FROM what we can learn, we infer that Congressional sanction is not likely to be given during this session to the creation of a commission to undertake the systematic revision of the mining law. On the contrary, it is likely that a direct blow at the extra-lateral right will be delivered, by means of Senator Smoot's bill or, more probably, by some legislation emanating from the subcommittee of the House itself. This may result not only in the killing of the extra-lateral right, but in eliminating the requirement of discovery, and in enlarging the claim-area, say, to 1500 feet square. Then the enterprising prospector will plaster the landscape with a succession of claims, to protect the dip of possible veins, which he is no longer required to discover. Thus the abrogation of the much maligned 'apex law' will serve not to promote the search of ore, but to allow of a postponement of such search pending leisurely digging and panning. Frankly, we do not like the outlook. If after all the sincere efforts made by a number of experienced engineers and enlightened lawyers we are to have this half-baked legislation, it would have been better to let the 'apex law' alone.

"So long Hetty" was one of the mottos inscribed on the banners used to decorate the streets of the mining settlement of Sutter Creek on the occasion of a recent celebration of the re-opening of Hayward's old Eureka mine. Mrs. Hetty Green, an affluent lady residing in New York, had owned this mining property unproductively for many years; in fact, it had lain idle for the time of a generation. We echo the 'So long!' and hope to see other idle owners of valuable mining property advised or compelled to end a policy of dog-in-the-manger, whereby so large a part of the public domain is alienated to no useful purpose. We congratulate the citizens of the little town in Amador county on the resumption of operations at this famous Californian mine and felicitate the community on the fact that the task of re-opening the deeper workings, closed since the fire of 1875, should be in the hands of so experienced a miner and manager as Mr. T. Walter Beam. We shall all watch the disclosure of the bottom levels and stopes with keen interest, not only to see how much of truth there is in the stories about the ore left in the mine but also to observe to what extent the latest methods of mining and milling, conjoined to the lower cost of supplies, will enable the new owners to treat veinstone that was unprofitable forty years ago. It is a fine adventure and we hope it may be rewarded abundantly. Incidentally this re-opening of the old Eureka mine draws attention to the awakening of interest in the Mother Lode region, from Sonora, in Tuolumne, to Plymouth, in Amador county.

Chinese Mining Regulations

Mining in China is the subject of an interesting article in this issue. The author, Mr. A. S. Wheeler, knows his subject well. Moreover, he is an engineer of experience in South Africa and elsewhere. While the industry has not been much developed as yet, it is a fact that at the present moment the excited metal markets of the world look to China for a large part of one metallic product, namely, antimony. Even the technology of the subject finds its best exponent in a Chinese metallurgist, Mr. C. Y. Wang. What has been done in a minor branch of mining may yet be accomplished on a larger scale, for the empire-republic dominated just now by His Excellency Yuan Shih-K'ai covers an area of 4½ million square miles, or a third more than the United States, and includes a number of mineral regions, of which it can be said that they have ore deposits of great variety. In a recent paper on 'Chinese Mining Legislation,' by Mr. William F. Collins, read before the Institution of Mining and Metallurgy, we find it set forth that the Chinese are beginning to realize that foreign mining enterprise is desirable. That idea is not so new as will be the attempt to give it effect. Like many other peoples, the Chinese would like to have the stimulus of foreign enterprise without the alienation of their domestic resources. If the old superstitions and necromancies have become less potent, there still remains a lingering dislike against the interference of the foreign 'devils.' We must look to the educated Chinese, to those who have been to Europe and America as students, and have absorbed the progressive spirit of the age; they are the natural leaders in any friendly effort to join in exploring and exploiting the mineral deposits of the Middle Kingdom. If these men will act in good faith as between their own countrymen and the foreign operator, it will be possible to obtain results satisfactory to all concerned. To be satisfactory any business venture must be mutually profitable. Any other kind of business means imposition on one side. Undoubtedly, the good example set by Russia in encouraging Anglo-American enterprise to exploit Siberia is not without effect, as Mr. Collins suggests. Again, the granting of mining rights to the Japanese in nine districts in Manchuria may be, and ought to be, followed by the ceding of similar privileges to other foreigners, under Chinese regulations, of course. Of such regulations there has been a succession, all of them giving with one hand and taking back with the other, so as to be impracticable when not clearly absurd. For instance, the regulations of 1904 granted sundry rights but required Chinese control of all mining companies and complete subjection to Chinese company law. In 1907, after the foreign ministers at Peking had made numerous representations, a new set of 74 regulations, with 73 supplementary ones, was issued. These also failed to recognize that modern large-scale mining is not performed by individuals, but by combinations in the form of companies. They included a number of impracticable conditions, some of them ludicrous. At about this time Mr. Wallace

Broad was retained as mining advisor to the Chinese. In 1914 a fresh series of rules, multitudinous and detailed, was issued by the Government. We commented upon them in our issue of June 20, 1914, and described them as the work of men unfamiliar both with the practice of mining and the legislation found practicable in other countries. We reverted to the subject in these columns again on April 17, 1915, describing the regulations as having the appearance of being drawn "with the purpose of leading to a maximum of official interference, with opportunities for graft, and a minimum of work." They failed to afford that reasonable opportunity and requisite sense of security without which capital is discouraged from speculative effort. On the other hand, as Mr. Collins points out, the government of the Malay States gives Chinese immigrants every chance to prospect and to mine, the result being that Chinese operators have done well for themselves, and for the tin-mining industry, in the Malay peninsula. The Chinese do not return the compliment. Their regulations disbar the foreign adventurer. We trust that the ministers representing the United States and England at Peking will be moved to another effort to obtain reasonable conditions and in doing so they will find an excellent guide in the eminently fair and sensible summary of the subject presented by Mr. Collins; above all, we urge upon Chinese engineers familiar with mining in this and other countries to use their goodwill in advising their own officials to a more sagacious attitude.

North Star-Empire Compromise

It gives us great pleasure to state that the final negotiations for a settlement of the apex suit between the North Star and Empire mines at Grass Valley have been concluded amicably. As our readers are aware, suit was brought by the North Star Mines Company against its neighbor, the Empire Mines & Investment Company, in June last. Three points of difference had arisen, namely, the right of a junior location to claim extra-lateral rights beneath a senior townsite location, the question as to what extra-lateral rights accrued to a claim having broken end-lines, and finally the geologic continuity of a rich vein uncovered by the bottom workings in both mines. This vein, called 'X' by the North Star and 'Pennsylvania' by the Empire, has been cut on the 63rd level (2500 feet vertically below the surface) in the North Star and on the 46th level (2000 feet deep vertically) in the Empire mine. Sufficient exploratory work has been done in both mines to prove the great value of the ground in dispute, it being conceded that it covers at least \$2,000,000 worth of ore. At an early stage it became evident that adjudication of the controversy would involve the decipherment of many intricate problems in structural geology and the settling of several obscure legal technicalities. Fortunately, the good sense of both managements was fortified by the sagacious advice of the attorneys and experts retained by the two companies. The final basis of settlement is an equal

division of disputed territory, the different areas being weighted in accordance with the various geological and legal factors pertaining to each. Undoubtedly the experience of the Pennsylvania-W. Y. O. D. case served to warn both parties against proceeding to the arbitrament of the courts, for it had been demonstrated in that case, as in others, that the invoking of the extra-lateral right leads to unsuspected complexities. By the settlement the North Star can stope the disputed vein for 750 feet above the 63rd level, several thousand feet south of the main shaft, for 1000 feet north, and indefinitely in depth south of this limit, while the Empire retains the right to mine on the dip north of the point mentioned, within the major length of the Pennsylvania claim. In short, both mines are given a great extension of life and are saved from the expense, anxiety, and uncertainty arising from a protracted litigation. The credit for this honorable consummation is due to Messrs. Curtis H. Lindley and William E. Colby on the one side and Mr. W. H. Dixon on the other, while among the geological specialists much is owing to Messrs. Fred Searls, Jr., and Ross E. Browne, particularly, if we may say so, to the distinguished veteran. Of course, no man can foresee what is contained in the areas apportioned to the two companies: at best, each receives a pig in a poke, but they are taking equal chances and making an equally sagacious compromise with chance. Each becomes assured of a fair share of profit from the disputed territory, instead of running the risk of losing the whole of that share. The example set by them is one that we hope will be followed by other adjoining proprietaries, for we feel assured that it is to the benefit of the mining industry.

The Psychology of Flotation

Any attempt to understand the scanty and contradictory literature of the flotation process is bound to be unsuccessful without the help of some knowledge of those personal equations that have rendered the subject so perplexing to the later student. Credit, for example, was begrudged to the Elmore brothers for their early work at the Glasdir mine, in Wales, in 1898, because it was known that they had carried forward experiments previously started by the late George Robson, in 1894, but it is a fact that Robson devised no workable process, while the Elmores did. Again, the latter placed their Australian rights under option in 1902 to Messrs. John Ballot and W. W. Webster, by whom Messrs. H. L. Sulman and H. F. K. Picard were employed as metallurgists. The option was not exercised, the group that declined it organized the Minerals Separation company and proceeded to exploit a method of their own. Whereupon, not unnaturally, there were heart-burnings and ill-feelings, culminating in the lawsuit of 1907, which decided nothing, but left a lot of acid in the freely flowing pulp of competition. Later came the litigations and rivalries of the various processes in Australia, leading to many queer doings, such as the surreptitious addition of oil to operations in which it was not supposed to be

present, and the dropping of scrap-iron into the agitators and sumps of the mill just to prove that the process in use was not as good as the other fellow's. Real progress was made by Minerals Separation when that company engaged Mr. T. J. Hoover as its general manager in 1906, but regrettable misunderstandings ensued when he resigned in 1910. The publication of his book on flotation, two years later, increased the surface tension. Shortly afterward, Mr. J. M. Hyde, who had been in the employ of Minerals Separation for one year, also resigned and proceeded to Montana, where he erected a flotation plant at the Butte & Superior mine during 1911, in disregard of the Minerals Separation patents. This led to the first important American suit for alleged infringement and at the same time marked the beginning of a revolution in the wet metallurgy of the base metals in the United States. Again the irony of fate came into play when, in 1914, Mr. J. M. Callow patented and introduced the pneumatic cell, with its porous bottom, the idea of which, unknown to him, had been patented for Minerals Separation by Mr. Hoover in England in 1910. This device for frothing was adopted by the Miami Copper Company in 1914 and provoked the second important litigation, it being claimed by the Minerals Separation company that the process at Miami is an infringement on certain of their patents, while the users of the Callow cell assert that it involves a procedure and a process radically different from the ordinary frothing method by mechanical agitation. Attempts were made to obviate litigation, but a lack of concession prevented a compromise. The royalties asked are not particularly excessive, but the forms of contract provoke natural resentment. The Miami opposition represents not that company alone, but a large group of copper enterprises, notably those directed by Mr. D. C. Jackling and his associates.

No application of the bubble-levitation phase of flotation to the concentration of ore was made in the United States until long after the Minerals Separation basic patent was registered. The patent was obtained in 1905, but the first introduction of the process was not made until 1912. Over six years elapsed. Yet it is claimed by Minerals Separation that "if the directions of the patent are followed, the operation of the process is inevitable." Many years of trial and experimentation were required before flotation became a practicable process in this country. It is claimed that the Jackling companies made successful application of the process by aid of their own research and persistent effort. Moreover, it is a notable fact that up to 1911 the Minerals Separation metallurgists thought chalcocite could not be treated by flotation, and said so. In Mr. Hyde's report of January 8, 1911, given as an exhibit by Minerals Separation in their suit against Hyde, it is stated that the tests made in the company's London laboratory proved that "the copper ores of a good part of the South-west and also of at least a portion of the Utah region contain chalcocite, which is not floatable by any of the methods so far tested." This opinion epitomizes the experience

gained up to that time in the London laboratory of the Minerals Separation company. Even in the 1914 edition of his book, 'Concentrating Ores by Flotation,' Mr. Hoover mentions the presence of bornite and chalcocite as likely to limit the successful operation of the process. It is evident, therefore, that the patentees did not bring any metallurgical revelation to those exploiting the big deposits of disseminated copper in Utah, Nevada, Arizona, and New Mexico. We know now that chalcocite is easier to float than pyrite, and on this fact an enormous metallurgical development is based. It is fair to add that at a later date the representatives of Minerals Separation learned that chalcocite was amenable and prevailed upon the Anaconda and Inspiration managements to try the process, to the gain of all concerned. Who first demonstrated that chalcocite can be concentrated by froth, we do not know. Whoever he was, he deserves grateful remembrance.

Another factor tending to confuse the understanding of the relative values of the various patents is worthy of mention. Experiments in court, and elsewhere, have been used to prove that this or that patent will produce certain effects when the description of the patent is followed. As a matter of fact the result of the experiment depends largely upon the manipulation, performed usually by an operator who knows a great deal not disclosed at the time the patent-description was written. Moreover, the improvement in apparatus facilitates the obtaining of results not contemplated by the followers of the prior art. In short, by aid of Herodotus and a slide machine the expert in a court-room can produce performances that will perplex a philosopher, and a judge. Thus undoubtedly the dexterity of clever technicians and the animus against Minerals Separation have combined to glorify the Everson patent and to credit the lady in Colorado with the discovery of a workable process. In the same manner, the instructions of Aléide Froment have been misapplied in such a way as to rob his contribution to the subject of its true significance. To us Froment appears as the connecting link, psychological if not metallurgical, between the Elmore brothers and Messrs. Sulman and Picard.

Another problem is presented by the claims to originality made after the event, when the importance of priority has sharpened the imagination. Much of the misunderstanding of facts is quite unintentional and is therefore most difficult to distinguish from calculated misrepresentation. Prejudice has raised a fog through which it is difficult to see. We sympathize with the judges, having read much of the testimony submitted to them. Indeed, the technology of flotation has suffered greatly from the fact that the litigation has dominated it almost from the first. This has been supplemented by personal vendettas and factional fighting of a bitter kind causing many to see red rather than to see straight. In consequence, the literature of the subject is deeply vitiated by the distortion of scientific truth, rendering it most difficult for the student to extract the essential truth.

The Flotation Process—I: Physics

By T. A. Rickard

IN a recent reminiscence my friend Ben Stanley Revett has recorded¹ how he bet "a bottle of bubbles" with that peripatetic philosopher Thomas F. Criley, the partner of Carrie Jane Everson in an oil process of concentration whereby the valuable sulphides were made to float above the worthless gangue in a pulp of crushed ore. Mr. Revett says that he bet his bubbles against Criley's, but we suspect that in saying so he was interpreting the prior art in terms of latter-day metallurgy, for it is doubtful whether any of the persons concerned in that early experiment at Baker City, Oregon, had a clear understanding of the function of the bubbles in assisting the oil to give buoyancy to the sulphides. However, in staking his bubbles of carbon dioxide dissolved under pressure in the vintage of Champagne against the performance predicated by Criley, Mr. Revett must be credited with successful anticipation, for 27 years after the incident we know that the key to the flotation process is to be found not in the oil, the acid, or the apparatus, but in the bubbles.

The man who understands the physics of a soap bubble has mastered the chief mystery of flotation. The small boy, who, as pictured by Millais, watches the birth, ascent, and bursting of the iridescent sphere of his own making, is the type of our modern metallurgist who makes the multitudinous bubbles constituting a froth and then wonders to what laws of physics this filmy product owes its existence.

To put it briefly, the boy, having dissolved soap in water, holds a little of it in the bowl of his clay pipe while he blows through the stem. The soapy water forms a film that is distended by the boy's warm breath into a lovely sphere, which is lighter than the surrounding air and therefore rises, while the sunshine undergoes refraction into the colors of the spectrum. When the boy blows through his pipe into pure water, he makes bubbles likewise, but they break instantly. It is the soap that lengthens their life. In the language of physics we say that high 'surface tension' causes the pure-water bubbles to burst immediately, while the addition of soap introduces a contaminant that lowers the tension so as to enable the bubbles to last longer.

The basic factor in the making of bubbles is surface tension. This is the force that causes the surface of a liquid to resist rupture. The particles at the surface have a greater coherence than the similar particles within the body of the liquid. In other words, each molecule within the interior of the liquid may be pic-

tured as surrounded by molecules like itself in being attracted toward each other equally in all directions; while the molecules at the free surface of the liquid are attracted only by those internal to themselves, the result being to constrict the free surface to the least area. In consequence, the surface acts as if it were elastic. Hence the attachment of water to the sides of a tube and the drawing of that water upward—which is called 'capillarity' because it is most marked in a tube as small as *capillus*, a hair.

Numerous manifestations of surface tension on water could be cited. Fill a tumbler a little more than full and the water will have a convex surface, indicating that there is some force at work to prevent the water from spilling. Note the cohesion between two plates that have been wetted. Dip a camel's hair brush into water and the hairs cling together; immerse the wet brush in the water and the hairs separate. Watch the formation of a drop of water and note that it behaves as if enveloped by a stretched membrane. Water-spiders can be seen running over the surface of a pond in summer, as small boys run over a pond covered with ice in winter. The ice bends under their weight without breaking; so also the spider² makes a visible dimple without wetting his feet. The surface is not ruptured.

The force of surface tension has been measured by ascertaining the weight that can be suspended from a film of water in air.³ It has been stated as $3\frac{1}{4}$ grains per inch⁴ or 81 dynes per centimetre.⁵ The most recent determination is that of Theodore W. Richards and Leslie B. Coombs,⁶ who found it to be 72.62 dynes per centimetre at 20°C. Many disturbing factors enter into the measurement of this force, so that divers figures, ranging from 70.6 to 81, have been announced at different times.

Surface tension differs as between various liquids and fluids in contact; for example, the tension separating mercury from water amounts to 418 dynes per centimetre, while that separating olive oil from air is only 36.9 dynes. A drop of pure water will spread over the surface of pure mercury as oil will spread over water. The surface tension of an oil-water surface is only 14, as compared with the 73 of an air-water surface at a temperature of 18°C.⁷ While the film of oil on water

²In New England the boys call them 'skaters.'

³'A Text-Book of the Principles of Physics.' By Alfred Daniell, 1911.

⁴C. V. Boys in 'Soap Bubbles.'

⁵Clerk Maxwell in the *Encyclopædia Britannica*, under 'Capillarity.'

⁶'The Surface Tension of Water, Alcohols, etc.' *Jour. Amer. Chem. Soc.*, July 1915.

⁷'A Text-Book of Physics.' By J. H. Poynting and J. J. Thomson, 1913.

*This article was presented as a paper at the March (1916) meeting of the Canadian Mining Institute.

¹*Mining and Scientific Press*, October 16, 1915.

may be only one molecule thick, or one twenty five millionth of an inch, it will suffice to reduce the effective pull of the water surface from 73 to 43. This latter figure represents the effective surface tension of water modified by oil as used in flotation. It is the main factor in the formation and persistence of a bubble. Heat lowers the surface tension of water. Place powdered sulphur on the surface of the water on a horizontal plate of clean metal; apply heat locally; the sulphur is pulled away by the cold liquid as against the feebler tension of the warmer liquid.

This elastic force at the surface of a liquid tends to draw it into the most compact form. That is why a drop assumes the form of a sphere, in which shape it presents the smallest surface in relation to its volume. Surface tension is a contractile force. This is shown in



FIG. 1.

a simple way by blowing a soap bubble on the large end of a pipe and then holding the other end of the pipe to a candle, when the air escaping from the shrinking bag of the bubble extinguishes the flame, as in Fig. 1.⁸ When water is spilled on a stove, it assumes a globular form and dances on the hot iron until it flashes into steam. When water is sprinkled on a dusty floor, the dust forms a layer upon the drop of water, which draws itself together into rolling spherules. The smallest drops are the most nearly round; in the larger ones the weight causes a flattening, because gravity overcomes the elasticity of the surface film. That is shown even more clearly in the case of drops of mercury, and by the beads of gold on an assayer's cupel.

This contractile force at the surface, whereby a portion of liquid gathers itself together into spherical form, explains why the pure-water bubble bursts so readily. The high tension shatters it. It does not burst explosively, by expansion of the gas within the envelope, but by lateral displacement of the substance of the elastic film. It collapses because the surface tension draws it together. To prevent such immediate collapse it is necessary to lessen the tension, that is, diminish the contractile force in the elastic membrane constituting the film of the bubble. This can be done by introducing an impurity or contaminant, which lowers the

surface tension, that is, diminishes the contractibility of the bubble-film. Water has the highest surface tension of any common liquid except mercury, so that the addition of another liquid usually lowers its surface tension.

Oil in emulsion and organic substances in solution can be used for this purpose. Soap will have the same effect, and that is why a soap bubble lasts longer than a pure-water bubble, the film of the former consisting of water having some soap in solution. When water has been modified by such a contaminant, the components of the film can so dispose themselves that the superficial forces will be the same everywhere, that is, tend to remain in equilibrium, including the force of gravity, which otherwise would pull the film apart.

When two bubbles come in contact they tend to coalesce because the two of them have an aggregate area greater than that required to include the same amount of air within a single bubble. In pure water the bubbles coalesce with a violence that is mutually destructive. Even when a survivor is left, the violence of coalescence of such bubbles in a pulp unhorses any mineral particles that may be riding the bubbles. When, however, the water is modified by oil, the contractile force of surface tension is diminished, the bubbles are less fragile, and they survive long enough to perform their metallurgical duty of buoying the metallic particles to the surface of the liquid pulp. In practice the 'modification' of the water is effected by emulsification or minute subdivision (as in a mayonnaise) of an insoluble oil, such as cotton-seed and oleic; or it may be done by means of a soluble oil or derivative, such as cresol and amyl acetate.

The presence of a contaminant in water may also affect its viscosity or internal friction, whereby it offers resistance to a change of shape. This strengthens the film of a bubble generated in such water. Moreover, it has been asserted⁹ that a concentration of the contaminant occurs in the surface of a liquid, causing the viscosity to be highly magnified as compared with the body of the liquid. It is also known that the films made of any definite liquid are of the same strength, irrespective of their thinness; so that the attenuation of the skin of a bubble does not decrease its strength. This again follows from one of the most remarkable properties of a bubble: the ability, within small limits, of adjusting its tension to the load.¹⁰ Briefly, the tension at the surface of a contaminated liquid is able to adjust itself within fairly wide limits. Thus a film of such a liquid can remain in equilibrium when a film of pure liquid¹¹ would have to break.

⁸Samuel S. Sadtler in *Minerals Separation* v. Miami case.

¹⁰'Thermodynamics,' by Willard Gibbs. Page 313. "In a thick film, the increase of tension with the extension, which is necessary for its stability with respect to extension, is connected with an excess of soap (or some one of its components) at the surface as compared with the interior of the film."

¹¹In a chemically pure liquid it is impossible to form froth or multiple bubbling. Some differentiation of the components of a liquid is required to make a film.

⁸C. V. Boys in 'Soap Bubbles,' page 49.

In his book T. J. Hoover¹² states how the presence of a mere trace of saponine will kill the froth in the flotation cell. He does not explain why. It happens that saponine, which can be dissolved out of horse-chestnuts, is an aid to the blowing of big bubbles. But they are weak and tender. Why? Because saponine *increases* the tension.¹³ When a saponine bubble is brought into contact with a soap bubble, the former contracts and blows air into the soap bubble. Rayleigh proved that the tension of the soap-film is only two-thirds of that blown from a saponine solution of equal strength. One part of saponine in 100,000 parts of water will suffice to make a liberal froth. But the bubbles are flimsy. They are so fragile as to render them of no use as carriers of mineral. Hence they spoil the normal working of a flotation-cell, in which it is necessary to employ a contaminant that lowers the surface tension so as to yield bubbles that are both persistent and sufficiently robust to buoy mineral particles.

In approaching the rationale of the process under discussion it may now be assumed that we are dealing with a pulp consisting of ore and water, modified by oil, the ore having been crushed sufficiently to separate the metallic sulphides from the associated gangue in a pulp consisting of minute particles of each. In ordinary water-concentration the lower specific gravity of the gangue permits the mill-man to wash it away from the heavier metallic sulphides, but in the flotation process this action is reversed, the metallic particles being lifted above, and away from the gangue particles. Apparently, it is a metallurgical anomaly.¹⁴

To this crushed ore we have added oil. The oil serves as a contaminant that lowers the surface tension; also it augments the viscosity of the liquid. These two effects unite in facilitating the formation of strong and persistent bubbles. The necessary air is introduced by agitation or by direct injection. Sea-weed contaminates sea-water and makes foam in the breakers, as oil makes froth in fresh water that is agitated.

Air has a marked adhesiveness for metallic surfaces: this attachment is supposed to be enhanced by the presence of oil or grease on the metallic surface. In other words, the metallic surface, such as that of a sulphide mineral, when in the presence of both oil and water, will exhibit a preference for the oil. Hence the sulphide is not wetted. This characteristic is less marked on the part of the heavy silicates, such as rhodonite or garnet, and still less evident in the case of the lighter siliceous minerals, such as quartz and orthoclase.¹⁵ The addition of acid lessens the oil attachment to the gangue particles without decreasing the selectiveness of the oil and the air for the sulphide particles.

Thus we can understand why the bubbles attach themselves to the metallic particles and buoy them to the top, while ignoring the gangue particles, which sink to the bottom of the vessel in which the pulp is undergoing stirring or agitation. This preference of air for metals and metallic surfaces must be emphasized. It is the decisive factor in the process of flotation. Most minerals when pulverized, and then sprinkled on water, will float, particularly if they are in flakes or plates, as gold often is and as minerals with a highly developed cleavage usually are. Such flotation is due to air, which forms a discontinuous film under the mineral particles. Mickle proved this by taking a magnetic mineral, like pyrrhotite, and pulling it out of the water by a magnet, when it could be seen that the water was dragged up with the mineral. These minerals float for the same reason as an ungreased needle will float, namely, the resistance to rupture of the surface of the water and the aid of the air attached. It used to be supposed that the needle must be greased in order that it may float. That idea, like the general exaggeration of oil as a factor in flotation, has been disproved by experiment.

If, to water in which mineral dust is floating, an addition of alcohol or caustic soda be made, or even the vapor of alcohol be allowed to play on the surface of the water, the mineral particles will sink.¹⁶ The contamination of the water has decreased its surface tension.

The bubbles collect the metallic particles, that is agreed; but whether the selection is dependent upon the previous oiling is a disputed point. Apparently the adhesiveness of air for metallic surfaces is greater than that of oil, and it would appear probable that in the flotation process the first phenomenon suffices without the aid of the second. It used to be an accepted canon of flotation that the oil coated the metallic particles, which therefore were not 'wetted' and did not sink, while the gangue particles were not oiled and therefore were wetted, especially in acidulated water, so that they sank. Testimony has been given by a keen observer that "the distribution of the oil in the concentrate and the gangue is entirely fortuitous."¹⁷ It is even asserted now that instead of the oil residing with the metallic particles exclusively, and leaving the gangue untouched, it is distributed throughout the mixture. When the larger proportions of oil were employed, it is likely that such promiscuous oiling of all the particles of the pulp did take place, but now that the quantity has been reduced to a proportion so small that the presence of oil on the concentrate is not discernible by the senses, we may assume a preference for the metallic particles in accordance with laboratory observation. This appears to be confirmed by experiments showing that in the case of specific minerals, such as chalcocite, it is necessary to

¹²'Concentrating Ores by Flotation.' Page 99, Second Edition.

¹³'Soap Bubbles.' By C. V. Boys. Page 115.

¹⁴Mr. Ingalls has called it 'concentration upside down'; Mr. Norris has called it a 'paradox.'

¹⁵Kenneth A. Mickle. Proceedings of the Royal Society of Victoria. Vol. XXIV, part 2, 1911.

¹⁶*Ibid.*

¹⁷Bertram Blount, testifying for Minerals Separation in the Elmore appeal before the Privy Council. I might add that 'fortuitous' is a word that describes other things in the history of flotation besides the oiling.

oil the mineral in order to lift it by an air bubble.¹⁸

When using the, at present, minimum quantity of oil—say, one third of a pound per ton of ore—it would appear that the oil forms a coating of microscopic thinness upon the metallic particles. The minimum thickness is the thickness of a molecule.¹⁹

Metallic surfaces have a selective adhesion for air and for oil, as we have seen. Therefore the molecular forces of the oil and of the metallic surfaces may be supposed to unite in attracting the bubbles. What the nature of those forces may be is yet a matter of conjecture, although the idea that they are electro-static is suggested by the fact, among others, that the metallic sulphides most amenable to flotation are good conductors of electricity.²⁰

The foregoing statement of physical principles applies more particularly to the frothing method. The history of the 'prior art,' as it is called in patent litigation, shows that the first stage of the flotation process as now in vogue was performed by the use of a large proportion of thick oil. This is typified by the bulk-oil method of the Elmore brothers. It depends upon the lower specific gravity of oil as compared with water, so that when mixed in a pulp of crushed ore the oil rises to the top, dragging the metallic sulphides with it. This also was explained formerly as due mainly to the selective adhesiveness of oil for metallic surfaces, which prevents them from being wetted, while the lack of a similar affinity on the part of the gangue particles enables them to be so wetted as to cause them to sink to the bottom. All of this is measurably true, but the underlying fact seems to be that an excess of viscous oil causes the oiled particles to adhere or stick together so that they are rafted to the top. It is probable that when thus collected in groups they are more readily floated on account of their ability to hold more oil, as compared with individual particles, because the oil fills the spaces between the members of a group.

The lighter oils have a specific gravity ranging from 0.8 to 0.95, as compared with the 1.0 of water, so that the margin for flotation is small. For instance, in the case of a mixture of an oil having a specific gravity of 0.9 and of zinc-blende, having a specific gravity of 4, it is necessary to use 6.7 parts by weight of oil to one part by weight of blende in order that the mixture may have a specific gravity equal to that of water. Thus an ore containing 20% blende, or 400 lb. per ton, would require the use of over 2680 lb. of oil in order to float all the blende in the ore.

In true bulk-oil flotation, which, as a matter of fact, was rarely performed, the phenomenon of surface tension does not play a prominent part. It is mainly a question of raising a mineral heavier than water by aid

of a liquid lighter than, and not soluble in, water. The emulsification of the oil was carefully avoided by Elmore. In the later phases of flotation, in which the proportion of oil becomes steadily less, it is aimed to emulsify the oil and air. The oil produces a 'micro-emulsion of air,' as Leverrier expressed it. Thus the air is thoroughly distributed in the pulp and the oil is brought into intimate mixture with the water, which is thereby modified and prepared for the making of persistent bubbles.

HEATED CYANIDE SOLUTIONS are of considerable benefit on the silver ores of Tonopah and other places, but E. A. Wright, in a paper read before the Institution of Mining and Metallurgy, came to the following conclusions: (1) The effect of heating cyanide solutions is of very doubtful benefit; the extraction may be increased for a short period, but this is more than compensated by the increased cyanide consumption and the subsequent decrease in the rate of dissolution of gold. (2) Oxidizing agents (H_2O_2 excepted) are apparently of no value, and may even exercise a deleterious effect on the extraction. (3) The addition of oxygen in a more active form, either as hydrogen peroxide or by means of heated air, increases the solvent activity of cyanide solutions in a very pronounced manner. The author stated that his experiments were by no means complete, and that considerably more work is needed before the results can be established as absolutely definite. The work, however, occupied a considerable length of time, as all the apparatus had to be made and fitted together before any work was possible, and several breakdowns and failures were experienced. The results are submitted to the Institution in the hope that if the matter proves of sufficient interest others who may have the opportunity will carry on these investigations. The effect of different temperatures of the air-blast, the comparative times required by hot and cold air agitation to effect, say, a 98% extraction, the possibilities resulting from the use of ozone, are matters which might be investigated with profit. The results obtained by the author undeniably point to the probability of a better extraction, and in any case to the certainty of a more rapid extraction by the employment of heated air. The advantage of this is apparent when economy of space or plant is a matter for shareholders' consideration, and in conclusion it may be pointed out that the expense of testing the air is merely nominal, and the waste heat from boilers, etc., would readily lend itself to this purpose. In his paper the author does not mention the results at Tonopah, nor the notes published from there, as have appeared in the Press from time to time. In the cyanide plants of this silver-producing centre, heated solutions are of considerable benefit. Both live and exhaust steam are used for the purpose. At the mortar-boxes the temperature is from 60 to 70° F., this being increased up to 120° in the agitators, the pulp being warm throughout its treatment. Extraction is increased by 2%. The cost of heating may be as high as 30c. per ton, but the better recovery pays for this.

¹⁸Experiments of B. H. Dosenbach in the Minerals Separation v. Miami suit, at Wilmington, 1915.

¹⁹'Oil Films on Water and on Mercury.' By Henri Devaux. *M. & S. P.*, July 31, 1915, page 156.

²⁰'The Electrical Theory of Flotation.' By Thomas M. Bains, Jr. *M. & S. P.*, November 27 and December 11, 1915.

Metalliferous Mines of Hunan

By A. S. Wheeler

INTRODUCTION. *The province of Hunan in China is endowed with a variety of mineral deposits. With the exception of the Shui-ko-shan property, the mines are practically all worked in primitive Chinese fashion which has been practised without material alteration for centuries. A Chinese mine may be described as a ragged hole in the ground off which numerous irregular excavations have been made, following the ore and working it out wherever found in sufficient quantity.

The result is a sort of bewildering rabbit-warren of workings, usually none too safe, up and down which one clambers on ladders and timbers affording a slippery and precarious footing or grasp. Development work is rarely undertaken, so that there is no reserve of ore to tide over a rainy day; hence when a poor zone is encountered the mine has to be closed-down for lack of funds. Practically all work is done on contract, whether mining, hoisting, pumping, or ore treatment. The method of working and the control and direction of the operations is left entirely to the workmen; it is extremely rare to find a manager who will venture underground or who has the knowledge and experience to enable him to assume technical control. The mining is let to one or more underground contractors and paid for at so much per picul of picked ore; they engage the miners, providing them with the necessary tools and explosives. For the latter purpose native-made black powder is used, the fuse being of straw and touch-paper with powder filling. For illumination, flare-lamps are employed; these consist of a shallow iron saucer suspended at the end of an iron rod and filled with vegetal oil in which are immersed wicks made of wood-pith. As ventilation is allowed to take care of itself, the underground atmosphere resulting from the fumes of the explosive, and the smoke of the lamps, can be better imagined than described.

The pumps are quite ingenious. They are made of bamboos 5 inches in diameter from which the inside rings have been cut, thus forming the pump-barrel. The rod is a long strip of bamboo to the end of which is fixed a disc of hide of the same diameter as the bore of the bamboo. This acts as a flap-valve and is seated or supported on a smaller disc of wood. A cross-piece fixed to the other end of the strip serves as a handle. The coolie actuates the plunger, and the discharge end of the bamboo delivers the water into a small cistern or sump on which he sits. The suction of a similar pump above him draws from this cistern and raises the water to the one next above, and so on. The method is crude but it answers admirably for comparatively shallow workings, as labor is cheap and the capital outlay a minimum.

The broken ore is usually picked over roughly underground to eliminate waste and is carried or dragged out of the mine in basket-loads of 80 lb. weight or more. In the narrow tortuous workings of the average Chinese mine this work is extremely arduous. The ore is then cobbled and sorted before being subjected to treatment for its valuable content.

ANTIMONY. This is by far the most important mineral product of the province; in fact, China is the world's chief producer of antimony and the bulk of the output comes from Hunan. It is marketed in various forms.

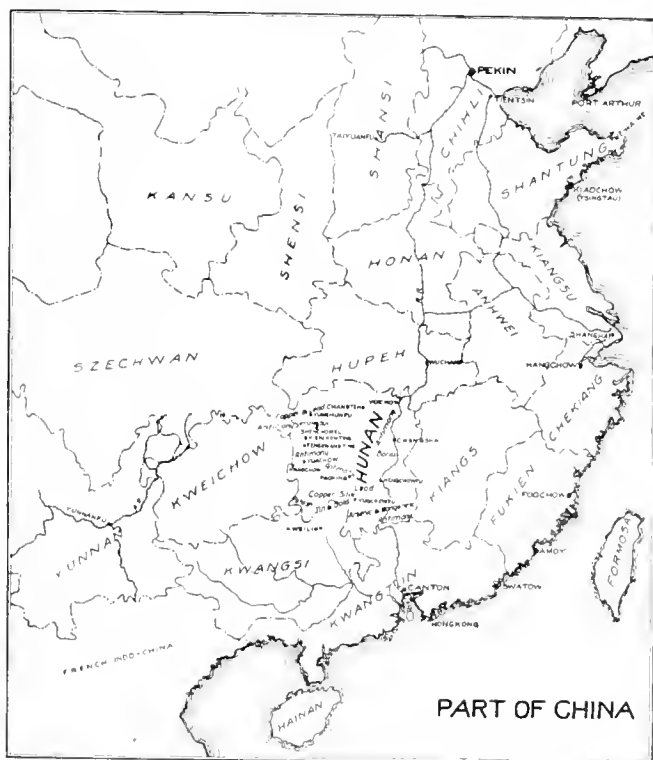

Antimony regulus is the metal and the production of it is the monopoly of the Hua Chang Company, granted under the Manchu régime and recently extended by presidential mandate. The Hua Chang Company owns the French patent rights for China of the Herrenschildt furnace, which is especially adapted for the treatment of low-grade sulphide ore. The process consists in mixing the broken ore with charcoal and heating with regulated admission of air. The sulphide is thereby converted into oxide, which is volatile and is drawn off and condensed in special chambers. The oxide is then mixed with suitable fluxes and smelted in the ordinary reverberatory furnace. The molten metal is ladled into molds and allowed to cool slowly and undisturbed beneath a covering of slag. This produces the fern-like markings on the surface of the ingot which is held to be a sign of

*Abstract from *The Far Eastern Review*.

freedom from impurities, but as a matter of fact is not necessarily so. Chinese regulus, however, compares favorably with any on the market and runs over 99.5% metal.

Antimony crude is the most usual form in which antimony is marketed in China. This consists of concentrated antimony sulphide, which is obtained by the process known as ligation. The ore, in small lumps or dust, is heated in a clay crucible or pot. The sulphide, being easily fusible, melts and percolates through a hole into a lower pot, whence it is ladled into molds. Crude contains roughly 70% of antimony metal. Another form is ash, which is the residue from ligation. This may run as high as 30% or more of antimony. It was formerly regarded as waste but is now being roasted and smelted locally for the production of regulus. Antimony ore is shipped to Europe for treatment, and works have also been recently established at Hankow for the production of crude and regulus. It must be mentioned that Hunan ores are remarkably free from deleterious impurities such as lead, copper, arsenic, zinc, etc. The export figures from Changsha for 1914 are

| | Tons. |
|---------------|--------|
| Regulus | 3,955 |
| Crude | 13,792 |
| Ore | 8,859 |
| Ash | 2,150 |

Owing to the largely increased demand for the metal, which is used in the manufacture of munitions of war, and to the fact that other producing centres, such as Mexico and France, are not in a position to maintain their output, prices have soared to the highest level yet reached.

Antimony ore is known to occur at numerous points, but the principal mines are situated in central Hunan. By far the most important field is Hsi-keng-shan, which lies 21½ miles east of Sinhua, on the Tzu river. The prevailing geological formation is dolomitic limestone. An abrupt scarp marks the line of the lode, which is over a mile in length and honeycombed with the workings of 70 companies or owners. The ore is stibnite partly oxidized above the water-level. It occurs in the form of seams, pockets, and masses generously distributed throughout a layer of limestone varying in thickness up to 40 feet.

The ore is sorted underground, carried to the surface, cobbled, to remove adhering waste, and sorted closely. The picked ore runs as high as 65% antimony, and the lower grades about 40%. The fine ore and dust is concentrated by hand-jigging in baskets. Owing to the high prices now ruling all the old waste-heaps are being carefully sorted and the ore concentrated by cobbling, crushing, and jigging. There are seven local smelting works in which the bulk of the ore is converted into crude. The oxide was being smelted to regulus in reverberatory furnaces, but this is believed to have been stopped by the monopoly-holders. The district produces 1000 tons or more of crude per month, and it is estimated that fully 10,000 persons are directly employed.

The Panhsi mines are situated 25 miles south of Chanhsi, a small town on the Tzu river 36 miles above Yiyang.

The surrounding country is mountainous and composed of sedimentary strata tilted and bent by granitic intrusion, but not much altered. Four mines are being worked. The orebodies are of the fissure-vein type, the ore occurring in shoots. These have been worked to depths varying from 150 to 500 ft. measured on the dip, which ranges from 70° to vertical. The vein-filling is quartz or interlaminated schist and quartz, and the stibnite usually occurs as a narrow seam hugging the foot-wall. The average width of the veins probably does not exceed 15 inches, though very occasionally they swell out to five feet.

There is no dressing or smelting plant; the ore is cobbled and sorted to 30% grade and 400 tons is shipped monthly to the Hua Chang works at Changsha. From the mine it is carried 2½ miles and then rafted down a small stream on bamboo rafts, each carrying half a ton to a point on the Tzu river, where it is transhipped into junks carrying 8 or 10 tons each. This ore supplies the Herrenscheidt furnaces and is converted into regulus, as previously described. Other mines of less importance are Wu-hsi in Shenchowfu, Hua-pan-hsi in Anhua-hsien, and Chiang-hsi-lung in Chiüpu-hsien. These are geologically similar to the Panhsi mines, the ore being, however, of higher grade. The output from these is less than 100 tons per month; and there are numerous other smaller producers in various parts of the province.

LEAD AND ZINC. The vast slag-heaps found at Kwei-yang-chow and south-east of Chenchow testify to the existence of a considerable industry in the smelting of argentiferous lead ore in past times, and pieces of galena recovered from ancient workings have assayed high in silver. This industry is practically extinct, but there are still a few small mines producing lead and zinc ore and by-products from associated minerals. The only one of any importance, however, is the Shui-ko-shan, controlled by the Hunan Official Mining Board. This property, as already mentioned, is run on foreign lines, and is probably the largest of its kind in China. It is well situated as regards transport and accessibility, and can be approached either overland from Hengehow, from which town it lies 32 miles distant in a southerly direction, or up the Siang river to Sungpo, the loading-station, just above the confluence of the Kwei and the Siang. From Sungpo a light railway 3 miles long connects with the property.

An examination of the geological structure shows that the ore-carrier is limestone covered to the north and west by slightly unconformable red sandstone and shale. An intrusion of syenite has tilted these into the form of an anticline, the crest of which has since been denuded. The ore deposit consists of large irregular bodies of mixed galena, zinc-blende, and iron and copper pyrites, which have been formed at or near the contact of the syenite and the limestone, as a result of this intrusion. Official records, covering the past 20 years, show that the mine has produced during this period over 50,000 tons of lead concentrate and over 126,000 tons of zinc concentrate, but there were extensive native workings prior to 1896, prob-

ably dating back for centuries. A portion of the mine is still worked in native fashion, but the main workings consist of an incline-shaft, sunk to a depth of over 600 ft., from which four levels have been driven, and of a small vertical shaft 160 ft. deep below this point serving the fifth and sixth levels. The ore is sorted underground and then cobbled and sorted again at surface. This yields clean high-grade lead and zinc ore, ready for shipment. The balance is a mixed product of varying size. The lumps are partly stacked as a reserve at surface and the remainder together with the coarse goes to the foreign plant for treatment. The dust and small pieces are sent to the Chinese dressing-floors.

In the foreign plant, the ore is first crushed and sized and then fed to mechanical jigs and Wilfley tables which produce a lead concentrate, a zinc concentrate, and intermediate products; the latter are at present being stored for future treatment. The Chinese process consists of repeated hand-jigging in baskets, which yields lead and zinc concentrates and a mixture. The latter is treated by washing down an inclined plane several times, whereby lead concentrate is separated out, the balance going to waste. The capacity of the foreign plant is about 50 tons per day and of the Chinese plant rather less. A new foreign plant with a capacity of 100 tons per day is in course of erection. During 1914, a total of nearly 56,000 tons of ore was treated yielding 5000 tons of lead concentrate and 14,600 tons of zinc concentrate. These respective products are stated to average 70% of lead with about 8% zinc, 30 to 40 oz. silver per ton, and over 30%

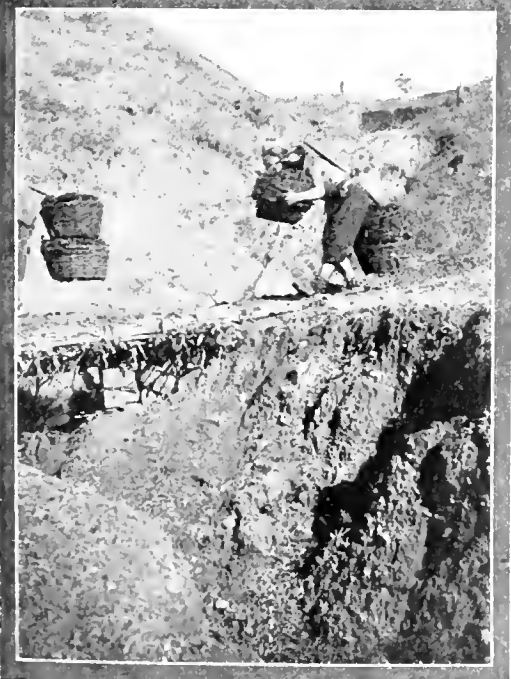
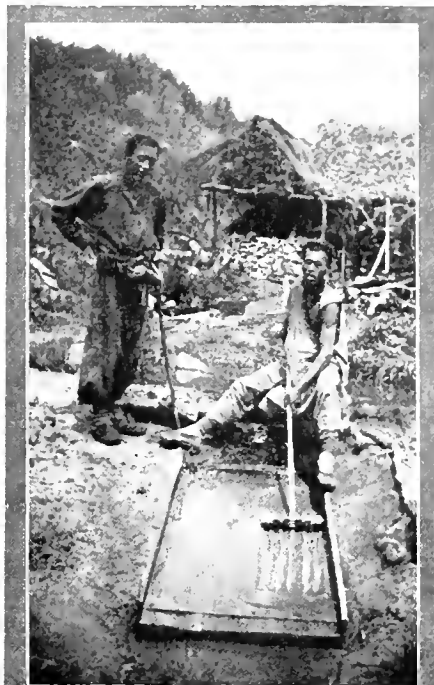

zinc with 5% to 10% lead impurity. The cost of producing a ton of concentrate is about \$13, local currency, excluding depreciation, amortization, etc. The concentrates are sold under contract to Messrs. Carlowitz & Co., of Hankow, who re-treat them in their works at Wu-chang, whence they are shipped to Europe to be smelted. An experimental lead and zinc smelting plant using native methods has been established by the Hunan Board near Sungpo, where both these metals and also silver are being produced.

TIN. The tin districts of Hunan are situated in the most southerly portion of the province close to the Kwantung border. The An-yuan mines in the Ichang district show the largest output at present. A deposit of quite exceptional nature is being worked here, and is of a type which, so far as the writer is aware, is known at only

three or four places in the world. The formation is limestone tilted and metamorphosed by a granite mass. A dike of granite, probably of more recent date than the main mass, has penetrated the limestone and along the course of this are found true chimneys or pipes of tin ore, associated with arsenical pyrite, actinolite, and a little copper pyrite and fluor-spar. The pipes are roughly circular or oblong in cross-section, varying from 20 ft. downward in diameter. The maximum depth reached is 400 ft. and the dip of the pipes ranges from horizontal to vertical.

The mineral contents are arranged in concentric rings or layers, usually sharply defined, and slightly oxidized on the outer edge, the interior being sulphide ore. One pipe is a marked exception to this, for it is oxidized to a soft red earth and clay to a depth of 300 ft. The dressing of the ore consists of cobbing and sorting, the clean arsenical ore being stacked for separate treatment. The remainder is then roasted, the arsenious oxide ('arsenical soot' of commerce) being collected by condensation in dome-shaped chambers built of rough stone and plastered with clay inside. This soot is placed in thin iron basins over a fire, covered with a similar basin inverted, and subjected to a prolonged second heating, when the arsenious oxide is deposited as a 'glass' on the upper basin. It is sold in this form for agricultural purposes. The roasted ore is then crushed by water-driven Chinese stamps, after which it undergoes a series of concentrations.

The first of these is affected by raking the ore over from side to side in a shallow stone-paved pit into which water is flowing. The 'heads' from this operation are further concentrated by repeated washings down a concave incline. The concentrate is then mixed with loam and re-roasted to drive off the associated arsenic; after it undergoes a second crushing and concentration, as above described. The smelting is conducted in a cylindrical furnace built of brick or stone bound with clay. Blast is supplied by a double-acting Chinese bellows through a two-inch opening pointing downward from the back of the furnace. The furnace-door is stopped with clay and a layer of live charcoal is placed on the furnace-bottom and blown up to a good heat. About 70 lb. of concentrate mixed to a thick paste with 'incense-wood' pulp is then charged and covered with a layer of charcoal. The smelt lasts for 24 hours, charge and fuel being added half-hourly, and the blast continued throughout. Shortly after starting an iron rod is inserted in the furnace-door and through this tap-hole the molten tin trickles out slowly into a clay-lined depression where it is kept covered with live charcoal. When sufficient has collected, it is ladled into sand molds forming ingots of about 50 lb. each. The metal thus obtained runs over 99% tin.

The Hsiang-hua-ling mines are situated in the Linwu-hsien 18 miles north of Linwu, in wild, mountainous country. Five companies are at work here, of which the Hunan Official Mining Board is the most important. The geological structure shows that the mineralization is due to a granitic intrusion between quartzite and a

conformably overlying highly fossiliferous limestone. This has produced a displacement and fissuring of the latter, with however but little alteration. The fissures are numerous but apparently of short lateral extent, though well defined. An intersection is usually marked by a good patch of ore. The associated minerals are arsenic, iron, and copper sulphides; with occasional bunches of fluor-spar in big cubic crystals. The processes of ore-dressing and smelting are precisely the same as at the Anyuan mines. A local custom, prevalent in both fields, is to reckon a picul of ore as 180 catties, a picul of concentrate as 115 catties, and a picul of smelted tin as the usual 100 catties. No explanation was forthcoming for these standards beyond the fact that it was the custom.

At Kianghwa, to the west of Linwu, there is an extensive tin-field extending southward into Kwangsi and Kwantung provinces, which has by no means yet been thoroughly investigated. Native operations have been more or less confined to the alluvial deposit which is found on the tops and sides of the hills, being retained in depressions in the eroded and rugged surface of the limestone. The tin occurs in association with tourmaline, iron, and arsenic, and when dressed contains from 50 to 70% metal. The output from the entire district is considerably in excess of either of the two previously mentioned and would be greater but for the fact that the workers suffer much interruption and discouragement by brigandage. There are a few small tin mines situated in the mountainous country to the west of the Kuei river that produce a few tons of metal annually, but they are of small importance. Arsenic is derived as a by-product from the treatment of tin ore carrying arsenical pyrite as previously explained.

QUICKSILVER. This occurs to the west of Feng-huang-ting in western Hunan adjoining the Kweichow border, and forms the eastern end of a belt extending well into Kweichow province. The mines are reported to have been worked intermittently for several centuries and certainly the extent of the underground workings and the size of the waste dumps lend truth to this statement. The two mines at present operating are Hon-tze-ping, situated 21 miles west of Fenghuang, and Tatung-la, situated 28 miles south-west of that town. The cinnabar is found disseminated through a thickness of about 100 ft. of horizontal dolomitic strata in small crystals or blebs frequently associated with long radiating crystals of stibnite; occasional rich pockets of ore occur but the deposit is of lower average grade than Hon-tze-ping. At both mines the richer picked ore is crushed by hand and panned. This is sold direct according to grade, as estimated by the eye, to buyers from Tungjen in Kweichow. The market price at the beginning of the year varied from 110 to 170 strings per picul and it may be remarked in passing that all payments are made in copper coin. The poorer ore and tailing from panning are retorted by crude native methods.

GOLD. Evidences of gold-washing of river sands are

plentiful but the operations do not appear to have been conducted with much profit, as only at two points was work seen in actual progress. Only a few mines are working and it is doubtful if these are remunerative. The chief of these is near Pingkiang in northeast Hunan close to the Kiangsi border, and 120 miles northeast of Changsha, the capital of the province. This company is controlled by the Hunan Official Mining Board, and controls a number of mines scattered over a mountainous district. The formation consists of a gray schist, carrying veins of quartz. There are numerous small workings dotted about the hillsides, most of which have been abandoned as either profitless or on account of inability to cope with the water. In most cases the adits or tunnels from the creek-banks were driven downhill, with the result that the working was, of course, flooded almost immediately.

The company is at present producing ore from six different mines, at distances varying from a third to 3 miles from the dressing-floor. The average width of the veins varies in the different mines from three inches up to two feet; the wider being generally composed of mixed schist and quartz. A small percentage of iron pyrite and galena is present. The principal mine, called the Kin T'ang is working two veins intersecting each other at an acute angle and dipping in the same direction. The veins consist of mixed schist and quartz and vary in width up to four feet, but the stope-widths are generally two feet or more in excess of this. This mine has been worked to a depth of about 650 ft. measured on the dip of 35 to 40°. The gold occurs in shoots and patches that decrease in depth. The mining is not run on contract; the miners are paid 214 cash per 8-hour shift and all tools and explosives are found by the company. The pump-men and ore-carriers are paid 164 cash per shift.

The process of treatment consists of the usual clobbering and sorting to eliminate the waste-rock. The sorted ore is then crushed in a man-power stamp-mill. This is built on similar lines to the old well-known rice-mill, except that the face of the stamp, corresponding to the shoe of the modern gravitation mill, shod with iron, strikes on a cube of iron, which corresponds to the die. The crushed ore is washed over two sets of riffle-tables, each table consisting of three boards, stepped, of a total length of 10 feet. The ore is fed by sprinkling on the head-board. The tailing is passed over the tables as often as is deemed necessary before going to waste; the concentrate is panned by hand and the free gold thus obtained smelted into ingots of 12 ounces. The remainder is fine-ground in small troughs in which an iron disc is rotated backward and forward by coolies rolling the axle on the soles of their feet. A similar appliance is used by Chinese chemists for grinding the ingredients of their medicines. After several concentrations by panning and re-grinding, the sulphides are roasted in a small reverberatory furnace and again fine-ground and sent over the riffle-tables.

The Kin T'ang mine has its own dressing-floors, the

concentrate being sent over to the central mill only for final treatment. The official returns for the closing months of 1914 show that the grade of the sorted ore was about 0.75 oz. gold per ton and that the output averaged 120 oz. gold per month of a fineness of about 920.

Other gold mines exist at Suo-sha-po, Liu-lin-cha, and Huitung. The first named is situated 14 miles north of the village of Ta-fu-hsi on the Yuan river, in the Tao-yuan district. The deposit here consists of an interbedded quartz vein in sedimentary strata composed of quartzite and shale, much hardened and contorted in places. The method of working is by drifts and open stopes, although adits suitably situated would open several hundred feet of backs. The veins vary up to a maximum of 30 inches; visible gold is found but is mostly associated with pyrite, galena, and copper sulphide. A 7-dwt. ore is considered to be of good grade. The crushing appliance is a stone roller-mill driven by water-power. The riffle-board is employed as a concentrator and the concentrate is ground fine by hand between stones; the tailings are re-treated several times before going to waste. Until recently this field was illegally worked and the output at present is low.

The Liu-lin-cha mines lie some 7 miles distant from the village of that name in the Shen-chaw-fu. Two companies are at work here on an auriferous mass which is apparently akin to a 'stockwork' (or accumulation of small veins and stringers) resulting from the infilling of fractures produced by a strong fissure. Neither company treats its own ore but sells it at the pit's mouth to the highest bidder. It is reduced in private mills of which there are fully 50 in the valley. The method of treatment is the same as at Suo-sha-po. The average grade probably does not exceed half an ounce of gold per ton, and the total production for the population of 3000 to 4000 is well below 100 oz. per month. It will be realized that the valley does not present a prosperous appearance. The Huitung mines in the Huitung district, in the south-western quarter of the province, were reported to have been closed-down recently. The geology here is stated to be similar to that at Ping-kiang.

"CHILE has slightly over 3,600,000 people," writes a reader in Valparaiso, correcting a note in our issue of November 20. This is equivalent to 12.3 people per square mile, being only exceeded in density among South American countries by Uruguay. "The population of Santiago is 400,000 and Valparaiso 150,000," says the same authority. "In width Chile varies from 106 to 219 miles, while its length is 2578 miles. The shipment of iron ore during 1914 was 63,500 metric tons, in 1915 it was 154,000."

COPPER PRODUCTION of Peru in 1915 totaled 31,890 long tons, compared with 25,070 in 1914, and 27,328 in 1913. Since August last year the Cerro de Pasco and Backus & Johnson plants have been at full capacity.

A Safety Trolley-Wire Box

During the past few years there have been several accidents in Butte mines, caused by men accidentally getting into contact with the trolley wires used in connection with the electric-haulage system. Some difficulty has been encountered in providing satisfactory protection against such accidents. The guards generally used consisted of two boards placed in a vertical position, one on each side of the wire. On account of the fact that the trolley-pole and trolley-wheel were in a straight line and in a vertical position, it was impossible to protect the wire from beneath, and there was always the danger of a man carrying a drill on his shoulder touching the end of the drill against the wire.

The trolley-wire box and trolley-pole which are shown in the accompanying illustration were devised at the Steward mine for the purpose of eliminating this danger. The main features are: a trolley-pole which supports the trolley-wheel by means of a horizontal offset plate, and a horizontal board guard which prevents the wire from being touched by anything pushed toward it from beneath. The use of this board is, of course, made possible only by the use of the offset trolley-wheel.

As will be seen in the sketch, the side opening through which the trolley-wheel is brought into contact with the trolley-wire, should be placed opposite the near side of the drift. It is then practically impossible for a man to accidentally get anything into contact with the wire.

In case the trolley-wheel should jump off the wire, the horizontal offset piece will bear against the lower edge of the side board nearest the trolley-pole, and will prevent the trolley-wheel from doing any damage. When using the old type of guard the trolley-wheel sometimes jumped

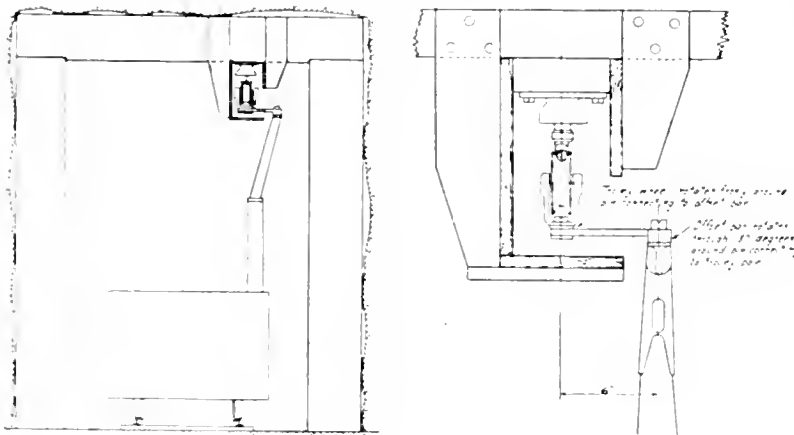

AN UNDERGROUND TROLLEY-WIRE GUARD.

off the wire and tore off the trolley-wire supports before the motorman could get control of the pole.

This guard has now been in use on the 2800-ft. level of the Steward mine for two months and has given complete satisfaction. Any man who has been knocked down and dazed by a shock from a trolley-wire will appreciate the device here described.

*Abstract from *The Anode*.

Chart for Computing Gas-Engine Horse-Power

Gas-engines and altitudes were discussed by four engineers in the *PRESS* of November 13, and the following note should be of further value.

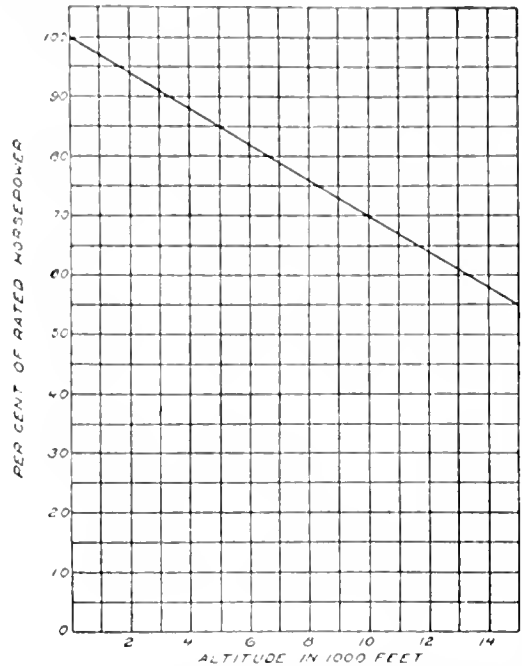

The horse-power that can be developed by an engine at a given altitude can be computed by multiplying the horse-power at sea-level by the atmospheric pressure at the given altitude and dividing by the atmospheric pressure at sea-level. Thus to compute the power developed by a 250-hp. engine at an elevation of 8000 ft., we have the pressure at that elevation equal to 10.9 lb. per square inch.

$$\text{Then } \frac{250 \times 10.9}{14.7} = 185.3 \text{ horse-power.}$$

The calculation is simplified by the use of the accompanying chart, which is taken from *Practical Engineering*.

UTAH's production of metals in 1915 amounted to \$55,000,000, an increase of nearly 50%, or \$18,000,000 over 1914. The State's output of copper has increased rapidly during late years until 182,589,000 lb. was attained in 1915. The area of Utah is 84,970 square miles, which is almost exactly the same as Idaho. In population the two states are nearly the same, being about 400,000 each. By reason of possessing deposits of coal suitable for coking, Utah is an important smelting field.

A JANNEY flotation-machine and a Wilfley table have been presented to the Michigan College of Mines by the Mohawk Mining Co., Theodore Dengler manager.

Notes From Grass Valley

By P. E. McDonald

THE narrow-gauge railroad from the Southern Pacific junction to Grass Valley indicates that the product of the mines of that district is shipped in gold-bricks rather than by great ore-trains such as leave Butte, the Lake Superior districts, or the Arizona copper mines. The snug little town of Grass Valley has the unmistakable atmosphere of American metal-mining communities, the same type of buildings and muddy roads, and the same quiet air of energy.

This famous gold-mining district is seven hours from San Francisco, at an elevation of half a mile. It is in the foot-hill country. Farms for dairy, fruit, and vegetables surround the mines, but in most respects these look much the same as other mines. In the window of the Chamber of Commerce is a gilded model, the size of a steamer-trunk representing the district's annual output of gold, $4\frac{1}{2}$ tons valued at \$2,500,000. Nevada

county has produced \$250,000,000 in gold since 1850, of which the quartz mines furnished over one-half.

The gold-bearing quartz veins are from a foot to four or five feet thick, and the ores range from \$4 per ton in wide veins to \$20 in narrow veins. The deepest workings are 6400 ft. on a dip of 23° , this bringing them to the sea-level. The North Star and Empire produce each a million dollars annually. The Empire has been operated for fifty years and is a close corporation; it recently erected a 60-stamp mill in which are the heaviest stamps in the district, 1350 lb., besides which it has 20 stamps at its Pennsylvania shaft. The North Star operates two 40-stamp mills. Both mines have cyanide-plants. The Golden Center is a rejuvenated little mine in the heart of the town that had pumping trouble in early times from a creek near the shaft. A 10-stamp mill treats the ore by amalgamation and concentration; devel-

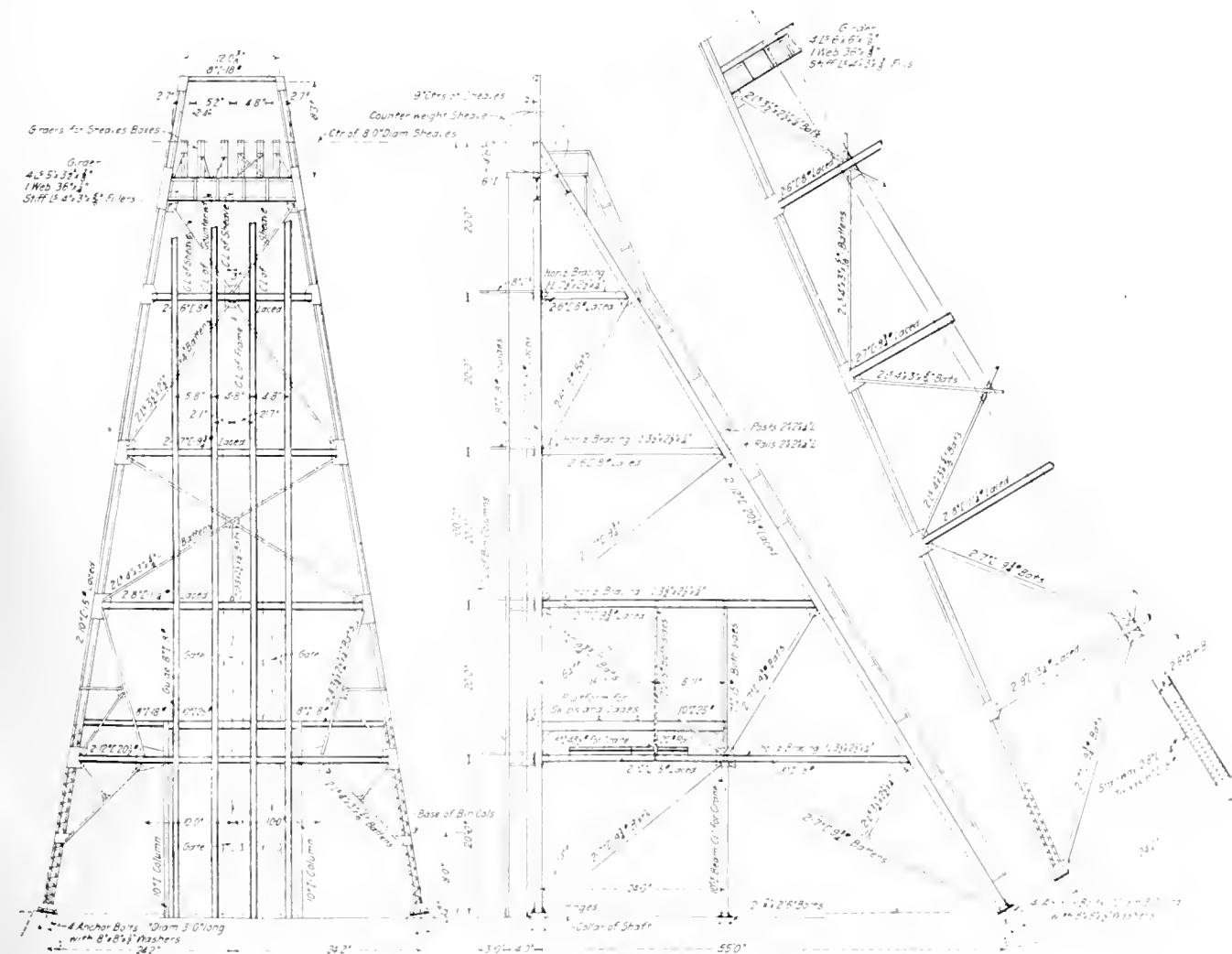

THE NEW STEEL HEAD-FRAME AT THE NORTH STAR CENTRAL SHAFT

equipment at depth is promising, and additional stamps will soon be required.

Two miles east of town near the rich old Idaho-Maryland vein, a famous bonanza of an earlier generation, are the Brunswick and Union Hill mines. The former has operated persistently for 26 years and paid dividends for the past two years; recently it added a 20-stamp mill of 1250 lb. stamps, a steel head-frame, and new machinery at the vertical shaft close to the railroad. This equipment supplements the old plant at the incline shaft alongside a 20-stamp mill of the customary 1000-lb. stamp. The Union Hill mine, adjoining the Brunswick, is believed also to be on a branch of the Idaho-Maryland vein. The Union Hill has a 20-stamp mill and does not concentrate, extracting its gold by amalgamation; occasional patches of scheelite have been found and shipped to buyers in Colorado and San Francisco.

The new mill at the Brunswick has clean-up pans of revolving bowl and balls. The mill is driven electrically with separate motors for the vanners, stamps, and crushers; Wilfley tables will be added. When the equipment at the new shaft is complete, the skips will dump directly into the mill; there is no cyanide-plant, the concentrate being shipped to a chlorination works at Nevada City. The two-post steel head-frame at the vertical shaft has an unusually short base; by reason of lack of room the back-brace is inclined at a steeper angle than ordinary; the centre of the sheave is 85 ft. above the collar while the back-brace has a base of only 30 ft. The head-frame was built by J. R. Cahill of San Francisco; the cost being \$5500.

The North Star likewise has a new two-post steel head-frame, built by the Minneapolis Steel & Machinery Co.; it is 100 ft. high to the sheaves, and contains 96,000 lb. of steel. The accompanying sketch shows the design of this head-frame. The back-brace has a base of 55 ft., which is over half the distance to the centre of the sheaves. The posts, back-brace, and horizontal members are laced. As skips and cages have to be changed two or three times daily, the cages are kept on a platform 25 ft. above the ground, where they are out of the way. This is better than having them at the collar of the shaft where space is at a premium.

The new hoist at this shaft is operated by compressed air; it is a Nordberg duplex-engine with the elaborate Nordberg devices; the cylinders are 28 by 48 in., each skip weighs 5000 lb. and holds four tons. At the hydraulic power-house, a half-mile from the mine, is a Laidlaw-Dunn-Gordon air-compressor direct-connected to an 18-ft. Pelton water-wheel. This large wheel is necessitated by the low speed of the compressor to which it is direct-connected.

Electric-power is used both for stamp-mills and mining. At the Brunswick I noticed an electric hoist; incidentally, it was fitted with the increasingly popular herring-bone gears. There are several direct-connected electric air-compressors of the type that make known their presence in engine-rooms by the peculiar 'clucking' noise that accompanies the regulation for the varying

demands for air in the line. Electric pumps are much used, both the centrifugal and plunger types. The North Star has a 10-stage centrifugal that pumps against a head of 1400 ft.; its capacity is 400 gallons per minute, and the efficiency in tests has stood at 65%.

At the vertical shaft of the Brunswick I observed a two-stage centrifugal pump mounted in a frame to run on guides in the pump-compartment, a handy method of hanging a pump so that it can be lowered or raised easily. With a centrifugal pump held flatwise in the frame no elbows are needed in the inlet or discharge at the pump; for an incline-shaft the pump would be mounted on a flat-car; this device is not new, but had not been adopted at small mines until lately.

At the incline-shaft of the Brunswick there is an old hoist driven by a Pelton water-wheel regulated by a Chavanne needle-nozzle; it is friction-driven by a fibre pinion and hoists 1250 ft. on the incline. At the top of the incline head-frame at the Empire is a compressed-air safeguard against over-winding; this consists of two cylinders connected to the compressed-air line, with a play of 4 ft. for reducing the shock in case the hoist-engineer is careless and starts pulling the skip through the top of the head-frame. A trip flashes a light in the engine-room when the skip is ready to dump, and there is a catch for automatically stopping the engine as soon as half of the 4 ft. is exceeded.

The new engine-house at the North Star is economically constructed of corrugated-iron sheets covered with a thin layer of asbestos on both sides and fastened by 'purlin-nails' (short wire hooks) to a light steel framework, making a tight structure that does not rattle in the wind. The absence of snow-load simplifies the roof problem, the roof being of the same material as the sides. Such a building, popular in mild climates, might not be satisfactory in the rigorous winters of northern regions. The roof-truss is shown in the sketch.

Some tendency is evident, as in several other American districts, to raise the grade of ore by hand-picking on surface and by decreasing the stoping-width underground. At the North Star during the three months ended October 2, a total of 24,414 tons of ore was hoisted as compared with 25,325 tons during the previous quarter, while the miners' shifts increased from 4133 to 5081. The tons per miner decreased from 6.14 to 4.81, but the sticks of dynamite increased from 79,408 to 95,448, and the tons of ore hoisted per square foot of stoping-area fell from 0.415 to 0.352. At first sight this looks as though the underground efficiency had deteriorated, because, although more shifts were worked and more dynamite was used, the output of ore decreased. This was not the case, but the decrease in output was due to narrowing the stoping-width and to increased sorting underground. This is one indication of the reaction now evident against striving for tonnage while disregarding the ultimate purpose—that of making money. Apropos is the old story told at Lake Superior of a visiting engineer who was watching the hoisting at a copper mine; observing that the rock dumped was barren sandstone

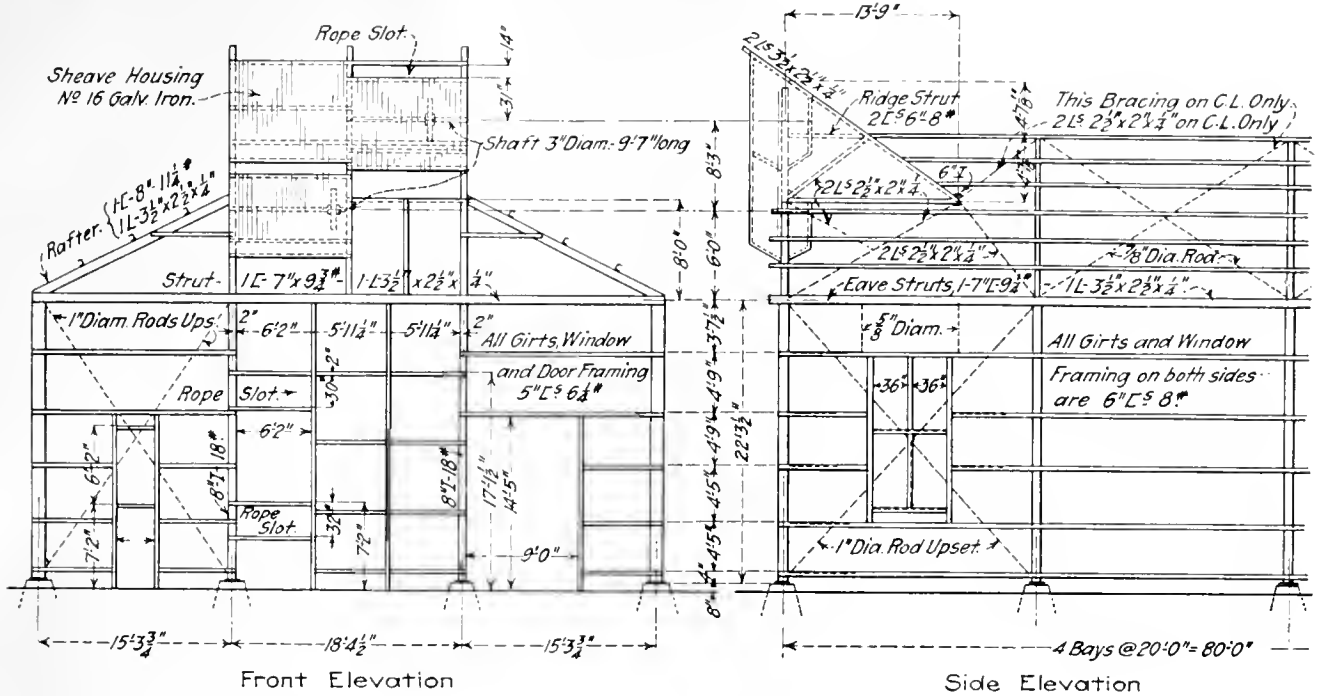

THE NEW ENGINE-HOUSE AT THE NORTH STAR MINE.

wall-rock instead of ore, he inquired of the foreman why such material was being hoisted; the foreman replied "We've got to keep those stamps going somehow." At the North Star the average stoping-width has been decreased 18% or from 4.5 ft. to 3.7 feet.

An interesting innovation is the hand-picking at the shaft. The ore, passing over the grizzlies spaced at 1 1/2 in., is fed onto two shaking-tables at which six men, three at a table, pick and cast behind them onto a conveyor-belt all rock that contains no quartz. The ore is fed forward by shaking into two jaw-crushers. The picking is aided by water sprayed on the ore; this water is afterward piped to the mill for use there. Six men, working on day-shift, are able to pick the accumulation in the bins of the night before in addition to the day's hoist, casting away as waste over 10 tons per man, or 60 to 70 tons that was formerly sent to the mill, where it cost 90 cents per ton to treat. While it is early to give definite

figures, the indication is that the grade of ore sent to the mill will be raised about \$1.50 per ton by the picking. A benefit already noticed is the increase of 10% in the amount of ore crushed by reason of the greater ease with which quartz, or mixed quartz, can be crushed in comparison to the less brittle waste-rock. The flattening of the veins, almost to the horizontal at depth, tends to increase costs. In flat stopes it becomes necessary to extract a wider portion of the vein to allow the miners room to stand; also tramming costs increase, and water settles in the hollows. Mules are used for underground-haulage in the larger mines.

ELECTRIC HAULAGE in the Copper Queen mine is on alternate levels, there being seven such haulage-levels. The gauge of the track is 20 in., and the rails are 25 lb. per yard. The heaviest locomotive weighs 14,000 lb. The weight of a loaded car is rarely above 6000 lb. At the larger stations sufficient double track is laid to hold 20 cars. Standard switches on curves of 40 to 80 ft. are used. D.C. is of 250 volts; and trolley-wires are, as required by law, 7 ft. above the track. Several men have been killed by coming in contact with the wire when their shoes or hands were wet. Carrying tools on the shoulder is against the rules. To reduce the breaking of trolley-poles in turning in narrow drifts, a trolley-pole with a knuckle in the centre was adopted. These notes are abstracted from a paper by Gerald F. G. Sherman, read at the San Francisco meeting of the A. I. M. E.

T. F. COLE, well known in copper mining circles, is taking an interest in his boyhood home in the copper country of Michigan. In addition to his financing of Keweenaw Copper Co. to explore a large area of old copper-bearing territory, he recently bought the mineral right under the town of Ahmeek, paying \$4000 per acre for 40 acres.

Dredging in the United States

By H. D. McCaskey

THE production of gold by dredging in the United States and Alaska from the commercial beginning of the industry in 1896 to the record output of 1914, inclusive, has amounted, according to best available data, to \$94,833,468, and the value will probably have passed the \$100,000,000 mark by the middle of 1915.

Profitable dredging for gold is first noted from Grasshopper gulch in the Bannock district, Beaverhead county, Montana, where a Bucyrus double-elevator bucket-dredge was operated as early as 1893-94. Before

operations have been continuous in Montana since, with a total yield from this source of more than \$6,500,000. In Idaho, where the gravels of the Boise basin have been worked by this method, dredging has produced nearly \$3,000,000 and been continuous since 1897. In Colorado dredging has been in vogue in the Breckenridge district, Summit county, since 1901, and has produced over \$2,700,000 in gold. In New Mexico, from 1902 to 1905, inclusive, a dredge was operated on Cimarron river, near Elizabethtown, in Colfax county, and

Production of gold in the United States by dredges and number of dredges producing, by States, 1896-1914

| State or Territory. | 1914 | | 1913 | | 1912 | | 1911 | | 1910 | | 1909 | | 1908 | | 1907 | | 1906 | | 1905 | |
|---------------------|-------------|----------|-------------|----------|-------------|----------|-------------|----------|-----------|----------|-----------|----------|-----------|----------|-----------|----------|-----------|----------|-----------|----------|
| | Value. | Dredges. | Value. | Dredges. | Value. | Dredges. | Value. | Dredges. | Value. | Dredges. | Value. | Dredges. | Value. | Dredges. | Value. | Dredges. | Value. | Dredges. | Value. | Dredges. |
| Alaska..... | \$2,300,000 | 42 | \$2,200,000 | 36 | \$2,200,000 | 38 | \$1,500,000 | 27 | \$800,000 | 18 | \$124,900 | 14 | \$170,901 | 4 | \$250,000 | 4 | \$120,000 | 3 | \$40,000 | 3 |
| California..... | 7,783,394 | 6 | 8,000,294 | 63 | 7,429,875 | 65 | 7,022,161 | 65 | 7,554,254 | 72 | 7,382,950 | 63 | 6,536,189 | 69 | 5,065,437 | 57 | 5,098,359 | 59 | 3,276,141 | 59 |
| Colorado..... | 62,659 | 5 | 372,288 | 4 | 384,748 | 3 | 272,173 | 3 | 344,211 | 6 | 491,636 | 4 | 144,773 | 4 | 35,235 | 3 | 48,343 | 3 | 34,342 | 3 |
| Idaho..... | 28,989 | 4 | 364,856 | 5 | 481,075 | 8 | 238,294 | 8 | 91,247 | 6 | 101,704 | 6 | 77,189 | 5 | 71,438 | 6 | 38,349 | 3 | 34,346 | 3 |
| Montana..... | 25,045 | 5 | 685,210 | 5 | 710,387 | 6 | 507,158 | 7 | 473,317 | 8 | 426,649 | 8 | 492,667 | 4 | 197,144 | 4 | 397,059 | 4 | 255,542 | 5 |
| Oregon..... | | | | | | | 14,575 | 3 | 31,010 | 6 | 42,667 | 3 | | 2 | 23,194 | 2 | | 1 | | 1 |
| Other States..... | 432,138 | 4 | 317,268 | 3 | 12,744 | 1 | 16,591 | 3 | | | | | 24,522 | 2 | 19,322 | 1 | | | 28,045 | 4 |
| Total..... | 12,312,780 | 120 | 12,287,366 | 116 | 11,218,944 | 124 | 10,326,369 | 118 | 9,293,040 | 115 | 8,783,599 | 96 | 7,353,571 | 88 | 5,655,702 | 79 | 5,721,394 | 76 | 3,687,376 | 68 |

| State or Territory. | 1904 | | 1905 | | 1906 | | 1907 | | 1908 | | 1909 | | 1910 | | 1911 | | 1912 | | 1913 | | Total value. |
|---------------------|-----------|----------|-----------|----------|-----------|----------|-----------|----------|-----------|----------|-----------|----------|----------|----------|---------|----------|---------|----------|--------|----------|--------------|
| | Value. | Dredges. | Value. | Dredges. | Value. | Dredges. | Value. | Dredges. | Value. | Dredges. | Value. | Dredges. | Value. | Dredges. | Value. | Dredges. | Value. | Dredges. | Value. | Dredges. | |
| Alaska..... | \$25,000 | 3 | \$20,000 | 2 | | | | | | | | | | | | | | | | | \$10,100,891 |
| California..... | 2,187,038 | 42 | 1,475,742 | 31 | \$867,667 | 29 | \$471,762 | 22 | \$200,922 | 16 | \$206,302 | 8 | \$18,887 | 3 | \$5,000 | 1 | \$2,000 | 1 | | | 71,314,766 |
| Colorado..... | 75,584 | 3 | 15,000 | 1 | 10,000 | 1 | 6,000 | 1 | | | | | | | | | | | | | 2,755,998 |
| Idaho..... | 98,110 | 1 | 86,113 | 6 | 101,237 | 10 | 115,117 | 6 | 129,443 | 6 | 62,436 | 6 | 13,920 | 1 | 11,436 | 1 | | | | | 2,907,819 |
| Montana..... | 245,700 | 2 | 229,332 | 4 | 318,914 | 7 | 146,134 | 5 | 189,665 | 5 | 165,440 | 5 | 154,893 | 4 | 102,120 | 4 | 42,000 | 1 | | | 6,305,535 |
| Oregon..... | | | | | | | | | | | | | | | | | | | | | 4,114,443 |
| Other States..... | 101,275 | 4 | 78,870 | 1 | 771,689 | 1 | | | | | | | | | | | | | | | 41,064,013 |
| Total..... | 2,723,717 | 61 | 1,910,964 | 43 | 1,369,322 | 48 | 740,013 | 34 | 520,037 | 27 | 434,178 | 18 | 187,700 | 8 | 118,556 | 6 | 44,000 | 2 | | | 94,833,468 |

a Oregon, Nevada, Alabama, North Carolina.
 b Oregon, Nevada.
 c South Dakota, North Carolina, Georgia, Wyoming.
 d Nevada (2), South Dakota, Georgia, North Carolina.

e Georgia, Oregon.
 f Georgia (2), New Mexico.
 g Georgia, Oregon.
 h Georgia, North Carolina, Oregon, New Mexico.

i Oregon (3), New Mexico.
 j New Mexico.
 k Part of output only; see other States.
 l Largely from Oregon.

that time, and only too frequently since, dredging operations had been attempted in various regions only to fail because of insufficient knowledge of the ground or of the engineering and financial features of the work. Dredges of various types have been tried without permanent success—clam-shell, suction, single bucket, spoon or scoop, and pump—until finally has been evolved the modern bucket-elevator machine of wonderful capacity and endurance, fitted, according to the special conditions involved, to overcome natural obstacles that have blocked earlier attempts, operated in many cases by electric power, and profitably treating material unprofitable under all other known or attempted methods of operation. From the Bannock district dredging extended to Alder gulch, near Ruby, in Madison county, and

added materially at that time to the gold output of the State. The gravels finally became too poor to operate, according to report, and work came to an end. In Alaska, dredging has been continuous and of increasing importance since 1903, and is now an important factor in the production of gold—over \$10,000,000 to date. In Oregon, dredging has not been always profitable, but it has been almost continuous since 1904, and in 1914 it was reported as notably successful. In the Philippine Islands dredging had its inception under the Spanish régime in a curious native boat of diminutive scale, but was first tried by modern American methods (unsuccessfully) in Masbate in 1905. Later New Zealand and American dredges were introduced into the Paracale-Mambulao district, south-eastern Luzon, where the first native dredging was done, and the development of the industry has been continuous since. One modern

*Abstract from 'Mineral Resources of the United States, 1914,' published Jan. 20, 1916.

dredge alone had recovered more than \$450,000 in less than 2½ years to the end of 1914, and had paid 107% interest on the original capitalization of \$250,000. There were eight dredges at work in 1914 in the Islands, seven in this district and one in Tayabas, and they produced altogether during the year about \$515,000.

In California some of the earliest attempts at dredging for gold were made, following the first successful work of the kind with steam-driven bucket-elevator dredges at Otago, in New Zealand, in 1882. But it was not until 1896 that the first commercial bucket-elevator dredge of the California type was operated on the Yuba river. It was later wrecked by floods, but it began the great output of gold from California by this method which had amounted to over \$71,000,000 by the end of 1914, in which year 60 boats altogether were at work in the various fields. Much of the proved dredging ground in California has now been worked out, and it is an open question whether development of new ground will in the future take the place of that worked out. In the evolution of dredging apparatus from the small steam-driven wooden machines with buckets of a capacity of about three cubic feet each and capable of raising 1200 cu. yd. daily to the great all-steel electric-driven dredges with buckets raising 16 cu. ft. each, and handling 10,000 cu. yd. daily, California has earned first rank. It is becoming better known that a great deal of dredging in various parts of the world has been at a loss, and that many important factors enter into the problem as to what ground can be worked at a profit by this method. The industry has now developed geologic, engineering, and constructing experts, and, in view of the fact that even profitable dredging is expensive in outlay, prospective investors would seem to gain something by consulting the rich fund of experience now available in the hands of these specialists.

Brief details of dredging operations have been given in 'Mineral Resources' in the mines' reports on gold, silver, copper, lead, and zinc of the Western States, and also in earlier reports of the Director of the Mint. Further information is to be found in reports of geological surveys or mining officials of different States. A comprehensive and very useful report is contained in Bulletin 57 of the California State Mining Bureau, 'Gold Dredging in California,' by W. B. Winston and Charles Janin. Another valuable treatise is 'Dredging for Gold in California,' by D'Arcy Weatherbe, published by the MINING AND SCIENTIFIC PRESS; and additional information is constantly furnished by the technical press.

The preceding table, compiled from best available sources, gives the dredge production of gold in the United States and Alaska (not including the Philippine Islands) from 1896 to the end of 1914, inclusive, by States.

ELECTRO-STATICS. That branch of electrical science devoted to the phenomena of electricity at rest or of frictional electricity.

Metallurgy of Native-Silver in Chihuahua

By W. M. Brodie

*The native-silver ores of Chihuahua were known in the seventeenth century, as soon as the Spanish settlers occupied that part of the country. The special attraction of these ores was that anyone could melt them in an ordinary forge into cakes of silver, that served as money. The low-grade ores were considered of no commercial value until 1880, when ex-governor Shepherd visited the place, bought the San Miguel group of mines, and commenced to explore on a large scale. He lived in Batopilas for over twenty years and died there in 1902.

The ores formerly were carefully hand-sorted. The rich ores were pounded fine by hand, the native silver sifted and washed out, and the remainder ground in drag-mills with mercury. The amalgam was separated by washing, packed in flasks and the mercury distilled, leaving silver to be melted and refined in the vaso.

Nowadays the rich ores are separated. They are crushed in a special stamp-mill and the coarse silver is taken out of the mortar and melted. The pulp passing through the screen is treated in amalgamating-pans with mercury, and the tailing is leached with cyanide solution by agitation. The low-grade ores are crushed in a larger mill also driven by water-power. The pulp is concentrated on shaking-tables, the tailing goes to the river, and the concentrates are re-concentrated. The richer part holding native silver is treated in the amalgamation-pans like the high-grade ores, and the poorer part of the concentrates is leached with cyanide solution by percolation.

The native silver and argentite concentrate well. The rate of concentration is 50 to 1. The fine black silver in the concentrate and tailing is easily dissolved with a cyanide solution. The low-grade ores have furnished in late years one-third of the total production. The crude silver from the stamp-mills, from the amalgamation, and from the cyanide process is refined in a reverberatory furnace to total fineness.

NEW-STYLE DRILL BITS of the Carr type are being employed at the New Almaden quicksilver mines in Santa Clara county, California. In this medium-hard rock with occasional soft streaks, it is found advantageous to punch a hole in the side of the hollow drill-steel an inch or two from the end of the bit rather than depend on the hole in the centre of the bit which is likely to become clogged with muddy rock-chippings. As mentioned in the article on drill-bits in our issue of November 6, this is not an unusual practice with Carr bits for mounted hammer-drills, and is done at Lake Superior mines where varieties of iron ore are not unlike the California cinnabar in drilling qualities.

*Abstract from paper read before the Pan-American Congress, Washington, December, 1915

CONCENTRATES

Readers of the MINING and Scientific PRESS are invited to ask questions and give information dealing with technical and other matters pertaining to the practice of mining, milling, and smelting.

QUICKSILVER DEPOSITS of California, with few exceptions, are situated in the Coast ranges.

CENTRIFUGAL PUMPS will pump gritty water and pebbles. If special blades are provided, rocks as large as a man's fist can be handled.

A STEAM-SHOVEL at the Calumet & Hecla mine, Michigan, was used to advantage in removing snow during the heavy fall of January.

THE SHAPE OF SHOVELS is important. A small round-pointed shovel is best for tough soils; a large square-pointed shovel for handling sand, gravel, or coal, off boards.

SHAFT-SINKING cost at Butte, in one instance, was reduced from \$45 per foot to \$36 per foot by putting the miners on a bonus system; 106 ft. was sunk in 30 working days.

BLACK SHALE, containing bituminous matter, pyrite, and marcasite stored on the edge of the Tennessee river, near Hamburg, recently caught fire after several days of rain. The pile of shale contained all the conditions necessary for spontaneous combustion. Coal frequently catches fire, but shale is rarely attacked in this way.

THAT A STERLING BILL payable on presentation in current and legal funds in London must be sold in New York at from 18 to 36 cents discount in the pound means merely that in London one cannot have the gold for the bill else the present rates of bank, freight, and insurance charges could allow of a discount of not more than 3 cents.

GEARS cannot be operated safely at too high a speed, or the liability to shock becomes dangerous and the noise excessive. For ordinary cast-iron gears 1800 feet per minute is high, for helical cast-iron gears 2400 ft., for cast-steel gears 2400 ft., for special cast-iron machine-cut gears 3000 ft. Rawhide gearing, which operates almost noiselessly, may be run satisfactorily up to 3000 ft. per minute.

SHAFT-SINKING practice in the Lake Superior region is exemplified by the rate of advance made in the Woodbury vertical shaft of the Newport Mining Co. at Ironwood, Michigan, details of the method of sinking of which were described in our issue of November 13. The shaft is 13 by 21 ft. in size, has six compartments, and much of the rock is granite. On December 1 a depth of 1664 ft. had been attained, making an average of 185 ft. per month, or approximately 6 ft. per day, which is noteworthy. Sinking will be continued to a depth of 2400 feet.

High prices for zinc are responsible for much activity that is not always profitable. In the Joplin district of Missouri pillars of ore are left to support roofs. In one instance, a pillar 8 ft. high and 25 ft. thick, contained 300 tons of 2.5% ore, worth \$750, and a profit of \$350. This pillar was mined, with the result that a slab of waste, 65 by 65 by 3½ ft., weighing 1100 tons, fell, costing \$200 to shovel it away, and \$350 for other charges. Here the operator risked losing \$220 in order to recover \$350 profit, not mentioning the risk to the lives of miners, according to Walter Holmes, a mine inspector.

COMPRESSED-AIR HOISTS are becoming popular at those mines where the use of steam has declined by reason of the substitution of electricity. A hoist at the Copper Queen mine that had been driven by steam, was changed to compressed air without making any alteration in the engine; compressed air was found to be more efficient than steam, as the steam-main was 920 ft. long. By employing cold air in the cylinders for brakes and clutches, leakage and packing troubles became negligible; however, the air for the engine is heated to 250°. At one hoist of the Copper Queen 1,000,000 cu. ft. of free air, compressed to 92-lb. pressure, is required daily.

DESIGNATIONS of various grades of cyanide, based on sodium cyanide content, was described on page 74 of the PRESS of January 8. As sodium cyanide has displaced the potassium salt, the previous 129% sodium salt, containing 51-52% cyanogen, is now 96-98%, with the same composition. To show the trend of use of the two salts, the following figures, compiled by the Survey, are of interest:

| State. | Potassium cyanide. | | Sodium cyanide. | |
|--------------------|--------------------|---------|-----------------|-----------|
| | 1913. | 1914. | 1913. | 1914. |
| Colorado | 659,374 | 35,800 | 260,589 | 935,589 |
| New Mexico | 1,415 | | 190,190 | 237,511 |
| South Dakota | 113,727 | 89,649 | 388,961 | 425,397 |
| Total | 774,516 | 125,449 | 839,740 | 1,598,497 |

EXPLOSIVES are stored underground in many mines, in a room apart from the active workings, preferably on a level where mining has ceased. While objection is sometimes raised to the storage of several days' supply of dynamite underground, there is reason to believe that less danger exists in such cases when carefully conducted and distributed by a capable 'powder-monger' than in a system whereby dynamite is taken underground each day by various miners or foremen, as the handling of it is lessened. Charles E. Munroe recently pointed out in a paper at the Second Pan-American Scientific Congress at Washington, that in an underground magazine it is well to arrange a 'safety-valve,' such as a lightly closed shaft above the magazine that will provide a vent similar to the explosion-doors on blast-furnaces and stoves in case of an explosion. He also spoke against the storage of black powder with the dynamite, as one tends to deteriorate the other by the absorbing of moisture from a hydrated explosive by a dry explosive.

Mining in Colorado

By George J. Bancroft

COLORADO increased its output of gold, silver, lead, copper, and zinc from \$33,000,000 in 1914 to \$43,000,000 in 1915, a gain of \$10,000,000. But the major metals represent only a part of the State's mining activity. Colorado leads in the production of rare metals, the increase in the value of which was \$2,700,000. Tungsten increased from \$293,500 in 1914 to \$1,785,000 in 1915; manganese increased from nothing to \$625,000; radium decreased from \$150,000 to \$100,000; vanadium increased from \$100,000 to \$600,000; molybdenum increased from nothing to \$400,000.

Colorado produces a variety of other minerals, as follows:

| | |
|-----------------------|---------------------|
| Marble | \$ 1,000,000 |
| Coal | 18,000,000 |
| Chemicals | 3,629,453 |
| Fire-clay | 50,000 |
| Portland cement | 500,000 |
| Petroleum | 200,000 |
| Hydro-carbons | 100,000 |
| Lime | 80,000 |
| Clay products | 1,200,000 |
| Total | \$25,069,453 |

This amount, added to the production of the common and rare metals, shows that the mineral industry in all its branches produced \$71,500,000 last year.

The future of the State's mining looks to the diversity of mineral output rather than to great increases in gold and silver. For many years, Colorado was famed chiefly for its production of the precious metals. I would say that the gold and silver product of the State will soon be a matter of relative secondary importance. Furthermore, I hazard the forecast that the metalliferous mining will be secondary to the non-metalliferous mining. Colorado has been known as the leading bi-metallie State. It is now the leading multi-metallie State, and it bids fair to soon become one of the leading multi-mineral states.

A hopeful feature of the silver market has been given publicity by Catlin & Powell Co. of New York, to the effect that the cinematographs or 'movies' are now buying 15,000,000 ounces of silver annually. A salt of silver is used to sensitize the films. It is evident that this film business is destined to play an important part in the future of the silver market.

An enterprise of much importance to the San Juan has been started at the Camp Bird, namely the driving of a 9000-ft. adit to work the famous vein at depth. This enterprise has a great geologic interest. A number of the profitable San Juan mines are situated in the andesite overflows, which are underlain by a conglomerate bed of Mioene age. It is generally recognized that the

conglomerate is the lower boundary of mineral enrichment, and even the beds immediately overlying it are considered unfavorable to orebodies.

Fresh discoveries of tungsten have been made in the Cement Creek part of the San Juan region. Silverton was shut off from the outside world for thirty days, but in spite of this fact, important discoveries are reported. In fact, one discovery is said to be due to an unusually heavy snow-slide that plowed the soil off a mountain-side.

At Leadville, Jesse McDonald's famous pumping project at the Penrose shaft is now one of three similar enterprises. Fryer hill and Carbonate hill are to be unwatered. Fryer hill is to be unwatered by the United States Smelting, Refining & Exploration Co., resident manager H. S. Lee. The Harvard shaft will be used for pumping, the machinery being already on the ground. Centrifugal station-pumps of the Krogh type will be used. The maximum lift will be 750 ft. and the capacity 700 gal. per minute. The U. S. S., R. & E. Co. recently floated \$12,000,000 in ten-year gold notes through Lee, Higginson & Co. of Boston, which seems to indicate that they will take over properties now under option. Carbonate hill is to be unwatered by a company organized to develop the Pyrenees, R. A. M., Mikado, and Gallagher mines under a five-year lease. Some of the money comes from New York, which is also headquarters for the Iron Silver Mining Co., capitalized at \$10,000,000, managed by George O. Argall and prominent as a shipper of zinc-lead ore. It pays dividends of \$50,000 at least twice per annum. From reports submitted by the engineers, the company expects to pump an average of 2000 gal. of water per minute from a depth of 1300 ft., a greater distance from surface than is involved in either the Penrose or Fryer hill enterprises. With capacity for 2000 gal. per min., the Carbonate pumps will rank third in Colorado and next to the Smuggler at Aspen, which is quoted at 2500 gal. and where incidentally the high price of lead, 50% above normal, has stimulated production.

The dredges are shut-down during the winter. A few years ago the Reiling dredge at Breckenridge ran all winter. Although it was proved that the winters do not limit successful dredging, a dredge needs overhauling once a year, so the boats stop work in the colder part of the winter. This year promises to make a record in placer mining.

Buyers of rare metal ores in Denver are thick as flies in honey, and their main worry appears to be to obtain a dependable supply for a long period. Price seems a secondary matter with them. The prices of alloy-steel are such that the cost of the small proportion of the rare metal required is susceptible to considerable latitude.

REVIEW OF MINING

As seen at the world's great mining centres by our own correspondents.

DEADWOOD, SOUTH DAKOTA

NEED FOR CUSTOM PLANT — FINEST PRODUCTION — HOMESTEAK
ACTIVITY — ORO HONDO — RICH GOLD ORE AT RATTLESNAKE
JACK MINE.

A custom-cyanide plant for Deadwood is a topic of discussion just now, and probably the mining committee of the Deadwood Business Club will investigate the matter fully; should it make a favorable report the mill undoubtedly will be built. It is pointed out that there are a large number of small properties, capable of supplying 10 tons or more of ore daily, not large enough to support a mill of their own, but combined could furnish a good quantity. Several such properties have been opened in the Blacktail district, others in Two Blk. Spruce gulch, and Bird mountain section can always be depended on to yield a good tonnage. Deadwood would be an ideal location for the mill. It has railroad connections, both narrow and standard gauge, with the mining camps; any one of several mill-sites could be secured, labor and supplies are plentiful. It is probable that the plant could be financed entirely with local capital. Several of the smaller mining companies would subscribe to the building fund, and local business men and investors could take care of the remainder. It is argued that the small mining companies would by this arrangement have their ore treated in a modern mill, which would be under the management of a first-class mill-man, at a moderate cost—no more than the treatment charge made at other plants—and that their dividends on the mill operations would still further reduce the net cost to them of treatment of their ore.

Production of wolframite continues at the Homestake and Wasp No. 2 mines. At the latter the concentrator is working well, and the first consignment of concentrate will be shipped about the end of February. The Wasp No. 2 paid a dividend of 5c. per share in January, and 2½c. in February. It appears that those who purchased the John Gray stock, sold by his administrators at 25c. per share, are almost reasonably sure to have their investment returned in dividends within the year. The Homestake is now loading its second car, which has been purchased by the Primos company.

The Homestake's Ellison shaft is to be continued to the 2000-ft. level. It is now 1920 ft. deep, or 70 ft. below the 1850-ft. station. From the new bottom a drift will be driven to a point beneath the B. & M. shaft, and connection made with that shaft, thus making it 2000 ft. deep also. For the sinking of the Ellison, an auxiliary hoist will be installed at 1850 ft., and the compartments used for hoisting from that level to the surface will be bulkheaded to protect the men in the bottom. Work is progressing rapidly to completion on the installation of the new equipment at the B. & M. shaft. The crushers and conveying system were recently tested, and by the time the boiler-plant is finished the new hoist will be ready to go into commission. When this is done the boilers now in use at this shaft will be torn out, and the space they occupy given to housing an immense air-compressor. Altogether the new equipment will be as good as possible to procure. It is expected that 1200 to 1500 tons daily will be hoisted here, or about one-third of the ore supply for the mills. Edzar Huntley and Ole Danielson, general foreman and night foreman, respectively, are no longer on the pay-roll. The former has resigned on account of ill-health, and has been succeeded by A. J. M.

Ross, a member of the engineering corps. Mr. Danielson, who recently died, has been succeeded by John Townsend. All four of the men mentioned have been long-time employees, and won their various promotions strictly on their merits.

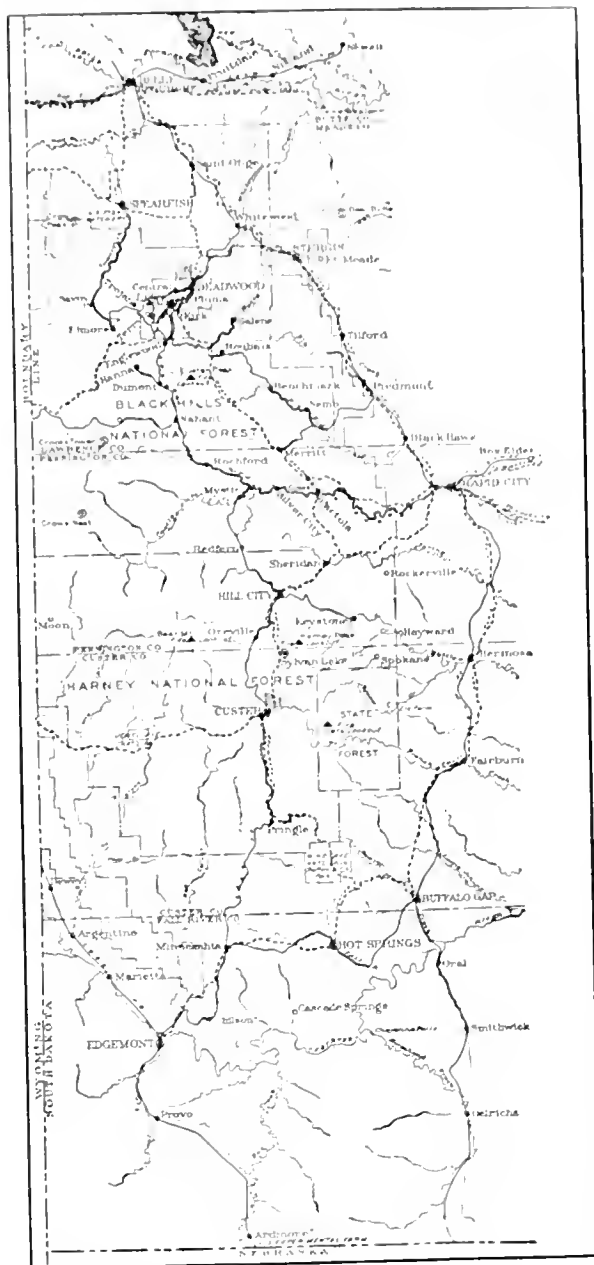

THE BLACK HILLS REGION OF SOUTH DAKOTA.

Mr. Ross, for instance, is a Lead product, leaving school to join the engineering staff, and working his way upward by ability.

At the 2000-ft. level of the Oro Hondo shaft excavation is now being made for a station. An extensive campaign of lateral work is contemplated for this level.

Exceptionally high-grade ore continues to be mined from a small streak in the Rattlesnake Jack property, near Galena.

The seam is 12 in. wide, and assays as high as \$2000 gold per ton. Much of it is specimen rock. The mill is treating about 50 tons daily, by a combination of concentration and cyanidation. The concentrate—pyrites—contain \$150 gold per ton; the last car shipped comprised 27 tons and returned \$3800 net.

TORONTO, ONTARIO

HEAVY WAR TAX WORRIES MINING COMPANIES.—NEW MILLS, DEVELOPMENT, AND RETURNS.

The proposed new war tax bill presented to the Canadian parliament on February 15 by Sir Thomas White, finance minister, has created much dissatisfaction in mining circles, as it hits the mining industry more than any other. The tax, from which it is expected to raise at least \$25,000,000, is levied on the net profits of all classes of business, with the exception of life insurance, farming, and stock-raising, with a capital of \$50,000 or more. Incorporated companies are taxed 25% on all net profits over 7%, and individuals, firms, and associations not incorporated, 25% on all net profits over 10%. The minimum capital limitation does not apply to those having war orders. The tax is made retroactive, covering a period of three years from August 3, 1914. The obvious objection from the standpoint of the mining investor is the injustice of placing mines on the same basis as other productive industries, as the assets are steadily depleted in the course of production, and the dividends largely consist of returns of capital. A high rate of interest is necessary to make the enterprise remunerative. Another objectionable feature is that under the bill as it now stands, companies having large capitalizations, mainly representing watered stock, and consequently yielding comparatively small dividends, will escape paying a due share of taxation. The retroactive clause is also strongly opposed on the ground that those companies which have already distributed their profits will be seriously embarrassed. It is understood that a strong deputation of mining men will shortly place its views before the Government. The finance minister has intimated that the bill may be modified as affecting mining companies.

A mill is to be erected at the North Thompson mine.

At Cobalt the Coniagas new cyanide plant for low-grade concentrate is in operation.

At the Chisholm Veteran claim near South Porcupine, five drill-holes are to be put down 1000 ft. each.

The McKinley-Darragh-Savage company pays 3% on April 1. The total is 199% equal to \$4,471,890, or almost twice the capital.

During January the McIntyre property at Porcupine produced gold worth \$71,076 from 8950 tons of ore. The profit was \$38,400.

The new mill of the Schumacher is treating 110 tons of ore daily, averaging \$8 to \$10 per ton. The plant cost \$57,800. It employs the Dorr counter-current decantation system.

During 1915 the Dome Lake Mining & Milling Co. of New Liskeard produced 11,727 tons of \$9.12 ore, at a cost of \$3.83 for underground work, and \$2.45 for treatment. The net revenue was \$80,659.

During 1915 the Trethewey Mining Co. of Cobalt only operated for the first two months. A fair amount of development was done. Reserves are 26,774 tons, containing 507,339 oz. silver. Production from 6113 tons was 85,004 ounces.

During January the Nipissing high and low-grade mills treated 81 and 5278 tons of ore respectively, for a yield of \$63,582 and \$116,220. The refinery shipped 251,676 oz. silver. Development generally was satisfactory. An extension of the Trethewey vein was found, assaying 3000 oz. over 6 inches.

At the Tough Oakes, Kirkland Lake, the new compressor will allow of 30 drills being worked, instead of 17 during December. During that month the mill treated 3668 tons of ore averaging \$20 per ton. Development continues good.

KALGOORLIE, WESTERN AUSTRALIA

WOOD-CUTTERS ON STRIKE.—CONTRACT TROUBLES.—WET MINES.—MINE SALE.—MORE WAGE DISPUTES.—YIELD OF MINES.

During December, there appeared to be fairly general dissatisfaction among the wood-cutters, who supply the mines with firewood and mining timber. The majority of these men were Italians and Austrians, and, as the latter have been interned, and many of the former have gone to fight in Italy, and new men who are not used to the work have taken their place and cannot make standard wages, they are asking for higher rates. As none of the mining companies hold more than one or two months' supply, a strike would be serious, and this is what happened early in January, resulting in gradual shutting-down of the mines and mills.

A largely attended meeting of the Miners' Union was held in the third week of December, with the view of putting the contract system of working on a uniform and more equitable basis. The trouble has arisen owing to some of the companies charging more than \$11 a case for explosives, the maximum rate stipulated. Another and more serious grievance is the fact that contracts, except in name, are not really contracts at all. No tenders are ever called for. The manager, or assistant, merely gives the job at a price, picks out some men, and they may take it or leave it. If one party refuses, another party is generally found that 'scabs' their mates. Naturally this leads to bad feeling. The system is intolerable, as really good workers pay their car-men and shovelers a 25 to 50c. bonus, in addition to the ruling rate paid by managers, whose employees the car-men are, and the remaining car-men are consequently dissatisfied. This is a long-standing grievance.

At the Edna May mine, near Southern Cross, the three electric pumps have an aggregate capacity of 1,400,000 gal. of water per day, and the Cornish lift 100,000 gal., a total of 1,500,000 gal. The adjoining mine, the Edna Deep, makes 2,880,000 gal. per day. The latter's shaft down to 300 ft. is practically dry; this was accomplished by means of plugging the bore-holes which cut the lode and putting down new vertical bores in the bottom of the shaft, and filling them with cement under high pressure.

The Associated Northern Blocks Co. has bought for \$425,000 the Slippery Gimlet mine, almost adjoining its Victorious leases at Ora Banda. This mine has been stoped in the oxidized zone for a length of 480 ft. from 150 ft. to the surface, and produced 30,100 tons for \$340,900, an average of \$11.32. Telluride occurs both in the Victorious and Slippery Gimlet, which are only 660 ft. apart.

The Meekathara Miners' Union has asked the Arbitration Court for a revision of the award given in November 1910, and the Court has agreed to reconsider the question, the new agreement to date from January 1, 1916. The only two regular producers and profit-earners in the district are the Fenian and Ingliston Consols, both owned by private syndicates. During November their profits were \$31,900 and \$20,200, respectively. The Ingliston Extended, owned in London, has never paid a dividend, and has merely been developing lately, while the Queen of the Hills, owned by the Lake View & Oroya Exploration Co., has depleted its oxidized reserves, and has recently been altering its treatment plant. The other mines in the district have only intermittent crushings of small tonnage and are chiefly worked by their owners. Yet the total output of the district is considerable.

During November the State's mines yielded gold worth \$2,124,000. The total to date is \$624,000,000, and \$128,000,000 in dividends. Some January returns were as follows: Horse-Shoe, 7412 oz. from 16,416 tons, with \$32,000 profit; Ivanhoe, 7289 oz. from 19,123 tons, with \$43,000 profit; and South Kalgoorli, 2911 oz. from 10,022 tons, with \$9600 profit. Costs at the last were \$4.32 per ton. Spare lathes at Kalgoorlie are now used to turn shells for the army.

THE MINING SUMMARY

The news of the week as told by our special correspondents and compiled from the local press.

ALASKA

The total trade of the Territory in 1915 was \$82,871,122, an increase of \$12,368,254. Exports amounted to \$54,856,815, including antimony, \$189,345; copper ore and matte, \$12,351,163; fish and fish products, \$19,655,239; gypsum, \$65,800; lead ore and matte, \$31,176; marble, \$104,888; tin ore, \$79,171; and gold and silver, \$16,099,411. Shipping amounted to 1609 vessels of 1,927,727 tons.

JENSEN

On February 28 the Alaska Treadwell and Alaska United companies paid 75c and 39c per share, respectively.

ARIZONA

COCHISE COUNTY

During January the Shattuck-Arizona mine produced 534 oz. gold, 39,369 oz. silver, 267,853 lb. lead, and 1,565,224 lb. copper.

In order to protect itself against possible fluctuations in copper, the Copper Queen company has informed custom ore producers in Mexico that new rates will be effective on March 15.

GILA COUNTY

In its mining and livestock edition of 36 pages the *Arizona Record* of Globe deals in an interesting way with the mining industry of the district. The text is well illustrated.

MOHAVE COUNTY

Charles S. Sprague and associates, who have taken over the Merritt, Yankee, and Dome properties, aggregating 150 acres in the heart of the Oatman district, announce that they will start active development at once with J. K. Turner, of the Jumbo Extension company, as consulting engineer for this merger, the Oatman United. Equipment which will be placed upon the ground will be of capacity adequate for working down to 1000 ft. depth.

Development has been started at the Oatman-Jumbo mine, midway between the United Eastern and Gold Road. A good ore zone occurs near a rhyolite dike.

PIMA COUNTY

On February 21 the new railway between Gila Bend and Ajo, 49 miles, at the New Cornelia copper mine, commenced a regular schedule. Large quantities of structural material are arriving at the property. A machine-shop is being built.

At Ginsjakt, 15 miles south-east of Cornelia, an old centre, lead-zinc-silver ore has been opened.

CALIFORNIA

AMADOR COUNTY

To celebrate resumption of work at the old Eureka mine, between 2500 and 3000 people participated in the function at Sutter Creek on February 24. The event is said to be the greatest ever held in the county. Water is being removed from the old shaft to permit putting in the collar-sets.

BUTTE COUNTY

The Woolley manganese mine at Clipper Mills will supply ore for the smelter of the Noble Electric Steel Co. in Shasta county. The ore will be hauled in trucks to Oroville, and then railed to Heroult.

According to A. Buckbee of Utah the Forbestown district will be busy this summer, but a merger of properties is desirable for profitable work. He considers the ore suitable for cyanidation.

COLORADO COUNTY

The first quicksilver that has arrived at Williams, passed through there last week from Wilbur Springs on its way to San Francisco. This marks the resumption of production in the Sulphur Creek district.

MARIPOSA COUNTY

To take over a lease or option to purchase 960 acres of the Fremont or Mariposa Grant, held by W. F. Deaner, the Elizabeth Mines was recently incorporated at Sacramento by Edward F. Dalton, R. Miller, and C. M. Coffing of that city, Edward M. Herberger of Sutter Creek, and Edward R. Solinsky of San Francisco. The capital is \$500,000.

The Mountain King Mining Co.'s power-plant on the Merced river is described in the *Journal of Electricity, Power & Gas* for February 12 by Rudolph W. Van Norden. A brief history of the mine is also given. The dam is 88 ft. high, averaging 6 ft. high on the down-stream side, and 3 ft. on the up-stream side. The flume is 2737 ft. long, costing \$4.128 per linear foot. It is semi-circular, 6 ft. 4 in. wide at the top, capable of carrying 3280 miners' inches, or 82 cu. ft. per second, with a grade of 5.28 ft. per mile. It was constructed in difficult country. The power-house includes a 450-hp. Francis scroll-case turbine, direct connected to a 350-kva. generator. The operating head is from 63 to 59 ft., depending on the state of the canyon where the plant is erected. The transmission-line is 8700 ft. long, carrying 4000 volts. The current is transformed to 410 volts for the motors, and 220 volts for the locomotive. At the mill are 11 motors of from 3 to 100 hp. The total cost of the power-plant was \$35,169, or \$88 per horse-power for 400 hp. delivered.

NEVADA COUNTY

(Special Correspondence.)—The Orleans mine, adjoining the Empire, is being operated with Albert Crase as superintendent. The property was formerly a good producer, and is thought to contain the extension of the Empire vein. Inwatering of the 800-ft. shaft is proceeding, and sinking will continue to a depth of 1000 ft. It is equipped with a good hoist and pumping plant.

At the Union Hill developments are proceeding from numerous points, particularly at 600 ft., where good ore was uncovered last fall. Water has recently caused considerable trouble, but this annoyance is being rapidly overcome. Several small shipments of tungsten-bearing ore have been made. The North Star Mines Co. is preparing to erect a large office building near the Central shaft, and to transfer its offices to this point from the North Star mine. A large amount of new work is going on below the 6000-ft. level, with ore of excellent grade exposed at several faces.

Negotiations for the acquisition of the Onstomah mine, at Nevada City, by Utah people are proceeding. The Utah interests are represented by F. M. Wichman, of the Utah Metals Mining and Bingham-New Haven companies, and Charles T. Law. The Onstomah has been a good producer and is well equipped. It is operated by the Onstomah Mining Company.

The new plant being erected near Spenceville for the Queen Regent Merger Co. is rapidly nearing completion and will start treatment of copper-gold ore before the end of March. A

large amount of new underground work is proceeding, and indications are good for a steady output. Several copper claims in this district are being examined in the interests of San Francisco people. The ore frequently ranges from \$20 to \$50 per ton, with considerable gold present.

Grass Valley, February 20.

Although there is no shortage of men in the Grass Valley-Nevada City district, it is reported that a good number have left for the large copper centres where wages are now so high.

Development at the Golden Center mine at Grass Valley continue to be good, and additions to the mill are contemplated.

SACRAMENTO COUNTY

An extensive deposit of chromic-iron ore, in the Negro Hill district, 10 miles above Folsom, has been located by D. E. Wiley and others of that town.

SIERRA COUNTY

In the issue of February 26 it was stated that W. Hague was connected with the Mugwump Mines Co., operating near Alleghany; this is not correct.

SISKIYOU COUNTY

H. J. Barton of Yreka has re-opened an old quicksilver mine in this county, which will be managed by W. Forstner.

The mineral returns for 1915 now coming to the statistical division of the State Mining Bureau, under direction of Fletcher Hamilton, state mineralogist, are beginning to show some interesting figures relative to the production of the past

quicksilver resources and particularly in regard to the metallurgy has exhausted the Bureau's stock of Bulletin No. 27, which was printed in 1908. It is the intention of the State Mineralogist to revise that bulletin in the near future, and bring it up to date. In this connection, an investigation is now under way relative to the possibilities of concentration, including also experiments on oil flotation of cinnabar. The results of these investigations will form a chapter in the new bulletin. Of importance to the metallurgy of quicksilver is the work being done at New Almaden, as described in the PRESS of February 19.

COLORADO

BOULDER COUNTY

The old Caribou silver mine at Cardinal has been acquired by the Caribou Mines and Mills Co., a Chicago corporation. The property was operated by the Cariman Mining & Milling company. A large production of tungsten ore continues from the county.

CLEAR CREEK COUNTY

The partly-erected Malm mill at Georgetown is to be completed at once, \$50,000 having been secured by Mrs. Brownlee, of the Stanley mine at Idaho Springs. The first unit is of 50-ton capacity. The process is electrolytic.

TELLER COUNTY (CRIPPLE CREEK)

(Special Correspondence.)—Several new water-courses have been cut recently in the Roosevelt drainage-tunnel. For a few days the estimated flow from the portal was over 20,000 gal. per minute; however, the last official measurement recorded the flow of 16,000 gal., after the heavy flow had subsided somewhat.

The annual report of the Mary McKinney company shows the total net income for 1915 as being \$27,517, with a cash balance on hand at December 31 of \$92,132.

Work on the concrete foundations of the Dillon shaft has been started. The Granite Gold Mining Co. will shortly install a powerful electric hoist and compressor at the Dillon.

Cripple Creek, February 24.

IDAHO

BONNER COUNTY

Near Metaline Falls the Lead & Zinc Co. is treating 100 tons of ore daily, in charge of Lewis P. Larson. Mining is by open cut. A

large quantity of ore has been developed. A 1000-ton mill is to be erected next summer.

BOUNDARY COUNTY

The Idaho Continental mine, 26 miles north of Bonners Ferry, will soon have its new 300-ton mill completed. It will replace the one burned in July, 1915. A 12-drill compressor and 1800-ft. aerial tram have also been erected. Shipments of crude ore average two carloads per week, assaying 58% lead and 25 oz. silver. This is hand-sorted. About 30,000 tons of milling ore is ready for treatment. The mine is considered an important one.

LEMMING COUNTY

At the Pittsburg-Idaho mine, near Gilmore, a good shoot of gold ore has been opened for 150 ft. in length, an 18-in. streak averaging over \$700 per ton. The mine generally is in excellent condition.

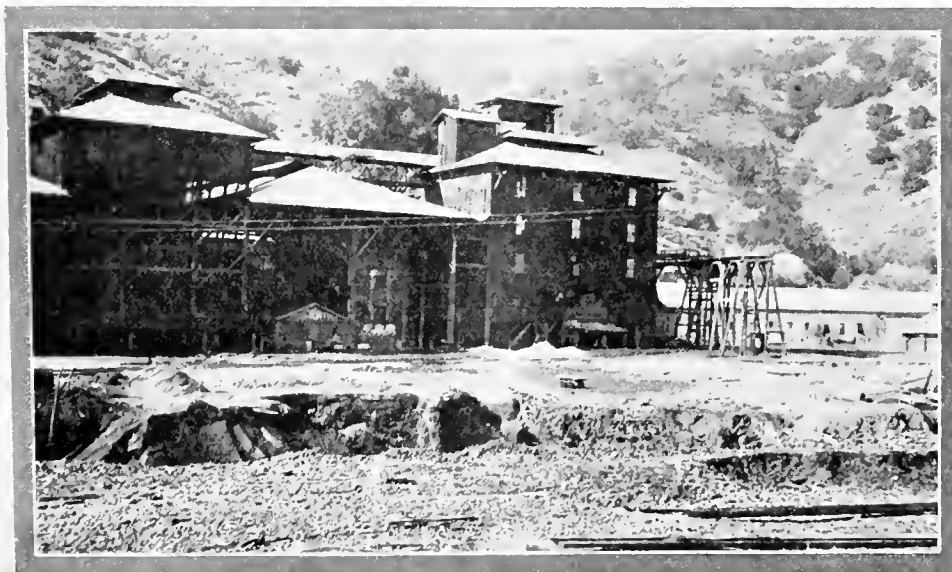

THE QUICKSILVER FURNACE BUILDINGS AT NEW ALMADEN.

year. Replies have been received from a sufficient number of the quicksilver mines of the State so that a fairly close estimate of the output can be made. This is placed at 12,450 flasks of 75 lb. each. The year's output was valued at \$1,968,210, or nearly double that of 1914, which was \$557,846 for 11,373 flasks.

Some interesting developments are taking place at the present time as regards concentration of quicksilver ores, particularly at the Oat Hill and Aetna mines in Napa county, at the New Idria mine in San Benito county, the Kings in King county, and at the Oceanic in San Luis Obispo county. During a trip last week to the Napa County mines, the mining statistician of the Bureau, W. W. Bradley, observed several men with rockers concentrating cinnabar from the sand and gravel in the ravines and creeks below Oat Hill. At the present high price of quicksilver, they are making good wages. The unprecedented demand for information on California's

MICHIGAN

THE COPPER COUNTRY

Diamond-drilling continues at the White Pine Extension recent cores showing rich ore with fine flaky copper similar to that in the White Pine mine.

The Onondaga Copper Co. has issued its report for 1915. On February 1, 1914, the company started No. 6 diamond-drill hole with \$74,675 cash. No. 6, 7, 8, and 9 holes were bored, the last on September 21, 1914. None of the lodes in the section drilled contained copper in commercial quantities. Work was stopped for a time, then resumed in the Nonesuch basin in July 1915. A hole in one corner passed through a barren lode at 1199 ft. Further work will be done. On February 1, 1916, the balance was \$46,585.

Haulage of ore in the region is again normal, after a strenuous fight against snow and bad weather. The Mineral Range line is carrying ore from 14 mines, at the rate of over 500,000 tons per month. The system covers 100 miles of track in charge of T. W. Smith.

The Calumet & Hecla Mining Co. and subsidiaries report their January output as follows:

Ahmeek, 1,239,669; Alouez, 499,998; Calumet & Hecla, 5,736,261; Centennial, 138,961; Isle Royale, 851,279; La Salle, 159,469; Osceola, 1,223,184; Superior, 296,397; Tamarack, 505,789; and White Pine, 377,616 pounds of copper.

MISSOURI

JASPER COUNTY

The A. W. C. mine, west of Joplin, controlled by A. W. Canada and W. O. Cragg, was sold last week to J. T. M. Johnston of St. Louis and A. Gibson of Joplin, for \$300,000. The transaction includes 49 acres, leases on 159 acres, three mills, and one being erected. Four years ago the original owners bought the 49 acres for \$500. The ore is in sheet formation at a depth of 180 ft. The sale is one of the most important recorded in the district.

The February 20 issue of the *Joplin News Herald* is its 1916 mining and industrial number of 92 pages, in which is a mass of illustrated information dealing with mining and milling in the Missouri-Kansas-Oklahoma zinc-lead region.

MONTANA

BLAINE COUNTY

(Special Correspondence.)—Gold mining at present is active in the Little Rocky mountains. A 200-ton cyanide plant is in operation at the August property near Landusky. Some ore assaying \$40 per ton has been found.—The 600-ton cyanide plant of the Ruby Gulch company is working at capacity on ores that usually assay only \$2 to \$3 per ton, but the large orebody has permitted such low costs that the extraction of the gold has proved profitable.—The Beaver Creek company has completed a 159-ton cyanide plant, but it is not yet in operation. This company has developed a good orebody, and has been sold to Eastern people.—Work is also being done on other mines and prospects in the district. About 120 men are now employed in these mines.

Landusky, February 21.

LINCOLN COUNTY

(Special Correspondence.)—Vanadium ore has been found here under entirely new conditions, that is, in rock that was never known to contain vanadium. A prospector who is developing what is known locally as the Rainy creek copper claims, encountered a very tough rock that he could not break or name until a member of the U. S. Geological Survey staff visited the property and took samples of the rock to Washington. Analysis proved it to contain 4% vanadium, as well as other minerals. A geologist from Essen, Germany, came here, and made thorough tests of the ore and reported assays from 0.14 to 7.07% metallic vanadium. The 7.07% ore was from a sulphide

ore not noticed or probably not seen by the American geologists. The ore occurs along both the foot and hanging walls of each of the 16 different veins in the claims, and is from 8 to 36 in. wide. The oxidized ore is a brownish black and the sulphide a silver-white. The ore is abundant, and sometimes appears in the copper ore as well as in the country-rock or general formation. Both the oxide and sulphide of molybdenite is also found in quantity in these claims, which are in the foot-hills of the Cabinet mountains, about 2½ miles from the Great Northern railroad.

Libby, February 6.

SILVERBOW COUNTY

During January the Butte & Superior mill treated 49,428 tons of ore, yielding 10,536 tons of concentrate worth \$191.6 per ton, an increase of \$15, at a cost of \$3.05 per ton.

Ore from the Butte-Alex Scott mine, now owned by the Anaconda, is being treated at the Washoe works in place of the East Butte smelter, where only one furnace is in blast. East Butte's flotation plant is treating 600 tons per day. The company may erect an acid plant to treat Butte-Duluth ore.

Anaconda is increasing its acid plant by 50 tons per day. Its Emma mine has been unwatered to 800 ft. Diamond-drilling in the Czarolah mine has cut a wide vein of zinc ore.

NEVADA

ESMERALDA COUNTY

During January the Goldfield Consolidated company treated 31,000 tons for a profit of \$59,061. Costs were \$5.07 per ton. Development covered 3387 ft., at \$5.06 per foot, revealing little of importance. The 50-ton flotation plant is almost ready for work.—The Nevada Metal Extraction Co.'s 150-ton flotation plant is also nearly complete.

LINCOLN COUNTY

To treat a large dump of gold-silver-lead tailing at Bullionville, worth \$18.50 per ton, the Prince Consolidated company of Pioche is to erect a 100-ton flotation plant. Anthony H. Godbe is president.

NYE COUNTY

During the past week Tonopah mines produced 8307 tons of ore worth \$174,786. Bullion worth \$91,741 was shipped. The Extension will pay 10c. per share, or \$127,280, and the Belmont 12½c., equal to \$187,500. The totals of these companies is \$1,209,853 and \$8,918,922 respectively.—During the second half of 1915 the Jim Butler's net income was \$141,703. Silver stored amounts to \$183,924, at 50c. per ounce.

STOREY COUNTY

Development at the north end of the Comstock continues to give encouraging results. In sinking a winze below 2500 ft. in the Sierra Nevada, three feet of \$25 ore has been cut.—From 2400 and 2500 ft. the Union Con. extracted 436 tons worth \$10,000.—Prospecting at 2500 and 2700 ft. in the Mexican shows favorable porphyry and quartz. The mill treated 521 tons of custom ore averaging \$23 per ton.—Work at 2700 ft. in the Ophir and Con. Virginia continues.—The Jacket-Crown Point-Belcher Mines Co. sent 754 tons of dump-ore to the mill.—The usual work proceeded at the Pumping Association's area.

NEW MEXICO

According to John H. Leavell of Salt Lake City, southwestern New Mexico is busier than ever and optimistic. Mining centres dead for 20 years are making large profits, notably at Deming and Cook's Peak districts.

COLEMAN COUNTY

In Bulletin 620-N of the U. S. Geological Survey, Willis T. Lee describes the Aztec gold mine at Baldy. In 1870, 1904, and 1910, it was described by R. W. Raymond, F. A. Jones, and Waldemar Lindgren respectively. The mine was a famous

producer 45 years ago. A large body of high-grade ore was entered in August, 1914, and in the middle of 1915 the 10-stamp mill was crushing \$107.60 ore. Concentrate is sent to the smelter. The property lies at an altitude of 10,000 ft., connected by wagon-road with Ute Park, the terminus of a branch of the Santa Fe railway. Placer mining was done extensively in 1867 on Willow creek, on the west slope of the mountain, yielding \$2,250,000. In 1868 the source of this gold was found, the outcrop of the Aztec mine. About \$1,000,000

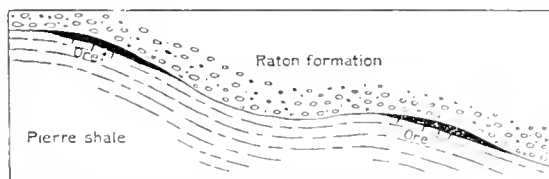

SKETCH SHOWING OCCURRENCE OF GOLD ORE IN THE BALDY MINE, NEW MEXICO.

was extracted in the first four years. As a result of its production an English syndicate bought the Maxwell land grant of 1,750,000 acres. The rich ore became exhausted. In 1872 litigation commenced, and for over 40 years efforts were made to find other ore-shoots. In 1909 J. T. Sparks confined his attention to the quartzite-slate contact, and later on E. U. Deshayes found the present rich shoot. Some of the ore is found in small pockets and stringers in the conglomerate sandstone, but most of it that is worked at present is in the underlying shale, into which it extends for a few inches to five feet or more. The richest and largest bodies occur on the down-slope side of the crests of the minor folds, as shown in the sketch. The ore is free-milling.

UTAH

BEAVER COUNTY

The Leonora Mining & Milling Co., operating in the Star district, has issued a report for 1915. Development amounted to 1050 ft. at \$5.25 per foot. The manager, John Matson, is optimistic as to the future. Cash on hand amounts to \$1747.

JUAB COUNTY

The new plant of the Tintic Milling Co. is in operation. The Dragon Consolidated and Iron Blossom mines are supplying some ore. Storage-bins have a capacity of 2000 tons. The crusher and rolls, of 500-ton capacity, reduce the ore to $\frac{3}{4}$ in. This is mixed with salt, etc., and further reduced. The fine ore is chloridized roasted in three Holt-Dern and one Knight-Christensen furnaces. The roasted product is then leached, and the metals precipitated.

SALT LAKE COUNTY

Application has been made at Salt Lake City for a franchise to construct an electric railway from 10th street south on 21st east street, through Holiday, up Big Cottonwood canyon to the mines and Brighton. The road would be principally for hauling ore and supplies.

With the work under way and contemplated the Little Cottonwood district will produce more ore this year than ever before.

TOOELE COUNTY

Another shipment of ore from the O. K. Silver mine 18 miles west of Mercur settled for 495 oz. silver and 0.02 oz. gold per ton.

VIRGINIA

WYTHE COUNTY

The Beaver Valley Mining Co. is shipping zinc carbonate ore regularly from Ivanhoe, three carloads going out last week. S. L. Boggs is manager.

WASHINGTON

CHELAN COUNTY

(Special Correspondence.)—The Holden Gold & Copper Mining Co. has leased and bonded its large and extensively developed property near Lake Chelan to Californians. Work is to be started on April 1. A larger compressor will be ordered and eventually a railway and smelter. The property was formerly bonded to Jay P. Graves for the Granby company, of Grand Forks, B. C., which did about 5000 ft. of development and opened a considerable quantity of low-grade copper-gold ore, but gave up its privileges when it started at the Hidden Creek mine.

Chelan, February 10.

LINCOLN COUNTY

(Special Correspondence.)—It is reported that the Old Reliable, Wisconsin, and Dakota claims in the Egypt district have been sold to Salt Lake City people for \$20,000. The ground will be equipped with machinery as soon as the weather permits. It is said that there is 50,000 tons of ore on the dump, averaging \$15 per ton.

Crystal, February 10.

OKANOGAN COUNTY

(Special Correspondence.)—The Adirondack Mining Co. has installed at Sheridan an air-compressor, to drive six machine-drills, and a 75-hp. steam boiler and hoist. A dam is under construction to conserve 3,000,000 gal. of water, and a mill will be constructed in the spring. A contract has been awarded to Laurie Brothers to cut 1,000,000 ft. of lumber. The mill is expected to cost about \$8000. The company is employing eight men on a 30-ft. vein of low-grade milling ore, a 3000-lb. sample of which has been forwarded to Salt Lake City, to be tested for a suitable process. The ore contains about equal value in gold and silver.

A carload of antimony ore was shipped from the Gold Creek mine, in the Methow district, to Chicago. The company is preparing to build a small smelting plant this winter.

In a 4000 ft. adit which penetrates the northern slope of Palmer mountain a 12-ft. body of high-grade silver-lead ore was recently found at a depth of about 1600 ft. in the Ivanhoe mine, and another similar shoot was cut a short distance beyond it.

In the Myers Creek district work has been resumed at the Grant mine, on Copper mountain.

At the Gold Ax, Recco, Copper Queen, Eagle, and Rebecca mines in various districts a good deal of work is under way. Sheridan, February 10.

STEVENS COUNTY

The newly-organized Loon Lake Copper Co. is to unwater and develop the old Kemp-Komar mine near Loon Lake, 38 miles north of Spokane. Machinery has been ordered. The Blue Bird-Dupont claims adjoining are also to be developed.

CANADA

BRITISH COLUMBIA

The preliminary review and estimate of mineral production of this province in 1915, compiled by Wm. Fleet Robertson, has been issued as Bulletin No. 1, 1916, by the Bureau of Mines. The publication covers 50 pages, which include some interesting matter. The yield of \$29,299,564 is an increase of \$2,910,739, mostly in copper and zinc.

The Trail reduction works of the Consolidated Mining & Smelting Co. is of considerable importance to this province, as it treats ore from the company's own mines and a large number of other companies, some in Washington. Copper, gold, lead, and silver are produced at present in the refineries, while soon the new electrolytic zinc plant will turn out good spelter. A great deal of electric power is used, and 1100 men

are kept busy. The company has purchased the common stock of the West Kootenai Power & Light Co., \$75 par value of Consolidated stock for each \$100 par value of Power stock.

During 1915 the Trail smelter treated 441,985 tons of ores and concentrates, 369,148 tons from the Canadian Consolidated mines, 49,271 tons from custom ores in the Province, and 10,266 tons from the United States, the Republic district of Washington contributing 25,402 tons. Metal output was as follows: 146,732 oz. gold, 2,900,639 oz. silver, 11,217,668 lb. lead, and 5,573,965 lb. copper, also some zinc.

According to O. B. Smith, general superintendent of mines for the Granby Consolidated company, there is considerable activity in several parts of the Province, especially on Alice arm, a branch of Observatory inlet, on which is situated the Hidden Creek mine and Anyox smelter. An auxiliary steam power plant is to be erected at Anyox to prevent a recurrence of reduced tonnage. In March the plant will treat 90,000 tons. On March 1 wages of miners were raised to \$4.25 per shift, while copper is at 22c. The pay-roll includes 800 men.

The British Columbia Metals Corporation has been organized by G. Weaver Loper of the Lucky Jim Zinc Mines Co. to erect reduction works for complex ores at Nelson. Ore containing 25% zinc, 19% lead, and a little copper, gold, and silver, will be treated by the Malm process, in charge of Edward Dedolph of Kaslo.

The Standard Silver-Lead company of Silverton pays 2½c. or \$50,000, on March 10. Bad weather is interfering with operations.

YUKON

Spring repair work is under way at the Canadian Klondyke and Yukon Gold companies' dredges.

KOREA

The Oriental Consolidated reports its January clean-up as \$144,939.

MEXICO

(Special Correspondence.)—United States customs returns at El Paso show the following shipments from Mexico during 1915:

| Product | Tons. | Value. |
|--------------|---------|-------------|
| Gold | 1,000 | \$1,248,627 |
| Gold ore | 100,000 | 116,522 |
| Silver | 100,000 | 2,718,630 |
| Silver ore | 100,000 | 807,181 |
| Copper ore | 13,120 | 190,487 |
| Copper matte | 1,989 | 106,726 |
| Copper bars | 568 | 118,055 |
| Lead | 39,489 | 219,507 |
| Lead bullion | 165 | 10,971 |
| Zinc | 23,914 | 1,068,449 |

Imports during the first four months were heavy, then they dropped largely toward the end of the year, when the revolution was at its height.

El Paso, February 4.

During 1915, 19,218,788 bbl. of crude oil was shipped from Tampico to United States ports, compared with 11,746,371 bbl. in 1914.

SONORA

The Moetzana company at Nacozeni is to sink a new shaft; the deepest at present is 1300 ft. Two electric hoists of 2500-ft. capacity are to be installed. Mill concentrate is being dried to reduce freight on the railroad to Douglas. A third aerial tram to dispose of tailing, 2900 ft. long, has been erected. About 1500 men are employed. It is rumored that the company may erect a cyanide plant for its Churunibabi mines. Several mines in the Cuppas district are busy producing ore.

In spite of poor railroad facilities, shipments of products through Agua Prieta during January totaled 16,368 tons worth \$2,250,300. From Nacozeni came 9450 tons of copper worth \$1,387,900. Silver was valued at \$597,800, and gold \$264,600.

PERSONAL

George E. Fautsch is at Oatman.

F. A. Hull, of Seattle, is in California.

Edmund Jessen has returned from New York.

C. S. Hutzig is now at 27 William street, New York.

Lucien S. Roue, of Fairbanks, is visiting San Francisco.

Walter Laman Brown is in the London office of the Belgian Relief Commission.

L. D. Fay, of Oakland, will re-open the Twin Peaks quick-silver mine near Callstoga.

E. GYMON SPRUENY has been elected president of the Engineers Club, New York.

SPENCER C. BROWN is now consulting mining engineer to the Midvale Steel Company.

WILL C. HIGGINS, editor of the *Salt Lake Mining Review* is making a tour of California.

LOUIS A. WRIGHT is on his way to Santiago, Chile, where he expects to remain for two years.

E. C. VOORHIES is president and J. H. MACKENZIE is general manager of the Atolia Mining Co.

CHARLES T. KIRK, of Albuquerque, N. M., has been examining tungsten mines in Boulder county, Colorado.

W. L. FRASER has left the employ of the North Star Mines and is now with J. R. McKINNIE, at Los Angeles.

OTIS F. HEIZER, of Idaho Springs, Colorado, will be in Tuolumne, California, for the next two months.

P. D. BURR, on his return to San Francisco from the Nevada Packard mine, has gone to Inyo county, California.

J. F. MITCHELL-ROBERTS is in New York. He will sail from San Francisco for Korea at the end of the current month.

W. J. McATEE, formerly mill superintendent of the Nevada Hills Mining Co., is now with the Miami Copper Company.

WILLIAM C. RUSSELL has been appointed general manager for the Caribou Mines and Mills Co., Boulder county, Colorado.

WILLIAM A. BURR has been examining the Kromitek mines in Madera county, California. He will be going shortly to China.

J. M. MITCHELL, mining engineer, formerly of Flushing, N. Y., is with the Homestake Mining Co. at Lead, South Dakota.

JOHN W. FINCH, in a New York hospital, is convalescing from typhoid most satisfactorily, his many friends will be glad to hear.

H. S. WEIGMAN, formerly manager of the Kok Kang Kol mine in Korea, has obtained a commission in the Artists Rifle Corps, and will probably be attached to the engineering branch of that corps.

H. J. STANDER, who is doing flotation experimental work for the Arizona State Bureau of Mines, has been called to Brunswick, Georgia, for consultation work with the Yaryan Oil & Rosin Company.

C. W. MERRILL will give five lectures at the Mining Building of the University of California on 'Cyanidation.' The dates and times are as follows: at 4 p.m. on Monday, Wednesday, and Friday (March 6, 8, and 10), and at 5 p.m. on Tuesday and Thursday (March 7 and 9).

CHARLES WILLARD HAYES, formerly chief geologist to the U. S. Geological Survey, died on February 8, 1916, at the age of 57. He left the Survey to become mining geologist to the Mexican Aguila Oil Co. Previous to joining the Survey he was principal of a high school in Ohio. His first appointment on the Survey was in 1887 as an assistant and in 1902 he became chief. He was a graduate of Oberlin College and Johns Hopkins University, a member of the Geological Society of America, the American Institute of Mining Engineers, and the Mining and Metallurgical Society of America.

THE METAL MARKET

METAL PRICES

San Francisco, March 1.

| | |
|---|-----------|
| Antimony, cents per pound..... | 44 |
| Electrolytic copper, cents per pound..... | 27.75 |
| Molybdenum; 90% MoS ₂ , per pound..... | \$1.40 |
| Pig lead, cents per pound..... | 6.55—7.50 |
| Platinum: soft metal, per ounce..... | \$88 |
| Platinum: hard metal, 10% iridium, per ounce..... | \$92 |
| Quicksilver: per flask of 75 lb..... | \$275—290 |
| Spelter, cents per pound..... | 22 |
| Tin, cents per pound..... | 43 |
| Zinc-dust, cents per pound..... | 30 |

ORE PRICES

San Francisco, March 1.

| | |
|---|-------------|
| Antimony: 50% product, per unit, of 1% or 20 lb.... | \$2.25 |
| Chrome: 40% and over, f.o.b. cars California, per ton | 11.00 |
| Magnesite: crude, per ton, f.o.b..... | 8.00 |
| Magnesite: plastic, no iron and lime, calcined, ton.. | 30.00 |
| Magnesite: refractory, 11% iron, dead-burned, ton.. | 35.00 |
| Manganese: 50% metal, 8% silica, per ton..... | 12.00 |
| Tungsten: minimum 60% WO ₃ , per unit of 20 lb.... | 60.00—65.00 |

At Boulder, Colorado, \$60 per unit is being paid for tungsten ore.

New York, February 25.

| | |
|---|--------|
| Antimony: 50%, per unit of 1%, or 20 lb., in 100-ton lots.. | \$2.50 |
| Tungsten: 60%, per unit of 1%, or 20 lb..... | 70.00 |

EASTERN METAL MARKET

(By wire from New York.)

March 2.—Copper is quiet, but fundamentally strong; there are few sellers of lead, independents getting premiums; zinc is quiet, though London is strong.

SILVER

Below are given the average New York quotations, in cents per ounce, of fine silver.

| Date. | Average week ending | | | | |
|------------------|---------------------|--------------|-------|--|--|
| Feb. 24..... | 57.00 | Jan. 19..... | 56.68 | | |
| " 25..... | 57.06 | " 26..... | 57.11 | | |
| " 26..... | 56.87 | Feb. 2..... | 57.02 | | |
| " 27 Sunday..... | | " 9..... | 56.79 | | |
| " 28..... | 56.62 | " 16..... | 56.62 | | |
| " 29..... | 56.62 | " 23..... | 56.86 | | |
| Mar. 1..... | 56.62 | Mar. 1..... | 56.79 | | |

| Monthly averages. | | | | | | |
|-------------------|-------|-------|-------|------------|-------|-------|
| Jan. | 1914. | 1915. | 1916. | 1911. | 1915. | 1916. |
| Jan. | 57.58 | 48.85 | 56.76 | July | 51.90 | 47.52 |
| Feb. | 57.53 | 48.45 | 56.74 | Aug. | 54.35 | 47.11 |
| Mar. | 58.01 | 50.61 | | Sept. | 53.75 | 48.77 |
| Apr. | 58.52 | 50.25 | | Oct. | 51.12 | 49.40 |
| May | 58.21 | 49.87 | | Nov. | 49.12 | 51.88 |
| June | 56.43 | 49.03 | | Dec. | 49.27 | 55.31 |

Small shipments of metal from Cobalt and Tonopah seem to indicate a desire to hold for higher prices. American silver operators maintain a bullish tendency.

London advises a good undertone. Reduced stocks at Bombay points to the necessity of fresh purchases, which should have a sustaining influence on London prices. Europe is buying fitfully, making an oscillating market.

COPPER

Prices of electrolytic in New York, in cents per pound.

| Date. | Average week ending | | | | |
|------------------|---------------------|--------------|-------|--|--|
| Feb. 24..... | 27.12 | Jan. 19..... | 23.70 | | |
| " 25..... | 27.12 | " 26..... | 24.93 | | |
| " 26..... | 27.12 | Feb. 2..... | 25.45 | | |
| " 27 Sunday..... | | " 9..... | 26.16 | | |
| " 28..... | 27.12 | " 16..... | 27.06 | | |
| " 29..... | 27.12 | " 23..... | 27.25 | | |
| Mar. 1..... | 27.12 | Mar. 1..... | 27.12 | | |

| Monthly averages. | | | | | | |
|-------------------|-------|-------|-------|------------|-------|-------|
| Jan. | 1914. | 1915. | 1916. | 1911. | 1915. | 1916. |
| Jan. | 14.21 | 12.60 | 24.30 | July | 13.26 | 19.09 |
| Feb. | 14.46 | 14.38 | 26.62 | Aug. | 12.34 | 17.27 |
| Mar. | 14.11 | 14.80 | | Sept. | 12.02 | 17.69 |
| Apr. | 14.19 | 16.64 | | Oct. | 11.10 | 17.90 |
| May | 13.97 | 18.71 | | Nov. | 11.75 | 18.88 |
| June | 13.60 | 19.75 | | Dec. | 12.75 | 20.67 |

Predicted that the Inspiration directors will declare \$1 per share quarterly, and possibly something extra.—Wolverine directors may pay \$5 per share.

Exports of copper products in January amounted to \$7,932,531.

The Chile Copper Co. is treating 40,000 tons of ore per week.

A Michigan company has closed a contract with the German government, for the following metal: 500 tons of cakes, bars,

and ingots, to be delivered to warehouse in New York each month for five months, commencing in March, but not to be delivered until after the War, at 28c. per lb. This shows that Germany considers that the price of copper will keep up after the War.—The Mass company has sold copper for April delivery at 28.75 cents.

The 1915 output of the United Verde was 45,127,832 lb. copper, 902,880 oz. silver, and 28,221 oz. gold, against 32,449,116 lb., 646,285 oz., and 21,393 oz. respectively. Cash on January 1 amounted to \$1,163,044.

LEAD

Lead is quoted in cents per pound, New York delivery.

| Date. | Average week ending | | | | |
|------------------|---------------------|--------------|------|--|--|
| Feb. 24..... | 6.30 | Jan. 19..... | 5.90 | | |
| " 25..... | 6.30 | " 26..... | 6.07 | | |
| " 26..... | 6.30 | Feb. 2..... | 6.10 | | |
| " 27 Sunday..... | | " 9..... | 6.12 | | |
| " 28..... | 6.30 | " 16..... | 6.26 | | |
| " 29..... | 6.30 | " 23..... | 6.30 | | |
| Mar. 1..... | 6.30 | Mar. 1..... | 6.30 | | |

| Monthly averages. | | | | | | |
|-------------------|-------|-------|-------|------------|-------|-------|
| Jan. | 1914. | 1915. | 1916. | 1911. | 1915. | 1916. |
| Jan. | 4.11 | 3.73 | 5.95 | July | 3.80 | 5.59 |
| Feb. | 4.02 | 3.83 | 6.23 | Aug. | 3.86 | 4.67 |
| Mar. | 3.94 | 4.04 | | Sept. | 3.82 | 4.62 |
| Apr. | 3.86 | 4.21 | | Oct. | 3.60 | 4.62 |
| May | 3.90 | 4.24 | | Nov. | 3.68 | 5.15 |
| June | 3.90 | 5.75 | | Dec. | 3.80 | 5.34 |

A record price was paid for 80% lead product at Joplin last week, namely, \$89 per ton.

On March 20 the St. Joseph Lead Co. will pay a 2½% dividend, an increase on last quarter of 1%.—On March 4 the Bunker Hill & Sullivan pays two dividends, totaling \$163,500; the amount to date is \$17,100,000.

QUICKSILVER

The primary market for quicksilver is San Francisco, California being the largest producer. The price is fixed in the open market, according to quantity. Prices, in dollars per flask of 75 pounds:

| Date. | Week ending | | | | |
|-------------|-------------|--------------|-----|--|--|
| Feb. 2..... | 295 | Feb. 16..... | 300 | | |
| " 9..... | 295 | Feb. 23..... | 300 | | |
| | | Mar. 1..... | 285 | | |

| Monthly averages. | | | | | | |
|-------------------|-------|-------|--------|------------|-------|--------|
| Jan. | 1914. | 1915. | 1916. | 1911. | 1915. | 1916. |
| Jan. | 39.25 | 51.90 | 222.00 | July | 37.50 | 95.00 |
| Feb. | 39.00 | 60.00 | 295.00 | Aug. | 80.00 | 93.75 |
| Mar. | 39.00 | 78.00 | | Sept. | 76.25 | 91.00 |
| Apr. | 38.90 | 77.50 | | Oct. | 53.00 | 92.90 |
| May | 39.00 | 75.00 | | Nov. | 55.00 | 101.50 |
| June | 38.60 | 90.00 | | Dec. | 53.10 | 123.00 |

The quicksilver market is easier, with lower prices.

ZINC

Zinc is quoted as spelter, standard Western brands, New York delivery, in cents per pound.

| Date. | Average week ending | | | | |
|------------------|---------------------|--------------|-------|--|--|
| Feb. 24..... | 21.00 | Jan. 19..... | 18.10 | | |
| " 25..... | 21.00 | " 26..... | 19.92 | | |
| " 26..... | 20.75 | Feb. 2..... | 18.67 | | |
| " 27 Sunday..... | | " 9..... | 19.08 | | |
| " 28..... | 20.50 | " 16..... | 19.92 | | |
| " 29..... | 20.50 | " 23..... | 21.35 | | |
| Mar. 1..... | 20.50 | Mar. 1..... | 20.71 | | |

| Monthly averages. | | | | | | |
|-------------------|-------|-------|-------|------------|-------|-------|
| Jan. | 1914. | 1915. | 1916. | 1911. | 1915. | 1916. |
| Jan. | 5.11 | 6.30 | 18.21 | July | 4.75 | 20.54 |
| Feb. | 5.22 | 9.05 | 19.99 | Aug. | 4.75 | 14.17 |
| Mar. | 5.12 | 8.40 | | Sept. | 5.16 | 14.14 |
| Apr. | 4.98 | 9.78 | | Oct. | 4.75 | 14.05 |
| May | 4.91 | 17.03 | | Nov. | 5.01 | 17.20 |
| June | 4.84 | 22.20 | | Dec. | 5.40 | 16.75 |

Zinc ore was lower at Joplin last week. The output of the Missouri-Kansas-Oklahoma district was 7563 tons blende (60% metal), 524 tons calamine (40% metal), and 1006 tons lead (80%), averaging \$105, \$83, and \$89 per ton, respectively. The total value was \$934,595.

TIN

Prices in New York, in cents per pound.

| Monthly averages. | | | | | | |
|-------------------|-------|-------|-------|------------|-------|-------|
| Jan. | 1914. | 1915. | 1916. | 1911. | 1915. | 1916. |
| Jan. | 37.85 | 24.40 | 41.76 | July | 31.60 | 37.38 |
| Feb. | 39.76 | 37.23 | 42.60 | Aug. | 50.20 | 34.37 |
| Mar. | 38.10 | 48.76 | | Sept. | 33.10 | 33.12 |
| Apr. | 36.10 | 48.25 | | Oct. | 30.40 | 33.00 |
| May | 33.29 | 39.28 | | Nov. | 33.51 | 39.50 |
| June | 30.72 | 40.26 | | Dec. | 33.60 | 38.71 |

Tin is firm at 47 to 47.75 cents.

Eastern Metal Market

New York, February 24.

With the situation in producers' hands the copper market is as strong as ever, although there has been a lull in buying in the past few days. The London quotation for electrolytic is a trifle lower, and there is an intimation that the British government may endeavor to force the price down. Its minimum of £100, fixed a few weeks ago, has been exceeded by £6. A strike among brass-mill workers at Ansonia, Conn., has excited a slight depressing effect on the market. Zinc is less active, and a trifle easier. Sheet zinc has been advanced to 25c. per lb. for carloads. Lead is strong, and further advances are expected in view of the fact that export sales are made at premiums over the quotations of the leading interests. Tin shows a tendency to advance, due to the lack of sellers. It is becoming more difficult to obtain licenses to ship from England. Antimony is as scarce as ever, and higher. Aluminum continues to advance.

The larger steel-mills have advanced their quotations for plates, shapes and bars \$5 per ton, and now ask 2.75c. for plates, 2.50c. for bars, and 2.25c. for shapes. All of these went begging a year ago at 1.10c. Eastern Pennsylvania plate-makers are asking 3 to 3.25c. Most deliveries contracted for today are to be made at the convenience of the mills. Pig-iron is active. The railroad-freight embargoes are alternately raised and lowered, and continue to hamper business. Practically all grades of pig-iron are about \$5 per ton higher than they were a year ago. Open-hearth re-rolling billets are quoted at \$35, Pittsburg, per ton, against \$19.50 a year ago.

COPPER

In a general way the situation in copper is unchanged. Its strength is unimpaired, but there is a lull in demand. Electrolytic at London was 19s. lower at £136, February 24. A strike of workers in the Ansonia mills of the American Brass Co. is a disquieting influence, although it is felt that the trouble will not be of long duration. This strike, and the slightly lower market at London, has unquestionably had the effect of causing consumers to hold-off in buying. The producing interests appear to have the situation well in hand, and no pronounced reaction in prices is looked for just yet, although ultimately it must come. June and July deliveries of electrolytic continue to command 27.25c. For later than July 26.50c. can be done. Lake is nominally quoted about 1c. over electrolytic. Prompt deliveries of electrolytic range from 28.50 to 29c., 30 days, delivered. There is a hint that the British government may take steps to curb the high prices which have prevailed at London, though just how this can be accomplished is not clear. New inquiries for shrapnel-fuses are appearing in this market, and Canadian interests are planning to undertake more fuse work, all of which will mean the consumption of more copper and brass. Canadian interests are looking for several hundred tons of copper tubes for shell-mounds, but it is questionable where they will find the material. Exports of copper up to and including February 24 totaled 17,548 tons.

ZINC

Following the period of activity which was referred to a week ago, the market has been quieter, but prices are well maintained at around 21.25c., New York, and 21c. St. Louis for prime Western. Early deliveries continue difficult to secure. The Ansonia strike has probably had more effect on zinc than on copper in the way of making consumers lessen their buying. March commands about 29c., April about 19.25c., and May, June, and July about 18c. The London market continues strong, the quotation advancing £1 to £106,

February 24. The metal is at too high a level to encourage buying on the part of the galvanizing trade, a condition which is reflected by the case of a manufacturer of galvanized shingles, who discontinued to make his regular product, and turned his attention to painted metal shingles. Painted roofing is finding a much wider use than formerly. Exports of this month up to and including February 24 totaled 2375 tons.

The base price of sheet zinc in carload lots is 25c., f.o.b. mill, 8c. off for cash.

LEAD

At the present time, independent producers, all of whom are well sold up, are asking about 2½ points over the quotation of the A. S. & R. Co., and the trade daily expects an advance to be announced by the large interest. In the past week the A. S. & R. quotation has been 6.30c., New York, and 6.22½c., St. Louis. The advance of only \$1 per ton, February 16 was a great surprise to the trade, as it was thought that a more substantial advance was warranted. Foreign business has been taken at a premium of \$1 per ton over the domestic market level. February exports, up to and including the 24th, totaled 1309 tons.

TIN

Advices that it is becoming more difficult to secure licenses to ship tin from England has caused brokers here to hold more tightly to their metal in order to preserve their ability to meet their commitments, and the result has been fewer offerings of prompt metal and consequent higher prices. The quotation for spot on the 24th was 13.25c., with consumers offering 13c. At the same time, arrivals have been fair, totaling up to the 24th, 3752 tons, while there was afloat on that day 5916 tons, most of which is due to arrive in March, with some in April. The United States government has bought several hundred tons for its own use, which will be brought from the Far East on its own colliers and vessels which carry supplies to the Philippines. The purchase was made through London.

ANTIMONY

Recent large arrivals did not find their way to the market, and prices are still stronger. For spot metal 41c. duty paid has been done. March is quoted at 34c. in bond, and April at 33½c. Needle antimony is offered at 24.50c., but there is little doing. Canadian munition-makers have been large buyers.

ALUMINUM

Spot aluminum is exceedingly scarce, and the quotation for No. 1 Virgin, 98 to 99½ pure, cannot be had at much less than 90 cents.

MANGANESE

The supply of standard 80% ferro-manganese in this country is running low, and many of the steel-mills and steel-foundries are facing a serious situation. Some of the latter have only three months' supply. The furnace operators are turning their attention to spiegeleisen, containing from 16 to 20% manganese, but its use means difficulties of a technical nature in furnace operation. Spot ferro-manganese is quoted at \$250 per ton, and forward deliveries from England, and these are limited in quantity, at \$150. It is not thought that all of the forward material which has been contracted for will ever reach this country. The only foreign ore coming here is from Brazil, and the shipping facilities are most restricted. Optimistic people say there must be rich manganese ore in this country, and there would seem to be a fortune waiting for the person who finds it. Ferro-manganese is made in the blast-furnace, and on a smaller scale in the electric-furnace.

MINING DECISIONS

OIL RENTALS NOT ENFORCEABLE AT LAW

In a lease providing for specified rentals upon failure of the lessee to drill wells within a given time, in the absence of an absolute covenant to pay the rentals, the lessor's only remedy for non-payment is to forfeit the lessee's rights, and he cannot recover judgment for the rentals in an action at law.

Kansas City Oil & Development Co. v. Irick (Indiana), 110 Northeastern, 566. December 7, 1915.

Note. Quite the opposite is the rule where there is an absolute covenant on the part of the lessee to pay the rentals in lieu of operating. In such event the lessor may, at his option, sue and recover delinquent rentals.

Hefner v. Light Fuel & Power Co. (West Virginia), 87 Southeastern, 206. November 23, 1915.

NEW REGULATIONS COVERING AGRICULTURAL ENTRIES OF PHOSPHATE, OIL, AND OTHER MINERAL LANDS.

Mining and oil men will be interested in the terms under which agricultural entries may be made in accordance with the provisions of the Act of July 17, 1914, upon lands withdrawn from entry by the United States because of their phosphate, nitrate, potash, oil, gas, or asphaltic-mineral deposits. The new Regulations of the Interior Department covering this subject set forth the procedure to be followed by such applicants, and note that no protection is afforded by the act to the surface owner against such disturbance of his possession as Congress may in the future authorize to grantees of the mineral rights reserved by the Government. Further provision is made for the granting of patents without mineral reservations where the claimant can prove that lands withdrawn as mineral are in fact non-mineral.

Regulations, March 20, 1915, 44 Land Decisions, 32.

MINERAL LEASE—CANCELLATION GRANTED—DILIGENCE

A lease of oil, gas, and mineral rights was made upon a one dollar consideration, and an agreement by the lessees to pay one-eighth of the net proceeds from the sale of anything of value found, and to begin to drill one or more wells within two years under penalty of forfeiture. The lessees drilled a well to a vein of coal and then ceased operations, waiting, as they claimed, for the value of the coal in its natural state to rise, which would be to the mutual advantage of the lessor and lessee. The lessor neither agreed nor objected to the delay, simply waited for several years and then brought suit to cancel the lease. Held, cancellation justified for lack of diligence in development.

Soaper v. King (Kentucky), 180 Southwestern, 46. November 30, 1915.

MINING COMPANY—GROUNDS FOR RECEIVERSHIP

The directors of the Goldfield Merger Mines Co. had met but four times in four years and did not call a stockholders' meeting for more than three years, during which time the company expended \$250,000, which was practically all of its available funds, and also sold property for \$50,000 which a short time afterward was worth \$500,000. All of such business was transacted without authority from the directors by officers who were also officers or employees of other mining companies having the same majority stockholders. The work alone was not calculated to, and did not benefit the Merger Mines, but did benefit the other companies. Held, that such facts entitled the minority stockholders to the appointment of a receiver.

Ames v. Goldfield Merger Mines Co. (Washington), 227 Federal, 292. May 6, 1915.

RECENT PUBLICATIONS

U. S. Bureau of Mines, Washington, D. C., 1915:

SAMPLING AND ANALYSING FLUE-GASES. By Henry Kreislinger and F. K. Ovitz. Bulletin 97. P. 70. Ill., index.

Results of investigations into the important subject of efficiency in boiler-plants. This is written in non-technical language, and is practical, so should be secured by steam-users.

MANUFACTURE AND USES OF ALLOY-STEELS. By Henry D. Hibbard. Bulletin 100. P. 77. Index.

This is also a valuable treatise on steels now much in demand.

THE LIMITS OF INFLAMMABILITY OF MIXTURES OF METHANE AND AIR. By G. A. Burrell and G. G. Oberfell. Technical Paper, 119. P. 30. Illustrated.

This paper is one of a series dealing with the causes of mine explosions, and discusses experiments made on self-propagation of flame in mixtures of methane and air, and shows the composition of some coal-mine atmospheres.

QUARRY ACCIDENTS IN THE UNITED STATES DURING 1914. Compiled by Albert H. Fay. Technical Paper 128. P. 45.

Out of 87,936 men employed, who worked 20,456,157 shifts, there were 180 killed, equal to 2.05 per 1000, an increase of 0.33 per 1000.

U. S. Geological Survey, Washington, D. C., 1915:

THE PUBLIC INTEREST IN MINERAL RESOURCES. By George Otis Smith. P. 9.

An instructive talk on a great industry.

GOLD AND SILVER IN 1914. General report. By H. D. McCaskey. P. 37.

Metallurgists and statisticians will find valuable data in this paper.

LEAD IN 1914. General report. By C. E. Siebenthal. P. 29. Illustrated.

PETROLEUM IN 1914. By John D. Northrop. P. 206.

The production of over 290,000,000 bbl. and all details of an important industry are discussed.

THE PEOPLE'S INTEREST IN WATER-POWER RESOURCES. By George Otis Smith. Water-Supply Paper 400-A. P. 8.

The author states that the people's interest in water-power is served only through use.

CASSITERITE IN SAN DIEGO COUNTY, CALIFORNIA. By Walde-mar T. Schaller. Bulletin 620. P. 4. Map.

An abstract from this appeared in the Press of January 29.

GEOLOGY AND COAL RESOURCES OF NORTHERN TETON COUNTY, MONTANA. By Eugene Stebinger. Bulletin 621-K. P. 40. Maps.

OIL AND GAS NEAR BASIN, BIG HORN COUNTY, WYOMING. By Charles T. Lupton. P. 44. Maps, chart.

PRELIMINARY REPORT OF THE ECONOMIC GEOLOGY OF GILPIN COUNTY, COLORADO. By Edson S. Bastin and James M. Hill. Bulletin 620-M. P. 29. Maps.

An abstract of this report will appear in another issue of this journal.

NATURAL-GAS RESOURCES OF PARTS OF NORTH TEXAS. Chapters by Eugene Wesley Shaw, George Charlton Matson, and Carroll H. Wegemann. Bulletin 629. P. 126. Ill., maps.

DISCOVERY OF PHOSPHATE OF LIME IN THE ROCKY MOUNTAINS. By Frank D. Adams and W. J. Diek. P. 36. Ill., index. Commission of Conservation, Ottawa, Canada, 1915.

This deposit was found near Banff, Alberta. Some useful hints on prospecting for this mineral and testing are given.

GEOLOGY AND UNDERGROUND WATERS OF THE NORTHERN LLANO ESTACADO. By Charles Laurence Baker. University of Texas Bulletin No. 57. P. 225. Ill., maps, charts, index. Austin, 1915.

INDUSTRIAL NOTES

Oil-Furnace With Pre-Heating Feature

The No. 3 Leyner oil burning furnace, which is used extensively for heating drill-steel, is now made with a pre-heating chamber which greatly increases the capacity of the furnace. This pre-heater is a section which fits between the body and cover of the furnace of the old design. It is, therefore, a simple matter to attach this section to an old furnace by changing

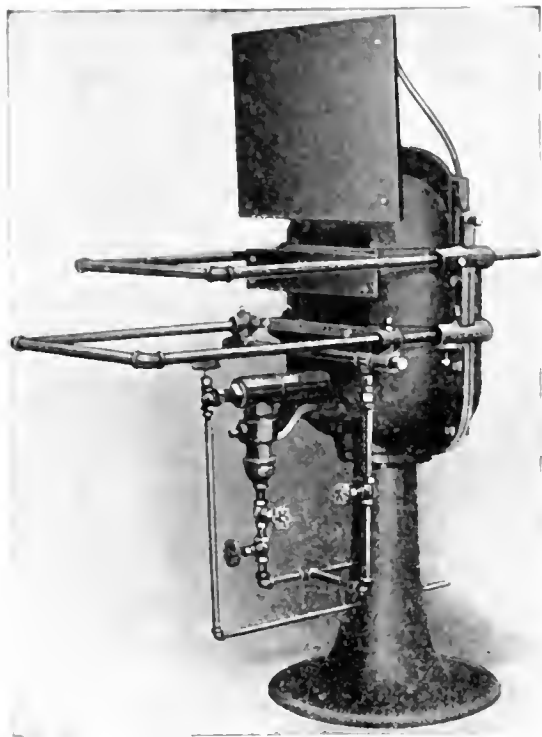

NO. 3 FURNACE FOR DRILL-STEEL.

a few bolts. Referring to the illustration, it will be seen that the lower chamber is used for the final heating and the upper one for pre-heating.

It is claimed that by the addition of the pre-heating feature, the space for heating is doubled, the heating capacity of the furnace is increased about 50%, and the efficiency of the furnace is increased correspondingly.

The type of burner now furnished with this furnace is suitable for either high or low-pressure air. It has merely to be throttled for high pressures, and when this is done, it is as efficient as burners designed especially for high pressures and eliminates the noise common to such burners.

This furnace burns petroleum or any of its oils, such as gasoline, kerosene, distillate, etc. Oil heating has many advantages. The steel cannot be injured by absorbing injurious elements such as sulphur, phosphorus, or other impurities which are present in nearly all coals, nor from unequal heating, as the steel is heated in a flame which imparts a uniform temperature. The steel is in full view of the operator at all times.

The floor space occupied by the No. 3 furnace is 3 by 4 ft. No foundation is required, installation being complete when air and oil-supply pipes are connected.

The absence of smoke, soot, dust, ash, and cinders is a great convenience, which is particularly appreciated in underground mine installations and in plants installed in buildings.

The manufacturers are the Ingersoll-Rand Co., 11 Broadway, New York.

Mine-Rescue Stations in California

Mines in all parts of California are rapidly installing mine-rescue apparatus in accordance with the State law which goes into effect April 1, although only about one quarter of them have completed their equipment as yet.

The Amador co-operation station, which includes the Kennedy Mining & Milling Co., South Eureka Mining Co., Plymouth Consolidated Gold Mines, and other mines in and near Sutter Creek, is installing the following: 5 sets Proto apparatus; 1 oxygen pump, which raises the pressure from the Linde tanks to 1800 lb. per sq. in.; 1 air-meter which registers amount of air passing through reducing valve per minute; 3 tanks oxygen; and 200 lb. of caustic soda. This apparatus will be placed at the Sutter Creek garage, which is building a room to store it. A house for training purposes is being built which will be filled with smoke and the men trained therein. Each mine in the co-operative station will have a team of five men who will be fully instructed in the use and care of the apparatus.

The Empire mine, Grass Valley, will have five sets of Proto. The company is building a concrete fire-proof house for the apparatus and all first-aid material. For training purposes they are using an abandoned level of the Empire mine, which will be filled with smoke, and will construct artificial barriers for men to practice on.

The North Star mine will have four sets of Proto which will take in the North Star and Champion mines as a co-operative station. They will have a team of picked men and expect to train under practically the same circumstances as the Empire mine.

The Brunswick mine will have two apparatus, a small fire-proof house wherein to keep the same, and first-aid material and train men.

The idea at Grass Valley is to have competition between the different mines so as to bring them up to a high state of efficiency. Prizes will be given from time to time to the winners of these meets, and in this way the efficiency will be raised to a high standard.

A full station is to be erected at the Eagle Shawmut mine, Shawmut. This consists of two sets of Proto apparatus, one oxygen-pump, one air-meter and oxygen, and enough caustic soda for 10 hours for each apparatus.

This makes five full stations that will be installed by April 1 in California, all of which are Proto stations, the Proto being the only apparatus now used in California.

This apparatus has all been sold by E. D. Bullard, a safety expert with offices at San Francisco.

The 'Rotator' hammer-drills 'DP-33' and 'DR-33' are described in Bulletin No. 79-A of the SULLIVAN MACHINERY CO., Chicago. The capacity of these machines is astonishing. Augers can be used for soft ground. Some notes are given on bits and blacksmiths' tools.

As is customary with the NATIONAL TUBE CO. of Pittsburg, Pa., its latest catalogue of 72 pages, entitled "The Whole 'Kewanee' Family" is an excellent production discussing the firm's unions, fittings, valves, etc. All pipe users should secure a copy.

A supplement to its general catalog No. 56 has been issued by the CHAIN BELT CO., of Milwaukee, Wisconsin. The detachable, saw-mill riveted, grip-lock riveted, steel-hushed, and steel chains are briefly described.

The Duntley universal electric hammer-drill is described in Bulletin E-38 of the CHICAGO PNEUMATIC TOOL CO. This is an efficient machine. Some notes are given on the steels to be used.



EDITORIAL



T. A. RICKARD, Editor

EFFICIENCY in war, and the national solidarity to which it is due, is receiving proper praise at this time, but most people seem to ignore the fact that this efficiency is being obtained regardless of cost. No economic argument can be based upon it. An effort so expensive could not be tolerated in time of peace.

HIGH-GRADING is usually associated with rich gold ore, to obtain which it is not so easy nowadays. The latest phase of ore-stealing is the taking of tungsten ore and concentrate, worth \$1 to \$2 per pound. Thefts of such products are being reported from the tungsten-producing districts.

ELECTRICAL theories of flotation will receive a jolt from the interesting article by Mr. F. A. Fahrenwald, who writes from the Case School of Applied Science, at Cleveland, from which also emanated the two suggestive articles by Mr. Thomas M. Bains, Jr., published by us a few months ago. Evidently this phase of the flotation problem is being carefully studied at Cleveland.

COBALT, like many other districts where flotation has proved useful as a process of concentration, is faced with the question of treating the flotation concentrate locally. At present the cost of freight and treatment outside is \$24 per ton, equivalent to about \$1 per ton of crude ore. Undoubtedly the reduction of flotation concentrate, otherwise than by large-scale smelting works, is a fascinating problem.

MEXICAN rumors of a union of forces between Villa, Zapata, and Diaz may be disregarded. If true, it would be a good thing for the Mexican government in so far as it concentrated the recalcitrant elements into one body instead of scattering them into marauding bands. The story emanates, we believe, from Villa's press agency at El Paso. Meanwhile Villa himself is reported near the northern border, looking for a chance of safe exile.

WE are surprised to see that the *Mining Magazine* reproduces the so-called statistics of the world's gold production published at the beginning of the year by the *Engineering and Mining Journal*, the editor in London stating that his own efforts to collect the necessary statistics had proved unsatisfactory to himself. This is frank, at least; but the gentleman in New York could have said so with equal grace, for his guesses at the gold output of Mexico, Central America, South America, Russia, Japan and Korea, China, Madagascar, Congo, and Dutch East

Indies must be equally "unsatisfactory" to a discriminating reader. As a matter of fact, the editor in New York had just as few reliable figures as his contemporary in London, only the latter was more cautious. The figures for the British dominions and for the United States constitute real statistical information, and these only. As to Canada, the *Engineering and Mining Journal*, in its issue of January 8, gave the Canadian output in 1915 as \$15,875,000. We have obtained the official estimate from the Canadian Minister of Mines, who gives it as 916,076 ounces, worth \$18,936,971, showing an error of over \$3,000,000, or about 20%, in the hasty estimate made by the *Journal*.

SPECULATION in mining stock is said to be lively in the Coeur d'Alene, one of the contributory factors being prohibition, which operates favorably in two ways: in the first place, the defunct saloons have been converted into brokerage offices, and secondly, the 'dry regime' is said to promote the diversion of money from the intoxication of alcohol to that of share-gambling. This is to the gain of mining, in so far as it provides capital for exploratory and development work. What with increased wages and more thrift the miner is becoming a factor in supplying money for new ventures. We should like to see more grub-staking among the men and less gambling in stocks, but this is not a perfect world, so we must not grumble.

PUMPING is an important subject at this season of the year, and it is particularly timely just now because so many old mines are being unwatered. Therefore we are glad to give our readers a summary of the excellent article by Mr. Charles Legrand, consulting engineer to Phelps, Dodge & Company. Among the topics discussed by him is a comparison between pumping by steam and by electricity, with records of tests that illustrate the chief points at issue. He also discusses the economy of steam-pumps, the question of steam-line, and the relative merits of air-lifts. In his many practical suggestions every mine-manager will find something applying to his own conditions. Among the big pumping operations mentioned in the paper is the Old Dominion mine, where now 11 million gallons of water is being raised daily.

OUR London correspondent sends an interesting letter, touching upon the general shortage of effective labor in South Africa, and the probability that any resumption of work at the diamond mines, at Kimberley and Pretoria, will cause a drain upon the labor-supply of the

Rand—Indeed, scarcity of common labor is going to be an unpleasant factor all over the world even before the War is ended. The effect of war taxes on mining operations is illustrated sharply by the case of the Cornish tin mine mentioned by our correspondent. Obviously the clash of patriotism and business is going to give many uncomfortable moments to thoughtful men in England and other belligerent countries. To what extent the heavy taxation incidental to war and its sequel may cause a transfer of registry on the part of mining companies operating in foreign countries is another matter of serious import to the mining fraternity in London.

WATER-POWERS are becoming more valuable, as electricity is applied increasingly to the arts and industries, notably metallurgy. We publish a letter on the protection of this natural resource by a distinguished exponent of conservation, Mr. Gifford Pinchot, formerly Chief Forester, whom we regard as a man of courage and initiative, although we are not in full agreement with the policy he and his friends advocate. We want to see the perpetual sources of energy used instead of going to waste while the limited reserves of coal and oil are being squandered recklessly.

EXTRA dividends distributed by several of the big copper companies mark the favorable effect of the rise in metal prices. Copper is now at its highest since 1873 and is approaching the prices ruling during the Civil War, when it sold as high as 55 cents. That was in 1864; in that year the United States produced only 9000 tons of copper. Mr. John D. Ryan and other authorities on the subject deprecate any further rise as likely to prove injurious to the industry. All the large producers are sold so far ahead that they are under no necessity to compete for business. The regrettable feature of any inflation is the stimulation of new mining enterprises based on a price that cannot last and the exploitation of worthless mines as a counter for wild gambling.

SAFETY work has now won a firm hold on the intelligent managements of mines. The main feature has been the effort to arouse the interest and co-operation of the miners themselves. This has been done at the Treadwell group of mines, for example, by organizing a Committee of Fifteen, eight of whom are appointed by the Labor Union and seven by the Mine Management. This committee is divided into five sub-committees, covering as many mine departments, so that when an accident occurs the fact is reported to the foreman, mine superintendent, and the sub-committee of that department. These make a prompt investigation and deliver a written report on the causes and consequences of the accident to the main Committee of Safety. In making reports, it is understood that the facts and comments shall be stated honestly and fearlessly, as thus only is it possible to secure evidence of value for future emergencies. The members of the committee are paid by the management for the time they devote to this work, which

throughout is placed on a workmanlike basis. A cash prize of \$25 is paid quarterly by the Treadwell company to the employee who submits the best suggestion for preventing accidents in or about the mines. Some good ideas have been elicited in this way and the general interest of the men has been stimulated thereby. First Aid lectures are given by the Company physician once a week and the men are taught the proper use of restoratives and remedies. The whole scheme has been admirably considered and elaborated.

ACCORDING to *The Northern Miner*, the mining public of Canada is objecting to the new war-tax whereby all corporate profits above 7% per annum are taxed 25%. It is claimed that this heavy mauling of the gains obtained from mining operations will stop the flow of capital from the United States. Our contemporary at Cobalt does not expect American speculators to make a sacrifice with equanimity, even though Capt. J. R. Delamar is quite willing to pay "the trivial amount involved." It is claimed that silver mining has not profited from the War, while gold mining has lost decidedly by the rise in the cost of all supplies and machinery. However, other kinds of metal mining are profiting greatly from the high prices caused by intensified consumption in the making of munitions, so we shall be surprised if the general sentiment in the Dominion is aroused to any real opposition to this taxation. By the way, in Canada also the War has reversed the current of trade, for while the trade balance was adverse in 1913 to the amount of \$198,500,000; and in 1914 the excess of imports was \$70,300,000; in 1915 the exports exceeded imports by \$201,700,000. This was due to the big wheat crop and the manufacture of war supplies.

IN our issue of May 8 last year we wrote concerning administrative continuity and referred to the efforts made by several well-known mining companies, notably the Goldfield Consolidated, to lengthen their lives by acquiring new property as the old approached exhaustion. We commended the idea as perpetuating the goodwill that exists in a thoroughly organized management or staff and preventing the waste of an asset that is valuable to the mining industry. We refer to the matter now because we are informed that the Goldfield Consolidated Mines Company has opened an office in San Francisco for the special purpose of investigating likely business, establishing what is called an 'exploration' department, the function of which will be to consider and examine properties offered for option or sale. In this case the scope of inquiry is not to be limited to gold mines. That is wise. The other metals can be turned into gold at an enhanced ratio today. More money can be made just now, and for some time to come, from the less common metals because there are fewer producers of them. Mining is full of adventure in these days and offers better chances than when, in default of other 'talking points,' the broker and promoter retailed nonsense about its being an investment, a manufacturing proposition, a dead sure thing, and so forth. Mining is

speculative and is least risky when frankly recognized as such.

OFFICIAL statistics are now available in regard to the export trade of zinc and copper last year. These give eloquent testimony to the growth of export. As regards zinc they are as follows:

| | 1915 | 1914 | 1913 |
|-----------------------------------|------------|-----------|---------|
| Exports, weight in tons | 125,203 | 64,847 | 7,782 |
| Exports, value in dollars | 33,504,908 | 8,540,668 | 955,667 |

In other words, the export of zinc has grown from a million dollars per annum to 33 millions within two years. In 1915 the importation increased to 55,668 tons as against 12,134 and 13,497 respectively in 1914 and 1913, the increase being due to the diversion of Broken Hill zinc concentrate from Belgium and Germany to the United States, by reason of the War, of course.

In regard to copper, the exportation of metal decreased in quantity, on account of the blockading of German ports, but the increase in price caused the value of the outgoing copper to be a million dollars more.

| | 1915 | | 1914 | |
|-------------------|---------|---------------|---------|---------------|
| | Tons. | Value. | Tons. | Value. |
| Exports | 341,000 | \$117,000,000 | 421,000 | \$116,000,000 |
| Imports | 158,000 | 44,000,000 | 152,500 | 40,000,000 |

In addition there was an enormous increase in the export of brass, thus:

| | 1915 | | 1914 | |
|-------------------|--------|--------------|--------|-------------|
| | Tons. | Value. | Tons. | Value. |
| Exports | 34,000 | \$55,000,000 | 14,000 | \$6,700,000 |

If this brass contained, say, 75% of copper, the total export of copper would have been 366,500 tons in 1915. Germany, Belgium, and Austria took no copper from us in 1915, while Holland received only 2000 tons as against 89,000 tons the year previous.

CANADIAN statistics of metal production in 1915 are just to hand from the Department of Mines. An increase of \$2,953,964, or 18.5%, is recorded in the production of gold, the total being \$18,936,971. Of the total 44% comes from Ontario. This province increased its output by 51%, thanks mainly to the Hollinger, Acme, and Dome mines. The production of silver remained practically unchanged at 28,401,735 ounces, as against 28,449,821 ounces in 1914. Of the total 86.8% came from Ontario, chiefly from Cobalt. Of the silver bullion 10,623,307 ounces was extracted by smelters in southern Ontario and 9,270,332 ounces by the mills in the Cobalt district. In copper a big gain was made, the output increasing 35% in weight and 72% in value as compared with the previous year. The total was 51,306 tons, worth \$17,726,300. Again Ontario ranks high, having contributed 19,651 tons, chiefly from the nickel-copper ores of Sudbury. Nickel, of course, has been in great demand, so that it is not surprising that the mines of Sudbury should have increased their output by nearly 50%, the total being 67,703 tons of matte containing 19,608 tons of copper and 34,039 tons of nickel from 1,364,048 tons of ore. The total value of Canada's mineral production in 1915 is estimated at \$138,513,750 compared with

\$128,863,075 in 1914 and \$145,634,812 in 1913. Thus the production was a little less than the best on record, owing, of course, to the crippling of industry by the War at the beginning of the year, the chief losses being in cement and clay products.

Is Mining Engineering on the Wane?

In the latest bulletin of the Mining and Metallurgical Society we find an interesting contribution by Mr. Arthur L. Walker, Professor of Non-Ferrous Metallurgy in Columbia University. He has heard it said that the profession of mining engineering is on the wane and he asks the members of the Society 'what they know about it.' He himself refers to the growth of specialization as having restricted the scope of the individual engineer; also to the effect of the persistent misrule in Mexico and of the organized calamity in Europe as having diminished the opportunities for professional employment. Finally, he suggests that the expansion of output does not make a corresponding increase of work for engineers, while the slackness in the exploration and development of new mines during recent years has tended to lessen the demand for engineering service. Another point mentioned is that of the character of the education required today for the mining engineering profession; the number of schools for the purpose has increased greatly and most of them try to give a complete training in three or four years; at Columbia the curriculum now calls for six years of study, it being the belief that three years of general education and three years of engineering is not too much time to devote to the preparation necessary.

Here are some good questions for thoughtful men to answer. We shall be glad to read what the members of the Society have to say to Professor Walker. Meanwhile, it is obvious that the subject concerns a wider public than the group of men to whom these questions were addressed. Let us begin by recording a cheerful negative to the first question. Mining engineering is not going to decline in importance, for the scheme of living called civilization depends upon the use of metals. In the immediate future we discern the probability of an intensified demand for the metals, at least for those to be extracted out of that part of the earth's crust that is called the United States. Material progress advances by means of metallic structures, whether of buildings, bridges, ships, cars, or aeroplanes. All the conveniences of life, from pipes and wires to heating and lighting, are largely based upon the varied use of the products of the mine. The mankind of today and of the future within our immediate vision will require metals in great and increasing quantity. We do not fear that they will go out of use. In so far as any of them become scarce there will be a call for skill in finding them and ability in extracting them from their natural state. No; there is no sign of the mining engineer going out of fashion, but there is danger of superfluity in one direction: During the last decade a number of unnecessary schools

of training have been established, reducing the attendance at the best schools while exhausting the supply, never abundant, of those competent to teach such difficult subjects as mining and metallurgy. The consequence has been to augment the number, without improving the quality, of those initiated into the profession. The boom days of 1907 caused the mining schools to overflow with students for two or three years, and thereby provoked the expansion of facilities for rudimentary schemes of teaching mining at State universities, agricultural colleges, and other institutions not well equipped for the purpose. Hence the apparent congestion today. This has been emphasized by the closing of several mining regions in consequence of warfare in many parts of the world and the financial stringency in others. When peace is restored, the congestion will be relaxed, but one feature will continue to be recognizable, namely, the need for specialization. The day of the smatterer is gone; every man must specialize in some branch of an immensely big subject. In the hey-day of the generation now passing it was possible for a mining engineer to be a mechanical engineer, a metallurgist, and a geologist; at least, he could equip himself with enough information concerning any and all of these departments of knowledge to meet the needs of the period. But even the Admirable Crichton of those days would feel, even if he did not look, foolish today when the machinery of mining has developed in size, cost, and complexity to something so far beyond the simple structures of its infancy; while metallurgy has grown to include concentration by water, fire, oil, and involves the use of chemical and electrical processes of the greatest delicacy conducted on a colossal scale; and geology as applied to mining has passed from the prattle of childhood to the stern work of accurate survey, microscopic examination, and chemical research. In short, the jack-of-all-mining has given way to the mechanical engineer, the chemical engineer, the economic geologist, the concentration expert, the mine-valuer, the specialist in leaching, matte-smelting, electrolysis, flotation, and so forth. Of course, no little mining school, the annex to a non-scientific college, can expect to train such specialists. Even the great schools of mines attached to the big universities are set a task beyond the scope of the ordinary three years course. It has become necessary to treat the training for mining as the post-graduate of a precedent thorough scientific training. Nevertheless the abilities of the advanced schools are being exceeded by the requirements. Obviously they also must specialize, so that they may be able to train specialists. Let one school concentrate its attention on metallurgical and another on purely mining subjects. For instance, let Columbia specialize in fire metallurgy, Harvard in economic geology, Houghton in mining methods, Berkeley in wet metallurgy, with such further distributions among the others as locality and circumstances may suggest, so that the graduate student may choose a specialty and go to the school best fitted to teach it to him. Of course, no agreement is likely to be made among the

schools for the accomplishment of this purpose, but something of the kind must be kept in view. Here is where organization is preferable to *laissez faire*. In any event, even if the schools continue their go-as-you-please policy, it is evident that the students must awaken to the realities of the position and recognize that a shallow knowledge of a tremendously wide subject will fail to equip them for a successful career. There will always be an opening for the man who is well prepared; there will be steady lessening of chances for the mob of the unprepared.

Chalcocitization

Among the notable contributions to the science of ore deposits is the work of research into secondary enrichment, more particularly of copper deposits, started by Messrs. L. C. Graton and Joseph Murdoch, and continued by Messrs. Posnjak, Allen, and Merwin in the geophysical laboratory of the Carnegie Institution at Washington. Supplementary to the work of these investigators, Messrs. C. F. Tolman and A. F. Rogers, at Stanford University, have been making a research into the origin of chalcocite ores. The idea had been put forward by Messrs. Graton and Murdoch that the chalcocite precipitated from ascending solutions showed a cleavage different from that possessed by the same mineral when deposited from descending solutions. This, of course, would be a criterion valuable to the miner. Now, Mr. Tolman, in a paper presented recently before the American Institute, shows that the cleavage can be inherited by the chalcocite from a bornite stage and that by this pseudomorphic pattern it is possible to find clues to the earlier minerals destroyed by the chalcocitization. Applying his method of examination to the ore of the Bonanza mine, of the Kennecott Copper Corporation, Mr. Tolman discovers that the chalcocite of this remarkable orebody is derived from bornite, as is proved by its intricate patterns in blue and white. Residual bornite was detected by the microscope. Thus the inference is that the big body of wonderfully rich ore is due to the chalcocitization of a coarsely crystalline mass of bornite, from which the iron has been completely leached, to be replaced by an equivalent amount of copper. He finds that the original group of minerals was bornite, klaprothite, and galena, succeeded by chalcocite, which by increase of oxidation became converted into covellite and chalcopyrite, then tenorite and cuprite, then malachite and azurite. The latest changes are being effected by the vadose circulation in water near the freezing point, the copper migrating as malachite, with resulting impoverishment of the mass. This study of an extraordinary deposit is most suggestive and we hope that before the ore is exhausted it may serve not so much as the excuse for financial operations of a flamboyant character as the subject for investigations that may finally establish the actual part played by chalcocite in making those copper enrichments on which so much large-scale mining is based.



DISCUSSION

Our readers are invited to use this department for the discussion of technical and other matters pertaining to mining and metallurgy. The Editor welcomes the expression of views contrary to his own, believing that careful criticism is more valuable than casual compliment.

Control of Water-Power

The Editor:

Sir—I write to ask your help to defeat a most serious attack on our public resources. Since the fight over the Alaska resources was won there has not been so pressing a threat against the conservation policy as the present effort in Congress to give our public water-powers for nothing into monopolistic control.

The Shields bill, now before the Senate, gives to the power interests without compensation the use of water-power on navigable streams. The amount of water-power these streams will supply is larger by far than all the power of every kind now in use in the United States. It pretends to, but does not, enable the people to take back their own property at the end of 50 years, for in order to do so under the bill, the Government would have to pay the unearned increment, and to take over whole lighting systems of cities and whole manufacturing plants. Private corporations are authorized to seize upon any land, private or public, they choose to condemn.

Bills which gave away public water powers without due compensation were vetoed by President Roosevelt and President Taft. The Shields bill would do precisely the same thing today.

Another water-power bill, the Ferris bill, relating to the public lands and national forests, was in the main a good bill as it passed the House. As reported to the Senate it encourages monopoly by permitting a corporation to take as many public water-power sites as it may please. Under it the corporations could not even be kept from fastening upon the Grand Canyon, the greatest natural wonder on this continent. This bill takes the care of water-powers on national forests from the experienced and competent Forest Service, and gives it to the Interior Department, thus entailing duplication and needless expense.

In my opinion, there is undue carelessness as to the disposal of public resources at present in Washington. The water-power legislation now before the Senate is too favorable to the men who, as Secretary Houston's admirable recent report shows, control through 18 corporations more than one-half of the total water-power used in public service throughout the United States. The water-power men charge that Conservation hampers development. The Houston report shows, on the contrary, that the most rapid development is in the national forests, where conservation is best enforced. On the other

hand, 120 public-service corporations own and are holding undeveloped and out of use an amount of water-power equal to four-fifths of all there is developed and in use by all the public service corporations in the whole United States.

As I said in an open letter on January 29 to the President: "Natural resources lie at the foundation of all preparedness, whether for peace or for war. No plan for national defense can be effective unless it provides for adequate public control of all the raw materials out of which the defensive strength of a nation is made. Of these raw materials water-power is the most essential, because without electricity generated from water-power we cannot manufacture nitrates, and nitrates are the basis of gunpowder. There are no great natural deposits of nitrates in the United States as there are in Chile. It would be folly to allow the public water-powers, which can supply this indispensable basis of national defense, to pass out of effective public control."

A concerted movement is on foot to break down the conservation policy. Feeble resistance or none at all is being made by official Washington. Unless the press and the people come to the rescue, the power interests are likely to win. This is a public matter wholly removed from political partizanship. Your help is needed, and that of your paper. For nearly ten years this fight for the public water-powers has gone on. We ought not to lose it now.

GIFFORD PINCHOT.

Milford, Pa., February 15.

Cyanidation of Flotation Concentrate

The Editor:

Sir—A few weeks ago you referred to me the question as to whether flotation concentrate could be successfully cyanided. I replied that although I had no working data on the subject I saw no reason to apprehend any difficulty due to the fact that the concentrate was recovered by flotation and not by some other method. I am now able to state that my opinion has been borne out by tests on a sample recently submitted to me.

The ore in question was a California gold ore assaying 0.57 oz. gold and a little silver. It was ground to pass an 80-mesh sieve for flotation and yielded a concentrate assaying 9.66 oz. gold and 9.85 oz. silver. A sample of this concentrate, without filtration or re-grinding, was treated by bottle-agitation for 72 hours with cyanide solution at 0.2% KCN and at a ratio of

5:1 No preliminary treatment of any kind was given and no reagents were added except lime and sodium cyanide. The solution was not changed during treatment, and at the conclusion of agitation the sample was filtered and washed on the filter in the usual way.

| RESIDUE | |
|--------------|----------------|
| Gold, Oz. | Silver, Oz. |
| 0.29 | 3.54 |
| EXTRACTION | |
| 97 | 61 |

It is probable that if some lead compound had been added during treatment, a higher extraction of the silver would have resulted. It is also not unlikely that the gold extraction can be increased in the course of further research work.

This test shows that some flotation concentrates, at least, can be cyanided raw with very little trouble. I am inclined to think that given an ore that presents no *a priori* obstacle to cyanidation, the concentrate recovered therefrom by flotation will give no more difficulty in cyanidation than a concentrate from the same ore recovered by any other means.

E. M. HAMILTON.

San Francisco, February 29.

Mechanical Efficiency of Crushing

The Editor:

Sir—I have just obtained a copy of your issue of November 6 which contains Mr. Stadler's letter, in which he is real rough to Messrs. Kenny and Del Mar. The matter of my being a qualified expert has come into the discussion, at least Mr. Stadler's letter carries an implication that the only real experts in crushing lived and moved and had their being some fifty years ago; but the written word is so easy of misinterpretation that I offer my apologies before he goes back to the piano for his gun.

Our little conspiracy to undo all that Mr. Stadler has done has recently had an accession. Some two years ago there was published in your columns a note on the rock-crushing tests then being conducted at McGill University, the preliminary results of which indicated that Stadler's theory of Kick's law was correct. Recently the secretary of the Canadian Mining Institute called my attention to an editorial in their October bulletin referring to my paper presented in the September bulletin of the A. I. M. E., but more particularly giving preliminary conclusions on the work that has been done at McGill up to date. The editorial concludes thus: "Nearly 200 tests have been made at McGill during the past two years and we understand that each series will demonstrate convincingly the fallaciousness of expressing power in terms of 'energy units,' as proposed by Mr. Stadler in accordance with Kick's law. Rittinger's hypothesis, on the other hand, is supported in so satisfactory a degree by the results obtained by actual ex-

periment as to appear quite dependable. It seems probable, therefore, that the investigations made at McGill and Purdue universities will result in terminating the long standing controversy between the supporters of respectively Rittinger and Stadler; while if, as now seems likely, it will conduce to the definite establishment of a correct basis for calculating the efficiency of rock-crushing machines, a work of great utility, by reason of its practical value to mill-men, will have been accomplished."

In the same issue (November 6) you abstract a paper by M. K. Rodgers presented in the September bulletin of the A. I. M. E. on 'Standardizing Rock-Crushing Tests.' I started some comment on it, but was unable to complete it within the time limit, and as he was absolutely neutral on the matter of laws and didn't take a shot at some of us, I won't say much about it, except just this: Report screen analysis of feed and discharge in cumulative per cent or tons and in reciprocals of diameters. If he will agree to get Tyler to stamp on every standard screen he sends out the reciprocal of diameter in inches, I'll agree to say that it's the ki-ki screen for crushing-surface diagrams.

Also, I took those screen analyses of Mr. Rodgers and made crushing-surface diagrams out of them. At least, I did the best I could, for they were not made with the screens he advocated, and I had to be very unscientific and guess at the openings, or the reciprocals of the diameters. These crushing-surface diagrams give the following results, on + 200 mesh:

| | Mesh-tons per hp.-hour. |
|------------------------------------|----------------------------|
| Calumet & Hecla conglomerate | 12.5 |
| Coeur d'Alene quartzite | 15.6 |
| Miami | 34.0 |

while Mr. Rodgers finds the relative crushing duty due to character only to be 1.00, 1.92, and 3.75, by a very neutral method. The other crushing conditions are not the same, the tonnage is decidedly different, there is some difference in moisture contents, and the feed at Calumet & Hecla is much cleaner of undersize than at Miami. I believe these figures represent not differences in the crushing characteristics of the rocks so much as they do differences in manipulation.

This matter of crushing efficiency and the laws of crushing must appear to the average reader as a fight between a bunch of quack doctors. I may be a crank on the subject, but when my study, scientific or unscientific, of fine grinding or crushing leads me to believe that fully 50% of the energy spent in fine grinding is absolutely wasted, and produces a product more difficult of manipulation, shall I keep my mouth shut? Where the mill-man can gain from this discussion will be to just forget about Kick and Rittinger, study his crushing operations by means of the crushing-surface diagram, and attempt to improve his mill efficiency along the lines that are suggested in my paper on 'The Applications of the Crushing-Surface Diagram.' (I have a few reprints of this paper that I will be pleased

to send to any mill operator interested.) So far as I know, neither Stadler's work nor mine has resulted in any marked improvement in mill-efficiency, but I know of no place where they have really tried to improve conditions by my methods. Some folks are fooling with it and may get results from them. Can't you give a Dutch boy a chance?

A. O. GATES.

Mishawaka, Indiana, January 18.

Mining in Western Oregon

The Editor:

Sir—Reading 'Mining in Western Oregon' by C. E. Morse in your issue of January 29 is like meeting an old friend, and I feel like saying "glad to see you, old fellow, but sorry you have not been as prosperous as you certainly deserve." for I was foreman of the Lucky Boy mill during the winter of 1900-'01 for six months, when I had to give up the position on account of a severe illness.

There was no "secret solution" used, however, in the De Keyser process, as I was reliably informed although it was not in operation when I went there, except the secret of the solution of the problem, which it did not reveal. You meet this process from time to time with about the same frequency as the process for the extraction of gold from sea-water. The concentrate was simply ground in the Crawford mill with an excess of mercury and strong cyanide solution, the pulp then passing over the 'electric plates,' where it was hoped the gold would be deposited by electrolysis. The plate did not shake, however. I put in the shaking device, using hardwood eccentrics. I re-ground the concentrate from the Wilfleys with mercury, and shook the plate merely to keep the heavy pulp in motion instead of increasing the grade of the plate. In this way I recovered an additional small amount of free gold. The classifiers, not mentioned by Mr. Morse, simply V-boxes with two spigots, I also put in. By treating the coarse spigot product on the Wilfleys and the fine on the vanners, I was able to increase the value of the concentrate from \$30 per ton to about \$50.

Since the development of concentration by flotation, I have often thought the ores of the Lucky Boy district could be successfully treated by this process. By screening the plate-tailing instead of classifying in water, delivering the + 80 to the Wilfleys, and the undersize—dewatered—to the vanners, a concentrate from the vanners could be produced well fitted for flotation, and by using continuous riffles on the Wilfleys most of the pyrite could be separated mechanically from the galena and blende.

My incomplete experiments showed that a fair extraction could be obtained by cyanide, though all my notes were lost when the assay-office was burned in March 1901. By a coincidence, I also spent a couple of months at the Ogle Mountain mine, assaying the mine and instructing the mill-crew. The mill had then 5 stamps and a new Standard concentrator. The mine in the upper workings yielded some high-grade ore. As an instance

of what we meet 'as through this world we roam' the young man who started the mill 'dressed' the plates with coarse sand and strong cyanide, the said cyanide being mixed and allowed to stand in a coal-oil can. The condition of the plates can be imagined.

H. S. REED, JR.

Shawmut, California, February 1.

Pine-Oil

The Editor:

Sir—Your definition of pine-oil, as embodied in 'A Glossary of Flotation,' in your issue of February 12, 1916, is rather misleading and, in view of the present general interests in pine products as applied to flotation I take the liberty of discussing this question at some length.

In arriving at a proper understanding of the different products produced by treatment of the resinous woods of the South Atlantic and Gulf states (usually dead and fallen timber or pine-stumps) it is necessary to bear in mind that two basic methods of treatment are used.

The first is the steam and solvent process: To prepare the wood for treatment it is reduced to the consistency of fine chips by passing through chipping machines and is then placed in a retort or extractor. Superheated steam is then passed through a charged retort until the turpentine and pine-oil have been volatilized and passed to the condenser, where they are recovered. Steam is then shut-off, the wood dried by evacuation and finally subjected to several extractions with a solvent, usually petroleum, gasoline, or naphtha. The resin and any remaining oils are thus extracted, and later this solution is separated into its component parts—extraction solvent, pine-oil, and rosin—by distillation. The products resulting from this process are turpentine, pine-oil, rosin, and 'spent wood,' which is suitable for paper-pulp or may be burned under boilers. All of these products appear normally in dead pine-wood and are not products of decomposition.

The second is the destructive distillation process: The wood, in the form of cord-wood, is placed in a horizontal retort. The retort is then sealed and heat applied externally. The temperature is raised slowly until the wood is thoroughly carbonized. The volatile constituents are passed to a condenser. It is general practice to separate the condensed liquors into two fractions; the first representing the distillate passing from the retort up to the temperature at which the wood begins to char, and the second representing the distillate during the charring or decomposition period. The first distillate is usually known as 'sweet crude,' and upon refining yields turpentine and a small percentage of pine-oil. The second fraction, known as 'D-D crude,' when refined yields a small amount of pine-oil of inferior quality, pine-tar oils, and pine-tar. A great variety of products can be produced from this 'crude' by varying the methods of refining.

With these methods of production now in mind we are

ready to return to the definition of pine oil. Specifications of the U. S. Navy Department define pine oil as follows:

"Pine-oil is a properly prepared light straw colored oil produced by re-distillation of heavy, high boiling point fractions resulting from the steam distillation of wood turpentine, and having a strong aromatic odor resembling turpentine." As it is not a product of decomposition, it possesses well defined physical properties. Pine oil produced by steam-distillation should have a specific gravity of not less than 0.930 or more than 0.945 at 60° F., and upon distillation should show at least 75% distilling between 200° and 220° C.

The definition you have given for pine-oil really covers pine-tar oil, which is defined by the U. S. Navy Department as:

"A properly prepared distillate from straight pine-tar, which latter has been obtained by destructive distillation of pine-wood." It is not practical to attempt to outline specifications for pine-tar oils here as they are usually refined in conformity with the individual ideas of each producer.

CHAS. A. LUNN,

New York, February 18.

Unusual Gas in a Metal Mine

The Editor:

Sir—An unusual gas mixture for metal mines is found in the Tonopah-Goldfield district of Nevada. This gas is locally known as 'ground gas' or 'natural gas.' During the stay of Mine Rescue Car 5 of the Bureau of Mines in the summer of 1914, the presence of this gas was noted by a member of the mine-rescue class, an underground shift-boss. Samples taken by the water-displacement method had the composition shown by the accompanying analyses.

| | (a) | (b) |
|-----------------------|--------|--------|
| Oxygen | 0.55 | 0.52 |
| CO ₂ | 0.65 | 1.08 |
| Nitrogen | 98.49 | 98.40 |
| Total | 100.00 | 100.00 |

The high nitrogen content, 98.40%, and the low oxygen content, 0.52%, are noteworthy. This is the greatest deficiency of oxygen that the writer has ever noted except in gases from a fire area. Apparently the evolution of this gas is associated with the genesis of the ore deposits of the district. Nitrates have been found in the mine-waters, and the surrounding country is full of hot springs, the waters of which show nitrates.

Careful inspection revealed that usually the gas was given off from the 'water-courses' and 'vug-holes' in the orebodies. So far as could be ascertained, this gas is not found in the country-rock. It collected in blind raises or in the tops of dead-end stopes. The air currents in the drifts under the raises created a definite line of separation at the bottom of each raise, above which a carbide lamp would be instantly extinguished.

In one mine investigated, the shift-boss stated that in a certain drift on the 800-ft. level the miners often drilled into fissures, and that the rush of gas from the drill-holes would immediately extinguish their lights and drive them from the place. It only required, however, a compressed air line carried to the face to clear the drift of gas so that the men could go back to work.

In the blind raises the air-line would completely rid a raise of the gas, but over-night a raise would refill. In a long drift on the 600-ft. level of one of the mines, a vug-hole or crevice was pointed out as producing 'natural gas.' On close inspection it was found that a carbide lamp extended into this crevice was immediately extinguished. The gas could be expelled by blowing a full breath into it, but in three minutes it would refill so that the lamp would not burn.

The physiological effect of breathing this gas is similar in every way to that produced by breathing pure nitrogen. A man is likely to drop dead without warning because of the lack of oxygen. In the weak mixtures, in which there is more oxygen than is shown by the analyses, but considerably less than in normal mine-air, a man breathes deeply, but shows no alarming symptoms of distress. A candle is extinguished, and the flame of a carbide lamp reaches forward and turns red, as might be expected from the incomplete combustion consequent on want of oxygen.

In a Goldfield mine a pipe-fitter lost his life in trying to disconnect a pipe-line extending into a raise that had filled with this nitrogen gas. The man was found face downward at the bottom of the raise in a position indicating that he had fallen. He had carefully placed his candle in the pure air at the bottom of the raise, evidently because it would not burn when he took it with him. The analyses cited above represent duplicate samples taken by me in the top of this raise, 50 ft. above the stope. A set of self-contained oxygen breathing apparatus was used in collecting the samples.

Washington, D. C., February 10.

E. STEIDLE.

[The above communication from the district mining engineer of the Bureau of Mines conveys a useful warning.—EDITOR.]

HOISTING ROPES at the Copper Queen mine are shortened every month by cutting six or eight feet off the end to change the points of maximum wear, said G. F. G. Sherman in a paper at the San Francisco meeting of the A. I. M. E. Sheaves are 7 ft. diameter and are lined with leather, as wood lining broke down rapidly. By reason of winding the rope on the drum in two layers instead of one, the rope-cost per ton of ore hoisted increased from 0.17c. to 0.3c., amounting to an additional cost of \$1000 per year. But to obtain this reduction, an additional expenditure on the hoisting-engine of \$15,000 would have been necessary. When a rope is wound upon itself, a good deal of sliding takes place of one coil upon the other. Lubrication of cables in general is of great benefit in preventing wear.

Antimony in China

By F. L. Cole

HISTORICAL. The high prices for antimony have directed attention to China as a source of supply. Owing to the mining being entirely in Chinese hands, there has been little accurate information published regarding ore occurrence or smelting methods. The first record of antimony ore in the Chinese customs returns was in 1895 when a small quantity was exported from Shanghai. In 1904 the returns show that regulus, crude,* and ore were exported. These three, together with antimonial refuse, which is also called 'ash-and-slag,' being the residue from producing crude antimony, have since then become regular articles of export. Antimony oxide has recently appeared in the customs returns, but it is probably the natural oxide or oxidized ore. The first recorded exports were from Hunan province, which has continued to be the leading producer. No proof exists that the ancient Chinese mined antimony, but they produced iron, copper, lead, zinc, and other metals for many generations. Local tradition has it that two Swiss jewelers at Shanghai, on being shown samples of antimony ore, immediately traced the source, and started the trade in 1895.

Exports first were made from Shanghai by a few foreign merchants. The foreign merchant in China used to handle everything that gave a profit and in early days the profits were not small. The ore was brought from the interior to the merchant, who sampled it, paid as little as possible, and shipped the cargo to Europe or America. The business gradually grew and the headquarters of it moved up the Yangtze river to Hankow on the arrival of German metal-buyers, who brought out men familiar with the trade. Later, the centre moved to Changsha in Hunan, 250 miles farther inland. Now buyers go direct to the mines with hard money in hand and compete with each other for ores and products from the opulent mine-owners, who make their own prices.

ORE DEPOSITS. Antimony is known to occur in nine provinces: Chekiang, Kwantung, Kwangsi, Yunnan, Szechuen, Kweichow, Hunan, Hupeh, and Kiangsi. Of these Hunan is the principal producer, but the production in Kweichow, Yunnan, and Kwangsi is growing. It is reported by the native press that the duties in Kwantung on antimony have been remitted for three years from last October in order to stimulate exploitation.

C. Y. Wang, in the 'Mineral Industry' for 1913 mentions the localities of occurrence in Hunan, Kwangsi, Kwantung, and Kweichow. A. S. Wheeler, mining engineer for the Board of Agriculture, Commerce, and

*['Regulus' means antimony metal of 99% purity; 'crude' is the artificial antimony sulphide of much lower purity.—
Editor.]



Industry, Peking, in the September 1915 issue of *The Far Eastern Review*,¹ has given the best general description of the Hunan deposits. There is little reliable information regarding the other occurrences although the general geologic conditions are somewhat similar.

The Hunan deposits may be generalized as fissure-veins with quartz gangue cutting shale, quartzite, and schist; and scattered deposits in limestone. With the exception of the Pan Chi mines (described by Wheeler, and also in the MINING AND SCIENTIFIC PRESS of July 10, 1915) none of these deposits has been exploited to any depth. The entire output of Hunan is 6000 tons of ore per month.

W. R. Schoeller² described the Hunan ores and gives interesting information as to their purity. No careful study has been made as yet. The ore is principally stibnite, which in favorable places both at surface and underground is more or less oxidized.

The mines, like all Chinese underground workings, are mere gopherings, with no apparent system except to get out the visible ore above water-level as quickly as possible, in any manner, and with no thought of development. A pinch in a vein or a fault is enough to cause work to be abandoned. Native-made black powder is used, and antiquated clumsy tools that add to the general inefficiency. The working-places are impossible for any but natives and the output per man is decidedly small. The ore is carried or dragged to the surface in bamboo baskets, and small amounts of water are handled in hand-operated bamboo plunger-pumps that work in relays, the sump of one being the discharge of the other. Open-flare oil-lamps, the smoke of which, together with the general insanitary conditions underground, make it anything but pleasant.

The purpose seems to be to obtain the least possible results and provide the most work for the greatest possible number of people. But when the cost of the labor is considered, the results are not as bad as would be supposed. Until recent prices stimulated search, only high-grade ores were mined, but at present all possible grades are utilized and all old waste-dumps are being carefully sorted. Each outcrop has numerous companies working on various lengths, usually units of 10 Chinese feet (said feet varying with each locality) and the working of each company is called a 'mine.' So reports of a large number of mines in a district are apt to be misleading. Actual work is done on a kind of co-operative basis by contractors, wages seldom being paid for day's work. The Chinese insist on having a gamble with everything they undertake, so there are innumerable combinations of leases and sub-leases, which the foreign brain is incapable of comprehending. Theft is not unknown, but unless carried on in too open a manner, no attention is paid, as "everybody is doing it." Payment for labor is usually at a price or at so much per

¹See also M. & S. P., March 4, 1916, 'Metalliferous Mines of Hunan.'

²Journal of Society of Chemical Industry, London section, No. 6, Vol. XXVII, 1908; No. 19, Vol. XXXII, 1913; No. 4, Vol. XXXIII, 1914.

pieul (133½ lb.) of clean ore, at the pit-mouth. The ore so received is sold to the nearest crude smelting-plant, which also absorbs the local high-grade output.

Hunan province, being rather independent, pays little attention to the various lengthy rules and regulations made by the Central government at Peking. The discoverer of an outcrop can apply for a prospecting-right over a given area through the local officials and the provincial guild to the provincial mining department. This permit entitles him to open the property; after a time, application is made for a working-permit accompanied by fixed payments. This permit necessitates a survey. Recent rules require any exploiter or company to show that there is actually a certain amount of capital available for the proper opening of the mine. This is obviated by forming a company and giving the shares a cash value equal to the requirements, with very little, if any, actual cash in the treasury. This rule is held over the heads of the small people but those in power can cheerfully dodge its ramifications. A tax of 5% on the value of the ore at the mine is collected, and a guild-tax and a 5% export-tax are collected by the customs on the market-value of the ore or products before they are exported. There are probably local taxes on smelting-plants, and various transport-dues along the roads and rivers.

As mining has been done profitably for some years in Hunan, the local rules are more helpful than otherwise to the industry. Transport of ore from the interior to steamer connections is done by coolies overland and by boats on the rivers.

SMELTING METHODS. The furnaces for producing 'crude' metal are simple in construction and are made with no regard to economy either in fuel or the recovery of oxide from the escaping fume. They are built in units of four, occupying a floor-space of 12 by 2½ ft., and standing 5 ft. high. One furnace can be repaired while the other three-fourths of the unit is working. The bricks used are local and the cost of one unit varies from \$20 to \$40. The grate-bars and doors are also made locally, the grates consisting of 12 to 16 bars, a half-inch thick, 14 in. long, and spaced about a half-inch apart. The smoke and fume go to a common flue at the top of the furnace and are carried down in the centre to a common underground flue connecting with a chimney that serves all the furnaces.

The pots used are made locally; they average 12 in. inside diameter, 18 in. high, and the hole at the top is 7 in. They hold 50 lb. of ore. As shown in the sketch, the lower pot is cut on one side to receive the bottom of the upper pot. The upper pot has a small hole about a quarter-inch wide and an inch long cut in the bottom for the liquated sulphide to drop into the lower pot. These pots never join tightly and much fume escapes. The pots last up to two weeks, depending on the care of the operators, and become broken from the stirring of the ore in the upper pot.

When the furnace is hot, the upper pot is charged with lump and fine ore mixed, the larger pieces about the

size of a dollar. Cheap local coal is used and the fire raised after charging. The tops of the pots are loosely covered, usually with a round cast-iron cover that collects oxide on its lower side. As soon as the temperature is high enough the ore begins to liquate, forming a pasty mass, and is frequently stirred with iron rods until it is considered to be finished, when it is in a more or less dry state. Meanwhile, when enough liquated sulphide has collected in the lower pot, it is dipped out with cast-iron spoons into molds which form brittle bricks of 16 lb. weight. The bricks are then weighed and boxed for shipment. The residue, left in the upper pot, is removed by spoons and thrown into a square iron box formed by two L-shaped castings; when cool the refuse is in a solidified hump. This refuse contains from 12 to 30% of antimony and silicious gangue, depending upon

Smelting Co. the rights for China for the Herrenschmidt volatilization process; furnaces were installed in Changsha by French engineers and they have since been operated by Chinese. This process converts sulphide ores into tri-oxide, which is smelted for regulus in reverberatory furnaces. The best results are obtained on low-grade ores.⁴ The Wah Chang Co. also obtained from the Peking government the sole right to produce regulus in Hunan. This company owns some low-grade mines and also purchases ores. The Herrenschmidt furnaces have been erected in Yunnan near the treaty port of Mengtze by the Pao Hua Co., also connected with the Wah Chang Co. The latter produces regulus from erude, after converting it to tetra-oxide by a slow roast and also from oxide ores by direct smelting. There are at present several other plants in Hunan smelting oxide ores direct,

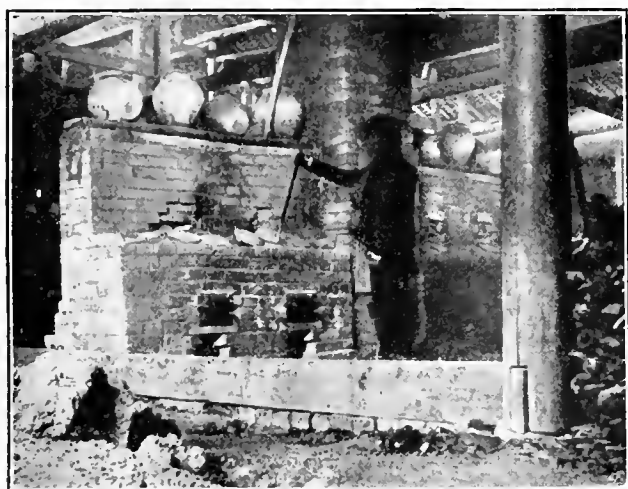

SHOWING OPERATION OF ANTIMONY FURNACES FOR PRODUCING 'CRUDE' METAL IN CHINA.

the grade of ore and the care used in smelting. The operation requires two to four hours during which time the furnace is surrounded by fumes that are unpleasant and injurious. Since the value of the tri-oxide has become known it is occasionally collected from the flues and chimneys and sold to plants producing regulus.

The smelting is done by contract, the contractor furnishing the labor, fuel, and pots, and keeping the furnaces in repair. There are at least twice as many men employed as necessary. Prices vary with local conditions but 'crude' is usually smelted for \$15 per ton. It is packed for shipment in cases bound with strap-iron and holding 224 lb. net, and about 240 lb. gross and measuring 10 by 10 by 22 inches. The cases are poorly made, and as the metal is brittle there is often loss by breakage. Cargo is usually re-packed in Changsha or Hankow and the cases bound in sacking before ocean shipment.

The smelting of 'regulus' in Hunan is on an entirely different basis from that of 'crude' smelting, as it is practically controlled by a monopoly. In 1908, C. Y. Wang³ obtained in France for the Wah Chang Mining &

but they all either sell their product direct or through the Wah Chang Co. This company's monopoly is contrary to the letter and spirit of various treaties with foreign powers, but so far they have succeeded in keeping their rights and have even had them extended.

The reverberatory furnaces used in smelting of oxide ores vary in size from a capacity of 300 to 1000 lb., the size holding 500 lb. being most used. They usually have a low roof sloping downward toward the chimney and a deep bed with its lowest point opposite the one working-door. The hearth sometimes consists of a square cast-iron box lined with ground fire-brick and kaolin mixed, which is put in wet and well beaten; at other times the lining is used without the iron box.

The same lining is generally re-used and is unsatisfactory, lasting from one week to two months, and an extra number of furnaces must be kept in repair to assure a constant output. The furnaces are fired with soft coal and are connected to a common chimney through flues, generally underground, that are occasionally cleaned for the condensed oxide. The oxide is mixed with soda-ash and charcoal in varying proportions, usually about 10% each. When the charge is

³'Antimony' by C. Y. Wang; 'Metallurgy of Non-ferrous Metals,' William Gowland.

⁴M. & S. P., July 10, 1915.

melted the furnace is cooled a little to thicken the slag, the slag is entirely removed and the molten metal skimmed clean. A 'starring' flux is then added composed of soda ash, powdered crude, a little charcoal, trioxide, and sometimes small quantities of powdered oxy-sulphide ores. This starring flux is varied according to the kind of material being melted and is used over again until it will no longer produce the 'star.' As soon as the flux is melted, samples are taken of the metal; when it gives a good star the refining is judged to be complete and the charge is ladled out with cast-iron spoons into molds, producing a cake 8 by 8 by 4 inches and weighing 40 lb. A little slag is put in the mold before the metal is added, and the metal is kept covered with slag. The whole operation takes from four to six hours. Oxide ores are smelted in the same manner, being broken by hand to one-quarter inch size; the charge is more frequently rabbled and the operation requires 10 to 12 hours. Regulus is boxed for shipment in boxes similar to those for crude, except slightly smaller and weighing (net) ten cases to the long ton.

With careful manipulation the losses in smelting oxide are not over 6% and with oxide ores from 10 to 15%. Some of the loss is condensed as oxide in the flues and recovered. The star is no guarantee of purity and can be produced on 95% regulus as well as on 99%. With the naturally pure oxide ores and with the oxide from pure sulphide ores or the residue from 'crude,' the production of 99% (or better) regulus is only a matter of careful manipulation. As far as known, no one in China is producing regulus from crude or sulphide ores by the precipitation methods. The smelting of antimony refuse is being done at several plants, and with one exception the processes used are practically similar. The operation is to heat the refuse with charcoal or coke in small brick shaft-furnaces, lined with fire-brick, using a light blast and condensing the fume in chambers and scrubbing-towers. Numerous difficulties arise, the principal being the length of time required to oxidize the refuse and the difficulty in handling large charges, since the charge agglomerates, having to be constantly punched with bars. The condensers are various, but condensing seems to be the least difficulty; the best results are obtained in small furnaces with easily removable grate-bars, completely closed, and with an air-blast sufficient to oxidize the antimony and not melt the gangue, which is principally silica. These furnaces are opened and the scoria removed several times a day through the grates. Charging is done in small quantities at frequent intervals. With a high scrubbing-tower no suction is needed for the condensers. Two furnaces 9 ft. high and 3 ft. interior diameter connected to brick condensing-chambers, in all 50 ft. long, thence to a 40-ft. wooden scrubbing-tower, will handle per day three tons of refuse containing 25% of antimony. Refuse containing less than 15% antimony is hardly worth treatment. The oxide obtained is quite pure and contains from 65 to 80% antimony. Whenever the fume comes in contact with water, sulphuric acid is produced, causing trouble with

pipes and tanks for the precipitating of oxide from the scrubbing-towers. One plant has a blast furnace with a capacity of 20 tons of refuse per day; it is intended to condense the fume, charge limestone and iron for flux, and produce crude metal to be refined in reverberatory furnaces. A mechanical roaster for successfully handling the refuse in larger quantities would be satisfactory. Flotation would probably produce a high-grade concentrate. However, the supply of refuse being limited and coming from many sources and the amounts remaining in the old dumps having been well collected, there is not enough supply available to warrant any extensive installation for this particularly interesting branch of the industry, and it would hardly be profitable with low market-prices. From the average quality of refuse, a ton of regulus is produced from six tons of refuse. One plant is smelting under contract to produce regulus containing 65% of the antimony contents of the refuse.

Constant careful supervision, preferably foreign supervision, is necessary to prevent theft and to obtain good results in smelting. Skilled labor with competent supervision in China is more of a problem than is generally supposed. The actual cost in making one ton of regulus by the Herrenscheidt process, including power, labor, supervision, fuel, and fluxes is not over \$25. One plant quotes \$35 for custom smelting of oxide ores. The actual cost of smelting oxide ores of 50% antimony, including the above items, without power, is not over \$15 per ton of regulus. Depreciation, repairs to plant, and other charges vary with the size of the plant. The price of ore varies with the market price of the metal. When the price is \$125 per ton, regulus can be made and sold at a profit of at least 50% and at the present prices there is a profit of from 100% to 500%, depending on how fortunate the producer has been in securing his ore. There is much room for technical improvements in all the processes, and these may come with low prices and competition.

The present scale of wages and prices for materials, with normal freights and prices, render it difficult to see how any other country can compete with China in producing 'regulus' and 'crude.' The Wah Chang Co. has an output of 15 tons of regulus per day, and several other producers bring the total for Hunan to 20 tons per day. At or near Hankow there are five plants supplied with ores from Hunan. Three plants are working on refuse, and two on oxide ores, with a combined production of 10 tons per day. The plant near Mengtze, Yunnan, was producing two tons per day in September; there is some production from Wuchow near Canton, and ores are being shipped to Japan from Canton.

MARKETING. Up to the beginning of the War, the export of antimony was principally in the hands of the New Chinese Antimony Co., a branch of Cookson & Co. of England, together with French interests, and a few German firms who were interested in ores and metals besides antimony. The New Chinese company had an agreement with the Wah Chang Co. for all of their out-

put and the latter could sell only to it. Differences arose in this agreement at the beginning of the War, resulting in cancellation of the agreement, but the Wah Chang pays the New Chinese a percentage on all sales for one year and can sell to anyone. Having experienced a boom at the time of the Russo-Japanese war, the Chinese dealers were confident that another boom was coming, and the Wah Chang Co. immediately absorbed several independent producers and strengthened their political fences so that in a few months they virtually controlled the Hunan market, not only for regulus, but for crude and ore as well. Huge profits have been made that will stimulate mining in Hunan. Buyers from all sources came into existence, as nearly every foreign firm in China wanted antimony and the local prices jumped

ers often sold to the nearest cash buyer regardless of the contracts hanging over them, with the result that the foreign merchant who had contracts and had sold forward on the strength of them was left holding the bag. The result has been that, with the exception of a few reliable producers, all business is cash and there are numerous cases for settlement involving large sums in which foreign consuls are writing demands and pounding tables in vain, as there seems to be no remedy for the recovery of money advanced or cargo that should be delivered. The Wah Chang Co. opened an office in New York, where it sells its own output, and the export business has resolved into the hands of a few foreign firms. Japanese have been the largest buyers of crude as they ship to Japan and convert it into regulus for the Russian and American markets, having the advantage of their own shipping companies and financial organizations. Some ore is being produced in Japan and a little from Korea; also there is some produced from Indo-China but the bulk of the Japanese regulus is made from Chinese crude.

Since the War very little ore has been exported from China except that which was bought previously; the high freight-rates and the difficulty of getting shipping space for bulk cargo preventing ore shipments abroad. Chinese regulus suffers in the market from either lack of advertising or astute competitors, as analyses show it to be as good or better than other brands.

The table below shows the export of antimony from Changsha for 1915 to November 1, the 1914 statistics for all of China being not yet available. The ore and refuse went principally to Hankow for refining.

| | |
|------------------------|-----------------|
| Antimony regulus | 5,255 long tons |
| Crude antimony | 13,502 " " |
| Antimony ore | 743 " " |
| Antimony refuse | 3,839 " " |

ORE-STORAGE BINS at the hoisting levels in the Copper Queen mine have a measuring hopper holding one skip-load. Hoisting in balance at the maximum rate of a skip per minute, and allowing 15 sec. for tripping the hopper, each loader has $1\frac{3}{4}$ min. between times to load the hopper. In actual practice the time required to dump the 58 cu. ft. of ore into the skip and ring it up rarely exceeds 12 sec. and is frequently only 10 sec. In three shifts of one day, 3899 wet tons was hoisted, or practically 1300 tons per 8-hr. shift. Deducting 30 min. for lunch, the hoisting rate has been 1.1 skip per min. On occasion when the ore is muddy, a third man is required and only 20 or 30 skips per hour can be hoisted. Trouble is occasioned from spillage of ore, while loading into the skips, which a screen with three sides attached did not appreciably reduce so it was removed. The spilled ore averages 17 lb. per skip or 0.21% of the ore hoisted; this spill has made heavy wear on the timber in the hoisting compartments. The skips have been rebuilt from a capacity of 70 cu. ft. to 90 cu. ft. to give a margin for overload. The above notes are abstracted from a paper by G. F. G. Sherman read at the San Francisco meeting of the American Institute of Mining Engineers.

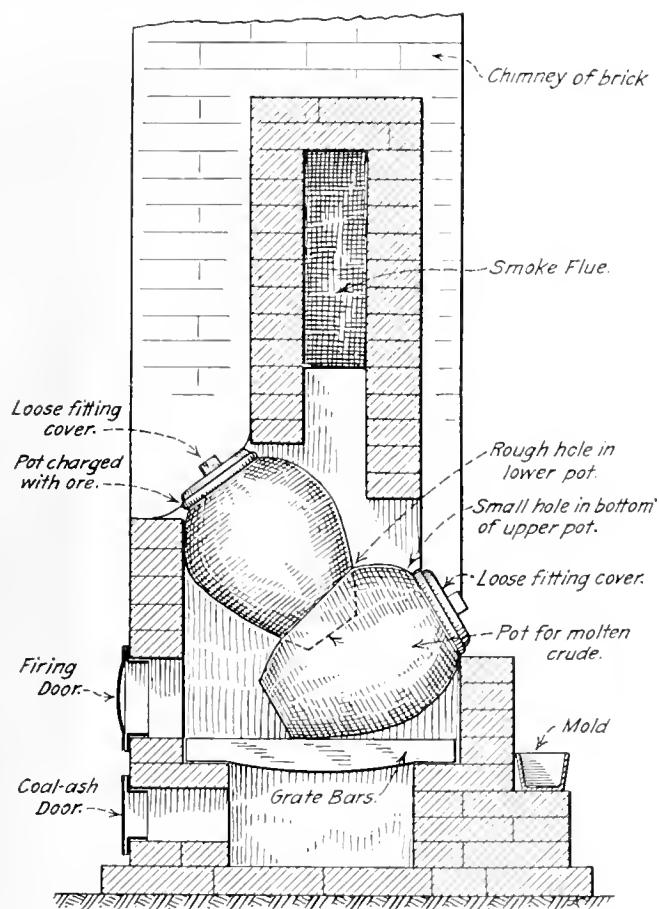

SKETCH OF ANTIMONY FURNACE FOR PRODUCING 'CRUDE' METAL.

daily. Few of the would-be buyers knew anything about antimony and consequently there were some sad mistakes. The home brokers and buyers wanted firm offers for a few days, but the Chinese wanted cash, as the time lost in telegraphing might result in the loss of a sale on a rising market, which was often the case. Formerly regulus, crude, and ore were purchased on contract for forward deliveries with part payment in advance or in some cases full payment in long-term native drafts that could be discounted locally, so the dealer often had the cargo and had turned it for a profit before the drafts came due. With the rising market, however, matters changed completely, so that producers and native brok-

Points of View From Lake Superior

By P. B. McDonald

One-time residents of the upper peninsula of Michigan read with interest of the great snow-storm that hampered the copper production during January to the extent of 8,000,000 lb. Railroad transportation was suspended for days at a time by an old-time Lake Superior blizzard that heaped the snow in immense drifts across the tracks.

F. B. Close, who returned recently to the Copper Country after a varied experience in North and South America, is doing a good deal for the development of the Porcupine district. Besides the White Pine Extension of the Smith-Stanton interests, he is directing other explorations for Chicago and Duluth financiers.

The Cleveland-Cliffs Iron Co. continues to expand its ore business. The largest operator on the Marquette range, it is opening mines at Iron River, and has purchased 10 additional steamers for transporting ore on the lakes. Its 1916 shipments will aggregate between 3,000,000 and 4,000,000 tons. On the other hand, the Rogers-Brown companies of Buffalo are decreasing their holdings in mines and steamers by sale.

At some of the iron and copper mines it is found profitable to employ a 'drill-inspector,' perhaps a young engineer, to visit the miners underground and quietly introduce efficiency ideas while ostensibly examining the drills to see that repairs and sharpening are properly done. 'Drill-inspector' is a term better liked by the miners than 'efficiency engineer.'

Re-treatment of tailing, now a recognized economy in the Copper Country, will be extended at the mills of the Copper Range Consolidated by nearly doubling the equipment of Wiltley tables. Instead of increasing the number of Hardinge mills, these will be supplied with manganese-steel balls, which make it possible to re-grind a much larger tonnage than with flint pebbles. The Quincy is also using steel balls in its large type of re-grinding mills. The tendency to substitute manganese-steel balls for Danish and French pebbles, since the War raised the price of the pebbles, has the objection that the price of manganese steel is rising likewise.

Flotation experiments continue on copper ores, particularly from the White Pine district, where the copper is exceedingly fine. The White Pine Extension has had detailed tests made by A. J. Houle, T. G. Chapman, and J. B. Cunningham. Working with ore in which the copper was too fine to permit of the ordinary method of concentration, a recovery of 80% has been made, obtaining a concentrate of 20% copper. The Calumet & Hecla is conducting flotation tests at Lake Linden under the

direction of a metallurgist from the Inspiration mine in Arizona. It is hoped to get the concentrate up to a commercial proportion of 30% copper by improvements in the methods and oils.

Isle Royale—not the mine near Houghton, but the island in Lake Superior famed for its scenery—is to be explored during the summer by T. F. Cole and associates, who have taken over the extensive mineral holdings. This island is over 40 miles long, or four times the distance between Houghton and Calumet. The Indians used to mine copper there for weapons and utensils, and attempts have been made to develop the mineral resources. It is a wild inaccessible place in winter.

James MacNaughton, in recent interviews and writings, indicated the important economies attained in the operation of the Calumet & Hecla and its subsidiaries. Among other things he said: "I expect to see the time when 13-lb. 'rock' can be made to yield a profit; at several mines during 1915 ore was mined and milled for \$1 per ton. * * * The C. & H. re-crushing plant is treating 1200 to 1400 tons of tailing per day and we are getting a larger recovery of copper at a lower cost than was estimated. * * * The use of the one-man drill and Carr bit has resulted in an increased output per miner equivalent to his total production of a few years ago." Incidentally it is interesting to note that surprising increases in native silver are being met with in the deeper levels of the C. & H. conglomerate.

Just as the copper mines are striving to make 1916 a record year, so the iron mines of Michigan and Minnesota are counting on the biggest shipping season in their history. The output of iron ore to lower Lake ports is expected to total well over the record of 50,000,000 tons that was attained in 1913, and some doubt is beginning to be felt as to whether or not the carrying capacity of the lake ore-fleets will be sufficient to accommodate the extraordinary tonnage that the railroads will bring to the docks at Duluth, Superior, Two Harbors, Marquette, Escanaba, and Ashland. It is true that the iron trade is a barometer of the country's industry, and it is also true that for the past two years things were very dull on the iron ranges, so that it looked at times as though Cleveland and Pittsburg capitalists had regretted the millions of dollars put into ore mines. Now, however, the old enthusiasm and aggressiveness have returned, and great ore-trains will soon be rolling out of the range towns in number fully up to the expectations of the long-headed men who equipped and developed the mines. The shipping season will open in April.

The 30th Anniversary Reunion of old graduates and students of the Michigan College of Mines, scheduled for August 8, 9, and 10, will bring back to Houghton men from all over the World, many of whom have not met since leaving college.

The Electro-Statics of Flotation

By F. A. Fahrenwald

THE development of every new metallurgical method is accompanied by a host of contradictory statements and widely differing opinions, but it is only by the elimination and correlation of parts of recorded observations that a particular process approaches a state of perfection. The theory of flotation has called forth a number of articles, each writer applying a different hypothesis in explaining the puzzling phenomena accompanying the process.

Of the various hypotheses thus far advanced only two are based on principles of sufficiently apparent soundness to warrant serious consideration.

The first of these involves the physical surface phenomena that may produce an inter-facial tension. This has, until recently, been accredited with more importance than all the other explanations combined. The second is called the electrical theory.

The part that surface phenomena may play in linking the particles of ore to the bubble-carriers is ably outlined by O. C. Ralston, whose treatment¹ of this phase of the question includes reference to about all of the theory that has so far been found applicable to flotation. Without doubt a proper application of the laws of physical chemistry will disclose fundamental principles upon which this process may be based, and it may be in the field of colloidal chemistry that most information is to be gained.

With regard to the electrical theory, however, there has been applied a number of laws of electro-statics that, from the general nature of conditions under which flotation is carried out, would seem to be inoperative.

This hypothesis has been tolerated by Mr. Ralston,² it is strongly advocated by J. M. Callow,³ while Thos. M. Bains, Jr.,⁴ excludes all other theories. These three references contain the gist of all arguments advanced in support of this hypothesis, and the last of them elaborates and definitely formulates the necessary requirements for flotation by electrical means. It is my object to attempt an analysis of the various arguments advanced in support of the electrical theory, and as the only difference between this and any other theory lies in the phenomena that cause the bond between the flotative mineral and the bubble-carrier, it is understood that only this phase of the process is under discussion. It is necessary, however, in order to arrive at practical conclusions, that this question be considered under conditions similar to those encountered in practice.

Before proceeding to a discussion of the electrical theory of flotation it will be necessary to point out briefly a few of the facts of electro-statics upon which it is based.

A. The production of electricity by friction is a common phenomenon; almost any two bodies become electrified if they are rubbed together. In the case of several substances, considerable force is then necessary in order to separate them. Attraction or repulsion also occurs when an electrified body is brought near bodies that have been subjected to friction and if these are light enough (as bits of pitch, feathers, wood, paper, etc.) they may be lifted. Bodies may also become electrified by coming in contact with other bodies that already carry a charge. In this case the first body receives electricity of the same sign from the charged body and is then repelled.

B. Bodies that when electrified at one point are immediately electrified all over are called good conductors; those over which the charge diffuses slowly are poor conductors. All metals, many metallic ores, graphite, ordinary undistilled water, and aqueous solutions of salts are good conductors.

C. If a piece of metal, or other conducting material held in the hand is rubbed against a non-conductor—say, a piece of dry flannel—only the non-conductor appears afterward to be electrified. The reason is that the electrification produced on the metal spreads over the hand, arm, and body of the experimenter to the floor and walls of the room. If, however, the conductor be insulated, the degree of its electrification cannot be increased or decreased.

D. By whatever process a body is electrified there is always an equal amount of electricity of the opposite sign, which may reside upon the walls of the enclosing room or upon some other surface insulated from the conductor. Bodies carrying opposite charges, when brought in contact or connected by a conductor, become discharged. If the charges are equal they are neutralized, but if one carries more than the other the system takes on the sign of the excess charge.

E. If these bodies are strongly electrified, discharge can take place through an appreciable thickness of non-conducting material, such as air, oil, or glass. This discharge is facilitated by the presence of sharp projections upon either body.

F. (a) The space between two charged bodies is filled with lines of force that tend to move a contained body in the direction of the local lines of force leading to the surface carrying the opposite sign.

(b) These lines of force do not penetrate the surface of the conductors forming its boundaries and a hollow

¹'Why do Minerals Float?' M. & S. P., October 23, 1915.

²Op. cit.

³'Notes on Flotation,' M. & S. P., December 4, 1915.

⁴'The Electrical Theory of Flotation,' M. & S. P., November 27, 1915, and December 11, 1915.

conductor is electrified on its outside or inside surface only, depending upon whether the opposite charge resides upon one contained without the sphere or upon one contained within and insulated from the shell. In the latter case the entire field is contained within the inner surface of the sphere, and in the former case there is no charge within the hollow conductor.

G. The force exerted between two small charged bodies is given in the equation $F = \frac{qq^1}{d^2}$ in which q and q^1 are the charges in electro-static units carried by each of the two bodies, and d is the distance between their centres of charge.* If the bodies are separated by a medium other than air a factor K , known as its dielectric coefficient, must be used, and the equation becomes $F = \frac{1}{k} \cdot \frac{qq^1}{d^2}$

H. Matter itself is not acted upon by an electric force, which acts only between different quantities of electricity. When a conductor is introduced into an electric field it represents a gap or an interruption of the lines of force, resulting in an electrification of its surfaces only, that part becoming positive which is presented toward the negative boundary of the field and the reverse. In other words, the original field is divided into two. This same effect is produced in the case of a poor conductor but to an exceedingly small degree. This explains the attraction of small bodies by another that has been electrified by friction, in which case electrification by influence precedes attraction, and what is really observed is attraction between opposite electric charges.

Before considering these fundamental laws of electro-statics in connection with an explanation of flotation phenomena, it may be well to consider briefly the conditions under which different phases of this process take place.

Of first importance is the fact that all operations are carried out in conducting solutions which in every case are earthed. It is inconceivable that, after any grinding process has been applied in machines such as are commonly used, the individual positively charged particles of ore should not have come in contact with negatively charged bodies and with conducting parts of grinding and mixing machinery, even if oil has been added in a preliminary stage. The ore particles are conductors, the oil is a non-conductor, the bubbles are filled with non-conducting air, and the gangue is composed of non-conducting material.

These conditions being granted, the next step will be to apply the laws of electro-statics to criteria for flotative conditions according to the electrical theory as summarized by Mr. Bains. These include the main ideas of Mr. Callow's article and of the theory in general, so that a discussion of these in order will apply to the various other articles advancing a similar hypothesis.

1. "Ores containing valuable minerals or metals that

are good conductors are the only ones that are suitable for flotation."

This seems in general to be true, but the ratio of flotative tendency to conductivity of the different ore constituents is nothing like a constant. For instance, the conductivity of galena is to the conductivity of chalcocite as 35:1. Their flotative tendencies hardly bear this ratio.

In entire opposition to this supposed requirement I found that small pieces of diamond attract a grease[†] or oil coating and attach to bubbles quite as readily as does galena.

2. "To buoy these conductors, it is necessary to supply enough electrified bubbles from below to float particles of the conductors that are attracted; hence the smaller the bubble, the better the result, the amount of gas being the same."

A bubble within a solution of various salts and acids presents a similar condition to that of the air-space within a hollow conducting sphere. It is known (see F (b) above) in this case that in order to have a charge upon this inner surface it is necessary that an opposite charge be maintained within and insulated from it. In the case of the bubble there is nothing inside to carry the charge. In case this space carried water-vapor or ionized gases, a charge could be present, but it would be dissipated quickly by diffusion of these charged particles and resulting contact with the water-surface.

If this sphere did contain charged gases and was lined with oil, there would be present the condition of the hollow conducting spheres, F (b) with enclosed charged conductor insulated from it, and carrying an opposite charge. The charges would be equal and the amount governed by the charge on the inside sphere. These charges being balanced, the bubble system could have no influence upon a body—charged or not—without the outer sphere, such as a particle of galena suspended in the water at a distance. There can be no attraction through the intervening conductor, as lines of force will not penetrate a conducting surface.

It appears evident then that, first, unless a bubble contains charged bodies (ionized gas, water-vapour, or solid) within its bounding sphere it can carry no charge; second, that unless it is lined with a dielectric the charge will be rapidly dissipated; and, third, even though a charge is present and insulated from the outer conducting sphere it can have no attraction for any body or charge without the outer sphere, through a thickness of solution.

3. "Some dielectric fluid is necessary to cover the conductor or the bubble, to prevent the dissipation of the electric charge. The thinner the film of dielectric and the greater its dielectric strength the greater the attractive force and the more permanent will be the froth."

The bubble, both insulated and otherwise, has been considered. The particle of ore, unless insulated, will

*The force exerted by a charged sphere acts as if originated at the centre.

[†]This fact is made use of in the recovery of diamonds at Kimberley.

be immediately discharged by coming in contact with a grounded conductor—the solution. It is immaterial whether the opposite charge is carried by the water or by some other surface, the effect will be the same. Assume, however, that the ore particle is charged, and insulated. Again we have the case of one charged conductor (the ore) being enclosed within another (the surrounding water solution) giving a system which is

before coming in contact with the conducting solution is not reasonable.

Assuming, however, that both bodies are charged, so that the second part of No. 3 (above) regarding the thickness of insulation may now be considered.

It has been proved that the force exerted by a charged sphere acts as if it was concentrated at the centre. Bearing this in mind, it is evident that in the case of particles of the size with which flotation deals, a separation of their surfaces by one micron or one millimetre will produce little practical difference in the force exerted between them.

4. "Some material must be added to the water to increase its conductivity, to obtain a clean concentrate: acids in small amounts are now used."

This factor has been considered under divisions 2 and 3. The working solution is a conductor, parts of which are interposed between the various charged particles, thereby breaking all lines of force between them.

In any attempt to determine experimentally whether or not electro-static forces play any considerable part in holding the bubble and particles of ore together it is rather difficult to select tests which will give results of value. If these forces act to the exclusion of all others it is evident that they would be represented by charges of easily measurable magnitude. For example, I have separated particles of galena (uncoated with oil), that have been carried to the top of an acid solution, weighing 60 mg. (52 mg. in water). To hold a particle of this size to the surface of a bubble requires 50.9 dynes—call it 50 in round numbers. The diameter of this particle is about 2 millimetres. The bubble required to buoy this particle must displace at least 52 mg. water, or in other words its volume must be 52 mm³. Its diameter would be about 5.2 mm. Using these figures the equation for force becomes $52 \text{ (dynes)} = \frac{QQ_1}{12.96}$ or assuming the charges to be balanced

$$Q^2 = 673.92$$

$$Q = 25.9 \text{ e. g. s. electro-static units.}$$

It is not likely that a particle of ore or a bubble of the nature given can have a charge of this magnitude, for the reason that a potential of this intensity would discharge through a very strong dielectric. Experiments have been carried out that give ratios for electro-static units, potentials, and distance through which discharge will take place in air, using brass knobs of one centimetre diameter.

| Electro-static units. | Volts at discharge potential. | Distance between knobs. |
|-----------------------|-------------------------------|-------------------------|
| 16.1 | 4830 | 0.1 cm. |
| 56.3 | 16890 | 0.5 cm. |
| 84.7 | 25404 | 1.0 cm. |

According to these figures the charge necessary to exert a force of 50 dynes in lifting a particle of galena would be so intense that it would discharge through a dielectric as strong as air at the distance by which the centres of charges are separated. Not satisfied, however, with this apparent theoretical disproof of

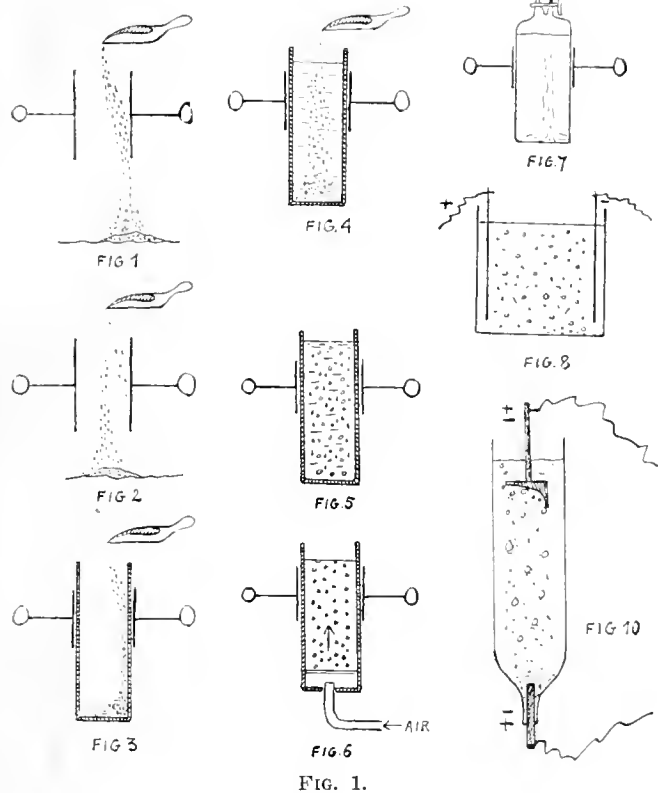

FIG. 1.

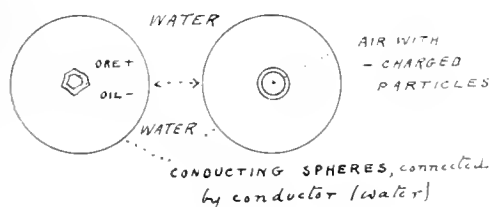

FIG. 2.

neutral with regard to any other charge or system without the outer sphere.

Under conditions electro-statically ideal these forces may be pictured as in Fig. 2. Both bodies are charged and insulated, and suspended in an intervening conducting medium. The systems ore-oil-water, and gas-oil-water, are without effect upon each other.

In case the gas is generated from the ore the particle could not be insulated unless by some phenomenon not understood at present. If the gas is air passed mechanically into the pulp it would be forced into contact with ore particles, in which case the charge carried by each would have its effect upon the other. That a mass of air containing charged vapor or gases could be insulated

the electric theory I undertook a series of experiments that should serve to check the various points in the above theoretical discussion.

No. 1. Galena ore was ground in an agate mortar and poured from an agate spoon (to prevent discharge of positive electricity, if present, from ore) between two plates of an electro-static machine. The material was deflected as shown. Plates were electrified almost to discharge point. This shows that galena ground under insulating conditions carries a charge and that a particle of this nature, suspended in a non-conductor in an electro-static field, is attracted.

No. 2. Ore was ground in conducting earthed mortar and poured from earthed spoon. Deflection of only a very few particles was shown. Perhaps the deflected particles were insulated with oil or did not come in contact with earthed surface.

No. 3. Ore treated as in No. 1 and poured between glass sides of a cell. Glass was 1 mm. thick and separated by 2 cm. Potential between plates of machine was 5500 volts. Deflection as shown. This interposition of glass had very little effect.

No. 4. As in No. 3, but the cell was full of water. Used conductivity, tap, and acid water. No deflection. This indicates that particles, charged or otherwise, suspended in a conducting solution (*i. e.* inclosed within our hypothetical conducting sphere) is not affected by electro-static forces without.

No. 5. Cell contained ore and nitric acid solution to generate gas. Neither bubble rising or ore particles dropping showed deflection. Potential 10,000 volts. The conditions here duplicate those of No. 4.

No. 6. Bubbles blown through canvas into water or acid solution were not deflected. Charged bubbles flowing in one direction would produce an electric current, and even if they were charged they could not be attracted, as here again the charges are enclosed in a conducting material.

No. 7. Ore poured into cell containing gasoline. There seemed to be a slight deflection. 10,000 volts between plates. Conditions here should not differ greatly from those of No. 3. Solution may not have been sufficiently non-conducting.

No. 8. Solution placed in electrolytic cell, arranged as shown, gave no deflection of ore or bubble with conducting or non-conducting solution. Both ions and charged colloids are susceptible to this treatment and no doubt they would move easier than the larger body and so lessen the potential on the larger masses.

No. 9. The water itself was electrolyzed to furnish gas. A two-way switch gave either hydrogen or oxygen at the bottom pole, which was covered with a layer of ore. Both gases carried apparently equal amounts of ore and with equal readiness. Bubbles in either case, upon striking the upper plate, did not discharge their burden of ore, no matter what the sign of electrode.

No. 10. Set up as in No. 9, except that gas furnished by action of nitric acid on ore. Changing of sign produced no discernible effect upon bubble or ore or upon

bubbles with load when coming in contact with upper electrode plate.⁷

I wish to point out the fact that this discussion and these results are to be considered only in connection with the bond between a bubble and ore particles. The conditions chosen have been ideal, in order to isolate this particular phase of the problem. Particles of appreciable mass (+ 200-mesh) have been used, but this permits of an electro-static consideration without interference from exaggerated surface conditions due to smaller bodies. It is possible that an ionized solution does not behave like a solid metallic conductor toward an electro-static charge, but I know of no evidence to the contrary. Very little is known regarding contacts between solid-liquid-gas phases, but it is doubtful whether charges such as accompany phases of a colloidal solution are of much influence in the case of bodies of the size herein considered. It may be found that the oil-water emulsion or the oil-films introduce the colloidal element, and no doubt many of the slimes contain colloids, in which the electric charges are of great importance. It is known that masses of sulphides, such as galena, are positive, but these same sulphides in colloidal form are negative. Metals in mass and as atoms are positive but these also as colloids are negative. This complicates considerably the electrical theory in the case of pulp containing both sand and slime. It may be interesting to call attention to the enormous increase of surface produced by subdivision, in which case phenomena that are purely superficial are greatly enhanced.

| Assume edge of cube to be | Number of cubes | Surface |
|---|------------------|--------------|
| 1 cm. | 1 | 6 cm. |
| 0.1 cm. | 10 ³ | 60 " |
| 0.01 cm. | 10 ⁶ | 600 " |
| 0.001 cm. | 10 ⁹ | 6000 " |
| 0.0001 cm. (mieron (u)) | 10 ¹² | 6 sq. metres |
| 0.0005 cm. (size of particles in kaolin suspension) | | |
| 0.00001 = 0.1 mieron | 10 ¹³ | 60 " " |
| 0.01 mieron (limit of ultra-microscopy) | 10 ¹⁴ | 600 " " |
| 0.001 mieron = one millimicro (mu) | 10 ²¹ | 6,000 " " |
| 0.1 mu. = hydrogen molecule | 10 ²⁴ | 60,000 " " |

When it is considered that these small particles contain the energy necessary to subdivide them, whether electrical or otherwise, it is apparent that phenomena encountered throughout a range in size of particle body will not bear a direct ratio to its mass or constituent material. A consideration of this phase of the subject is, however, without the scope of this paper, which is only given to point out a few of what would appear to be misapplications of the laws of electro-statics.

FLOTATION-FEED. The crushed ore, pulp, or other mill-product that goes for treatment to the flotation plant.

⁷The writer is greatly indebted to the departments of Metallurgical Engineering and of Physics in the Case School of Applied Science for laboratory facilities and apparatus placed at his disposal in carrying out these experiments.

Pumps for Mines

PUMPING practice in mining, as discussed by Charles Legrand of Douglas, Arizona, consulting engineer for Phelps, Dodge & Co., at the San Francisco meeting of the American Institute of Mining Engineers, is characterized by the following points:

Steam seems more satisfactory than electricity where the quantity of water to be pumped is relatively great, or where the mine does not use electric power for any other purpose. As a rule, the cost of installation is greater with electric pumps than with steam-pumps, and the latter have an advantage where flow is variable, as speed and delivery are easily adjusted to varying conditions. Electric pumps, on the other hand, require less attention than steam-pumps and reduce the quantity of heat liberated—a considerable advantage in hot mines. As electrical measurements are easier to make than steam, an electric pump is likely to be kept at a higher efficiency. The latter can be operated at a lower lift than normal without appreciable loss in efficiency.

The following tables give the results of tests under running conditions on various steam and electric pumps;

cylinder pumps with two low-pressure cylinders, steam was superheated 35° when leaving the boiler, and the pumps were tested together.

Referring to the tests of electric pumps, No. 12, 13, and 14 were on pumps immediately after starting, while test No. 15 was on the same pump as No. 14 after a two-weeks run. Test No. 16 is on a single-reduction, spur-gear pump; and No. 17 is on a single-reduction herring-bone-gear pump.

The triple-expansion direct-acting pump is fairly economical in use of steam, provided the proportion of the steam-end to the water-end is correct for the head pumped against. It is not unusual for the steam-end to be too large, considerably increasing the consumption of steam, because of the habit of mine-managers to specify a higher lift than the actual distance. If a pump is ordered with a view to a change of lift to a lower level, as the mine is deepened, it is best to order the pump for the original lift but to specify the water-end strong enough to stand the maximum pressure expected in the future. When the lift is increased, the size of a plunger

STEAM PUMPS

| Test No. | Kind of pump. | Steam cylinders, Inches. | Water plunger, Inches. | Stroke, Inches. | Speed, Rev. per min. | Gal. per min. in test. | Lift, including friction. | Steam, per hp.-hr. | Boiler pressure, in lb. |
|----------|--|--------------------------|------------------------|-----------------|----------------------|------------------------|---------------------------|--------------------|-------------------------|
| 1. | Single duplex | 9 | 8½ | 10 | 33.0 | 270 | 120 | 98.0 | 135 |
| 2. | " " | 14 | 8½ | 10 | 33.0 | 285 | 111 | 135.0 | 135 |
| 3. | No. 1 exhausting in No. 2 as a compound pump | | ... | .. | ... | 350 | 120 | 78.0 | 135 |
| 4. | Triple expansion duplex..... | 10-15½-26 | 8 | 24 | 14.1 | 278 | 591 | 61.5 | 122 |
| 5. | " " " | 15-23-39 | 10 | 24 | 12.7 | 391 | 926 | 49.4 | 125 |
| 6. | " " " | 15-23-39 | 10 | 24 | 21.7 | 658 | 629 | 42.1 | 131 |
| 7. | " " " | 18-28-47 | 12 | 24 | 13.0 | 584 | 1056 | 35.9 | 143 |
| 8. | " " " | 18-28-47 | 12 | 24 | 25.7 | 1207 | 1056 | 27.8 | 142 |
| 9. | Cross-compound, fly-wheel..... | 19-35 | 5½ | 36 | 32.4 | 502 | 1059 | 23.7 | 110 |
| 10. | Triple expansion, fly-wheel..... | 14-26-26-26 | 7½ | 36 | 38.0 | 878 | 652 | 18.0 | 137 |
| 11. | " " " | 14-26-26-26 | 6¾ | 36 | 32.0 | 553 | 883 | 18.0 | 137 |

ELECTRIC PUMPS

| Test No. | Kind of pump. | Motor, Hp. | Water plunger, Inches. | Stroke, Inches. | Speed, Rev. per min. | Gal. per min. in test. | Lift, including friction. | Steam, based on 25 lb. per kw.-hr. |
|----------|--|------------|------------------------|-----------------|----------------------|------------------------|---------------------------|------------------------------------|
| 12. | Vertical triplex, double-reduction..... | 10 | 4 | 9 | 35 | 51 | 475 | 32.7 |
| 13. | " " " " | 20 | 4 | 9 | 37 | 54 | 1162 | 28.1 |
| 14. | " " " " | 50 | 9 | 10 | 37 | 302 | 423 | 29.1 |
| 15. | " " " " | 50 | 9 | 10 | 37 | 303 | 423 | 25.6 |
| 16. | Vertical quintuplex, single-reduction..... | 110 | 4½ | 12 | 40 | 159 | 1155 | 23.1 |
| 17. | Horizontal " " " | 250 | 9 | 18 | 52 | 1245 | 605 | 22.2 |

with the steam-pumps the water fed to the boilers was assumed as used by the pumps, the auxiliaries of the boiler-plant being run from another source of supply.

Referring to these tables, tests No. 1, 2, and 3 were taken by condensing the exhaust of the pump, weighing the condensate, and estimating the volumetric efficiency of the water-end at 90%, as the delivered water was not measured. In tests 10 and 11 on triple-expansion four-

can be altered at small cost to keep the correct proportions between steam and water-end.

Compound and triple-expansion fly-wheel pumps are notably economical in steam but are expensive in installation, requiring much room and good foundations. The use of them is justified when a good deal of power is required, steam is expensive, and the mine assured of long life.

The following suggestions as to the details of pumping practice and operation are given: For gritty water, outside packed plunger pumps are recommended, if the water is only slightly acid, chilled cast iron plungers quickly pay for their extra cost in diminished packing, with chilled plungers it is possible to use metallic packing if the water is not too gritty nor the lift too high. For vertical pumps, metallic packing is suitable for lifts up to 400 ft. For water slightly acid, cement lined pump bodies have given satisfaction. For acid water, plungers and pump bodies should be of acid resisting bronze. For gritty water, it is advisable to have large sumps where water can settle, and if possible, to have two of them, so that they can be cleaned alternately. In the Old Dominion mine at Globe, mud is cleaned from a sump by employing a small air-ejector discharging into a mine-car. For high lifts with gritty water, a satisfactory pump-valve is hard to find; to reduce the balanced pressure on the valve, narrow seats are recommended, however, high pressure on the seats when the valve is closed. On large valves for lifts of 600 to 1000 ft., leather, hard rubber, vulcanized fibre, and soft brass are used; for clear water, soft brass is preferred.

Steam-pumps are run condensing both for economy in steam and because exhaust steam should not be discharged in the mine. The choice of a surface or jet condenser depends on local conditions; the former has less moving parts and consumes less steam, but it is likely to be out of service a longer time when the tubes are cleaned.

The question of proper size of steam-line between the boilers and pumps should be given attention. Most steam-lines are too large. It is best to have a pipe that gives a drop in pressure of 5 to 10 lb. between boilers and pumps, as the reduced condensation pays for loss of pressure. With a small pipe-line, the separator at the pump should be made a separator-receiver, to steady the flow through the line.

As to electric pumps the following facts are noted: With electric plunger-pumps, the herring-bone gear permits a single reduction in gearing the motor to the pump; herring-bone is more efficient than spur gear, but requires closer adjustment of the pitch-line, so that bearings have to be made adjustable to maintain a proper distance between pinion and gear shafts. Incidentally the proper design of bearing is important.

With electric plunger-pumps the amount of water delivered can only be altered by one of three methods: varying the speed of the motor; starting and stopping the pump as required by the flow of water; or passing a portion of the water to the pump suction. The first method is easy where direct current is available, but more complicated and less efficient where A.C. motors are used. The second method can be employed with both varieties of power, but it is hard on the power-plant if the pumping load is a large proportion of the total. The third method is inefficient in the use of power, as the pump is working at full load at all times.

Centrifugal pumps have the advantage of simplicity

and ease of connection to motor with no gearing. On the other hand, they are less efficient than plunger-pumps, and have to be designed for exactly known conditions, being sensitive to change of motor speed or head. In a high lift centrifugal pump of moderate capacity the passages are small, the water travels at high speed and if gritty the wear upsets the proportions of the pump, and affects the efficiency. As the efficiency of electric pumps is not much affected by their size, where the flow of water is variable it is advisable to have several units, each of small capacity, so that the number of units running can be adjusted to the quantity of water pumped.

As to air-lifts, these are inexpensive to install and will handle large quantities of water in a small space, where proper submergence can be obtained. The method could not be used from the lowest level of a mine without a lot of complications, as there is no way to get the proper submergence. Although air-lifts require a good deal of air, the other running costs are almost nothing. Air-lifts were used at the Old Dominion mines at Globe during a recent emergency. Two 10-inch air-lifts, raising the water 200 ft. and 431 ft. respectively (excluding friction) taking air at 90 to 95 lb. (at the power-plant) required the following amounts of air (measured by flow-metre) at a barometric pressure of 27 in. of mercury, the submergence in each case being 190 feet.

| Gal. per min. | Cu. ft. free air per min. | Cu. ft. free air per 1000 gal. | Steam consumption. |
|---------------|---------------------------|--------------------------------|--------------------|
| 1680 | 1809 | 1980 | 48.7 |
| 1791 | 2262 | 1261 | 57.5 |
| 1122 | 3051 | 2718 | 57.0 |
| 1233 | 3395 | 2753 | 57.6 |

The steam consumption per water hp.-hr. is based on air-compressors requiring 38 lb. of steam per 1000 cu. ft. of free air, delivered compressed at 9 lb. gauge-pressure.

Qualitative Test for Molybdenum

In view of the rapidly increasing demand for molybdenum ores, the Colorado School of Mines at Golden is continually receiving requests from prospectors and miners for a reliable test for molybdenum. In response to such requests the following test is suggested:

Pick out carefully the supposed molybdenum mineral, grind fine, and take a quantity equal to a pea in size and put it in a glass test-tube with a speck of paper $\frac{1}{2}$ of an inch square. Add three drops of water and five drops of concentrated sulphuric acid, and boil slowly. If molybdenum is present the solution will change to a dirty green color when almost dry, and on cooling will turn a beautiful ultramarine blue. This color changes immediately on the addition of a few drops of water to a dirty gray. Care must be taken to take the pure molybdenum mineral, to boil the exact quantities specified, and to boil slowly. Tests in the laboratories of the School of Mines prove that this method gives splendid results with all molybdenum minerals.

CONCENTRATES

Readers of the MINING and Scientific PRESS are invited to ask questions and give information dealing with technical and other matters pertaining to the practice of mining, milling, and smelting.

BARITE (barium sulphate) is often used as a filler in rubber goods.

PUMP VALVE-SEATS badly worn can be improved by clamping a disc of sole-leather to the rubber valve.

LARGE BLASTS of rock should be done by electricity, this being safer and surer than fuses. Direct current is preferable to alternating.

GASOLINE ENGINES may be used underground for hoisting and other purposes, if the exhaust is piped to surface. If the fumes escaped into the mine, danger would result.

REVERSE BENDING, that is, where it is first bent around a sheave in one direction, and then at some other point it is passed around another sheave in the opposite direction, is one of the severest conditions that wire rope has to meet.

TRAMMING of ore underground in the proportion of 194 ft. by hand to 708 ft. by mule in one part of the Copper Queen mine cost 20.7c. per ton in 1914. All new light track was charged to this account; amounting to 47,800 ft. of drift.

TEMPERATURE of the oxy-acetylene welding or cutting flame is 3500° C. This is 1250° higher than the old oxy-hydrogen jet. The proportion of acetylene to oxygen for welding is from 1 of the former to 1.14-1.5 of the latter. The correct mixture is of great importance.

THE ZINC-VIOLET or *viola calaminaria* is a flower peculiar to the zinc mining region of Westphalia. Its yellow blossom grows on zinc-bearing soil and it is said to revert to the ordinary tricolor violet if cultivated in a garden. According to R. W. Raymond, this flower has been recognized at the Horn Silver mine in Utah.

HOISTING OF ORE at the Sacramento shaft of the Copper Queen mine in 1914, when 659,102 tons was raised, cost a total of \$46,126 or 7.1c. per ton. Of this cost, \$12,632 was for steam; \$8712 was for engineers and oilers; \$8703 was for hoist repairs; \$4086 was for cage and ore-pocket repairs; and \$3252 was for ropes.

LENZITE is the name given to a complex of minerals that has the curious property of detecting the aerial vibrations made by the wireless telegraph. It was found in the Waldron mine, in the Cedar Valley district, 56 miles south-west of Kingman, Arizona. The crystals are sold for \$10 apiece. The name comes from Charles S. Lenz, the discoverer.

IN VENTILATED MINES there is seldom enough variation in the oxygen and carbon dioxide contents of the differ-

ent atmospheres to affect sensibly the inflammability of methane-air mixtures, according to the U. S. Bureau of Mines. In mines that are not ventilated, and in sealed areas, different conditions prevail.

RIVETS have conical, button-shaped, conoidal, or countersunk heads; the other end or point, may be either button-shaped or pan-shaped. A rivet should as nearly as possible fill its hole, so that undue stress will not be brought on its neighbor by reason of slip or play of the rivet in the hole. When driven, a rivet should be upset throughout its entire length in order that it will fill its hole. If driven hot, a rivet shrinks in cooling; however, this draws the riveted parts more firmly together. Holes are usually $\frac{1}{16}$ inch larger than the rivet and are either punched or drilled.

CONVEYOR-BELT COSTS for the transportation of ore from the shaft into railroad cars at the Copper Queen mine in 1914 were as follows:

| Length of belt, feet. | Quantity carried, tons. | Cost per ton, cents. |
|-----------------------|-------------------------|----------------------|
| 415 | 1,166,734 | 0.122 |
| 700 | 1,070,363 | 0.242 |
| 680 | 984,130 | 0.288 |
| 60 | 353,621 | 0.087 |

The total cost per ton of transporting the ore from the shaft into railroad cars by belt-conveyors was 2.74 cents.

FREEZING of compressed-air pipes in winter, says Frank Richards in *Practical Engineer*, is caused not by the freezing of the air, but by part of the water in the air. The capacity of air to hold water decreases with falling temperature, as in passing through a long pipe in cold weather. This moisture collects and flows along the bottom of the pipe. Freezing of the water takes place in freezing weather, accumulating ice until the pipe is completely choked. The remedies include; burying the pipe in the ground; covering it with protective material such as manure; providing means for drawing-off the water at low points by draining; employing an after-cooler near the compressor with a good steam-separator to take care of the water, the use of which should leave little or no water in the line.

ELECTRIC PLUNGER-PUMPS have a general greater efficiency than centrifugal pumps. The following table of three pumps of each type in the mines of the Cleveland-Cliffs Iron Co., Michigan, shows the relative efficiencies:

| | Head in ft. | Gal. per min. | Percentage of over-all efficiency. |
|---|-------------|---------------|------------------------------------|
| Six-stage centrifugal pump . | 933 | 988 | 54 |
| Four-stage centrifugal pump . | 409 | 288 | 51 |
| Five-stage centrifugal pump . | 498 | 1153 | 57 |
| Duplex double-acting geared plunger-pump | 833 | 992 | 85 |
| Triplex single-acting geared plunger-pump | 409 | 304 | 82 |
| Duplex double-acting geared plunger-pump | 509 | 1406 | 82 |

REVIEW OF MINING

As seen at the world's great mining centres by our own correspondents.

LONDON

RAND PROBLEMS—LABOR AND ORE SUPPLY—CORNISH MINES, MARKETS, AND TAXES—ORE PROCESSING AND GLASS-TOPS ON CONCENTRATORS

RAND LABOR PROBLEMS. The abundance of native labor resulting from the closing of African diamond mines made possible an increase in the Rand gold output in 1915, despite the number of white men who have gone to war. As the diamond mines have resumed washing, and presumably will begin underground work again in a few months, if the present demand for diamonds in the United States continues, there is likely to be, before the year is out, a shortage of native, as well as of white, labor on the Rand. It is not generally appreciated that, despite the millions of blacks, labor shortage is an almost chronic condition in Africa, not only on the Rand,

it seems inevitable that industry will develop in Africa faster than black men are trained for it. Another matter that is becoming more and more serious is the decrease in white labor on the Rand. In spite of the high wages and easy conditions new men are not coming in to take the place of those who constantly leave the mines to open small ranches or engage in other business, or, it must be sadly admitted, who fall victims to phthisis. Slowly the day is coming when the white workman on the Rand will lose his job, and the few left will be promoted to positions as bosses. These various problems related to labor therefore forbid expectation of any considerable increase in output from the Rand or even, perhaps, a continuation of the present rate of production.

ORE-SUPPLY. There is also the problem of future ore-supply; as to that South Africans are looking with increased confidence to the East Rand. More complete knowledge of the geology of that great basin is brushing aside apparent complexities, and more recent development is showing a surprising amount of ore of grades better than had been anticipated. While not enough ore has been mined or developed to be considered an adequate sample of a basin about 25 miles in cross-section, it is worth noting that the Brakpan, Springs, Modder Deep, and Geduld show an increase in reserves, and that this increase is not due to diluting with lower grade. The Brakpan now reports 3,017,000 tons of 7.86 dwt., and the Springs has 1,125,000 of 10.4 dwt. ore. Modder and Geduld continue to be profitable, and East Rand mining is certainly coming into its own. The Daggafontein has finally been financed by the Consolidated Mines Selection, joining Henderson's Transvaal Estates, and work is to be hurried. It is significant that Consolidated Mines Selection undertakes to supply £300,000 within two years, despite the fact that flotation of public companies is forbidden at present. This is typical of recent mine financing in London.

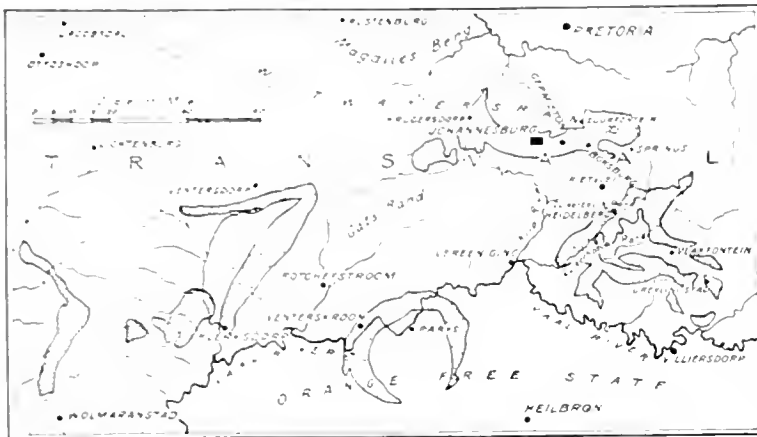

THE GOLDFIELDS OF THE TRANSCAAL.

but in the Congo. At the Katanga mines the Union Minière uses a number of small Bucyrus steam-shovels in places where natives might be expected to be employed, and does so not only because it is economical, but because there is an actual shortage of laborers. This same deficiency is one factor, along with absence of transportation and the limited supply of water, in holding back development of the tin deposits of the Congo. It is true that there are millions of blacks, but few of them are laborers. In South Africa proper, many thousands of Kaffirs have been trained to work and, so to speak, have got the habit, even if it be not firmly fixed. The tropical boys, however, upon whom the industries of the Congo must rely altogether, and on whom the Rand must depend for any great expansion, have not become accustomed to work in a white man's sense, and, in the main, see no reason why they should. Their wants are simple and soon satisfied, and while men work hard and long for a piece of cloth, a tin trunk, or some other piece of property, possession of which sets them above their fellows, they have no wants that lead them to continuous labor. Perhaps some genius will meet the situation by establishing in the affections of the dusky belles of the region an African edition of the *Ladies Home Journal*, much as the Tennessee Copper Co. got steady work from its men by opening a millinery shop. Short of some such round-about campaign,

establish new concerns, and for the present the public is not invited to participate. The Consolidated Mines Selection also takes options amounting to 365,874 shares at prices slightly above par, to be exercised at intervals in the next few years. It is from the disposal of such optioned shares at a premium that the London financial houses make an important part of their profits. Additional East Rand properties wait to be financed, though the ore that is available except under Government lease is becoming limited. Cloverfield, a Neuman property, and Welgedacht of the Ochs holdings, are said to be undergoing examination with a view to exploration.

CORNWALL. War conditions have brought a measure of prosperity, as well as many troubles, to Cornwall. The search for tungsten ore has led to an increase of production, and to re-opening of several mines, though export restrictions and high freights have paralyzed the china-clay industry. The tin output has not greatly increased, as under existing conditions of labor shortage, high smelting-rates, and increasing profit-tax, there is not much inducement to extra effort. The East Pool & Agar, the mine managed by Bewick, Moreing & Co., has recently opened an orebody apparently of some size, and far richer than anything that has been worked in recent years. This emphasizes the desirability of pushing development into those veins that have never been worked at great depth, and

has greatly encouraged the whole mining fraternity of Cornwall. Unfortunately it is debatable whether it would be wise for the company to mine the ore now that it has been found. The excess profit, the mine having been in lean ground for years, would be large, and in one form or another the tax will amount to about 60% of the excess. Smelting rates also are high. The closing of the German market for Bolivian ore has led to a great accumulation of stocks at Liverpool, with a result that has been reflected in prices at the Redruth ticketings. The returning charge on tin ore is an old grievance, but it is one that shows no sign of amelioration locally.

The investigation of ore-dressing methods to be conducted under the auspices of the Institution of Mining and Metallurgy has not yet been actually begun, though a Government grant has been made, and much careful preliminary work has been done. Locally keen interest has been aroused by the efforts to substitute glass for the ordinary wooden and rubber surfaces on concentrating tables under the Morley Martin patents. The advantage is that glass, being structureless, lends itself to prepared uniform surfaces either by rolling the plates while hot or by use of the sand-blast later. The results of tests so far are contradictory, though it seems to be true that a higher-grade concentrate can be made on the glass-topped tables. How far it will be possible to control conditions so as to do this in practice remains to be seen.

JOPLIN, MISSOURI

ZINC AND LEAD PRODUCTION.—DRAINAGE OF PEACOCK MINES IS STARTED.—CINOMO MINE SOLD FOR \$125,000.—NOTES.

The largest production of both zinc and lead ores in the history of the Missouri-Kansas-Oklahoma district is now being recorded, the output of blende being 8000, calamine, 1000, and lead 1200 tons per week. Normally the district produced 5000 tons of blende, and much less lead and calamine than at present. Foundries and machinery houses are pressed to their capacities to meet the demands for new concentrating plants. The pay-rolls are greater than ever before, wages being at their highest, an average of \$4.50 per day. High prices for zinc and lead ores cause the great activity. Blende, at the beginning of March, is selling for \$120 per ton, basis of 60% metallic zinc; calamine for \$85, basis of 40% zinc, and lead ore (galena) for \$90, basis of 80% lead, the highest figure in the history of the district. The Webb City-Carterville district maintains its lead in production of both zinc and lead ores. The opening of many new mines in that field has increased the production to more than 2000 tons of blende weekly. Practically every part of the district has shown a remarkable increase in production, and many that were inactive a year ago are now producing.

The biggest drainage project launched in the district this year is that undertaken by the United Zinc Cos. of Boston, owning several hundred acres of land in what is known as the Peacock camp, 7 miles north-west of Joplin, in the intersection of Spring river and Center creek. About 12 to 15 years ago this area was one of the largest producers in the Missouri-Kansas district, and for a number of years thereafter was important, but during a flood of six years ago, the high dikes that had been constructed around the mines were washed out and the drifts were flooded. One by one the large concentrating plants that had been operated in that field were removed, and the output of concentrates dwindled to nothing. Even the shallower work was given up, and the ground became flooded to the surface. The United Zinc Cos. will install three Texas pumps with a capacity of 1600 gal. per minute each. They will be driven by electricity, power being procured from the Empire District Electric Co., one of whose sub-stations is situated on the land. These pumps are to be installed in the old shafts of the S. H. & S. Mining Co., formerly operated by O. W. Sparks. Two will be placed in the mill shaft, and one in the north shaft, and the ground will be drained to a depth of 167 ft.

The ore occurs in both soft and disseminated formation, the faces in places reaching almost up to surface. Applications for leases from large operators have been made to the United Zinc Cos., and there is every assurance that two or more large concentrating plants will be constructed in the near future. Extensive drilling on this ground, done within the past few months, shows good orebodies ahead of all the old workings. Simultaneous with the drainage operations the company will construct a large rock and earth dike, 1000 ft. long, extending along the east side of the land and shutting off the natural flow of water that sweeps down from Spring river, on the north, in times of flood. This dike will be 40 ft. at the base, 12 ft. high, and 10 ft. wide at the top.

Mining deals are materializing so rapidly these days, that it is hard to keep tab on all of them; hardly a week passes in which a \$100,000 deal is not recorded. Smaller transactions are of almost daily occurrence. The last big deal at the time this correspondence is written is that of the Cinomo Lead & Zinc Co., to the Brennan Lead & Zinc Co., for a consideration of \$125,000. Harry Lindermann was the owner of the mine which is situated on a lease of the Connor land, south of Webb City, Mo. The first prospecting on the land was done last summer. Several good drill-strikes were made, the ore being in soft ground, peculiar to that immediate district, at a depth of about 200 ft. A shaft was sunk, several drifts driven, and a good formation blocked out. At present ore prices it does not require a large tonnage of ore before \$100,000 worth is sold; hence when the Cinomo company constructed a large concentrating plant there were numerous prospective buyers. The new company took charge on March 1.—On the Connor land, not far east from the Cinomo, but in a sheet-ground district instead of soft, the McDonald Mining Co., a producer of many years, sold for \$175,000 cash, to Shackleford and associates.

G. Moore, W. B. Bash and others have acquired a lease of 16 acres of the Beacon Hill tract of the J. M. Leonard land at Chitwood, north-west of Joplin, and contemplate the construction of a 200-ton mill. First lease on this land is held by G. T. Fletcher. The new company has gone into old ground at a depth of 170 ft., and extended drifts ahead of the old workings toward some good drill-strikes that were made recently. The ore occurs in high disseminated faces. On another 16-acre lease of the same land, Hicks & Co. have sunk a new shaft to 140 ft., and are opening a good shoot of zinc.

WASHINGTON, D. C.

NOTES ON THE FOSTER MINING BILL.

The bill to revise, amend, and codify the revised statutes of the United States relating to the location of mining claims on the public domain, has been introduced in the House by Representative Foster of Illinois, chairman of the House mines and mining committee, and has been referred to that committee for appropriate action. The bill is called H. R. 12,275, and as has been forecasted in this correspondence, is wholly temporary. It is but the basis for the codification of the mining laws of the country, as has been urged in many quarters, but by a special commission, instead of by a committee of the House, as this bill proposes. The Foster bill as now written is the present mining code with changes, all comprised in 65 pages, and in all making approximately 16,000 words. It is the plan of Mr. Foster to start work at once on the real revision and codification, and for that he has appointed a sub-committee composed of himself as chairman, and Representatives Taylor of Colorado, Hamlin of Missouri, James of Michigan, and Delegate Wickersham of Alaska. Inasmuch as Mr. Wickersham has been chiefly instrumental in persuading the mines and mining committee to set aside the bills favoring a codification of the mining laws by a special commission, and as he is opposed to any extensive change in the mining laws, the character of the eventual bill to be passed by the House may be inferred.

THE MINING SUMMARY

The news of the week as told by our special correspondents and compiled from the local press.

ALASKA

JUNEAU

Bids were received late in February for sinking the Mexican, or Combination shaft, from 1750 to 2800 ft. The opening is 8 by 31½ ft., with five compartments. A steel head frame will replace the old structure. The Central shaft is being sunk, its present depth is at 2500 feet.

January gold yields of the mines on Douglas island were as follows:

| | Alaska Mexican. | Alaska Treadwell. | Alaska United. |
|---|--------------------|----------------------|-------------------|
| Development, feet | 140 | 448 | 1,269 |
| Stamps dropping | 120 | 510 | 300 |
| Ore crushed, tons | 19,775 | 78,677 | 15,395 |
| Gold from amalgamation and cyanidation | \$26,886 | \$126,510 | \$92,593 |
| Operating expenses | 26,533 | 103,853 | 74,208 |
| Construction | 1,156 | 3,367 | 8,052 |
| Profit | | \$21,392 | \$9,407 |
| Loss | \$1,971 | | |

The results of operation in 1915 were as follows:

| | Tons. | Output. | Profit. | Dividends. |
|-----------------|---------|------------|-----------|------------|
| Mexican | 216,428 | \$ 379,797 | \$ 99,177 | \$ 90,000 |
| Treadwell | 900,211 | 1,828,724 | 859,187 | 650,000 |
| United | 503,419 | 1,942,175 | 367,250 | 252,280 |

ARIZONA

COCHISE COUNTY

(Special Correspondence.)—A syndicate of southern Californians is developing a promising copper property in the

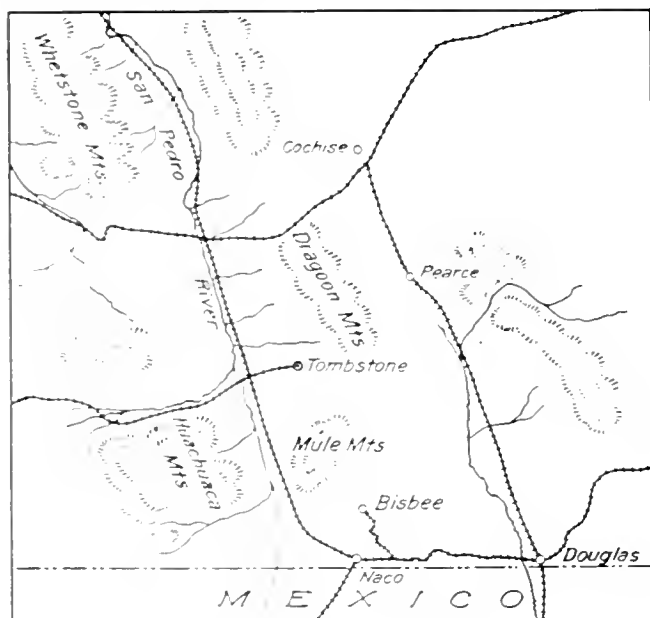

PART OF SOUTH-EASTERN ARIZONA.

Dragoon mountains, 40 miles north of Bisbee. Extensive outcroppings have been opened by shafts and adits. The area was worked in the early 80's by men from Tombstone. Over

\$100,000 has been spent on development and plant. New ore-bodies have been opened on No. 5, 6, and 7 levels, and regular shipments are made. The reduction plant is to be increased to 400 tons per day.

Pearce, February 23.

The Bunker Hill company at Tombstone is shipping 10 carloads of manganese ore per week to steel works in the East.

PIMA COUNTY

It is reported that the American Smelting & Refining Co. has acquired the Imperial Copper Co.'s property at Silverbell 35 miles from Tucson. The mine has been closed since 1910, when the owner went bankrupt. Past records show an output of \$8,000,000 in copper and silver.

In the San Xavier district, 20 miles south-west of Tucson, work has been resumed at three mines. The San Xavier zinc mine is the largest.

YAVAPAI COUNTY

The annual report of the United Verde Extension Mining Co. shows cash on January 10, 1916, amounting to \$219,205, against \$8850 on September 10, 1914. Due on shipments of ore is \$290,000, of which \$136,380 has been received. There is enough ore developed for a daily output up to 200 tons, averaging 10 to 12% copper, 0.025 oz. gold, and 2.21 oz. silver. The rich ore has been extracted above 1200 feet.

CALIFORNIA

CALAVERAS COUNTY

(Special Correspondence.)—At the Summerville mine at Fourth Crossing, formerly known as the Thorp, a vertical two-compartment shaft has been sunk to a depth of 230 ft. At 60 ft. a cross-cut was driven to the vein a distance of 20 ft.; the shaft crossed the vein at 130 ft. At 215 ft., the first working level, a cross-cut is in 70 ft., where the vein is 5 ft. wide of good value, containing considerable sulphurets. The work has all been done with air-drills. The hoist is driven by air from a motor-driven compressor. An electric hoist will soon be installed, with a 150-hp. motor.

Below the 215-ft. level, in the sump, a vein was cut, also being of good value. This will also be prospected by a cross-cut to the west from the 215-ft. level. It is planned at an early date to install an aerial tram to transport ore from this shaft to the 30-stamp mill, which is now on the property, a distance of 1500 ft. from the present shaft. A. H. Summerville is superintendent.

The Pioneer Chief Gold Mining Co. commenced work at the Pioneer Chief mine on May 20, 1915. During this time they have unwatered and cleaned-out the old workings to a depth of 240 ft. The south drift has been extended 45 ft. beyond the old workings, making a total length of 155 ft. The incline shaft has been sunk an additional 110 ft., making a total depth of 350 ft. At this point, drifts have been driven in each direction along the vein. The south drift, which is in 30 ft., shows 9 ft. assaying from \$5 to \$40 per ton, averaging \$15. The drift north at the same level is in 35 ft. with 6 ft. of the same grade. The company is employing 23 men. Air-drills, supplied by an Ingersoll-Rand compressor are used. A 50-hp. electric motor drives the hoist. A 10-stamp mill will be installed ready for operation about August 1. Ore will be transported to the mill from the shaft, by belt-conveyor. Telephone communication from the mine to San Andreas will soon be established.

An assay-office is now being built. J. E. King is superintendent, and George Damon will have charge of the assay-office.

The Tullock Mines Co. is now unwatering the old Tullock mine and doing some prospecting in the old workings, preparatory to locating the proposed new shaft, which will be sunk a depth of 800 to 1000 ft. The work is being done under the supervision of Tom Lane, formerly superintendent of the Utica mine.

Angels Camp, February 25.

Chrome ore has been opened by C. H. McClory of Angels Camp and J. F. Bollinger of Copperopolis, near the latter place. They have bonded the property to a syndicate, and 1000 tons is to be mined.

ELDORADO COUNTY

Some promising developments are reported from the north-western part of this county, around Pilot Hill. The Bean Ridge mine has yielded \$30,000 gold from pockets. The Camelback, owned by J. D. Voss, has \$350,000 of copper-gold ore opened. Shipments will be started soon.

SAN BERNARDINO COUNTY

(Special Correspondence.)—A promising tungsten district is that about $6\frac{1}{2}$ miles north of Goffs in the Signal mining district. It is 3 miles long and from $\frac{1}{2}$ to 2 miles wide, reached by a fair wagon-road. At present there are 30 men employed and the showing is encouraging. The ore is hübnerite almost exclusively, though it is said that there are several deposits of scheelite. Work so far has been mostly trenching for float, but some development has been done in opening a few veins of promise. The ore contains from 7 to 30% tungsten, and the lower-grade ore will be concentrated if development continues as satisfactory as at present.

Goffs, February 3.

SIERRA COUNTY

(Special Correspondence.)—The long cross-cut from the lower adit of the Tightner mine has cut the Osceola vein, showing fair-grade ore. The cross-cut is being extended to intersect the Red Star vein, which yielded rich quartz in the upper workings. Much work is going on in the Red Star, which is owned by the Tightner company. Good ore continues to come from the main Tightner levels and the mill is working at full capacity.

Operations have been resumed at the Gold King, on Kanaka creek, owned and managed by W. H. Weldon. It is proposed to install a small compressor and drills as soon as weather conditions permit. The property has been under development several years, and some good ore is in sight.

A compressor and other machinery will be erected at the Eastern Star as soon as the roads are in shape for transportation of heavy equipment. The mine was recently taken under bond by C. A. Jackson. Good ore has been opened.

Mining is active throughout the Alleghany field, despite deep snow at many points. The Plumbago and Oriental are working with full crews. The Louise Consolidated, Morning Glory, Twenty-One, Irehan, Mariposa, and Sixteen-to-One are busy. Rich discoveries have been recently made in the Irehan, Twenty-One, and others; that in the Irehan was made about 860 ft. in from the portal of the upper adit. A survey of this part of the mine has been made preliminary to extensive development.

Alleghany, February 26.

TUOLUMNE COUNTY

(Special Correspondence.)—Unwatering of the New Albany mine, near Tuolumne, which was begun several weeks ago, has been delayed by caving of the shaft. It is reported that San Francisco men will take over and operate the property, which is owned by a Cleveland, Ohio, company.

It is reported that some good ore has been found in the 300-ft. level of the Rawhide, recently acquired by the Pittsburg-

Silver Peak Co., which formerly operated at Blair, Nevada. Unwatering is still in progress.

Work has been resumed at the Live Oak mine, near Soulsbyville, after an idleness of several weeks.

The Experimental mine, above Columbia, which was forced to suspend operations several weeks ago owing to collapse of a flume on the main water-supply ditch, is again active. The rich ore-shoot that was worked to a shallow depth years ago will be cut by driving the adit, now in 2600 ft., less than 200 ft. farther. Ore is now being stoped from another vein intersected by the cross-cut adit a few months ago. A two months' run on ore from this vein with the old two-stamp mill yielded \$4500. The plant has lately been enlarged to five stamps.

The Springfield Tunnel & Development Co. held its annual meeting on February 12, and re-elected the following officers: president, W. M. Hall; vice-president, C. A. Belli; secretary and general manager, A. L. Horner. Joseph Cademartori will continue as superintendent.

Sonora, February 11.

Rich gravel, up to \$15 per mine-car, has been opened in the H 1 Can mine on the Stanislaus river. The ground is in the Table Mountain channel. It is proposed to re-open the Punch Bowl mine near-by.

COLORADO

BOULDER COUNTY

Last week the Vasco Tungsten Mining & Development Co. of Latrobe, Pennsylvania, shipped 25 tons of tungsten ore, worth \$80,000, or \$3200 per ton, the richest lot ever produced in this county.

GILPIN COUNTY

A big revival of mining is reported from the Lake, Russell, and Willis Gulch areas adjacent to Central City and Black Hawk. Companies and lessees are all busy with development and ore production.

LAKE COUNTY (LEADVILLE)

Since the U. S. R. & E. Co. started work at the Harvard shaft of the Fryer Hill project considerable improvements have taken place, and operations are attracting a great deal of attention.

At the Penrose shaft of the Down Town mines the water is down to 800 ft., leaving 75 ft. to the bottom. The flow of water is strong, but the pumps are lifting it with ease.

A company is to be formed to acquire, drain, and develop several mines in the Carbonate Hill area, near the Iron Silver property. The depth to be unwatered is 1300 feet.

OURAY COUNTY

During January the Camp Bird made a profit of \$37,000 from 2534 tons of ore. During the last quarter of 1915 the mill treated 7897 tons of ore, yielding \$235,451 from bullion and concentrate sold. The profit was \$135,000, plus \$101,000 from the Santa Gertrudis in Mexico. Development amounted to 1383 feet.

Money has been secured for the Mountain Top company's aerial tram and mill, according to the manager, G. H. Barnhart.

TELLER COUNTY (CRIPPLE CREEK)

During February the district produced 77,630 tons of ore worth \$1,121,515. Dividends for the first two months of 1916 totaled \$195,000.

IDAHO

SHOSHONE COUNTY (COEUR D'ALENE)

During the quarter ended December 31, 1915, the Interstate-Callahan company's profit was \$721,749. There was shipped 133 tons of crude lead and 1856 tons of zinc ore. The mill treated 26,323 tons, yielding 879 tons of 55.77% lead and 20.81-oz. silver concentrate, and 12,607 tons of 48.54% zinc concentrate. The total cost was \$6.11 per ton of ore mined.

The new aerial tram saved \$12,000, when compared with team haulage. One dividend of \$1.50 per share, equal to \$697,485, was paid.

MICHIGAN

THE COPPER COUNTRY

To those of its 3,000 employees who work through March and April the Copper Range company will pay a 20% bonus.

Copper production during February is estimated at 22,000,000 lb., 99% of normal. March should be up to the old standard, although a severe blizzard was reported on the 7th.

The Butte company is suing the township of Adams to recover the taxes on the increased valuation of \$2,200,000 put on the mine by the State Tax Commissioners.

MONTANA

FERUS COUNTY

(Special Correspondence.)—The cyanide mill at New Year in the Judith mountains will be re-started this spring, treating ore from the Gold Acres mine. The adit is in 788 ft., and work is now progressing on a drift of 325 ft. It is claimed that a large orebody has been cut by a raise of 110 ft., which will be further developed by another raise at the end of the drift. The ore is low grade, about \$1 per ton, but production should prove profitable if the orebody is as large as expected.

During January bullion amounting to \$75,000 was produced at the new Spotted Horse mill at Maiden, besides a carload of concentrate worth \$200 per ton. With the successful operation of the new mill, the output of this famous old mine is expected to greatly increase in the next few months.

At the West Kendall mine in the north Moccasin mountains an extensive deposit of white and pink gem topaz has been found. The gems occur in a solid mass, and will be cut and sold. According to James H. Conley, of the West Kendall, a 15-ft. vein of galena, high in gold and silver, has been found during recent development. The ore is of shipping grade, and is now being sorted and sacked for shipment.

At a recent meeting of the Hanover Gypsum Co., Dan R. Brown, formerly of Spokane, was elected president. George J. Wiselmann, H. V. Alwood, O. U. Miricle, and B. E. Stack are directors. The superintendent is Frank Schultz, formerly with the gypsum mill near Great Falls. A spur-track is being built by the C. M. & St. P. railroad to the company's property near the south Moccasin mountains. Temporary houses and an office building have been erected, and machinery has been ordered. The plant will cost \$100,000. Cement materials are found nearby, and a cement plant is planned for the near future.

Over a dozen townships in Meagher and Musselshell counties have been withdrawn from entry by executive order from Washington, D. C., as they are suspected of being oil bearing. The withdrawal starts in the neighborhood of Big Elk in Meagher county, and extends east and along Fish Creek basin into Musselshell county near Rothiemay and Ryegate.

Lewistown, February 21.

LEWIS AND CLARK COUNTY

An examination of the Scratch Gravel gold mine near Helen, by four engineers, places the gross value of the ore to 200 ft. depth at \$1,400,000. The vein is in granite. The 300-ft. level will be developed, the shaft sunk to 500 ft., and a mill erected.

SILVERBOW COUNTY

To operate the old Ophir silver-copper-zinc mine, south of the Emma at Butte, the Butte-Detroit Copper & Zinc Mining Co. has been organized in the East. Canadian people are also interested. The shaft is down 1065 ft., and will be deepened another 1000 ft. The mill will be re-modeled. W. L. Creden is in charge.

The Butte & Zenith shaft has been unwatered to 670 ft., and

cross cutting started to the vein. Another 150 hp. motor has been coupled to the hoist, and a new 1000 cu. ft. compressor installed.

At the Butte & Great Falls the shaft is down 500 ft., and crosscutting started for the Genevieve vein, 375 ft. distant.

Considerable activity is reported from the east Butte district. During February the Butte & Superior company produced 16,000,000 lb. of zinc in concentrate from 55,360 tons of ore.

NEVADA

CLARK COUNTY

Searchlight is still producing ore, shipments in 1915 being 707 tons of ore worth \$79,500, and bullion valued at \$79,856. Some good developments are reported recently.

On March 25 the Yellow Pine Mining Co. will pay 10c. per share, equal to \$100,000. The cash reserve is \$153,000, and ore in transit \$150,000. In 1915 the mine yielded 18,403 tons of ore worth \$853,200 in lead, silver, and zinc. Profits were \$699,611, of which \$150,000 was distributed.

ESMERALDA COUNTY

The estimated production of the Goldfield Consolidated company in February is as follows:

| | |
|--------------------|-----------|
| Ore mined, tons | 29,400 |
| Gross extraction | \$221,000 |
| Operating expenses | 161,000 |
| Net realization | \$ 60,000 |

HUMBOLDT COUNTY

The Rochester Mines Co. is to double the capacity of its mill, making 300 tons per day, at a cost of \$75,000.

NYE COUNTY

Returns from Tonopah continue to drop, those for last week totaling \$164,488 from 7846 tons. The Tonopah Mining Co. shipped bullion worth \$56,000.

In January the Extension treated 7721 tons, yielding 178,600 oz. bullion, and \$59,000 profit. The drift at 1540 ft. in the Victor ground is in a full face of rich ore.

A development of note is that at 950 ft. in the Rescue-Eula mine, where a vein of good width and value was cut. The property is south and east of the Belmont.

OREGON

JOSEPHINE COUNTY

The establishing of a mining-experiment station in Oregon, possibly at Grants Pass, is being urged in Congress by Representative Hawley.

The Queen of Bronhee mine at Waldo has been sold to John F. Twoby of the firm of Twoby Brothers, and others. The sum of \$78,000 has been paid as an installment. The mine contains good copper ore, some of which is hauled 45 miles to Grants Pass, and then railed to Kennett and Tacoma smelters. The Twoby railway is to be extended to Waldo.

TEXAS

BREWSTER COUNTY

(Special Correspondence.)—The high price of quicksilver has led to much activity in the Terlingua cinnabar district.—The Big Bend Mining Co. is preparing to resume on a large scale, also the Marfa-Mariposa Mining Co. By installing pumps the working levels can be unwatered.—The Chisos Mining Co., which for several years has operated the principal quicksilver property in the district, has increased its output considerably recently. Workings on and below the 400-ft. level are yielding plenty of rich ore.—Many new cinnabar claims have been located in the area during the last few months, and some of these undeveloped properties will be placed on a producing basis within the next few weeks, judging by the plans made for erection of furnaces and other equip-

ment.—Engineers state that there is evidence that the quicksilver deposits extend over a large part of the border section around Terlingua, and that it is found in outcrop across the Rio Grande in Mexico.—It is reported that an

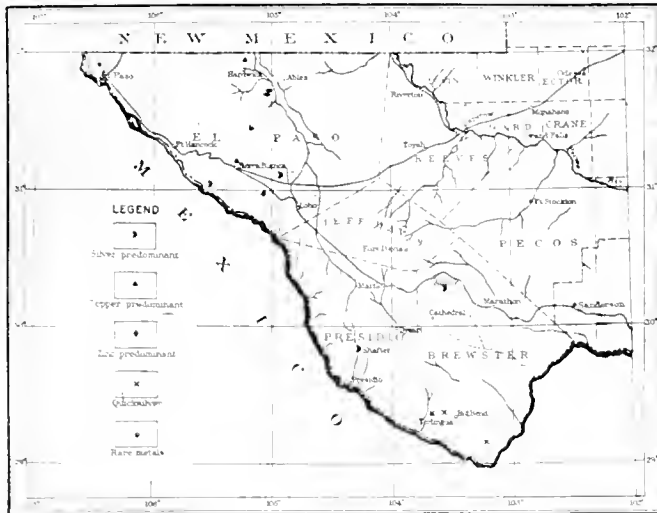

PART OF TEXAS, SHOWING QUICKSILVER AREAS.

outcrop of unusual richness was recently discovered within 60 miles of Laredo, and only about 10 miles from a railroad. W. H. Gibson of Laredo plans to develop the prospect. Terlingua, February 22.

EL PASO COUNTY

As was done at the Copper Queen smelter at Douglas, Arizona, the El Paso smelter will pay less for Mexican copper ores, to protect itself from fluctuations in the market. El Paso rates are lower than the Copper Queen, the former deducting 2c. per lb. on a 14-c. market, and a reduction of 3/4c. per lb. on each 1c. rise above the 14c.; the Copper Queen deducting 2 1/2c. on 16-c. metal.

UTAH

SUMMIT COUNTY

During February, 11 companies at Park City shipped a total of 6564 tons of ore. There are more mines, mills, and men employed than for many years. There are also a number of prospective producers.

During 1915 the Silver King Consolidated Mining Co. produced 13,719 tons of ore yielding \$37.87 per ton net. The metal output was 652,076 oz. silver, 604 oz. gold, 7,843,139 lb. lead, and 411,086 lb. copper, all good increases. Dividends totaled \$255,033. The surplus is \$232,645.

An electric smelter is to be erected by the Daly-Judge Mining Co. near Park City. The plant will cost over \$300,000 and will reduce zinc ore.

WASHINGTON

PEND OREILLE COUNTY

Shipments from the molybdenite mine, owned and operated by the Molybdenite Mining & Milling Co., near Ione, were begun recently, a car of ore having been forwarded to the Henry E. Wood company, Denver, Colorado, according to Burrell J. Raines, president of the corporation, who states that consignments will be forwarded regularly every week for an indefinite period. The property is developed by several short drifts and adits in which there are five veins, from 8 to 36 in. wide.

STEVENS COUNTY

In the Great Western claim of the Norman mines, near Northport, at a depth of 165 ft. the main orebody is 250 ft. long. A winze below this level is in good zinc carbonate. Ore containing 35% zinc is being shipped to Donora, Pennsylvania. Prospects generally are good.

PERSONAL

W. E. SIMPSON is at Haileybury, Ontario.
 GEORGE E. FARISH is here from New York.
 OLOF WENSTROM, of Boston, has gone to Mexico.
 W. L. FRASER is in the Death Valley district, California.
 CLAUDE V. HAINES has left London for Santa Ana, Colombia.
 EDGAR RICKARD sailed from New York by the *Rotterdam* on March 11.

JOHN BALLOT, chairman of Minerals Separation Ltd., is in New York.

LESTER W. STRAUSS has been visiting the Braden copper mine, in Chile.

MARK B. KERR has returned from the Tajo mines, near Mazatlan, Mexico.

S. A. R. SKERTCHLY, chief engineer to the San Antonio mines, has returned to Peru.

LOUIS WEBB was in San Francisco on his way to take charge of the Lagrange mine, near Weaverville.

A. MELLICK TWEEDY is now connected with the South American Development Co., at Zaruma, in Ecuador.

G. M. COLVOCORESSES, manager for the Consolidated Arizona Smelting Co., is here from Humboldt, Arizona.

C. F. KELLEY, managing director of the Anaconda Copper Co., has been to Cananea on a visit of inspection.

DURWOOD COPELAND has finished his investigations of tin smelting in Great Britain, and sailed for New York on Feb. 18.

JOHN B. FARISH has gone to Sutter Creek, being a director of the Amador Consolidated company, which has acquired the old Eureka mine.

CHARLES W. NEWTON, general superintendent for the Consolidated Interstate Callahan Mining Co. at Wallace, Idaho, was recently at Butte.

WILLIAM P. MILLER has been appointed superintendent of the mines and mill of the Jacket Crown-Point Belcher Mining Co. at Gold Hill, Nevada.

E. A. JULIAN has opened an office in the Crocker building as representative of the exploration department of the Goldfield Consolidated Mines Company.

ROBESON T. WHITE, manager for the Caucasus Copper Co., was in San Francisco last week. He expects to sail shortly for Vladivostok on his way to Batoum.

NELSON DICKERMAN has resigned as general manager of the Pato Mines (Colombia), Ltd., and the Nechi Mines (Colombia), Ltd., and will return from Colombia to San Francisco, California, the latter part of April. W. A. PRICHARD has been appointed as his successor.

Schools and Societies

The MICHIGAN COLLEGE OF MINES will celebrate its 30th anniversary on August 8, 9, and 10, by a reunion of hundreds of old graduates and one-time students gathered from all parts of the world to the college at Houghton. The committee in charge consists of: William Kelly, John W. Black, F. W. McNair, Ocha Potter, Enoch Henderson, A. J. Houle, and James Fisher. Branch clubs of M. C. M. men at the various mining centres of the Continent are assisting in the preparations.

The semi-annual meeting of the UTAH SECTION of the A. I. M. E., took place on March 7. By the courtesy of the Utah Copper Co. and the Garfield Smelting Co., arrangements were made for members to visit the plants of these companies. The same evening a dinner for members was held at the Alta club. After the dinner was a discussion of letters and papers that have been received in regard to the part the Institute will take with reference to military preparedness. Following this a paper was read by R. F. Barker, entitled 'Preparation of Powdered Coal for Reverberatory Smelting at Garfield, Utah.'

THE METAL MARKET

METAL PRICES

San Francisco, March 8

| | |
|---|-----------|
| Antimony, cents per pound | 44 |
| Electrolytic copper, cents per pound | 27.75 |
| Molybdenum, 99% MoS ₅ , per pound | \$1.10 |
| Pig lead, cents per pound | 6.95-7.90 |
| Platinum, soft metal, per ounce | \$88 |
| Platinum, hard metal, 99% (bottom), per ounce | \$92 |
| 99% K-silver, per flask of 75 lb. | \$250 |
| Spelter, cents per pound | 22 |
| Tin, cents per pound | 43 |
| Zinc, old stock, cents per pound | 30 |

ORE PRICES

San Francisco, March 8

| | |
|---|-------------|
| Antimony, 50% product, per unit of 17 1/2 or 20 lb. | \$2.25 |
| Chino, 40% and over, 600 cars California, per ton | 11.00 |
| Magnesite, crude, per ton, Feb. | 8.00 |
| Magnesite, plastic, no iron and lime, calcined, ton | 20.00 |
| Magnesite, refractory, 11% iron dead-burned, ton | 35.00 |
| Manganese, 50% metal, 8% silica, per ton | 12.00 |
| Trusted, minimum 60% WO ₃ , per unit of 20 lb. | 60.00-65.00 |

At Boulder, Colorado, \$1.20 per lb. was paid for 79.15% tungsten ore.

EASTERN METAL MARKET

(By wire from New York)

March 9—Copper is quiet and weak, there are few sellers of lead, and independents are getting premiums, zinc is weak with few buyers.

SILVER

Below are given the average New York quotations, in cents per ounce, of fine silver.

| Date | Average week ending | | |
|---------|---------------------|---------|-------|
| March 2 | 56.87 | Jan. 26 | 57.11 |
| " 4 | 56.77 | Feb. 2 | 57.02 |
| " 6 | 56.77 | " 9 | 56.79 |
| " 8 | 56.86 | " 16 | 56.62 |
| " 10 | 56.77 | " 23 | 56.86 |
| " 12 | 56.77 | March 1 | 56.79 |
| " 14 | 56.77 | " 8 | 56.75 |

Monthly averages.

| | 1914 | 1915 | 1916 | | 1914 | 1915 | 1916 |
|-------|-------|-------|-------|-------|-------|-------|------|
| Jan. | 57.58 | 48.87 | 56.74 | July | 54.90 | 47.52 | |
| Feb. | 57.52 | 48.45 | 56.74 | Aug. | 54.35 | 47.11 | |
| March | 58.01 | 50.63 | 56.75 | Sept. | 53.75 | 48.77 | |
| April | 58.52 | 50.25 | 56.75 | Oct. | 53.12 | 49.49 | |
| May | 58.21 | 49.87 | 56.75 | Nov. | 49.12 | 51.88 | |
| June | 58.42 | 49.03 | 56.75 | Dec. | 49.27 | 55.34 | |

Although steady, the market is quiet. English, European, and Indian buying has eased. China bought a little after its New Year. A continuance of strength may be expected, but without much movement in price.

On March 2 the 'Chiyo Maru' took from San Francisco to Bombay silver worth \$71,796; to Shanghai, \$419,667; and to Kobe, \$196,779, a total of 1,076,000 ounces.

In 1917 Ontario, mainly Cobalt, yielded 23,796,839 oz., a decrease of 7,487,557 ounces.

COPPER

Prices of electrolytic in New York, in cents per pound.

| Date | Average week ending | | |
|---------|---------------------|---------|-------|
| March 2 | 26.87 | Jan. 26 | 24.90 |
| " 4 | 26.77 | Feb. 2 | 25.45 |
| " 6 | 26.62 | " 9 | 26.16 |
| " 8 | 26.86 | " 16 | 27.06 |
| " 10 | 26.77 | " 23 | 27.35 |
| " 12 | 26.79 | March 1 | 27.12 |
| " 14 | 26.79 | " 8 | 26.62 |

Monthly averages.

| | 1914 | 1915 | 1916 | | 1914 | 1915 | 1916 |
|-------|-------|-------|-------|-------|-------|-------|------|
| Jan. | 24.21 | 23.69 | 24.39 | July | 23.26 | 24.69 | |
| Feb. | 24.48 | 24.78 | 26.62 | Aug. | 22.34 | 17.27 | |
| March | 24.31 | 24.89 | 26.62 | Sept. | 22.02 | 17.89 | |
| April | 24.14 | 24.84 | 26.62 | Oct. | 21.19 | 17.90 | |
| May | 24.57 | 18.71 | 26.62 | Nov. | 21.55 | 18.88 | |
| June | 24.69 | 19.77 | 26.62 | Dec. | 22.55 | 26.67 | |

The following dividends have been declared: Calumet & Hecla, \$15; Calumet & Arizona, \$2; Chino, \$1.25; Magma, 50c.; Nevada Con., 50c.; Old Dominion, \$2.50; Ray, 50c.; United Verde, 75c.; Utah Copper, \$2.50; and Wolverine, \$5 per share.

January returns were as follows: Chino, 5,316,975; Nevada Con., 6,157,862; Ray, 4,266,499; and Utah Copper, 11,999,910 pounds. Bad weather affected the yields. In February, Anaconda produced 23,200,000 pounds.

According to John D. Ryan the price of copper is as high as producers care to have it go. They desire the market to be on a stable basis, as they are all sold far ahead.

LEAD

Lead is quoted in cents per pound, New York delivery

| Date | Average week ending | | |
|---------|---------------------|---------|------|
| March 2 | 6.52 | Jan. 26 | 6.97 |
| " 4 | 6.57 | Feb. 2 | 6.10 |
| " 6 | 6.57 | " 9 | 6.12 |
| " 8 | 6.57 | " 16 | 6.26 |
| " 10 | 6.57 | " 23 | 6.30 |
| " 12 | 6.57 | March 1 | 6.30 |
| " 14 | 6.57 | " 8 | 6.60 |

Monthly averages.

| | 1914 | 1915 | 1916 | | 1914 | 1915 | 1916 |
|-------|------|------|------|-------|------|------|------|
| Jan. | 4.11 | 3.73 | 5.95 | July | 3.80 | 5.59 | |
| Feb. | 4.02 | 3.83 | 6.23 | Aug. | 3.86 | 4.67 | |
| March | 3.94 | 4.04 | 6.23 | Sept. | 3.82 | 4.62 | |
| April | 3.86 | 4.21 | 6.23 | Oct. | 3.60 | 4.62 | |
| May | 3.90 | 4.21 | 6.23 | Nov. | 3.68 | 5.15 | |
| June | 3.90 | 5.75 | 6.23 | Dec. | 3.80 | 5.34 | |

Lead ore, 80% metal, was quoted at \$89 per ton at Joplin, Missouri, last week.

QUICKSILVER

The primary market for quicksilver is San Francisco, California being the largest producer. The price is fixed in the open market, according to quantity. Prices, in dollars per flask of 75 pounds:

| Date | Week ending | | |
|---------|-------------|---------|-----|
| March 2 | 295 | Feb. 23 | 290 |
| Feb. 9 | 295 | March 1 | 285 |
| " 16 | 300 | " 8 | 250 |

Monthly averages.

| | 1914 | 1915 | 1916 | | 1914 | 1915 | 1916 |
|-------|-------|-------|--------|-------|-------|--------|------|
| Jan. | 39.25 | 51.90 | 222.00 | July | 37.50 | 95.00 | |
| Feb. | 39.00 | 60.00 | 295.00 | Aug. | 39.00 | 93.75 | |
| March | 39.00 | 78.00 | | Sept. | 76.25 | 91.00 | |
| April | 38.90 | 77.50 | | Oct. | 52.00 | 92.90 | |
| May | 39.00 | 75.00 | | Nov. | 55.00 | 101.50 | |
| June | 38.60 | 90.00 | | Dec. | 53.10 | 123.00 | |

The market is quiet, with fair supplies. Evidently holders let go their metal. Some has come from Mexico, also 600 flasks from Italy.

ZINC

Zinc is quoted as spelter, standard Western brands, New York delivery, in cents per pound.

| Date | Average week ending | | |
|---------|---------------------|---------|-------|
| March 2 | 20.75 | Jan. 26 | 19.92 |
| " 4 | 20.25 | Feb. 2 | 18.67 |
| " 6 | 20.00 | " 9 | 19.98 |
| " 8 | 20.00 | " 16 | 19.92 |
| " 10 | 20.00 | " 23 | 21.35 |
| " 12 | 19.25 | March 1 | 20.71 |
| " 14 | 19.25 | " 8 | 19.92 |

Monthly averages.

| | 1914 | 1915 | 1916 | | 1914 | 1915 | 1916 |
|-------|------|-------|-------|-------|------|-------|------|
| Jan. | 5.14 | 6.36 | 18.21 | July | 4.75 | 20.54 | |
| Feb. | 5.22 | 9.65 | 19.99 | Aug. | 4.75 | 14.17 | |
| March | 5.12 | 8.49 | 19.99 | Sept. | 5.16 | 14.14 | |
| April | 4.98 | 9.78 | 19.99 | Oct. | 4.75 | 11.95 | |
| May | 4.91 | 17.03 | 19.99 | Nov. | 5.91 | 17.29 | |
| June | 4.84 | 22.20 | 19.99 | Dec. | 5.49 | 16.75 | |

Prices for zinc ore at Joplin, Missouri, dropped \$5 last week. The output of the region was 6196 tons blende, 264 tons calamine, and 1797 tons lead, averaging \$102, \$82, and \$88 per ton, respectively. The total value was \$896,738.

Butte & Superior has declared its regular quarterly dividend of 75c. per share and an extra of \$10.

TIN

Prices in New York, in cents per pound.

| Date | Monthly averages. | | |
|---------|-------------------|---------|-------|
| March 2 | 37.85 | Jan. 26 | 37.38 |
| " 4 | 39.76 | Feb. 2 | 31.37 |
| " 6 | 38.16 | " 9 | 33.12 |
| " 8 | 48.25 | " 16 | 33.00 |
| " 10 | 36.19 | " 23 | 33.51 |
| " 12 | 33.29 | March 1 | 33.69 |
| " 14 | 39.28 | " 8 | 38.71 |

Tin is strong at 49 cents.

ANTIMONY

The demand is good, both for prompt shipments from the East and for spot, and quotations are strong at 44.50 to 15c. for Chinese and Japanese grades.

Eastern Metal Market

New York, March 3.

To curb speculation in metals required in the production of war materials, and the resulting high prices, Great Britain proclaimed the following drastic order on March 1: "It shall be unlawful for any person to sell or buy or to offer to sell or buy the following: iron, steel, copper, zinc, brass, antimony, nickel, tungsten, molybdenite, ferro-alloys, or any other metal specified by the Ministry of Munitions as necessary for the production of any war material unless the metal is in the possession of the seller, or in course of production for him, and, in the case of the buyer, unless the purchase is made for the actual consumers."

Reference has been made heretofore to the failure which Great Britain experienced in trying to fix the minimum price of electrolytic copper at £100 several weeks ago. At that time the Government purchased 60,000 lb. of copper which it planned to supply to munition makers at the minimum price. The London market, however, has steadily advanced and today stands at £136. As a result of the latest action, the New York Metal Exchange received no cable quotations on March 2, as the London market was closed. How the new decree will work out, and what effect it will have here is for the future to tell. It is cabled that the London metal-brokers will seek a modification of the order. They assert that it will not benefit the Government. Opinion in New York is that no good will be accomplished by the regulation so far as copper, lead, and spelter are concerned, inasmuch as the chief sources of England's supplies lie in countries beyond her control, and war conditions must govern. Spot supplies of the metals are so small in London that business there will amount to little. The London exchange may be closed, and in this event New York might easily become the metal centre of the world. The copper quotations on the London Metal Exchange have been chiefly those of standard or unrefined copper, and in this connection, John D. Ryan, president of the Anaconda Copper Mining Co. is quoted as saying: "The standard metal market in London has not been an important one for many years past. American electrolytic and Lake copper make the price the world over, and the speculation in standard copper in London has been used principally by metal-dealers to affect sentiment to depress or advance the price of stock or metal as they may be interested. The price of standard copper in London has had very little, if any, influence on the American seller of copper, and the price of copper is not and has not been for many years affected by London fluctuations to any considerable extent."

Incidentally it may be said that the copper prices quoted at the New York Metal Exchange have been for standard or unrefined metal, a fact not realized or understood by many lay publications.

COPPER

The spectacular advance in copper quotations with its attendant buying has been checked, at least temporarily, with the result that prices of prompt deliveries have eased considerably, while futures are a little lower also. The big agencies continue to restrict their sales largely to June and July metal. The quotation for these months is about 27.12c. cash, New York. Prompt copper, which was quoted a few days ago at 28.50c., can now be had at 28.12c., these prices pertaining to both Lake and electrolytic. For a week or more the market has been quiet, gradually approaching a state of dullness, a trend which started with a strike of brass-mill workers at Ansonia, Connecticut. The strike lasted only a week, the men returning to work last Monday, but the trouble was sufficient to throw over the market a damper from which it has not yet recovered. With the easier quotations came a

puzzling development, not by any means a new one, yet one which surprised the trade. Despite all the talk of spot and near-by copper being scarce, these positions began to be offered freely, both by the smaller producers and by second-hands. As for the latter, it has been maintained that there was very little speculative copper in existence. Of course, it is to be considered that consumers who buy heavily not infrequently offer metal for re-sale. Electrolytic copper at London, March 1, was unchanged at £136, but on that day standard or unrefined copper declined £4 10s. to £101. Exports in February totaled 20,548 tons.

ZINC

The market here has been quiet and prices have dropped a few points, but London needs spelter and quotations there have advanced. On March 1 the London quotation was £111, establishing a new high record. Some buying on English account is expected; meanwhile the domestic market is dull. The quotation for spot-metal at New York on the 1st was 20.50c. Early positions are still declared to be scarce, although there appear to be more offerings of brass-mill special grades. These have been quoted around 22c. Second-quarter prime Western is quoted at about 18c. Producers are not pressing sales. This is a sellers' market and they can afford to wait. Exports in February totaled 3155 tons.

Sheet zinc is quoted at 25c., f.o.b. mill, 8% off for cash.

LEAD

The lead situation is a puzzling one. The A. S. & R. Co. continues to adhere to 6.30c., New York, and 6.22½c. St. Louis, and is ostensibly out of the market, yet according to reports it has accommodated some of its customers with limited quantities. The independents are well sold up, but where they do sell they are getting 6.50c., New York. Both the domestic and foreign demand is good. The supposed reason for the action of the A. S. & R. Co., in clinging to 6.30c., New York, is that it is trying to halt what may become a runaway market. Its policy is not to sell far ahead, and it has declined a great deal of business. If the independents become entirely filled up for some months to come the leading interest will then have things its own way, and this may be the plan being pursued. February exports totaled 5085 tons.

TIN

On February 28 the quotation for spot-tin advanced 5c. to 50c., but it was on bids only on the New York Metal Exchange, and no business was reported at that figure. Later on that day the bidders were offered the metal at 50c. and they declined to take it. The following day sales were made at 48c., but since that time the tendency has been downward, and the market was quiet and easy on the 2nd at 46.75c. No large business has been done for days, and prior to the 50c. bids the market was extremely dull, not so much because there were no buyers, but for the reason that sellers were cautious and unwilling to part with their holdings. It has been steadily becoming more difficult to obtain shipping licenses from Great Britain, and the brokers have dreaded not being able to fulfill their commitments. Shipments have been delayed, and should the situation become aggravated there is prospect of higher prices of which the brokers might take advantage provided they have metal on hand. The quantity of tin in this country is fair, but it is tightly held. Deliveries into consumption in February were record-breaking, amounting to 6388 tons, indicating not only that consumption is large, but that consumers are stocking-up. In stock and landing at the end of February was 1308 tons, and afloat at that time was 5866 tons. Of the deliveries in February, 1388 came to the East from Pacific ports.

COMPANY REPORTS

PORTLAND GOLD MINING CO

The report of this Cripple Creek, Colorado, company covers 1915. During the year Stratton's Independence was purchased for \$325,000. To the end of 1915 the combined properties of over 250 acres had yielded \$61,426,370 from 3,653,969 tons of ore. Adjacent to these workings, and on dumps there is from 12,000,000 to 15,000,000 tons of profitable low grade ore. This will be treated on a large scale by flotation, at less cost and with higher recovery than by cyanidation. The Independence mill has been partly re-modeled for this process, and is to be enlarged to 1000 tons' daily capacity. The Victor plant is also to be changed and enlarged. That at Colorado Springs, treating high-grade ore, will continue to use cyanide. Every level of the Portland mine contributed to last year's output. Lessees only worked at 200 feet.

Development in the mines amounted to 19,808 ft., an increase of 4216 ft., each foot opening 3.6 tons of ore. Thirty-five new stopes were opened. No. 2 shaft was sunk 151 ft. to 1870 ft. depth. Indications here point to a large amount of good ore. No. 17 level has been an unusually productive one.

From the Portland mine the Colorado Springs mill treated 55,339 tons of \$21.6854 ore, 213,122 tons of \$3.033 ore at Victor, and 12,967 tons of \$22.75 ore by lessees, a total of 280,528 tons averaging \$8.154 per ton. Including the Independence there was treated 426,580 tons. The net profit was \$798,460. Dividends amounted to \$260,000, making \$10,177,080 to date. The cash balance on January 1, 1916, was \$483,503.

TEMISKAMING MINING CO.

The ninth annual report of this Cobalt, Ontario, company covers the year 1915. The general manager, F. L. Culver, states that development totaled 4763 ft., also 8853 cu. yd. of

The Beaver Consolidated property, adjoining on the north, had driven a crosscut 125 ft. to the west of its shaft and opened a new orebody. This discovery was made 55 ft. north of the Temiskaming line. Arrangements were made with the Beaver company to have it drive south on its property to penetrate Temiskaming ground, and in December 1914 it opened for the Temiskaming what has since been termed the "new vein system." Early in 1915, the Temiskaming started two cross-cuts to the west from the old workings in the Temiskaming, to intercept the new vein, one on the 400-ft. level and one on the 500 ft. level. Work during 1915 proved the ore-shoot on the new vein to be of large proportions and of exceptional richness.

As early as 1904, Willet G. Miller, provincial geologist of Ontario, proved beyond doubt the existence of a diabase sill which intruded both the Keewatin and Huronian formations. On the Temiskaming property, this intrusion occurs in the Keewatin as far as is known. The upper contact between the Keewatin and the Diabase has been proved to be approximately 500 ft. from the surface. Along this contact, both above and below, the Temiskaming and the Beaver have recovered their richest ores. It is reasonable to suppose that, at the lower contact or along the floor of the diabase sill, equally rich ore as occurred at the upper contact will be found. In order to ascertain the thickness of this diabase sill, a joint arrangement was made with the Beaver company to diamond-drill the properties. A drill was placed at the 900-ft. level on the Beaver, and a hole driven at an angle to penetrate both properties. It has been determined that the lower contact between the diabase and the Keewatin formations exists at a depth of approximately 1670 ft. from the surface. Having determined this, the Temiskaming is sinking the main shaft with all possible speed to cut this lower contact in the hope that like enrichments may be proved as were found on the contact above.

At other properties in the Cobalt area, it has been proved that the upper contact has been eroded away and that the

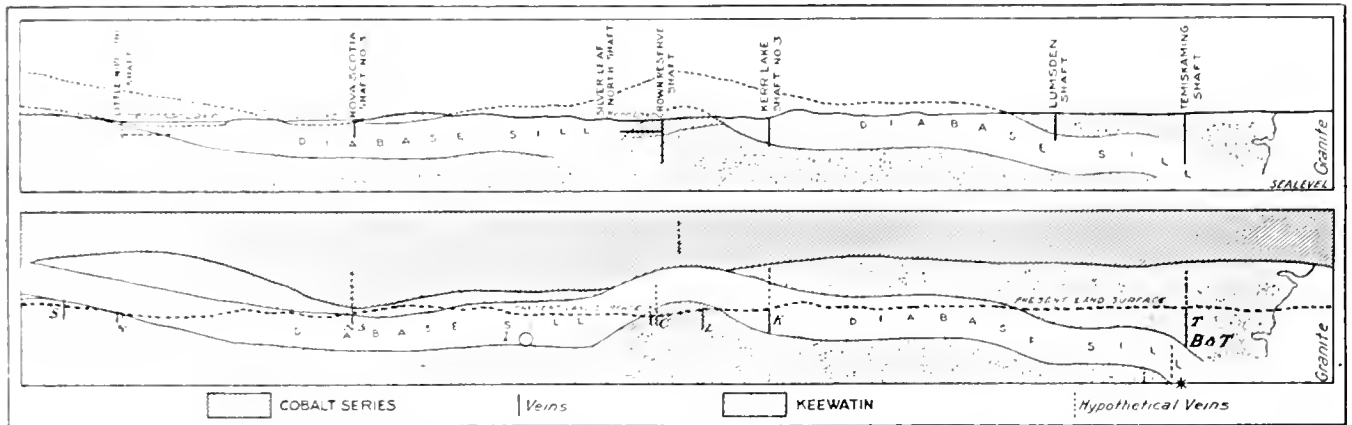

GENERALIZED VERTICAL SECTION THROUGH THE PRODUCTIVE PART OF THE COBALT, ONTARIO, AREA. THE TOP PLATE SHOWS THE GROUND AFTER EROSION, THE LOWER ONE BEFORE EROSION.

stopping. From the 400, 500, and 530-ft. levels most of the ore was extracted. Work resulted in large quantities of high-grade and mill ore being opened.

The mill treated 26,927 tons of ore, yielding 391 tons of concentrate. Silver recovered was 509,074 oz. There was 1,456,894 oz. shipped. The high-grade averaged 6413 oz., and the low-grade 1302 oz. per ton. Production cost 16c. per ounce. Silver was sold to meet current expenses, but large quantities are stored at New York and London. The year's revenue was \$455,541, and expenditure \$358,956. A dividend of \$75,000 was paid on December 31, 1915.

The output to date is 9,116,404 ounces.

The following exploratory work is of interest, and of value to the future of Cobalt:

lower contact is not nearly so deep as at the Temiskaming and Beaver. This was demonstrated at the No. 3 shaft on the Kerr Lake mine, where the lower contact was reached at a depth of between 274 and 322 ft. Development in this shaft, just above the contact, produced approximately 5,000,000 oz. of silver, while at the No. 2 shaft, that company got silver below the contact. Kerr Lake shaft No. 3 is about one mile north-west of the Temiskaming shaft. At the Lawson property (part of the La Rose group), which adjoins the Kerr Lake, approximately 2,500,000 oz. of silver was recovered below the contact.

The accompanying plan will explain the above notes. To the right is a long granite ridge. The lower contact from K down to the point designated by the start has never been

penetrated, only by the diamond-drill, which was used to explore the formation. The Beaver and Temiskaming properties adjoin, the main shafts of the two properties being about 400 ft. apart. At the point marked *B* and *T*, which would eliminate the dividing line between the properties, and just denote so much ground, at the upper contact nearly 14,000,000 oz. of silver had been removed. From *K* to the left to a point marked *O*, the lower contact has been mined by various companies and been productive of a great amount of silver. From the dip of the rock in the Keewatin and also in the diabase sill, the Temiskaming officials are led to believe that the flow came up against the granite ridge and flowed to the left, and that deposits of silver have been made between the points *K* and the star to the right. It is for this purpose that sinking the shafts on both the Beaver and Temiskaming properties to encounter the lower contact is being done.

The main shaft of the Beaver is down 1350 ft., while the Temiskaming is down 900 feet.

COPPER RANGE CO.

This company controls the Baltic, Champion, and Trimountain properties in Michigan. Results may be summarized as follows:

| | 1915. | 1914. | 1913. |
|--------------------------------|-------------|-------------|-------------|
| Development, feet | 37,903 | 13,542 | 20,353 |
| Raises, feet | 7,939 | 6,417 | 5,321 |
| Ore stamped, tons | 1,651,870 | 1,216,538 | 984,287 |
| Average content, lb. per ton. | 32.5 | 22.9 | 25.24 |
| Metal output, pounds..... | 53,739,442 | 27,867,457 | 24,852,026 |
| Price received, cents per lb.. | 17.4 | 13.38 | 14.89 |
| Gross revenue | \$9,373,120 | \$3,726,389 | \$3,707,091 |
| Cost, cents per pound..... | 8.06 | 10.66 | 11.71 |
| Net income | \$3,564,762 | \$494,600 | \$490,536 |
| Dividends | 1,182,003 | | 1,084,498 |
| Surplus | 2,382,759 | 494,600 | |
| Deficit | | | 593,962 |

Ore reserves were greater than at the beginning of the year.

Individual production was 12,028,947 lb. from the Baltic, 33,417,599 lb. from the Champion, and 8,302,896 lb. from the Trimountain. The Copper Range Co. only benefits from 50% of the Champion profit.

ST. JOSEPH LEAD CO.

During 1915 this Missouri company had the following results:

| | 1915. | 1914. |
|-------------------------------|-------------|-------------|
| Lead output, tons | 84,356 | 77,404 |
| Average price per ton | \$90 | \$74 |
| Net profit | \$4,283,425 | \$2,317,040 |
| Total income | 4,392,360 | 2,427,686 |
| Net income | 3,489,964 | 1,547,275 |
| Surplus after dividends | 1,998,883 | 1,273,580 |
| Previous surplus | 9,416,629 | 8,237,190 |
| Final surplus | 11,415,512 | 9,416,629 |

The balance-sheet as of December 31 shows cash \$442,127, against \$392,599. The profit and loss surplus was \$3,261,276, compared with \$2,543,627.

IRON BLOSSOM MINING CO.

The annual report of this Provo, Utah, company contains the following data:

No. 1 workings yielded 16,549 tons, averaging 0.139 oz. gold, 25.1632 oz. silver, 2.6889% lead, and 1.1559% copper, equal to \$17.7514 per ton. No. 3 workings produced 26,764 tons, assaying 0.1634 oz. gold, 31.2926 oz. silver, and 8.9212% lead, worth \$23.1125 per ton. Some copper and zinc was also produced. Costs at the mine averaged \$4.851 per ton; sampling, freight, and smelting cost from \$8.5573 to \$9.5852 per ton.

The revenue was \$770,981, including \$557,185 from ore sales. Dividends absorbed \$300,000. The cash balance on December 1, 1915, was \$128,997, a small increase.

BOOK REVIEWS

THE MINING MANUAL FOR 1916. By Walter R. Skinner. P. 957. Ill., index. Published by the Author and *Financial Times*, London, 1916. For sale by the MINING AND SCIENTIFIC PRESS. Price, \$6.

This is an annual volume, appearing this year as the 30th consecutive issue. It is the standard reference book of mining companies having headquarters in London, and it includes information concerning a number of American companies having shareholders in England. It is the Red Book of mining, and has won an honorably useful place as the chronicle of company finance and operations in that large part of the mining world that is irrigated by British capital. We find it invaluable in our own work, and recommend it to those having business with mining houses in London. The list of companies, directors, and secretaries is useful to anyone engaged in Anglo-American mining enterprise.

HEATON'S ANNUAL. The commercial handbook of Canada and Boards of Trade Register. Twelfth year, 1916. P. 506. Index. Published by Heaton's Agency, 32 Church street, Toronto.

As the WORLD ALMANAC is to the United States, and WHITAKER to England, so is HEATON'S to Canada. As in previous years the annual contains official, bank, insurance, and legal directories, postal information, cable-rates, the complete customs tariff revised to date; a shippers' guide (covering every commercial town in Canada and giving the population, railways, and banks), list of registry-offices for deeds, chattel mortgages, etc., up-to-date descriptions of every town in Canada, exchange and miscellaneous tables, and a mass of valuable general information, from which cross references are given to the section 'Where to find it' (new) for the benefit of those who want further information. Mining covers 15 pages.

METAL STATISTICS, 1916. Ninth annual edition. Edited by C. S. J. French and B. T. V. Luty. P. 368. Published by *The American Metal Market and Daily Iron and Steel Report*. The American Metal Market Co., 81 Fulton street, New York, 1916. Can be obtained through the MINING AND SCIENTIFIC PRESS.

The publishers of this handy (4 by 6½ in.) little book issue a daily and monthly discussing the metal markets generally, and therefore are in a position to compile a volume covering each year, this one containing all that is necessary to know regarding 1915. The chapters include notes and statistics on iron ore, coke, pig-iron, manganese, steel in all forms, copper, tin, lead, spelter, aluminum, antimony, silver, imports and exports, prices, analyses, duties, and many other factors in the metal world. A buyers' directory of 32 pages gives the full name and address of over one hundred ore and metal dealers, a useful appendix at this time of much enquiry for these products.

DETAILS OF PRACTICAL MINING. Compiled from the *Engineering and Mining Journal* by the Editorial staff. P. 544. Ill., index. McGraw-Hill Book Co., New York, 1916. For sale by the MINING AND SCIENTIFIC PRESS. Price, \$5.

The journal from which this book is compiled has a department under a similar title, and in 1912 published a 372-page volume called 'Handbook of Mining Details,' culled from the same source. The new work is half as large again, and contains a great variety of material that was published between July 1912 and July 1915, all different from the first. The selection and arrangement was done by Lee O. Kellogg, until recently a member of the staff. It is impossible in a brief

review to attempt to discuss this collection of practical suggestions and results the contributions of scores of mining men. The chapters include surface plant and operations, timber structures, explosives, rock drills, shafts and raises, drifting, stoping, hoisting and transportation, shaft conveyances, cars, track, drainage and ventilation, and safety and sanitation. Many opinions are expressed, but it is an excellent reference of practical work.

MATERIALS OF CONSTRUCTION. By G. B. Upton. P. 20. Ill. Index. John Wiley & Sons, Inc., New York. For sale by the MINING AND SCIENTIFIC PRESS. Price, \$2.50.

This volume is stated to be the outgrowth of a college lecture course, but it will be of value to the practising engineer as well as to the student. It is divided into two parts. The first part deals with the determination of the properties of materials by engineering testing, tension, torsion, compression, and bending stresses are considered in order; impact and other minor tests are discussed, also special test for hardness and the fatigue of materials. Some space is also devoted to corrosion and other effects of age upon materials, and the general subject of specifications is briefly considered. Part II takes up the nature of the internal structure of materials and the control of properties through the control of their internal structure by chemical and physical means. Naturally considerable space is devoted to steel and the effects of heat treatment and of varying the proportion of carbon and other elements. The remaining chapters deal with cast iron, alloy-steels, non ferrous metals and alloys, and cement.

MECHANICAL DRAFTING. By Charles B. Howe. P. 117. Ill. Index. John Wiley & Sons, New York, 1915. For sale by the MINING AND SCIENTIFIC PRESS. Price, \$1.75.

If this work were to be judged from its title alone, it might be inferred that it dealt with mechanical or machine drawing only. This, however, is not so, as it takes the student through from the beginning, including the care and selection of instruments and materials, architectural studies, mechanical studies treated as problems in orthographic projection, topographical, and development in sheet-metal work. The work is intended as a text-book for preparation schools, and as an assistance to the teacher rather than a manual of self-instruction; but the illustrations are treated in a simple manner, making it an easy interpretation for the student. Chapter II is devoted to lettering, a subject of much importance, yet here it is discussed in an abridged manner. In selecting and maintaining an efficient drafting corps for large corporations, more attention is being given to free-hand lettering, and even by small concerns. A poorly delineated drawing may be made plain and attractive by good lettering, for it is the lettering that gives character to the drawing. Orthographic projection and geometric drawing are covered in 23 pages. Chapter V is devoted to working drawings. The next one includes a number of plates for conventional details and simple machine parts. The following 31 pages deal with the architectural treatment of plans and structural details. Then comes topographical drawing. The work is concluded with perspective and shade-line drawings; the illustrations for the latter are poor and could have been treated much more forcefully.

Regulations have been issued by the Interior Department covering the manner of proving "good faith" in placer locations of phosphate lands made prior to January 11, 1915, which locations were validated by the Congressional Act of that date. Patents will be issued for such lands under the mining laws with the additional requirement that claimants must submit authenticated copies of annual "proofs of labor" showing performance of annual assessment work for each year since location, or corroborated affidavits to the same effect.

Regulations of March 31, 1915, 44 Land Decisions, 46.

INDUSTRIAL NOTES

The INTERNATIONAL ACHEISON GRAPHITE Co., of Niagara Falls, New York, has changed its name and hereafter will be known as ACHEISON GRAPHITE Co.

The GRANBY MINING & SMELTING Co., of St. Louis, Missouri, announces the appointment of Alfred W. Dodd as its Eastern sales agent with offices at 165 Broadway, New York.

The manager of The Independence Gold Mines Co., L. S. Robe of Seattle, Wash., operating near Kuk, Alaska, has given the DENVER QUARTZ MILL & CRUSHER Co., Denver, Colorado, an order for ore-milling equipment including one No. 2 Denver quartz mill, one 8 by 12-in. Denver steel crusher, one No. 2 Denver ore-feeder and two 54 by 96-in. copper-plates. The stamps and crusher now in use will be discarded.

A new catalogue has just been issued by the REDWOOD MANUFACTURERS Co., San Francisco, which embodies a quantity of excellent information on wood pipe. Besides the data generally found in a booklet of this nature, tables are given showing allowable curvature in pipe construction, relative capacities, water-wheel requirements as for cubic feet per horsepower, pump speeds and capacities, friction losses, rate of flow for various sizes of pipe, and other tables.

The WAH CHANG MINING & SMELTING Co. of China and New York, states that on March 2 the antimony market was firm with a strong undertone. There are many inquiries, but for some days buyers have held aloof in the expectation of a change in price. It appears, however, that in view of the recent rise in freight from China to New York the price is going to be directly affected by a further rise. The spot market is bare, and prices vary between 43 to 44c. per lb. The company is sold out for February shipment, with very little March offering. They quote on the 2nd for March-April shipment from China 34c. c.i.f. in bond.

A section of one of the largest cables in the world, made under a new design at the plant of the JOHN A. ROEBLING'S SONS Co., was tested at Lehigh University, and withstood a pull of 716,000 lb. The test took place in the Fritz engineering laboratory, under the direction of the Lehigh civil engineering department. The 800,000-lb. Richie machine of the University was used. The new cable is confidently expected to have great wearing quality, because of its design, which includes six strands of 37 wires and an independent wire-rope centre. The cable was designed for use in the Mayaria mines in Cuba, owned by the Spanish-American Iron Co., a subsidiary of the Pennsylvania Steel Co. It will be attached to 50-ton ore-cars operating on an incline-plane of more than a mile, with a grade of 25%.

The following interesting note is from the HARDINGE CONICAL MILL Co. of New York: An installation which pleased the firm was an 8-ft. standard Hardinge ball-mill taking stamp-feed at the Dome mine, Poreupine, and reducing it for tube-mill grinding. This mill was guaranteed to give a capacity of 350 tons, and the estimated horse-power 125, with the provision that the over-size should be returned to the head of the mill. It was found that the over-size arrangement had been operated two or three days, but was out of commission when Mr. Hardinge arrived, owing to the fact that it was not needed. The mill was putting through 550 tons, taking between 105 and 110 hp., and grinding same so that it would pass to the tube-mills without classification. The company recently shipped two 8-ft. ball-mills to the Nevada Consolidated Copper Co. for fine grinding, and now has an order from them, without knowing the results of the first two, for two more 8-ft. mills.



EDITORIAL



T. A. RICKARD, Editor

BILLS have been introduced in both houses of Congress providing for the erection and maintenance of monuments marking the site or guide-posts indicating the direction of water-holes in the Western deserts. It is also proposed to issue maps and other information concerning sources of potable water in the arid regions. A sum of \$10,000 has been asked for this purpose. If done conscientiously, it were well done.

BIBLIOGRAPHIES are useful, particularly when they are timely. We welcome the bibliography of concentration by flotation just issued in the form of a bulletin by the Missouri School of Mines. This furnishes what appears to be a sufficiently exhaustive list of the articles on the subject appearing in the technical press during the last 15 years, including January 1916. It also gives a chronological summary of the British and American patents relating to flotation. In short, it is a useful and enterprising piece of work on the part of the librarian at Rolla, Mr. Jesse Cunningham.

FLOTATION of oxidized ore has been successfully effected by Mr. Joseph T. Terry, Jr., at Superior, Arizona. He has been investigating the problem for the past two years, experimenting on the oxidized ores of the Magma mine. It can be stated definitely that malachite and azurite ore can be treated with high extractions and that the addition of a particular liquid to the flotation cell is helpful to sulphide flotation also. We understand that Mr. Terry does not purpose to patent his discovery, believing that he can make more money by the sale of his secret than by disclosing his method in a patent.

THE Canadian Mining Institute bulletin for March contains an interesting note by Mr. J. B. Tyrrell on the representation of the mining industry in the Dominion Parliament. This is apropos of a resolution passed some time ago by the Canadian Institute asking the Government to endeavor to get some mining engineers, or men otherwise familiar with the mining industry, into one or other of the two legislative chambers in order that they might give useful advice in regard to measures designed to aid one of the basic industries of the country. The Canadian cabinet consists of 17 men, of whom 9 are lawyers. In England the legal profession is even more strongly in possession of the administration, as is emphasized by Mr. H. G. Wells in a recent article in the *Saturday Evening Post*, in which he argues that one of the beneficent results of the War will be to get rid of an excess of lawyers and their medieval methods in the con-

trol of national affairs. Mr. Tyrrell advocates the larger employment of engineers in an advisory capacity to his Government during this time of war and he reiterates the request that mining affairs at Ottawa be regulated and assisted by utilizing the experience of mining engineers. His suggestion is not without application to Washington.

CRUSHING, that is, the mechanics of the operation, is a subject of practical importance. Last week we published a letter from Mr. A. O. Gates, and in this issue Mr. H. Stadler returns to the charge. He is a vigorous but withal a genial disputant. As a matter of fact he might be forgiven if a little acerbity were apparent in his discussion of the subject, for he seems to have received rather shabby treatment from the Mines Trials Committee at Johannesburg. A committee is apt to be less kind and less considerate than any one of its personnel. Not only was he compensated for his sincere technical efforts by a miserable remuneration, but the Committee forbade him from using his own data in any published writings. To pay an engineer no better than a roustabout is—shall we say—unprofessional on the part of a committee of professional men, but to place an embargo on useful knowledge is worse. Every member of the profession ought to be a unit in condemning secrecy when unnecessary.

IN our issue of March 4 we discussed Chinese mining regulations. Since then we have received word from Peking that Mr. G. G. S. Lindsey, who has been in China for the past twelve months in connection with the grant of a mining concession to a group of European capitalists, headed by the Central Mining & Investment Corporation, formerly identified with the firm of Werner, Beit & Co., has finished his task. On the completion of it an Imperial mandate announces that Mr. Lindsey has been asked to undertake the work of drafting a new set of mining laws and regulations for China. We are informed that he has accepted the appointment. As we explained to our readers recently, the Chinese government has made several attempts, dating from 1902, to promulgate mining regulations satisfactory to the treaty powers, but so far every attempt has proved abortive. Now, in fulfillment of its earnest desire to carry out existing obligations and to induce foreign capitalists to aid in the development of the country, the Imperial Government at Peking has made a new departure. It is expected that the regulations to be drafted by Mr. Lindsey and his staff will be prepared in accordance with modern mining requirements, and on a liberal basis.

with the object of opening the mineral resources of China to foreign enterprise. We need only add, for the few who may not know who Mr. Landsey is, that he is a Toronto lawyer, well and honorably known in Canada, especially among those engaged in mining, as is proved by the fact that in 1914 and 1915 he was president of the Canadian Mining Institute, he is fully fitted, by his knowledge of mining and of law, by his energy and tact, to perform well the difficult task entrusted to him.

EARTH TREMORS on the Rand had become so frequent and so perturbing to the local community that the Union Government of South Africa appointed a commission to investigate the matter. This commission has now issued a report stating that the shocks originate from mining operations, and not from earthquakes proper. They are due to crushing of the rock-pillars left in the big stopes of the deeper mines, such crushing and collapse of ground being due to the superincumbent weight, which is increasing steadily as the ore is excavated over larger areas underground. The tremors caused by the shock are transmitted to the surface and for a distance of as much as seven miles. The greater frequency and violence of the tremors at Johannesburg, as compared with other towns along the lode, is due to the more intensive mining in that neighborhood. Of course, little of this is new to those well informed, but the publication of it in the *Transvaal* may serve to allay public anxiety. 'Air-blasts' are fairly well understood in other districts where the deep mining of lodes of relatively flat dip is extensive, as at Hancock, in Michigan, and in the Kolar district of India. The Commission suggests that the shocks may be prevented by the removal of existing pillars when insufficiently strong and the adoption of sand-filling in substitution. Also, new shafts should be protected by larger pillars, and both the inclines and the drifts should be excavated in the foot-wall rock. Some of this has the savor of a counsel of perfection; we shall be curious to see how nearly the advice is followed.

Is it Intervention?

On March 9 the tawdry melodrama of Mexican miserie suddenly diverted attention from the heroic struggle at Vera Cruz, and our daily press enjoyed an orgy of irresponsible sensationalism. Obviously the action of Pancho Villa in crossing the border to make an unprovoked attack on the little town of Columbus, in New Mexico, was not merely a brutal folly. As an expression of hate, it would have been stupid, for while the Mexican bandits killed 16 persons, of whom half were civilians, they themselves lost, in the attack and retreat, at least five times as many. The purpose of the raid was not punitive, but political. Villa has been playing a losing game in Mexico; as a revolutionary he has lost; unable to obtain a following against Carranza, he plans by this desperate act to involve Mexico in war with the United States and pose again as a national leader. The intol-

erable outrage of a massacre of Americans on American soil would arouse reprisals, he argued; it would compel the government at Washington to abandon 'watchful waiting'; it would compel President Wilson to send troops across the line. That would give Villa the chance to rally the Mexican people against the invader; instead of being a beaten rebel, he would spring into the limelight as a patriotic chieftain. He has nothing to lose and all to gain by creating complications between the Mexican and American governments. It is possible that his expectations may be fulfilled. Our yellow press talks recklessly about "invasion" and the sending of a "big army" into Mexico, instead of recognizing that the immediate purpose is only to capture an international outlaw. Mr. Hearst assures the President that he and his papers will "stand by him [the President] loyally" now that he has decided "to avenge the insults and outrages inflicted upon Americans." That is exactly the talk Villa hoped to hear. Meanwhile Carranza is in a quandary. He is between the devil and the deep sea—between Villa and Washington; if he acquiesces in American pursuit of the bandits into Mexico, he will give Villa the opportunity to dub him a traitor; if he refuses, he will face American intervention and be driven by Mexican sentiment into joining with Villa, Zapata, and all his former opponents into a defensive war against the gringo. On the 10th inst. he sent a message from Guadalajara asking for permission to send troops across the border, asserting that "the tenacious pursuit" by some of his men under General Luis Gutierrez had been the cause of Villa's incursion into American territory. If so, why did Gutierrez fail to arrest Villa on his return? In transmitting this diplomatic request General Carranza referred to the agreement made thirty years ago between the American and Mexican governments whereby each allowed the armed forces of the other to cross the boundary in pursuit of the Apaches, who were then on the rampage. But the head of the Mexican government made no reference to the American preparations for sending an expeditionary force against Villa. On the 12th inst. he published a manifesto in Mexico City stating that under no circumstances would his government sanction the invasion of Mexican territory by an armed force from the United States "without reciprocal rights being granted to the Mexicans." On the 13th the Government of the United States granted permission "for military forces of the *de facto* government of Mexico to cross the international boundary in pursuit of lawless bands of armed men, who have entered Mexico from the United States, committed outrages on Mexican soil and fled into the United States," this being an exact description of Villa's performance, *mutatis mutandis*. But the above permission is granted on the understanding that the *de facto* government of Mexico grants the reciprocal privilege, and the United States assumes "that, in view of this agreement, the arrangement is now complete and in force," so that American cavalry will be in Mexico before our readers see these remarks. But before these words get

into print, and while these diplomatic exchanges are in progress, Villa is distancing his pursuers and planning fresh depredations likely to arouse the people on both sides of the border to mutual antagonism. If the American cavalry could have caught or killed him in the pursuit immediately after the raid, it would have been easy to apologize to the Mexican government for transgressing its territory; or if Carranza had promptly offered to contribute a Mexican force equal to that organized later by General Funston for the purpose of putting an end to Villa's depredations, it would have removed several opportunities for friction. Now the matter, it seems to us, is largely out of the hands of either government; the course of events depends on Villa's actions. If he massacres an American community in Mexico or does anything else outrageously to flout American sentiment, it will be impossible for President Wilson to withstand the popular demand for military operations on a large scale; it may be equally impossible for President Carranza to avoid calling his people to arms in defence of their country. Thus the Mexican revolution may find its sequel at last in American intervention.

Flotation of Chalcocite Ore

In a recent issue we stated that the man who first proved that copper in the form of chalcocite could be concentrated by frothing deserved grateful remembrance. Since then we have ascertained the facts in the case, and desire hereby to promote a grateful remembrance of those deserving of the credit. On December 6, 1911, Mr. Edward H. Nutter, the representative of the Minerals Separation company in San Francisco, received a sample of chalcocite ore from the dump of the Joe Bush mine, belonging to the Inspiration Consolidated Copper Company, at Miami, Arizona. That sample was sent to Mr. Nutter by Mr. I. W. Greninger, then in the employ of Minerals Separation, but now underground superintendent for the Inspiration. The sample was tested by Mr. E. W. Wilkinson in the Minerals Separation laboratory, in the Merchants Exchange building, San Francisco. The result was a 9% concentrate and a 0.4% tailing on a 1.4% copper ore. Rather better results were obtained subsequently on some samples from the Miami mine, but still they were not good enough, it being recognized that they were due largely to a gangue-supported froth that could not be reproduced in practice. So nothing more was done until November 1912, when another series of tests was made on Inspiration ore, using the slide machine. On a 2% ore, a 15% concentrate was obtained with an 87% recovery, and a 39% concentrate with a 55% recovery. The various tailings assayed from 0.11 to 0.20% copper. These tests were made by Mr. F. A. Beauchamp in the same laboratory. A telegram stating that a 15% concentrate could be obtained with an 87% recovery was mutilated on its way to New York and on arrival was made to state that

a 50, not 15, per cent concentrate could be obtained. The higher figure caused considerable elation to all concerned, notably Dr. S. Gregory of Minerals Separation and Mr. W. D. Thornton of the Inspiration company. However, Mr. Nutter and his staff felt warranted in promising good results and forthwith made arrangements for the erection of an experimental plant at the mine. By March 1913 it was possible to give decisive results. These showed a 35 to 40% concentrate with a 90 to 92% recovery on a 2% chalcocite ore, leaving tailings assaying from 0.15 to 0.20% copper. Satisfactory results were obtained even when the air in the mill was so cold that the bubbles froze before they were out of the flotation-cell. Some difficulty was caused by ore having a granitic matrix in which a decomposition product, or kaolinized mineral, was present. This being of a colloidal nature, led to the diversion of the oil from its proper function. Final success ensued when Mr. G. A. Chapman suggested the addition of oil to the pebble-mill, whereby the mineral particles became oiled at the moment of exposing fresh fractures. This idea was patented promptly by Mr. Chapman for Minerals Separation. It remains to state that the tests were supervised by Mr. Louis R. Wallace, now superintendent for the International Smelting Company at Miami, the evidence then obtained warranting a reasonable expectation that on a 1.58% ore, there would be obtained a 27½% concentrate with a recovery of 92% and a tailing loss of 0.13%. This has been measurably fulfilled, for if the extraction now is only 83% it is because a small proportion of oxidized ore is allowed to go to the mill with the sulphide product. This then is the story of how chalcocite ore was first treated by flotation. It does credit to the Minerals Separation staff, for it is owing to their insistence that the Inspiration company put the question to a test and finally erected a plant of 15,000 tons daily capacity.

After the War—I

If popular expectation could determine the length of the War, we should know when the howitzers would cease from troubling and the trenches be at rest. By general consent it is assumed that hostilities will continue during the current year, but that they will be ended early in 1917. Everybody seems agreed to brush aside the nightmare thought of a persistence of this organized calamity into future years. On that basis it is possible to discuss the effects of the War; without some such assumption of its length it is futile to try to make any sort of forecast. Obviously if the nations are to fight until one side is crushed, invaded, and devastated, then all the current ideas concerning the trend of industry in this country are childish. Should either the Central powers or the Entente nations be conquered, destroyed, or disintegrated, then the United States would certainly suffer keenly from the cataclysm. We do not believe that such will be the result, nor do others better in-

formed. On the contrary, it seems likely that as national industrial organisms all the existing countries will survive, although changed as to boundaries and suzerainties in regard to some parts of them. We accept the idea that the War will last not more than twelve months or thereabouts. If so, what then will be the effect? No so catastrophic in a material way as is suggested by many authoritative writers; more calamitous in a psychical sense than is assumed by many thoughtless ones. It is a characteristic of the English-speaking people that they take it for granted that eminence in any one field of human activity fits a man to express an authoritative opinion on every other subject. Mr. Ford and Dr. Jordan are quoted continually on subjects not even remotely connected with motor-cars or fishes; the opinions of Mr. Hall Caine or Mr. Kipling on the War and its many political complications are more seriously regarded than those of Mr. Hirst of *The Economist* or Dr. Dillon of the *Daily Telegraph*. For this a sensational daily press is largely responsible. Yet the observant reader has been offered many thoughtful treatments of the all-pervading subject by competent observers. From them he may conclude that the scaremonger, as usual, has been more noisy than intelligent. The actual loss of life as yet has been far less, in proportion to population, than it was in the American Civil War; and even if the fighting in Europe lasts for another twelve months, it is unlikely to reach the 2½% of fatalities in the North, much less the 4% of loss to the Confederacy. As regards the destruction of capital, it is probable that the wastage of natural resources has been exaggerated even in Belgium and Serbia, for example, and that the natural productivity of these regions, as of other areas occupied by embattled armies, will be restored not long after peace is declared. We read already of the growing grain that hides alike the graves of the invader and the defender on the battlefield of the Marne. In an excellent article in *Collier's* Mr. Henry C. Emery quotes John Stuart Mill in support of his contention that a rapid recovery from the effects of war is in accord with the theory that the destruction of wealth incidental to warfare is different in kind rather than in amount from consumption during peace. Sacrifice of comfort and compulsory thrift during war-time go far to offset the obvious financial losses, and the good habits learned under stress survive in such measure as to become a source of economic strength to a nation, which, on the declaration of peace, is able to widen the margin between maximum production and minimum consumption. Hence the extraordinary recovery made by France after the war of 1870 and of Russia after that of 1904. The Civil War affords an even better example, for it illustrates two phases: The South did not recover for years because its labor-supply collapsed when the slaves were freed. The North continued the industrial development that the War had only checked, for this country was then on the eve of a great expansion, due to the exploitation of natural resources that had barely been tapped. We need not foresee a collapse of labor in Europe, but we may antici-

pate a better organization of that industrial weapon, including a more intelligent use of women in certain kinds of work for which they are naturally fitted. Ideas of general bankruptcy may be disregarded. As Mr. J. Laurence Laughlin shows, in *The Annalist*, the War has not destroyed the store of gold in the countries likely to trade with us; on the contrary, France, England, and Germany have increased the absolute amount of gold held in reserve by their central banks. Even those countries now burdened with excessive issues of depreciated paper will be able to redeem their obligations in gold. While we have been bemused by the stupendous cost of the War and the bigness of the sums raised by the belligerents, it is likely that most of us have forgotten or been otherwise unaware of the latent wealth of the great nations involved. As Mr. W. E. Chancellor suggests, what is a hundred billions of dollars when compared with the resources of the earth, the whole of which is now directly or indirectly contributory to the expense of Armageddon? A hundred billion dollars is stupefying until we recall the fact that a billion people on 30 million square miles are engaged in activities that are being taxed for the purpose of supplying that hundred billion dollars. The wealth of the British empire is at least 250 billions, that of the United States 215 billions, and that of Russia, Germany, and France from 70 to 85 billions apiece. The national incomes of Great Britain, Russia, France, and Germany range from 22 to 30 billions per annum. The six great powers have national incomes aggregating 140 billions per annum, while the total revenue of civilized beings does not fall short of 200 billions per twelve months. The annual saving in countries like England or Germany is over two billion dollars. Thus a possible charge of five billions in annual interest, among the six great belligerents, need not provoke either insolvency or revolution. Hence we come to the conclusion that neither in men nor money will Europe be so crippled as to cause a commercial collapse of world-wide consequence.

In our next issue we shall discuss the question as it applies more directly to American industry, especially mining. Yet we cannot forbear from adding to this post-script. We have emphasized the material loss, because that was our immediate subject, but the man is ignorant indeed who does not realize that the vast and futile brutality of this war has caused the world a loss greater than any number of billions in money or even many millions in lives. To the young it is a great spectacle; a heroic struggle; a moving picture of transcendent interest. To the older generation it means the stultification of Christianity, the sending of civilization to the shambles, a satire on human intelligence. The imponderable results and the spiritual consequences will send their perturbations to every shore of the seven seas and penetrate the tidal waters of human thought to the uttermost corners of the earth. We, or our sons, shall outgrow it, let us hope, for the world is young and life an epic, but it takes all the optimism of youth to repel the horror of the times.



DISCUSSION

Our readers are invited to use this department for the discussion of technical and other matters pertaining to mining and metallurgy. The Editor welcomes the expression of views contrary to his own, believing that careful criticism is more valuable than casual compliment.

Natomas and Re-Soiling

The Editor:

Sir—A recent visit to Folsom enables me to contribute some notes on the working of the new dredge of the Natomas Consolidated, with particular reference to the re-soiling of the ground after the gravel has been dug and washed for its gold contents. In designing a gold dredge that will leave the ground in such a condition that orchards at least are practicable, two limitations must always be kept in view: first, that the efficiency of the gold saving be not impaired, and, second, that there be no material increase in the cost. Experience with the Natoma No. 4 dredge operating on the American river indicates that with some changes, already designed by the management, both conditions can be fulfilled. Their importance can be appreciated by considering that even with ground only 27 ft. deep an increase in the working cost of only one-quarter of a cent per yard would mean that over \$100 per acre would have to be charged to reclaiming the land, a value on which farmers in California often fail to earn interest even where the land is good. Changes now being made in the reclamation feature of Natoma No. 4 bring out another point, namely, that notwithstanding the ability and long experience of the management in gold-dredging, results are not obtained except by actual trial of proposed devices, for as with dredging generally, progress has come about by working on an empirical basis.

The only substantial difference between the ordinary type and Natoma No. 4 is that two stackers and double-deck sluices are used, all four being mounted on swivels. A small monitor is also mounted on the stern of the boat to level the tailing. If the other devices are working properly there should be little or no need for the latter. The principal difficulty appears to be that the quantity of material discharged by the revolving screen onto the stacker-belts is such that it heaps to a height not permitting its being covered by fine from the sluices. Much of the fine material may be seen running off the tailing-piles back into the pond to be covered by coarser material, the reverse of the desired result. The management is confident that this may be remedied by installing a grizzly with five-inch openings at the end of the revolving screen, so as to deflect boulders through two or more chutes to the bottom of the pond. It may be noted here that the detail of design and procedure necessarily depends on the character of the ground to be treated. Plainly, if the original amount of soil be too scanty the problem may be insoluble. A considerable proportion is

usually carried in solution by the pond-water. Uneven contour of both bedrock and surface, particularly the latter, also greatly complicates matters. In the case of a deep hole immediately following a shallow area a large quantity of material from the stacker tends to pile up on high bedrock.

Other changes of less importance are planned, such as

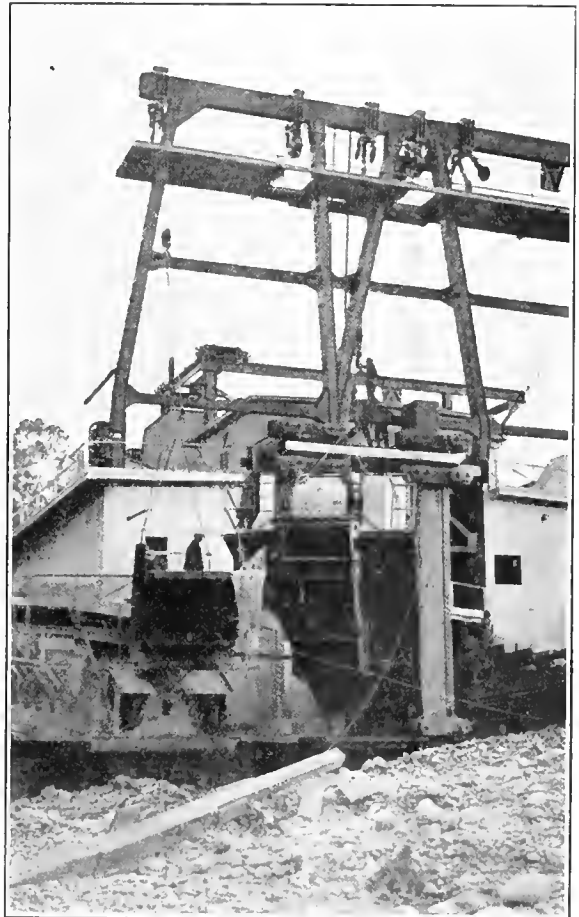

NATOMA NO. 4 DREDGE.

the lengthening of both stacks and sluices by 10 ft. The best position for the sluices, according to the management, has been demonstrated to be directly in line with the boat; consequently, swivels are not needed. The swinging of the boat and consequent swing of the sluices brings about sufficient distribution. The height of the upper tumbler-shaft above the water-line, namely 30 ft., permits the placing of a grizzly. In case of No. 1 dredge now being re-built, 32 ft. has been allowed, thereby ensuring ample headroom.

A comparison of dredged ground on both sides of the

main Folsom road indicates the amount of progress already made. Instead of huge irregular piles, a fairly level pile of tailing is the result of the present working of No. 4 dredge. The dredging industry owes a debt to the Natomas management for its well considered efforts to solve the reclamation problem.

HOWARD D. SMITH

San Francisco, March 2.

Patents

The Editor:

Sir—I have read with interest the editorial on this subject in your issue of January 29. While the conclusion reached is eminently proper, you seem to have reached it in spite of the arguments you yourself advanced. While the patent on its face grants to the inventor the exclusive right, for a limited period, to make, use, and sell the invention, such a statement must be qualified by the clause "when the manufacture, use, or sale of said invention does not infringe any prior unexpired patent." The patent does not give a patentee any more right to make, use, or sell than he had before, because before the patent was obtained he had the same right to make, use, and sell. What the patent really grants is the right for 17 years to prevent anyone else from making, using, or selling the invention patented.

A patent is not a true monopoly, because it does not restrict the exercise of a right that was open to the public before the patent was issued. A true monopoly contemplates a restriction that operates to prevent the exercise of a right which was open to the public before the monopoly was secured. This distinction between a monopoly and a patent, being not usually recognized, has led to confusion and, as in your article, to the questioning of the value of the whole patent system. It must be recognized that a patent covers something new, not theretofore known or used, and the public is not constrained to use the new device or process, being at perfect liberty to continue to use the device or process which it had theretofore been using. If the invention is broadly new and meritorious and effects a considerable saving over the methods of the prior art, it is in demand; and in return for permitting the use of the invention, the inventor is clearly entitled to receive a consideration. The fact that in certain isolated cases onerous conditions are imposed, should not lead to the conclusion that the whole patent system is at fault. A man owning a piece of desirable property is at liberty to ask whatever price he desires, and if his price is exorbitant, the property will remain in his possession, regardless of its desirability. The same condition is true with regard to patents and, in fact, everything else; that is, the price is regulated by the supply and the demand.

Your editorial states, further, that the granting of patents has not done away with trade secrets and it is often questionable whether an inventor should patent his process, disclosing his method, or keep the process secret. This relates entirely to processes and the condition is

brought about, not by the reasons advanced, but on account of the fact that it is often difficult to obtain evidence that a manufacturer is infringing the process. A process patent covers a certain sequence of steps, not the product of these steps, and from the product it is impossible to determine its process of manufacture. If the process is carried on in the factory behind closed doors, the inventor may not be able to obtain the necessary evidence to prove infringement and for this reason some processes are kept secret and not patented.

Your remarks concerning the Victor phonograph are perhaps true, but it must be remembered that the patent gave them a virtual monopoly of the use of disc records for 17 years, during which time, by the expenditure of millions of dollars in advertising, they have made their trade-mark of great value. The patent, however, has now expired, and we find a dozen competitors in the field with machines using disc records. It cannot be successfully contended that a condition which granted them a monopoly of disc records over such a period of years and permitted them to build up their business without competition, was of no value.

The editorial further states that the language of a patent description is often cryptic intentionally. While this may be so in a few isolated cases, it is by no means common and is not considered good practice. A description is often necessarily somewhat indefinite due to its very nature. When an invention is conceived in the mind, it is conceived in its generic form, but when the idea is presented in a drawing or description, it must necessarily be embodied in a specific form. As soon as an idea is expressed in concrete form, it immediately becomes specific. The specific structure, however, is not the invention, but only one embodiment of it; in the description and claims, the inventor desires to express his generic invention; and since language is such a clumsy tool with which to express our thoughts, the description and claims are often obscure.

Exception must also be taken to the inference that the patent system is to be blamed because the inventor is often unable to exploit his invention commercially, due to lack of finance, and must sell his patent. This condition is in no manner chargeable against the patent system, but to our economic system in general and to the natural laws of the world. I have seen several instances of late, where inventors have sold their patents to corporations who were qualified to exploit them commercially and in every instance, the inventor was greatly pleased with his trade. The fact that the corporation takes the risk, expends money in exploiting and manufacturing, and makes a profit, is not reprehensible and should not be so considered by right-minded persons.

I am of the opinion that the patent system in this country has done more to advance this country to its present high state of civilization than any other influence of which we are aware. The desire to gain has been the incentive not only to thousands of independent inventors who have contributed greatly to our advance, but has caused corporations to install research labora-

ories, and operate them at large expense, in an endeavor to bring forth the secrets of the unknown.

I fully agree with you that the man who would abolish the Patent Office should pack his few ancient devices and take to the tall timber.

H. G. PROST.

San Francisco, February 8.

[This subject is one of particular interest at this time. Other letters will appear shortly.—EDITOR.]

The Mechanical Efficiency of Crushing

The Editor:

Sir—None of the arguments of my criticism of an article by Mr. Algernon Del Mar on the above subject, has in his recent reply of November 27, 1915, been opposed or contradicted, but, pluckily on his feet again, he challenges me upon new issues.

In fairness to Mr. Del Mar, I willingly admit that by devoting his full energy to his own business, some of my writings may have escaped his notice, but I am entitled to expect him to look them up if he goes out to kick at "Stadler's theory," and more so, if he accuses me of indulging in personal reflections, instead of giving facts and proofs in support of my contentions.

Not long ago I wound up the controversy on the laws of crushing, in a lengthy and comprehensive article,* in which I also tried, at first in a friendly spirit and in decent form, to convince Mr. Del Mar and Mr. Gates of the incorrectness of the views expressed by them in earlier articles in the same journal. Ignoring my criticism, they both reiterated their ill-considered arguments and statements in another periodical, quoting each other as authorities. Poor Lord Kelvin! His theoretical proof of the law of work based on the property of matter,† has broken down in the light of the results of Mr. Gates' experiments. The maxim of Mr. Del Mar, that such problems "are being unsettled every day," did not however guide the French astronomers, for whom the apparent irregularities of the orbit of Uranus had been the cause of great perplexity for many years, until they discovered Neptune.

Returning to our own petty troubles, I proceed to answer Mr. Del Mar's question: "Will Mr. Stadler prore and give to the public the results of these (referring to the experimental work of the Mines Trials Committee in Johannesburg) investigations?" In anticipation of such reasonable demands, I approached the Committee, while in their employ, twice on this matter, the first time suggesting to them the advisability of being instructed to sum up the intermediate reports on the progress of the work in a final comprehensive one, and the second time, when the Committee was already in a moribund state, asking for permission to make use of the data in my possession for the purpose of publication. Although both applications have been rejected, I am on

my side quite prepared to overcome my moral scruples of committing a breach of confidence, if I am backed up a little in my taking the view that now, after the collapse of the organization, the information and experience gained can no longer be withheld from the investors of the participating companies by self-constituted trustees.

Quoting from memory, Mr. Del Mar believes that I had stated, "that the comparative efficiency of stamps and tube-mills on the Rand varied [he means compared] as 70:17, or 4:1. Any practical operator knows that this is not so with respect to tube-mills in other localities." By omitting the fact that these figures referred, as explicitly stated, to the conditions of a specific test given as an example, the quotation is not a correct expression of my views. In the reply to the discussion of the paper from which the quotation is taken, further examples were published, and in commenting upon the results, due attention was drawn to the rapid decrease in the efficiency of stamps with the increase of the fineness of the battery-screens. From the results of the investigation by the M. T. C. it appears that the merits of the three methods of crushing: single stamp, stamps and tube-mills combined, and single tube-mill grinding (Giesecke mill) are so close, as regards the mechanical reduction efficiency, that the final decision in each case depends upon other considerations, such as metallurgical requirements, nature of the ore, local conditions, etc. In any case, the investigation clearly proved that nothing would be gained by the promotion of the tube-mills from auxiliary to primary grinders.

These results were subsequently confirmed by a gigantic trial-run carried out on a practical working scale by several of the biggest mines on the Rand. Based on an imaginary crushing law, Dr. Caldecott and his friends evolved and inaugurated in 1909-1910 a 'new metallurgy' through which Rand practice was to be revolutionized by shifting the greater portion of the crushing work from the stamps to tube-mills. At the time when enthusiasm as to the marvels to be achieved by this innovation reached its height, we were led to believe that by simply hanging up a portion of the stamps and buying so many tube-mills at so much per dozen, millions of tons of low-grade ore would be brought within the economic limit. The metallurgical advisers of the East Rand Proprietary Mines made Sir George Farrar say at the March meeting in 1910 that they intend "to crush with 440 stamps more than we do now with the whole of our 820 stamps, with consequently much decreased costs." The 'new metallurgy,' based on Rittinger's law, has had its trial! The non-fulfilment of the unwarranted promises was the intrinsic cause of the débâcle of the E. R. P. and of the simultaneous depreciation of the share-market valuation of Rand scrip by about one-third. Yet such trifles are so easily forgotten, and Rittinger's theory is still alive.

H. STADLER.

Royal School of Mines,
London, S.W., January 4.

**Eng. & Min. Jour.*, November 21, 1914.

†Sir William Thomson and Peter Guthrie Tait: 'Treatise of Natural Philosophy,' Vol. II.

Account Systems for Small Mines

*Elaborate book keeping is the general custom with large mining companies, requiring a numerous staff. While this is not necessary at small mines, yet a simple and reliable method is desirable. This should be in sufficient detail to be able to tell quickly the grade of ore, prices received for metals, costs per ton for mining and milling, costs per foot for development, upward or downward tendencies in costs, ore settled or in transit, cash on hand, stocks of supplies on hand, efficiency of labor, etc.

As in all accounting, there are two main divisions; that of revenue received for what is sold, and that of disbursements made for what is bought, so in mine accounting there is to be considered chiefly the income derived from sales of ore or concentrate, and the expenses incurred in producing these in a marketable condition. The cash and voucher-record, as a single book, preferably loose-leaf, has met with general approval in recent years as a combination of cash-book, journal, and voucher-register, and is the only record at the book-keeper's desk from which posting is done to the ledger. It is compact, convenient, and desirable, serving the purpose of gathering numerous items into their proper sections at original entry, and requiring that they balance before they are used in further calculations. This book may have columns for cash, bank-accounts, operating accounts, and various non-operating ledger-accounts. It seems scarcely necessary to do more than sketch the use of this record, since its cash columns correspond exactly to those of a cash-book, and journal entries are made in it double, as in a journal, the only difference being that the amounts are listed in columns so that they are easier to refer to and to total. Totals only are posted to the ledger, so that posting is a short and simple matter. This is done but once a month, after closing the month's operating accounts.

In expenditure a distinction is drawn between direct and indirect operating costs, the former being, as the term indicates, those incurred for actual handling of ore, and the latter those necessitated by the operation of mining in general. A large operating company has the following accounts for its smaller properties: 1. Direct.—(a) development; (b) ore-breaking and stoping; (c) timbering; (d) tramming; (e) hoisting; (f) sorting, weighing and loading; (g) draining. 2. Indirect.—(h) branch-office; (i) salaries; (j) general and New York expense; (k) insurance; (l) taxes; (m) laboratory; (n) marketing; (o) transportation. For a concern operating a mill, the number of accounts is increased by the addition of sampling, mill-experimental work, and milling. Only the last-named requires a further sub-division in order to give more definite information as to the work

and the efficiency of the various departments and machines. General expense, if care is not exerted, may become a dumping place for items which ought properly to be distributed to accounts to which they pertain. The heading 'miscellaneous' is practically taboo, except as the designation of a department in which details are shown.

The actual procedure in accounting for expense items comprises the following steps: (1) making the voucher; (2) entry in cash-voucher record; (3) entry in distribution book; and (4) summary on cost sheet or monthly report. A comprehensive survey of operations is completed by making up a financial statement, by adding the totals of income (separating the amounts according to the classes of ore sold, if desired) and deducting the operating expenses therefrom. This is made up and entered as a voucher also, the balance being charged into profit and loss account.

All charges to the power, mechanical or electrical and supply departments are divided at the end of the month according to the purpose for which the electric current or supplies were used, or the work done. For example, charges for current are pro-rated, according to kilowatt-hours or horse-power, to mine-compressors, pumps, locomotives, hoist-motors, framing-shed motors, sorting-plant motors, mill-motors for driving various machines, etc. In a similar way, mechanics' and electricians' time may be re-distributed by the use of cards specifying hours worked on this or that job, and repair parts used on the same. Thus proper charges may be made against the various motors, engines, and machines, cars, track, trolleys, lights—against any part of the plant, in fact, for the benefit of which this diverse work may be done. No hair-splitting is necessary or at all desirable.

Two other matters, which are closely related, naturally come under the control of the mine accountant, namely, the ordering of supplies, and the keeping of stock, and taking of inventories.

In adopting a system of accounting, a thorough study should be made of the conditions at the mine where it is to be installed, bearing in mind also the needs and desires of the management and the stockholders in the matter of reports. Once a system has been adopted, it should be adhered to religiously, and the seeming advantages of some different system should be well considered and tried out before any change is made.

SHOVELING is at its best in the lead and zinc mines of Missouri. A. G. Barton, superintendent of the Galena Booster mine at Neck City reports that a man named Tom Woodmaney shoveled 104 cans (52 tons) in an 8-hr. shift, went home, got married, and the next day shoveled 108 cans, or 54 tons.

WASHINGTON has an area of 69,180 square miles which is about the same as Missouri but less than half the area of California. Washington's population is 1,500,000, having trebled since 1900. Spokane, Washington, population 140,000, is a convenient centre for Coeur d'Alene mining.

*Abstract from paper by James E. Chapman prepared for the Arizona (September 1916) meeting of the American Institute of Mining Engineers.

Electrolytic Zinc

By Harry A. B. Motherwell

AT the present time when electrolytic zinc is occupying so prominent a place, the following notes on the Bradley-Williams process of zinc production as used in a demonstration run in 1910 may be of interest. The Bradley-Williams process was originally worked out on the ore of the Rhodesia Broken Hill mine, this being essentially a lead carbonate with zinc silicate and some carbonate. The lead content runs about 33% and the zinc about 15%, of which about one-fourth is present as carbonate. Very little lime or magnesia is present in the ore, but traces of copper, arsenic, and vanadium are found.

The process consists of leaching with an acidified solution of zinc sulphate, passing the solution through electrolytic precipitating-tanks fitted with lead anodes to deposit the zinc at the cathode, and returning the solution to the leaching-vats. A claim was made that "the leaching takes place, not only by virtue of the solvent action of the sulphuric acid, but by an electrified solution of zinc sulphate carrying powerful oxidizers."

This process is continuous and practically regenerative, requiring but a small amount of sulphuric acid to be added daily to account for that consumed by the carbonate of lime and sulphatization of some lead. The intention was to grow cathode zinc for as long a period as practicable, then to remove the cathodes, and by dipping into a bath of molten zinc melt off the surplus deposit of metal, and withdraw the cathodes ready to be put back in the deposition tank. A cast-iron bath, 6 ft. by 2 ft. 6 in. by 1 ft., was filled with pure zinc and kept at a proper temperature with its surface protected from undue oxidation. At intervals, zinc would be ladled from this bath and cast into ingots. An account of the difficulties encountered may be of interest.

The accompanying flow-sheet of the experimental plant shows five leaching-vats, one of which was filled each day, giving fully four days treatment, which time was sufficient to reduce to under 1% the zinc content of the tailing. The leaching-vats were fitted with a false bottom like cyanide-vats and need no description. The steady-head tank was to regulate the rate of flow and acidity of the solution of the precipitation-boxes. The anodes were of hard lead (6% antimony), the plates were 66 by 20 inches and $\frac{3}{4}$ -in. thick and the cathodes were of similar area, but of $\frac{1}{2}$ -in. rolled steel galvanized. The electrodes were spaced $\frac{3}{4}$ in. apart.

It was soon found that the surface line of liquid on the cathode became eaten down to the bare iron, and on dipping in the zinc bath, this line would not take on zinc without being first cleaned and pickled. It was impossible to pickle before dipping, as the rough zinc alongside the line destroyed the hydrochloric acid used, before the iron surface was clean. The water-line was then protected by a coating of varnish or paraffin wax, but it was found that if this protecting and insulating material extended $\frac{1}{2}$ inch below the surface of the liquid,

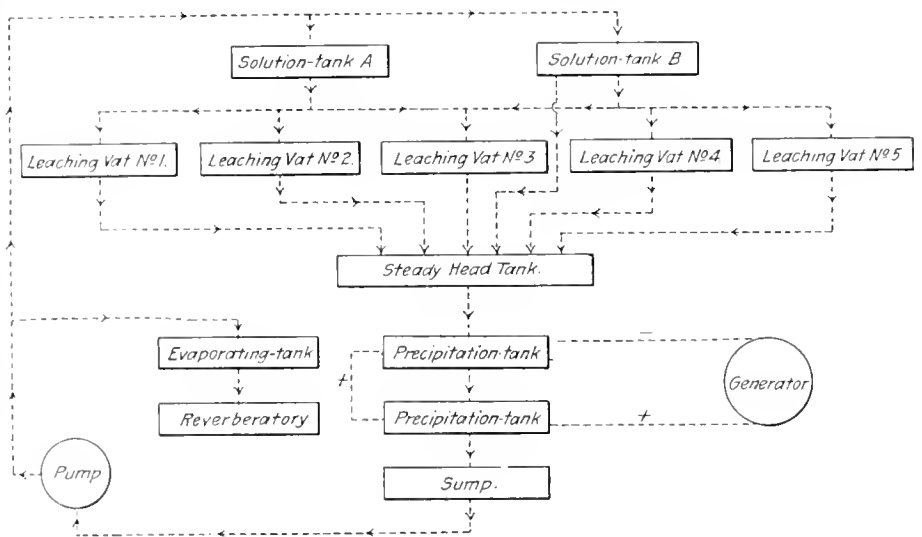

the increased C. D. along the junction of the zinc and paraffin quickly caused 'trees' to short across to the anode. This difficulty was overcome by raising the level of the surface of the liquid in the tanks by $\frac{1}{2}$ inch during the first 12 hours the plates were in use, thereafter lowering, by 12-hour stages, $\frac{1}{4}$ of an inch at a time, so that after the first 12 hours there was an increased thickness to be corroded. A considerable improvement, however, was made by changing the shape of the cathodes. These were cut-down so that they were completely submerged in the electrolyte, except for a piece at each end to make the connections (see Fig. 3). A very much better deposit was obtained on these.

The first plate was able to be kept in for over 50 hours, which was improved upon later. The gas seemed to escape from the top of the plate much better, and there was no 'treering' along the top. At first some trouble was caused by 'treering' along the bottom edge of the plate, this causing short circuits and consequent loss of power. This sprouting was also harmful in so far that all flakes of PbO_2 from the anodes were caught, and made short connections across, starting local action on the cathode; also those small pieces of PbO_2 would stick on the rough surface and contaminate the zinc

when melted. Eventually the anodes were cut $\frac{1}{2}$ inch less in depth than the cathodes. This remedied matters much by decreasing the C. D. along the bottom line of the cathode.

Another trouble arose with the feed of solution to the boxes. This incoming liquid, being heavier, went to the bottom of the box. The flow of solution, coupled with the arrangement of the electrodes parallel to it, caused bare patches of iron where the liquid first touched the cathode. This was righted by a baffle-board, causing the incoming liquor to first descend and then rise to the surface mixed with the liquor of the vat before it entered the compartment in which were the electrodes.

The next trouble arose with the anodes. After the plant had been about three weeks in operation, it was found that the anode plates were peeling badly: quite large flakes of PbO_2 , falling between the electrodes, were held resting against both anode and cathode. Whenever this happened the zinc on the cathode was dissolved quickly and a spot of bare iron appeared. Even if the flakes were removed, the damage was done, as the iron and zinc couple set up a local action, and the zinc on the cathode was rapidly eaten away, with large evolution of hydrogen gas. Once started, the patch of bare iron increased in area so rapidly that a few hours sufficed to dissolve all the zinc from one side of a cathode even with 40 hours growth on it. Careful watching of the boxes enabled many a cathode to be caught when the destructive work had just begun, but unfortunately there was trouble ahead still, for those injured cathodes when dipped would not take any zinc on the bare patches.

The shape of the cathode also led to considerable trouble.

The work was done in mid-winter in England. The zinc bath was at one side of a room and close against an interior brick wall. That wall retained some heat. When a sheet of steel $\frac{1}{2}$ inch thick and $5\frac{1}{2}$ ft. long was heated to the temperature of molten zinc, then hoisted above the bath and suspended there to drain and cool, it very naturally took a slight curve, as one side was exposed to the cold air and the other to the radiated heat from the wall. The cost of stripping, pickling, straightening, and re-galvanizing practically killed the method of collecting the deposited zinc, and the old practice of making starting sheets was adopted, that is, dipping in molten paraffin wax and then coating with graphite rubbed on with a brush, and stripping the deposited metal whenever it became necessary. The cathode sheet then required only re-graphitizing before being put back. Much time and trouble were saved and the plates were not buckled. With the spaces between electrodes so very small it is essential that the plates be quite straight. To overcome the trouble of short circuits due to flakes of PbO_2 , an experiment was tried by putting on each side of the anode a sheet of corrugated and perforated celluloid, such as is used in some batteries. This seemed quite satisfactory, but it is well worth noting that celluloid is highly inflammable and a spark across might

set it alight; therefore it should be totally submerged. Workmen about the lead anode tanks in a copper refinery occasionally have a firework display that teaches caution.

Why there occurred such heavy disintegration of the anodes was never quite decided. Probably many factors could be counted. Lead anodes after many years in use in a copper plant at a voltage of 2 showed little wear. At a voltage of under 2, however, only lead sulphate is formed; but bring the voltage up to 4 and peroxide is formed. Part of the rapid destruction may have been due to the presence in the ore of vanadium, which is a powerful oxidizer and accumulates in the solutions. The sump-solution gradually assumed a blue tint, which at first was supposed to be copper accumulating in the liquor. After a few days the characteristic changes from green to pale lavender were noticed, thus indicating the presence of vanadium. I held the opinion that much of the destruction of the anode was due to frequent stoppages of the current. The dynamo supplying current was driven by a motor that in turn derived its supply from the public mains. For some cause unknown, almost every other night the supply was either ceased for a few minutes or a fuse was blown, stopping the motor. With the tanks acting as accumulators or storage-batteries, or rather more correctly, acting as primary batteries, the current was reversed when the dynamo stopped. Each time this happened the loose peroxide would be thrown off on re-starting the dynamo. A somewhat parallel instance will be found in gold-refining by the Wohlwill process, where an improvement is made by sending simultaneously with the direct current an alternating one, which by its vibrations dislodges all the silver chloride from the anode as soon as formed. Copper had not accumulated in the solution to the extent of necessitating its removal before precipitating the zinc. In an account of Nordhausen's process of electrolytically refining zinc the following is stated: "The product handled is spelter ladled from the ordinary refining-furnaces nearest to the underlying lead. * * * Impurities taken into the electrolyte from anodes being precipitated by zinc-dust. If the spelter carries 1% copper, then 1.1% zinc is required on the weight of spelter used. The E. M. F. is 0.5 to 1.0 volt, and C. D. is 10.1 amp. per sq. ft." With soluble anodes, of course, a much lower voltage is required than with insoluble, as when depositing from a solution obtained by leaching ore. The voltage used was 4 and C. D. 9.5 amp. per sq. ft. of cathode area. Undoubtedly the efficiency was low, but many conditions had to be accepted as they were found. The main leads were copper rods 1.75 in. diam. (a sectional area of 2.4048 sq. in.), which with 1630 amp. = 677 amp. per sq. in. Taking 0.00266 lb. as theoretical zinc per ampere-hour, total amp., 1630; 11 cathodes; time, 92.33 hr.: zinc obtained, 19 lb., we get 35.24 lb. theoretical deposit and 53.9% efficiency. If we take it that usually the practical deposition is round about 80% of the calculated theoretical, then the 53.9 is raised to close on 70%

of the general work done. At the time of this efficiency test the electrolyte carried only 8% ZnSO₄·7H₂O in place of the usual 13%. The cathode was rolled steel $\frac{1}{8}$ inch thick, galvanized, waxed, and graphited. Eleven cathodes and 12 anodes were in each tank; electrodes were spaced $\frac{7}{8}$ inch apart; free acid was 0.25% H₂SO₄.

All these troubles in connection with the precipitation were finally overcome. The margin allowed in the matter of free acid-content is small. If allowed to fall below 0.1% free H₂SO₄ the deposit is of a dark color and

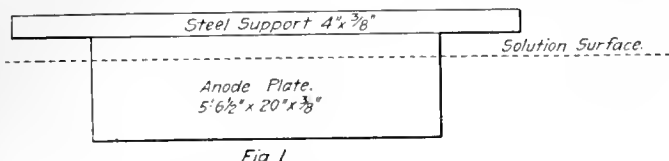

Fig. 1

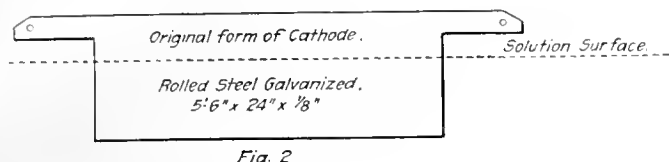

Fig. 2

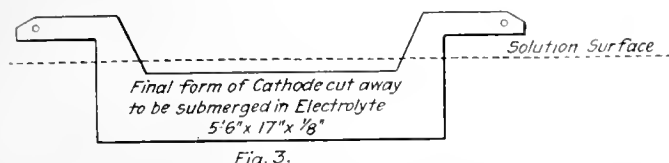

Fig. 3.

a spongy nature and carries considerable impurity. There is much loss by oxidation and formation of dross in melting a deposit of this nature.

With the quantity of solution on hand it was found that the electrolyte required to be fed to every second or third tank, as more than that in series (as to flow of solution) rendered it too acid for the later boxes. There is some doubt if it would be possible on this ore to produce a zinc of quality sufficiently pure to compete with the Brunner-Mond electrolytic zinc, but a high-grade spelter can be made. If the situation of the mine from which the supply of ore was obtained be considered, one would say that impure spelter was all that was desired, the obvious market being the Rand goldfield, where pure zinc is not wanted. The ore with 32% lead and 15% zinc, all as carbonate and silicate, is not wanted by any metallurgical plant, but tailing with the following approximate content seems quite desirable as a source of lead:

| | % | | % |
|--------------------------------------|------|----------|------|
| SiO ₂ | 16 | Zn | 0.8 |
| Fe | 11 | S | 1.2 |
| Al ₂ O ₃ | 5.5 | Pb | 48.5 |
| CaO | 0.25 | | |

The most serious difficulty encountered in the treatment of this ore lay in finding a method by which the electrolyte could be freed from accumulating silica. Much silica naturally passed into solution, and in time would present a serious problem on a large plant. This difficulty did not appear till after some months running, and, on the small-scale operation was met by withdrawing from circulation daily some of the sump-solution,

evaporating to a pasty condition, and baking hard in a reverberatory to dehydrate the silica. The product of the furnace was spread on top of the next vat undergoing treatment, and gave no trouble in leaching. It contained 34% silica.

Wolframite Mining in South Dakota

By Edward Manion*

†For years the Wasp No. 2 mine has been known for the low grade of gold ore extracted. It has also been known for some years that wolframite occurs in the mine, and in May 1915, it was found in commercial quantities. Since that time the company has mined 184 tons, averaging 45% tungstic acid. The wolframite occurs along fissures in the flat Cambrian quartzite.

The ore is taken to the ore-house, sorted, cobbled, crushed to about $\frac{1}{2}$ in., sampled, and sold to the highest bidder. For the first shipment, which was made in July, \$8 per unit was obtained for material carrying 48% tungstic acid; for the last shipment, in December, \$51 per unit for 47% product.

A concentrating plant was recently constructed to treat the low-grade ore. This ore is crushed to $\frac{1}{8}$ -in. mesh by rolls, and from there it passes through a trommel of 16-mesh. The oversize goes to a jig, then to a small set of rolls, returning to the trommel. The undersize from the screen goes to a cone-classifier, from which the agitated slime flows to canvas tables, and the sand to Wilfley tables. The sand from the latter goes to a 4 by 5-ft. ball-mill, discharging into an 8-in. elevator, which raises and returns the re-ground sand to the classifier. Slime goes from the classifier to nine 4 by 60-ft. canvas tables, which catch the concentrate, the slime passing to a launder at the end of the tables, and from there to an 8-in. elevator, which deposits the treated slime into a 420-ton tank as tailing. The tailing that is high in gold is treated by cyanide.

Three grades of concentrate are produced, namely, 65%, 45%, and 35% tungstic acid, the last being slime from the canvas tables.

CHUTES for loading ore from the stopes into mine-cars have been lined with concrete in heavy ground in the Copper Queen mine. These are long chutes that concentrate the ore from two levels to a haulage-level. One concrete-lined chute used for 20 months required relining due to wear by sharp ore. For most of their height these chutes are 3 by 3 $\frac{1}{2}$ ft. but are enlarged, for 30 ft. at the bottom, to 8 ft. by a maximum of 30 ft., in order to hold 90 tons of ore, there being an offset of several feet at the enlargement to make a baffle for the ore to fall upon, checking its downward velocity. The pile of ore is not allowed to extend up into the raise, which serves only as a passageway.

*Superintendent, Wasp No. 2 mine, Flatiron, South Dakota.

†Abstract from *The Pahasapa Quarterly*, South Dakota School of Mines, Rapid City.

Saving Fine Gold

Some gravels contain gold so fine that only a small amount is saved. The gold from the Snake River alluvial flats in Idaho is 945 parts fine, and the particles are so small that it takes from 1000 to 2000 colors to equal one cent, according to J. M. Hill in Bulletin 6204 of the U. S. Geological Survey. The largest pieces of gold are scarcely 0.01 in. diameter, while many can only be distinguished by a high-power microscope. The larger flakes are cupped. Most of the gold is bright-yellow, but some is red-brown, due probably to a coating of iron hydroxide.

Along the course of Snake river can be seen the wrecks of numerous attempts to extract the fine gold from the gravels. The remains of dredges are seen here and there, and many more have been removed. Countless process machines have been tried there, but so far as known without success. Most of these machines have depended on amalgamation, but many different methods have been used to get the quicksilver and gold into contact.

The rocker and sluices are still used, and a sluice of special type, known as the burlap-table, used also on some of the dredges, has proved one of the best appliances for saving the fine gold. This is shown in the accompanying sketch. In working with burlap-tables the main sluice leading from the working A, is set at any convenient grade. Near the lower end is a section with a perforated-steel bottom B, which allows the fine heavy sand and gold to drop through to sluices set at right angles to the line of the main sluice. The transverse sluices C, are in reality launders which deliver the sands to a series of burlap-tables E. Each burlap-table is from 16 to 30 ft. long and 3 or 4 ft. wide. It is usually set at a grade of 1 to 12 in., but the grade needs to be adjusted to meet different conditions. Most tables are built with two drops at least. The pulp from the launder-slui-ces is fed to the burlap-tables through adjustable openings D, so that it flows over the table in a thin, even sheet. The heavy sand and gold are caught by the rough surface of the burlap, and the light sands run to waste. In some places the tailing is re-run. In operation, the tables are cleaned as often as necessary, by taking up the burlaps and washing them in tubs of clear water. The concentrate, together with that washed from the bottom of the tables, is either placed in a grinding-pan or revolving barrel, for treatment with quicksilver and weak cyanide solution, or cleaned with a rocker. The latter method, while attaining somewhat better results than the simple rocking of the gravels, is not efficient. In some of the burlap-tables the first section of the table—that nearest the launder-slui-ces—has a silver-plated copper-bottom coated with quicksilver, for amalgamating the gold. In the sketch six tables are shown on each side of the main sluice. The number of tables varies with different conditions. In some places all the tables are on one side of the main sluice. In fact, each operator has his particular design of table and method of handling the gravel.

Both suction-pump and bucket-dredges have been used

for lifting the gravels. Probably the most successful dredging operation on the river was the Sweetzer-Burroughs dredge, which was operated 30 miles west of Minidoka. The first boat built by this company, in 1894, was of the suction type, but the company later constructed a bucket-dredge having a capacity of 2000 cu. yd. a day. Concentrate from burlap-tables was amalgamated in barrels. It is estimated that the cost of handling the gravel was from 4.5 to 5.5c. per cubic yard.

Within the last few years experiments in cyaniding the gravels of the Snake river, while not a financial

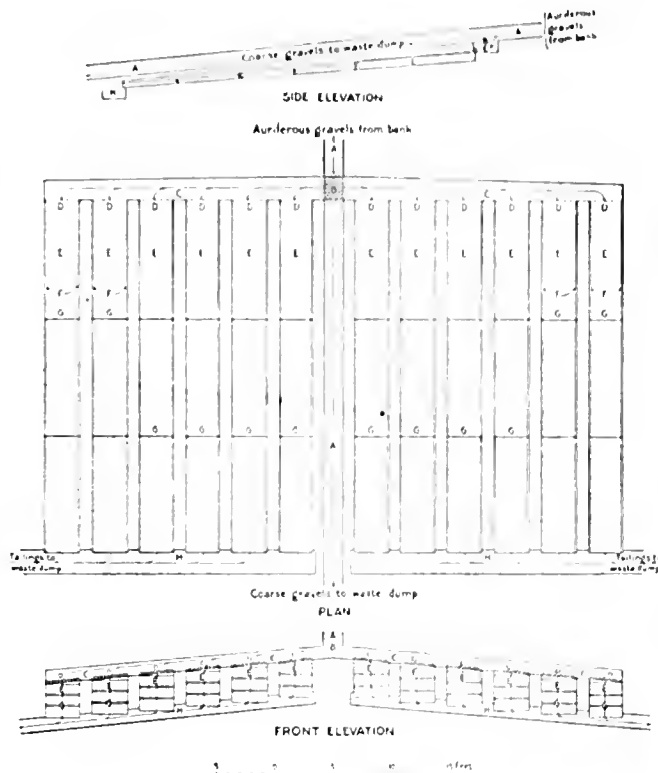

DIAGRAM OF BUREAP-TABLE FOR SAVING FINE GOLD.

success, have at least shown that the method has merit. At a plant 16 miles south-west of Blackfoot, the gravel was screened through a $\frac{3}{16}$ -in. mesh trommel. All the undersize was leached; no difficulties were met with in the leaching-vats.

ELECTRIC PLUNGER-PUMPS were discussed by Chas. Legrand of Douglas, Arizona, at the San Francisco meeting of the A. I. M. E. in September. He stated: "I prefer the vertical type of electric plunger-pumps as giving more even wear on packing and plungers and taking less floor space, although requiring more head room."

VANADIUM ORE is being mined at Vanadium, San Miguel county, Colorado, by the Primos Chemical Co. This, it is said, is the only active vanadium mine in the United States, although, of course, the carnotite mines produce vanadium as a by-product with radium.

BUOY. To keep from sinking, to keep afloat in a liquid.

Geology of Tungsten Deposits

By J. J. Runner*

† **A**LTHOUGH relatively a rare metal, tungsten is, contrary to popular opinion, widely distributed in nature. It is known to occur, although not in commercially important quantities in 19 of our States and in Alaska.

Tungsten occurs chiefly as the tungstates of iron and manganese, or of calcium, in the minerals, ferberite, wolframite, hübnerite, and scheelite. The difference between the first three of these minerals is of scientific rather than technical value; hence they will be discussed together.

Ferberite, wolframite, and hübnerite form an isomorphous series from FeWO_4 to MnWO_4 . When the mineral is pure FeWO_4 , or contains only a small percentage of manganese, it is called ferberite. Hübnerite is pure MnWO_4 , or may contain a small percentage of iron. Wolframite is $(\text{FeMn})\text{WO}_4$, in which the ratio of iron to manganese is more nearly 1:1 than in either of the other two. The following analyses will serve to illustrate:

| | Tungstic oxide. | Ferrous oxide. | Manganous oxide. |
|------------------|--------------------|-------------------|---------------------|
| Ferberite | 75.68 | 24.47 | 0.12 |
| Wolframite | 76.00 | 16.00 | 7.70 |
| Hübnerite | 75.58 | 0.25 | 23.40 |

It will be noted that in all of these the percentage of tungstic oxide is nearly 76.

The minerals of this series vary from dark-brown in the varieties high in manganese to nearly black in the ones rich in iron. The streaks are dark-reddish brown to brownish-black. The common forms are tabular masses, disseminated grains, and in columnar crystals. Cleavage is perfect in one direction at right angles to the direction of elongation in the tabular forms. The hardness is about that of ordinary glass, the hardest being those rich in manganese. Specific gravity ranges from 7.2 to 7.5, the varieties high in iron being the heaviest. Lustres are sub-metallic. Among minerals frequently mistaken for the minerals of the wolframite series are hematite, magnetite, graphite, columbite, and cassiterite. The first three may be readily distinguished by their inferior weight and the last two by their inferior cleavage.

Scheelite, the tungstate of lime, CaWO_4 , occurs in double-ended square pyramids and in massive forms. In color it is white, pale yellow, pale brown, greenish, or reddish. Its lustre is vitreous; the cleavage fairly good in four directions; the hardness is about 5 or less than that of ordinary glass; specific gravity about 6. Most

specimens are translucent or transparent. It may be distinguished from the other minerals resembling it in color by its superior weight.

Other minerals of tungsten are:

Cupro-tungstite, CuWO_4 , tungstate of copper.

Cupro-scheelite, CuCaWO_4 , tungstate of copper and calcium.

Stolzite, PbWO_4 , tungstate of lead.

Powellite, $\text{Ca}(\text{MoW})\text{O}_4$, tungstate and molybdate of calcium.

Tungstite, WO_3 , oxide of tungsten.

Meymacite, hydrous-oxide of tungsten.

The world's commercially important deposits of tungsten are almost wholly confined to the following five modes of occurrence: (1) quartz veins; (2) pegmatite dikes and tin-stone veins; (3) placers; (4) contact zones on the borders of intrusive igneous rocks; and (5) replacement deposits. Of these the first three are far the most important.

Among rocks, granite, granitic gneiss, and their fine-grained equivalents, are by far the most common associates of tungsten deposits. In some cases the orebodies lie wholly within these rocks, in other cases they extend into slate, quartzite or other rocks at the side, but in a majority of cases igneous rocks of the acidic type are to be found near-by. This applies with equal truth to each of the five types of occurrence. Tungsten deposits are usually in or in close proximity to metamorphic rocks also, such as slate, schist, quartzite, or crystalline limestone, for the very intrusion of the granite itself has in many cases brought about the metamorphism.

The mineral associates of tungsten also are well defined and characteristic. It is commonly accompanied by one or more of the following: quartz, muscovite, cassiterite, topaz, tourmaline, fluorite, beryl, biotite, bismuth, molybdenite, pyrite, arseno-pyrite, chalcopyrite, galena, sphalerite, gold, silver, and graphite. In the orebodies the tungsten minerals may occur finely disseminated and scattered through the gangue; they may occur in masses of various sizes up to a weight of many pounds, irregularly distributed throughout the orebody, or they may appear as crystals lining cavities. Many veins exhibit a banded structure with the tungsten minerals concentrated in definite layers, especially along the vein-walls.

Some interesting characteristics of a few of the commercially important deposits are as follows:

Those of Boulder county, Colorado, the principal source of tungsten in the United States, lie on the eastern slope of the Front range of the Rocky Mountains, about 30 miles north-west of Denver. The veins are

*Professor of Mineralogy, South Dakota School of Mines, Rapid City.

†Abstract from *The Pahasapa Quarterly*.

narrow fissures in granite and in porphyry dikes, accompanied in places by breccia. The ore mineral is ferberite, finely disseminated through quartz or lining cavities. The deposits have been opened to a depth of 600 ft. and are said to show no signs of impoverishment.

Second in importance among American occurrences are the deposits of Atolia, in San Bernardino county, California. Here the ore mineral is scheelite, in seams and veins varying from thin stringers to widths of four feet, in grano-diorite and schist. The gangue consists of quartz, calcite, and crushed country-rock. The ore is at present being mined down to 600 feet.

In the Dragoon mountains of Arizona hübnerite occurs in vertical quartz veins in granite, with a little muscovite and fluorite. The hübnerite occurs distributed through the quartz in tabular masses, some reported to weigh 500 lb., and in layers along the vein-walls. In the Arivaca district of the same State, hübnerite occurs in tabular masses and blade-like crystals in gold-bearing quartz veins.

In White Pine county, Nevada, hübnerite and scheelite occur in quartz veins occupying fault-fissures, associated with fluorite, pyrite, muscovite, and minerals of copper, lead, zinc, and silver. The veins range from thin stringers to thicknesses of 11 or 12 ft.; some are very rich.

In the northern Black Hills of South Dakota deposits of wolframite lie in the Cambrian dolomite, associated with the flat-lying masses of refractory silicious ores, north of Lead, and on the divide between Yellow and Whitewood creeks south-east of Lead. The wolframite appears in flat, horizontal, but irregular masses, and in many places seems to form a rim around the silicious ore-shoots, except on the under side. In other places it is found in thin stringers. Its mineral associates are pyrite, fluorite, barite, and occasionally gypsum.

Near the granitic area of Harney Peak in the southern Black Hills, wolframite exists in pegmatite. Similar occurrences have been found near Tinton in the Nigger Hill district. In the southern hills also, quartz veins bearing wolframite, tourmaline, muscovite, and graphite are being worked for their tungsten content. The veins dip steeply, cut across the bedding of the slate for the most part, in lenticular masses from a few inches to 2 or 3 ft. wide. The wolframite is inter-grown with quartz in tabular masses in places estimated to weigh 8 or 10 lb. Many of the veins show a banding parallel with the walls.

In Burma and the Shan States, which have become the world's greatest producers of tungsten, the ore is wolframite, found as nodules and granules in alluvial deposits. The parent lodes lie at the northward extension of the granitic backbone of the Malay Peninsula, which farther south has furnished the great tin deposits of the Malay States. In these lodes the wolframite is associated with quartz and tin-stone. At present mining is confined to the placers.

In Portugal, which ranks third as a producer, wolframite is accompanied by scheelite and tungstite, in veins and stockworks, with cassiterite, pyrite, chalcop-

pyrite, arsenopyrite, and often mica, tourmaline, and fluorite.

In Cornwall, greenstones and slates have been intruded by granite, and these in turn by dikes of quartz-porphry. The mineral-bearing lodes are for the most part parallel with the dikes, and in many places occupy fault-fissures. Impregnations of country-rock along the lodes are common. Within the lodes the ore is irregularly distributed in bunches and pipe-like masses. The ore mineral is chiefly wolframite, with which is found cassiterite, pyrite, arsenopyrite, chalcopyrite, quartz, feldspar, and tourmaline. Locally, ores of nickel, cobalt, lead, zinc, and uranium are found in the higher levels, while antimony, bismuth, and molybdenum have been produced in commercial quantities. The wolframite follows contacts between granite and slate.

In Spain deposits of wolframite are found in quartz veins with scheelite, cassiterite, mica, rutile, and feldspar cutting gneiss and gneissic granite, and in alluvial deposits derived therefrom.

In Bolivia wolframite is found in veins associated with cassiterite, bismuth, copper, and silver.

In Peru hübnerite occurs in veins following contacts of granite with slate and quartzite.

In Queensland and New South Wales wolframite occurs in quartz veins, in greisen, and in placers with chlorite, muscovite, biotite, topaz, fluorite, beryl, cassiterite, and bismuth and molybdenum minerals. The production of these two Australian States is of considerable importance.

The persistence of tungsten deposits in depth and the maintenance of metal-content are questions of vital importance. Unfortunately but few deposits have been developed sufficiently to determine their true nature, so that we have not enough data upon which to base definite conclusions.

CALUMET & HECLA drilling practice, with the Carr bits on hollow inch steel used in mounted hammer-drills, employs a $\frac{1}{16}$ -in. difference of gauge for each 22-in. change of steel, says the *Canadian Mining Journal*. On the Osceola lode, the difference in gauge for $\frac{1}{2}$ -in. steel is only $\frac{1}{16}$ -in. for every second change or 44 in. For the tough, irregular conglomerate ore, as distinguished from drilling in amygdaloid and trap-rock, piston-drills are retained; the gauge is changed $\frac{1}{16}$ -in. every foot, and a 'cross-Carr' bit has been devised for the conglomerate in which the single bit tends to fitcher. These improvements have increased the efficiency of the miners 40%, as the drilling speed varies inversely with the volume of rock cut or as the square of the diameter of the hole, and the reduced gauge has made it possible to start a hole with a much smaller diameter. Apart from this, the Carr bit drills but little faster than the ordinary cross-bit. No lugs are used on the steel for mounted hammer-drills but anvil-block chucks and plain shanks are employed. By drilling deeper holes for stoping (12, 14, and 16 ft. in amygdaloid and 10 ft. in conglomerate) a saving of 20% is made in dynamite.

The Flotation Process—II: Processes

By T. A. Rickard

THE application of the physical principles outlined in the foregoing paragraphs has taken diverse forms, as expressed in scores of inventions, only a few of which have been developed into workable processes. The phenomenon of surface tension is used directly in the so-called skin-flotation methods of Hezekiah Bradford, Arthur P. S. Macquisten, and Henry E. Wood. In the first of these, invented in 1886, the pulp flows down an inclined plane onto the quiet surface of water in a vessel, so that the sulphide particles float forward under the impetus of their descent while the gangue particles sink. See Fig. 2. The explanation is that sulphides, by exposure to the atmosphere, attach films of air to themselves, so that they are not wetted and move over the so-called water-skin, while the gangue, which has remained wet throughout the operation, sinks through the surface to the bottom of the vessel.

Macquisten applied the same idea in a tube cast with a helical groove and revolved at a moderate speed. In 1906 this method was adopted in the Adelaide mill, at Golconda, Nevada. The ore contained 2.2% copper as chalcopyrite, with pyrrhotite and pyrite, as well as some blende and galena. The gangue was quartzose, containing spinel and garnet. The tubes were of cast-iron, 6 ft. long, 1 ft. inside diameter, and each weighed 450 lb. See Fig. 3. Externally these tubes were cast with two tires, which rested upon supporting rollers. The discharge-end was entirely open. The feed-end was closed except for a hole in the centre large enough to admit the pipe through which the pulp entered. Internally the tube was cast with a helical groove of $\frac{3}{4}$ -inch pitch, which was changed subsequently to $1\frac{1}{2}$ -inch pitch. The discharge-end was connected with a separating-box, the joint between this and the tube being water-tight, while the tube was free to revolve. At the side of the separating-box, directly opposite the discharge from the tube, an opening or lip was cut for the overflow of the surface layer of water, carrying the floating mineral. This opening regulated the depth of water in the tube. The bottom of the opening was three inches above the inside bottom of the tube, so that there was three inches of water in the tube; the feed and the discharge were so regulated that the water passing over the lip was about $\frac{3}{8}$ inch deep. The tube was rotated at 30 r.p.m. in a direction corresponding with the helix of the interior. As Mr. Ingalls said: "The pulp is thus screwed through the tube and in its advance is repeatedly given an oppor-

tunity to slide upon the surface of the water, where it may be retained by surface tension." The ore was crushed to pass 30 mesh. The capacity of each tube was 5 tons per 24 hours, and 25 tubes were in use. A concentration of 11:1 was effected on a 2.2% copper ore, the tailing assaying 0.2%; but this refers only to the deslimed ore, that is 70% of the supply, so that the actual extraction was only 63%. The inability to treat

(No Model.)

2 Sheets—Sheet 1

H. BRADFORD.

METHOD OF SAVING FLOATING MATERIALS IN ORE SEPARATION.
No. 345,951. Patented July 20, 1886.

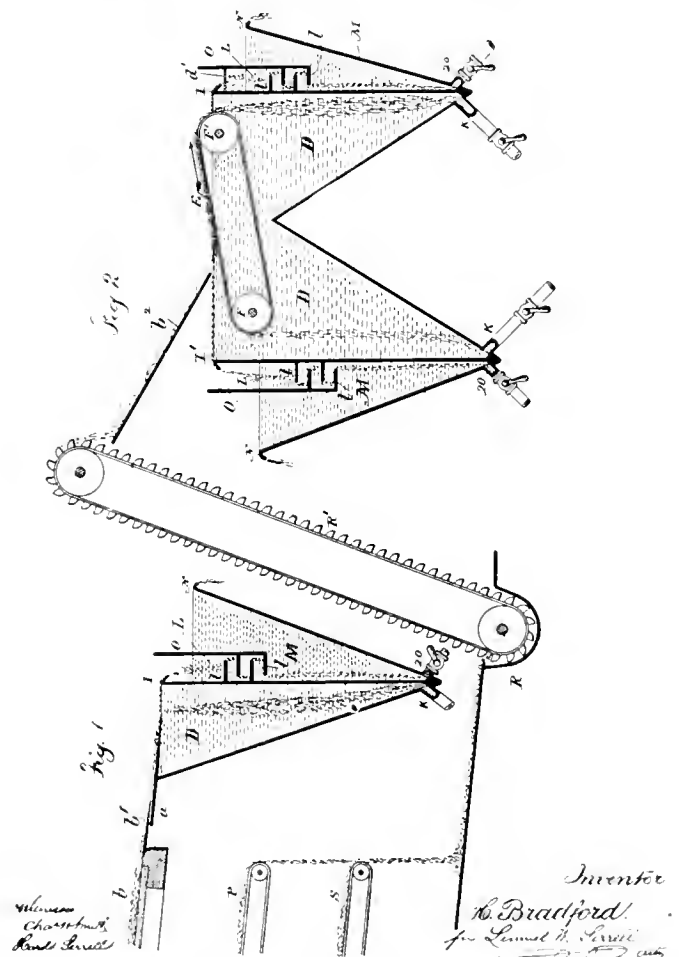

FIG. 2. REDUCED FACSIMILE OF BRADFORD PATENT.

slime is a notable defect of this ingenious method of flotation.

Wood's method is equally interesting. The ore is crushed dry to 30 or 40 mesh and is then fed in a thin stream from a vibrating plate onto the surface of water in a tank to the surface of which a forward movement is given by small jets, also of water. By a combination of the capillary attraction and the pressure of a con-

*Part of a paper under the same title read before the March 1916 meeting of the Canadian Mining Institute.

†The whole of the above description is taken from the admirable technical article by W. R. Ingalls in 'Concentration Upside Down,' *E. & M. J.*, Oct. 26, 1907.

stant feed, the sulphides are caused to move forward as a definite elastic film on top of the water. This film of mineral passes over an endless canvas belt, which emerges from the tank at a particular angle, varied according to the kind of mineral to be saved. The belt with its film of sulphides passes over three rollers so that its motion is reversed when it strikes the water-level of a second tank, where it releases its valuable burden.² Very little gangue in suspension comes over, as the water drains back into the main tank. Any submerged particles that have been accidentally wetted or are so heavy that they have penetrated the surface-film, pass to standard concentration-tables, on which they are separated by gravity in the ordinary way. In the case of molybdenite and graphite, the film concentrate is still further cleaned by being passed over a nearly vertical screen. Gangue in suspension passes through, while the flat crystals of the valuable minerals slide over the screen, which largely dewater them. The flotation concentrate is collected and dried as usual. See Fig. 4.

Mr. Wood is using his own process to commercial advantage in the treatment of molybdenite ore, at Denver. The Macquisten tube is still in use at Mullan, Idaho; but the Bradford patent is only of academic interest. These methods have been confused with the more recent flotation processes; they ought to be differentiated. I suggest therefore that they be classed under 'film-suspension,' for it may be taken that in every case the sulphides are carried with air over the tensional film on the surface of the water.

Incidentally, it may be well to point out that although it is convenient to speak of the 'water-skin' and of 'skin-flotation,' the use of either 'skin' or 'film' is inaccurate. A skin is a thing of definite thickness, which therefore can be 'peeled' off, like the epidermis, for example. The phenomenon of surface tension involves nothing of the kind. It refers to a condition of molecular forces at the surface of a liquid, the effect of which can be only one molecule thick. Thus, 'water-skin' and 'skin-flotation' stand for water-surface and surface-suspension.

Neither Bradford nor Wood uses oil or acid, but in the later applications of the Macquisten tube both have been introduced. As the ore contains carbonates that would react with the sulphuric acid so as to liberate carbon-dioxide gas, it is obvious that another factor is introduced, namely, the bubble idea, which has proved so potent in the more recent phase of flotation. The further addition of oil marks a distinct departure from the first idea of the inventor, causing the process to resemble those of Potter, Delprat, and De Bavay.

The methods of these three Australians were alike designed to treat Broken Hill tailings, containing zinc-lead sulphides in a gangue composed partly of carbonates, notably calcite, siderite, and rhodochrosite. Charles V. Potter used water containing from 1 to 10% sulphuric acid, which was added to crushed ore placed

in a vessel (see Fig. 5) provided with stirrers (*B'* the shaft and *B* the arms.) Heat was then applied by gas (3); whereupon the metallic particles rose to the surface of the liquid. It has been said that "it is clear that he (Potter) had in view a surface tension process."³ If this is meant as a reference to the surface-suspension method, say, of Bradford, it is incorrect. Surely Potter used bubble-levitation as his principal effect. The gas generated by the action of the acidulated water on the carbonates joined with the air entrained by the ore is furnishing gas for making bubbles, this result being assisted further by the stirring of the pulp and the heating of it.

G. D. Delprat had an apparatus suggesting the employment of surface suspension, but he also used chemicals to induce flotation. See Fig. 6. By the addition (through the pipe 5) of a hot solution of acid salt-cake to the crushed ore as it was fed (from the chute 1) upon a pan having a sloping bottom (4) heated by a Bunsen burner (14), the sulphides were made to rise to the surface of the vessel (at 3, passing forward along 13), while the gangue collected in a sump (10). In this case also the flotation was the result of forming bubbles of carbon-dioxide gas and of air by chemical action and heat.

Auguste J. F. de Bavay described a process in which a thin stream of freely flowing pulp was delivered upon the surface of a vessel of water, after the style of Bradford. The description of the method as used subsequently on the North Broken Hill mine does not correspond with this, for in that plant the mill-tailing, relieved of slime, is said⁴ to have been fed into a vessel provided with a mixing device, run at a high speed, so as to agitate the acidulated pulp. The sulphides rose to the surface, much in the same way as in the preceding methods of Potter and Delprat. That of Potter was used, in a modified form, at the Block 14 mine at Broken Hill in 1905 and 1906, while the Delprat process has been in use for several years successfully at the Broken Hill Proprietary mine. It is proper to add, however, that all of these acid-flotation methods are now only of academic interest. In the chief application of these processes it has not been customary to use oil, but as the material treated came from old dumps of tailing it may be assumed that there was some substance present capable of modifying the water sufficiently.⁵

The first application of any of the oil-flotation processes on a working scale in a mill was that made at the Glasdir mine, near Dolgelly, in Wales, by Francis E. Elmore in 1899. The mixture of crushed ore and water was fed⁶ at the upper end of a slowly revolving drum,

²'Concentrating Ores by Flotation.' Page 9.

³*Ibid.* Page 115.

⁴This suggestion is made by Mr. Hoover in his book. On page 101 he says that "there may be organic substances in the ore which, upon the addition of acid, yield gummy compounds that selectively adhere to the ore." By 'ore' here he probably means 'sulphides,' that is, the blende and galena.

⁵Charles M. Rolker. 'Notes on the Elmore Concentration Process.' Trans. Inst. M. & M., Vol. VIII (1899-1900), pp. 379-384.

⁶From particulars given to me by Mr. Wood himself. See also Trans. A. I. M. E., Vol. XLIV (1912), pp. 684-701.

provided with annular helical ribs and transverse blades, so as to effect the mixing of the pulp and the oil without producing emulsification. See Fig. 7. The oil was intro-

duced through a separate pipe. The mixture was discharged into a V-shaped vessel, where the water and sand subsided while the oil buoyed the sulphides to the top. An oil-residuum having a specific gravity of 0.89 was used in equal parts by weight with the ore, ton for ton. The oil was so viscous as to require the aid of small rotary pumps to propel it forward. The temperature of the oil and water was kept between 54° and 57° F. The loss of oil was 2 gallons per ton of ore. A concentration of 14:1 was achieved with a recovery (in the concentrate) of 69% of the gold, 65% of the silver, and 70% of the copper from a pyritic and chalcopyritic ore assaying 1.12% copper, 0.049 oz. gold, and 0.8 oz. silver per long ton. The process was described as "a somewhat dirty and nasty process." It did not work on oxidized or earthy ores, nor upon tarnished sulphides.

the oil was 25%, as against the theoretical load of 10% inferred by Mr. Rolker. In short, the oil did 150% more than anybody could explain. The 'prior art' was in the dark, but the posthumous art of today can make a confident guess. Of course, the larger part of the levitation was done by air, entangled previously in the ore particles or entrained subsequently during the mixing of the pulp with the oil in the drum. Later investigators can testify how difficult it is to prevent the indrawing of air under such circumstances. Therefore even in this beginning of flotation as a practical process the agency of air was utilized, although unwittingly. Four years later Walter McDermott, who has been a consistent supporter of the Elmore brothers in their flotation business, acknowledged that "the agitation with the pulp results in the oil taking up a very appreciable quantity of air."

This fact was not recognized at first, but in 1904, six years after the first bulk-oil patent of 1898, Francis E. Elmore took out his patent for vacuum-oil flotation. See Fig. 8. In this he subjected the oiled and acidulated pulp to a vacuum, thereby releasing the air

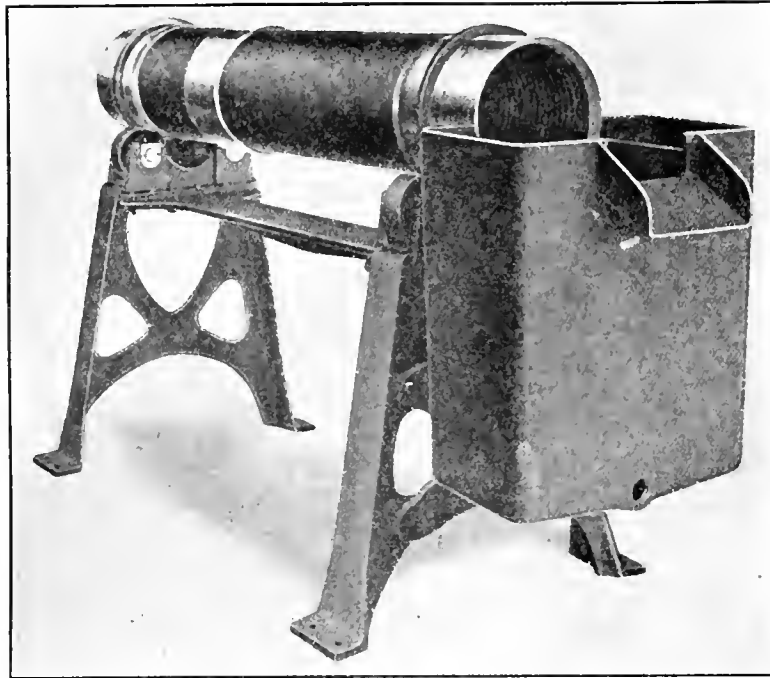

FIG. 3. THE MACQUISTEN TUBE.

In the course of the discussion following the reading of the paper by Mr. Rolker from which these facts are gleaned, it was acknowledged that the process developed by Mr. Elmore was based on previous experimental work done, at the same mine, by George Robson, who used petroleum in even larger proportion, as much—I have been informed—as three tons of oil to one of ore. But the most interesting fact elicited by the discussion was the statement made by Mr. Elmore, and confirmed by the superintendent of the mill, John Bevan, that the actual load of mineral on

dissolved in the water. The air thus held in solution amounts to 2.2% by volume, at sea-level and 60° F. By 'The Concentration of Ores by Oil,' *E. & M. J.*, February 14, 1903, page 262.

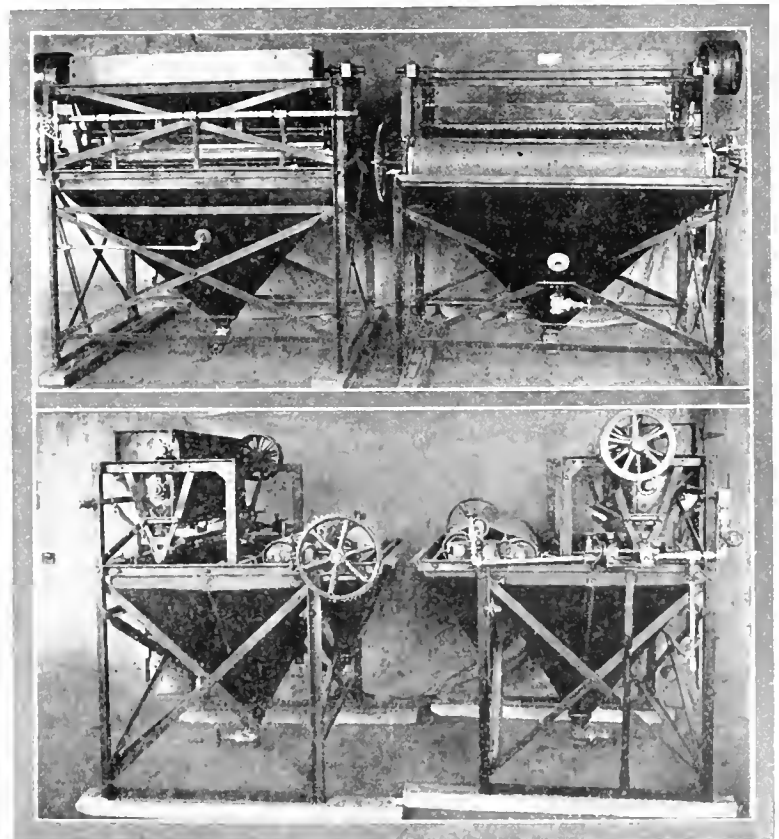

FIG. 4. THE WOOD MACHINE.

By 'The Concentration of Ores by Oil,' *E. & M. J.*, February 14, 1903, page 262.

lowering the pressure and raising the temperature this air is released, thereupon attaching itself, in the form of bubbles, to the oiled sulphide particles, which rise to the surface. For example, the air in a pulp of 1 ton of ore to 6 of water suffices to lift 360 lb. of zinc-lead sulphides in a Broken Hill ore.⁷ In actual practice, however, the weight of sulphides floated is considerably greater than the theoretical capacity, as based on the efficacy of the air released from solution in the water. Part of the work is done by the gaseous carbon dioxide liberated by the reaction between the acid and the carbonates, such as calcite, either in the gangue or added in the form of limestone. Part of it is entangled in the ore particles and part of it is entrained into the pulp during mixing. In this process the quantity of oil added to the pulp was reduced to 10 lb. per ton and finally, in some cases, to as little as 3 lb. per ton of ore. The machine devised by Elmore was remarkably ingenious and to it the success of the process was largely due. It was applied at many mines, notably the Sulitelma copper mine, in Norway.⁸

The Potter-Delprat and the Elmore vacuum processes are clearly based on the activity of bubbles of carbon dioxide or air, or both. Next, mention must be made of Alcide Froment, who, although he was not the inventor of a working process, introduced the idea of violent agitation for the purpose of producing bubbles of gas rapidly from a pulp containing both calcite and acid. While he looked to carbon dioxide as the gas from which to make his bubbles, he did undoubtedly entrain lots of air and obtained the use of it in generating the bubbles that attached themselves to the oiled particles. He did not recommend much oil; only "a thin layer." In his later instructions to the Minerals Separation company, which bought his British patent in 1903, he specified that the oil was to be from 1 to 3½% on the ore.

The next method was that invented by Arthur E. Cattermole, also in 1902. It was to buy his patents that the Minerals Separation company was organized in 1903 by John Ballot, J. H. Curle, W. W. Webster, S. Gregory, H. L. Sulman, and H. F. K. Picard. Cattermole departed from the prior art. Instead of floating the sulphides, he sank them, while the gangue was assisted to rise in an upward current of water. He added oil in the proportion of 4 to 6% "of the weight of metalliferous mineral present in the ore," together with 2% of soap, so as to obtain an agglomeration of flocculent sulphide particles, which, being heavily oiled, stuck to each other, in groups or granules that sank to the bottom. He used a Gabbett's or cone-mixer, to obtain a violent agitation of the pulp, and followed it by a gentler stirring during which the separation into "shotty granules" was effected in the presence of as little air as possible.

This process was only put to work in one mill, on the Central mine at Broken Hill, where it must have seemed

a metallurgical abortion during the very short time it was in use. The oil was emulsified with soft soap and then fed into the mixers, where the crushed ore underwent agitation with acidulated water. From the very start a considerable proportion of mineral was floated on the froth incidental to violent mixing in the presence of air. Apparently only a part of the sulphides was 'granulated,' so as to sink according to program. The remainder was floated unintentionally. The description given by the manager, James Hebbard, indicates that he and his staff stumbled upon the so-called agitation-froth process almost immediately. He records¹¹ how he discovered that more froth was made by using less oil, and that the frothing and floating proved a better method than the granulating and sinking of the sulphide particles. He also states that the discovery was made concurrently by the metallurgist¹² of the Minerals Separation company in the London laboratory. They hit upon the same idea by varying the quantity of oil, in March 1905, so we are told. Yet the plant at the Central mine was allowed to start on the Cattermole process in July. Successful tests with the frothing process were not made until September, the proportion of oil being reduced from 3% when granulating to between 0.15 and 0.2% when frothing. The plant was gradually changed until granulation was completely ousted, by decreasing the quantity of oil and increasing the violence of agitation. The ore from the mixers was passed with "a good splash" into spitzkasten, thereby accentuating the need for aeration.

So the failure of the Cattermole method is stated to have led to the Minerals Separation process of today, the proprietary rights to which are based primarily on U. S. patent No. 835,120, dated May 29, 1905. This is a process "wherein, by the use of a frothing agent, and in the presence of such agitation as will maintain or produce distribution of the ore particles through the pulp, and dissemination of bubbles of air through the pulp and into contact with the metallic particles through the pulp, the air bubbles will seize the metallic particles and will carry them to and through the surface of the pulp, so as to permit of their delivery at or above the surface of the pulp separate from the gangue particles." This description is taken from the complainant's brief in the suit of Minerals Separation, Limited, v. Miami Copper Company, 1915. It is further explained that in this process "the frothing agent is an oil or immiscible liquid, and the discovery was that this mode of operation in the concentration of ores was attainable with small quantities of oil, quantities so small that although the oil coated the metallic particles in the exercise of the well known preferential affinity of oils for metallic substances, the coating was so minute, so nearly infinitesimal, that the oil disappeared from sight and sense. In this process the oil coats the metallic particles, modifies

⁷St. J. Hoover, 'Concentrating Ores by Flotation,' Page 192.

⁸Vacuum-Concentration at Sulitelma.' Holm Holmson and H. N. Rees. *The Mining Magazine*, May 1910.

¹⁰See page 795, M. & S. P., Nov. 6, 1915.

¹¹'Flotation at the Central Mine, Broken Hill.' By James Hebbard. M. & S. P., Sept. 4, 1915.

¹²The actual operator was Arthur H. Higgins.

the water so as to produce minute and persistent air-bubbles, and increases the attraction of the metallic particles for the air-bubbles; and the persistency of the air-bubbles is such that the air-bubbles cling to the metallic particles and carry them to and through the surface of the pulp, and when the air-bubbles escape from their water environment in the body of the pulp and are exposed at or above the surface of the pulp, their water-

being the product of a joint effort on the part of counsel and experts representing Minerals Separation in the lawsuit at Wilmington. In the basic patent, No. 835,120, the proportion of oil is given as "a fraction of 1% on the ore." W. H. Ballantyne, patent lawyer for Minerals Separation, testified, in the Hyde suit, that "an ideal standard for the agitation-froth process is 1½ to 2 lb. oil per ton of ore." Much less is used now in the big mills of the copper mining companies.

No. 776,145.

PATENTED NOV. 29, 1904.

C. V. POTTER.

PROCESS OF SEPARATING METALS FROM SULFID ORES.

APPLICATION FILED JAN. 14, 1902.

NO MODEL.

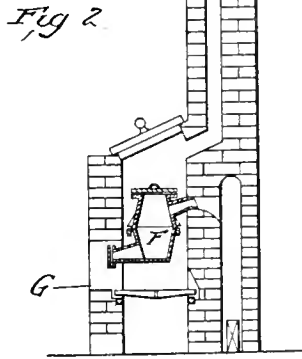
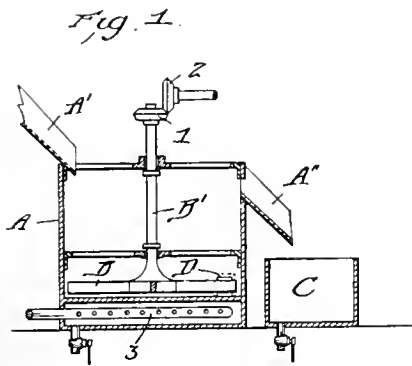

Attest:
C. S. Middleton
L. B. Middleton

Inventor
Charles V. Potter
Richard C. ...
 BY
Att'y

FIG. 5. FACSIMILE OF POTTER PATENT.

No. 763,662.

PATENTED JUNE 28, 1904.

G. D. DELPRAT.

APPARATUS FOR USE IN CERTAIN PROCESSES OF EXTRACTING SULFIDS FROM ORES.

APPLICATION FILED MAR. 9, 1903.

NO MODEL.

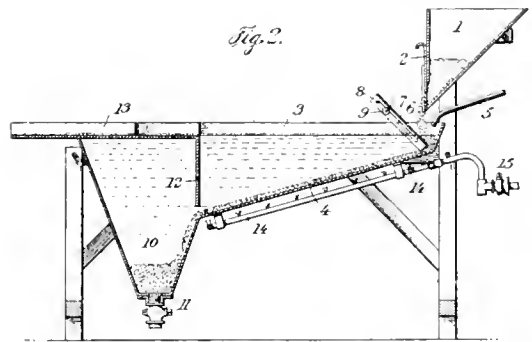
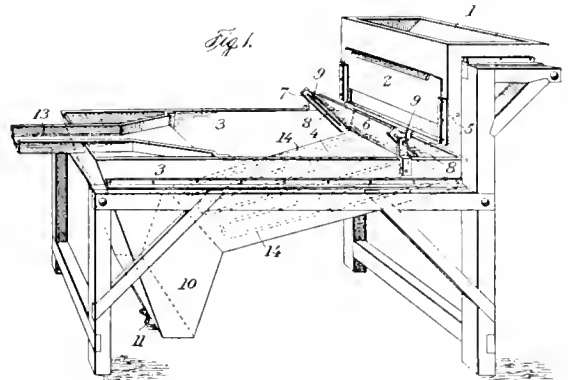

Witness
Arthur ...
A. L. ...

Inventor
Guillaume Louis Delprat
Henry ...

FIG. 6. FACSIMILE OF DELPRAT PATENT.

films carrying a mineral load are maintained intact until at least their separation from the body of the pulp has been effected, by overflowing or otherwise. The air-bubbles with their mineral load form a froth floating upon the surface of the pulp, which, if allowed to remain there in a quiescent condition will float for days and weeks. This froth has therefore been properly called a persistent or permanent froth. It will always form a coherent mass of bubbles pressed against each other and frequently several inches in thickness."

This description, lacking adequate punctuation, as is usual in legal statements, may be accepted as official.

in the Central mill of the Sulphide Corporation, at Broken Hill, as already mentioned. Two years later, in 1907, it was adopted by the Zinc Corporation, to be discarded during 1909 in favor of the Elmore vacuum process, and to be restored again to favor in 1911. See Fig. 9.

The next important application was made in 1912 at the Braden Copper mine, in Chile, where a 200-ton plant was erected. The extraction of copper (as concentrate) was 80 to 85%. But when a larger mill of two 600-ton units was built the recovery became poor, being no better than it had been in the old water-concentration mill.

namely, about 65%. Whereupon the oil was added to the ore in the tube mill and the extraction improved at once. The mill has now been enlarged to seven 600 ton units, treating 3500 tons per day.¹³ The extraction last year was 77 per cent.

In February 1915 the Anaconda Copper Mining Company took a license from Minerals Separation, and at that time also the Inspiration Consolidated Copper Company made an agreement for the same purpose. Both

during 1912. This provoked the first test case,¹⁴ which is now before the Supreme Court of the United States.

Other companies charged with infringement are the Utah Copper, Nevada Consolidated, Magma Copper, and

No. 676 679
 F. E. ELMORE
 PROCESS OF SEPARATING METALLIC FROM ROCKY CONSTITUENTS OF ORES
 Patented June 18, 1901
 2 Sheets Sheet 1

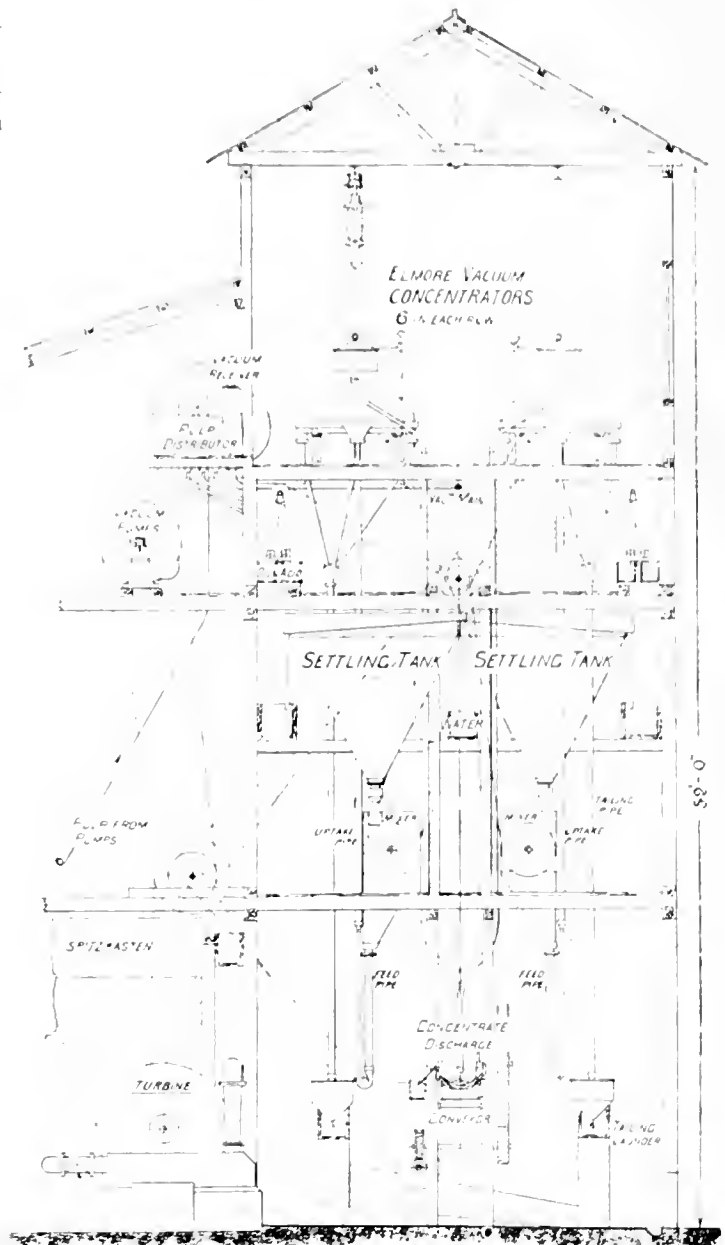
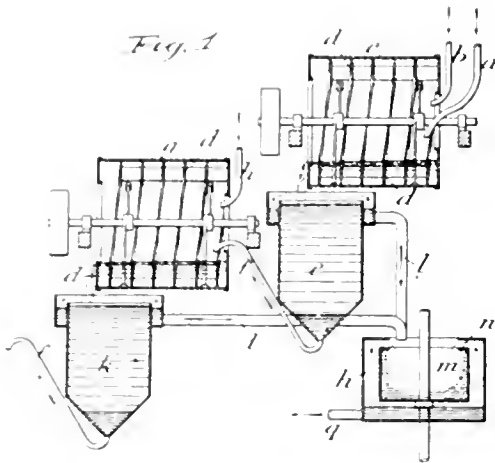

James L. Elliott
James L. Norris

FIG. 7. FACSIMILE OF ELMORE PATENT.

FIG. 8. THE SULPHUR PLANT.

companies built large mills for the operation of the process during last year.¹⁵ The Anaconda now treats 12,000 tons and the Inspiration 10,000 tons of ore daily by flotation.

The first mining company in America to ignore the Minerals Separation patents was the Butte & Superior, in Montana. Under the technical guidance of James M. Hyde, this company built a 150-ton unit in their mill

the Miami. The first three use the Janney machine and the last one the Callow pneumatic launder. In each case it is stated that the Minerals Separation machine—in which violent agitation is effected by blade-impellers—was tried first and then discarded as ineffective. The pneumatic flotation plant at Miami was commenced in August 1914 and remodeled in the early part of 1915. Suit for infringement was brought at once by Minerals Separation, the trial commencing on March 29 and end-

¹³The Braden Mill. M. & S. P., Dec. 18, 1915.
¹⁴Flotation at the Inspiration Mine, Arizona. M. & S. P., July 3, 1915. Also Flotation at the Washoe Reduction Works, Anaconda. By E. P. Mathewson. M. & S. P., Aug. 28, 1915.

¹⁵Minerals Separation, Limited, and Minerals Separation American Syndicate, Limited, v. James M. Hyde.

ing on May 27, 1915. The decision of the Court is not yet known.

As applied at Miami the flotation process is simplified by the use of a launder having a canvas bottom through which air is forced under pressure. This gives the gas required for the generation of bubbles in a pulp previously modified by the addition of oil, which is mixed with the ore while being pumped into a Pachueca tank, or Brown agitator, where it undergoes further emulsification before entering the Callow launder constituting the flotation-cell. It is claimed that the froth produced in this way is different from that made in the mechanical

processes are covered by the general term 'flotation,' and that to clarify the discussion of the subject it will be well to distinguish between

1. Film-suspension, as in the Wood and Macquisten methods.
2. Oil-flotation, as in the Robson and Elmore bulk-oil methods.
3. Bubble-levitation, as in the Elmore vacuum, Delprat, Froment, and Sulman-Picard methods.

The third class can be further sub-divided according as carbon dioxide or air is the principal gas utilized for making bubbles.

Finally, the air-bubble method can be classified according to the way in which the air is introduced:

- (1) From the bottom of the vessel, as in the Callow and Owen cells.
- (2) By being entrained or dragged into the pulp by the beating of paddles or some other form of impeller, as in the Gabbett and Hoover mixers.
- (3) By escape from solution in water, as in the Elmore vacuum machine and the Norris apparatus.

It remains to emphasize the fact that from the high ratio of 3 tons of oil per ton of ore, the proportion of oil used in flotation has decreased, by reason of the recognition of the part played by air, to one-third of a pound per ton of ore; that is, one eighteen-thousandths of the quantity used by Robson. Concurrently the acid used has decreased to a minus quantity, namely, alkalinity.

MINE-CARS at the Copper Queen mine, as first designed for the underground electric haulage system, held 21 cu. ft., had gable bottoms, hinged sides, and were equipped with M.C.B. midget couplers, spring-draft rigging, and roller-bearing axles. This car was found not satisfactory. The ore was too sticky to slide well, requiring rocking by the men to empty the cars. Also the cars leaked fine ore when wet. Later, roller-dump cars, weighing 1700 lb. and of 33 cu. ft. capacity, were secured. These also had the refinements of spring-draft rigging, automatic couplers, and roller bearings. However, instead of the solid bearings used on the first cars, the axles were designed to take Hyatt rollers with special care to make them dirt-proof. Roller-bearing axles have been an unqualified success; the axles are filled with grease only once a month. The Hyatt-bearing axles last at least six years, and the recent chrome-nickel steel types wear longer yet. It is well to use large cars underground to reduce the cost of loading, dumping, and repairs. On the other hand, narrow drifts cannot accommodate wide cars, and for convenience in taking cars from one level to another by the cage, it is necessary to limit the size. Thus the underground cars at Anaconda are less than one ton capacity.

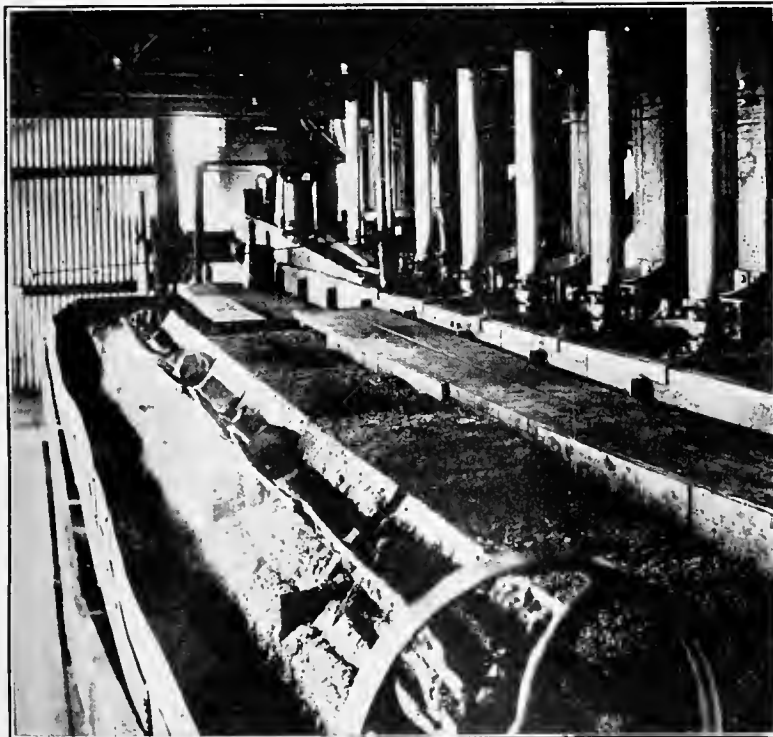

FIG. 9. FROTHING PROCESS IN THE CENTRAL MILL, AT BROKEN HILL.

mixer of the Minerals Separation machine. In the one case, according to R. C. Canby, the froth consists of a mass of delicate, fragile, and evanescent bubbles, which rise to the surface in rapid succession and maintain a froth only because they are being generated slightly faster than they break, so that the uppermost layer overflows, with its burden of mineral, over the lip of the vessel. In the other case the froth is said to be "thick, coherent, and persistent," as Mr. Picard phrased it. "It appears as if the minerals were protecting the tender air-bubble like an armor, and instead of destroying it, were actually guarding it. The froth has a long life. I have myself seen a froth standing for 24 hours without the least change having taken place." So testified Dr. Adolf Liebmann. Mr. Ballantyne stated that this agitation-froth of the Minerals Separation machine was so dense that it would support a spade. Mr. Canby showed that the air-froth of the Callow machine would not support a match-stem.

From the foregoing summary it is clear that three

Slime-Settling

*The desirability of correlating the data obtained from small scale slime settling tests with commercial work as carried on in large tanks has long been recognized by metallurgists. This need, though most apparent in designing new installations, frequently arises also in existent plants, since a large range of experimental work can be performed without interfering with regular operation.

In order to develop rational methods of laboratory testing, it becomes necessary to study the general phenomena of settling. In mulling, slime-pulp consists of water, finely-divided sand or granular products, and colloidal matter. In this connection water is used as implying either ordinary water, or water containing some chemical or chemicals in solution. Those which exert an influence upon the subsequent settling behavior of the pulp, are known as electrolytes. The electrolyte has the property of causing the colloidal portion of the slime to form aggregates known as flocs, particles having a more or less definite size, consisting of water, colloidal material and usually fine-granular matter that has been entrapped. The flocs settle in the liquid medium according to certain laws. There are four settling zones, (1) the bottom, where that portion of the pulp wherein the flocs, considered as integral bodies, have settled to a point where they rest directly one upon another; (2) a transition zone above the bottom one; (3) pulp of constant consistence of flocculated pulp and of the same consistence as the flocculated pulp in the feed pulp; and (4) the top zone of clear water or solution.

The authors summarize their investigation as follows:

1. In thickening pulps which are to be discharged at a consistence such that the discharge is still in the form of free-settling pulp, the depth of the tank used is of no consequence, except in so far as it permits a depth of feed sufficient to avoid surface agitation and allows ample depth of clear liquid to care for fluctuations of the feed, and changes in the character of the pulp in the case of continuous thickeners, and sufficient depth to give ample capacity to avoid the necessity of frequent charging and discharging in the case of intermittent thickeners.

2. When thickening pulps to a consistence where it is necessary to expel fluid by compression, sufficient capacity must be given the tank so that the pulp will be retained the necessary period of time to thicken it to the required density and also to allow sufficient storage to compensate for fluctuations in the feed and discharge. This capacity may be obtained by varying either the depth or diameter to give the required cubical content.

3. The consistence of discharge possible may be closely determined by allowing a cylinder of thick but free-settling pulp to settle, taking readings at intervals

of a few hours up to the point where settling practically ceases.

(4) The required area may be computed by applying

$$A = \frac{2,000}{24} \left(\frac{92.35/D}{F-D} \right)$$

the formula $A = \frac{2,000}{24} \left(\frac{92.35/D}{F-D} \right)$. A is the area in square feet required to thicken 1 ton of 2000 lb. of solids to a consistence in the discharge of D (parts fluid to 1 part solid by weight), per day of 24 hours. A series of settling rates is taken on pulps ranging in consistencies from that of the proposed feed to the thickest free-settling pulp. D is taken as the ratio of fluid to solids in the thickest pulp which can be economically obtained. The greatest value for A indicated by the tests is taken as the required area. Under ordinary circumstances a factor of safety should be allowed over the calculated area to take care of changes in the character of the pulp and variations in temperature. It will be noted that this is the same formula previously given, modified to give area required instead of capacity per square foot per hour.

(5) The required depth of the thickener may be ascertained by computing the capacity of the thickening zone to contain a supply of solids equal to the total capacity of the tank for the number of hours required to thicken the pulp to the density required in the discharge, and to this depth adding an allowance for the lost space due to the pitch of the drag in the thickener; also from $1\frac{1}{2}$ to $2\frac{1}{2}$ ft. for depth of feed, and a further allowance for storage-capacity when the discharge may be closed.

The following table gives the actual capacities, together with the computed capacities, of thickeners used at the various mills enumerated. In each case the tests were made at the mill by the local staff, according to directions supplied by the authors. From the data received the capacities were computed, employing the method described.

| PULP | Computed capacity, lb. per sq. ft. | Actual reported capacity, lb. per sq. ft. | No. of ft clear solution reported | Consistence of feed-pulp | Consistence of discharge-pulp |
|---------------|------------------------------------|---|-----------------------------------|--------------------------|-------------------------------|
| Liberty Bell | 4.87 | 5.94 | 1.25 | 10.00-1 | 2.00-1 |
| Belmont | 14.1 | 14.75 | 1.5 | 7.99-1 | 2.11-1 |
| Portland | 8.3 | 6.0 | 6.0 | 15.10-1 | 1.66-1 |
| (low-grade)* | | | | | |
| Nipissing | 8.24 | 11.8 | 6.0 | 11.90-1 | 1.50-1 |
| (low-grade) | | | | | |
| Presidio† | 32.0 | 17.65 | 6.0 | 5.62-1 | 1.58-1 |
| Hollinger | 19.7 | 18.0 | 2.0 | 5.69-1 | 1.60-1 |
| West End‡ | 15.24 | 11.97 | 5 to 6 | 6.10-1 | 2.62-1 |
| Homestake | 7.78 | 7.05 | | 33.60-1 | 2.18-1 |
| Homestake | 8.86 | 8.55 | | 17.50-1 | 1.59-1 |
| Golden Cycle | 19.3 | 19.1 | 0.0 | 7.70-1 | 1.00-1 |
| (roasted ore) | | | | | |

*Some colloidal material in this pulp had a tendency to remain in suspension after most of the pulp had settled. The thickener was operated below capacity.

†Thickeners being operated below capacity.

TAXATION of Michigan copper mines has been overdone. Homer Guck points out that the Ford Motor Co., one of the manufacturing concerns of the lower peninsula, earns more money than all the Lake Superior copper mines combined.

*Abstract from a paper by H. S. Coe and G. H. Clevenger, prepared for the Arizona (September 1916) meeting of the American Institute of Mining Engineers.

Mining in Utah

By L. O. Howard

THE volume of trading on the local stock exchange has not been so great since 1909. During February there was transferred 4,591,950 shares worth \$888,471. Tintic stocks have always been good counters for gambling. Their erratic orebodies, coupled with the peculiar habit of most of the Tintic mines of distributing their profits promptly in dividends, has made the stocks highly speculative. Assessments and dividends alternate. Repeated 'come-backs' have done much to popularize the cheap stocks, so that all but the largest flotations are based on 5 and 10-cent shares. The length of the calls has been increased and after April 1 unlisted stocks are to be absolutely ignored by exchange brokers.

A decision just rendered by the Commissioner General of the Land Office at Washington in the case of the U. S. Forestry Service v. The Kennebec Mining Co., is interesting. The Kennebec was engaged in driving an adit to apply as patent work on its Cottonwood property. The Forest Service took it upon itself to intervene, on the ground that the proposed work would not be upon the claims to be patented, and if continued would be of no benefit to them. The company announced its intention of changing the direction of the adit, and upon this defense was upheld in the local Land Office. The Forestry Service was not satisfied, and appealed to Washington. The mining company was again upheld. The Forest Service has gained nothing but further ill-will, and laid itself open to renewed charges of obstructing legitimate mining.

In the Cottonwood district parties connected with the Maxfield mine are to develop a large area of granodiorite at the head of Little Cottonwood. On the claim-maps of the district this area has remained a blank, because it was thought there was no limestone or other conditions favorable to ore. It is now claimed that there is limestone in this area. If so, it is an attractive prospect. Rumors are plentiful in regard to railways for the Cottonwoods. A franchise is being sought for an electric railway up Big Cottonwood.

Development continues in the American Fork district just over the divide from Little Cottonwood. Among the companies engaged in mining or soon to start work are the Texan, Pacific, Miller Hill, Globe Con., Earl-Eagle, Mineral Flat, Smuggler, Pittsburg, Bay State, Treasure Con., Major Evans, Whirlwind, Dutelman, Boyd Park, Deer Creek, Endora, Bogg, Wasatch Range, Live Yankee, American Fork, Mary Ellen, Belorophen, Phoenix, American Volunteer, Bredemeyer, South Park, Mountain Lake Extension, Silver Flat, and Tonto Development. Geologically the district lies on the strike of the productive formations of the Cottonwoods. A

power-line is to be extended into the district and at least one mill is planned.

Shipments from Park City decreased in February, owing to the short month and bad climatic conditions. Eleven shippers sent out 6564 tons. They were the Silver King Coalition, Daly-Judge, Daly West, Silver King Consolidated, Ontario, Federal Leasing, Broad-water Mills, Big Four Exploration, Western Ore Purchasing, and Quiney. The Daly West mill, which has been shut-down owing to lack of water, will be started

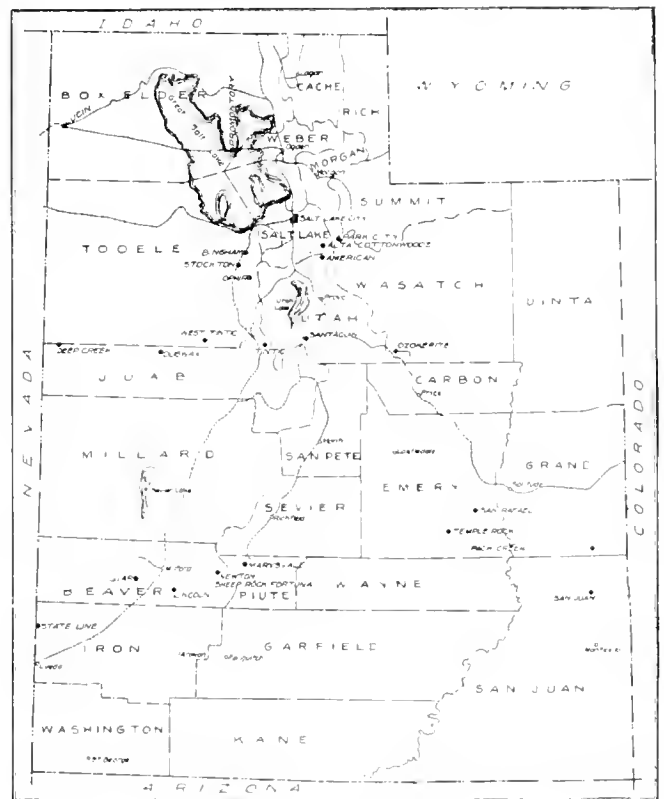

MAP OF UTAH.

soon. The heavy snow-fall assures plenty of water during the summer. Development is progressing favorably at the Keystone, New Quiney, Three Kings Silver, and American Flag.

Shipments from Tintic in February were increased to 24,550 tons of a gross value of \$610,000. There were 25 shippers, the Eureka Hill, Godiva, and Black Jack resuming their places in the list. The Crown Point and Plutus are two old mines on which work is to be renewed owing to the present favorable conditions. Two new incorporations have been launched to mine in northeast Tintic, in the part of the district that has been proved by the Chief Consolidated. They are the North Tintic Mining & Milling Co. and the Chief Consolidated

Extension—One of the principal causes of the boom in Tintic stocks is the development of a large body of copper ore in the Iron Blossom mine. Ore assaying 16% is being broken on the 1000 ft. level. A cross cut 85 ft. long has not reached the limit of the ore at this level. Another cheerful discovery is the \$80 gold ore in the Gold Chain mine.

The crushers and roasting furnaces have been started at the new mill erected by the Knight Dern interests. Last summer the chlorination plant at Park City was closed and operations transferred to Tintic. Two Holt-Dern furnaces are roasting 90 tons per day. When all are in commission, 3 Holt-Dern and 1 Knight-Christensen furnaces will be used. Capacity is estimated at 300 tons per day. Briefly the process consists of crushing by rock-breaker and rolls to 3 in., feeding automatically the proper mixture of ore, salt, coal, and sulphides to the furnaces, in which a chloridizing roast is accomplished, and further chloridizing in bins, after which the calcined material is leached in brine and acid solutions for the recovery of gold, silver, lead, and copper. These metals are recovered by successive precipitation on copper and iron.

Bingham, best known for its low-grade copper, now claims the distinction of having the largest shipper of lead ore in the United States. The mine is the Utah-Apex. The company has a contract to ship 300 tons of lead-zinc ore per day to the United States smelter, in addition to the 300 to 400 tons it is shipping to the American Smelting & Refining Co. The Utah Metal-Bingham-New Haven reports for 1915 show that this consolidation produced 2,873,815 lb. copper, 9,860,089 lb. lead, 16,914 oz. gold, and 475,894 oz. silver, for a net profit of \$594,295. The profit for January this year was \$125,000. Another dividend-payer is thus assured for Bingham. Utah Copper is now paying \$2.50 per share quarterly. Bad weather reduced the output in January to about 12,000,000 lb. copper, compared with 14,500,000 lb. in December. The Bingham Mines Co. plans extensive development of the Yosemite mine. Its report for 1915 shows a net income of nearly \$200,000, half of which came from the operation of the Eagle & Blue Bell mine at Tintic.

In Beaver county the scale of operations is increasing. In addition to the companies that I mentioned last month, the following are becoming active: Indian Queen, near the Horn Silver; Monzonite Silver & Gold, adjoining the Cedar-Talisman; Galena, in the Beaver Lake district; and Master Key in the Star district. New discoveries are being made in the Fortuna district. At the Gold Hill, adjoining the Sheep Rock, ore is being developed by an adit, on a vein that panned well at the surface. It is said that high-grade has also been opened for 40 ft. along the vein, and 5 to 6 ft. wide. The United States shaft has penetrated milling ore, and a cross-cut at 85 ft. is reported to have cut ore that can be shipped at a profit. Operations were later suspended. No reasons were given, but it may be surmised that the company is now endeavoring to secure control of sur-

rounding ground. The Sheep Rock has been bonded by local interests. A deposit of alunite occurs on this property. The local press announced the intention of the new management to erect a mill to treat this for its potash. This must be taken with reserve, seeing that the recent investigation of the newer discoveries of alunite at Marysvale resulted in the conclusion that they were not of commercial value.

There is talk that operations may be resumed on the Sacramento at Mercur. This is one of the old producers, which was unique as being the only one to operate a mercury-distilling plant. The company treated 300,000 tons of gold ore by cyanidation and paid \$308,000 in dividends. The ore yielded about \$3 per ton near the end of operations, and the tailing carried another dollar per ton. Operations covered a period from 1895 to 1907. During the five years 1903 to 1907 the company produced 3538 flasks of mercury, worth about \$139,000. There was recovered 102 lb. of mercury per ton of ore at a cost of 10.18 cents per pound. The revival, if it is to come, will be in the mining of gold ore. On the west dip of the Mercur district the group about the old Daisy is now in strong hands. The property is equipped with a cyanide plant. The mines have had a checkered history. The last attempt to work them was in 1913, when the Norma Gold Mining Co. re-modeled the cyanide plant, and ran it a short time. The treatment consisted of separate leaching of sand and slime, and filtration of the slime on Moore filters. The operation was not successful, but it is believed that with ample capital there is a good chance of doing well.

The distribution of a dividend of \$15,000 on March 6 by the Lakeview Mining Co. of Promontory brings the total for the first year of operation to \$100,000. Fifteen cars of ore containing 32.5% zinc were shipped in February. Ore has been opened by lessees 3500 ft. north of the main workings. Some lead ore also is being shipped. The Promontory Development Co. has opened a 6-ft. vein of low-grade zinc ore. Some ore of shipping grade has accumulated on the dump.

There are substantial rumors that the American Smelting & Refining Co. intends to erect an electrolytic zinc plant. The proposed sulphuric acid plant at Garfield and the success of the electrolytic plant at Murray (2 tons per day) are known facts. Cheap power and a large ore-supply are two other factors. A plant for extracting zinc has long been desired by producers. Large reserves of ore at Tintic, Bingham, Park City, and smaller amounts at Ophir, Stockton, the Cottonwoods, Promontory, and in Beaver county, would become profitable if the high freight-rate to the East were avoided. Further efforts along the same line are indicated in the announcement just made by the Daly-Judge Mining Co. that it intends to erect a plant for roasting and leaching zinc ore, and electrolyzing the solutions. With power developed by the Snake Creek tunnel and a large supply of zinc ore from its own mine, the outlook is good. It is planned to build a plant in or near Park City large enough to take care of all the Daly-Judge zinc ore.

CONCENTRATES

Readers of the MINING and Scientific PRESS are invited to ask questions and give information dealing with technical and other matters pertaining to the practice of mining, milling, and smelting.

LEAKS in compressed-air lines are more costly than leaks of the same size in steam lines.

SOME of the rarer minerals occur irregularly in the granitic pegmatites of southern California.

WORN-OUT mine car-wheels, with the axles sawed-off, then clamped to the inside of tube-mills and set with cement, are being used on the Rand for liners.

TIGHT KEYS in pulleys may be removed by placing a teaspoonful of 40% dynamite against the end of the keys, mud-capping the charge, and exploding it.

MINE-PUMPING figures are expressed both in millions of gallons per day and in hundreds of gallons per minute. A million gallons per 24 hours is about equal to 700 gallons per minute.

ARSENO-PYRITE when it is struck with a hammer gives off an odor somewhat like garlic—the 'alliaceous odor' of the text-books—an odor familiar in mines where drills are cutting rock or ore impregnated with arseno-pyrite.

FIREMEN'S WHISTLES are considered better warning signals than motor bells at the Leonard mine at Butte, where crossings over electric-haulage tracks underground are dangerous on account of the difficulty of seeing an approaching train from cross-cuts or drifts that cross or join the haulage-level.

THE H-BIT, says a mine-superintendent who has used it for several months, drills best when the little cross-bar of the H is left off. The effect of the double cutting-edge without the cross-bar is to chip the rock in the centre of the drill-hole in larger fragments by reason of the rotation of the two off-set cutting-edges.

THE TROY POUND contains 5760 grains; the avoirdupois pound 7000 grains. As there are but 12 ounces in a troy pound, each troy ounce contains 480 grains and is heavier than an avoirdupois ounce, which, being $\frac{1}{16}$ of a pound, contains 437½ grains. That is, a troy ounce of gold is 9.7% heavier than an avoirdupois ounce.

ELECTRIC-ORE HAULAGE underground in the Copper Queen mine cost 23c. per ton in 1914, the average distance trammed being 2939 ft. Of this cost, 11c. was for labor; 7.4c. was for maintenance of motors, cars, trolley, and tracks; and 1.3c. was for power. Cost of car repairs was high as the equipment was several years old.

VANADIUM MINERALS, more especially those of the oxidized zone, are readily soluble in mineral acids. Hydrochloric is the most convenient acid to use. If concentrated hydrochloric acid, HCl, is put upon carnotite,

vananite, vanadinite, the descloizites, and some other vanadium minerals, it immediately gives a rich red-brown solution. If water is added the color changes to green or disappears.

LUBRICANTS sometimes contain corroding substances, and should be tested for these. A simple method is to polish a steel surface, coat it with the lubricant, and expose it to the sunlight for 15 to 20 days. If acid is present in the lubricant the steel will show etchings. Water oxidizes the steel and shows rust pittings, the latter showing better on a rough surface.

MICA is used considerably in electrical machinery, as an insulator between the segments of commutators, the soft grades being preferred. The General Electric Co. formerly obtained mica from its own mine near Sydenham, Ontario. Large sheets of mica bring a high price for lamp-chimneys and novelties. Scrap mica is ground fine for fire-proofing materials and miscellaneous uses. Quebec produces a good deal of mica mined in irregular amounts from Pre-cambrian crystalline rocks by prospectors. London has been a large market for mica, where lots were sold by auction so that the buyer could see exactly what he was getting.

MAINTENANCE COST of electric centrifugal pumps compared with steam pumps at a mine of the Penn Iron Mining Co., Michigan, for one year was as follows:

| | Four centrifugal pumps. | Four steam pumps. |
|----------------------|-------------------------|-------------------|
| Shop labor | \$717 | \$760 |
| Labor on pumps | 690 | 590 |
| Supplies | 503 | 2021 |
| Total | \$1910 | \$3371 |

These two sets of pumps were doing practically the same duty.

TIN. The simplest test for cassiterite is to place a fragment of the mineral in dilute hydrochloric or sulphuric acid with granulated, shot, or sheet zinc. The zinc and the acid rapidly evolve hydrogen, which takes the oxygen from the mineral and leaves a coating of tin on the fragment tested. Granulated zinc is the best to use. The blow-pipe test is better known and is more often used, though it is not made so readily. The mineral supposed to be cassiterite is pulverized and should yield a light-colored powder unless it is mixed with iron oxides, in which case the powder will be reddish or brown. Some cassiterites from the Carolinas and South Dakota, however, give a purplish powder. A small portion of the powder is mixed with twice its bulk of pulverized charcoal and three times its bulk of sodium carbonate or bicarbonate (ordinary washing or baking soda). The three substances are thoroughly mixed, and a portion the size of a pea is moistened and placed in a hollow in a piece of charcoal. By means of a reducing blow-pipe flame tin is readily reduced in small globules, which are easily distinguished from the flux.

REVIEW OF MINING

As seen at the world's great mining centres by our own correspondents.

SANTA FE, NEW MEXICO

MINERAL PRODUCTION OF THE STATE MADE PUBLIC BY OPERATION OF NEW TAX LAW.

For the first time in the history of mining in this State, authoritative figures on mineral production have been secured. The State Tax Commission, working under the provisions of the Springer-Hawkins mine tax law, passed last year, is responsible for these data. The gross production of New Mexico's coal and metal mines in the calendar year 1915 was nearly \$22,000,000, with \$10,000,000 net. One concern, the Chino Copper Co., produced more than half of the entire gross, or \$11,383,777, with \$6,846,294 net. This company is treating 7500 tons of 24-ore per day.

The Commission's figures cover 36 coal and metal-mining enterprises. In addition to these, the Colorado Fuel & Iron Co. and the Oark Mining & Smelting Co., also were producers in 1915, but their returns are not yet complete. The figures on gross production are those returned to the Commission by the operators, but the net values, on which taxes are collected, were determined after an examination not only of the returns made, but of reports submitted by a special accountant who checked the operators' books. The gross production returned by the 36 producers was \$21,695,479, and the total net, as determined by the Commission, \$9,824,736.

The 10 coal enterprises of New Mexico, now on a producing basis, returned a total output in 1915 of \$6,674,599, and \$1,367,734 net. Among the coal concerns, the Stag Canyon Fuel Co. (Phelps, Dodge) ranks first in gross production, and the St. Louis, Rocky Mountain & Pacific Co. second, but in net production their positions are reversed.

Among the metal-mining concerns, the gross output of the Eighty-five Mining Co. is second to that of the Chino, but the Empire Zinc Co., operating in both Grant and Socorro counties, has second place in net output, showing \$157,114 net out of a gross of \$524,579.

Under the provisions of the Springer-Hawkins law, the mines and mineral lands of the State are divided into productive and non-productive classes. On the net outputs of the producing properties taxes are assessed as on all other property, and these taxes are considered to cover the full mineral values of the lands being worked, and of contiguous mineral lands held for future extensions of mining operations. The net value of the mineral output is stated to mean the difference between the actual cost of production, transportation, treatment, shipment and sale, and the amount realized, if sold, or that could be realized at the time of making the reports, and it is specified that the statements of expenditures shall not include any amounts expended for machinery or other improvements, for the construction of mills or other reduction-works, or for salaries of persons not actually engaged in the working of the mines, in the reduction, transportation or marketing of the minerals, or in the personal management of the enterprises. All non-productive mineral lands are to be assessed and taxed on the reasonable valuation thereof as undeveloped mineral ground, in addition to their surface values for grazing, agriculture, timber or other purposes, and in fixing such values it is the duty of the taxing officials to take into consideration transportation problems and opportunities for marketing the products. The law does not exempt from taxation reduction-

works, buildings and other improvements at mines or on mineral lands.

In Socorro county, the Mogollon Mines Co.'s gross yield was \$508,592, and \$131,485 net; and the Socorro Mining & Milling Co., \$649,127, and \$180,154 net. Both are silver producers.

CRIPPLE CREEK, COLORADO

GOLD OUTPUT.—FLOTATION.—DRAINAGE.—ELLA W. AND ISABELLA

Gold production of the Cripple Creek District mines for February, as reported by the mills and smelters, is as follows:

| | Tons. | Average. | Total value. |
|-----------------------------|--------|----------|--------------|
| Golden Cycle, Colorado City | 29,500 | \$19.00 | \$560,500 |
| Portland, Colorado Springs | 12,500 | 21.00 | 262,500 |
| Portland, Victor mill | 17,600 | 2.34 | 41,184 |
| Portland, Independence mill | 12,250 | 2.25 | 27,562 |
| Smelters, Denver and Pueblo | 4,100 | 55.00 | 225,500 |
| Isabella mines | 1,680 | 2.60 | 4,368 |
| | 77,630 | \$14.15 | \$1,121,614 |

Oil flotation is in operation at the Independence mill of the Portland company, and is reported to be a success. So far no official figures have been published.

Experiments in flotation were undertaken at the Colburn mill of the Ajax company last month, but results are kept quiet.

The Caley mill, on the property of the Jerry Johnson company, resumed ore treatment during the last few days of February. It is expected to run full time during March.

An advance of 24 ft. was made in the Roosevelt drainage-tunnel in February. The breast is now approximately 200 ft.

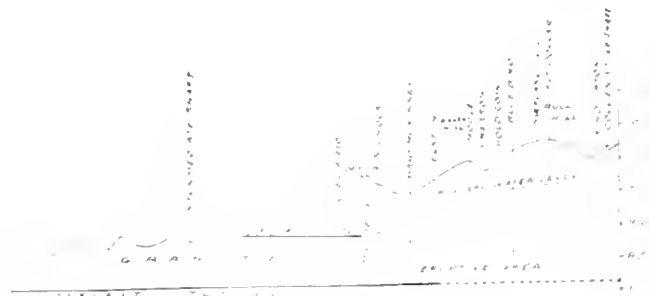

SECTION OF CRIPPLE CREEK DISTRICT.

east of the Elkton shaft. The adit will continue east for some 500 ft. farther, within the boundaries of the Elkton property. Interesting developments are expected. Included in the advance mentioned was a cross-cut from the tunnel to a point directly under the Elkton shaft. At this place a station was cut preparatory for the connection of the shaft with the tunnel. The flow from the portal remains at 17,000 gal. per minute.

Since the discovery last July at the Ella W. property on Tenderfoot hill, there has been shipped up to February 16, 1916, 638 tons of ore. The average net value, after freight and treatment charges were deducted, was \$11.13 per ton. The ore was shipped without sorting. The lowest gross value on

any car of ore was \$8.80 per ton; the highest was on the last car, \$37.80 per ton. It is reported that Johnson and Mack, who found the ore there, have disposed of their interest to Denver men.

In February the El Paso mine produced 200 tons of ore with a gross value of \$44,000. The annual meeting of this company will be held in Denver on March 13, when a full board of directors, nine in number, will be elected.

The Isabella mine produced 1300 tons of \$20 ore during the last month. A rich development was reported in this mine a few days ago. The share quotation on the Colorado Springs exchange jumped five points. The new shoot is on No. 15 level of the Lee shaft, and 1300 ft. below the surface. Grab samples of the ore as broken from 42 in. width, are said to assay over 6 oz. per ton.

The Granite company's mines on Battle mountain yielded 3270 tons of \$22 ore during February; lessees contributed.

KALGOORLIE, WESTERN AUSTRALIA

LABOR DISPUTE SETTLED.—PRINCIPAL GOLD PRODUCERS IN 1915.

The strike of wood-cutters, mentioned in the Press of March 4, employed by the three companies that supply the majority of the mines with firewood, was settled on January 19, after nearly three weeks' stoppage. Work was expected to be in full swing on the 24th. The two mines which did not suspend operations were the Ivanhoe, which substituted coal for wood, and the Kalgurli, which gets its firewood from a private contractor. The total number of men out of work was 4700, consisting of 3800 on the mines and 900 in the wood areas. (There were also 700 others on the Trans-continental railway construction out of work, owing to shortage of rails due to a strike of the coal-miners in New South Wales, and the men employed at the Broken Hill Proprietary company's steel-works at Newcastle, in that State). The new agreement, which extends to June 30, 1918, increases the rate of wood-cutting from \$1.08 to \$1.14 per ton, with several minor concessions. The credit for amicably settling the dispute is due to P. Collier, minister of mines and acting-premier of the State.

The current wages agreement with the Kalgoorlie-Boulder miners will expire on April 15, and will probably be extended for the period of the War without alteration.

The revenue of the principal gold producers of the State for the past two years is as follows:

| | 1915. | 1914. | Dividends in 1915. |
|--------------------------|-------------|-------------|-----------------------|
| Great Boulder | \$2,924,500 | \$2,827,700 | \$1,312,500 |
| Ivanhoe | 1,900,100 | 1,814,400 | 525,000 |
| Golden Horse-Shoe | 2,207,400 | 1,945,700 | 412,500 |
| Oroya Links | 611,100 | 594,500 | |
| Great Fingall | 326,200 | 379,700 | |
| Lake View & Star | 1,165,400 | 1,296,900 | 150,000 |
| Perseverance | 1,236,300 | 1,304,300 | |
| Kalgurli | 1,112,100 | 1,284,100 | 435,000 |
| Sons of Gwalia | 1,242,300 | 1,252,500 | 203,120 |
| Associated Northern | 137,900 | 127,500 | |
| Associated | 654,700 | 714,200 | |
| South Kalgurli | 680,200 | 612,100 | 78,120 |
| Black Range | 250,800 | 221,700 | |
| Fenian | 568,200 | 556,100 | |
| Yuanmi | 379,200 | 655,900 | |
| Mararoa | 289,500 | 276,900 | 75,000 |
| Ida H. | 194,000 | 288,600 | 15,150 |
| Bullfinch | 505,200 | 550,500 | 119,000 |
| Menzies Consols | 308,800 | 318,700 | 28,000 |
| Edna May | 754,100 | 645,700 | 385,650 |
| Edna May Central | 115,500 | 223,400 | |
| Ingliston Consols | 236,500 | 224,600 | |
| Adelaide Enterprise | 20,400 | 7,000 | 2,000 |

TORONTO, ONTARIO

THE NICKEL QUESTION AGAIN.—WAR-TAX MODIFIED.

During the present session of Parliament the nickel policy of the Government has been repeatedly attacked on the ground that all nickel refining should be done in Canada to prevent any possibility of Germany obtaining a supply. It was stated that the International Nickel Co. was controlled, or at least under the influence of Krupp. The course of the Government was warmly defended by Solicitor-General Meighen, who effectually disposed of the wild talk by official figures showing that of the 469,441 shares of the International company only 421 shares were held by persons in Germany and Austria. While admitting that it might be desirable at some time to put an export duty on nickel ore, as a means of encouraging Canadian industry, he urged that to do so at present would cut off the supply of nickel from the American manufacturers, who were making war munitions for the Allies. It is evident that the Government has no intention of disturbing the present arrangement by imposing any restrictions on nickel ore exportation.

The strong pressure brought to bear on the Government by mining and industrial interests has resulted in the modification of several objectionable features of the proposed war-tax on profits. Only paid-up capital will be treated as capital stock, and the value of remaining stock will be based on assets and liabilities on January 1, 1915, stock thereafter issued to be reckoned according to its money-value. Other provisions are introduced with the object of having the profits calculated on the actual money invested, instead of on the nominal capital. The most important change as affecting mining companies is that in determining profits allowance will be made for the exhaustion of ore.

The regular four-weekly statement of the Hollinger company for the period ending January 28 showed a considerable fall in revenue, owing to the lower grade of the ore treated. The gross profit was \$174,966, from the treatment of 30,817 tons of ore, averaging \$9.30 per ton. The working cost was \$2.94 per ton. The new central shaft has been cemented down to the 425-ft. level, which is a new departure in northern Ontario mining. Two veins have been cut in the cross-cut which is being driven at this level toward the Vipond boundary.

At the Dome ore has been cut below the 625-ft. level in the new central shaft. This is regarded as unsatisfactory, as the location of the shaft was chosen so that it should not be in ore. Some of the original 40 stamps are being removed to make room for ball-mills, which are regarded as more economical for the secondary crushing of ore. Two tube-mills have arrived. During February 32,040 tons was treated for \$163,480.

The machinery in the addition to the McIntyre mill has been installed, giving the mill a capacity of 450 tons. The addition will be used for the treatment of ore from the Jupiter, where the breaking of ore has been at 100 and 200 feet.

The new orebody at the Vipond is averaging much better than ordinary run-of-mine. It has been drifted on at the 400-ft. level for 100 ft., maintaining its width and grade. An extension of the same vein has been picked up at the 500-ft. level. The statement of the Vipond for 1915 shows a total revenue of \$248,312, and a net profit of \$35,136. Ore reserves are placed at 90,000 tons, valued at \$587,280.

On March 15 the Right of Way company paid a 0.5% dividend, or \$10,000. The mine, 365 ft. deep, is near the La Rose and has an interesting history, having paid large dividends. A car-load of 1000-oz. silver ore was recently shipped. Four drills and 22 men are employed.

Timmins brothers are developing and equipping the Cheney mine in Gould township.

A car-load of bagged ore is ready for shipment from the Belle Ellen in South Lorrain.

THE MINING SUMMARY

The news of the week as told by our special correspondents and compiled from the local press.

ALASKA

JUNEAU

During February the Alaska Gastineau mill treated 122,000 tons of \$1.92 ore. The March average is expected to be much better. The low value last month, 19c, under that of January, was due to inability to deliver any high-grade ore in the last two weeks from the stope east on No. 5 level, which is looking better than for some months. At least 150,000 tons of \$2.50 ore more than expected can be extracted there. To obtain this the stope had to be prepared. There is 90,000 tons of this vein broken in the stope.

The general manager, B. L. Thane, reports the following latest news from the mine:

"Latest results in prospecting the ore-zone east of No. 1 shaft are as follows: Level No. 9 first drill-hole 150 ft. west No. 2 shaft 30 ft. schist ore, average value \$2. Second hole 250 ft. west of No. 2 shaft, No. 9 level schist ore 35 ft. Average value before reducing the high assays, \$30.10. After reducing all high assays to \$10, average value \$4.88. This is the highest grade ore ever cut. No diamond-drilling is being done yet at No. 8 east. On No. 7 level 950 ft. east of No. 1 shaft the first 18 ft. averaged \$3.30; next 26 ft. low value; next 35 ft. average value, before reducing high assays, \$10.45; after reducing high assays to \$10, average values \$5. The last two holes are in ore. Indications are favorable that the high-grade schist ore-body continues on down from No. 5 to No. 10 levels in position as previously reported, and that the value continues satisfactory. The management is doing all it can to hurry development east as much as possible, and will open a stope in this new high-grade ore as soon as possible."

D. C. Jaekling thus comments on the above:

"This is the best looking information we have had for some time, and while I think the very high values reported should be considered conservatively, it begins to look like there is no doubt about the existence of a very large continuous orebody in this section that will average at least twice or three times as high as our estimated average. Stopes are all opened on the fifth, ninth, and tenth levels; the sixth level and seventh level are into the orebody, and the eighth will soon be there. It would seem reasonable to expect that within the next 90 days we should be able to get considerable of this ore and thus increase both grade of ore and tonnage, and I am now much more hopeful of early improvement of conditions than I have been for the past two months."

ARIZONA

MOHAVE COUNTY

(Special Correspondence)—The Oatman Champion Mining Co., which recently started work at the old Black Wonder in the Silver Creek district, is contemplating considerable development. The old shaft will be abandoned for the present, and a new one is being sunk about 75 ft. off the main vein, which will cut it at 200 ft. depth. The vein is an unusual one for this district; at places it is 40 ft. wide, and some samples have assayed as high as \$40 per ton. The old shaft is worth about \$6 per ton any place from surface to depth 70 ft. The buildings will be re-modeled at an early date; modern machinery will be installed soon.

The Arizona Gold Star Mining Co., which also recently commenced near the Times mine, is making rapid progress in

sinking. The shaft is down 60 ft., going through the vein on the hanging wall. The machinery is all on the ground, partly installed. The equipment consists of one 25 hp. and 38 hp. White & Middleton gas engine and 250 ft. Gardner compressor. In a few days sinking will be resumed with jackhammer drills.

Oatman, March 2.

It is stated that miners at Oatman have asked for a raise in wages from \$3.50 to \$1 per day. At the Golconda zinc mine, at Union Basin, they receive \$1.65 per shift, on account of the price of spelter.

A good deal of interest is being taken in development at the United Western mine. A cross-cut on the 505-ft. level has cut stringers of quartz, one assaying \$16.68 across 7 in. The cross-cut is in alternate stringers of highly mineralized andesite, with the entire formation showing good pan values. Mining men who are familiar with development in the Big Jim and United Eastern state that the character of the zone now being cut by the United Western is identical with that lying just outside of the main orebodies in these other properties. The inflow of water is also regarded as a favorable sign, as in the developed mines in the district the veins which hold important shoots usually carry some water.

The shaft of the Boundary Cone is now down 700 ft., and the contact zone between the younger and older andesite has been passed. A good deal of ore has been opened at 505 feet.

The Gold Dust company has taken over 40 acres of the old O'Ryan property adjoining the Boundary Cone, and has started extensive development. There are three shafts from 300 to 500 ft. deep, with more than 3000 ft. of lateral workings. Sinking will be started, and the fault-zone studied.

The Oatman Gold Mining & Milling shaft is down 475 ft., having cut stringers of mineralized ore.

The Oatman United company has ordered machinery of 1000-ft. depth capacity. The shaft is to be sunk to 600 ft. at once.

Water has curtailed work at the Black Range, in which some good ore has been opened.

The Big Jim shaft is down 500 ft., and will go another 100 ft. Cross-cutting at 500 ft. is soon to be started. Work at 100 ft. has cut more ore.

Grading for a 200-ton mill is well under way at the United Eastern. The new shaft is down 60 feet.

The Oatman Amalgamated company's property has been examined by Etienne A. Ritter. Extensive development is to commence.

The Gilt Edge shaft is down 135 ft., and that of the Gold Range 125 ft., both in favorable country.

The Mohave-Oatman Water Co. is an Arizona corporation, capitalized at \$1,000,000, to construct a water and sewerage system in the Oatman district, to cost between \$250,000 and \$300,000. Water will be pumped from wells on the east bank of the Colorado river, through a 10-in. pipe, to an intermediate reservoir of 2,500,000-gal. capacity, a distance of 9½ miles, to a height of 1762 ft. From this point an 8-in. pipe will be run through various townsites to its main reservoir at Oatman, also of 2,500,000-gal. capacity, a distance of 3 miles, to a height of 625 ft. A 4-in. lateral will be constructed from the intermediate reservoir, to Black Range townsite, a distance of 4 miles, and another to the Times townsite, a distance of 3 miles, which supply will be by gravity. The pumping plant will deliver 800 gal. per minute, raised to the intermediate

reservoir, from which point water will be re-pumped to Oatman, the total lift for the two pumping stations being 2400 ft., and a distance of 12½ miles. The sewer will be a 14-in. main, beginning at Oatman, and extending south, running parallel with the water-main, by its intermediate reservoir, a distance of 5 miles. The following towns through which the main line will be laid are Oatman, Oatman City, Mazona, Carter, Ryan Addition, Old Trails, and South Oatman. These towns adjoin each other and are on the Old Trails national highway. Officers of the company are Daniel Cahill, president and superintendent; E. Pritchard Smith, vice-president and general manager; and D. L. Mayhew, secretary and treasurer. The company will be ready to let contracts within 90 days.

PINAL COUNTY

(Special Correspondence.)—There seems to be no doubt that another copper-producing mine will be opened on the extensive copper belt extending from Christmas to Ray. The Pinal Development Co., which is energetically developing the Renfro property, four miles east of the Ray Consolidated, reports that a discovery of rich ore has been made on heretofore unexplored ground. This has strengthened confidence in the property, and the remaining shares of the first issue are being subscribed for.

Ray, March 8.

YAVAPAI COUNTY

With each 3c. advance in the price of copper the United Verde company will raise wages 25c. per shift. A minimum of \$3.75 is paid with 17c. metal, \$4 with 17 to 20c., \$1.25 with 20 to 23c., \$4.50 with 23 to 26c., \$4.75 with 26 to 29c., and \$5 with 29 to 32c. The output is to be increased 30% by August, and 30% more in October.

CALIFORNIA

The search for chromic-iron ore deposits in this State continues, as foreign supplies are interrupted and irregular. Cali-

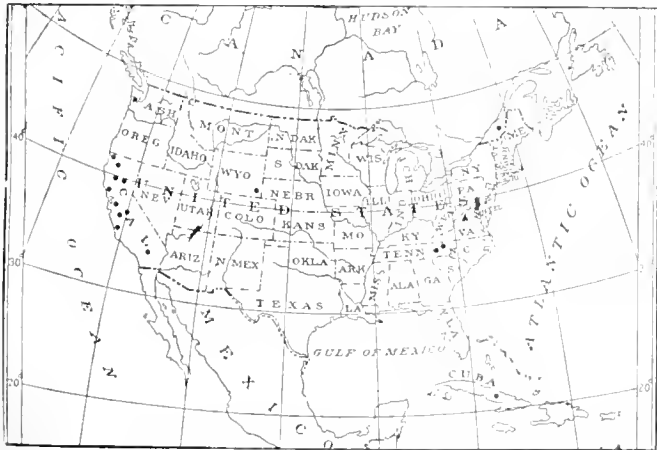

MAP OF NORTH AMERICA, SHOWING CHROMIC-IRON ORE DEPOSITS.

ornia is the principal producing State; Shasta county contributing the most ore. Production is increasing, and new deposits are frequently reported. The accompanying map shows the situation of the best-known deposits in North America. Several properties in San Luis Obispo county have been shipping 42% ore for the past six months.

AMADOR COUNTY

The discovery of a deposit of good-grade chrome ore is reported by V. N. Swanson from near Ione. A carload is to be sent to San Francisco.

NEVADA COUNTY

(Special Correspondence.)—People claiming to represent the Tonopah Belmont company of Nevada are acquiring options

on large areas of quartz and placer territory north and east of Grass Valley. Owners state they are offered \$400 per acre, subject to development under option. Several ranches in the vicinity of Alta hill containing mineral deposits are included.

Arrangements have been made for re-opening of the South Idaho mine, south of the Idaho-Maryland group. A centrally-located shaft will be sunk, new equipment installed, and efforts made to pick up extensions of important veins opened in neighboring properties. The mine is held under option by Errol McBoyle and associates of San Francisco. A. M. Randal is superintendent.

The Whiskey vein has been intersected at a depth of 850 ft. in the Golden Center mine, and is similar to the upper workings. The company has taken under option two mines near Placerville, Eldorado county.

The Massachusetts quartz claim at Gold Flat, between the Phoenix and Pittsburg mines, has been taken under bond by H. O. Secrist of Nevada City. Preparations are being made for early work. The ore-shoot contains free-milling quartz assaying \$40 to \$150 per ton.

The Providence shaft of the Champion group, at Nevada City, has passed the 2000-ft. point, and is still advancing. It has three compartments, and the station at the drain-tunnel is timbered with steel. The shaft will soon become the main working thoroughfare of the property, displacing the old Champion shaft. A. Gill is in charge of the work.

Grass Valley, March 6.

After being closed for 20 years, the Washington mine at Ormonde has been bonded by the Von Schroeder Investment Co. The mine is opened by adits, and has a 20-stamp mill. Work will commence early in May.

The Pennsylvania Consolidated Mining Co. is to be dissolved at an early date. On May 1 the Empire Mines Co. will pay the Pennsylvania the last installment of its purchase of \$500,000, about \$5.75 per share on 51,000 shares.

SHASTA COUNTY

(Special Correspondence.)—Late developments in the Midas mine, at Harrison Gulch, have been of such a satisfactory nature that the president, J. H. Sharpe, has arranged to take personal charge of affairs. The vein recently cut on the second level was found in the foot-wall of the middle vein, and promises to yield well. It has been opened for over 100 ft., and some of the ore assays \$100 per ton. Preparations are being made to develop it at the point of discovery, and to seek its continuation at a lower depth. The working force has been increased, and more comprehensive developments are proceeding in both the Midas and Gold Hill mines. Important additions to the mill are contemplated. The property is owned by the Victor Power & Development Co., with headquarters at Red Bluff.

The vein cut last summer on the 1300-ft. level of the Gladstone, at French Gulch, has been intersected on the 600-ft. level. The 20-stamp mill is running steadily, and over 60 men are on the pay-roll. Preparations are under way to open the vein on other levels, and it is reported sinking of the shaft will be resumed soon. E. Young is superintendent.

Dredging operations in the vicinity of Redding continue to claim interest. The dredge of the Gardella Dredging Co., on Clear creek, four miles below town, will soon start. It will first work the Gibson ranch. Exploration of ground east of Redding is being carried on with a Keystone drill by the El Oro Dredging Co. The U. S. Dredging Co. is preparing to work ground along the bed of the Sacramento river with a suction-dredge. It is reported the Igo Development Co. is planning an early resumption of prospecting along the placer deposits in the vicinity of Igo.

Redding, March 5.

Seven cinnabar claims have been located by C. O. Strayer of Chico on Clover creek, near Millville.

A vein of considerable length has been uncovered at Oak Run by J. T. Beale and W. Winters; it assays \$8 per ton.

SIERRA COUNTY

In the laterals of the State highway to be constructed some of them will be of great benefit to mining centres of this county.

SOLANO COUNTY

Work has been started at the Hastings' estate near Bencheh to develop the cinnabar deposits.

TUOLUMNE COUNTY

(Special Correspondence.)—A mill test of ore extracted in developing the Star King mine is being made. The property which is situated east of Tuolumne has for some time been in the hands of R. C. Kennedy, under whose direction considerable development has been done. A station is being cut at the 225-ft. level, where driving is also in progress.

The Pittsburg Silver Peak company, which is rehabilitating the Rawhide, has taken an option on the Patterson, an old property situated near Tuttletown.

While sinking a well on land adjoining Sonora creek, near Lamestown, H. S. Shepherd, a mill-man employed at the Harvard, uncovered a promising deposit of gravel. It is capped by several feet of soil. It is thought that a creek once flowed through the property.

An 18-in. vein, which gives high assays, is being opened on the Pease ranch, in the Blanket Creek district, by Wesley and Haley Fitzgerald. It is said to be the intention to install a mill on the property before long.

The Street mine, at Tuttletown, has been unwatered to permit of inspection.

The Cherokee Gravel Co., whose property is situated between Tuolumne and Soulsbyville, has decided to extend the adit several hundred feet farther into the mountain, beneath which an ancient channel is hidden. The adit was started many years ago, and exposes gravel from which rich pannings have been obtained. Those interested are J. H. West and James Harry, of Soulsbyville, and A. Scanavino, of Tuolumne.

Sonora, March 4.

Activity in drilling new oil-wells continues throughout the California fields as shown by the reports made to the State Mining Bureau during the week ended March 4. There were 16 new wells, which equals the highest weekly number yet reported. A remarkable fact is the widespread distribution of the wells among various fields and owners. The large companies own only four of the wells. This probably indicates that the pressure for more oil has now reached to the smaller producers who respond less quickly to market changes than the larger ones do. It is also a notable fact that 14 wells are reported for deepening or re-drilling which is a secondary method of increasing production. The number of tests of water shut-off and abandonment are normal. Oil operators during 1915 will probably spend about \$4,000,000 in drilling new wells. The Bureau is now receiving sworn production statements from all producers for the year 1915. These figures are to be used as the basis in levying the assessment to pay for the oil-protection work carried on by the Bureau, and will doubtless give the most accurate figure that has ever been obtained. The assessment to be collected this year is to cover the expense of two years and amounts to \$75,000. There will also be funds established in each county to provide for actual repair work at wells whose owners refuse or are unable to carry it out.

COLORADO

CLEAR CREEK COUNTY

(Special Correspondence.)—Every mill in the Idaho Springs district is being operated on three 8-hour shifts, and nearly 500 tons is being treated daily. The Argo cyanide plant is treating 150 tons daily from the Gunnell mine; the Newton, 90 to 100 tons from the Gun; the Hudson 80 tons from the Big Five; the Combination 50 tons from the Comstock; the Mixsell

25 tons from the Bride, and the New Era 50 tons from the New Era. The Egan mill up Chicago creek will be brought into commission in a few days, while the Donaldson is also to be remodeled. The Jackson concentrating plant, of 50 tons daily capacity, has been leased to Filgren, Gustafson & Co. for two years. Two new Huntington mills and five sets of jigs are being installed. The machinery will be started on March 15.

A rich discovery has been made on the fifth level of the Black Eagle mine up Chicago creek. The vein is from 8 to 14 in. wide, and smelter returns average \$55 per ton in gold, silver and lead. H. Short is lessee.—Work will be resumed in a few days on the Quito mine, situated up Chicago creek. This property was a heavy producer previous to three years when litigation arose. J. B. Shepherd of Denver is manager. —Work has been resumed on the Beaver mine situated up Chicago creek and shipments of \$20 smelting ore are in order. J. J. Hoban is manager.

A 5-ft. body of \$40 ore has been uncovered on the Edgar vein on Bellevue mountain. Operations are being pushed through the Big Five adit, 800 ft. from the portal. An average of 50 tons of ore is being broken daily. A. L. Carnahan is manager of the Boston Leasing Co., controlling ground below the adit level.

Idaho Springs, February 28.

LAKE COUNTY (LEADVILLE)

Ore shipments from Leadville during February totaled 53,781 tons; 38,000 tons to outside plants and 15,781 tons to the Arkansas Valley smelter. Included was 13,211 tons of zinc ore, mostly from the Western Mining Co., Empire Zinc Co., Colonel Sellers, and Iron-Silver mine. The local smelter is again at capacity after the strike.

Good progress is being made in preparing the Harvard shaft on Fryer hill for unwatering. A station is complete at water-level, and two pumps installed. A power transmission-line is under construction to the property. Pumping was expected to commence about the middle of March.

At the Penrose shaft of the Down Town area the stopes and openings at 800 ft. are being drained. All machinery is working well.

In the Lackawanna district the Mt. Champion mill is treating 75 tons of gold ore daily, worth from \$8 to \$100 per ton. Ten tons of concentrate is shipped each day. If development continues to be good a 500-ton plant will be erected. Lucien Smith is manager.

Two men were killed in the Anderson adit by the premature explosion of 60 to 70 lb. of dynamite.

SAN JUAN COUNTY

According to *The Silverton Miner*, from present indications the county is to have an early spring. Prospecting will be keenly done, new properties will commence, and old producers are to increase their forces. The tungsten areas will be thoroughly explored. Some of the mines to resume are the Dora and Frisco. The Red Mountain district is busy now, high-grade copper ore coming from the National Bell.

TELLER COUNTY (CRIPPLE CREEK)

The Roosevelt drainage-tunnel was advanced 244 ft. during February. A good deal of other work was also done. The present face is 160 ft. east of the Elkton shaft.

The Golden Cycle shaft is down 2210 ft., and the Ready Money vein has been cut at 2025 ft., where it is as large as 200 ft. above, and of fair value. The Vindicator shaft is 1787 ft., equal to 1650 ft. in the Golden Cycle. During February the Vindicator property produced 5500 tons on company account and 4676 by lessees.

IDAHO

The report of the State inspector of mines, Robert N. Bell, for 1915, covers 134 pages, considerably larger than that for

the previous year. It is well illustrated with photographs of mines and mills. The metal production was as follows:

| Metal. | Quantity. | Value. |
|------------------------|-------------|------------|
| Antimony, pounds | 70,950 | \$ 28,380 |
| Copper, pounds | 7,365,000 | 1,286,665 |
| Gold, ounces | 60,746 | 1,255,619 |
| Lead, pounds | 369,242,600 | 17,243,601 |
| Silver, ounces | 12,933,619 | 6,426,715 |
| Tungsten, pounds | 54,000 | 81,000 |
| Zinc, pounds | 93,410,000 | 12,993,331 |

| | |
|--------------------------------|---------------|
| Total value in 1915 | \$39,315,311 |
| Total value in 1914 | \$24,976,706 |
| Grand total for 55 years | \$704,314,681 |

Antimony and tungsten have not been recorded for many years.

The past year was the most prosperous in the history of Idaho mining. Progress in development was decidedly marked, and expansion is certain throughout, especially in the Coeur d'Alene region, regarding the geology of which Mr. Bell gives a long chapter. The various counties are briefly reviewed, the Snake River fine gold, phosphate and potash deposits, antimony, asbestos, coal, and tungsten. There were up to 7500 men employed, with an average of 6500, an increase of 1300. There were 23 fatal accidents in all operations, equal to 3.54 per 1000 employed, against 5.19 in 1914.

In Bulletin 620-L of the U. S. Geological Survey, J. M. Hill

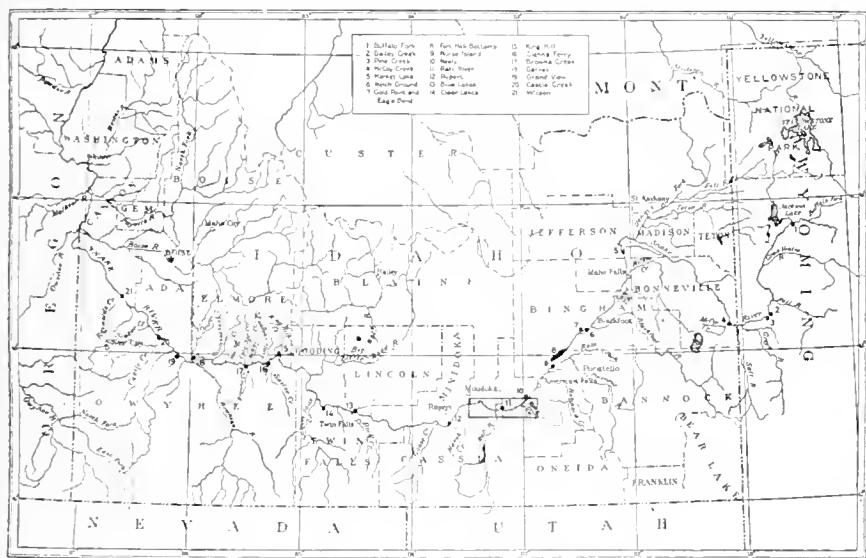

SKETCH MAP OF SOUTHERN IDAHO, SHOWING MAIN TRIBUTARIES OF SNAKE RIVER AND PRINCIPAL LOCALITIES AT WHICH PLACER WORK HAS BEEN DONE.

discusses the fine gold of the Snake river, which rises in Shoshone, Lewis, and Heart lakes, in the south-eastern part of the Yellowstone National Park. The area of the river basin above the mouth of Rattlesnake creek is 37,000 sq. miles. The placer gold deposits along the river may be classed as stream and bench; the former are often temporary, the latter are older and at higher levels. The gold is in minute particles, most of which are flat, and from 1000 to 2000 colors are required to be worth one cent. It is 945 fine. Since 1902, \$149,315 has been recovered from the river above the mouth of the Boise river; but the yield is probably more. A large number of gold-saving devices were used to save the fine gold. Even cyaniding has been tried.

MICHIGAN

THE COPPER COUNTRY

(Special Correspondence.)—Recent prices paid for land in the vicinity of the Mohawk and the Ahmeek properties are the

highest ever paid. This should not lead to a misconception that other lands, carrying minerals, can be sold at similar figures. The prices paid were unusually high, but the value was certainly assured. A minimum price of \$500 an acre for land that may possibly carry mineral, or may adjoin some valuable working property, or some likely looking prospect, cannot always be counted on.

Houghton, March 7.

MISSOURI

JASPER COUNTY

Within the next two months \$500,000 will be spent in the Missouri-Kansas-Oklahoma region in the erection of new concentrating plants. They range from 500 to 150 tons per shift.

Discussing present conditions in the zinc-lead region the *Joplin News Herald* states that machinery companies never before knew the like of the demand for all kinds of mill equipment. Scores of costly new concentrating plants have been ordered for all parts of the district. Orders for new mills are coming in to the larger companies at the rate of one or two a day. On one occasion last week the Webb City-Carterville Foundry Co. closed contracts for five new mills in the course of one day. It would be difficult to estimate the population of Joplin as a result of the influx of people brought here by the high price of ore. It is certain that the normal population of 36,000 has been swelled to something like 50,000, and vacant houses are at a premium. Rental properties are hard to find and rents are 100% higher than they were three years ago. Hotel facilities are not adequate to meet the requirements of the strangers in the city, and for this reason extensive improvements in hotel accommodations and in apartment-house facilities are contemplated.

Owing to the increased price of chemicals, assayers at Joplin, Webb City, and Galena have standardized and raised charges. The following prices are asked for assays: zinc, 75c.; zinc and moisture, \$1; zinc, iron, and moisture, \$1; lead, \$1; sulphur, \$1; lime, 75c.; silicate and blende, \$1.50; moisture, 25c.; zinc and iron, \$1; lead and moisture, \$1.25; and zinc in tailing, drill cuttings, etc., \$1.

Oklahoma oil-men have purchased the McDonald mine at Prosperity for \$175,000. Ore is mined at 180 ft. A good 350-ton mill is part of the equipment.

The Tom C. mine of the Prosperity district, bought last September by T. F. Coyne for \$15,000, has been sold by him to R. R. Conklin of New York for \$150,000. A 200-

ton mill, which yields 63% blende is included. Fifty men are employed.

A 250-ton mill is to be erected by the Evans-Hall-Soy company in the Duenweg district.—In the seventh drill-hole of Molloy, Cameron & White, at Duenweg, 9.06% blende was cut from 130 to 180 ft. depth.—The Wilson mine at Duenweg has been sold to the Onamena Mining Co. for \$100,000.

NEVADA

HUMBOLDT COUNTY

During February the Nevada Paekard mill produced \$15,587, work being affected by bad weather. The March yield is expected to be \$20,000. The plant treats 100 tons a day. At the end of March extraction of ore will commence from the fine shoots opened in adits B, C, and D.

A compressor and machine-drills will probably be installed at the Paekard North Extension mine, where development is encouraging.

LYON COUNTY

Officials of the Nevada Douglas company consider that the leaching plant will produce copper at 6¢ per lb. from 3½ ore. Fine grinding machines have been ordered to pass the ore through 60 mesh, doubling the Wedge furnace capacity. About 25 tons of metal has been precipitated, and the first shipment made. The annual report shows that revenue during 10 months ended December 31 was \$24,197, four assessments realizing \$375,919, bank loans, \$80,500, and sales of ore, \$36,974. Mill construction cost \$117,152, and development, \$38,968. By the purchase of the Western Nevada mine, reserves are increased by 250,000 tons of 3.5% ore.

MINERAL COUNTY

(Special Correspondence.) Jesse Knight of Utah, Adams and O'Neil of Los Angeles, and J. H. Miller of Hawthorne, last December bought the Golden Pen mine, which up to that time had been a shipper of ore, worth from \$116 to over \$1000 per ton, with smaller shipments going as high as \$18 per pound. All the new owners visited the Golden Pen mine in the last week in February. Work has been done steadily since its purchase, and it is reported that plans have been made for extensive development, which includes a plant to treat the bodies of mill ore already opened. All ore of shipping grade has been broken during development, and a shipment of 60 tons of \$100 ore is now being hauled to the railroad.

A 10-ton shipment, from the Miller-Meaker lease on the Queen Regent Merger Mines Co., has been sent to the Hazen sampler. The company reports that the west drift on the second level in the main shaft, out 120 ft. is in good ore of improving value.

The Last Hope mine was recently sampled by engineers for George Wingfield, and it is said that it will be taken over by him, and extensive development undertaken. The mine has already shipped \$20,000 worth of high-grade ore from shallow workings.

On the Ed. Lappart group of 17 claims, three leases were let during February, and already from the Stockton and Gardner lease, a carload shipment has been made. One of the other lessees states his first carload will be sent out inside of 30 days.

S. W. Van Syckel of Newark, New Jersey, has taken an option on a group of claims.

Rand, February 28.

At the Luning Idaho mine, north of New York canyon in the Luning district, a large tonnage of 6% copper ore has been developed. Road construction is to be started when the ground is dry. John S. Skuse is in charge.—Near-by is the Nevada Champion mine, the management of which has made a contract with the Western Ore Purchasing Co. for 30,000 tons.

NYE COUNTY

Tonopah mines produced 8311 tons worth \$171,858 last week. At 15.0% in the Extension the vein is 32 ft. wide.

UTAH

BOXELDER COUNTY

Wages have been increased 25¢ per shift at the Lakeview zinc mine on Promontory point, Great Salt Lake; 130 men will benefit.

SALT LAKE COUNTY

During 1915 the Bingham Mines Co. shipped 41,975 tons of ore, containing 2,244,978 oz. lead, 1,221,219 lb. copper, 188,216 oz. silver, and 3399 oz. gold. The profit was \$95,465. This company controls the Eagle & Blue Bell of Tintic.

During 1915 the Utah Metal & Tunnel Co. in seven months, and its Bingham-New Haven mine in twelve months, produced a total of 16,914 oz. gold, 475,894 oz. silver, 9,860,689 lb. lead, and 2,873,815 lb. copper. Net profits were \$329,628. In January 1916 the Bingham-New Haven yielded 704,155 lb. lead and 348,096 lb. copper. The profit was \$103,824, while that of the Utah Metal was \$45,000, making \$148,824 for the month.

At Garfield a 100-ton sulphuric-acid plant is to be erected, to be in operation by August 1, by the Garfield Chemical & Manufacturing Co. The A. S. & R. Co. is said to be interested in the project. E. L. Newhouse, Jr., is manager.

SUMMIT COUNTY

Seventy men are at work for the Federal Leasing Co. in the upper workings of the Ontario mine at Park City.

TOOELE COUNTY

The International smelter at Tooele was recently visited by officials of the A. S. & R. Co. Two units of the Cottrell furnace plant are in operation, while material for the lot is arriving. The whole will cost \$160,000.

WASHINGTON

FRY COUNTY

(Special Correspondence.)—In the Belcher Mountain mines are extensive deposits of iron-sulphide ore, which contain small gold and silver values, with prospects for copper in the lower levels. The Copper Key is to be drilled by Boyle brothers for the Granby Consolidated company, which is said to be negotiating for the property.

During January and February the Lone Pine mine produced 24 carloads of ore, assaying \$12 per ton, mostly from the 450-ft. level. Last week it produced 130 tons.—In the suit of the Lone Pine-Surprise Mining Co. v. the Insurgent Gold Mining and Insurgent Leasing companies, the Superior court has rendered a decision in favor of the defendants. The suit was for the value of ore alleged to have been taken by the leasing company from Lone Pine ground.

In the Enterprise district, near Covada, the adit at the Syndicate mine is in 950 ft. A contract has been let to extend it 50 ft., in expectation of cutting the Rising Sun vein, which has been opened by the Advance Mining Co. on adjoining property, at a depth of 600 ft. The Syndicate company has operated 14 years, spent \$25,000 on development, and has sold no shares.

Republic, March 3.

SILVER COUNTY

(Special Correspondence.) The Silver Queen mine, near Kettle Falls, in which development was started over 20 years ago, recently shipped its first carload of ore to the smelter.

The Byron E. Sharp Mining Co., owning 10 claims which produced \$300,000 from near the surface in early years, and was abandoned because of the ore containing zinc, proposes to re-open this, the Cleveland group. The property is situated north of Springdale. About 15,000 tons of ore is reported to be on the dump and developed above the adit-level. The ore contains silver, lead, zinc, and antimony. A 50-ton concentrator will be installed.

A Spokane syndicate has taken over all the property of the Orient Gold Mines and will begin extensive development and the erection of a cyanide mill as soon as spring opens.

Springdale, March 3.

During 1915 the United Copper mine, near Chewelah, received \$117,269 from smelter settlements on crude ore and concentrate. The products yielded copper, gold, and silver. The company operated at a loss, the gross indebtedness being \$111,553. The mine is in good condition.

No. 1 lead furnace was blown-in at the Northport smelter last week; No. 2 will soon follow. There is plenty of material to smelt.

At the Electric Point mine a good deal of ore has been developed, and ready for shipment is 1000 tons of carbonate and over 500 tons of very rich lead ore.

WYOMING

LINCOLN COUNTY

In Bulletin 620-O of the U. S. Geological Survey, G. R. Mansfield describes the work of a reconnaissance for phos-

phate in the Salt River range. Certain land in the area was withdrawn, and the presence or absence of phosphate beds west of the crest of the range was the subject of investigation. Indications point to the fact that the deposits are probably inferior to those in south-eastern Idaho, both in thickness and quality. A considerable body of medium-grade rock occurs, which may be considered as a valuable reserve deposit. It is not likely that the mineral in this area will be of any notable importance in the near future.

CANADA

BRITISH COLUMBIA

A sulphuric-acid plant is to be erected at the Trail smelter to supply the zinc and lead refineries. The copper refinery will need the acid later on.

ONTARIO

Electric power is to be available for Kirkland Lake companies, as the Northern Ontario Light & Power Co. is to supply the current. This is of importance to the district.

HONDURAS

René Kilhauer is developing silver-zinc mines at Valle de Angeles. The San Antonio mines, near Tegucigalpa, formerly owned by Callejas, have been sold to a New Orleans syndicate. The mill at the Socorro mines has been closed down, and is being re-erected on the Santa Helena property, near Santa Lucia. Attempts are also being made to sell the Danli gold mines, but the scattered character of the rich pockets has made it difficult to operate on a systematic scale.

MEXICO

Smelting operations in Northern Mexico, notably Monterrey, Matehuala, and Chihuahua, are again interrupted by the political complications. The American Smelting & Refining Co. has called all its employees out of Mexico. This is particularly regrettable, as a new start had been made at several of the plants.

HIDALGO

During January, Santa Gertrudis made a profit of \$80,000 from 20,503 tons of ore. The report for the last quarter of 1915 shows that 58,532 tons of ore gave a profit of \$135,000. Development totaled 4441 ft., 2342 ft. being in payable ore. Sinking was resumed at the 20th level Counter shaft. The mill worked at 60% capacity. There are ample supplies for full time, but labor is lacking, and is likely to continue so until the country is more settled.

SONORA

It is estimated that over 15,000 burros are needed to carry ore between Cuppas and Nacozari.—The Nacozari Consolidated mines, near Pilares de Nacozari, is shipping ore regularly to El Paso. The mine is in good condition. A roasting-plant is to be erected to desulphurize the zinc ore.—A number of mines near Nacozari are to be re-opened, including the Promontorio of Phelps, Dodge & Co., 25 miles south of Moctezuma.

Shipments of minerals from Sonora through Agua Prieta during February totaled 9391 tons, valued at \$2,015,700. Nacozari sent 9126 tons of copper and El Tigre 6204 lb. silver bullion. The estimated value of copper, gold, and silver was \$1,429,000, \$198,000, and \$388,700, respectively.

Considerable activity is reported from Cananea. The Cananea Consolidated has eight blast and two reverberatory furnaces in operation. The Puertecitos mine is supplying rich ore. The first 1000-ton flotation unit is working, the second soon will be.—The Democrata company has 400 men and two furnaces treating 500 tons of ore daily.—Lead-zinc-silver concentrate is being produced by the Duquesne company from the Catalina mine.—Lack of transport facilities is hampering the Santa Cruz district, a little south of Cananea.

PERSONAL

C. R. CORNING is in Cuba.

ROBERT B. ROGERS is at the Plaza hotel.

ALBERT L. WATERS is at Globe, Arizona, for a few weeks.

P. KIRKEGAARD is opening some gold mines at Cordova, Ontario.

W. E. THORNE is expected in London from the Lena district, Siberia.

G. G. S. LINDSEY is expected in London on his return from China.

C. R. PINDER is consulting engineer to the Mexico Mines of El Oro.

C. H. BENEDICT, metallurgist to the Calumet & Hecla is in Florida, on a holiday.

ROGER W. STRAUSS, of the Guggenheim organization, was in San Francisco this week.

E. A. CAPPELEN SMITH has been elected a director of the Chile Copper Company.

GEORGE J. ADAMS has been appointed Professor of Mining Geology at the Peking university.

WILLIAM RALPH has been appointed superintendent of the Tarbox mine near Saltsee, Montana.

MARK HARRIS, superintendent of the Adirondack mine at Sheridan, Washington, is at Portland.

FRANK A. ROSS, of Spokane, has been appointed the Washington representative on the Naval Consulting Board.

LEON J. PEPPERBERG, consulting geologist and engineer, announces the removal of his office to 718 New Call building, San Francisco.

LAFAYETTE HANCHETT has been selected by the Utah section of the A. I. M. E. as State representative on the Naval Consulting Board.

S. A. WOOLEY, of the Hollinger, is manager of the Schumacher mine, in place of J. HOUSTON, now assistant-manager of the Dome, at Porcupine, Ontario.

MORTON WEBBER, who has held a commission with the Royal Field Artillery in France, Gallipoli, and Serbia successively, has been invalided home, and is now at the Ritz hotel, London.

FREDERICK G. CLAPP and MYRON L. FULLER, the managing geologists of the Associated Geological Engineers, announce the opening of a New York office at 3112 Equitable building, 120 Broadway, in charge of Mr. Clapp, managing geologist of the petroleum division.

Schools and Societies

The Department of Geology of PRINCETON UNIVERSITY has published its announcement for 1916-1917. Details are given of the courses offered and examinations.

The last Bulletin of the MASSACHUSETTS INSTITUTE OF TECHNOLOGY contains the report of the president, Richard C. Maclaurin, also the reports of administrative officers. There are 1900 students registered, a record. The staff totals 208 instructors. Gifts received during 1915 amounted to \$877,815. The operating revenue from all sources was \$721,704, and expenses \$678,782.

The U. S. Civil Service Commission announces an open competitive examination for assistant technologist in oil and gas production. From the register of eligibles resulting from this examination, certification will be made to fill a vacancy in this position in the Bureau of Mines, for service in the field, at a salary ranging from \$1800 to \$2100 per annum. Applications must be filed at Washington, D. C., by April 4, 1916.

THE METAL MARKET

METAL PRICES

San Francisco, March 14

| | |
|---|-----------|
| Antimony, cents per pound | 44 |
| Electrolytic copper, cents per pound | 27.75 |
| Pig lead, cents per pound | 6.95-7.90 |
| Platinum, soft metal, per ounce | \$88 |
| Platinum, hard metal, 90% triidium, per ounce | \$92 |
| Quicksilver, per flask of 7 1/2 lb. | \$245 |
| Spelter, cents per pound | 22 |
| Tin, cents per pound | 16 |
| Zinc dust, cents per pound | 30 |

ORE PRICES

San Francisco, March 14

| | |
|--|-------------|
| Antimony, 50% product, per unit of 10, or 20 lb. | \$2.25 |
| Chromite, 40% and over, 600 cars California, per ton | 11.00 |
| Magnesite, crude, per ton, 600 cars California | 8.00 |
| Magnesite, plastic, no iron and lime, calcined, ton | 30.00 |
| Magnesite, refractory, 11% iron, dead-burned, ton | 35.00 |
| Manganese, 50% metal, 8% silica, per ton | 12.00 |
| Tungsten, minimum 50% Wob., per unit of 20 lb. | 60.00-65.00 |

In the March Bulletin of the Canadian Mining Institute the production of molybdenum ores is discussed by Henry E. Wood of Denver, Colorado. While it is desirable to make a large-grade product, it is not essential, and 70 to 75% concentrate will bring proportionately as much per pound of molybdenum content as one of 80 or 90%. The demand for molybdenum is likely to be maintained and increased. Molybdenum is four times the price of two years ago, compared with ten times in the price of tungsten.

New York, March 9

| | |
|---------------------------------|--------|
| Antimony, 50% product, per unit | \$2.70 |
| Tungsten, per unit | \$0.00 |

These prices are for small quantities. In molybdenum no business is being done.

EASTERN METAL MARKET

(By wire from New York.)

March 14. Copper is firm, but there are no buyers; spot lead is scarce, but there are plenty of buyers but no sellers; spelter is dull and quiet, with London very weak.

SILVER

Below are given the average New York quotations, in cents per ounce of fine silver.

| Date | Average week ending | | | | |
|-----------|---------------------|--------|-------|--|--|
| 18 | 56.75 | Feb. 2 | 57.02 | | |
| 9 | 56.75 | " 9 | 56.79 | | |
| 10 | 56.75 | " 16 | 56.62 | | |
| 11 | 56.75 | " 23 | 56.86 | | |
| 12 Sunday | | 1 | 56.79 | | |
| 13 | 56.62 | " 8 | 56.75 | | |
| 14 | 56.62 | " 14 | 56.48 | | |

| 1914 | | 1915 | | 1916 | |
|------|-------|-------|-------|-------|-------|
| Jan. | 57.78 | 48.87 | 56.76 | July | 54.90 |
| Feb. | 57.78 | 48.45 | 56.74 | Aug. | 54.35 |
| Mar. | 58.03 | 50.83 | 56.75 | Sept. | 53.75 |
| Apr. | 58.21 | 50.25 | 56.75 | Oct. | 53.12 |
| May | 58.41 | 49.87 | 56.75 | Nov. | 49.12 |
| June | 58.43 | 49.07 | 56.75 | Dec. | 49.27 |

The silver market is fairly steady, depending mostly on European supplies. It has been quiet, although China bought a little. Exports from London to India in February 19 were 6,100,000 oz., less than in that period of 1915. American supplies in London have been small. Prices are a concern for Serbia and Montenegro.

COPPER

Prices of electrolytic in New York, in cents per pound.

| Date | Average week ending | | | | |
|-----------|---------------------|--------|-------|--|--|
| 18 | 26.75 | Feb. 2 | 25.45 | | |
| 9 | 26.50 | " 9 | 26.16 | | |
| 10 | 26.50 | " 16 | 27.06 | | |
| 11 | 26.50 | " 23 | 27.25 | | |
| 12 Sunday | | 1 | 27.12 | | |
| 13 | 26.50 | " 8 | 26.62 | | |
| 14 | 26.50 | " 14 | 26.59 | | |

| 1914 | | 1915 | | 1916 | |
|------|-------|-------|-------|-------|-------|
| Jan. | 14.21 | 12.80 | 24.26 | July | 13.26 |
| Feb. | 14.46 | 14.78 | 26.62 | Aug. | 12.34 |
| Mar. | 14.11 | 14.80 | 26.62 | Sept. | 12.62 |
| Apr. | 14.19 | 16.64 | 26.62 | Oct. | 11.10 |
| May | 13.97 | 18.71 | 26.62 | Nov. | 11.75 |
| June | 13.60 | 19.77 | 26.62 | Dec. | 12.75 |

During February the Inspiration produced 8,300,000 lb. copper. Greene Cananea yielded 5,180,000 lb., 838,000 lb. of which was custom metal.

Almoeck will pay \$3, Alibouze \$1.50, and Occochea \$1 per share. The copper situation in Canada from the consumer's point of view is discussed in the March Bulletin of the Canadian Mining Journal by G. C. Brown. The output in 1915 was 102,000,000 lb., an increase of 26,000,000 pounds.

LEAD

Lead is quoted in cents per pound, New York delivery.

| Date | Average week ending | | | | |
|-----------|---------------------|--------|------|--|--|
| 18 | 6.70 | Feb. 2 | 6.10 | | |
| 9 | 6.80 | " 9 | 6.12 | | |
| 10 | 6.85 | " 16 | 6.26 | | |
| 11 | 6.85 | " 23 | 6.30 | | |
| 12 Sunday | | Mar. 1 | 6.30 | | |
| 13 | 6.85 | " 8 | 6.60 | | |
| 14 | 6.85 | " 14 | 6.82 | | |

Monthly averages.

| 1914 | | 1915 | | 1916 | |
|------|------|------|------|-------|------|
| Jan. | 4.11 | 3.73 | 5.95 | July | 3.80 |
| Feb. | 4.02 | 3.83 | 6.23 | Aug. | 3.86 |
| Mar. | 3.94 | 4.04 | 6.23 | Sept. | 3.82 |
| Apr. | 3.86 | 4.24 | 6.23 | Oct. | 3.60 |
| May | 3.90 | 4.24 | 6.23 | Nov. | 3.68 |
| June | 3.90 | 5.75 | 6.23 | Dec. | 3.80 |

QUICKSILVER

The primary market for quicksilver is San Francisco, California being the largest producer. The price is fixed in the open market, according to quantity. Prices, in dollars per flask of 75 pounds:

Week ending

| Date | 1914 | | 1915 | | 1916 | |
|-----------|------|-----|------|-----|------|-----|
| 18 | 300 | 285 | 300 | 285 | 300 | 285 |
| 9 | 300 | 285 | 300 | 285 | 300 | 285 |
| 10 | 300 | 285 | 300 | 285 | 300 | 285 |
| 11 | 300 | 285 | 300 | 285 | 300 | 285 |
| 12 Sunday | | | | | | |
| 13 | 300 | 285 | 300 | 285 | 300 | 285 |
| 14 | 300 | 285 | 300 | 285 | 300 | 285 |

Monthly averages.

| 1914 | | 1915 | | 1916 | |
|------|-------|-------|--------|-------|-------|
| Jan. | 29.25 | 51.90 | 222.00 | July | 37.50 |
| Feb. | 39.00 | 60.00 | 255.00 | Aug. | 80.00 |
| Mar. | 39.00 | 78.00 | 255.00 | Sept. | 76.25 |
| Apr. | 38.90 | 77.50 | 255.00 | Oct. | 53.00 |
| May | 39.00 | 75.00 | 255.00 | Nov. | 55.00 |
| June | 38.60 | 90.00 | 255.00 | Dec. | 53.10 |

The market in New York is dead, with no takers at the above quotation.

ZINC

Zinc is quoted as spelter, standard Western brands, New York delivery, in cents per pound.

| Date | Average week ending | | | | |
|-----------|---------------------|--------|-------|--|--|
| 18 | 19.25 | Feb. 2 | 18.67 | | |
| 9 | 18.75 | " 9 | 19.08 | | |
| 10 | 18.25 | " 16 | 19.92 | | |
| 11 | 17.75 | " 23 | 21.35 | | |
| 12 Sunday | | 1 | 20.71 | | |
| 13 | 17.50 | " 8 | 19.92 | | |
| 14 | 17.50 | " 14 | 18.17 | | |

Monthly averages.

| 1914 | | 1915 | | 1916 | |
|------|------|-------|-------|-------|------|
| Jan. | 5.14 | 6.30 | 18.21 | July | 4.75 |
| Feb. | 5.22 | 9.05 | 19.99 | Aug. | 1.75 |
| Mar. | 5.12 | 8.40 | 19.99 | Sept. | 5.16 |
| Apr. | 4.98 | 9.78 | 19.99 | Oct. | 4.75 |
| May | 4.91 | 17.03 | 19.99 | Nov. | 5.01 |
| June | 4.81 | 22.20 | 19.99 | Dec. | 5.40 |

On March 31 the Consolidated Interstate-Callahan company of Idaho will pay \$1.50 per share, or \$657,485. Since April 1, 1915, the total paid is \$7 per share, equal to \$2,254,939.

The Butte & Superior company is paying the American Zinc, Lead & Smelting Co. at the rate of \$2,500,000 per year for treating 8000 tons of concentrate per month, equal to \$13 per share on the latter's 193,000 shares.

TIN

Prices in New York, in cents per pound.

| 1914 | | 1915 | | 1916 | |
|------|-------|-------|-------|-------|-------|
| Jan. | 37.85 | 34.40 | 41.76 | July | 31.60 |
| Feb. | 39.76 | 37.22 | 42.80 | Aug. | 50.20 |
| Mar. | 38.10 | 48.76 | 42.80 | Sept. | 23.10 |
| Apr. | 36.10 | 48.25 | 42.80 | Oct. | 30.40 |
| May | 33.29 | 39.28 | 42.80 | Nov. | 32.51 |
| June | 39.72 | 40.26 | 42.80 | Dec. | 33.60 |

Tin is firm at 55 cents.

In Sweden antimony is \$2.37 per lb., aluminum \$1.25 per lb., and tin \$1.40 per lb. This is the result of the War.

Eastern Metal Market

New York, March 9.

The copper market is dull, and quotations are much easier, a condition which is attributed, more than to any other cause, to difficulties in making deliveries in New England. Great Britain has modified her regulations, which were announced on March 1, designed to stop speculation in materials needed for the manufacture of munitions. The order, which prohibited dealings in futures, has not so far lessened the cost of electrolytic copper, which stands at £136. The regulations, or some other influence, has brought down the London quotation for zinc sharply. The domestic market for zinc is dull and much lower. Lead is soaring, independent producers having obtained 7c. per lb., although the A. S. & R. Co. quotes 6.60c. The demand is heavy, and a scarcity of spot lead seems imminent. The independents will soon be sold-up, some of them are already, and then the A. S. & R. Co. will have the field to itself. Meanwhile the big interest is thought to be loading up with ore and raw materials on the basis of its quotations. It is selling at 6.60c., but to a restricted degree. Tin is tightly held to cover old contracts; Great Britain is being stricter than ever in the matter of issuing licenses to ship. Antimony and aluminum continue firm, and little is to be had of either for spot shipment.

Blast-furnaces and steel-mills are making new production records. The railroad-freight embargoes and car shortages are more severe than ever, and holding up shipments of both raw materials and finished products. Shipments to New England points and to the Atlantic seaboard are particularly difficult to get through. Shippers are now fearing a general railroad strike, on which the men have been taking a vote.

COPPER

The market has become very quiet, and quotations have continued to grow easier, until near-by deliveries of electrolytic are to be had at from 26.50 to 27c., cash, New York. The action of Great Britain, referred to a week ago, prohibiting dealings in future positions of the metals has had but little effect on the New York market, and not so much on London as was expected, as electrolytic in the latter city is still quoted at £136. Standard copper at London, however, has declined heavily. The new regulation in its original and severest form was only in existence four days, March 1 to 4, and on those days no prices were cabled to the New York Metal Exchange, as the metal exchanges at London and Glasgow were practically closed. The British Ministry of Munitions yielded on March 4 to the importunities of the British metal-dealers. As a result the order was modified to the extent of not applying to purchases made outside of the United Kingdom. The modification read: "The new regulations will not be enforced in the case of purchases made outside the United Kingdom until the metal reaches this country. Export orders and sales to allied or neutral countries through authorized channels will be treated as consumers' orders."

More effective than the British order, in making trade quiet, has been the bad railroad situation existing in the East, and which is steadily growing worse. Brass-mills in New England are hungry for copper, which cannot be delivered to them because of the embargoes on the New York, New Haven & Hartford railroad and other lines. How irregular deliveries are is indicated by the case of a New Jersey rolling-mill. It was clamoring for copper, then in one morning had 16 carloads placed on its railroad siding with instructions to unload within 48 hr. or pay demurrage. At the same time the ground was covered with over a foot of snow. It can again be pointed out that plenty of spot electrolytic copper is now available, in

spite of the repeated declarations of a scarcity, heard on all sides a few weeks ago. Lake is nominally quoted at 27c., cash. Exports this month total 4167 tons, up to and including the 8th.

ZINC

Inability to make deliveries in New England, and to a lesser extent in other directions, because of the railroad-freight congestion, has had a serious effect on zinc. For a week prices have been on the down-grade, and the market today is not far from 18.75c., New York, for prime Western. Offerings at concessions are plentiful but consumers are staying out of the market. The London spot market dropped £8 on the 6th, and £4 more on the 8th, and it is thought that prices are being adjusted there to accord with the wishes of the Ministry of Munitions. A continuance of the decline will start buying on the part of the galvanizers, most of whom lose interest when the quotation rises above 17 cents.

The quotation for sheet-zinc is unchanged at 25c., f.o.b. mill, carload lots.

LEAD

A most peculiar situation prevails in this metal. Independent sellers sold their product yesterday at from 6.75 to 7c., while the A. S. & R. Co. was quoting and, to a limited degree, selling at 6.60c. The leading interest advanced its quotation on the 3rd to 6.40c., New York, or \$1 per ton, a move which astonished the trade, inasmuch as independents were then selling at 6.75c., and finding many buyers for their offerings. Both the foreign and domestic demand has been good. Buyers have seemed willing to pay almost any price. On March 6, the A. S. & R. Co. announced another advance, this time \$4 per ton, bringing its New York price to 6.60c. Sales were made yesterday by independents at 7c. A peculiar phase of the situation is that New York and St. Louis are on a parity. Under the circumstances the only manner in which prices may be gauged is to give both price levels, or to strike an average between those of the big company and those of the smaller producers. The crux of the whole situation is that near-by lead is scarce and becoming more so. The big interest is selling only to its regular customers and then only in such quantities as it, and not the customers, believes should be doled out. The independents are rapidly becoming sold-up, only a few remain in the market, and these can command the high prices alluded to. The London market is gaining strength. Exports from the 1st to the 8th totaled 701 tons.

TIN

Moderate quantities have been taken in the past week, but the general aspect of the market has been dull. Prices, however, are firm and promise to go higher. The quotation yesterday was 49c. for spot. It is steadily becoming more and more difficult to obtain licenses to ship from London and the Straits Settlements, and brokers here are unwilling to sell, inasmuch as they may need the metal to cover old contracts. This condition exists despite the fact that there is a fair quantity here, and a large quantity is afloat. Arrivals this month, up to the 8th, totaled but 145 tons. There was afloat on that day 6558 tons.

ANTIMONY

The market is firmer than ever, with Chinese and Japanese grades quoted at 44 to 45c., duty paid. For needle antimony 24½c. has been bid for good-sized quantities.

ALUMINUM

Quotations for No. 1 virgin aluminum, 98 to 99% pure range from 61 to 64c. New-comers in the market must pay high for this metal; the regular consumers like the automobile companies obtain their metal much lower under contracts.

MINING DECISIONS

NEW MINING REGULATIONS

The Mining Regulations of the Land Department have been revised and a copy of the new regulations dated August 6, 1915, has just been printed in Vol. 14 Land Decisions and Vance sheets, page 285 of seq.

MINERAL LANDS DO NOT INCLUDE FOSSIL DEPOSITS

Fossil remains of dinosaurs and other pre-historic animals having a value for scientific research are not minerals, within the meaning of the United States mining laws, and lands containing such remains are not subject to entry under such laws.

In re Douglass (Land Department), 14 Land Decisions, 375 August 6, 1915.

MINING LEASES—TAXATION

The mining royalties required to be paid to the lessor under a mineral lease are assessable and taxable as "credits" for the year in question and are in the same category as rent's.

State v. Royal Mineral Association (Minnesota), 156 Northwestern L.S., February 4, 1916.

RESIDENCE OF MINE OWNER—DISCHARGED EMPLOYEE

A man who had been employed in a mine as a foreman, had quit, and was returning to get his tools and pay-check when killed by a gas explosion. Held, that he was entitled to protection under the provisions of a miner's safety-act, and his widow was permitted to recover damages for his death resulting from a violation of such provisions.

Romani v. Shoal Creek Coal Co. (Illinois), 111 Northwestern, 88, February 4, 1916.

OIL LEASE—MEASURE OF DAMAGES FOR BREACH

The lessee of oil-land, after driving a well to a great depth and at considerable expense, violated an express provision of his contract by withdrawing the well casing. Held, on suit by the lessor for damages, that inasmuch as the land had been proved to be without value for oil, the measure of damages should be the value of the casing when removed, and not the cost of replacing it or driving a new well.

Jenkinson v. Hinkle (California), 154 Pacific, 487, January 28, 1916.

OIL LAND NOT TO BE PARTITIONED IN KIND

A lessee under a mineral contract may not contest the title of his lessor as an owner of an undivided interest with others, and compel him and his co-owners to make a judicial partition in kind of the property leased. Known oil-lands, like mines, cannot be judicially partitioned in kind, on the suit of one of the co-owners. A lot without oil under the surface falling to one co-owner would work incalculable damage to him to whom it was awarded, due entirely to the consequence of dividing the land.

Gulf Refining Co. v. Hume (Louisiana), 79 Southern, 569, January 10, 1916.

All mining exports during 1915 were 8,544,834 lb. as metal and \$60,865 value of manufactured metal, against 16,241,349 lb. and \$130,809 lb. in 1914. Exports of domestic metal and manufactures amounted to \$3,682,417, compared with \$1,546,510 in 1914 and \$969,994 in 1913.

ANTIMONY IMPORTS in 1915 totaled 3,374,912 lb. in ore, and 17,484,930 lb. as metal, compared with 1,986,982 lb. and 13,970,381 lb. respectively in 1914.

COMPANY REPORTS

NATOMAS COMPANY OF CALIFORNIA

The gross earnings of the dredging department of this company in 1915 were \$2,416,960. Net earnings totaled \$1,675,076, as follows: dredges, \$1,324,953; rock crushing plants, \$153,398; and water, land, rentals, crops, etc., \$196,816. In 1914 the total was \$1,548,970. After paying interest on bonds and notes there was \$833,767 over, of which \$831,592 was written off for depreciation.

EAGLE & BLUE BELL MINING CO.

The report of the Eagle & Blue Bell Mining Co. of Tintic, Utah, for 1915 shows the following results: Development covered 3350 ft. This opened a silver-lead orebody, which was first encountered on the 1550-ft. level in 1911. Stopping was in progress on the deposit, proving it continuous for 400 ft. in length, averaging 60 ft. wide and extending from a point 129 ft. above the 1550-ft. level down to a point 100 ft. below the 1700-ft. level. This gives this immense orebody a vertical depth of 370 ft. Ore shipments totaled 26,745 tons, containing 1228 oz. gold, 141,263 oz. silver, 8,275,731 lb. lead, and 3896 lb. copper. Gross revenue was \$493,678, and profit \$113,315, of which \$133,972 was paid in dividends.

OSCEOLA CONSOLIDATED CO.

The past three years of this Michigan company compare as follows:

| | 1915. | 1914. | 1913. |
|----------------------------------|-------------|-------------|-------------|
| Ore treated, tons..... | 1,361,089 | 1,168,147 | 735,044 |
| Copper in ore, pounds per ton.. | 14.5 | 13.5 | 15.4 |
| Refined copper, pounds..... | 19,731,472 | 14,979,737 | 11,325,910 |
| Price received, cents per pound | 18.19 | 13.14 | 15.48 |
| Cost, cents per pound..... | 10.03 | 10.79 | 12.30 |
| Revenue..... | \$3,599,798 | | |
| Profit..... | 1,610,860 | | |
| Dividends of \$11 per share..... | 1,957,650 | | |
| Surplus..... | \$2,166,646 | \$1,613,436 | \$1,549,300 |

The Osceola, North and South Kearsarge mines contributed 272,073, 612,831, and 476,185 tons of ore, respectively. On No. 42 level of the first is its best development in recent years.

BRUNSWICK CONSOLIDATED GOLD MINING CO.

If more Californian companies issued such interesting reports as the above for the past year, mining men would know what was being done at the large mines. In the reports of the general manager, R. Chester Turner, and superintendent, C. H. Mallen, are the following notes:

A new steel 85-ft. head-frame and 29-stamp mill were erected at the vertical shaft, resulting in costs being reduced from \$8.45 to \$6.78 per ton. A further drop is expected. Development down to a depth of 1100 ft. amounted to 2905 ft. The shaft is to be sunk to 1300 ft. Reserves are 16,000 tons blocked and ready for stopping, and a good tonnage of low-grade ore indicated by exposed faces. Sorting is to be tried. The mine is a puzzle to miners on account of faults and intrusions in the orebodies.

The old mill worked the full year; the new one from October 18. The respective stamp-duty was 2,616 and 2,998 tons. A total of 22,004 tons of ore was treated, yielding \$223,557, and an operating profit of \$72,565. The new head-frame, mill, etc., cost \$39,751. Three dividends absorbed \$71,152. The year commenced with a balance of \$83,034, and ended with \$49,629, the new equipment accounting for the decrease. Since 1893 the output is \$1,384,844, and dividends since 1906, \$203,315. Interesting mill data will be given in another issue of this journal.



EDITORIAL



T. A. RICKARD, Editor

FLAT RIVER is the great lead-mining district of Missouri. We have arranged for regular correspondence concerning local mining and metallurgical developments. The first of these news-letters appears on another page of this issue.

COPPER is favorably affected by the cessation of smelting operations in Northern Mexico and the possibility of hostilities entailing a supply of munitions for an American army in active service. Purchase of supplies of this metal by the United States Government is reported.

FREE IMPORTATION of dredges and parts thereof, for a period of 10 years after the declaration of peace, is recommended by the consultative committee of gold producers in Russia. Meanwhile, the War is said to be facilitating the stealing of gold, owing to the loosening of organization.

OUR New York correspondent makes interesting comment on the metal market. Evidently the demand for lead has proved too strong for those seeking to keep down the price of that metal. Consumption of metals in the making of munitions proceeds at a tremendous rate, as is indicated by the figures quoted by our correspondent on another page of this issue.

CRITICISM of the use of English by technical men is an ungracious task, for a man is as sensitive in regard to his use of language as he is concerning the cut of his clothes; yet we cannot forbear from protesting against the use of 'uprise' by the author of Bulletin 86 of the U. S. Bureau of Mines. In this paper, on the effect of earthquakes at the Panama Canal, the word 'uprise' is used as a geologic term indicating elevatory movement. The question, we are told, is whether "the canal is in danger of an uprise." It may be in equal danger of a 'downsink.'

WE take pleasure in drawing attention to the article on the pipe-line supplying the Nevada Wonder mine with water, as described in this issue by Mr. J. A. Burgess, the resident manager. It is a good example of what a technical description should be, in that it gives useful information in a straightforward way, assisted by good drawings and just that touch of individuality that lends human interest. The special difficulties against which it was intended to guard and the arrangements effected for that purpose are portrayed with sufficient detail to make the article helpful to other engineers and managers of mines. Excessive cold causes trouble to the

users of water in Western regions, especially those drawing it from high mountains, as is commonly the case. Mr. Burgess describes how the telephone service, flow-indicator, and other protective devices are supplemented by an organization of the staff so that each member of it is ready to act in an emergency. The apparatus for giving warning of a cessation of flow and the electrical coil for preventing this apparatus from being crippled by cold are highly ingenious. We are not surprised at the good reputation of the Nevada Wonder management.

GOOD SENSE, it seems to us, characterizes the attitude of *The Globe*, at Joplin, in regard to the relation of the mines to the smelters in that important zinc district. Our contemporary in Missouri is in agreement with the opinion we expressed several months ago in regard to the demand for a 'smelter trust' investigation, which proved a mere mare's nest of suspicion. Now it is suggested that the best way of aiding the mining industry of the Joplin district is to work for the establishment of an open zinc market in New York. It is claimed that the mine operators are at the mercy of the metal-selling agencies, which fix the price arbitrarily to suit their own extensive speculations. Undoubtedly the New York metal market is anything but healthy in its tone; the brokers are speculators, and those who fix quotations are dealers themselves. If the Department of Commerce cannot be persuaded to make an investigation, it would be worth while for some representative of the mining industry to do so. Why should not the American Mining Congress or the Mining and Metallurgical Society of America justify its name and its reputation by performing this public service?

TAMARACK, as most of our readers know, is the famous copper mine adjoining the Calumet & Hecla, on the Keweenaw peninsula, Michigan. The deepest shaft for metal mining until quite recently was the Tamarack No. 5, which is 5368 feet in vertical length. During the last two years, however, the St. John del Rey shaft, in the Minas Geraes province of Brazil, has sunk to 5826 feet, this being now the deepest metal-mining opening. The original Tamarack enterprise, as planned by Capt. John Daniell, was a shaft to intercept the Calumet & Hecla conglomerate on its dip, which is 38°. This bold venture proved successful, paying \$9,000,000 in dividends between 1888 and 1907; but the conglomerate became so impoverished in depth as to cause abandonment of deeper exploitation. Now the Calumet & Hecla has offered \$59 per share for the remainder of the Tamarack stock, represented by an issue of 60,000 shares, which have sold during recent years

for less than half the figure mentioned. The Tamarack shareholders claim that their stock is worth more than \$50 to the Calumet & Hecla, which, by reason of its position and equipment, can operate the mine at a profit when the Tamarack company itself could make money only when the metal market was highly favorable. It seems to us that a business transaction should be mutually advantageous, and that in this case the Tamarack can afford to sell the mine for less than it is worth to the Calumet & Hecla, while the latter can afford to pay more than it is worth to the Tamarack, the result of such a compromise being to the gain of both, as compared with the spasmodic operation of the mine on Tamarack account.

After the War—II

In a preceding article, we drew the conclusion that if the War should last no longer than twelve months more, the belligerent countries of Europe would not be subject to financial bankruptcy or industrial collapse. Let us proceed to inquire what will be the effects on the industry and commerce of these United States. In the first place, the supply of labor may suffer from a decrease of immigration on account of the contending pulls of patriotism and taxation in the chief countries now at war, and it may be restricted further by Congressional legislation imposing an educational test on those coming to our shores from Europe. If the latter is vetoed again, that check may not become operative, and there is a probability, no matter how the War ends, that the influx of population will be resumed from the countries bordering upon the Mediterranean and the Adriatic, if not from northern and western Europe. However, the rise in the cost of living and the logical demand for higher wages will hinder a too exuberant expansion of industry in the United States. Moreover, the organization incidental to war will not be discarded in a hurry by the European nations; on the contrary, the democracies that lacked organization before the great struggle are likely to maintain that organization for international industrial competition, while German efficiency will be unabated. France, Russia, and England will have learned a lesson. Great Britain is sure to discard her historic policy of free trade and adopt a protective tariff, in the first instance against her chief enemy but probably against the world at large as well, establishing preferential rates with her overseas dominions, which in turn will seek to exclude the manufactures of the Germanic countries. Even if some measure of reciprocity is arranged with the United States, it is not likely that imports into Great Britain, particularly manufactured products, will be as free as heretofore. We anticipate many checks to international trade on this account. The demand for American raw materials and products partly manufactured will be immense, but commerce in finished manufactures will suffer both by reason of tariffs and of economy in Europe. On the other hand, the United States is being given an opportunity to find new customers elsewhere, as in South America and Asia. In such expansion of

trade this country has two advantages, namely, the interval of preparation while her competitors are fighting and the opportunity to accumulate a big reserve of spare capital. At present the first advantage is not being utilized in a large and systematic way except by propaganda in South America, due mainly to the initiative of the National City Bank of New York, but we hope that during the current year more intensive efforts will be made in other parts of the world. As to capital, it is apparent that the enormous export trade, chiefly in grain and munitions, both at high prices, is going to create a vast store of financial energy, which should prove of the most timely assistance in the world-wide industrial competition that is to follow the War. The wealth thus collected should be available for further exploitation in this country itself and for the extension of American enterprise to other regions where attractive opportunities will be afforded, largely by reason of the withdrawal of European initiative in consequence of the War. This applies to mining enterprise more particularly. Let us then consider the effect of the War on the industry in which we—our readers and ourselves—are directly interested.

Unquestionably the demand for metals will be prodigious. Europe has abundant supplies of iron ore and coal, but does not produce sufficient copper, lead, or zinc for her own consumption in ordinary times, much less when an abnormal demand is created, as will be the case when the great work of reconstruction begins in the regions devastated by warfare. Normally the United States consumes all of its lead and nearly all of its zinc, but it exports one-third of the copper extracted from domestic ores, besides nearly as much more from the smelting and refining of foreign ores and mattes, and other forms of copper derived from abroad. The great buyer of American copper is Germany, which consumes 250,000 tons and produces only 25,000 tons per annum. Great Britain and France consume 245,000 tons between them, and produce practically none—about 400 tons per annum. Therefore this country will find a greedy market for the useful metals among the great belligerents, not only now that they are required urgently for the manufacture of munitions but when peace is restored in order to re-build and re-furnish the essentials of modern life.

Another consequence of the War should be the opening of a wider horizon for the American mine operator. Opportunities for using capital productively in mining will be offered in many foreign countries on account of the lack of money for such a purpose in the capitals of Europe. For several years the work of physical reconstruction and industrial rehabilitation will make incessant calls upon the financial resources of London, Paris, and Berlin. There will be some money available for mining, of course, but not so much as heretofore. Speculation in mines abroad will not command European support as it did before August 1914. We believe that this will furnish the American a favorable chance to exploit mineral deposits in Russia, Mexico, South Africa, and South America. The mining capitalist and operator

in this country will find it advantageous to follow the lead of the American engineer and learn to regard mining with a cosmopolitan comprehension, recognizing the fact that this particular industry is the least provincial of all those to which the art of man is applied. Already a start has been made in Russia, Peru, and Chile, for example, not to mention Mexico, where American mining interests have always been large.

Thus we expect to see a notable expansion of enterprise in foreign regions. We anticipate also a great increase of energy and productivity at home, because the demand for the metals to meet domestic consumption and to supply foreign requirements will be increased beyond previous experience. For a while after peace is restored there will be an extraordinary market for American tools and machinery, as well as steel shapes and base metals of every kind. Later there will be less demand for finished products, but a continuing call for the metals themselves. The United States is still a continental area of partly developed and quite unexhausted mineral wealth; being in a state of highly organized industrial vitality, this country can and will furnish a steadily increasing proportion of those metals on which the material civilization of the world depends for its maintenance and progress.

Does the Flag Follow the Trader?

Among the many rumors released by the entrance of an American expeditionary force into Mexico was a story that northern Mexico, to a line going westward from Tampico, was to be sold to the United States for \$300,000,000, which, it was mentioned, was a sum sufficient to enable the Mexican government to meet the accumulated claims for damage done to foreign property during the last three years of misrule. This yarn was promptly squelched, but it is interesting as an expression of the hope of the American exploiters of Mexican mineral and agricultural resources. They, naturally, would like to operate under their own flag, with its promise of political stability, instead of trying to do business under a phantasmagoria of government. It seems late in the day to ask the question as to whether they—adventurers, traders, and business men—are warranted in expecting their home Government to go out of its way to protect them in the security of their property or even their lives while on alien soil. Yet this very question has been raised recently by the Commissioner of Immigration in New York, Mr. Frederick C. Howe, who is of the opinion that the flag does not follow an investment, that the United States is not called upon to use armed force to protect the concessions or to collect the debts of American citizens in foreign countries, meaning those backward countries in which security of property is doubtful. American money to the amount of \$600,000,000 has been invested in the mines of Mexico; according to Mr. Howe, such capital has been risked without any obligation on the part of the United States government to safeguard its security. This is a strange doctrine. Nor is it in accord with the logic of

events. A few weeks ago it was reported on Wall Street that the *de facto* government of Mexico had been refused a loan; we thought we heard a chuckle from the financiers, to whom Carranza is anathema on account of his fantastically radical notions, so completely subversive are they of the *cicntifico* activities that flourished in the good old days of Porfirio Diaz! Undoubtedly, if the ideas of the Commissioner of Immigration were to prevail at Washington, it would not be surprising if the financial groups were to make it impossible for General Carranza to raise money to meet obligations already overdue to the extent of at least \$70,000,000. Such refusal to finance the *de facto* Government would be awkward but by no means final, for the American government that recognized Carranza would be bound logically to step into the breach itself and make a loan. The fact is not sufficiently recognized that the United States has already established a financial suzerainty over Mexico. This condition has obtained since Huerta was driven out of office by the refusal of the United States to recognize him, and by the subsequent recognition of his enemy, Carranza. No foreign loan could be raised by Mexico without the friendly concurrence of the United States; and in any case no borrowing in Europe is possible at this time. Thus the logic of events has placed the American Government in a position where it controls the credit of Mexico and thereby exerts a decided measure of protection over the property of Americans in that country. Without funds Carranza, or any other President of Mexico, can do nothing. He can get that money only from the banking community in the United States or the government of the United States. But unless subscribers to a loan are promised the protection of their investment it is not possible to obtain the use of such money. Mr. Howe is answered.

The question is worthy of further consideration. We might refer to the pages of history and point to the East India, Hudson's Bay, and British South Africa companies as having advanced under their home government's protection to the successful exploitation of India, Canada, and Rhodesia; but their methods, it may be said, are now out of date. We agree, although it is quite clear that the northern Mexico deal, if true, would have been an illustration of a similar process of benevolent assimilation. A better way is to strengthen and uphold the government of a backward country into which American muscle and money have penetrated peacefully. As the *New Republic* says, "the central motive of a democratic foreign policy must be the modernization of the feeble and distracted nations." When such a country is next door, it becomes all the more obligatory, for our own comfort, to help in the establishment of orderly government, not harrassing it or refusing assistance to it, but supporting it, financially and otherwise, so that it may be established in prosperity. Our people have gone into Mexico to use their capital in working mines, stocking ranges, cultivating farms, building railroads, establishing businesses of every kind, altogether involving about \$1,500,000,000; by doing so they have followed the call of legitimate enterprise; their work

has helped to develop the resources of a backward country, educate its people, and promote political development. The political dose was too strong, perhaps, for the peon, but when he has overcome the intoxication of the American idea he will settle down to a quiet citizenship. The American and his property is a fact in Mexico. It is too late to repudiate his obvious claim for protection, always provided he conducts himself properly and does not use his citizenship to make trouble. A policy of detachment will not help either Mexico or Americans in Mexico. The establishment of order is for the good of both. On the other hand, the Americans in Mexico, if they expect the goodwill of either government, their own or that of the country in which they do business, must abstain from intrigues calculated to undermine one government and embarrass the other. No good can come of insidious efforts to force events toward an annexation of northern Mexico; it would entail the bitter enmity of the remainder of Mexico and a re-erudescence of suspicion on the part of the Spanish-American countries farther south; it would end all Pan-American fraternization and give the United States a fit of political dyspepsia highly injurious to healthy development.

Electrolytic Zinc

The wet metallurgy of zinc has come very much to the front by reason of the successful application of electrolysis to the precipitation of the metal from sulphate solution. We are glad, therefore, to give our readers an admirable article on the subject by no less an authority than Mr. W. R. Ingalls, the editor of the *Engineering and Mining Journal* and the author of the standard text-book on zinc. The article represents a paper read by him recently before a joint meeting of chemical societies in New York. In our issue of December 25 last we gave the salient facts concerning the big electrolytic zinc precipitation plant now in course of erection for the Anaconda Copper company at Great Falls. This is the result of the successful experimental work done by Messrs. Laist and Frick at Anaconda. These two metallurgists overcame the chemical difficulty of separating the iron so that a purified zinc solution might pass into the electrolytic cell. They discovered that this could be done by using manganese as a carrier of oxygen, whereby the ferrous iron is turned into ferric iron, which is then removed by precipitation. Later the oxygen liberated by the decomposition of the zinc sulphate serves to re-oxidize the manganese so that it is again available for service. In short, this part of the process is cyclical.

Mr. Ingalls takes a conservative view of the future of electrolytic zinc extraction. He does not expect the process to be revolutionary in its effect; on the contrary, he is of the opinion that only metallurgical works operating under exceptionally favorable conditions will be able to continue the use of the process when the War is over and the zinc industry returns to its normal state, which means a price for the metal that is much nearer to 5 cents per pound than to 15 or 20 cents. The electrolytic

method calls for cheap hydro-electric power and a relatively high-grade ore, say, 20% zinc. It must be remembered that the natural sulphide, blende, contains only 67% zinc. At Anaconda the separation of the silver is another favorable factor, for it is effected far better by the wet process than by distillation in retorts. Another point may prove important, and that is the comparative purity of the metal produced by electrolytic precipitation. High-grade spelter has been in strong demand for the making of special brasses required in the manufacture of munitions, and it may be that one of the results of the War will be to place such a premium on the purer brand of spelter as to give it a persistently preferred market. Another recent development, namely, the growing production of a high-grade concentrate (say, 50 to 55% zinc) by flotation, favors the electrolytic method of reduction, because the excessive fineness of the flotation product causes difficulties in smelting by the old distillation process. That is one reason why so many smelting companies have started to make zinc electrolytically. Besides the Anaconda company's big plant at Great Falls and the smaller one at Anaconda itself, we may mention the production of electrolytic zinc at the Trail smelter of the Consolidated Mining & Smelting Company of Canada; the Electro Zinc Company at Welland, Ontario; the plants at Keokuk, Iowa, at Bully Hill and Palo Alto, California; and now the announcement that \$1,000,000 is to be spent on a similar annex at the Garfield smelter, of the American Smelting & Refining Company, in Utah. While deferring to Mr. Ingalls' special knowledge of the subject, it seems fair to recall the fact that he has never taken a particularly cheerful view of the development of this phase of zinc metallurgy, and it is obvious that the big smelting companies, by spending millions of dollars in the building of reduction works using this process, are, in effect, betting a large sum that it will prove successful not only during the War period, but afterward in normal times. It seems to us that there are several factors favoring the electrolytic method, particularly where electrical energy is available on reasonable terms, say, \$30 per kilowatt-year, equivalent to about \$22 per horsepower-year. We believe that power at that price will be obtainable for the purpose, but in California all power contracts are subject to revision by the Railroad Commission, which is authorized to prevent an inequitable distribution among consumers. We hazard the prediction that electrolytic spelter will be produced at a total cost of 3 cents per pound, allowing \$3 per ton for mining, where crude ore runs from 15 to 20% zinc. This would be about 25% cheaper than production by the old method, which we debit with an average cost of 4 cents per pound of zinc. In any event, the new development—for it is hardly a new process—does challenge the old retort practice of Silesia and Belgium, and threatens these European zinc-smelting centres with serious competition. Perhaps, as a factor in zinc reduction, the waterfalls of Norway will prove superior to the coal-fields of Belgium, and the energy of the Missouri may prove preferable to the oil of Oklahoma.



DISCUSSION

Our readers are invited to use this department for the discussion of technical and other matters pertaining to mining and metallurgy. The Editor welcomes the expression of views contrary to his own, believing that careful criticism is more valuable than casual compliment.

Classification and Fine Grinding

The Editor:

Sir—In your issue of December 18, A. L. Blomfield has given some interesting figures (in reply to my letter of October 16) regarding the recent operation of the Dorr classifier in connection with ball-mills at Anaconda and Inspiration.

According to the screen analysis given, the classified oversize sand contains 28.8% of -48 mesh and 71.2% of +48 mesh product. The overflow product for treatment will practically all pass a 48-mesh screen. According

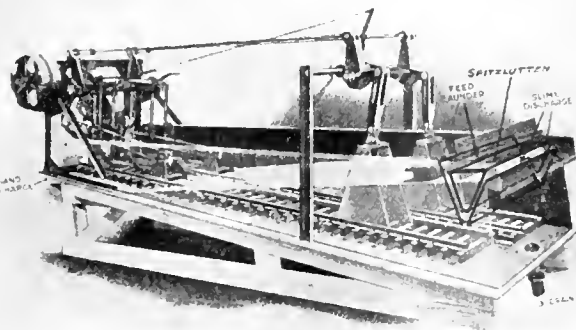

SPITZLUTTEN WITH DORR CLASSIFIER.

to this there is a large proportion of -48 product already fine enough passing to the ball-mills that should have overflowed the classifier with the finished product. I suppose at the Inspiration they are using the baffle as well as an increased speed for the rakes in order to obtain this result. The efficiency of the ball-mill should be increased by eliminating from the feed the greater part of that 28.8% of -48 mesh material.

I suggest as a means for largely reducing the amount of undersize (-48 mesh) product from the feed, the use of a spitzluttgen classifier in combination with the Dorr machine. This would convert it into a combined hydraulic and rake classifier. Very little water, if any, would be required for the spitzluttgen, as it would be submerged to its overflow within the Dorr machine. By raising or lowering the inner prism of the spitzluttgen, one can overflow any product desired for final treatment without speeding up the machine or using spray-pipes at the sand-discharge end. I believe that the Homestake has also used a similar arrangement thereby minimizing the return of undersize material with the feed to tube-mills.

The Dorr classifier is an excellent machine for sepa-

rating -150 or -200 mesh products from sand. The mill of the Frontino & Bolivia Gold Mining Co. in Colombia for which I recently designed and erected a cyanide plant, consists of classifier, agitators and thickeners all of the Dorr type (counter-current decantation) for slime of -150 mesh, and leaching-vats for sand of +150

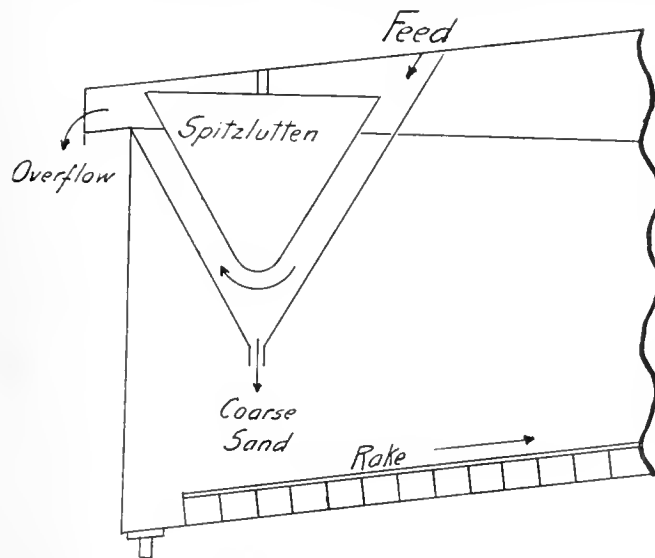

DETAIL OF ARRANGEMENT.

mesh. The sand-vats also act as clarifiers for the continuously decanted gold solution from the thickeners. The classifier delivers a clean product practically free from slime to the sand-treatment vats.

A. E. DRUCKER.

La Salada, Colombia, January 24.

Treatment of Antimony-Gold Ore

The Editor:

Sir—I recently came across the following notes on a mill-test that I made some years ago in southern Mexico.

The ore in question carried gold and silver. Associated minerals were antimony, lead, arsenopyrite, and copper. The practice had been to crush in a stamp-mill, with a large plate-area, then concentrate, and ship the product. The tailing, after passing over amalgamating plates, contained a considerable amount of free gold which was plainly visible in a pan, and also carried such a high percentage of antimony that the cyanide consumption was prohibitive. The mill-men insisted that the free gold in the tailing was not gold at all, only a form of mica, because it would not amalgamate with

mercury, but a fire assay disproved this idea. A chemical analysis led to the discovery that this gold was covered by a film of antimony sulphide (stibnite) and that this was soluble in a solution of caustic soda. After this treatment the gold readily amalgamated with mercury. I also found that by treating the original ore with a strong solution of caustic soda and washing well, it cyanided easily with a consumption of but 2.6 lb. cyanide per ton of ore.

The ore was crushed in a 5% solution of caustic soda, amalgamated on copper plates for the free gold, and then concentrated. The tailing from the concentrating tables passed through a long box with a traveling belt, which separated the sand from slime. The fine was afterward dewatered in a spitzkasten and the water returned to one of two battery storage-tanks, where the antimony was precipitated. The soda solution was then brought up to strength and used over again. The sand was cyanided by percolation and the slime by agitation and decantation. The copper, which went into solution, was taken care of by immersing the zinc shaving in a 10% solution of lead acetate. The lead only caused trouble by keeping the amalgam soft. This was afterward overcome by maintaining the plates dry.

WM. SEWARD MANN.

Cananea, February 20.

This is an interesting note. We recall that at West Gore, in Nova Scotia, in 1905, an antimonial-gold ore was treated by dissolving the stibnite in a dilute solution of caustic soda and then neutralizing so as to precipitate the antimony form of red amorphous, Sb_2S_3 . The intention was to cyanide the gold, but the difficulty arose of getting rid of the soda before cyaniding.—(Error.)

Electrolytic Zinc

The Editor:

Sir—A year or two ago there was prevalent the idea that the making of electrolytic zinc through some hydro-metallurgical process was not commercially practicable, and would never compete with pyro-metallurgical processes. Owing, however, to the high price of zinc, and especially to the high charge made for the treatment of zinc ores, the electrolytic recovery of zinc is being seriously undertaken—as, for instance, at the Washoe plant, Anaconda, where a 10-ton experimental plant is now in operation.

It is true that patents are obtainable for presumably novel details of treatment, but it is questionable whether these patented details would stand the test of legal action. These are so largely adaptations taken over from other chemical processes and from cyaniding that their novelty is in doubt.

The Nalmsen process, modified in detail, is at present preferred. This may be thus described: The finely ground ore after roasting is brought in contact with the liquor from the electrolytic tanks now containing free sulphuric acid and from which a part of the zinc has been removed, having been deposited on the cathodes. The

zinc (and other bases) is extracted by the action of the acid solution; the resultant solution is neutralized and treated in tanks with zinc dust for the precipitation of any electro-negative constituents that may be present, and after chlorination is sent in a regular stream to the electrolytic tanks.

The whole process consists then of two phases: First, the zinc-containing electrolyte is decomposed in the bath, yielding zinc and producing free sulphuric acid. Second, this acid liquor still containing zinc sulphate, goes to the dissolving tanks, where it takes up all the zinc possible. In order that the solution may be free from iron, it is brought in contact with ores containing increasing percentages of zinc, so that any iron oxide may be precipitated rapidly by the zinc oxide. Any other bases are precipitated later by means of zinc-dust, leaving a nearly pure solution of zinc sulphate for treatment in the electrolytic tanks.

As for details of precipitation, numerous experiments have been instituted, all of which have been tried in present practice. Otto Best has lately patented the idea of neutralizing any free acid immediately after solution by the use of a regulated addition of lime. The oxidation of the ferrous iron by potassium chlorate, by manganese, etc., has also been patented. All of these people endeavor to obtain a neutral and pure zinc sulphate solution to send to the electrolytic bath. They try to dissolve as little of the other bases as possible by promptly neutralizing the free acid. Metallic zinc, I may add in passing, is difficult of solution in strong sulphuric acid, though it makes quite a display of so doing.

One could wish that the idea of patenting could be abandoned and that the various companies, now so intent on the problem of producing pure electrolytic zinc, could compare experiments to their mutual advantage. Re-melted electrolytic zinc is of a pure white color like nickel, 99.92% fine, and fetches the highest price on the market.

Salt Lake City, March 2.

L. S. AUSTIN.

Use for an Old Hammer Drill

The Editor:

Sir—I note in your issue of April 3, 1915, the use to which Mr. C. A. Banks puts an old hammer-drill. We have also found the idea helpful, having had occasion some years ago to employ a drill in the manner described. Within the last year we have rigged up an old Leyner drill as a pneumatic stamp, the mortar-box being cut out of a suitable piece of timber and lined with $\frac{1}{2}$ -inch steel. A launder conveys the crushed ore to a small Wilfley table. Sizing tests on the discharged pulp closely parallel the regular discharge from our gravity stamps.

El Oro, Mexico, January 24.

PAUL W. AVERY.

WHEN selenium minerals are heated on charcoal before the blowpipe, they give off a peculiar fetid odor, like that of carbon di-sulphide.

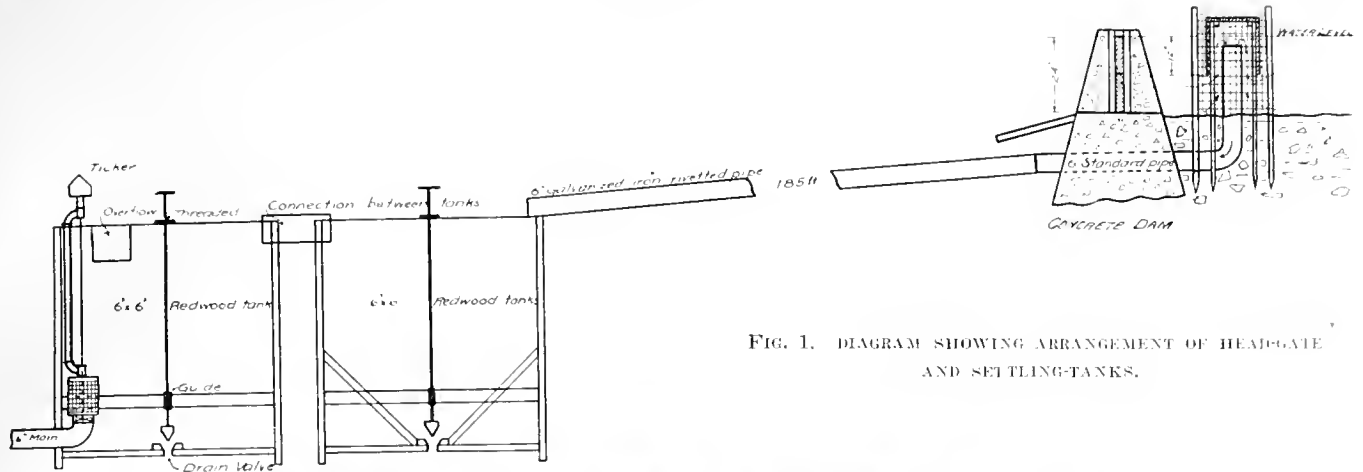

FIG. 1. DIAGRAM SHOWING ARRANGEMENT OF HEAD-GATE AND SETTLING-TANKS.

The Nevada Wonder Pipe-Line

Automatic Devices for Checking Interruptions to Service

By J. A. Burgess

A GEOLOGIST, in writing of the mineral resources of California, mentioned water as the most important mineral. It is not usual to think of water in this way, but the geologist's remark was strictly true, and would apply with equal force to the entire world. The truth that he stated is most appreciated in localities where water is scarce; and in the oases of the arid regions, where industry depends on a scanty water-supply, it is not uncommon to hear recognition of the fact openly expressed.

An ample supply of water is particularly necessary for mining and milling plants and in some localities it has to be brought for a great distance at big expense. Any interruption of the supply causes a corresponding cessation of milling operations, and therefore every possible precaution should be taken to insure against such a contingency. This paper describes the means used for this purpose at the Nevada Wonder mine, at Wonder, in Churchill county, Nevada.

The pipe-line was laid in the latter part of 1910. It conveys water by gravity-flow from Horse creek to the mine, a distance of 10 miles. It is in the form of a broad letter U. From the point of intake the course of the line leads downward through a valley until a point 2135 ft. below the intake is reached; thence it rises to the storage-tanks at the mine, where the elevation is only 465 ft. lower than the intake.

The line is built of standard, guaranteed full weight, steel pipe, with screwed joints. The same kind of couplings are used as on extra heavy pipe. The flanges and valves of the original equipment were of the type known as 'hydraulic,' but on all subsequent repair-work 'ammonia' flanges were used. The pipe was dipped in asphaltum before shipment by the manufacturer. The diameter at the intake is 6 in., reducing to 5 in. at 500 ft., and to 4 in. at 1000 ft. It has a covering of from 10 to 18 in. of soil. Air-valves and drain-valves are placed

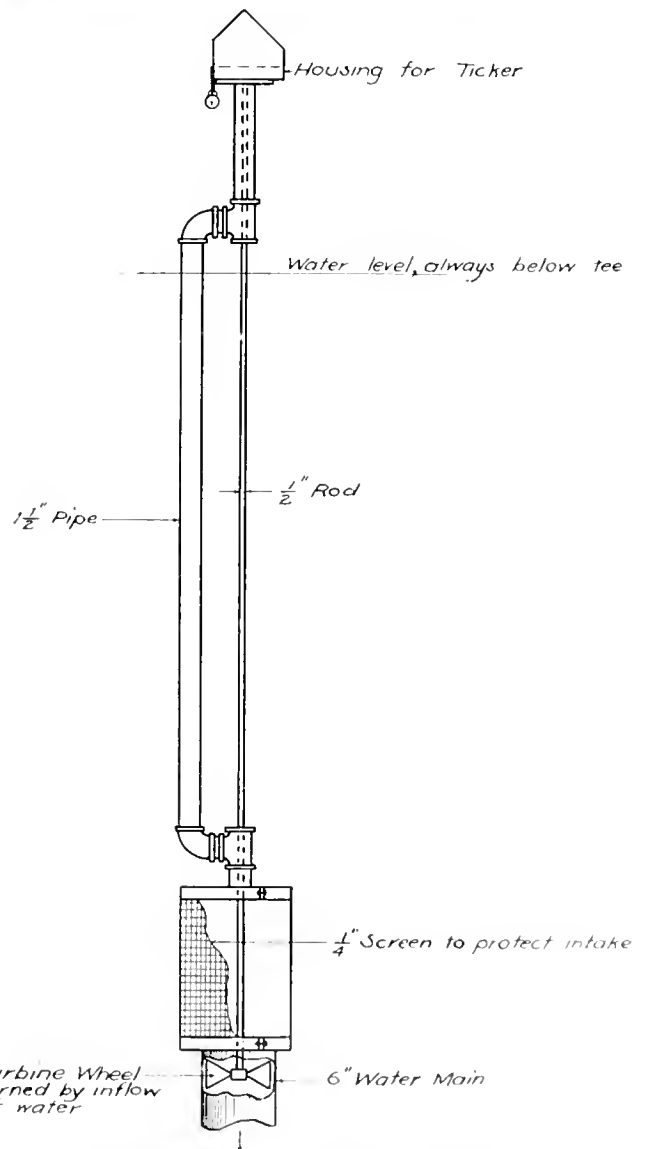

FIG. 3. TELEPHONE FLOW-INDICATOR FOR INTAKE OF WATER-MAIN.

at all peaks and sags where air or sand might collect. These are also of use when it becomes necessary to drain the pipe-line. They are one-inch hydraulic-compression valves, and there are 46 of them on the line. Shut-off valves are placed at four important points. The pressure at the lowest part of the line is 920 lb. per square inch, and an automatic valve, set to release at 1000 lb. pressure, is situated at this point to protect the pipe from sudden increases of pressure due to water-hammer from the too sudden closing of a valve.

The calculated capacity of the line is 185,000 gallons per 24 hours, and this checks fairly closely with the actual delivery. The rate of flow in the pipe is 2.57 ft. per second.

The chief sources of trouble are clogging of the intake-screens by leaves, breakage of the pipe at joints by longitudinal contraction in cold weather, pitting by corrosion, stoppage of the flow in the creek by freezing, and freezing of water in the pipe. Uncovering of the line is brought about by cloud-bursts, by cattle using the mound for a trail, and by badgers digging off the covering, evidently mistaking the sound of flowing water for the noise of insects or small burrowing animals.

The obvious remedy for clogging of the intake by leaves is to have the screens cleaned frequently. The interval between cleanings can be kept within reasonable limits by having the screen-area sufficiently large. Contraction breaks at joints, though never frequent, gave more trouble during the first three winters than since then. They took the form of cross breaks at the threaded ends. The adjustment of irregular strains and the elimination of weak spots by breakage and repair put an end to the trouble. There are no expansion-joints in the line; the numerous bends would make them superfluous. Pitting of the pipe has caused no trouble except in the valley, where the pipe was penetrated several times in the fourth year. These breaks occurred within half a mile of each other, and were doubtless due to an excess of alkali in the soil. The pitting was from the outside. A protective coating applied to the pipe at the time it was laid would have prevented this deterioration, but the coating applied by the manufacturer before shipment was partly rubbed off during transportation.

Excessively cold weather forms the principal source of danger. With the thermometer not lower than 10° or 15° F. at night the line is safe. With temperatures between 10° and 5° above zero, the line must be watched closely, and when the night temperatures are below 5° it is in danger. The lowest temperature recorded in five years was -11°. During the present winter freezing began in the pipe after three nights with the temperature at 4° below zero. At this low temperature the rate of flow in the line is not sufficient to prevent the formation of ice. A good covering of snow on the ground acts as a blanket and greatly reduces the danger of freezing. The ends of the line, being at the higher altitudes, are in the greatest danger of freezing; and when a decrease in the flow is observed during a cold snap, the means used to prevent a total closure of the line is to increase

the rate of flow at the intake end by opening valves in succession from the delivery end, until a point of high pressure has been reached. It has been found that ice formed in the pipe can be rapidly cut out by increasing the flow in this way. While this is being done the delivery end of the line is drained, and no water reaches the mine; but the cold spells usually last only a few days and it is better to endure a temporary shortage than to have the line frozen. There is storage capacity at the mine sufficient to run the mill for three days.

During normal winters Horse creek carries less than twice the quantity of water taken, and during an excessively cold night there is danger of the creek being completely stopped by freezing. The only way to save the line in a case of this kind would be to drain it entirely.

During the unusually cold winter of 1912-'13 this line, like many others in the West, experienced disaster, and the experience of that winter suggested steps to prevent a repetition of the trouble. Considerations of expense and the necessity for maintaining a continuous water-supply prevented the deepening of the trench, but additional covering was mounded over the pipe. A telephone line was built from the head-gate to the mine, several permanent telephone stations were established, and two portable sets were provided. A flow-indicator was devised and placed at the intake, arranged so that the rate of flow could be approximately read at any telephone-receiver. A device was attached to the mine end of the line to give instant warning of a stoppage of the flow. Arrangements were made to keep a watchman at the head-gate during dangerously cold weather, and a type-written program covering every possible contingency was furnished to him, as well as to a rancher three miles below the intake, and to several employees at the mine. This program specified exactly the duties of each man in case of a threatened freeze-up, and provided for the complete draining of the line, if necessary, within an hour after receiving warning. All telephone-poles and valve-boxes were marked with consecutive numbers.

The arrangement of the head-gate and the mechanical protective devices are as follows; Fig. 1 shows the arrangement of the head-gate and the settling-tanks. The dam backs up water to a depth of two feet. Removable boards, set horizontally in grooves, afford a means of sluicing out gravel accumulated during freshets. The entire bottom of the canyon is formed of loose rock-debris and soil, and the grade is so steep that a storage-dam would be impracticable; and in addition to this the danger of cloud-bursts forms an objection to the erection of expensive headworks. For these reasons no improvements beyond those strictly necessary were made. The intake at the dam is arranged to give a constant water-level, and to take the water from a depth of 12 inches below the surface. By these means a considerable depth of ice on the dam does not interfere with the flow into the pipe, as long as there is running water in the stream. As an additional protection, the dam is boarded over in winter. Ample area of screen, $\frac{1}{4}$ -inch mesh, is shown sur-

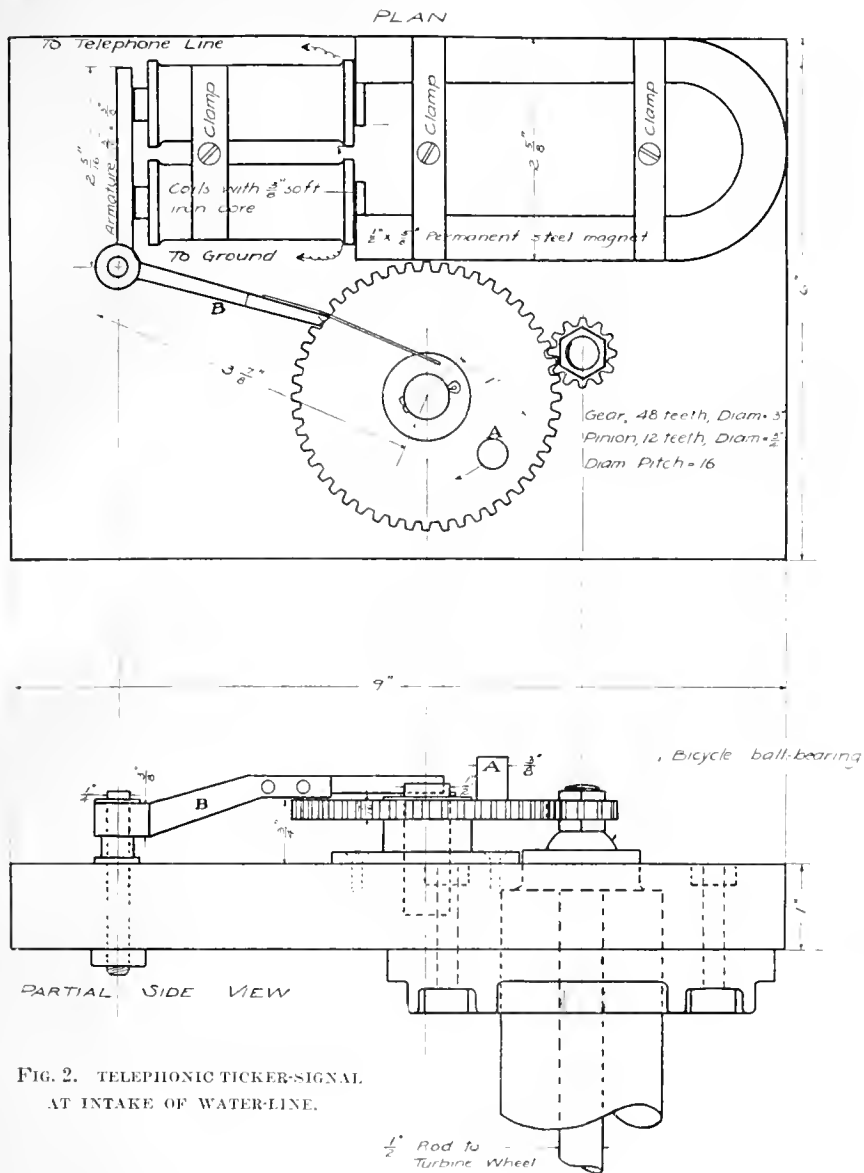

FIG. 2. TELEPHONIC TICKER-SIGNAL AT INTAKE OF WATER-LINE.

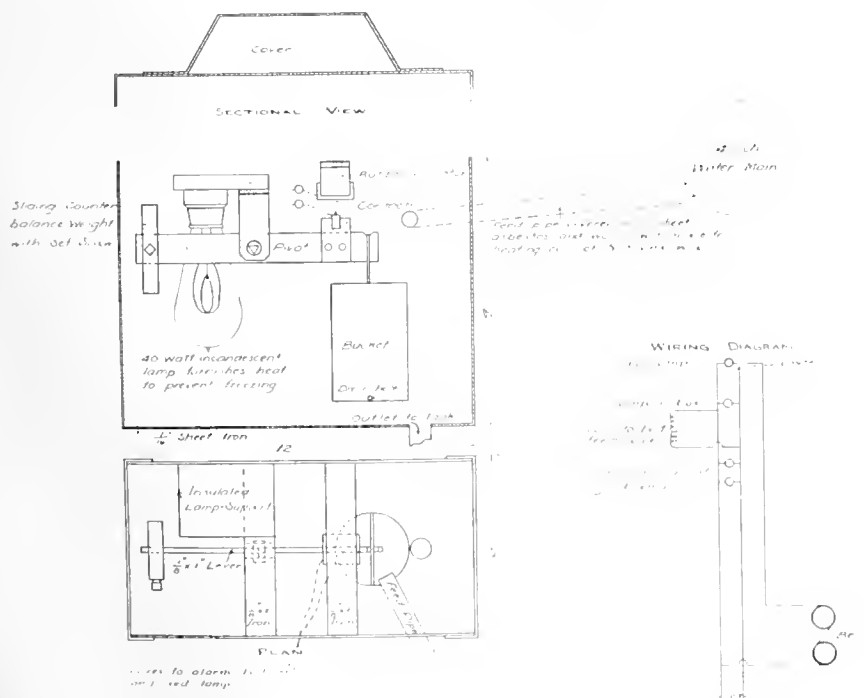

FIG. 4. SIGNAL ON WATER TANKS, NEVADA WONDER MINING CO.

rounding the intake. Two small tanks are provided for the purpose of trapping sand. The first has a conical bottom, and both are furnished with discharge plugs operated from above by threaded rods. Both tanks are covered. They are placed at the side of the canyon where only an unusually heavy cloud-burst would damage them. Delivery from the dam to the tanks was originally made through a square wooden flume, but when this became leaky, galvanized sheet-iron pipe was laid inside of it.

In Fig. 2 and 3, are shown the details of the telephonic flow-indicator, commonly called a 'ticker.' It consists essentially of a turbine-wheel just inside of the intake end of the water-main, by means of which the armature of a permanent magnet is periodically removed from its poles. The interruption of the magnetic flux induces an electrical impulse in a coil about the magnet. The coil is grounded at one end and attached to the telephone wire at the other, and each movement of the armature produces a clicking sound in the telephone receivers that is easily heard but is not sufficiently loud to interfere with conversation. The telephone line is connected with all the company telephones, so that the indicator may be heard in all offices and residences. The operation of the ticker is readily understood from the drawing. At each revolution the pin A displaces the arm B, which is integral with the armature. The bicycle ball-bearing forms a thrust-bearing that supports the entire weight of the rod and turbine-wheel, so that the lower bearing of the turbine-rod is simply a loose guide-bearing, and requires no lubrication. The only attention required by the ball-bearing for the past two years has been a few drops of oil occasionally. Its housing is kept locked. The support is made of pipe, but the drive-rod passes through only a part of its length. We ascertained that occasionally accumulations of air in the pipe-line bubbled back to the tank, and when a straight support was used, the gurgling air-bubbles entered the support and drove water upward through the bearing into the ticker. In cold weather this water froze and stopped the apparatus.

Fig. 4 shows the warning apparatus attached to the delivery end of the pipe-

line at the storage tanks. A small tin can with several punctures in the bottom is attached by a bail to a beam. The beam is supported by a pivoted axis like the beam of a pulp balance. The bucket when empty is over-balanced by a weight at the opposite end of the beam, so that the bucket end rises and an electrical contact is made. When the bucket is full of water it over-balances the weighted end and the contact is broken. A bleeder pipe, $\frac{1}{2}$ in. diam., taps the horizontal part of the water-main where it discharges into the tank, and leads to the bucket. When water is being delivered into the tank a small stream flows continuously into the bucket of the alarm apparatus, and the electrical contact is held open. If the water ceases to flow in the main pipe, none is delivered to the bucket and its contents leak out through the holes in its bottom. This permits the bucket end of the beam to rise, and the electrical contact thus established simultaneously lights a red incandescent lamp on the tank, and operates a loud-ringing polarized bell at a place in the mill where a mill-hand is always within hearing distance. To prevent freezing of the apparatus and of the small pipe leading to it, an incandescent lamp is kept lighted within the box, and a heating-coil is placed around the bleeder-pipe. Lights are maintained on the boards on which the water-level of the tanks is indicated, so that they may be read at night. The wiring diagram is shown in Fig. 4. A 110-volt alternating current is used. It will be observed that the bleeder-pipe does not tap the water-main exactly at the lower side. This is so that the alarm will be given when there is a serious decrease in the flow, and before it stops entirely. The apparatus is inspected and the bucket cleaned daily during cold weather. Small solid particles or scales from the pipe sometimes gather in the bucket and stop up the holes unless this is done.

The ticker is the pulse by which the performance of the water system may be watched. Under normal operating conditions it sounds 24 times per minute. If it works faster than this, it is a certain indication of either a break in the line or an open drain-valve. If the ticker sounds less than 24 times per minute, the reduction is due to decreased flow and may be caused by several circumstances. Except in freezing weather, it is apt to be caused either by air or sand in the pipe, or by leaves partly clogging the screens at the intake. In very cold weather it may be caused by a shortage of water in the creek or by freezing in the pipe. Only an inspection of the intake will distinguish between these possibilities, and it is partly for this reason that a watchman is kept at the head-gate during cold weather. At such times the temperature of the water in the stream is at 32° , and even a short stoppage of the flow in the pipe would result in a freeze-up. It is necessary, therefore, to obtain prompt information of conditions at the head-gate when there is any decrease of flow in the line. The alarm apparatus at the storage-tanks gives notice of any serious decrease of delivery, whatever the cause. By means of these two devices, and with a reasonable amount of attention, the danger of a freeze-up has been practically eliminated.

The ticker is also of great help when water is being forced through the line after draining it in cold weather. By using a portable telephone, the working crew can observe any stoppage that might be caused by the freezing of undrained pockets of water. In such a case the first valve back of the obstruction should be opened to maintain the flow until the obstruction is removed. Great care is taken under these circumstances to maintain a continuous flow.

The ticker is susceptible of use for a variety of purposes. By it the speed of operation of any piece of machinery can be indicated through a telephone line.

A few notes on methods of repair may be of interest. In thawing the line after the freeze-up of 1913, it was found that running a stream of water through the ditch, where this could be done, thawed the pipe just as effectively as a fire. When frozen only in isolated spots, the trouble can be easily detected between two valves. To determine the exact spot, the pipe is dug up at intervals, and tapped by boring holes $15/32$ in. diam. When the obstruction is removed the hole is threaded and closed with a $\frac{1}{2}$ -in. plug. The flanges used in the construction of the line were faced flat, and where these were subjected to high pressure, trouble was experienced through the blowing out of gaskets. In all repair-work, heavy ammonia flanges are used. In these fittings the faces are made in matched parts. On one face there is a projection $\frac{1}{2}$ in. wide and $\frac{1}{4}$ in. high, and on the opposite face there is a groove of corresponding dimensions, in which is placed a fiber gasket $\frac{1}{16}$ in. thick. Heavy fittings of this kind are peculiarly suited to repair-work, since their construction allows of using a heavy strain on the bolts to overcome a slight error in cutting inserted lengths. It is now planned to avoid the trouble caused by the freezing of small pockets of water after partly draining the line, by blowing out the residual water with air from the air-compressor at the mine.

Manganese in Panama

According to a Consular report from Colon an American syndicate recently opened a manganese mine at Madinga, on the gulf of San Blas, in the province of Colon, about 70 miles east of the city of Colon. A trial shipment of 900 tons of the ore has been made to New York. One of the owners, who acts as agent for the syndicate, states that shipments of 1500 tons a month can probably be made for several months if vessels are available for that purpose; but beyond that nothing definite can now be stated regarding the development of the mine. A wharf at deep water has, however, been built near the mine, and if the supply of ore holds out, and it can be profitably marketed it is the purpose of the owners to develop the Madinga mines to a considerable extent.

QUICKSILVER deposits in the Huancavelica district of Peru have changed hands, and mining is to be resumed by E. E. Fernandini of the American Vanadium Co.

Electrolytic Zinc

By W. R. Ingalls

INTRODUCTORY. Without any doubt, the most important thing in the metallurgy of zinc in 1915 was the inauguration of electrolytic zinc production direct from ore on a large experimental, even a commercial, scale at several places, the most important of these being at Anaconda, Mont., where the production of electrolytic spelter at the rate of about 5 tons per day was begun. The results are considered so favorable that the Anaconda company has commenced the erection at Great Falls, Mont., of a plant capable of producing 35,000 tons of electrolytic spelter per annum.

CHEMISTRY OF THE PROCESS. The chemistry of the process used at Anaconda is described in U. S. Pat. No. 1,167,700, granted to Frederick Laist and Frederick F. Frick, Jan. 11, 1916. According to this the proper performance of the cycle depends upon the presence of manganese. Its function is to serve as a carrier of oxygen for the oxidation of ferrous to ferric iron, thus rendering possible a complete separation of iron and affording a purified solution from which zinc may be recovered by electrolysis. In the course of this electrolysis the manganese is restored to a state of oxidation higher than the manganous state, and thereby becomes available for re-use in the process.

The calcined ore is treated at a temperature of 50 to 65° C. with sufficient dilute sulphuric acid so that there is 5 to 10% excess acid over that required to complete the reactions, by which the metals in the calcined ore are dissolved. A portion of the iron enters into solution as a ferrous salt, in which state it is not completely removed by the usual basic precipitants (lime, zinc oxide, etc.). It is necessary, therefore, to oxidize this ferrous iron, and in the cyclic operation of the process this is accomplished through the agency of the manganese, which enters the cycle at this point in one of its higher states of oxidation—as for instance, in the form of manganese dioxide. The oxidation of the ferrous sulphate takes place according to the equation,

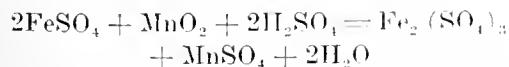

Having accomplished the leaching and having a slight excess of acid solution, sufficient milk of lime or zinc oxide is added to render the solution neutral or slightly basic. The iron and most of the other impurities except

copper are precipitated, and the precipitated impurities are so coagulated that filtration is very rapid.

The solution, purified from elements harmful to electrolysis, is subjected to electrolysis using insoluble anodes—as lead, for example—and suitable deposition blanks or zinc starting sheets for cathodes. The electrolytic reactions are:

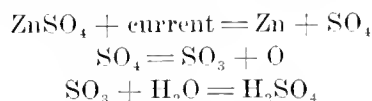

The oxygen liberated from the SO_4 at the anode effects the oxidation of the manganese; thus,

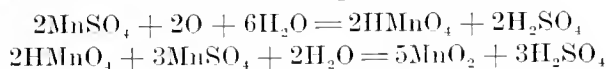

It is apparent from the foregoing that a regenerated sulphuric-acid solution containing manganese in higher stages of oxidation than the manganous state results and is directly available for leaching additional portions of roasted ore, where the higher oxides of manganese are available for oxidation of ferrous iron and are themselves reduced to manganous sulphate, thus making a cyclic process in which the desirable manganese may be used over and over again and in which the original supply or any deficiency may be supplied to the raw zinc ore or concentrates in the form of carbonate or sulphide ores of manganese.

DETAILS OF THE PROCESS. In the performance of the process the ore is roasted in Wedge furnaces at a temperature of 900° C., which, with a fuel consumption of 5 to 6%, delivers a product containing only about 0.3% S as sulphide. The roasted ore is leached in a Pachnea tank with air agitation, the lixiviant being spent solution from the electrolytic cells. The percentage of zinc dissolved is from 85 to 95. After addition of limestone to neutralize free acid, the pulp is run to a battery of Minerals Separation flotation agitators, where it is agitated and aerated to precipitate ferric hydrate. The charge thence passes to a Dorr thickener, which delivers clear overflow to solution storage tank and mud to Oliver filter. The latter gives cakes of gangue containing iron, lead, silver, etc., which go to blast furnaces, and solution which is united with that overflowing from the Dorr thickener.

From the solution tank the liquor is drawn into a tubemill filled with zinc balls, which precipitate copper and cadmium, flowing thence to a circular filtering tank having a quartz bottom, and finally to a Shriver plate and frame filter press, which completes the clarification. The purified solution goes to a cascade of 21 electrolytic cells, whereof there are two series, and upon entering, is mixed

*A paper presented at a joint meeting of the New York Sections of the American Electrochemical Society, the American Chemical Society and the Society of Chemical Industry, on February 11, 1916, but somewhat further elaborated for the *Engineering & Mining Journal*, of which the author is Editor, in its issue of March 4, 1916.

with one half of the spent electrolyte from the tail cells which brings the cell feed up to 24% free H_2SO_4 and 5% Zn.

In flowing through the cells the temperature of the electrolyte is kept below 70° C. by means of lead coils conducting cooling water, which is done in small boxes interposed between the cells. The anodes are of pure lead, the cathodes of aluminum. Solution is electrolyzed at a current density of 23 amp. per sq. ft., the voltage drop being 3.8 to 3.4 volts per cell, decreasing as the acid increases. Current efficiency is 93 to 94%. The cathode is finished within 48 hr., by which time it has attained a weight of 50 lb. and is then peeled from the aluminum sheet.

Apart from the Anaconda work, the most ambitious plans carried on in 1915 were those of the Consolidated Mining and Smelting Co. of Canada, which continued the experimental work begun several years ago. In the last official report of this company it is stated that spelter of good grade has been produced at the rate of 1000 lb. per day from ore from the Sullivan mine, and that the results were sufficiently promising to warrant the building of a plant capable of producing 25 to 35 tons of spelter daily. Construction of this plant is well advanced, and it is expected to be in operation early in 1916.

Electrolytic zinc was also produced in 1915 on an experimental scale by the Electro Zinc Co. at Welland, Ontario, while some work in this line was done at Keokuk, Iowa, and at Bully Hill, California, and there were one or two other operations (one of these employing the Isherwood process) that may not yet be mentioned publicly. The work at Welland is unique in that the dissolving of the zinc and the electrolysis of the solution are performed in the same vat, the cathodes being inclosed in canvas bags. All of the other work, so far as I know, is being done on lines similar to those at Anaconda.

Before going any further, let it be well fixed in the mind that the conditions that have existed in the zinc industry during the last year are not only unprecedented, but also it is certain that they cannot be otherwise than ephemeral. They have been due to a shortage of metallurgical capacity, not of ore in the least degree, and that shortage is being reduced with extraordinary rapidity. In the meanwhile, however, there has naturally been a huge metallurgical margin—even \$60 per ton of ore against a normal of about \$15—in the manufacture of common spelter, and with such a margin it has been good sense not only to commit metallurgical crimes, but also to institute new processes that would not ordinarily be profitable. In the manufacture of high-grade spelter the margin has been much higher, so much so that the possibility of it would two years ago have been considered nothing less than preposterous.

Now, the electrometallurgy of zinc is no new thing. The electrolytic refining of impure spelter was tried on a large scale by Nahnsen in Upper Silesia in the 90's, the hydrometallurgical-electrometallurgical treatment of

zinc ore was essayed disastrously by Ashcroft at Cackle Creek, N. S. W., in a works costing about one million dollars. Doctor Hoepfner developed a process that was put into use at Fährfort on the Rhine and at the works of Brunner, Mond & Co., at Wilmington, in England. At the former it was abandoned after a short time; at the latter it has been continued through a long series of years, making a few hundred tons of spelter annually, and is in use at the present time. The electrometallurgy of zinc has therefore a commercial history of respectable antiquity.

DIFFICULTIES IN THE ART. In the early days of the art, both commercial and experimental, difficulty was experienced in obtaining dense deposits on the cathodes, spongy zinc being a stumbling block, but while this matter required some study for its mastery, it was manifest that the real difficulties of this process were the getting of zinc into solution rather than out of it and the large amount of power required for zinc precipitation.

With regard to the former point, I refer to the formation of insoluble ferrite of zinc in roasting, with the consequence of relatively low extraction of zinc. That is experienced in the case of many, perhaps most, ores that it is desired to treat. To illustrate, roasted Joplin blende may be leached with sulphuric acid so as to cause it to give up 97 or 98% of its zinc, the residue being a white silica sand, but nobody wants to treat Joplin ore by a hydrometallurgical process, for the reason that it would be less economical than ordinary smelting. On the other hand, certain mixed ores high in iron, like those of Leadville, Colorado, may give up only about 65% of their zinc. So low an extraction would in itself be prohibitive in most circumstances in ordinary times. It is possible that the roasting might be conducted in such a way as to steer clear between the Scylla of zinc ferrite on the one hand and the Charybdis of undecomposed zinc sulphide on the other hand, but that question has not been investigated with definite results, so far as I know. With regard to the high power required for the electrolysis of zinc solutions with insoluble anodes, the expense of it, when imposed upon the cost of roasting, leaching, re-melting cathodes, re-working between products, etc., is likely to make the cost of hydrometallurgical-electrometallurgical zinc extraction too high to be ordinarily considered.

I have therefore repeatedly expressed the opinion that metallurgical processes of this sort were unlikely to be successful commercially, unless: (1) Exceptionally cheap hydro-electric power, such as the \$6 or \$7 per annual horsepower of Norway and Sweden, were available; or (2) unless use could be made of the anode reaction, such as the liberation of chlorine by the electrolysis of a chloride solution and the employment of it for some chemical manufacture, as at Wilmington, England; or (3) unless certain especially favorable conditions otherwise existed. By the last I mean such things as high-grade of the run-of-mine ore, a kind of ore that will give up a high percentage of zinc by lixiviation with sulphuric acid, an ore high in silver and possibly lead.

These points are almost determinative. In the pyrometallurgy of zinc the extraction of silver is, perhaps, about 65%. In the hydrometallurgy of zinc it ought to be upward of 90%, perhaps as high as 95%. The situation with respect to lead is somewhat similar. It is needless to dwell upon the importance of this in the cases of ore exceptionally high in silver.

FAVORABLE CONDITIONS AT BUTTE. Now, in the treatment of the Butte ore at Anaconda, about all of the favorable conditions that I have enumerated under the third head exist. The ore raised from the mine is of rather high grade, it is of a character that enables 90% of the zinc, or more, to be extracted by sulphuric-acid lixiviation, and as zinc ores go, it is exceptionally high in silver (the concentrated ore going 20 oz. silver per ton or thereabouts). Moreover, the Anaconda company is introducing zinc extraction in connection with its other great metallurgical work, thus dividing general and administrative expenses, etc. It is able to obtain moderately cheap power at Great Falls, and finally, what is not least in importance, it possesses about the best metallurgical organization of any concern in the United States and is instituting this new process at a time when there ought to be commercial profit in spite of any imaginable infantile disorders. I am not free to communicate such figures respecting the Anaconda results as I know, but I may say that the Anaconda management is thoroughly aware of the exceptional conditions existing in the zinc industry at present, and is nevertheless of the opinion that with its peculiarly favorable circumstances it can continue the production of electrolytic zinc in competition with everybody else in normal times, or even in the hard times that may be experienced after the termination of the War. The promise of the development of the hydrometallurgy-electrometallurgy of zinc as a commercial art on a large scale has therefore already become a prospect. There is to be such an art. The magnitude that it will attain and its effect upon the zinc industry of the world remain for the future to tell, but that it is going to have an early and important influence is not to be doubted.

Turning attention to some of the technical features of electrolytic zinc production, the conditions governing the electrolysis of zinc solutions were exhaustively treated by Dr. Victor Engelhardt in a paper read at the first general meeting of the Gesellschaft Deutscher Metallhütten- und Bergleute and published in *Metallurgie* a few years ago. A summary of Doctor Engelhardt's conclusions, together with some additional notes, was published by Prof. J. W. Richards in 'Transactions of the American Electrochemical Society,' XXV, pp. 281-90. The ideas of Doctor Engelhardt, who is chief engineer of the electrochemical division of the Siemens & Halske company, of Berlin, are exemplified in what are called the Siemens & Halske and Isherwood processes. However, in the late development of zinc electrolysis, 'processes' and patents have played but slight part. With recent experimenters the matter of spougy-

zinc deposits appears to have been among the least of the difficulties. Mr. Keating succeeded several years ago in depositing smooth, solid zinc on his cathodes at Bully Hill, California, while as for Mr. Laist, he accomplished this part of the process as a matter of course, just as simply as if he were depositing copper, the necessary precautions as to purity of solution, etc., being naturally taken.

GRADE OF ELECTROLYTIC ZINC. With regard to the grade of electrolytic zinc, high purity is easily obtained. This is something that is far more under control than in refining by fractional distillation. Lead ought not to go appreciably into solution at all, while iron, copper, and cadmium—the other common impurities of spelter—are readily precipitated from the solution. The spelter first made at Anaconda was higher in cadmium than is permitted by the standard specifications for 'high-grade.' At that time zinc-dust, more or less impure, was being used as the precipitant for cadmium. Running the clarified solution through a tube-mill filled with zinc balls corrected this, and the grade of spelter was then raised to upward of 99.9%. Brunner, Mond & Co. have been for many years guaranteeing their electrolytic spelter at 99.95% Zn, and there is no reason why the Anaconda spelter should not be made as good as that.

Is electrolytic zinc extraction going to revolutionize the metallurgy of zinc? Unqualifiedly, no. When the zinc industry returns to its normal status, conditions will be in the main as they were before the War and the principles that I have previously stated will continue to obtain, with the difference that some people will have learned the details of the art, will have gone through the period of infantile mistakes in a time when almost any mistake was of no great consequence. By that time some of the concerns possessing exceptionally favorable conditions—Anaconda, if anybody—may be able to continue. Others will not.

However, there are certain new industrial features that cannot yet be clearly estimated and may have a modifying effect upon this forecast. One of these relates to the matter of high-grade zinc. Previous to the War that class of spelter was produced in limited quantity and sold at a premium over common spelter of about 2½c. per pound. Inventors, promoters and others who talked about making such zinc were discouraged from reckoning upon the premium by the dictum that the market would not take any more than the then supply, which was indeed artificially limited, and that it was unsafe to count on anything but the price for common spelter. During the War high-grade spelter has fetched 40c. per pound, and at times the demand for it has been insatiable. This demand has been especially in connection with the manufacture of ammunition and may be expected to cease with the War, but will the advertising that high-grade spelter has had and the wider knowledge of its peculiar properties that has been acquired give it a more extensive use in the peaceful arts and a maintenance of the premium for it, that will be

to the advantage of the electrolytic producer? Or will it become a drug in the market, with entire disappearance of price differential? These are questions that nobody yet knows enough to answer reasonably.

THE BEARING OF FLOTATION. Another new and uncertain factor is the bearing of the flotation process of ore concentration upon the metallurgy of zinc. I think that this had a good deal to do with the institution of the Anaconda work. About all metallurgical work is a sequence of steps of concentration and refining, treating the bulk of the ore by a cheap but wasteful process and delivering a concentrated product to a more costly but less wasteful process. Now, most experimenters in the hydrometallurgy and electrometallurgy of zinc heretofore have contemplated the application of a costly process to the run-of-mine ore. The flotation process has enabled ore to be concentrated at relatively small cost with but slight loss. Let it be observed, therefore, that Mr. Laist is applying his costly process not to run-of-mine ore, but to a flotation concentrate in which about 90% of the zinc is concentrated in about one-fourth of the original weight. This is the new and important feature of recent zinc electrolytic work.

We must let our thoughts run a little farther ahead. The treatment of flotation concentrate is one of the present troubles of the zinc smelter, owing to its excessive fineness, which produces difficulties that it would take me too long to describe. Yet the proportion of this class of ore that the zinc smelter is getting is still relatively small. The supply of it is, however, bound to increase, and when it becomes large, the troubles of the zinc smelter will really begin. Now the hydrometallurgist will have the same troubles up to and through the roasting of the ore, but he will be free from those that arise in the distillery. In so far he will have an advantage over his brother pyrometallurgist, but whether it will be a weighty advantage, I do not venture to offer an opinion.

Another thing that may help the hydrometallurgist is improvement in the method of roasting. Twenty-five years ago he used to talk about sulphate roasting. He did not in practice find that idea to work out as well as he expected. While he might be able to render 40 or 50% of the zinc soluble in water, he found there was too much undecomposed sulphide left behind after leaching with sulphuric acid. So then he said he would roast the ore completely, leach all the zinc with sulphuric acid and be done with it. To his surprise he found that much of the zinc had been rendered insoluble by the formation of zinc ferrite if iron were present in the ore, as was almost always the case. The roasting of ferruginous blends in such a way as to convert all of the zinc into sulphate and oxide, avoiding both sulphide and ferrite, which may perhaps be done by correct control of temperature, perhaps by some other control, is an interesting subject for investigation. Mr. Laist has given some attention to this by carefully limiting the temperature of his roasting furnace. However, I think that perhaps the danger of ferrite formation is not very great in the

case of his ore. Anyway, I know that it is not in roasting some similar ore of Butte without much regard to the matter of temperature.

Refining and Melting Gold Precipitate

The composition of raw gold precipitate from the Liberty Bell cyanide plant at Telluride, Colorado, varies considerably within short periods, according to A. J. Wernig, in a paper prepared for the September meeting of the A. I. M. E. in Arizona. The variations are as follows:

| | % |
|-----------------------|-----------|
| Gold and silver | 25 to 75 |
| Zinc | 18 to 30 |
| Lead | 0.5 to 52 |
| Copper | 0.5 to 20 |
| Silica | 1 to 5 |
| Calcium oxide | 4 to 8 |
| Sulphur | 0.5 to 8 |

All methods of wet refining, that is, with acid, were discarded after unsatisfactory results. A great deal of experimenting led to the present system of flux refining, which generally embodies the principle of the addition of an oxidizer, and the proper proportion of fluxes to carry off the oxidized impurities as metallic bases in a fluid slag.

A rather wide experience in the melting of precipitate proved that the various impurities are oxidized and driven into the slag in a definite order. Zinc tends to oxidize first, followed by sulphur, lead, and copper. As long as lead is present in the bullion it is almost impossible to drive the copper into the slag. Graphite crucibles are responsible for this.

After removing the precipitate from the press, the computed flux of manganese dioxide, potassium, or sodium nitrate, sodium carbonate or soda-ash, silica, and borax (to suit the particular class of precipitate) is added, and the whole mixed while wet. In a muffle the mixture agglomerates to $\frac{1}{3}$ its original bulk, minimizing dusting. The product is excellent for crucible melting, resulting in fast reduction, as much as 1300 oz. bullion per hour. The advantages gained by sintering are many. The completion of practically all chemical reactions in the muffle-furnace prevents any excessive boiling in the crucible, and the crucible may be loaded to the top during the period of melting. The slow application of heat in the muffle-furnace gives ample chance for complete chemical reaction. The flux calculations have been used in 60 melts during 18 months with complete success, there being close approximations to the grade of bullion determined. Slags are melted once a year in a blast-furnace and the only by-products shipped are lead bullion and pig-copper.

DURING February the San Francisco Mint received 161,269 oz. gold and 76,962 oz. silver. Coinage executed, \$20 pieces, was worth \$5,860,000.

Uses of Furnace Slag

By Herbert Lang*

THE advance made in the utilization of waste slag from smelting works is small, and, with the exception of the important one dealing with the manufacture of hydraulic cement from certain iron blast-furnaces, no permanent industry has been built upon this metallurgical residue. Although in other directions it is increasingly evident that the trend of thought is toward the conservation of by-products, the proposals for the utilization of slag do not express much that is novel or particularly cogent. This, I presume, is largely because the subject is old and well-worn. Judging by certain suggestions that have been recently made it appears that many persons are unaware of what has been previously accomplished in these directions, and it may prove advantageous to recount briefly what has been done, and what is likely to be done in the future.

The most obvious use of waste-slag, and probably its earliest use, is as road-metal, for which its hardness, brittleness, and density make it especially adapted. When it takes the place of ordinary crushed rock, at no greater cost, the substitution is advantageous. Slag is dustless, it packs well and drains well, making an ideal macadam, but it must be covered with a top-dressing of some more friable substance, the more so as it breaks with sharp edges, trying to horses' feet. A binder is usually intermixed with the fragments; this may be of clay, pitch, or tar. In England a special grout has come into use, prepared by mixing the crushed and heated slag with pitch, before laying. This is a novel proceeding, and is said to be successfully used. Also novel is the proposal to employ broken slag for ballast in lieu of crushed rock, the idea being to discourage pedestrians from trespassing on the track. The sharp edges are supposed to be unpleasant to the feet of the wandering hobo. Copper and lead furnace-slags are better for these purposes than those from iron furnaces, since they are of greater specific gravity, their weight ranging from 3.4 to 3.8, in general, while the corresponding figure for iron slags compares with that of granite, sandstone, and other building stones, which seldom surpass 2.8 or 3.

The manufacture of slag-bricks, building-blocks, and paving-stones from specially tough slags has been practised, and good examples of the construction and use of such may be seen in or about such smelting centres as Butte and Cleveland. An English friend calls my attention to the old dwellings and other slag structures still standing in Cornwall, after more than a hundred years. The manufacture of such blocks is simple, consisting merely in pouring the molten slag into a recep-

table of the proper size and form, and allowing it to cool slowly, the slower the better, until it is quite cold. This slow cooling partakes of the nature of annealing, by which the object is rendered much tougher and less liable to breakage from shock. Slag requires this treatment, since without it slag is very sensitive to sudden shocks, although it stands remarkably well the application of slowly applied pressure. The cooling is delayed usually by covering the material with a layer of sand, under which it is allowed to remain for hours or days. Slowly annealed slags of favorable composition acquire almost the hardness and toughness of glass, being equal in compressive strength to the best granite, while surpassing in that regard all other ordinary building-stones. The tougher slags approach glass in their composition, for glass is a true slag, differing of course as respects its chemistry, and some glass-makers have employed a proportion of slag in their 'mix,' adding enough of silicious sand, soda, lime, etc., to bring the mixture to approximately their ordinary formula, and manufacturing therewith the coarser objects of their art, such as bottles, sidewalk lights, etc. It should not be forgotten that silica lends toughness both to glass and to slag, it being the rule that given the same bases the slag (or glass) is the tougher the more silica it contains. Whether the glass-maker of the future will derive some of his materials from slag-heaps is a suggestive question. Slag, of course, is usually quite impure and often not suited for colorless glass; but, on the other hand, the glass-maker's customary materials, such as sand, lime, soda, and lead oxide, are also impure, and it is often difficult for him to obtain them of the proper quality.

Slag in small amounts has been used, also, in the production of the so-called slag wool or mineral wool, so much used for the coating of steam-pipes, for deadeners within walls, and generally where a non-conducting material is in demand. Slag-wool is a curious substance. It is made by blowing a jet of air transversely across and through a falling stream of molten slag as it flows from the spout. Small spheres or spherules of the slag are detached and carried away in the air-current, leaving behind them a fine hair-like thread of the material, which may reach a length of several feet. These threads are frequently formed when tapping, being caused by the escape of the blast. Usually they have a little globule of hardened slag at the far end, and are very attenuated—so fine, in fact, as to be almost invisible. The wool may be collected upon a sieve, which allows the air to pass onward, while intercepting the threads. This interesting and valuable product is more generally made in special fur-

*Metallurgist, Oakland, California.

naces running on a special mixture supposed to be better calculated for the purpose than ordinary furnace products. It is said that the sulphur that accompanies ordinary slags is prejudicial to the manufacture of slag wool, so that it becomes advisable to obtain melting stock devoid of that element. A little slag will make an astounding pile of wool, so that it does not appear likely that its manufacture will ever make serious inroad on the great cinder-heaps that border upon our smelters. A method has been worked out for improving ordinary slag for this manufacture, consisting in re-melting it with a small addition of nitre, by which the sulphur is expelled, rendering it more suitable for this and other purposes. I am not informed as to the practical success of this proceeding.

Referring to the manufacture of hydraulic cement from the high-lime slags of the pig-iron process, the question is often asked: Why cannot copper and lead slags be used for this purpose? The answer is not difficult. In the first place such slags contain no portion of the peculiar basic lime-silicate that has, above all other known substances, the quality of what is called 'hydraulicity,' that is, the tendency to absorb water, to become hydrated, and then harden or 'set.' The relative proportions of the ingredients are unfavorable, the various silicates being of too acid a character. Again, their principal silicate is that of iron, which itself is devoid of cementing properties. In the effort to render such slags of use in cement-making it would be necessary to re-constitute the slag, depriving it of iron and increasing its proportion of lime. This could only be done by re-smelting the slag in an iron-furnace, with considerable additions of limestone, whereby pig-iron would be gotten, thus freeing the material from that metal, while a slag of sufficient basicity would fall, which, if the proportions of other constituents, especially magnesia and alumina were admissible, would constitute a sufficiently good basis for cement manufacture. But considering the relative cheapness of the limestone and clay or slate, which are the usual materials for cement-making, it could hardly be hoped that the residues of such slags would ever be sought for that manufacture. It is only a small part of ordinary iron-furnace slag which is now deemed suitable for it, and we can scarcely expect that any considerable portion of the great slag-heaps that dot the landscape will ever be removed from their present situation for any manufacturing purpose whatever, the more so as many of them lie in comparatively inaccessible positions. However, it is dangerous to prophesy even about slag; and future inventors may have something to say about it.

The ferruginous slags of the copper and lead furnaces are adapted to the manufacture of the so-called metallic paints. They owe their value in this connection to the abundance of iron which they contain. This iron is in the form of silicate of the protoxide, and requires to be converted into the form of free ferric oxide, which, when pulverized finely, gives a bright red powder, suitable for the base of such paints. The process of converting

the slag (which is or was carried on at a certain works in New Jersey) consists in grinding the slug, subjecting it to the action of sulphuric acid, by which the silica is set free and the iron converted into ferrous sulphate (copperas, or green vitriol), and then calcining the mass, by which the sulphuric acid is expelled and the iron made to take up an additional quantity of oxygen, forming the sesquioxide, which is the red coloring-matter of the paint. By governing the calcination and the proportion of acid, various shades of color may be produced, having a considerable range. The dry color sells for \$20 or \$25 per ton in this market, which consumes perhaps 1000 tons yearly. The presence of the silica and such ordinary bases as lime, magnesia, and alumina has no unfavorable effect on the paint, and even adds to its durability, provided they remain insoluble. This manufacture has not been introduced on this side of the continent, but I have made small samples in the laboratory, preparing over 20 different shades of reds and browns, and I believe that the manufacture is perfectly feasible under the conditions here, especially as the various ochres, vermilion, etc., sell at prices much beyond those offered for similar products in the East.

By acting on pulverized copper-slag with dilute sulphuric acid and leaching out the soluble ferrous sulphate from the insoluble residue of silica, etc., good copperas may be made cheaply, at a cost that should allow it to compete with other manufactured brands, which are usually by-products of other processes, or are made, as in this vicinity, by dissolving scrap-iron in sulphuric acid.

Generally speaking, furnace-slugs may be divided into two kinds, according to their content of iron. Those made in the pig-iron industry, in which, as a matter of course, the effort is to keep the iron out of the slag (cinder, in that parlance); while in copper and lead smelting, wherein iron is an impurity to be got rid of, its only usefulness consisting in rendering the slags more fusible, the object is to drive it into the slag. Hence this division. Slag made in copper-furnaces, if run through the high iron stack and suitably fluxed with lime, etc., will yield its contained iron in the form of pig, just as crude iron ore will, and the product might be as good as any pig except for possible (and probable) impurities which such slag too frequently contains. This proceeding is carried on to some extent in the case of 'mill-cinder' and 'puddling-slag,' both of which result from the working of pig, and which are very rich in iron, chiefly as the sub-silicate. They form a component of the iron-furnace in some localities, but I have never heard of an instance where they were the sole metallic component, the practice being to feed them along with crude iron ore. The average copper and lead slags contain perhaps 25% iron, reckoned as metallic, and hence could not, in the present state of the industry, be considered as a practicable ore, regardless of what else they might contain. However, with the certain exhaustion of our iron mines, which should take place

within at most a few centuries, the accessible deposits of discarded slag will probably be utilized to some extent. The copper that many slags contain may not, in the light of the new discovery that the presence of this metal to a small extent enables steel to resist corrosion, be found a detriment, while the sulphur that almost all contain in small amounts, may be got rid of perhaps, or otherwise rendered innocuous. Discarded copper slags would average, I think, about 0.5% copper, and both lead and copper slags carry usually one or two per cent of sulphur. Some contain also a proportion of phosphoric acid; but this, in view of the trend of metallurgical invention and practice, may not be viewed as invariably detrimental, although we are well aware of its effects on iron and steel. It is well known that in Germany, where they do many things differently from American practice, a large industry, that of preparing fertilizers from steel-makers' residues, has arisen. By treating phosphoric pig in basic converters a secondary slag is obtained, so rich in phosphoric acid that it is ground and sold to farmers for such a price as to net, it is said, in some instances, a greater profit than the steel which is produced with it. Instead of avoiding phosphoric iron ores the Germans often seek them as most desirable, and our own iron and steel-makers are looking forward to the time when this peculiar manufacture will be established on our continent. Meanwhile the output of phosphate-slag fertilizer (Thomas slag) has reached the annual total, I am informed, of nearly two million tons.

Slag is a great snapper-up of unconsidered trifles. Almost anything that exists in the ores and fuels used in smelting finds its way, if not volatilized and driven off in the smoke, into the slag. Iron goes into it in three, if not in four different forms. First, there is the silicate of the protoxide, which disposes of by far the greatest amount; then there is almost always a little in the form of sulphide, which has a great propensity to dissolve in all slags, especially in basic ones; magnetite has been isolated from many slags; and occasional analysis of exceptional slags shows ferric oxide, united, no doubt, with silica. We may conjecture, too, that one or the other oxide may unite with alumina and perhaps other substances for which it has an affinity, and all these dissolve freely in the general menstruum, provided there is not too much. Copper enters the slag in two forms, mainly as the oxide in combination with silica, but to a much less extent as dissolved sulphide (matte). Occasionally, too, there will be detached particles of metal or matte floating about. Slags which fall from wholly oxidized ores of copper are invariably richer in that metal than those which are produced from ores carrying sulphur (matte-smelting). This is the reason why the old slag-heaps, made from surface ores, are eagerly taken up by the later smelters, who have found sulphide ores, and who invariably fuse them to matte. In this way the old slags are reduced from 3 or 4 or 5% copper to 0.5%, more or less.

Arsenic, antimony, lead, zinc, tin, cobalt, nickel, silver,

gold, manganese, molybdenum, titanium, tungsten, uranium, vanadium, and a long list of other elements have been found in greater or less quantity in slags from various processes, but the recital of their occurrences would fill too large a space for discussion now.

It is significant that a chemist (a German, of course) has discovered that radium itself, when contained in ore that is smelted, persists, and is found in the slag. I submit that in view of this fact it would be an interesting research to test the slags of smelters dealing with complex ores here and there, to the end that if their radio-activity were established, further search among the contributory mines might bring to light some radium-bearing minerals. I have in mind one or two slag-dumps, about which I am keeping dark until I can get there with an electroscope and a suitable form of option. But like all other prospective possessors of radium mines, I feel some disquiet at the progress that Uncle Sam, through his Bureau of Mines, is said to be making in reducing the price of radium. Should that price fall to, say, 40,000 times that of gold, I fear the worst. I think, on the whole that our Uncle should retire from such pernicious activities.

BELT-CONVEYORS are used at the Sacramento shaft of the Copper Queen mine to transport the ore to railroad-cars. At the shaft the ore is dumped into a 12-ton bin, the bottom of which is a pan-conveyor that transports the ore to a belt-loader. A V-shaped opening at the bottom of the pan-conveyor allows the fine material to form a bed on the belt for the coarse material; the sides of the V are movable and can be spread to widen the opening when sticky ore is hoisted. Other belts parallel with the railroad tracks load the cars by the help of a mechanical moving tripper. The tripper travels back and forth 36 to 40 times in filling seven cars of a string, serving the purpose also of taking samples which are automatically deposited in an eighth car. The average sample results for a month's run checked the smelter returns to 0.1%. The whole operation is electrically driven, and is controlled from a platform between the loading-belts. The speed of the belts is increased when hoisting is from the upper levels and the belts are stopped when the skips are delayed. A man stationed where he can see all the belts, regulates this. In addition there are two Mexicans to oil and help load, and a mechanic on day-shift to repair parts. The ore is rough, uncrushed, and hard on belts, yet the system gives satisfaction. The total cost of conveying and screening was 2.74c. per ton of ore in 1914. The above notes are from a paper by G. F. G. Sherman at the San Francisco meeting of the A. I. M. E.

GOLD produced by its dredges, etc., in Alaska, California, and the Yukon during last year yielded the Yukon Gold Co. \$4,209,809 gross, and \$2,099,373 operating profit. There was \$1,036,081, or 31c. per share, available for dividends, of which 30c. was paid. Preparatory work for the coming season is now under way.

Water Concentration Before Flotation at Anaconda

By Frederick Leist and Albert E. Wiggin

THE concentrator, as remodeled for flotation, consists of eight sections, each of 2000 tons per day capacity, giving a grand total of 15,000 tons per day, allowing for shut-downs, repairs, etc. All sections are alike with the exception of Section 1. In this section, Hancock jigs¹ are used in place of Evans jigs and tube-mills are used in place of Hardinge mills. Fig. 1 shows the flow-sheet of Sections 2 through 8.²

The ore is fed from the bins to a 2-in. round-hole shaking screen, the oversize going to a 12 by 24-in. Blake crusher. The product from this crusher is delivered to a 2-in. round-hole trommel, the oversize of which is sent to two 8 by 20-in. Blake crushers. The product from these crushers, together with the undersize from the 2-in. screens, is elevated and passed through 1-in. round-hole trommels. The oversize from this is treated in coarse Harz jigs, making a middling and a concentrate; the undersize is passed through 2-in. trommels, the oversize being treated in fine Harz jigs making a concentrate and a middling. All sections are alike up to this point. In Section 1, the undersize from the 2-in. trommel is screened on 1½ by 12-mm. trommels, the undersize going to the Anaconda classifiers and the oversize to the Hancock jigs. The treatment of the products from this point is the same in all sections, except that Section 1 uses tube-mills in place of Hardinge mills for grinding, as noted previously. The undersize from the 2-in. trommel is screened through 4-mm. trommels, the oversize from these going to the double compound Evans jigs and the undersize going to 1½ by 12-mm. trommels. The undersize from these trommels goes to the Anaconda classifiers, the oversize to double compound Evans jigs. The two sets of Evans jigs make a concentrate which goes to the dewatering bins and a middling which is ground for further treatment.

The concentrate from the coarse Harz jigs is dewatered and conveyed to bins. The middling is screened on a dewatering screen, the undersize together with the hutch product from the coarse Harz jigs going to the Evans jigs. The oversize is passed through rolls, 54 by 24 in., and thence back into the system ahead of the 1-in. round-hole trommels. The concentrate from the fine Harz jigs is sent to the bins. The middling is screened through a dewatering screen, the oversize going to 54

by 24 in. rolls and then back into the system ahead of the 1-in. round-hole trommels. The undersize of the dewatering screen together with the hutch discharge of the fine Harz jigs goes to the Evans jigs.

The concentrate from the Evans jigs is dewatered in bins to about 7% moisture, and sent to the smelter. The jig concentrate assays about 15% insoluble and 8% copper. The middling, together with the hutch product is dewatered in tanks and screened through 1½ by 12-mm. trommels, the undersize from which goes to the Anaconda classifiers,³ the oversize through 54 by 24-in. rolls, and back to the 1½ by 12-mm. trommels.

The spigot from the Anaconda classifier is treated on 18 Wilfley tables, fitted with Butchart riffling, making a concentrate and a middling. These tables make a concentrate assaying 25% insoluble and a middling assaying 0.9% copper. The concentrate is sent to the dewatering bins, together with the fine jig concentrate, and the middling is sent to the 10 by 4-ft. Hardinge mills. The overflow from the Anaconda classifiers is sent to the slime thickener division, consisting of 28 by 3-ft. Dorr tanks.³ The spigot product from these tanks is divided; about one-half is returned to the section and the remainder is sent to the slime plant.

The product from the Hardinge mills (Fig. 2) is treated in six simplex Dorr classifiers—one classifier to each mill—the overflow going to the flotation division and the classifier sand being returned to the mill.

At the time it was first decided to remodel the concentrator, it was not definitely known whether pebbles or steel balls would be used for grinding. To provide for this uncertainty a compromise was effected. The mills were made 10 by 4 ft. and built sufficiently strong for steel balls in case balls were used. Each mill was equipped with a 225-hp. motor directly connected through a flexible coupling. The mill filled with pebbles takes from 95 to 115 hp. to operate. In case steel balls were used it was planned to put in a false wood lining back of the steel lining in the cylindrical part of the mill to reduce the effective diameter of the mill.

This latter plan was finally adopted, and the Hardinge mills will be equipped with the false wood lining, 15 in. thick, in the cylindrical part of the mill, and a Cascade steel lining. With this form of lining, the mill is virtually 7½ by 6 ft. and requires about 225 hp. when loaded with steel balls.

*Abstract from paper to be presented at Arizona meeting (Sept. 1916) of the American Institute of Mining Engineers.

²For comparative data on Hancock and Evans jigs, see *Trans. A. I. M. E.*, xlvii, p. 212 (1913).

³This flow-sheet appears on page 205 of our issue of Feb. 26, 1916.—EDITOR.

²For description of Anaconda classifier, see *Trans. A. I. M. E.*, xlvii, p. 277 (1913).

³For description of this thickener plant, see *Trans. A. I. M. E.*, xlix, p. 470 (1914).

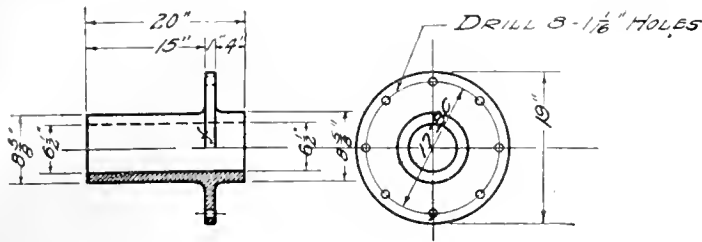
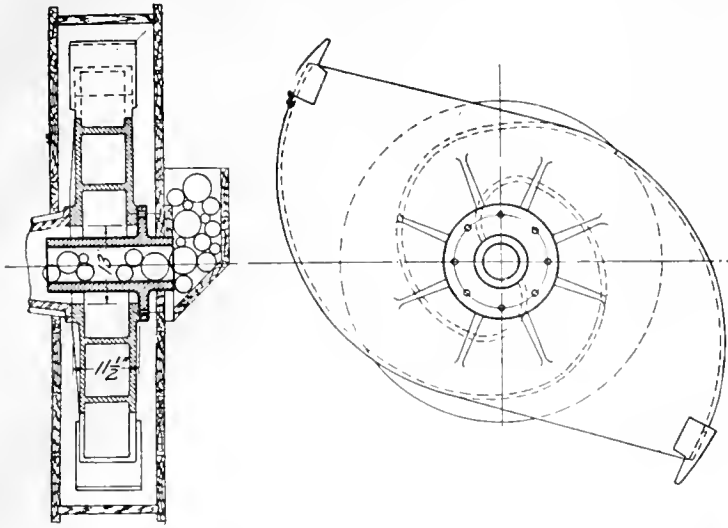

FIG. 2.

The drawing (Fig. 3) gives the details of the lining. This lining was designed by the American Manganese Steel Co.⁴ At first the pebbles, and later the balls, were

⁴A detailed description of these mills, together with grinding data and Dorr classifier data, will be published in a subsequent paper.

fed to the mills through the feed scoop. This method of introducing the grinding medium into the mill gave considerable trouble, due to the breaking of the feed boxes caused by the jamming of a pebble or ball between the revolving scoop and the feed box. We tried to obviate this difficulty by various changes in the amount of clearance left between the scoop and the box, but without success. In our particular case this trouble was aggravated by the fact that we had to use 7 ft. diam. scoops, in order to lift back into the mill the sand discharged by the Dorr classifier. Finally a method was tried of feeding the pebbles, or balls through a spout passing through the centre of the feed scoop. This device has worked splendidly and all of our mills have since been equipped with it.

Australian Gold Production

The following table compares the gold yield of the Commonwealth for the past two years, according to the official statistics of the various Mines Departments.

| | 1915 | 1914 |
|--------------------------|-----------|-----------|
| | Fine oz. | Fine oz. |
| Western Australia | 1,210,109 | 1,232,977 |
| Victoria | 329,068 | 413,218 |
| Queensland | 249,360 | 249,468 |
| New South Wales | 132,498 | 124,507 |
| Tasmania | 16,000 | 26,243 |
| South Australia | 6,258 | 6,258 |
| Northern Territory | 2,532 | 2,532 |

Total 1,945,825 2,055,203

In Victoria the Bendigo district showed a decided decrease. Most of the Tasmanian production is a by-product from copper ore, also in South Australia.

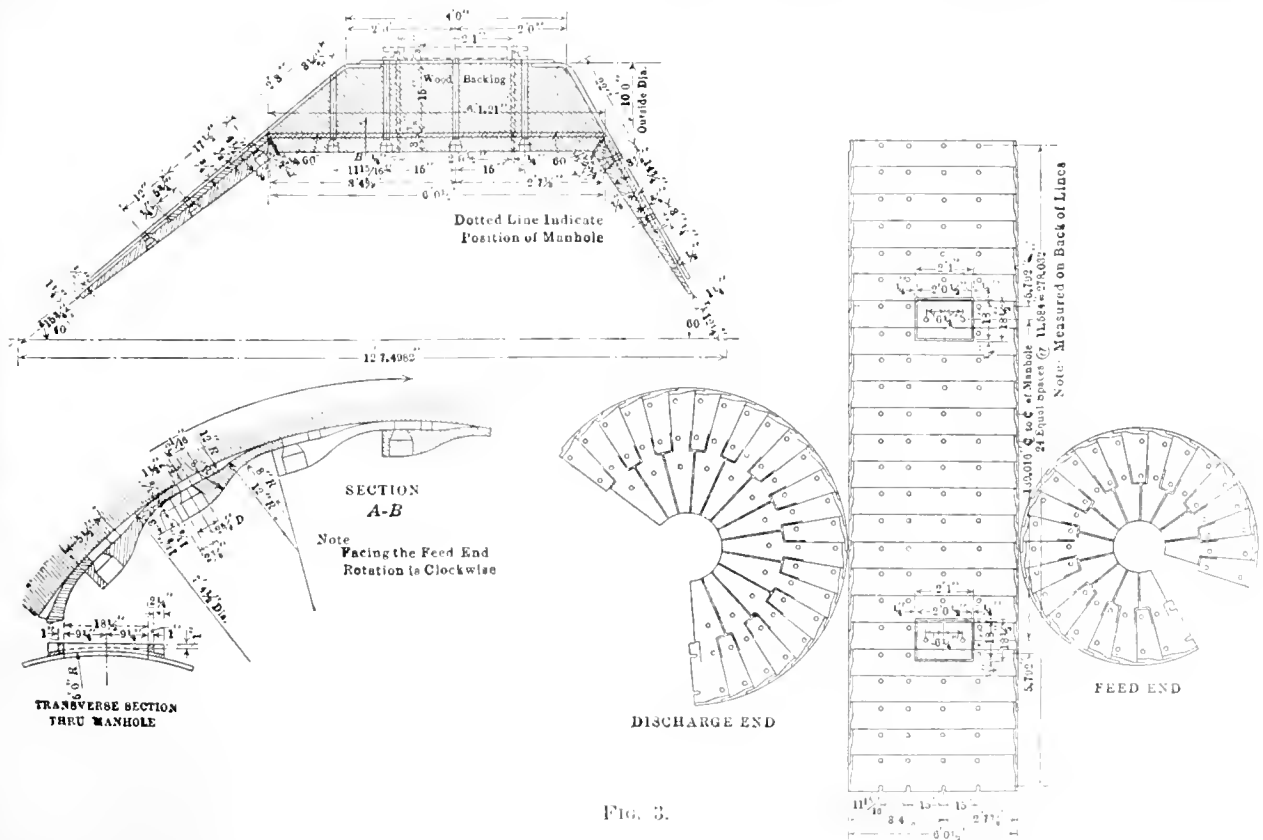

FIG. 3.

CONCENTRATES

Readers of the MINING and Scientific PRESS are invited to ask questions and give information dealing with technical and other matters pertaining to the practice of mining, milling, and smelting.

OPEN CUT MINING produced over 25% of the ore mined during 1913 in the United States, omitting placers.

VIRMILON is the paint made from a particularly pure, nearly translucent, crystalline form of cinnabar, the sulphide of mercury.

HEATING the National copper mill at Mullan, Idaho, costs 24¢ per ton in winter. This increases the efficiency of both men and machinery.

THE COMPRESSIBILITY of methane (80% of natural gas) is 9% more at 600 lb., and 17% more at 1500 lb., than at 15 lb., atmospheric pressure.

ORE from the Brunswick mine, Grass Valley, California, may be considered free-milling, as during 1915 amalgamation and concentration recovered 90.8% of the gold-content.

SILVER PRODUCTION at the Crown Reserve mine, Cobalt, Ontario, cost 45.01¢ per ounce in 1915, an increase of 16.06¢, against 51.56¢ received for the metal. Abnormal conditions and prices account for this difference.

IT IS COMPUTED that the horse-power of gasoline internal-combustion engines in the United States is more than twice that of all engines in the country driven by steam. The former include 2,225,000 automobiles, 300,000 motor-boats, 45,000 motor-trucks, and 30,000 farm-tractor engines.

THE STEAM-SHOVEL, it is stated, was first used in Michigan in 1887 by Joseph Sellwood, a pioneer of the Lake Superior region, to load iron ore from stockpiles into railroad cars. Later John Jones, of Iron Mountain, Michigan, a widely-known mine-operator and inventor, employed a steam-shovel in the opening of the Biwabik mine on the Mesabi range in Minnesota.

GASOLINE can be obtained in almost inexhaustible supply from the shale of north-western Colorado, north-eastern Utah, and south-western Wyoming, says the U. S. Geological Survey. A ton of some of these shales yields over a barrel of oil by distillation. Natural gas, kerosene, paraffin, and ammonia could be recovered in addition to the gasoline. In Scotland several thousand men ordinarily are employed at the oil-shale industry.

NICKEL is used extensively to toughen steel for bridge construction. The amount of nickel consumed for armor plate, guns, and munitions of war in general, is only a minor proportion of the total nickel production. A good deal of nickel is diverted to the manufacture of minor articles of hardware, cooking utensils, German-

silver specialties, and automobile parts. The output of the mines of the Canadian Copper Co. around Sudbury, Ontario, is shipped as matte of 50% nickel, 25% copper, and 25% sulphur to refineries in New Jersey. The matte of the Mond Nickel Co. goes to Clydach, Wales, for refining.

BISMUTH is not a widely used metal. Its brittleness prevents the use of it for anything that should be tough or malleable. It expands on solidifying from the molten condition. While consumed chiefly in medicine, some bismuth is employed in making low-melting cliché alloys, such as in the automatic sprinklers placed as a protection against fire in warehouses and stores, in fuses for electric wiring, and in solders. A little is consumed in bearing metals.

TORBANITE is the principal commercial oil-shale, so named from the Torbane Hill mine, Scotland. It is a brown, fine-grained, schistose shale, having a fawn-colored streak without lustre; sometimes it resembles coal, and it is mined like coal deposits. To reduce, the shale is crushed into blocks the size of bricks, and fed to retorts from hoppers. Ammonia and crude oil are collected in the condensers, after which the crude oil is refined exactly as oil from wells.

OUTPUT of ore on the Rand averages only two-thirds of a ton per man per day. This low figure is due to the extraordinary hardness of the gold-bearing conglomerate and to the native labor employed. The Hollinger gold mine in Ontario, a medium-sized mine, gets about 2 tons per day. At the Treadwell mines in Alaska, where the lode is wide, it is 5½ tons. The British Columbia Copper Co., which aims at breaking ore in a wholesale manner, gets 11 tons per man at one underground mine. The Utah Copper Co., using steam-shovels, has attained 15 tons per man per day.

ALL MINERALS that carry uranium also carry radium, which is now considered a product of the atomic decomposition of uranium. A test for radio-activity is, however, not a conclusive test for radium and uranium, for thorium also has a decomposition product, mesothorium, which closely resembles radium in its behavior, according to the U. S. Geological Survey. Tests for radio-activity will therefore show only whether the specimen contains radium and uranium or mesothorium and thorium. The appearance of the minerals will generally determine which of the elements is present, but in case of doubt the determination requires more elaborate tests, which should be made by an experienced chemist. To test for radio-activity lay the mineral to be tested on a plate holder containing a sensitive photographic plate, and if uranium is present in any considerable quantity the plate will be light-struck within a period ranging from 12 hours to a week, the time depending on the amount of radio-active matter in the specimen. When objects are laid directly upon a sensitized film or plate deceptive effects are obtained by pressure.

Mining in Southern Arizona

By Charles F. Willis

DEVELOPMENTS during the past few months have directed attention to several districts that had been dormant for years. Legends of the wonderful country just north of Mexico, particularly its richness in silver and gems, marked the beginning of mining in southern Arizona. The silver mines of the Patagonia mountains, of Globe, and of Monte Cristo attracted the Spanish explorers, who followed the only feasible route from Mexico, through the valley of the Santa Cruz. They found rich ores that could be taken out on mule-back, but it was not until the '50s that American explorers penetrated the region.

The Ajo mines were located under the laws of the United States by a party of Americans in 1854, and were worked by the Arizona Copper Mining & Trading Co. for half a century, but in a desultory manner. Today the Calumet & Arizona Mining Co. has developed 40,000,000 tons of ore. Under the direction of Dr. L. D. Ricketts, the company has perfected the Greenway leaching process, for the treatment of carbonate ores, with electrolytic precipitation of the copper. A railroad 40 miles long has been built to connect the mines with Gila Bend, so that the old settlement of Ajo, now called Cornelia, has become a thriving city. Work is being rushed on the construction of the reduction plant, and \$5,000,000 is being spent in the enterprise as a whole.

The Twin Buttes, another old district, is coming to the front. E. G. Bush and John G. Baxter, with the faith of the true prospector, borrowed \$300 with which to do their development work last year. Almost at the grass-roots excellent ore was found, and within three months the Bush-Baxter property was bonded to the American Smelting & Refining Co. for \$450,000. Today the Arizonan representative of this company, Julius Krutchnitt Jr., reports that development has been satisfactory, and that 120 tons is being shipped daily to El Paso, this ore running 4 to 4½% copper. Mr. Baxter, however, surmising that there was more than one mine in the district, secured a bond and lease on the Glance, a neglected property belonging to the Twin Buttes Mining & Smelting Co. Again, within three months, he was offered \$600,000 for the property, but this time he decided to operate his own bonanza.

At Bisbee, miners are receiving \$5.35 and shovelers \$5.10 per day. The district is remarkable for the fact that while only nine miles from the Mexican border, none but American labor is employed underground. The Calumet & Arizona Mining Co., which has been operating both its own property and that of the Superior & Pittsburg, has absorbed the S & P. The C & A paid the stockholders of the S & P \$21.50 per share, or exchanged one share of C & A for three and a half shares of S & P,

giving a bonus of \$1 per share for speedy transfer. Although the two companies have been under the same management, the books had been kept separate, involving double clerical work and duplication of taxes, which will now be avoided.

The Arivaca district, including the Guigas mountains and part of the San Luis range, is one of the earliest known mineral localities in southern Arizona. The placers at the foot of these mountains are reported to have financed several Mexican revolutions; they are now

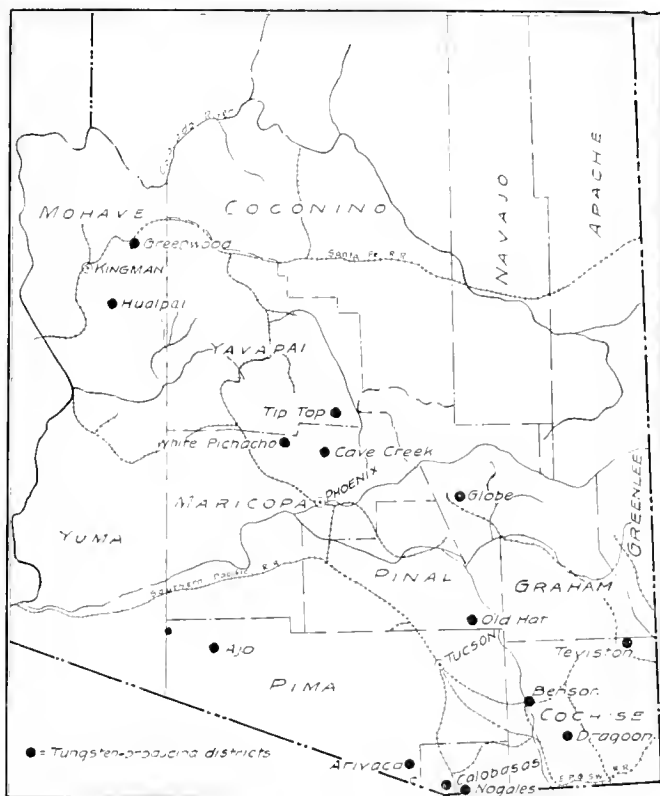

THE TUNGSTEN DISTRICTS OF ARIZONA.

largely owned and operated by the New Venture Placer Mining Co. The gold in these deposits came undoubtedly from the Guigas (meaning 'pebbles') mountains. At the present time this district is more remarkable for its tungsten. Two companies, the National Tungsten Co. and the American Tungsten Co., are employing about 500 men, and maintaining regular shipments of tungsten ore.

The Babaquivari district is in a range of the same name on the west side of the Arivaca valley. The Cababi and Comobabi districts are in the central part of Pima county. This region was the scene of much historic mining and prospecting. Notable in the history of the Southwest is the Pico mine, whose rich silver ores were sent

far into Mexico for treatment. The network of old shafts, inclines, and drifts has made later development difficult, although the deeper workings have revealed the existence of ore bodies that it is believed will rival those of the higher levels.

The Old Hat district has become the scene of renewed activity. The Copper Queen Consolidated has entered the district and has done systematic prospecting. The Daily Arizona Mining Co. has been developing a property on the northern side of the Catalina mountains with favorable results. The Stratton Copper Co. has a good quantity of what, at the present price of copper, is high-grade copper ore. This company has built a remarkable road of approximately 18 miles for motor truck haulage. The Old Hat district has also produced some scheelite and hübnerite.

The notable event of the month was the purchase of the properties of the Imperial Copper Co., at Silver Bell, by the American Smelting & Refining Co., and the leasing of the Saseo smelter, with the restoration of the Arizona Southern railroad. The Imperial properties cover about 1000 acres in the Silver Bell mountains, a small independent range, having a granitic base, with limestone and quartzite capping, the latter much eroded and entirely gone at points. There has been faulting and shearing, the orebodies occurring as irregular contact-lenses, having a north-westerly strike with axes parallel with fault-fissures. The granite porphyry in the vicinity of the lenses is strongly mineralized with copper sulphides. The zone of oxidation is comparatively shallow, no deeper than 150 ft. in the principal workings. The oxidized ores that furnished the bulk of past production are mainly cuprite, malachite, and azurite, while the sulphide ores are chiefly chalcopyrite and some bornite. The mines also show some cupriferous silver-lead ore. This property, owned formerly by the Development Company of America, has suffered from the long litigation of the parent company; it is reported to have produced \$8,000,000, but a year ago was sold at bankruptcy sale. Immediately following the sale, the American Smelting & Refining Co. secured permission to churn-drill the property in order to check the assay-plans of the former management. It is evident that the results were satisfactory, for the new owners have taken possession. This is the largest developed mine in the vicinity of Tucson, being but 35 miles south-west. The operation of this property in connection with that of the Bush-Baxter mine, recently acquired by the same company, means much to southern Arizona. The leasing of the Saseo smelter from the Arizona Smelting & Refining Co. for \$2000 per month means the production of 900 tons of ore daily, and will undoubtedly open a local market for custom ores.

The Patagonia district in Santa Cruz county is a famous producer of copper, gold, and silver. The Old Mowry is a lead mine that was shut-down during the Civil War by the Federal authorities, being suspected of supplying lead for Confederate bullets. The World's Fair mine is now being operated profitably. The Trench,

which was operated in the '50s, has been bonded to W. A. Clark of the United Verde and is being developed systematically. The Hardshell and Flux mines, discovered in 1879, were purchased in 1880 by the present owner, R. R. Richardson. Considerable ore has been shipped, and now the mine is being deepened.

It has just been announced that the Empire Zinc Co. of New Jersey will operate the San Xavier zinc carbonate mine, which they have owned for some time. For several weeks the engineers have been getting the property in readiness for operation and making a preparatory survey either for a railroad or aerial tram of eight miles to the Nogales Branch of the Southern Pacific railroad.

Although, as regards mineral production, Pima county has been behind Cochise, Greenlee, Yavapai, Gila, Mohave, and Pinal counties, the commencement of large-scale operations by such companies as the Copper Queen Consolidated, the American Smelting & Refining, the Empire Zinc, and the Calumet & Arizona promises a new era of successful development.

Accidents at Anaconda

The Bureau of Safety of the Anaconda Copper Mining Co. has compiled the following data on accidents at its properties during 1915:

| | Per cent of fatal and serious accidents. | Per cent of all accidents, including slight. |
|------------------------------------|--|--|
| Falling ground and rocks..... | 12.8 | 32.3 |
| Handling timber, tools, pipe, etc. | 16.4 | 17.9 |
| Ore-cars and trains..... | 14.8 | 8.7 |
| Falling timber, tools, etc..... | 4.1 | 4.2 |
| Men falling through floors..... | 6.8 | 3.1 |

The following tabulation gives the accident rates per 10,000 shifts for each quarter of the year 1915. The accidents considered include all on surface and underground of the classes given that occurred in the metal mining department:

| | Fatal. | Serious. | Per cent reduction by comparison with 1st quarter. |
|---------------------------------------|--------|----------|--|
| First quarter | 0.09 | 1.83 | ... |
| Second quarter | 0.17 | 1.52 | 17.0 |
| Third quarter | 0.09 | 1.03 | 43.9 |
| Fourth quarter | 0.05 | 0.89 | 51.4 |
| Average for the year, all mines | 0.10 | 1.32 | 27.9 |
| Anaconda group | 0.10 | 1.42 | 25.3 |
| B. & M. group..... | 0.10 | 1.21 | 32.4 |
| Southern Cross mine.... | ... | 0.57 | ... |

Over 50% of the injuries caused by falling ground was due to carelessness of the men themselves.

NEW MEXICO has an area of 122,580 square miles, which is more than twice that of Georgia. Its population, 400,000, is more than that of Arizona, being equal to Utah or Idaho. New Mexico's output of copper in 1915 was greater than that of Nevada. The State's production of minerals last year was \$22,000,000.

REVIEW OF MINING

As seen at the world's great mining centres by our own correspondents.

LEADVILLE, COLORADO

INTERESTING NOTES ON LABOR TROUBLE AT THE LOCAL SMELTER.

On Friday, February 25, five hundred smelter-men employed at the Arkansas Valley plant of the A. S. & R. Co. went on strike for higher wages, and an adjustment of the existing working conditions. The following Sunday, E. E. McLaughlin and A. J. Warren, chairman and secretary of the Colorado Industrial Relations Commission, arrived from Denver and took charge of the situation. They stated that the smelter-men had violated the new act that went into force last August, in connection with the workmen's compensation law, and that they were subject to the penalties provided in the law.

The clauses of the law covering the case are quoted below: "Employers and employees shall give at least 30 days' notice of an intended change affecting conditions of employment with respect to wages or hours; and, in every case where a dispute has been made the subject of an investigation, hearing, or arbitration by the Commission, or the board, until the dispute has been finally dealt with by the Commission, or board, neither of the parties nor the employees affected, shall alter the conditions of employment with respect to wages or hours, or on account of the dispute, do, or be concerned in doing, directly or indirectly, anything in the nature of a lockout or strike, or a suspension or discontinuance of work or employment; but the relationship of the employer and employee shall continue uninterrupted by the dispute, or anything arising out of the dispute; but if either party uses this or any other provision of this Act for the purpose of unjustly maintaining a given condition of affairs through delay, such party shall be guilty of a misdemeanor and, upon conviction thereof, shall be punished by a fine of not more than one hundred dollars."

"Any employee, who goes on strike contrary to the provisions of this act shall be guilty of a misdemeanor and, upon conviction thereof, shall be punished by a fine of not less than ten dollars (\$10) nor more than fifty dollars (\$50) for each day or part of a day that such employee is on strike."

Mr. McLaughlin contended that each and every smelter-man on strike was liable to the rulings of the above law, and that they should be dealt with accordingly. However, the fact that the men were all foreigners, the greater number being Austrians, and that they were not familiar with the law, was taken into consideration. The other members of the commission, Frank P. Lannon and E. L. Williams, together with Attorney-General Farrar, were called to the scene, and it was decided to give the men a chance to return to work before taking legal steps against them.

The Commission held several conferences with the men, and fully instructed them through an interpreter as to the readings of the law and their violation of it. The strikers then contended that they did not strike, but stated that they had simply quit work because they did not wish to labor under the conditions at the plant. A great number of them drew their time-checks and thereby put themselves within the law.

The Commission then adopted a policy urging the men to make known their grievances and to return to work so that an investigation could be legally taken up.

The men stated that they did not want to go to work until they were given an increase of 50c. per day, and the system of hiring and firing had been adjusted. They said that under

the present arrangement they were subject to graft on the part of the foremen in the smelter and were under the control of a company store, which, although not in connection with the company, was just as binding. Frank Zaitz, president of the Hart-Zaitz Mercantile Co., the store in question, is accused by the men of forcing them to trade with him or lose their jobs. For several years he has acted as a sort of 'padrone' to the smelter-men, and at the same time it is alleged that he has had an agreement with the company for furnishing labor. This gave him an almost absolute control over the men. He could get them work and if they did not do as he wished he could have them discharged or laid-off, according to the stories of a number of the strikers. It is a known fact that he draws time-checks for the greater number of the men at the smelter through assignments of wages, which it is stated he demands from the men before giving them work. Some of these assignments call for wages over a year in advance. In many cases it is said that the men do not owe him a cent, but that in order to keep their jobs they must allow him to draw their checks

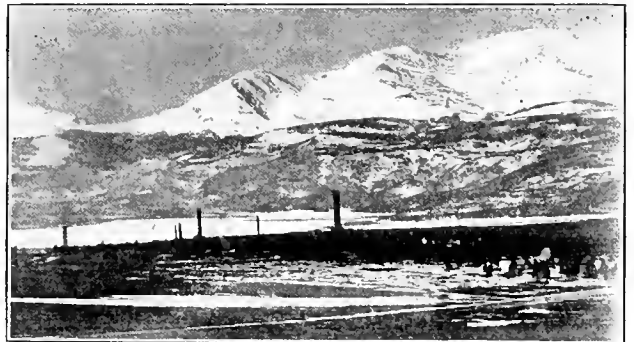

A SMELTER AT LEADVILLE.

and trade at his store. He settles up their accounts every month, and gives the men what is left. He is accused of charging them higher prices for his goods than other merchants and of generally "holding them up" whenever an opportunity presented itself.

Upon getting a statement of these demands from the smelter-men, the Commission began an energetic campaign to persuade the men to return to work, promising that an immediate investigation of their conditions would be started as soon as the strikers obeyed the rulings of the industrial act, namely, to give 30 days' notice before walking out.

Several days of activity among the members of the Commission and repeated conferences with the men proved unavailing, as it appeared that the situation was to develop into violent outbreaks. Many of the men wanted to heed the instructions of the Commission, but a number of agitators stood firm on their demands and refused to go back to work until promised the wage increase. These men it seemed had control, and were threatening any of the others who wished to go to work. Two men who did go back were waylaid and beaten, and as a result others were afraid to risk it. Fritz von Fischer-Ankern, vice-consul of the Austrian legation at Denver, was called to the scene and talked to the men. He tried to make them see the position of the Commission and understand that their conditions would be greatly improved if they would just

men to work and thereby allow an investigation. Still the men refused to be moved from their stand, and Governor Carter was advised of the situation. He immediately replied that if the men did not go back to work they should be treated as violators of the law, and if Lake county did not have sufficient power to enforce the law, State aid would be sent at once.

The prospect of having the militia intervene aroused a number of local men to action in a dual effort to have the matter settled, at least temporarily, without the necessity of calling in the troops. A few influential Austrians took a hand in the affair, and gradually persuaded the greater number of the men to return to work for a month or until such time as the Commission could complete an investigation of their grievances and make its recommendations to the company. By Sunday, March 5, nearly all of the men had returned.

The smelter, which had been reduced to one furnace, quickly resumed its normal activity and early the following week had five again in blast. No damage was done to the plant.

It is the general opinion here that the smeltermen have a number of just grievances which should be investigated by the Commission. The matter of wages will be looked into and comparisons made with other plants in the State, and if the Commission finds that an increase should be made it will be urged upon the company to do so. The system of employment and the company store matter will be adjusted satisfactorily, it is thought, and the men will secure the privilege to do as they see fit in the matter of trading. There is, however, much to be said in favor of Frank Zaitz and his dealing with the men in his connection with the Hart-Zaitz Mercantile Co. These smeltermen, upon arriving here know practically no one, and it is doubtful if they could secure credit from other firms as they are able to from the Zaitz concern. He keeps them supplied with the necessaries of life, in many cases when they are not at work, and relies on his ability to get the men a job and to then draw their checks for payment. Whether this privilege is being abused is a matter for the Commission to decide. The Commission is now busy on the investigation.

PLATTEVILLE, WISCONSIN

NOTES ON IMPORTANT EVENTS IN THE ZINC REGION.

From every point of view February, usually a dull month in the zinc-mining districts of Wisconsin, this year proved a glowing exception. Intermittent periods of severe winter weather, followed by sudden thaws, interfered with milling and left very bad roads. Strikes, especially among shovelers, nearly all of whom demanded increased pay or uniform can rates, threatened for a time to disrupt the entire field. Operators at first refused to meet the demands of the men, and enforced suspensions of operation were made until new gangs of men could be recruited. In some of the districts the disaffection spread to entire working-forces, but the absolute scarcity of men of all classes and continued high prices for fine ore inspired operators to concede the demands, and the close of the month found the field again harmoniously employed. For the first time in the field drilling-rigs with squads of men then went at a premium, and scores of lessees went begging for outfits, unable to secure any service at all. In the Benton and New Diggings districts every available foot of ground has been secured for mining and prospecting purposes, either by lease or purchase, and many new concerns have made initial investments in drilling-machines in order to get started. Scores of miners are living in tents, while barns and attics provide shelter for many unable to secure houses. Building booms flourished at all of the southern mining centres, including hastily constructed shacks to important municipal improvements. The elaborate drilling program resulted in numerous rich discoveries of both zinc and lead ore in every part of the field. Sales of mining properties were numerous, especially where it was shown that ore could be readily secured by providing the necessary equipment, and

capital flowed into the field from many parts. Several new modern mining equipments were started, and millwrights crowded with work have contracts to fill that will take a year to complete. The Inter-State Light & Power Co. of Galena, Illinois, for a year or more past has regarded the abnormal demand for current as a 'war load' and refused to provide increased capacity. Numerous break-downs under the power available, just as prices for ore reached top levels, engendered a feeling among operators that put them in a most belligerent frame of mind, and threats of damage suits for current being furnished under contract were freely made, with the result that capacity will be doubled. A new battery of boilers of 3500 hp., and a 3000-kw. generator are being installed. Two new separating plants were started; one for the New Jersey Zinc Co. at Mineral Point, and the other for the Galena Refinery Co. at Galena. The National separating plant at Cuba, treating 1000 tons of crude ore per month installed four additional Dings electro-static machines, raising the capacity to 5200 tons.

Zinc-blende prices were exceptionally good all the month. At the beginning of the month a base range slightly in advance of \$100 per ton was paid, rising to \$115 and \$125 at the middle, falling away to \$95 to \$110. Miners of zinc carbonate in the northern district had a surprise, one sale being at \$60 per ton.

FLAT RIVER, MISSOURI

THRIVING CONDITIONS IN THE LEAD REGION.—NEW MILL

FINE-GROUNDING, CONCENTRATION, AND SLIME FLOTATION.

The rising price of lead has greatly stimulated mining operations in this district. During the last year the output of lead has been at a maximum, and has been limited only by the milling capacity of the different companies. Quite a little optioning has been done this winter, and drill-prospecting is being hurried. Most of the known mineral land in the district is owned by five large operating companies, namely, the St. Joseph Lead Co., the Doe Run Lead Co., a subsidiary, Federal Lead Co., St. Louis Smelting & Refining Co., and the Desloge Lead Co. About three or four years ago another company, the Baker Lead Co., controlled by Boston capital, entered the field. This company has operated a shaft near Leadwood, and is now sinking a new shaft south of Elvins. The ore is milled by the St. Louis Smelting & Refining Company.

The Federal Lead Co. broke ground on the first of March for a new 2000-ton mill, just west of Elvins. The company expects to finish it in about four months, in order to benefit by the high price of lead. The mill will be practically a duplicate of the present one in its equipment.

Finer grinding is being considered in this district, and this summer will probably show developments along this line. The Doe Run company has ordered a Marcy ball-mill, the Desloge company a Hardinge ball-mill, and the Federal and St. Louis companies Marathon mills. The present intention is to re-grind the Hancock jig-middling, and treat it with tables and flotation.

Table practice is also being changed in some of the mills. The St. Joseph and the Doe Run companies have adopted the Butchart riffle system on their Willey tables. This system has enabled them to handle much large quantities on the tables, thus increasing the capacities of the mills.

The mill-slime in the district is being treated by flotation, and metal recovered which in former years was lost. The Doe Run company has just added another flotation plant to its mill at Rivermines. This gives a capacity to treat approximately 600 tons of slime per day.

Labor conditions in the district are good at present. All the companies have raised wages by giving the men a bonus as the price of lead has advanced. Last June a bonus of 10% was added, and another of 10% on February 15. This makes wages higher than ever before. The men seem quite satisfied, and the output per man is at a maximum.

THE MINING SUMMARY

The news of the week as told by our special correspondents and compiled from the local press.

ALASKA

In accordance with plans approved by the Secretary of the Interior, the investigation of the mineral resources of Alaska by the Geological Survey will be continued this year by 12 parties. Congress has recognized the necessity of preparing in advance for the survey of this difficult field by including the appropriation for its continuation in the urgent deficiency act, which was approved on February 28. This prompt action makes it possible to plan the work in advance of the opening of the field season, and to carry out the plans efficiently and economically.

The work to be done this year includes a detailed survey of the region tributary to Juneau, which is the most important quartz area in Alaska. A continuation of the study of the mineral resources of the Ketchikan district, where there are important gold and copper mines, is also planned. The investigation of the water-powers of south-eastern Alaska will also be continued. Only one party will be employed in the Copper River region. Two parties will work in Prince William sound. Four parties will make surveys in the region directly or indirectly tributary to the Government railroad under construction. One of them will study the new Tolovana placer district, and also make some supplementary investigation of the Fairbanks lode district. The geologist of this party will later visit the Nome district. A detailed geologic survey will be made of the western part of the Nenana coalfield, which is adjacent to the route of the Government railroad. Two other parties will be employed in carrying reconnaissance surveys westward from the railroad route to the Kantishna placer and lode district. It is also proposed to make surveys of the lower Yukon, including the Marshall placer district.

ARIZONA

In Bulletin No. 11 of the State Bureau of Mines, A. C. Rubel discusses tungsten generally, and its occurrence in Arizona. An accompanying map shows the areas in which the mineral is found. Bulletin No. 12, by P. E. Joseph, deals with quick-silver, which is mined in the Sunflower district of Maricopa, and Plomosa district of Yuma county. A list of tungsten-ore buyers is given by the Bureau. Bulletin No. 14, by Frank L. Culin, Jr., deals with magnesite. Bulletin No. 16, by the same author, covers mica. There are several deposits of this mineral in Arizona, but none have been much developed. The occurrences are in the north side of the Grand Canyon, Coconino county; in the White Horse Tank mountains, south-west of Phoenix, Maricopa county; Mohawk mountains of Yuma county; and the Santa Catalina mountains, Pima county.

The Bureau has issued a press letter regarding the number of samples sent to it for determination. Many of these are poorly packed and labeled. Questions regarding the minerals present in rocks are permissible, but assaying is not done free.

COCHISE COUNTY

The following additions and improvements are to be made to the Calumet & Arizona equipment: a 200-ton sulphuric-acid plant, 2 reverberatory and 12 roasting-furnaces, another blowing-engine, enlargement of the sampling-plant and storage-bins, electric transmission-line, and fire-proof storehouse. The design is in charge of A. G. McGregor for Repath and McGregor.

GREENLEE COUNTY

On March 9 a union employee was discharged by the

Shannon Copper Co. for impertinent interference, whereupon the mine, mill, and smelter were rendered idle by a general strike, pending a conference with the manager, J. W. Bennie. The American employees remained at work.

The strike has been settled after a week's stop.

MOHAVE COUNTY

An apex-suit is reported as probable between the Tom Reed and Big Jim companies at Oatman, the former being the complainant.

A new treatment company, under the name of the Lorezona Ore Purchasing & Reduction Works, has been formed and proposes to handle the concentrates and smelting ores from the Kingman-Oatman-Chloride districts. The object of the company is to afford a market for the ores developed by small operators who have not sufficient tonnage opened to warrant the construction of mills. This will undoubtedly add much impetus to the development of mines in that part of Arizona.

After having installed a 25-hp. hoist and a 500-cu. ft. air-compressor, the Times company, four miles from Oatman, has resumed sinking and development. The water-supply is sufficient. Prospects are most encouraging.

The Oatman Pioneer mine, 1½ miles west of the United Eastern and Tom Reed, has been acquired by the Keith's of Boston. Valuable ore-shoots have been found in this area. The shaft is 400 ft. deep. In the Arizona-Tom Reed, Apex Pioneer, and others farther west development is giving fine results. Well-known engineers reported favorably on the area.

YAVAPAI COUNTY

More discoveries of tungsten ore are reported from the Tule Creek area. The Tule Creek Tungsten Co. contemplates erecting a mill for itself and custom ore.

CALIFORNIA

AMADOR COUNTY

(Special Correspondence.)—Work at the Amador Star mine is progressing rapidly generally.

The Oneta gravel mine, near Charleston, recently uncovered a good deposit. This property is owned by the Oneta brothers.

At the Treasure mine, north of Amador City a contract for building a new mill has been let. Grading is well under way, and mill construction will start in the near future. A large sum of money has been spent on this property in sinking the shaft and prospecting. So much good ore has been opened on the lower level that the company is justified in erecting a mill. J. H. Bell is manager.

Dividend No. 116 has just been paid by the Bunker Hill company at Amador City. During the past 10 years this company has not missed a single monthly dividend. E. Hampton is superintendent.

Amador City, March 11.

Following is the preliminary report of the Plymouth Consolidated for February:

| | |
|------------------------------|----------|
| Ore milled, tons | 11,000 |
| Value of output | \$58,393 |
| Working expense | 30,420 |
| Development | 5,794 |
| Surplus | \$22,179 |
| Other capital expended | 121 |

During 1915 the South Eureka Mining Co.'s income was \$582,762, and dividends paid \$125,354.

CALAVERAS COUNTY

(Special Correspondence.) The Utica Mining Co. is now extracting and milling about 6000 tons of ore per month at the Gold Cliff mine. Twenty stamps are dropping at the Utica cross-shaft mill on ore from development in that mine. A comparative prospecting and development scheme has been followed in the past two years, which will be understood when a few facts relating to the relative positions of veins in the two mines are described. The Gold Cliff and Utica veins are about 3000 ft. apart on the surface, converging somewhat in their southern trend, and also as depth is attained. Development tends to show that within a short distance from the bottom of the present workings, these two veins will come together as a large one. The pitch of the Utica vein, at or near the surface, is 60° to the east, while at the 2400-ft. level it has a pitch of 70°. The Gold Cliff, on the other hand, at or near the surface has a pitch of 55° to the east, and at the 2000-ft. level has changed to 49°. The present lower workings of the Utica show the vein at that point to be about vertical, with a probability that at the depth of 2700 ft. the two veins will junction, when, it is anticipated the value will be greater, and a larger body of ore than ever will be found. Fred J. Martin is superintendent.

Angels Camp, March 4.

ELDORADO COUNTY

At the Georgia Slide mine, near Georgetown, 60 men are employed with a payroll of over \$6000 per month. A mile of pipe has been laid, 10 stamp mill is in course of erection, and driving an adit is under way in charge of J. C. Ingersoll.

GLENN COUNTY

Early in April the California Chrome Mining Co. will commence shipping chrome ore to Fruto from its mine 19 miles distant. The first contract will be 5000 tons.

NEVADA COUNTY

The Buckeye quartz and Cold Springs gravel properties, and other claims totaling 1000 acres, a few miles north-east of Nevada City, have changed hands. E. S. Burr and S. L. Bright of San Francisco represent the new owners.

PLUMAS COUNTY

Diamond-drilling the one-shoot in the Walker mine gives an average of 7.28% copper, 2.7 oz. silver, and \$1.11 gold per ton over a length of 200 ft. Machinery for the tramway and 100-ton flotation-plant is arriving.

SAN BERNARDINO COUNTY

A rush has set in for a gold district 25 miles north of Barstow. A. A. Turner of the Goldstone mine has brought in rich ore to Barstow.

SAN LEUIS OBISPO COUNTY

East in capital last week bought the Oceanic quicksilver mine for \$400,000. San Francisco people were interested in the property. In 1914 this county produced 1336 flasks of metal, mostly from the Oceanic, which is equipped with a 50-ton Scott furnace, 2 Detonets for soot, and a small mill.

SISKIYOU COUNTY

On account of the heavy snow-fall in this county there will be an abundance of water for mining this season.

Engineers are examining the Blue Ledge copper mine at Cooper. At one time this property employed over 200 men.

TRINITY COUNTY

(Special Correspondence.)—Three miles north-west of Carrville, on Coffee creek, at the north of Morrison gulch, the Trinity Development Co. is to install a large dredge now being constructed in Ohio.

The old Golden Jubilee mine, six miles north of Carrville, is being re-opened by the California Extraction Co. Fifteen men are employed, the number to be increased when snow disappears. A compressor and two water-Leyner drills are used. Carrville, March 4.

TELLER COUNTY

Under the leasing system last year the Jumper mine at Stout yielded gold worth \$100,000. The royalty is 25%. Ore is treated at the company's mill.

COLORADO

CLEAR CREEK COUNTY

(Special Correspondence.) Since the Argo mill was provided with flotation apparatus 92% recovery of the metallic content of the ores treated is reported by the manager, J. A. Pearce. The plant is being operated three 8-hour shifts, dealing with 150 tons per day. Most of the supply comes from the Gunnell mine.

Idaho Springs, March 13.

GILPIN COUNTY

A shipment of 112 tons of radium ore, worth approximately \$85,000, was received last week at the Colorado School of Mines at Golden. It is the largest shipment ever made in Colorado. The ore came from the Colorado-Gilpin Gold & Radium Mining Co., and is destined for the U. S. Bureau of Mines at Denver, after it has been concentrated at the plant of the School. The shipment is estimated to contain 715 milligrams of radium.

Bulletin 620-M of the U. S. Geological Survey, 'Preliminary Report on the Economic Geology of Gilpin County, Colorado,'

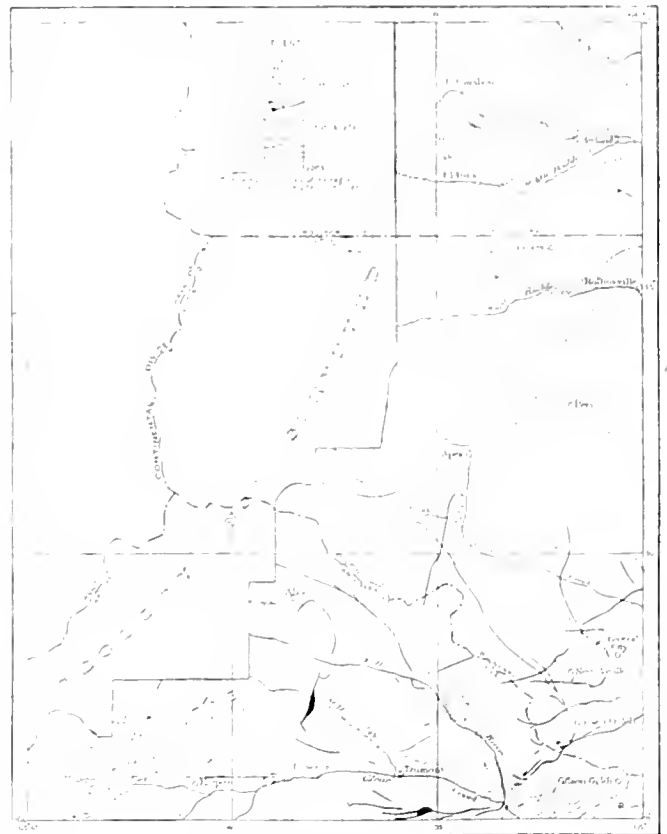

GEOLOGIC FEATURES OF PART OF GILPIN COUNTY.

by Edson S. Bastin and James M. Hill, has been published. With plans it covers 29 pages. Charles W. Henderson assisted in some of the field-work. In the Press of September 18, 1915, an abstract of this paper was given with a map, as the preliminary notes had been published in *Economic Geology*.

TELLER COUNTY (CRIPPLE CREEK)

The Vindicator company has secured an option on a large brick building and ground at Goldfield, owned by the Arkansas Valley Light & Power Co., presumably for a flotation plant to treat the former's low-grade ore.

IDAHO**LEMHI COUNTY**

During 1915 the Gilmore Mining Co. produced 10,173 tons of gold-silver ore, yielding \$114,539 net. The Latest Out, adjoining, produced 31,000 tons of 30% lead ore, and the Gilmore company is exploring to cut the downward extension of this vein.

SHOSHONE COUNTY (COEUR D'ALENE)

On March 23 the Success company paid 3c. per share, equal to \$45,000.

On March 11 about 4000 men working at mines tributary to Wallace received their pay, including the 50c. a day bonus for high lead prices. The lowest average wage was \$116 for February.

The Black Horse mine and mill are to resume operations at an early date by the Murray Hill Mining Co., organized by C. E. Mallette of Spokane. Zinc concentrate will be sold to the U. S. S. & R. company.

In the Pine Creek district a 13-ft. lode has been opened, 9 ft. assaying from 30 to 50% zinc, the remainder being of good grade for a mill, in the Little Pittsburg mine. It is owned by Gus Smith of Spokane, but is under option to the Colonial Mining Co. of Wallace.—In the same district 8 ft. of 42% zinc ore has been cut in the Constitution mine. Thirty men are employed. The company has decided that a 100 or 150-ton mill will be erected as soon as advisable.—There are 30 four-horse teams hauling ore from the Little Pittsburg, Highland Surprise, and Constitution mines. At the Pine Creek siding the railroad is erecting ore-bins. It seems that the district will have a line built through it this year, as somebody has secured right-of-way for a road from the mouth of the creek to the Constitution, and for three miles up the west fork. The C. M. & St. P. railroad is thought to be interested.

It is reported that Pine Creek antimony producers will make no more shipments until they receive better prices for their product. They claim that the smelters are making too much profit by paying low prices.

As has been mentioned before, the Anaconda company has purchased the Douglas lead-zinc mine for \$360,000. A mill is to be erected, concentrate going to Montana for reduction to metal.

On March 20 the Hecla Mining Co. pays 10c. per share, or \$100,000, making \$300,000 for 1915, and \$4,055,000 to date.

MICHIGAN**THE COPPER COUNTRY**

It is reported that the Calumet & Hecla company has offered \$59 per share and some stock arrangement for the Tamarack property.

On March 12 the four-stamp mill of the Trimountain company was destroyed by fire. The loss was \$200,000. The plant will be re-built.

MISSOURI**JASPER COUNTY**

Zinc-ore prices were lower at Joplin last week, a decline of \$15 per ton. Producers do not feel that they are getting enough for their ore, and there is talk of a curtailment. Smelter representatives, on the other hand, maintain that the metal situation is so uncertain that they are not justified in paying higher. Evidently there is a wide variation of opinion between buyers and producers as to what constitutes an equitable price for ore under existing conditions. In this respect it is interesting to recall that the smelters all along have set forth the so-called uncertainty of the spelter market as being the chief reason for their refusing to advance ore prices higher than they have been; yet the reports of the various smelting companies show that most of them have reaped much larger profits, proportionately, than have the mine operators. A fact that is not to be overlooked, however, and one that the smelt-

ers advance is that prior to the sharp advance in zinc the smelters, like the mine operators of that period, were running on either limited margins of profit, or were operating at an actual loss, according to the *Joplin News Herald*. The output of the Missouri-Kansas-Oklahoma region was 7442 tons blende, 292 tons calamine, and 1146 tons lead, averaging \$90, \$72, and \$89 per ton respectively. The total value was \$809,411, and for 10 weeks, \$8,259,652.

On a lease at Prosperity the Franklin Mining Co. is to erect a 400-ton mill, driven by two 250-hp. Bessemer engines. The mine contains a large quantity of 4% blende ore.

A 1000-ton mill is to be erected by the Coahuila Lead & Zinc Co. at Duenweg. A 250-hp. Corliss steam-engine and Sullivan straight-line 1200-cu. ft. compressor are part of the machinery.

MONTANA**FERGUS COUNTY**

During February the Barnes-King properties produced 6049 tons of ore yielding \$43,800. Development in the Shannon ground is good.

GRANITE COUNTY

A recent addition to the geologic map of the United States, just published by the Geological Survey, is the folio covering what is known as the Philipsburg quadrangle, in south-western Montana. The area covered is 827 square miles, which includes several important metalliferous mining districts, among them the Flint Creek (Philipsburg) and Cable (Southern Cross) districts. The folio is the result of geologic investigations by W. H. Emmons and F. C. Calkins. The Flint Creek district is one of the most productive silver-mining regions on the continent. During most of the period from 1888 to 1893 it led all other districts in the United States in output of silver. In 1867, soon after the first discoveries, the Hope mill, which is still standing, was built to reduce the silver ores. The town of Philipsburg grew up about this mill and has maintained itself ever since as the principal settlement of the region. Much of the ore found in the Hope mine was so rich that it could be readily melted down to bullion in an ordinary blacksmith's forge, and the Granite-Bimetallic vein contained what is probably the largest body of high-grade ruby silver ore ever discovered. It has yielded more than 1000 tons of metallic silver that had a value of about \$22,000,000. Extensive bodies of ore still remain in this district, but since the decline in the value of silver in 1893 they have been worked to a moderate extent only. Rather curiously, the Cable, and adjoining districts, although only 16 miles from Philipsburg, produce gold almost exclusively. They are also among the first discoveries in this region and are more active now than at any former period.

LEWIS AND CLARK COUNTY

The Helena Mining Bureau is to hold regular monthly meetings to keep up interest in the mining industry. Through this institution has resulted development of the Head mine; the Eastern Belle, the final payment upon which has just been made by Huffaker and Hill; the Conrad-Perry property; the Allen group of claims, and others in the Scratch Gravel district, as well as at Unionville, Marysville, Alhambra and elsewhere in the Helena district. New properties are being listed with the Bureau which may be purchased or otherwise examined. A lot of interesting news is reported from these districts.

MINERAL COUNTY

At the Tarbox mine near Saltose the shaft is being sunk from 400 to 700 ft. A mill is to be erected to treat second-class ore.

SILVERBOW COUNTY

The February pay-rolls at Butte were the largest on record, totaling \$1,800,000. Of this the Anaconda disburses \$1,200,000, Butte & Superior \$235,000, and North Butte \$120,000.

NEVADA

HUMBOLDT COUNTY

On April 1 the Seven Frouths Coalition pays 24c per shate. The 150-ton mill of the Rochester Mines Co. is to be enlarged to 500-ton capacity at a cost of \$75,000.

At the tungsten mine of J. W. Patterson and W. Nelson, four miles west of Fay, a 15-ton mill is to be erected. Thirty inches of ore assays 5% tungstic acid, and 72 in. contains 1'. The vein at the surface is in a contact of lime and granite.

MINERAL COUNTY

At the Silver Dike tungsten property at Sodaville there are 85 men employed, soon to be increased to 150. Large shipments are made regularly.

NYE COUNTY

The geology and ore-deposition at Tonopah is discussed by J. E. Spurr in a 57 page paper contributed to *Practical Geology* for December, 1915. He gives a history of geologic investigation at Tonopah since 1902, progress of development and modifications of geologic views, results of recent study, Mizpah trachyte, calcitic andesite, analyses of rocks, Montana breccia, West End rhyolite, Midway andesite, mineral veins (those that have made Tonopah are confined to the Mizpah trachyte), periods of vein deposition, temperature of rocks, and the complex faulting.

Considerable importance is attached to the Murray vein in the Tonopah Extension mine, where at a depth of 1540 ft. it is 32 ft. wide of good grade.

Fifteen tons of ore daily is being broken from the vein recently cut at 959 ft. in the Rescue-Eula. One lot returned \$21.59 per ton at the mill. The vein is 5 ft. wide, the ore containing black sulphide, ruby, and nearly pure silver.

Tonopah mines last week produced 9521 tons of ore worth \$190,638.

During February the Belmont produced 252,822 oz. bullion from 12,300 tons, with \$198,221 profit. The Tonopah Mining Co. shipped 142,297 oz. from 6896 tons, with \$59,635 profit.

TEXAS

BREWSTER COUNTY

(Special Correspondence.)—An investigation of the property of the Terlingua Quicksilver Mining Co. has recently been completed by Edward Thomson of New York for people in that city. Reports obtained from a reliable source show it is likely that another of the now remaining idle properties will soon be on the producing-list again.

H. Wardenberger of Kansas, who owns some valuable claims adjoining the Chisos Mining Co.'s holdings, is also contemplating an early resumption of work; so is the Dallas Mining Co. of the Big Bend district.

The Study Butte Mining Co. reports good progress and results with its development. One shipment of metal has been made, and the company expects to be making them regularly from now on.

Terlingua, March 8.

UTAH

BEAVER COUNTY

The Majestic Mines Co. reports that between September and February the Old Hoosier mine produced 4193 tons of ore yielding 5759 oz. silver and 239,945 lb. copper, netting \$17,182 at the smelter. Work at the Hoosier Boy, Harrington-Hickory, Vicksburg, and O. K. mines has been satisfactory.

SALT LAKE COUNTY

During 1915 the Utah-Apex company produced 4900 oz. gold, 560,000 oz. silver, 2,400,000 lb. copper, and 32,000,000 lb. of lead. The lead output is now at the rate of 50,000,000 lb. per year.

SUMMIT COUNTY

Preliminary work has been started on the Daly-Judge electric smelter.

Development in the Three Kings is reported as good. Two strong fissures have been cut.

In the suit of the Conkling Mining Co. v. the Silver King Coalition Mines Co., an extra lateral dispute, the U. S. Court of Appeals decided that the plaintiff owns a quarter and the defendant three-quarters of the property, reversing the previous judgment of the District Court. About \$1,000,000 of ground must be adjudicated.

WASHINGTON

By April 1 mining companies operating in the Coeur d'Alene, Idaho, and British Columbia will have paid \$3,188,834 in dividends for the first quarter of the year. Of this amount \$2,287,885 was contributed by seven Idaho and \$900,949 by six British Columbia companies, and it will increase the grand total of net profits for eastern Washington, Interior British Columbia, western Montana, and all of Idaho to \$86,557,979, including those companies now dormant or absorbed by other corporations. The following table shows the amount of dividends that will be paid in the first quarter of the current year by the operating companies, together with the grand total to April 1:

| COEUR D'ALENE | | |
|----------------------------------|-------------|--------------|
| Company. | 1916. | Grand total. |
| Bunker Hill & Sullivan | \$327,000 | \$17,160,000 |
| Caledonia | 208,400 | 4,091,131 |
| Federal | 120,000 | 15,105,545 |
| Hecla | 300,000 | 4,955,000 |
| Hercules | 600,000 | 8,600,000 |
| Consolidated Interstate-Callahan | 697,485 | 3,245,339 |
| Stewart | | 2,943,425 |
| Success | 135,000 | 1,739,000 |
| Total | \$2,387,885 | \$53,271,031 |
| BRITISH COLUMBIA | | |
| Company. | 1916. | Grand total. |
| Canadian Consolidated M. & S. | \$175,282 | \$ 2,495,418 |
| Crows Nest Coal | 93,189 | 2,276,864 |
| Granby | 224,978 | 5,951,901 |
| Hedley | 120,000 | 1,883,520 |
| Le Roi No. 2 | | 1,516,749 |
| Mother Lode | 137,500 | 137,500 |
| Rambler-Caribou | | 120,000 |
| Standard | 150,000 | 1,950,000 |
| Total | \$900,949 | \$16,661,952 |
| Grand total | \$3,288,834 | \$69,932,983 |

FERRY COUNTY

(Special Correspondence.)—It is reported that a contract for the first 250 ft. of a 1000-ft. vertical double-compartment shaft in the ground owned by the Republic Consolidated Mines Corporation has been let to George S. Bailey, the trustee in bankruptcy of the Republic Mines Corporation. The former company owns the Lone Pine, Pearl, and Surprise claims, but on which a shaft is to be sunk information is not yet available.

On March 10 an explosion occurred in the compressor-room of the power-house at the Knob Hill mine. The only person in the room was Joe Wiseman, the engineer, who saw a small place on fire. Instantly the explosion followed, and the whole room was filled with smoke and fire. Wiseman, a careful man, was blinded with the smoke, but attracted a number of workmen who were coming out of the mine. He was severely burned. The compressor-room was consumed, but the building adjoining was saved.

Some machinery has been hauled from the Great Northern Railway depot to the San Poil mine for the West Side Mining Co., a new corporation here.

Republic, March 19.

The old San Poil mine and mill at Republic has been taken over under a five-year lease and bond for \$150,000 by the West Hill Mining Co., recently organized by Inland Empire men. The bond calls for yearly payments of \$30,000, and 10% of the smelter returns for ore shipped is to be applied on the purchase price. D. M. Drumheller, Jr., is manager for the new corporation, and he already has put 20 men on preparatory work. The mill, a 75-ton daily capacity cyanide plant, will not be started yet, but may be operated later. A contract has been secured from the Canadian Consolidated company for 2000 tons of ore monthly, to be treated at its smelter at Trail, B. C., and the first shipments will be forwarded in a few days. The San Poil is a gold producer, the product, according to engineers' reports, assaying from \$7 to \$15 per ton. It was extensively developed by the former owners, underground work and equipment costing not less than \$300,000. It is said that there are 30,000 tons of ore blocked out ready for extraction above the 300-ft. level. The new operating plans contemplate extending the 400-ft. level to cut the shoot showing in the upper workings, and later a shaft will be sunk to 800 ft. depth.

CANADA

BRITISH COLUMBIA

On March 31 the Hedley Gold Mining Co. pays its quarterly dividend of 3%, and an extra of 2 per cent.

The Silver Hoard Mining Co. will erect a 200-ton mill near Ainsworth this summer. George Chew is president and general manager.

The Slocan Star mine at Sandon has been examined, and the company will re-model and enlarge its mill to 250-ton capacity, to treat the silver-lead and zinc ores. Bonds worth \$80,000 were issued last week for this purpose.

On account of the bad weather in January the Standard Silver-Lead company suffered a loss of \$26,329. About \$10,000 will be paid by the Canadian Pacific railroad for five cars of concentrate lost on the lake. February will also be a poor month. On April 10 will be paid 2½c. per share, or \$50,000.

ONTARIO

As explosives and steel prices have advanced so much, the higher quotes for silver have not balanced this increase at Cobalt, so economy is the order of the day.

During February the Nipissing high-grade and low-grade mills treated 124 and 6954 tons of ore, yielding \$72,146 and \$99,710 respectively, a total of \$171,856. The refinery shipped 535,514 oz. silver from all sources. No. 81 shaft, to develop the Cobalt Lake fault-vein, is down 310 ft. The fault was cut at 270 ft., being of no value.

KOREA

The Seoul Mining Co., operating the Suan Concession in Whanghai province, Chosen, reports the following results for February:

| | |
|----------------------------|-----------|
| Ore treated, tons | 14,420 |
| Mill operating, days | 24 |
| Bullion | \$ 62,500 |
| Concentrate | \$ 57,950 |
| <hr/> | |
| Total recovery | \$120,450 |
| Expenses | 55,000 |
| <hr/> | |
| Operating profits | \$ 65,450 |

Copper is figured at 12c. per pound.

MEXICO

SONORA

The Moctezuma Copper Co. at Nacozari decided to send its employees to Arizona, on account of the Mexican trouble. The general manager, J. S. Williams, Jr., and General Calles conferred on the question.

PERSONAL

PHILIP ARGALL is at New York.

HORACE V. WINCHELL was at Salt Lake City this week.

ERNEST BAMBERGER, of Salt Lake City, is at the St. Francis hotel.

C. E. JULIEN has been examining the Burning Moscow mine, in Utah.

E. L. LARISON and F. F. FRICK of Anaconda are at the Bellevue hotel.

F. C. ALSDORF is examining properties in Nevada and northern California.

JAMES HOATSON, of Calumet, Michigan, was in San Francisco last week.

D. M. RIORDAN is expected in San Francisco on his return from New York.

JOHN COOPER has passed through New York on his way from London to Zacatecas.

R. R. LESLIE, manager of the Butters Divisadero mine, in Salvador, is here on a holiday.

R. S. BOTSFOED has gone to the Bodaibo region, in Siberia, to report on dredging conditions.

KARL EHLERS, a director of the A. S. & R. Co., has been in San Francisco on a tour of inspection.

JOHN R. MITCHELL and P. H. ARGALL have been examining mines along the Mother Lode and in Nevada.

H. R. BOSTWICK, A. R. WEIGALL, and J. F. MITCHELL-ROBERTS sail on the *Tenyo Maru* for Korea on March 28.

FRANK O. JASMER has returned from the Republic of Honduras and expects to go to Mexico in the near future.

F. C. LINCOLN, of the Mackay School of Mines, Reno, is gathering information and statistics on Nevada mining.

GEORGE T. COFFEY, superintendent of the hydraulic department of the Yukon Gold Co., has returned to Dawson from Oakland.

H. A. GUESS, formerly consulting engineer, has been appointed managing director of mining department of American Smelting & Refining company.

E. E. MCCARTHY, dredge superintendent of the Yukon Gold Co., arrived from New York in San Francisco March 15, where he will be for two weeks at the Palace hotel.

W. A. NEILL, for many years engineer of the mining department of Allis-Chalmers Co., has moved to Denver and become associated with the Dorr Cyanide Machinery Company.

WILLIAM F. JAHN, for the past three years mill superintendent for the New York & Honduras Rosario Mining Co. at San Juanito, Honduras, C. A., has resigned and will leave shortly for the United States.

F. H. BROWNELL of Seattle, chairman of the board of directors of the Federal Mining & Smelting Co., will succeed HARRY L. DAY of Wallace, Idaho, as president and general manager. H. A. GUESS of Wallace becomes managing director.

A. L. BLUMFIELD, for many years in the employ of Bewick-Moreing & Co., as metallurgist, and for the last eight years mill superintendent of the Golden Cycle mill at Colorado Springs, has become associated with the Dorr Cyanide Machinery Co.

S. R. ELLIOTT of Negaunee, Mich., is now general superintendent of Cleveland-Cliffs Iron Co., a new position that takes some of the work formerly directed by M. M. DUNCAN whose title changes from agent to general manager. A. J. YOUNGBLUTH has been made purchasing agent. The company now controls over 20 mines.

The regular meeting of the Missouri Mining Association was held on March 13, at the School of Mines, Rolla. An address was given by PHILIP N. MOORE, first vice-president of the A. I. M. E. Following this, an enjoyable smoker was held. Officers of the Association are as follows: L. W. EHLERS, president; J. G. REILLY, vice-president; W. A. SHAW, secretary; and H. A. KLEGE, treasurer.

THE METAL MARKET

METAL PRICES

San Francisco, March 21

| | |
|--|-----------|
| Antimony, cents per pound | 41 |
| Electrolytic copper, cents per pound | 27.75 |
| Eng. lead, cents per pound | 7.00 8.45 |
| Platinum, soft metal, per ounce | \$88 |
| Platinum, hard metal, 10% iridium, per ounce | \$91 |
| Quicksilver, per flask of 75 lb. | \$210 |
| Spelter, cents per pound | 22 |
| Tin, cents per pound | 16 |
| Zinc-dust, cents per pound | 30 |

ORE PRICES

San Francisco, March 21

| | |
|--|-------------|
| Antimony, 50% product, per unit, of 17, or 20 lb. | \$2.25 |
| Chromite, 40% and over, 100 lbs. California, per ton | 11.00 |
| Magnesite, crude, per ton, 100 lbs. | 8.00 |
| Magnesite, plastic, no iron and lime, cubed, ton | 25.00-30.00 |
| Magnesite, refractory, 11% iron, dead-burned, ton | 35.00 |
| Manganese, 50% metal, 8% silica, per ton | 12.00 |
| Tungsten, minimum 60% WOs, per unit of 20 lb. | 65.00-75.00 |

At Boulder, Colorado, 60% tungsten ore jumped from \$75 to \$90 per unit last week.

New York, March 15.

Antimony ore is firm at \$2.70 to \$2.75 per unit.
 Tungsten ore for forward delivery exceeds \$70 per unit, and spot, if offered, would easily bring \$80.
 Spot 80% ferro-manganese, a product of the blast-furnace, has been sold in car-load lots at \$350 per ton. Ferro-manganese, containing 50% manganese, is held at \$5 per unit. Spiegelsisen, containing 20% manganese, has sold at \$60 per ton. All of these products, indispensable in the making of steel, are exceedingly scarce.

EASTERN METAL MARKET

(By wire from New York.)

March 21—Copper producers are firm but quiet; independents control the lead market; zinc is firm and more active.

SILVER

Below are given the average New York quotations, in cents per ounce, of fine silver.

| Date | Average week ending | | |
|-------------|---------------------|--------|-------|
| Feb. 15 | 56.75 | Feb. 9 | 56.79 |
| " 16 | 56.87 | " 16 | 56.62 |
| " 17 | 57.00 | " 23 | 56.86 |
| " 18 | 57.00 | Feb. 1 | 56.79 |
| " 19 Sunday | 57.00 | " 8 | 56.75 |
| " 20 | 57.37 | " 14 | 56.68 |
| " 21 | 57.92 | " 21 | 57.10 |

| Monthly averages. | | | 1914 | 1915 | 1916 |
|-------------------|-------|------|-------|-------|-------------|
| Jan. | 57.58 | 1915 | 56.76 | July | 54.90 47.52 |
| Feb. | 57.57 | 1915 | 56.74 | Aug. | 54.25 47.11 |
| Feb. | 58.01 | 1915 | 56.61 | Sept. | 53.75 48.77 |
| Apr. | 58.52 | 1915 | 56.25 | Oct. | 54.12 49.40 |
| May | 58.21 | 1915 | 56.87 | Nov. | 49.12 51.88 |
| June | 56.43 | 1915 | 49.02 | Dec. | 49.27 55.31 |

After a quiet but steady market, silver has suddenly moved up. There has been a large outflow of silver from the Indian currency reserve for various purposes, amounting to 65,500,000 oz. Shipments of metal from London to India to February 23 are 7,200,000 oz. less than in the period of 1915.

Silver worth \$27,700 (462,000 oz.) was shipped last week from San Francisco to China.

COPPER

Prices of electrolytic in New York, in cents per pound.

| Date | Average week ending | | |
|-------------|---------------------|--------|-------|
| Feb. 15 | 26.77 | Feb. 9 | 26.16 |
| " 16 | 26.74 | " 16 | 27.06 |
| " 17 | 26.74 | " 23 | 27.25 |
| " 18 | 26.74 | Feb. 1 | 27.12 |
| " 19 Sunday | 26.74 | " 8 | 26.92 |
| " 20 | 26.74 | " 14 | 26.59 |
| " 21 | 26.74 | " 21 | 26.48 |

| Monthly averages. | | | 1914 | 1915 | 1916 |
|-------------------|-------|------|-------|-------|-------------|
| Jan. | 14.21 | 1915 | 13.26 | July | 13.26 19.09 |
| Feb. | 14.49 | 1915 | 20.62 | Aug. | 12.34 17.27 |
| Feb. | 14.11 | 1915 | 14.89 | Sept. | 12.92 17.59 |
| Apr. | 14.19 | 1915 | 16.64 | Oct. | 11.10 17.99 |
| May | 13.97 | 1915 | 18.71 | Nov. | 11.75 18.88 |
| June | 13.60 | 1915 | 19.77 | Dec. | 12.75 20.67 |

Bradley produced 2,812,000 lb. in February (29 days), against 4,556,000 lb. in January (31 days).

Miami expects to produce 50,000,000 lb. in 1916.

Rio Tinto has declared \$8.10 per share on the ordinary shares, against \$4.50 in the first half of 1915.

Reports from the copper companies for 1915 are now coming to hand and will be reviewed in the 'Press' as early as possible.

LEAD

Lead is quoted in cents per pound, New York delivery.

| Date | Average week ending | | |
|-------------|---------------------|--------|------|
| Feb. 15 | 6.25 | Feb. 9 | 6.12 |
| " 16 | 6.37 | " 16 | 6.26 |
| " 17 | 6.45 | " 23 | 6.30 |
| " 18 | 6.50 | Mar. 1 | 6.30 |
| " 19 Sunday | 6.50 | " 8 | 6.60 |
| " 20 | 6.50 | " 14 | 6.82 |
| " 21 | 6.45 | " 21 | 7.12 |

| Monthly averages. | | | 1914 | 1915 | 1916 | |
|-------------------|------|------|------|-------|-------|-----------|
| Jan. | 4.11 | 1915 | 3.73 | 5.95 | July | 3.80 5.59 |
| Feb. | 4.02 | 1915 | 3.83 | 6.23 | Aug. | 3.86 4.67 |
| Feb. | 3.94 | 1915 | 4.04 | | Sept. | 3.82 4.62 |
| Apr. | 3.86 | 1915 | 4.21 | | Oct. | 3.60 4.62 |
| May | 3.90 | 1915 | 4.24 | | Nov. | 3.68 5.15 |
| June | 3.90 | 1915 | 5.75 | | Dec. | 3.80 5.34 |

On account of the advance in lead, Joplin producers consider \$100 per ton for 80% product justified, and expect to see that figure soon.

The Consolidated Mining & Smelting Co. of Canada pays \$2.50 per share on April 1, a total of \$175,282.

QUICKSILVER

The primary market for quicksilver is San Francisco, California being the largest producer. The price is fixed in the open market, according to quantity. Prices, in dollars per flask of 75 pounds:

| Date | Week ending | | |
|---------|-------------|--------|-----|
| Feb. 23 | 2300 | Feb. 8 | 250 |
| Feb. 1 | 2385 | " 14 | 235 |
| | | " 21 | 210 |

| Monthly averages. | | | 1914 | 1915 | 1916 | |
|-------------------|-------|------|-------|--------|-------|--------------|
| Jan. | 39.25 | 1915 | 51.90 | 222.00 | July | 37.50 95.00 |
| Feb. | 39.00 | 1915 | 60.00 | 225.00 | Aug. | 80.00 93.75 |
| Feb. | 39.00 | 1915 | 78.00 | | Sept. | 76.25 91.00 |
| Apr. | 38.90 | 1915 | 77.50 | | Oct. | 53.00 92.90 |
| May | 39.00 | 1915 | 75.00 | | Nov. | 55.00 101.50 |
| June | 38.60 | 1915 | 90.00 | | Dec. | 53.10 123.00 |

The market continues weak. It is reported that Great Britain has eased the embargo on metal from Europe, which may result in imports to the United States, further lowering the price.

The New Idria company pays \$1 per share (\$100,000) on March 31. The Oceanic mine in San Luis Obispo county, California, has been sold for \$400,000. Its output is over 1900 flasks per year.

ZINC

Zinc is quoted as spelter, standard Western brands, New York delivery, in cents per pound.

| Date | Average week ending | | |
|-------------|---------------------|--------|-------|
| Feb. 15 | 16.75 | Feb. 9 | 19.98 |
| " 16 | 17.12 | " 16 | 19.92 |
| " 17 | 17.12 | " 23 | 21.35 |
| " 18 | 18.25 | Feb. 1 | 20.71 |
| " 19 Sunday | 18.25 | " 8 | 19.92 |
| " 20 | 18.25 | " 14 | 18.17 |
| " 21 | 18.25 | " 21 | 17.83 |

| Monthly averages. | | | 1914 | 1915 | 1916 | |
|-------------------|------|------|-------|-------|-------|------------|
| Jan. | 5.11 | 1915 | 6.30 | 18.21 | July | 4.75 20.54 |
| Feb. | 5.22 | 1915 | 9.05 | 19.99 | Aug. | 4.75 14.17 |
| Feb. | 5.12 | 1915 | 8.46 | | Sept. | 5.16 14.11 |
| Apr. | 4.98 | 1915 | 9.78 | | Oct. | 4.75 11.05 |
| May | 4.91 | 1915 | 17.02 | | Nov. | 5.91 17.20 |
| June | 4.84 | 1915 | 22.20 | | Dec. | 5.40 16.75 |

If prices paid for 60% zinc ore at Joplin do not harmonize better with the price of spelter, 67 operators in south-west Missouri, producing 5000 tons per week, will curtail output or shut-down.

TIN

Prices in New York, in cents per pound.

| Monthly averages. | | | 1914 | 1915 | 1916 | |
|-------------------|-------|------|-------|-------|-------|-------------|
| Jan. | 37.85 | 1915 | 34.10 | 41.76 | July | 31.60 37.33 |
| Feb. | 39.76 | 1915 | 37.22 | 42.60 | Aug. | 50.20 34.37 |
| Feb. | 38.10 | 1915 | 48.76 | | Sept. | 23.10 32.12 |
| Apr. | 36.10 | 1915 | 48.25 | | Oct. | 30.40 33.00 |
| May | 33.29 | 1915 | 39.28 | | Nov. | 33.51 39.50 |
| June | 30.72 | 1915 | 40.26 | | Dec. | 33.60 38.71 |

Tin is firm at 52 cents.

Eastern Metal Market

New York, March 15.

The lead market has run away, despite all efforts of the leading producer (the A. S. & R. Co.) to hold it in check. The spot supply is scarce, and it has been eagerly sought by both domestic and foreign buyers. Interests on the Pacific Coast have offered 8c., delivered on the Coast, for metal intended for export to Japan, China, and Russia. This price is equal to 7.50 to 7.60c., St. Louis. The A. S. & R. Co. has advanced its nominal quotation to 7c., New York, but is practically out of the market. Copper is dull, but prices are firm, a slight weakness which developed last week quickly disappearing. Zinc has declined steadily for days, but the bottom has apparently been reached. The domestic demand is light, but a more depressing influence is the decline of £25 per ton in the London market in less than 10 days. Tin has touched 56c., and is still strong because of the scarcity of the supply available for March delivery. Antimony continues strong. Aluminum is a little weaker.

Exports of metals in unmanufactured form are not so heavy compared with those of recent months, but large quantities are going abroad in the form of munitions. The aggregate value of munitions exported in the week ended March 11 was \$17,370,243, against \$11,418,241 in the previous week, and \$5,997,439 two weeks ago. Shipments of cartridges in the week ended March 11 totaled \$1,729,556, against \$696,774 and \$93,984, one and two weeks ago. The value of other munitions are proportionate. For the seven months ended January, 1916, exports of miscellaneous iron and steel totaled \$64,844,131, while for the same period ended January, 1915, they were \$8,554,873.

The steel market is a run-away, and prices are difficult to gauge.

COPPER

Since the recent strike at the Ansonia mills of the American Brass Co. the demand for copper has been light, and for the past few days the market has been very dull. The strike only lasted a week, but it seems to have frightened consumers into stopping to realize the prices they were paying. A further influence on prices has been the congestion of freight on the New York, New Haven & Hartford railroad, which has halted deliveries from time to time. The embargo was raised for a period of four days ended at midnight March 14, and in this time a great deal of copper, as well as other metals and materials, were forwarded to their destination. In the latter part of last week the market weakened a little because second-hands were offering at concessions. It was possible to shade 26.50c., for near future deliveries, although the larger sellers adhered to their minimum quotations. Consumers are well covered for the present, as they should be in view of the vast movement of a few weeks ago, consequently there is little or no buying of spot copper. The next large buying movement probably will be for deliveries in June and later. Spot electrolytic hangs around 27.50c., cash, New York. Lake is nominally quoted at the same figure. Electrolytic at London is unchanged at £136. Exports up to and including March 14 totaled 6833 tons.

ZINC

Except for steady recessions in price the zinc market has been without feature during the past week. Needless to say, the demand has been dull. The quotation for prompt yesterday was 16.75c., New York, and 16.50c. St. Louis, both of which were about 1c. above the quotations of the previous day. April and May were quoted at 16c., St. Louis, and June at 15c.

It is felt that the bottom has been reached, and that from this time on quotations will advance, or at least hold their own. Since March 6, when the British Ministry of Munitions permitted the resumption of trading (under certain restrictions) on the London Metal Exchange, spot zinc has declined from £110 to £85, a drop of £25. Though details are lacking, it is felt here that the Ministry is making a minimum price effective, and is doing it successfully, which was not done in copper. Exports of this month, up to and including the 14th, totaled 906 tons.

Sheet-zinc is quoted at 25c., f.o.b. mill, earload lots, 8% off for cash.

LEAD

The market is a run-away one of the worst type. Spot lead is scarce, and both domestic and foreign buyers are clamoring for what is to be had. Interests on the Pacific Coast have been heavy buyers for export to Japan, and to Russia, by way of Japan, and have bid 8c., delivered on the Coast. This is equal to 7.50 to 7.60c., St. Louis. The result has been a complete upset to Eastern prices. The A. S. & R. Co. raised its nominal quotation yesterday to 7c., New York, and 6.92½c. St. Louis, (an advance of \$8 per ton) but it is not selling at these levels. The independents are selling what they have at 7.50c., New York, and up to 7.62½c. St. Louis. The average of St. Louis prices has run higher than those at New York, and it is exceedingly hard to tell just where the market stands. The average New York price yesterday was 7.25c., and that at St. Louis 7.37½c. It is plain that efforts to restrain the market from running away have been entirely unsuccessful. The London market, contrary to that for spelter, has gained strength in the past week, and now stands at £35 5s. for spot. Exports this month, up to and including yesterday, totaled 1678 tons.

TIN

Spot tin is scarcer than ever, and it is increasingly difficult to obtain licenses to ship from London. American consumers are partly to blame for the situation. A few of them whose wants were well covered with tin they had in warehouse have obligingly helped out some of their less fortunate friends, thereby violating the agreement they entered with the British authorities. Last Thursday (the 9th) the market was highly excited, probably 500 tons changing hands at prices that ranged from 52 to 56c., all in the course of the afternoon of that day. The trouble is that brokers fear they will be caught short on their commitment for the month, and this is certain to happen if they sell metal which cannot be replenished before the end of March. Arrivals of the month only total 368 tons, but there is afloat 6735 tons. Relief for the present situation hinges to a great extent on the arrival of the steamer *Suruga* from Singapore with 1135 tons. She was to have arrived the 8th, but has been delayed, and it is uncertain whether her cargo will be available for March delivery. The quotation yesterday was 54c., but strong at that figure. While the situation is a problem for the moment, it is a passing one, as the large quantity of tin afloat indicates.

ANTIMONY

The market continues firm and the quotations for Chinese and Japanese grades show no change. Spot is quoted at 14 to 45c., duty paid. March and April shipments from the Far East have sold at 34½c. Needle antimony is in demand, and March shipment from the East has been done at 23½ cents.

ALUMINUM

Spot aluminum, 98 to 99% pure, is easier at 57 to 60 cents.

BOOK REVIEWS

THE MECHANICAL POCKET DIARY AND YEAR BOOK FOR 1916. P. 70. Ill. index. The Notman Remington Co., Baltimore. For sale by MINING AND SCIENTIFIC PRESS. Price, 25 cents.

This is the twentieth year of the publication of this valuable pocket-book. Some material has been added and other parts brought up to date. It contains a number of tables and other data, principally useful to the mechanical engineer, but of value to the engineer in other lines. A diary for 1916 is included. Altogether the purchaser certainly gets a great deal for his money.

CONCRETE. By John C. Trautwine, Jr. and John C. Trautwine, Jr. P. 126. Ill. index. Trautwine Co., Philadelphia. For sale by MINING AND SCIENTIFIC PRESS. Price, \$1.

This book contains the portions of the 'Pocket-Book' that relate to concrete. The first section reprinted is on strength of materials, the next sections are, in order, cement, sand, mortar, concrete, and reinforced concrete. The notes on the last named, while necessarily condensed, contain a good summary of the principles of design in that material. Next comes a division on experiment and practice, which contains a summary of the data obtained concerning concrete and related subjects by a number of observers. Divisions on specifications and on cost data are included and there is also a price-list, bibliography, and index. The book should be of as much value to those interested in concrete construction as the regular pocket-book is to engineers in general.

DAMS AND WEIRS. By W. G. Bligh. P. 206. Ill. index. American Technical Society, Chicago. For sale by MINING AND SCIENTIFIC PRESS. Price, \$1.50.

This is a neat but fairly comprehensive treatise upon the subject. The design of gravity dams of masonry and concrete is first considered and examples with profiles given of a number of dams actually constructed. The effect of percolation under porous foundations is discussed. The next division is overflow dams and weirs, then single and multiple-arch dams, and hollow-arch buttress dams. Submerged weirs founded on sand and methods of preserving stability in spite of percolation are then considered. The last division is open dams or barrages. Earth dams are not considered anywhere in the volume. The book is well illustrated. It would have been made more interesting, at least, if the geological situation of the various structures had been always given.

PRINCIPLES AND PRACTICE OF COST ACCOUNTING. By F. H. Baugh. P. 199. Index. F. H. Baugh, Baltimore. For sale by MINING AND SCIENTIFIC PRESS. Price, \$3.

There is a familiar story concerning the man who installed a cost-keeping system in his factory, but who was unable to tell whether or not it helped his business because the entire force had been obliged to suspend business to work on the cost system. With due allowances for exaggeration, it is undoubtedly true that many manufacturers have failed to get the best returns from their plants because cost systems seemed to them nothing but a useless mass of printed form and filing-cases. The author of the present volume has wisely confined himself to an explanation of the principles underlying cost keeping with only enough concrete examples to illustrate these principles, leaving the arrangement of details for a particular factory to the reader. As a further aid to clearness, 'efficiency engineering,' or as the author prefers to call it, 'factory management' is separated from cost-keeping, and the latter subject only is discussed.

RECENT PUBLICATIONS

MINERALS OF OREGON. By Graham John Mitchell. University of Oregon Bulletin. P. 61. Eugene, 1915.

ALPHABETICAL HANDLIST OF NEW ZEALAND TERTIARY MOLLUSCA. By Henry Suter. P. 28. Tables. Government Printer, Wellington, 1915.

GEOGRAPHY OF THE FOX-WINNERAGO VALLEY. By Ray Hughes Whitbeck. Wisconsin Geological and Natural History Survey Bulletin XLII. P. 109. Ill. maps, index. Madison, 1915.

PRELIMINARY REVIEW AND ESTIMATE OF MINERAL PRODUCTION OF BRITISH COLUMBIA IN 1915. By Wm. Fleet Robertson. Bulletin No. 1, 1916. P. 59. British Columbia Bureau of Mines, Victoria, B. C., 1916.

The total production was \$29,299,561, an increase of \$2,910,739, of which placer gold was \$180,000 more, lead \$115,922, copper, \$3,884,749, and zinc \$1,208,378.

MAGNETIC AND OTHER PROPERTIES OF IRON-SILICON ALLOYS, MELTED IN VACUO. By Trygve D. Yensen. University of Illinois Bulletin No. 83. P. 67. Illustrated. Urbana, 1915.

It is shown that silicon increases the mechanical strength of iron in almost direct proportion to the amount added, until the maximum strength is reached with a silicon content of about 4.5%. The elastic limit of this alloy was shown to be 94,000 lb. per sq. in. and its ultimate strength 105,000 pounds.

U. S. Bureau of Mines, Washington, D. C., 1915.

GASOLINE MINE LOCOMOTIVES. Relation to safety and health. By O. P. Hood and R. H. Kudlich. With a chapter on methods of analyzing exhaust gases by George A. Burrell. Bulletin 74. P. 83. Ill. index.

MINE-VENTILATION STOPPINGS. With especial reference to coal mines in Illinois. By R. Y. Williams. Bulletin 99. P. 80. Ill. index.

SHOT FIRING IN COAL MINES BY ELECTRICITY CONTROLLED FROM OUTSIDE. By H. H. Clark, N. V. Breth, and C. M. Means. Technical Paper 108. P. 36.

HEAT TRANSMISSION THROUGH BOILER TUBES. By Henry Kreisinger and J. E. Barkley. Technical Paper 114. P. 36. Illustrated.

U. S. Geological Survey, Washington, D. C., 1915.

THIRTY-SIXTH ANNUAL REPORT OF THE DIRECTOR, GEORGE OTIS SMITH, OF THE SURVEY FOR THE FISCAL YEAR ENDED JUNE 30, 1915. P. 186. Maps, index.

This publication contains a review of the immense amount of work done by the department, and shows that "it is of great importance to the country."

PRODUCTION OF METALS AND ORES IN 1913 AND 1914. By J. P. Dunlop. P. 11.

A total of 113,579,697 tons of ore was mined in 1914. The metals were valued at \$795,704,240.

ZINC AND CADMIUM IN 1914. General report. By C. E. Siebenthal. P. 56. Chart.

A RECONNAISSANCE OF THE COTTONWOOD-AMERICAN FORK MINING REGION, UTAH. By B. S. Entler and G. F. Loughlin. With notes on history and production by V. C. Heikes. Bulletin 620-I. P. 62. Map.

A timely discussion of a district of great promise. Abstracts will be made at an early date.

NOTES ON THE FINE GOLD OF SNAKE RIVER, IDAHO. By J. M. Hill. Bulletin 620-L. P. 24. Maps and diagram.

THE AZTEC GOLD MINE, BALDY, NEW MEXICO. By Willis T. Lee. Bulletin 620-N. P. 6. Illustrated.

Interesting notes on an old producer recently re-opened.



EDITORIAL



T. A. RICKARD, Editor

HONDURAS passed a new law on February 15; this is intended to check the holding of mining property without working. Forfeiture follows inactivity. Moreover, the amount of territory to be granted for mining purposes is now limited to 200 hectares, or 494 acres; nor will locations be allowed on ground already the site of a town. Finally, a 5% *ad valorem* tax is levied on gold and silver exports, and a specific tax of 10 pesos, or \$3.84, per ton on refinery products and precipitates for export.

ARIZONA holds the first place among the States of the Union as a producer of copper. In 1916 the total output is anticipated, by the Arizona State Bureau of Mines, to reach 268,500 tons, as compared with 207,440 tons in 1915 and 182,600 tons in 1914. The Phelps-Dodge group is credited with 70,000 tons and the Inspiration with 55,000, the latter being the chief factor in the increase to be made by the State as a whole. Arizona produces about one-third of the United States output and one-fifth of the world's supply of copper.

REVIVAL of prospecting may bring clashes with the Forest Service, owing to lack of public knowledge concerning the rules governing mineral exploration on Forest Reserves. We are informed that the Forestry Relations Committee of the American Mining Congress, under the chairmanship of Mr. Carney Hartley, at Denver, is prepared to furnish information on the subject in such a way as to facilitate prospecting and prevent friction with the duly constituted authorities. Write to him if you need information on the subject.

STATISTICS are out of repute in these days, when figures are juggled either to conceal ignorance or to promote a policy. The Department of Commerce is being attacked for issuing a statement that American dye-works are producing coal-tar colors at the rate of 15,000 tons annually, when expert unofficial information shows that only 6500 tons of dye-stuff is now produced in this country. We agree with *American Industries* that the Federal government ought to set a better example of accuracy in these matters.

ONE-CENT postage is again being advocated by the association formed for that purpose at Cleveland. It is hoped to obtain this reduced rate for local delivery at first and extend the concession for all domestic letters later. Fifty-three separate bills for this purpose have been introduced in Congress during the present session. It is stated that the 2-cent rate is just twice more than the cost, and that the Government earns a surplus of

\$75,000,000 per annum on its letter postage. It is claimed by the advocates of 1-cent postage that the Post-Office was not organized to make a profit but to serve the people. Cheap postage is a great stimulant to social and industrial progress.

SILVER rose to 60 $\frac{3}{4}$ on the 24th instant. The demand from India has improved and an increased amount is being absorbed for subsidiary coinage in Europe. In any event, it is a good thing for the Western miner, who wins silver nowadays largely as a by-product. The biggest producer of silver in the United States is the Anaconda Copper Mining Company, which contributes 8,000,000 ounces annually to the mints. Among purely silver mines, the Nipissing, in Canada, yielded 4,610,050 ounces last year and the Canadian Mining Corporation, also at Cobalt, 4,503,000 ounces. The Tonopah Belmont normally produces 3,700,000 ounces per annum, while the total output of Nevada last year was 14,500,000 ounces.

APPARENTLY the scientific commission sent to the Panama Canal has not been able to give a particularly cheerful report on the geologic conditions modifying the stability of that great highway of maritime commerce. The slides that were the cause of the recent block are being removed at the rate of 1,000,000 cubic yards per month, and 9,000,000 yards will have to be dredged, but traffic can be resumed long before this work has been completed. A re-opening is announced for April 15. Sliding of the ground, in the Culebra cut particularly, will continue to give trouble, but to a diminishing degree and not enough to interrupt navigation seriously. A repetition of the recent experience is considered most unlikely. In order to minimize the unfavorable conditions it is necessary to employ every practicable device that will divert the water falling as rain on the sliding ground. This can be done, so the scientific commission suggests, by bordering the slides with vegetation, closing peripheral cracks, draining the threatened areas, establishing open drains in the great slides themselves, and using tunnels or 'adits' for a similar purpose. The structural weakness of the rocks of the Canal Zone is recognized, also the possible effect of earthquakes in starting slides, but it is expected that the remedial measures mentioned, and the relief of pressure by unloading certain areas, will suffice to protect the great water-way. About seven feet of water falls in eight months of the year in the Culebra district. No wonder that it is so difficult to control the underground seepage, for during the rainy season the level of ground-water is practically at the surface, making the country nothing better than

one big mess—All of which recalls the alternate plan for building a canal in Nicaragua.

NO SURPRISE need be felt that President Wilson should have issued a warning against the sinister influences that are seeking to embroil the United States in war with Mexico. During recent weeks the disreputable portion—much the larger—of the daily press has been publishing all kinds of fictitious stories about events in Chihuahua and elsewhere in Mexico; it has indulged in a lot of nonsense and some plain lying about the American expeditionary force, its movements, and its purposes. Undoubtedly there are "persons along the border who are actively engaged in originating rumors of the most sensational sort" and there are others distant from the border who are playing the same game "for the purpose of bringing about intervention in the interest of certain American owners of Mexican properties." The interests of the mining profession, and those of this technical publication, would, we believe, be advanced by an intervention that would ensure law and order in Mexico, but we have no right to jeopardize the political welfare of the United States and the lives of thousands of our fellow citizens in working insidiously to bring about such a climax. We believe that it is inconsistent with the honor of the United States to interfere in Mexican affairs so long as we recognize the Government of that country, except in so far as that Government gives consent. The time may come when the logic of events will compel drastic action; meanwhile it is our duty to support the President and the moderate policy endorsed by Congress.

THOSE who remember the beginning of the business developed by Meyer Guggenheim's seven sons—now reduced to five—and the first organization of the smelting consolidation in 1898, will appreciate the bigness of the operations now conducted by the American Smelting & Refining Company. The report for 1915 just issued exhibits steady growth and a marked recovery from the depression of 1913 and 1914. A total income of \$18,245,731 in 1915 compares with \$12,825,530 in 1914. A net profit of \$13,873,676 last year compares with \$9,889,630 the year before. Metal stocks aggregating \$23,618,862 indicate the hostage to fortune that such an enterprise is compelled to carry. From four to five millions is spent annually on the purchase of new property and the construction of additional plant. In Mexico, of course, the company's operations have been unproductive and unprofitable recently. Despite the gloomy outlook, fresh property has been acquired in that distressful country, and Mr. Daniel Guggenheim, the president, expresses his confidence that such investment ultimately will prove advantageous. During the past year the company constructed a tin smelting and refining plant at Perth Amboy, New Jersey, zinc smelting plants at Salt Lake City, Utah, and Sand Springs, Oklahoma, besides a copper refinery at Tacoma, Washington. With this latest addition to its productive capacity the company will be able to smelt and refine 500,000 tons of

electrolytic copper per annum, which is equal to half the normal copper production of the world.

DEALINGS in metals in Great Britain have been placed under severe embargo by the Government under an Order in Council. According to *The Financial Times*, this prohibition of speculative dealings in copper, lead, spelter, and iron-tin is omitted has received public approval in so far as it affects the gambling in war commodities, but grave doubts are expressed as to the check upon 'hedging' operations on the part of consumers and the transactions based upon metals in ores and concentrates while yet in process of treatment. It is claimed that the abnormal prices for zinc and copper, for instance, are due not to speculative dealings in London, but to 'cornering' tactics in New York. It is asked, how can the British government expect to restrain the quotations for copper and zinc when two-thirds of the production of these metals is controlled in the United States? Concurrently, the *London Mining Journal* lays stress on the fact that the control of spelter was at Frankfurt before the War and at New York since then, and yet the British government has failed to grapple with the problem of a domestic smelting of the Australian output, although urgent representations have been made to that effect. *The Financial Times* expresses the fear that the result of interference with the metal trade will be to centralize European dealings at Rotterdam or Amsterdam, where the Dutch have already got a good grip on the tin market. Indeed, the War is going to have a far-reaching effect on the metal trade.

DISCUSSION is good for the correction of error and the disciplining of prejudice. This week the department of our paper devoted to this purpose is enriched by contributions from a number of well-known professional men. Mr. David Cole, himself a busy metallurgist, compliments Professor Austin by making some interesting corrections in regard to the practice at Anaconda. Mr. J. R. Finlay, recently elected president of the Mining and Metallurgical Society of America, corrects an inaccuracy of our own in regard to the highest price paid for copper. In response to his mention of the economic consequences of the War upon the metal markets, we shall welcome a discussion of the subject, to which we also made reference in these columns in our last issue. The note by Messrs. Grothe & Carter is interesting, and we may take the opportunity of adding that a letter just received corrects the name of the engineer who devised the make-shift stamp-shoe. It should have been Herbert P. Orr. To Mr. K. C. Li, one of the accomplished Chinese mining engineers to whom we appealed for help in persuading the Chinese authorities to modify their mining regulations, we are indebted for a sympathetic treatment of an international difficulty. Undoubtedly our people often make the mistake of introducing a political element into their business and they are much too apt to despise any methods that are not exactly like their own. For instance, as Mr. E. T. McCarthy suggested in the discussion on Chinese mining

regulations before the Institution in London, they overlook the probability that the evasion of the Oriental is not without method, that the intellect of the educated Chinese is of a very high order, and that the imposition of prohibitive regulations may be only a polite method of effecting a deliberate purpose, namely, of blocking the mining enterprise that threatens foreign complications and domestic unrest. Mr. B. Read contributes an eminently sensible letter on share dealings, treating the subject in a manner entirely consonant with our own views, often expressed. His comments are particularly timely just now when share quotations are inclined to soar recklessly. In regard to the metal quotations, concerning which Mr. Joseph Ralph writes, we are unable to reply explicitly. The New York Metal Exchange, mentioned by Mr. Ralph, is not recognized usually in the settlement for metals in ores, because it is not considered to reflect accurately the current dealings in such metals. Usually its quotations go up quicker and come down slower than those quoted by the technical press. We give consumers' prices as ascertained by our own representative, who is in no way connected with any metal-dealing agency. He discusses the peculiar condition of the lead market in this issue. The whole question of metal quotations needs careful examination. The prices are made not by brokers but by dealers, who are themselves speculators. It would be well if one of the engineering societies would take the matter in hand and appoint a committee to investigate.

Mine Accident Insurance

The useful work of the Industrial Accident Commission is in danger of being discredited by an unreasonable and unfair imposition on the mines operating in this State. Under Chapter 176 of the laws of 1913, known as the Workmen's Compensation, Insurance, and Safety Act, a fund was created to furnish insurance against the liabilities arising thereunder. Under Section 36 of this Act it was stated further that the purpose of this State Compensation Insurance fund was to make provision against the expense of defending any suit for damages, but it was also explained that it was "the intent of the legislature that said fund shall ultimately become neither more nor less than self-supporting." In December 1914, after a hearing, the Commission made a rate of 5%, or \$5 per \$100 of monthly pay-roll, for such insurance as is carried by the metal-mining companies operating in California. At that time the insurance companies offered to accept the same risk at 3½%, and owing to this lower rate they secured most of the business being done. We are informed that they are not only now willing to write such insurance at a rate even less than that quoted at the end of 1914, but did so in 1915. When it became evident that the excessive rate demanded by the State defeated its proper purpose, an effort was made successfully to pass a bill in the 1915 session of the Legislature empowering the Insurance Commission, after a public hearing to establish a mini-

imum rate for all companies carrying insurance under the Act. On October 1, without any hearing whatever, so far as can be ascertained by those most interested, the Commission arbitrarily established the rate at 5%, which minimum has since been increased to 5¾%, thereby endeavoring to force the mining industry to pay the State 2½% more than the rate at which perfectly solvent and reliable companies are willing to underwrite insurance, basing their rate of 3¼% on their experience not only in California and not only in 1914 and 1915, but in other States and for a much longer period of time. The question may be asked whether the mining industry should be compelled to tax its pay-roll 2½% in order to support a State institution that aims to maintain an insurance trust arbitrarily and without advantage to the community? The affair constitutes a grave scandal, which bids fair to destroy the good-will and co-operation that seemed assured between the mine operators and the Accident Commission.

American Capital on the Rand

American participation in gold mining on the Rand is presaged by the recent announcement that Lewis & Marks, a South African firm of considerable repute, had enlisted the interest of several financiers in New York, notably the house of Adolph Lewisohn & Sons, in a proposal to engage in the development of properties at the extreme eastern end of the Witwatersrand goldfield. Mr. William W. Mein, formerly manager of the Robinson mine, has gone to Johannesburg to make an investigation. This, of course, is an interesting event, but it will not be the first occasion on which American capital has participated, for we know that a few well-informed speculators have bought sundry blocks of Rand shares during recent years, notably in the Modderfontein, Brakpan, and other splendid mines in that part of the goldfield to which chief attention has been directed of late. Some of these big mines, such as the Modderfontein group, afford a kind of security unusual in mining. They are well explored and so systematically developed as to give ample assurance of an enormous tonnage of ore having a gold content that has been determined by careful sampling, and capable of being exploited at a cost the exact amount of which can be stated with unusual accuracy. This kind of property is as nearly an investment as a gold mine can be. That does not mean that there may not be an error in the estimate of either the yield or the cost over a long period of years, but the chances for such error have been reduced to a minimum. In short, it is the least risky kind of mining. The factors of uncertainty are labor troubles, fire underground or above, and caving of the workings, all of which are contingencies inseparable from this form of industry—and others also. And then there is one more source of danger to the shareholder who really 'invests' his money in a high-class South African mine, and that is consolidation of the sort that swamped the East Rand Proprietary and Crown Mines, whereby rich ground was

agglomerated with poor ground in order to enable the holders of the latter to get rid of a white elephant and make an advantageous deal. The later history of the Rand can furnish several instances of such abuse of public confidence by financial houses in this way, indeed it is not too much to say that most of the big consolidations were hatched in *verrukerij*, as the Boers call it. However, the more we remember the less we forget, as Kipling says, and if past experience is not too lightly disregarded, it will be difficult to repeat the trick. Making a discount for this contingency and for other possible mishaps, we can still say that the use of capital in such mines is highly attractive. It is possible that the incidence of the War may enable the American financier to participate on favorable terms. The new departure appears to be in excellent hands. We await the sequel with keen interest.

The Qualities of an Engineer

We have received a post-card from the Carnegie Foundation for the Advancement of Teaching requesting us to indicate the relative importance we assign to groups of qualities, which, it is stated, were mentioned in the course of the replies given a year ago to a similar circularization on engineering education. The qualities are grouped as follows:

CHARACTER, integrity, responsibility, resourcefulness, initiative.
 JUDGMENT, common sense, scientific attitude, perspective.
 EFFICIENCY, thoroughness, accuracy, industry.
 UNDERSTANDING OF MEN, executive ability.
 KNOWLEDGE of the fundamentals of engineering science.
 TECHNIQUE of practice and of business.

Partly because we find ourselves unable to answer off-hand and partly because the subject is one of general interest, we propose to discuss the matter with our readers. They will agree that it is worth while to ascertain what are the qualities and aptitudes in demand "in sizing up young men for employment or promotion," as the post-card says. But here we part company with the worthy gentlemen who have formulated the enquiry, for many of the qualities enumerated by them are not required of young men, nor are they associated in their mental equipment in any such way as appears to be suggested. We do not know what is meant by "young men" in this context. To a man of 70 his junior of 50 seems young; to the youth of 25 the latter is old. The inquiry may refer to men just graduated from college or it may mean all those who occupy subordinate positions, as is hinted by the word "promotion." Most of us have known one or two men who at 30 years of age exhibited a precocity of powers that was as admirable as it was abnormal. Such are not typical and the appraisal of them cannot be covered by a post-card. In short, the gentlemen who posted that disturbing missile should start their campaign of enlightenment with a few definitions. That applies to the qualities that they have grouped. Either they give certain words an unusual

significance or they have linked qualities that have no close connection with each other. Judgment and perspective are the product of experience; so are understanding of men and executive ability. These qualities may be latent, but they are rarely apparent until a man matures. Nor need executive ability be found in him who understands his fellow men; the latter calls for sympathy, the former for decision. If character is to be identified with integrity, certainly it need not be allied with initiative. A criminal may have initiative *ad libitum*. Apparently character means honor and honesty on the post-card. To us character stands for reliability. One can predicate how a man of character will act under given conditions; a man lacking character is entirely undependable. Common sense and perspective are not related; a man with plenty of common sense may see no farther than his mental foreground, while he with the larger view might yet be impractical in small matters. In short, the best way to begin a discussion, or an enquiry, is by defining the terms to be used.

However, let us disregard these obscurities and proceed to give attention to the obvious purport of the enquiry. If a young man, say 25 years of age, were to come to us for employment on the staff of a mine or smelter, we should look for intelligence, the desire to learn, a willingness to assist, and loyalty. Thoroughness and accuracy would be in the sequel. As the young man became older and gained in experience, we should look for signs of rarer qualities, such as initiative, judgment, and executive ability. Of course, "the knowledge of the fundamentals of engineering science" must be assumed, as we are supposed to be dealing with young "engineers." We do not understand why the post-card gentlemen should place this kind of knowledge fifth among the qualifications for "engineering success," nor why the last group should be subordinated. For the rest, the manifold work of life calls for diverse qualities; for instance, the two representatives of the American Institute of Mining Engineers included in this Committee on Engineering Education illustrate a typical difference of useful qualities. One of them is a professor, distinguished by scientific insight into the essential principles governing the metallurgy of iron and steel; the other is a mine promoter, endowed with a remarkable understanding of men and their ways. These two have little in common save continuity of purpose and the fact that each started with a "knowledge of the fundamentals of engineering science." In no occupation is there greater scope for many qualities than in mining, and the business related thereto, but success appears to depend upon the power to develop the particular qualities required for the special work each man undertakes—not from choice, it may be. Continuity of purpose counts enormously. The man who "keeps his eye on the ball" is apt to make the strokes that win. A good 'follow through' is essential. The ability to keep one's head in a moment of unaccustomed success or unexpected failure is another factor that makes for ultimate effectiveness. But most of all continuity of purpose, assisted by good health, and luck.



DISCUSSION

Our readers are invited to use this department for the discussion of technical and other matters pertaining to mining and metallurgy. The Editor welcomes the expression of views contrary to his own, believing that careful criticism is more valuable than casual compliment.

The Washoe Reduction Works

The Editor:

Sir—In reading Professor Austin's last article describing the present practice in the coarse concentration and flotation plant of the Washoe reduction works, I note some inadvertent errors of statement which I think should be currently corrected:

In his description of the initial process the author leaves the impression with his readers that Hancock jigs are still extensively used in the rehabilitated mill, which is not the case. Professor Austin's written description evidently refers to, and is accurate for, Section No. 1. This section was remodeled in accordance with the Great Falls flow-sheet before flotation had been considered in any way by the Anaconda engineers. In this section Hancock jigs were installed and are still used, but the other seven sections remain practically unaltered down to the point where hydraulic desliming by the Anaconda type classifier is introduced.

The flow-sheet by Mr. Wiggin that accompanies the article accurately portrays the various steps in the process used in the seven sections that were remodeled after flotation had routed the forces of the old order of things, for Anaconda engineers immediately recognized that with flotation on guard many simplifications of process were possible. For this reason, multiple-stage crushing, elaborate hydraulic classification, and complicated methods of concentration went out of style suddenly at Anaconda as elsewhere within the very large field so quickly dominated by what you have pleased to name "the new metallurgy." What happens above the final grinding stage does not matter as long as the insolubles in the concentrate removed are kept within the proper limits, and this meant that the fine points of difference between types of jigs, hydraulic classifiers, and their flow-sheets, which had occupied the stage so long, were of minor, if any, importance. The old equipment of coarse and medium jigs was well adapted for the purpose of impoverishing the ore preparatory to final re-treatment by flotation.

In the last paragraph of the article referred to, the author states that the concentrate as dewatered by the Oliver filter is sent to the smelter carrying but 10% of moisture. By reference to the flow-sheet it will be noted that the moisture is given at 18%, which is more nearly correct.

As the ease now stands flotation concentrate may be dewatered in Dorr thickeners to a product that will carry an extreme working minimum of 25% moisture. With

this percentage of moisture the product will be fluid enough to be handled in launders with a grade of not less than 1 inch per foot and may be readily pumped when necessary.

Mr. Oliver's drum type of vacuum-filter seems to be the best method we have for reducing the moisture, but the degree of success as expressed in the difference between 25 and 18% seems to be relatively poor. It often costs more money to install the apparatus necessary to remove the moisture from flotation concentrates than it does to provide the frothing apparatus needed to produce them, and a great deal more room is required for these auxiliaries than is needed for the frothing machines themselves. There is a crying need for improvement in the end processes auxiliary to the new art. If the inventors who are trying to perfect "different" frothing machines would turn their attention to defrothing and dewatering machines, there would be less competition and more chance for success.

DAVID COLE.

El Paso, Texas, March 8.

Small Machinery

The Editor:

Sir—In your issue of January 29 appears a letter from Mr. Edgar Hall, writing from Queensland on this subject. That letter is very much to the point and describes just my experience. For years I have tried to make mine-machinery manufacturers see the importance of producing small units for small mines. New mines, as a rule, are not next to trunk lines, nor do millionaires discover or open prospects. In such countries as this, so rich in mineral wealth, but poor in cash, population and transportation facilities, it is still more important to have small units of machinery.

The use of machinery in this country is very limited, not from ignorance, for 90% of the miners know of its existence and would willingly install up to their capacity, which averages 5 to 25 tons per day, but reliable manufacturers do not produce complete units for such small fry. Complete practical small units would have a big sale in all these backwoods regions. By complete unit I mean power, transmission, rock-breaker, stamp-mill or other grinding outfit, concentrator, jigs, flotation, etc., any combination to reduce the weight of the mineral to be shipped from the mine. If any of the mine and mill supply firms would unite the best machinery manufactured into complete small units and undertake to supply these in a compact and light form, I have no

doubt whatever that in a few months many such would be sold—even during the War.

Lima, Peru, March 1

R. F. LAURE

These opinions of mining machinery buyers in criticism of the manufacturers and selling agencies are interesting. We hope others will contribute. Editor.

Appraisal of Mining Stock

The Editor:

Sir—Although no sharp line can be drawn between speculation and investment, the speculator generally buys in anticipation of the enhancement of the value of his stock, thereby making his profit, while the investor is content with the dividends alone. Even when buying as an investor, an element of speculation is always involved by reason of the periods of financial prosperity and depression that are usually reflected in the price of stocks. In one year the price may vary over a margin far exceeding the amount of the annual dividend. During periods of depression the stocks are sometimes quoted at a price that does not even reflect the amount spent on development and equipment, let alone the value of the property itself.

But whether or not the trading is due to speculation or investment, there seems to be a tendency on the part of the public to over-value all stocks in general, and mining stocks in particular. It is doubtful if any appraisal is made, as it is improbable that the average investor has sufficient knowledge of the subject of mine valuation to make a proper appraisal even though data were at hand. Usually the data consist of periodic reports of operating companies. Some companies issue reports that are models of what such reports should be, while others are lacking in the necessary information.

The valuation of mining property presents unusual difficulties, as the risks to which the revenue is subjected and the peculiar character of the property itself, necessitate the introduction of certain principles not common to the valuation of other properties. The stock quotation in itself is not sufficient for an appraisal. In addition, the amount of the annual dividend must be known and the life of the mine at least approximated. Many times the purchaser endeavors to justify the high price of the stock by the high rate of annual dividend or the long life of the investment. In reality, long life adds little to the present value and the rate of the annual dividend may be real or apparent depending on whether or not the market value or the par value of the stock is used as a basis of appraisal. The purchaser must take into consideration the fact that, in buying stocks in the open market, he must pay the price as listed on the stock exchange, regardless of the par value.

In mining, unlike many other kinds of investment, provision must be made for the return of the capital invested. As a result, some confusion exists owing to the introduction of more than one rate of interest. There are two distinct directions in which interest must be computed, namely: the internal influence of interest on the

redemption of the capital, and the rate of return on the investment after providing for redemption of capital.

If, at the present rate of production, the life of a mine is estimated at 10 years, the rate of the annual dividend must be 18.3% in order to pay 10% on the investment and redeem the capital at 4%, because 45.4% of the annual dividend must be placed in the sinking-fund for the redemption of the capital. If, however, the life of the mine is prolonged to 20 years, the rate of the annual dividend need be only 13.4% while 25% of the annual dividend returns the capital at the end of that period.

Just what rate of interest to demand in a mining investment is the crucial question. The rate must take into consideration the nature of the investment with a return commensurate with the risk. With many sound investments offering 5 and 6% at almost no risk, the mining investor is certainly entitled to a more remunerative rate. In the case of a prospect or a small mine in the early stage of production, where the value is wholly prospective, the rate on the investment must be extremely high in order to justify the price. In producing mines where many of the speculative factors have been eliminated by a well established production, the return on the capital invested can be fairly well defined. The cumulative rate of interest, that is, interest on the sinking fund, is fairly well established by savings-banks at about 4% per annum. Well secured stocks and bonds are not available for sinking-fund purposes because the value of a sinking fund lies in the periodic additions to the amounts previously deposited.

The introduction of interest refinements in any appraisal depends much on the nature of the investment under consideration. The value of these factors lies in their assistance in determining the number of years of life required to yield a given interest on the capital invested, and in addition, furnish annual installments, which, if re-invested in a sinking fund, will redeem the original capital at the end of that period.

A stock with a par value of \$2 paying an annual dividend of \$1, is listed on the stock exchange at \$4. The rate of the annual dividend is 25% on the market value and 50% on the par value. In order to pay 10% on the investment and also to furnish annual installments that, re-invested in a sinking fund at 4% will redeem the original capital at the end of the period, requires a life of 6 years. If the stock is quoted at \$8, the life required is 24 years. In other words, if the present value is doubled, the life must be quadrupled in order to justify the price if the amount of dividend remains the same.

A long life adds little to the present value and, at the same time, the redemption factor ceases to be of importance. Increase the life of the above annual dividend to 30 years, and the present value is then \$8.49, while a further increase of 10 years increases the value but 56c., a total of \$9.05. If, however, with the assurance of 40 years of life, 7% is deemed sufficient return on the capital invested, then the present value is \$12.42, and the amount that must be added annually to the sinking fund for the redemption of the capital is but 13c., or

13% of the annual dividend. Decrease the life to 10 years, then the present value on a 7% remunerative and a 4% cumulative basis is \$6.52 with a 54c. contribution to the sinking fund. As the life increases, the amount that must be annually added to the sinking fund rapidly decreases in accordance with the operation of compound interest. In 10 years, 8.3c. is required to redeem \$1 at 4%, 30 years requires 1.8c. while 40 years needs an annual contribution of only 1c. On a 5% accumulative basis, 10 years requires 7.9c., while 40 years reduces the amount to 0.8c.

Although long life adds little to the present value, this present value is very much of a factor in modifying the remunerative and cumulative rates of interest used as a basis of appraisal. A 20-year annual dividend of \$1 with interest on the investment at 10% and a redemption of the capital at 4%, has a present value of \$7.49. On a 7% remunerative and a 4% cumulative basis, the present value is \$9.65.

The value of any stock is based upon its present and prospective capacity to yield dividends, although all stocks are not equally valuable. This discrimination is the essence of any valuation and involves economic considerations of the greatest importance.

B. READ.

Natoma, Cal., February 8.

Metal Prices

The Editor:

Sir—I note your editorial in the copy of March 11, in which you state that copper is at the highest price since 1873. I think you are a little inaccurate in this, due probably to a conclusion brought about by the depreciated United States currency in war times. Dr. Douglas called my attention to that some years ago and I have recently looked it up. I find that the London price for 'tough' copper (I don't know exactly what that means), in January and February, 1864, was £113 per ton, corresponding to about 24½ cents in American money, per pound. In 1873 the same brand was quoted in London at a high price of £97, corresponding to a little less than 21 cents per pound. Thus you will see that the price of 55 cents, which you mention as having occurred in 1864, is plainly due to depreciation of the currency in which it was quoted.

To the best of my knowledge and belief, copper and lead are both at the highest price since the Napoleonic wars. In fact, it is doubtful whether lead is not at a higher price than it ever sold for before in London; the highest that I find for it being £35 15s. in 1806. Copper, however, was considerably higher during the Napoleonic wars than it is now, although it started from a higher level before those wars. For instance, in 1790 it was quoted at £86 per ton and reached a maximum of £198 per ton during the latter part of 1805 and the early part of 1806. The average price in London on this occasion in 1913 was about £69½ for standard copper, say, £72 for electrolytic. Thus, while this present price of electrolytic copper in London, which is supposed to be

about £136 plus freight from New York, is the highest since that time, it is not so high either actually or relatively to former prices as it was during the Napoleonic period.

The question of the stimulation of prices by great wars is an interesting one, and while I understand that your policy is not to say anything about the War from a political standpoint, I suggest that the subject is worth discussion from an economic standpoint and I would be glad if you would publish this letter.

J. R. FINLAY.

New York, March 16.

Improved Stamp-Shoes

The Editor:

Sir—During a period when it was impossible to import steel shoes and dies for stamp-batteries owing to lack of communication, Mr. Hubard P. Orr, mechanical engineer in charge of the shops and foundry of one of the large mining companies here, successfully tided over the shortage of shoes by means which it seems to us are worthy of record.

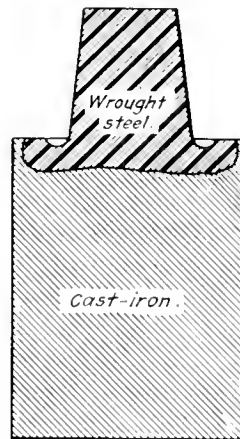

The necks of worn-out shoes, after being thoroughly cleaned on the face, were put into sand, the surface liberally sprinkled with borax and hard iron poured centrally into the mould formed by a pattern of the shoe, the result being complete fusion of the iron to the steel neck.

See sketch enclosed. These shoes are running at present without showing any sign of weakness.

This may have been done elsewhere, but had not been heard of here and no less credit belongs to Mr. Orr.

GROTHE & CARTER.

Mexico City, March 2.

Chinese Mining Regulations

The Editor:

Sir—Your editorial on this subject in your issue of March 4, affords me an opportunity of passing a few words of comment.

I quite agree, in a broad way, that the obnoxious regulations imposed upon mining capital in China were, and still are, very detrimental to the development of our national resources and the tremendous possibilities associated with it. Foreign capital certainly has so far avoided Chinese mining, or has only approached it in almost negligible quantity, but notwithstanding this, those few who did venture have, I think it safe to assert, received a handsome return on their capital.

That the mining laws do require a careful and thorough sifting by a capable board is my considered judgment. An ideal board to take charge of the revision of the regulations should, I think, be composed of four kinds

of members—Chinese mine owners, experienced mining engineers, legislators familiar with mining laws, and persons familiar with Chinese mining customs. Such a board, if in earnest, would be possessed of everything necessary to accomplish the desired object, and fill in the gaps which are so conspicuous in the existing regulations.

As a mining engineer myself, I feel that the sooner the Chinese authorities become apprehensive of the beneficial effect it would have on our country and the sooner they do away with the present easy-going individuals who head some of the wealthiest institutions, the sooner will the dawn of a new era descend upon us and bring with it prosperity and wealth to the Chinese merchants, as well as to the Chinese workmen.

If I am not intruding too much on your valuable space, perhaps I might add that my advice to foreigners who go into China for the purpose of investing in Chinese mines would be to debar themselves completely from the idea of introducing a political element into their business, for any purpose whatever. The Chinese business-man is not a politician, he dislikes the game intensely, but at the same time, like any other man, he favors not the foreigner who tries to become master in his Chinese home. I do believe that some good is bound to come as a result of your persistent soundings and your appeal to the youthful and educated Chinese students, who have distinguished themselves in the American and European universities to assist in the rejuvenating of China. This appeal should deeply resound in the hearts of every one of them. In conclusion, I would add that my only desire is that the echo should be carried deep into the ears of those in whose hands the destiny of our country lies.

K. C. LI.

Secretary Hunan Mining Board.

New York, March 16.

Metal Quotations

The Editor:

Sir—Will you be good enough to explain the existing differences between copper prices as stated in the daily press and those quoted in the trade journals. As yet the highest weekly average for electrolytic has been 27.25c.; for example, in the week ending February 23, and the average for the month of February, 26.62; yet the Associated Press has been consistently advising a figure of about 28.50 for the past several weeks. This matter has become so monotonously misleading that I asked for explanation from the editor of the *Salt Lake Tribune*; in reply to which I was informed that the Associated Press simply advise the actual market conditions on the New York Metal Exchange and reflect existing conditions. Approximately there is a difference at the present time of 2c. per pound on electrolytic as between the advices daily given by the Associated Press and what is reported in the trade and professional journals. What I would like to know is: When the Associated Press advises that the metal exchange quotes copper as "Steady; electrolytic, near by, 28.00 to

28.50," as is the case this morning, can a person buy at a less figure or not? If the metal can be bought for approximately 2c. per pound less than this purported market price—and it evidently can be so purchased, and is—then where is the basis for the fictitious 28 or 28.50? And that the term 'fictitious' is not an exaggerated one any seller of crude copper ore can readily ascertain for himself by the simple process of making shipments.

This difference has not always existed in such a marked manner; and although the two authorities have rarely been in exact alignment with each other, yet when copper was in the neighborhood of 15c. the difference would be only about 25% of what is the case now that a 'daily quotation' of 28.5c. is in evidence. I have before me as I write a settlement sheet with electrolytic at 17.28, when the previous week's average was about 17.60; another settlement quoting 15.85 with a previous week's average of 16.50; and away down the list the greatest difference is about 0.85 of a cent. But now we have persistent 2c. differences.

JOSEPH RALPH.

Salt Lake City, March 16.

Alunite in Utah

The Editor:

Sir—In editing my article on 'Mining in Utah,' which appeared in your issue of March 18, you have made me say that "the recent investigations of the newer discoveries of alunite at Marysvale resulted in the conclusion that they were not of commercial value," when what I did say was that "the recent investigations of the newer discoveries of alunite at Marysvale and in Beaver county, resulted in the conclusion that the Beaver County deposits were not of commercial value." I trust you will make the correction that a wrong may not be done the owners of new alunite discoveries in the Marysvale district.

L. O. HOWARD.

Salt Lake City, March 21.

[Marysvale is in Piute county and close to Beaver county; hence the confusion.—EDITOR.]

COBALT'S silver production in 1915 was 23,730,839 oz., worth \$11,742,463. Nine companies there produced over 1,000,000 oz. during the year. The Mining Corporation ranked next to Nipissing, with an output of 2,776,589 oz. from the Townsite mine and 1,566,206 oz. from Cobalt Lake, Seneca-Superior, which only recently took a place as a successful producer, ranked fourth or next to the Kerr Lake company. Temiskaming's output was 1,486,400 oz. exceeding La Rose or McKinley-Darragh-Savage. Dividends from the Cobalt mines for 1915 amounted to \$4,441,948, making a total return to shareholders of \$59,660,912.

NICKEL-COPPER ore raised in Canada in 1915 was 1,325,973 tons. The Canadian Copper Co. smelted 865,169 tons and the Mond Nickel Co. 407,144 tons.

The Flotation Process—III: Patents

By T. A. Rickard

THIS is the part of the subject of which we have heard the most; indeed, until recently the literature of the flotation process was closely identified with the records of patent litigation. That is why the scientific principles are as yet so little understood and the technology of the process has made such scanty progress. The aim of a patent specification is to disclose just enough to prove originality. In many cases this has been done to the apparent satisfaction of the Examiner of Patents without conveying all the facts essential to a clear understanding of the operations involved. The description given in a modern patent is cryptic; it is couched in a quasi-legal jargon that assists obfuscation. I refer to processes only, for the disputes over flotation patents have arisen over methods, not machines. The apparatus required had already been used in other branches of wet metallurgy, so that we have been spared one source of trouble, at least.

The litigation, which is now a serious obstacle to the free development of the process, has arisen largely from confusion of ideas as to the underlying causes of flotation. The patentees did not understand the phenomena with which they played. Those to whom they sold their patents knew even less. The interpretations of attorneys and judges have elucidated the law but confused the physics. No clear adjudication of rights is possible so long as claims and counter-claims are based on an ignorance of the rationale of the process.

As the flotation process of today is essentially that of making a mineral-buoying froth in modified water, it is not necessary for me to make further reference to the patents granted for the use of purely surface-tension effects. It would seem permissible also to omit further consideration of the bulk-oil methods, but, as a matter of fact, none of these operated without the aid of air, although the patentees were quite unaware of it, and it was from these bulk-oil methods that the frothing process was developed fortuitously.

The first patent for the use of oily substances and coal-tar products in the concentration of ores was that granted to William Haynes, an Englishman, in 1860; but this is now only of academic interest. Next comes the patent of Carrie J. Everson, dated August 24, 1886, the application having been filed on August 29, 1885.¹ The Everson patent refers to the selective action of oil for "metallic substances" and the increase caused in that selectiveness by the addition of acid. The pulp is stirred so as to bring "the mineral" in contact with the oil and acid,

producing a "stiff mass." The use of "about a barrel of oil to the ton of ore" is mentioned, indicating a ratio of about 17%. Other statements indicate that she used as little as 5% of oil per ton of ore. The separation of the oiled mineral from the unoled gangue is described thus: "In practice, the concentrate, after thorough agitation of the mass and detachment of the sand, will in

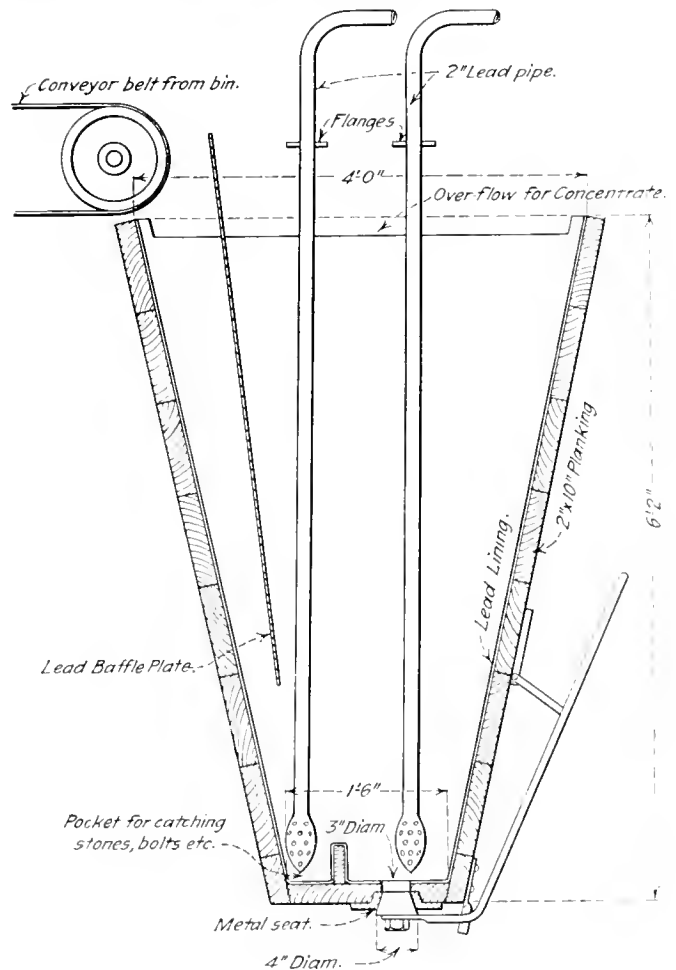

FIG. 10. THE POTTER APPARATUS.

this case be preferably removed by means of a constant overflow of water from a washing-out vessel, by which overflow the concentrate will be floated off." These last words constitute the only direct reference to the floating of the concentrate.

A great deal more has been read into this patent than could ever have been in the mind of the patentee. It is difficult to read her description without cocking one eye at the present practice of flotation, whereby some of Mrs. Everson's phrasing is given a significance to which it had no possible claim 30 years ago. The proportion of oil used, even the maximum, would not suffice for the

^{*}Part of a paper under the same title read before the March 1916 meeting of the Canadian Mining Institute.

¹The date of application is the more important, as being the one from which priority of invention is measured.

operation she had in mind, namely, the floating of the heavy sulphides by direct aid of the buoyancy of oil. Her maximum proportion of oil represents a mere fraction of the quantity required for this operation. She disclosed no notion of the assistance to be obtained from air, in the form of bubbles, although, of course, this was her principal flotative agent. The process described by her is quite impracticable on a large scale, and it never was operated save in a crude experimental way. Nevertheless the exigencies of patent litigation have caused the opponents of Minerals Separation to idealize both Mrs. Everson and her metallurgical adventure, as they have also created a romantic story of the supposed epoch-making discovery. She is represented as a school-teacher, a Miss Everson, who as the sister of an assayer, washed some greasy ore-sacks and saw the sulphides floating on the contaminated water. Even the idea of agitation was suggested by the activity of her hands in the wash-tub. Therefore "it only required the customary neatness of observation of the Western lady school-teacher to grasp the essential facts of sulphide flotation." This is pretty, but not scientific. The "essential facts" are a bit too slippery to be grasped firmly even today. In thinking acid necessary, she was wrong. It is known now not to be an essential. Even the use of oil as a direct means of buoyancy has receded into the background; if she had understood the rationale of her own operations she would have known that it was not so much the selective adhesion of the oil to the mineral particles that gave her the requisite buoyancy as the greater selectiveness of the air bubbles made by agitation in water modified by the oil. Carrie Jane Everson had no idea of the frothing process. Her methods may have involved bubble-levitation, but she did not know it, and her description would not suggest it to anyone not versed in much later knowledge. The effort to feature this lady as the inventor of the frothing process cannot commend itself to an unprejudiced student of the subject.

It is interesting to add that the "Miss Everson" of the story was really a Mrs. Everson; the wife of a Chicago doctor; she was not a school-teacher; her brother was not an assayer; and there is no reason for regarding the story of the ore-sacks as anything more than the fiction of an irresponsible scribe.² Mrs. Everson died at San Anselmo, California, on November 3, 1914.³

Next comes the British patent of January 8, 1894, granted to George Robson,⁴ an Englishman, who did his experimental work at the same place and on the same ores as the Elmore brothers, at the Glasdir mine, near Dolgelly, in Wales. He disclaimed "the use of acids or salts and also the method of washing away the gangue with water," effecting "the separation of the metallic matter by the mixture of oils alone." He does not specify the quantity of oil, but I am informed that it was in the ratio of 3:1, three tons of oil to one of ore.

This was true bulk oil flotation and it proved an abject failure.

Then came Francis Edward Elmore, on April 10, 1899, duplicating his British patent of October 18, 1898. His method has been described already. It only remains to say that in so far as this method proved more practicable than that of Robson, the result was due to the fact that the Elmore brothers were capable engineers and therefore designed a more suitable plant. The patent ignored the use of air; the intention was not to emulsify the oil and not to aerate the pulp, but this theoretical condition was never fulfilled, as is clear from the fact that the flotative action was 150% more than that calculable from the difference of specific gravity between the oil and the water. On January 3, 1903, A. Stanley Elmore took out a British patent for an apparatus for excluding the air during the operation. He effected his purpose by sealing all the open vessels with a ring or surface of oil; from which it is evident that at that time he and his brother endeavored to base their method wholly on bulk-oil flotation.

In January 1902, Charles V. Potter, an Australian, obtained a British patent for the flotation of sulphides in a hot acid solution. He used a stirrer, and he claimed that the solution would "react on the soluble sulphides present to form bubbles of sulphuretted hydrogen on the ore particles and thereby raise them to the surface."⁵

In November of the same year, 1902, Guillaume D. Delprat, the manager of the Broken Hill Proprietary mine, applied for a similar patent, except that he used salt-cake instead of sulphuric acid. Litigation ensued, followed by a compromise, eliminating Potter. In later patents both Potter and Delprat introduced the use of oil, finding it beneficial.

In his first American patent, No. 735,071, filed on January 2, 1903, Delprat states that the process "depends upon the ore particles being attacked by the acid to form a gas. Each ore particle so attacked will have a bubble or bubbles of gas adhering to it, by means of which it will be floated and can be skimmed or floated off the solution." ("Ore particles" means blende and galena at Broken Hill.) Here is a pretty good recognition of bubble-levitation, only he supposed the sulphides, not the gangue, to be attacked by the acid. In another place he says specifically: "The sulphides in the ore are rapidly attacked by the acid and gas-bubbles formed on them, that quickly carry them to the surface." In this patent he claimed the use of nitric acid and a suitable nitrate, such as sodium nitrate, the latter being intended "to increase the specific gravity of the bath." What reaction was to follow between the sulphides and the dilute nitric acid is not clear. It has been recorded⁶ that in the early days of the Potter-Delprat methods it was supposed that the acid liberated hydrogen sulphide from the sulphides, when sulphuric acid was used, without attacking the gangue. Those who first scouted this idea sug-

²"Concentrating Ores by Flotation," Page 5.

³In the *Financial Times*, March 3, 1902.

⁴"The Everson Myth," M. & S. P., Jan. 15, 1916.

⁵His American patent is dated Jan. 19, 1897.

⁶U. S. patent No. 776,145. Claim 3.

⁷"The Physics of Ore Flotation," By J. Swinburne and G. Rudolf. M. & S. P., Feb. 24, 1906.

gested that carbon dioxide was generated by decomposition of a carbonate coating on the sulphides, due to weathering of the ore, arguing therefrom that it was necessary for the gas to be produced at the surface of the sulphide particles themselves. All of these explanations are now on the scrap-heap of discarded theories.

These patents of Potter and Delprat have been labelled variously under 'acid-flotation' and 'surface tension'

No. 763,259.

PATENTED JUNE 21, 1904.

A. E. CATTERMOLE.

CLASSIFICATION OF THE METALLIC CONSTITUENTS OF ORES.

APPLICATION FILED SEPT. 29, 1903

FIG. MODEL.

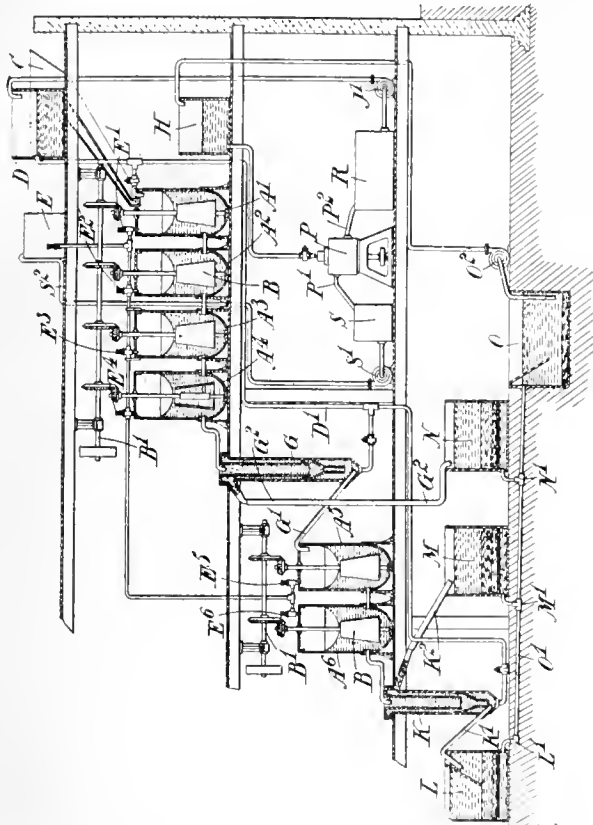

Witnesses:
[Signature]
[Signature]

Inventor:
 Arthur E. Cattermole
[Signature]
 Attorney

FIG. 11. THE CATTERMOLE PATENT.

liberation of carbon-dioxide gas from the gangue, which, at Broken Hill, contains a large proportion of carbonates, notably calcite, siderite, and rhodocrosite. From any of these a hot sulphuric-acid solution would release the gas that promptly attached itself to the metallic surfaces of the galena and blende.

Meanwhile Alcide Froment, in Italy, had got hold of the bubble idea, which is the real basis of the flotation process as it is understood today. He invented his meth-

No. 835,120.

PATENTED NOV. 6, 1906.

H. L. SULMAN, H. F. KIRKPATRICK-PICARD & J. BALLOT.

ORE CONCENTRATION.

APPLICATION FILED MAY 29, 1905

2 SHEETS-SHEET 2

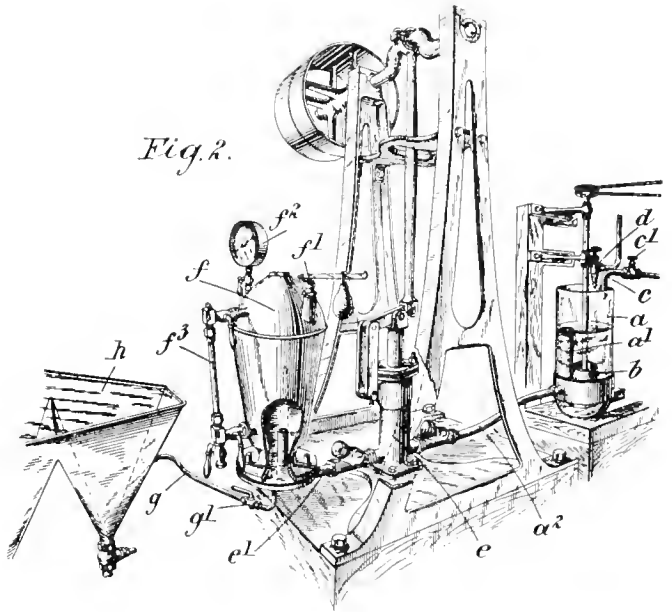

Witnesses:
[Signature]
[Signature]

Inventors
 Henry L. Sulman
 Hugh F. Kirkpatrick-Picard
 John Ballot
 by *[Signature]*
 Attorney

FIG. 12. THE CHIEF MINERALS SEPARATION PATENT.

methods. Delprat's apparatus does indeed suggest a process of the Bradford or Wood type, but, of course, both he and Potter depended for their results on the

In his book Mr. Hoover states (page 13, second edition) that Goyder & Laughton, in their patent of July 31, 1903, "were the first to disclose the principle governing Potter's and Delprat's acid-flotation process, namely, that the action of the acid on the ore generated gas-bubbles to which the sulphide particles attach themselves, and were floated to the surface." What they said was that "the physico-chemical action develops the formation of gas-bubbles adhering to particles of certain of the finely-divided minerals and causing such particles of certain minerals to rise to or near the surface of the solution." But this does not make it clear that the bubbles are obtained by the decomposition of the carbonates in the gangue; it is more nearly compatible with Delprat's idea that they were generated by the action of the acid on the sulphides themselves.

od in 1901 and filed his claim for a British patent on June 9, 1902. This patent was duplicated in Italy, but not in the United States. The fact last mentioned is important. Froment claimed that his process was "a modification of what is known as the oil process of ore concentration," meaning that of Elmore, for the bulk-oil method had been tried at the Traversella mine, in Italy, where Froment was engaged as an engineer. His plan was to generate bubbles of gas by the reaction between sulphuric acid and the carbonates in the gangue, adding limestone when the ore did not contain enough carbonate. He argues that "if a gas of any kind is liberated in the mass, the bubbles of the gas become coated with an envelope of sulphides and thus rise readily to the surface of the liquid where they form a kind of metallic mag-

na." It will be noted that he says "gas of any kind." AS the children say, in a familiar game, he was "very warm" just then, for he had only to invoke the aid of air to have described the essential principle of the later phase of flotation. He also states that the sulphide particles when "moistened by a fatty substance" have a tendency "to unite as spherules and to float upon the surface of the water." His brief description closes with the statement that "the rapidity of the formation of the spherules and their ascension is in direct ratio to the quantity of gas produced in a given time." As to the oil, the only mention of quantity is made in describing a test tube experiment in which he uses "a thin layer of oil." This phrase has been variously interpreted, according to the exigencies of litigation, but it refers obviously to a minute proportion. In the directions given by him to the Minerals Separation people when they bought his patent rights on November 17, 1903, he specified 1% of mineral engine-oil for ore containing up to 5% of metal, 1½% of oil for ore containing 10%, and so on, up to ores containing 50% of metallic lead, which would require 3½% of oil. As oil flotation was understood at that time, this marked a great reduction in the proportion of oil. However, the more interesting point is Froment's failure to perceive the possibility of using air as the gas for making his bubbles. He depended upon chemical action to furnish him with the necessary gas. Nevertheless Froment deserves a high place in the roll of flotation pioneers, for he made an important step forward. He furnished the link between bulk-oil and air-froth flotation.

The next chapter in the story marks a retrogression. Under date of November 28, 1902, Arthur E. Cattermole obtained British patents No. 26,295 and 26,296, both of which were acquired by John Ballot and associates in December 1902, preparatory to the formation of the company—Minerals Separation, Ltd.—organized to exploit them. In August 1903 Cattermole revised and amplified his previous claims in British patent No. 18,589, which was duplicated in the United States under date of September 28, 1903, as No. 777,273. This last is the principal patent covering the so-called granulation process.

Cattermole prefaces his description by reference to the selectiveness of oil, when emulsified, for sulphide particles, such selective action being intensified by the acidulation of the water. He then proceeds to say that if the mixture be thoroughly agitated, there is a tendency for the metalliferous particles, now coated with oil, to adhere together, forming granules* that sink and are readily separated from the lighter gangue by an up-current of water. In his description of the operation he says that "the granules, with a certain amount of heavy sands, sink to the bottom and are discharged (see Fig. 11) through a pipe *G*¹ into the vessel *A*¹, while the lighter sands are carried away by the upward current and discharged through outlet *G*² to a light-sands tank *J*." In the drawing, *A*¹, *A*², *A*³, *A*⁴, *A*⁵, and *A*⁶ are mixing

vessels, *G* and *K* are classifiers, *E* is a tank containing oil emulsion. He refers to the quantity of oil several times in vague terms, explaining, however, that it should be "insufficient to materially lessen the specific gravity of the metalliferous mineral particles." Finally, he specifies the proportion as "usually an amount of oil varying from 1% to 6% of the weight of metalliferous mineral matter present in the ore." This can be interpreted variously; if it refers to the sulphides to be concentrated, then an ore containing 20% blende would require from 0.8 to 1.2% of oil, equivalent to from 16 to 24 lb. oil per ton of ore. On the other hand a 2% chalcocite ore would need only 1.6 to 2.4 lb. of oil per ton of ore, which approaches the proportion now used.

This Cattermole process was the subject of lengthy experiment in the London laboratory of the Minerals Separation company, where all sorts of variations in temperature, acidification, oiling, and mixing were tried by Arthur H. Higgins under directions from H. L. Sulman and H. F. K. Picard. It was not until March 1905, that is, nearly 2½ years subsequent to the patenting of the Cattermole method, that it was found advisable to float the 'granules' rather than sink them, whereupon ensued "the startling discovery of the agitation-froth process" as W. H. Ballantyne has described it. A similar discovery was made contemporaneously at Broken Hill, but there, according to James Hebbard, it was not so "startling;" it was the result of strenuous efforts to make a workable process out of the impracticable method devised by Cattermole. See Fig. 12 and 14.

This 'discovery' led to Minerals Separation's basic patent U. S. No. 835,120, of May 29, 1905, which duplicated the British patent No. 7803 of April 12, 1905, taken out in the names of H. L. Sulman, H. F. K. Picard, and John Ballot. In this patent the aid of chemically-generated gas is discarded definitely, in favor of air-bubbles. This seems to me a matter of far greater importance than the reduction in the proportion of oil. The patentees say: "It is to be understood that the object of using acid in the pulp according to this invention is not to bring about the generation of gas for the purpose of flotation thereby, and the proportion of acid used is insufficient to cause chemical action in the metalliferous minerals present." This differentiates the method from those of Potter, Delprat, Froment, and De Bayay, the addition of acid being therefore presumably to assist the selective oiling of the sulphides. The patentees also state that "a large proportion of the mineral present rises to the surface in the form of a froth or scum which has derived its power of flotation mainly from the inclusion of air-bubbles introduced into the mass by the agitation, such bubbles or air-films adhering only to the mineral particles which are coated with oleic acid." The last clause had better have been omitted, for it is only conjecture, as to the truth of which there is room for plenty of doubt, but the clear description of air as the main agent of flotation is most important—far more important as regards the rationale of the process, than the diminution in the proportion of oil.

As to this, it is stated that if the proportion of oil

*The 'granules' may be contrasted with Froment's 'spherules.'

mentioned in the previous Cattermole patents "be considerably reduced—say to a fraction of 1% on the ore—granulation ceases to take place, and after vigorous agitation there is a tendency for a part of the oil-coated metalliferous matter to rise to the surface of the pulp in the form of a froth or scum." One per cent on the ore is equal to 20 lb. of oil per ton; a 'fraction' of 1% is anything between 20 and 0 pounds per ton. In enforcing the right to the collection of royalties, the Minerals

No. 873,586

PATENTED DEC. 10, 1907

D. H. NORRIS.

APPARATUS FOR SEPARATING THE METALLIC PARTICLES OF ORES FROM THE ROCKY CONSTITUENTS THEREOF.

APPLICATION FILED AUG 7, 1907

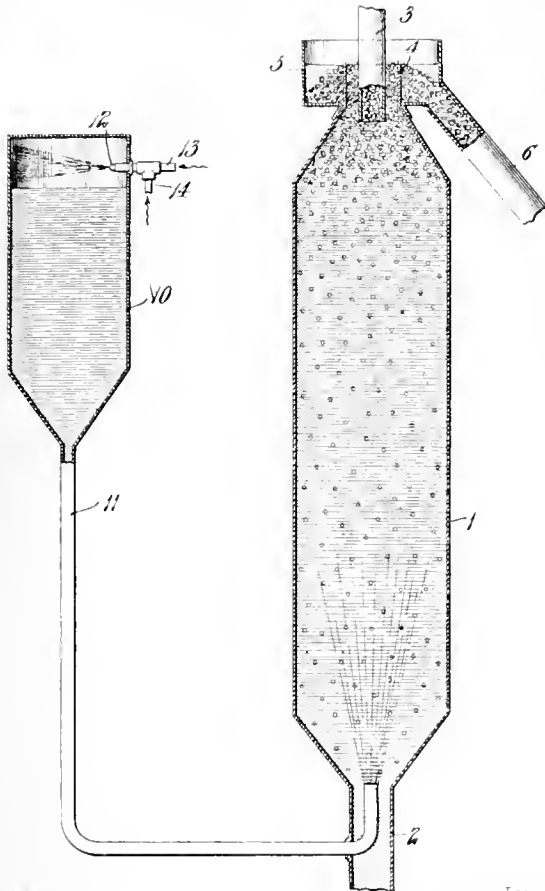

Witnesses:
Geo. R. Redson
Wells L. Chubb

Inventor
Dudley H. Norris.
By Pro. Kewell & Co. Attys

FIG. 13. THE NORRIS PATENT.

Separation company has rested its claim mainly on the reduction of oil, claiming that it produces a series of phenomena quite different from any of the other methods employing larger proportions of oil, and, concurrently, insisting that such superior effects as are produced by the use of the reduced quantity of oil are unobtainable when the larger proportions of oil are used. Thereupon, of course, it has been claimed, by those desiring to ignore the Minerals Separation basic patent, that neither the Cattermole nor the Froment methods demanded a quantity of oil notably larger, for the minima prescribed by these earlier inventors come under 20 lb. of oil per ton of ore. However, this matter is still *sub judice*, so it is best let alone for the present.

Between the Froment patent of 1902 and the Sulman-Picard-Ballot patent of 1905 comes the Kirby patent U. S. No. 809,959 of December 14, 1903, granted on January 16, 1906. This is interesting as specifying gentle agitation and the use of a gas, making it possible to use thin oils instead of the viscous oils of the prior (Elmore) art. The claim is made that "the injection of gas, preferably air, into the mass, assists in the flotation of the hydrocarbon-coated particles." The mention of air, as

T. J. HOOVER.
APPARATUS FOR ORE CONCENTRATION.
APPLICATION FILED MAR. 17, 1909.

953,746.

Patented Apr. 5, 1910.

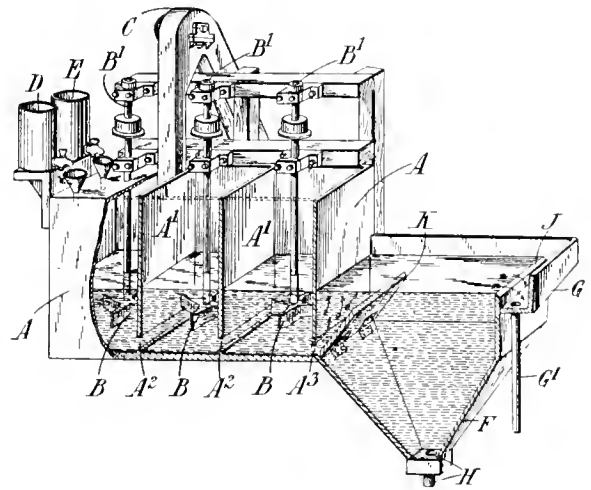

Witnesses:
J. H. Brown
J. W. H. H. H.
J. H. H. H.

Inventor
T. J. Hoover
By Knight & Co. Attys

FIG. 14. THE HOOVER APPARATUS PATENT.

an assistant flotative agent, is more important than the reference to the kind of oil.

The actual part played by the oil has been misapprehended from the very first, the earlier investigators using not enough to produce bulk-oil flotation, while the later metallurgists have employed much more than was needed for bubble-levitation. The relative importance of the part played by air was persistently ignored until a late date and even then it was under-estimated. It is interesting to note that the two first patents in which air was specified as a gas suitable for flotative effects were those of F. E. Elmore and the firm of Sulman & Picard. Francis E. Elmore obtained a British patent for his vacuum-oil method under date of August 16, 1904, and

duplicated it in the United States as No. 826,111 of July 10, 1905. Sulman & Peard obtained a British patent for their perforated coil patent under date of September 22, 1903 duplicating it in the United States as No. 793,808 of October 5, 1903.

The Sulman & Peard patent just mentioned has been claimed by the Miami Copper Company as the one covering their operations with the Callow pneumatic cell. In No. 793,808 the inventors "utilize the power which is possessed by films or bubbles of air or other gas of attaching themselves to solid particles moistened by oil or the like." They also state that they add oil "in quantity in sufficient to raise the oiled mineral by virtue of the flotation power of the oil alone. A suitable gas is generated in or introduced into the mixture, such as air, carbonic acid gas, sulphuretted hydrogen, or the like. For example, bicarbonates or carbonates, either soluble or insoluble in water—preferably the latter—or easily decomposable sulphides and the like may be used with acid solution." Thus they lessen the emphasis on air as the prime agent. The description also refers to the oiled metalliferous particles as "attaching to themselves, with a greater comparative strength than the gangue particles, the films or bubbles of gas which exist in the mass and are thus raised to the surface of the liquor by gaseous flotation." Yet we are told that the metallurgists who prepared this excellent description of the bubble-levitation method made "a startling discovery" of the frothing process eighteen months later. This U. S. patent 793,808 is more than a year junior to Froment's British patent, and contains an echo of it in the introductory announcement.

Elmore's vacuum-oil process marked another inadvertent step toward the recognition of air as the most important flotative agent. He utilizes the air naturally dissolved in water, releasing it for his purpose under a vacuum. The patent states that "under a vacuum or partial vacuum, air or gases dissolved in the milling water are liberated. These liberated gases may be augmented by the generation of gases in the pulp, or by introduction from an external source." Elmore invented a most ingenious machine for his purpose. In so far as he depended upon the air in a pulp that had undergone mixing with a quantity of oil relatively small (as compared with his bulk-oil method) he furnished a notable metallurgic sign-post, but it is necessary to remember that he mixed his crushed ore in acidulated water and that the acid would cause the generation of carbon-dioxide gas, thus explaining his reference to "air or gases."

The first inventor to break away from the use of either acid or oil and to make a clear claim for air as his sole flotative agent is Dudley H. Norris, in U. S. No. 864,856, under date of November 19, 1907, also in No. 873,586, of December 10, 1907. See Fig. 13. In his first patent he described a method for "introducing water containing air in solution into the lower end of an open-ended receptacle into which is introduced a flowing mixture of pul-

verized ore mixed with oil and water, thereby exposing said mixture to the continuous action of infinitesimally small nascent bubbles of air." He does not specify the use of acid and he distinctly says that he does not wish it to be understood that his method "is limited to the use of oil, as the method can be practised successfully without mixing oil with the pulverized ore and water." Incidentally, his method is worthy of friendly interest, for he has declared his intention to render the use of it free of tonnage royalty.

Having got rid of acid and oil, we have now reached the point where modified water mixed with the crushed ore in the presence of air suffices to form bubbles sufficiently lasting to buoy the metallic particles to the surface of the liquid.

Metal Price Increase

The following table shows the great increase, in cents per pound, since the War commenced, according to *The American Metal Market*:

| Metals | Before the War | Now | Increase, per cent |
|------------------------------------|----------------|---------------|--------------------|
| | July 31, 1914 | March 6, 1916 | |
| Lake copper | 13.00 | 27.50 | 111 |
| Electrolytic copper | 12.75 | 27.50 | 116 |
| Casting copper | 12.62½ | 26.12½ | 107 |
| Sheet-copper | 18.50 | 34.00 | 84 |
| Tin | 33.00 | 48.50 | 47 |
| Lead | 3.72½ | 6.60 | 77 |
| Spelter | 4.85 | 19.25 | 297 |
| Aluminum | 17.25 | 63.00 | 265 |
| Antimony | 5.50 | 45.00 | 718 |
| Copper wire | 14.25 | 29.25 | 105 |
| High-sheet brass | 13.87½ | 40.00 | 188 |
| Sheet-zinc | 7.00 | 25.00 | 257 |
| Iron and steel products | | | |
| Bars | 1.15 | 2.25 | 96 |
| Plates | 1.15 | 2.35 | 104 |
| Shapes | 1.15 | 2.25 | 96 |
| Pipe (1 to 3-in.) | 1.95 | 2.55 | 31 |
| Wire (nails) | 1.55 | 2.40 | 55 |
| Sheets (28 gauge) | 1.89 | 2.60 | 44 |
| Tin-plates | 3.30 | 4.00 | 21 |
| Pig-iron (per ton) | | | |
| Bessemer, Valley | \$14.00 | \$20.50 | 46 |
| Basic, Valley | 13.00 | 18.50 | 42 |
| No. 2 foundry, Valley | 13.00 | 18.50 | 42 |
| No. 2 foundry, Philadelphia | 14.25 | 19.75 | 38 |
| No. 2 foundry, Cleveland | 13.75 | 18.80 | 37 |
| No. 2 foundry, Buffalo | 13.00 | 18.25 | 40 |
| No. 2 foundry, Chicago | 14.50 | 19.00 | 31 |
| No. 2 foundry, Southern Cincinnati | 13.25 | 17.90 | 36 |

MINERAL PRODUCTION OF QUEBEC in 1915 was valued at \$10,796,348, against \$11,732,783 in the previous year. The falling-off was mostly in asbestos, which declined from 114,115 tons worth \$3,544,392 to \$2,895,935. Structural materials declined considerably. Chromite increased from \$1210 to \$221,287, the value of 14,076 tons, according to the superintendent of mines, Theo. C. Denis. Copper and sulphur ore rose over \$200,000, and magnesite more than \$135,900.

¹⁰Note the sloping launder-like vessel used by both.

The Mineral Industry of Chile

By Lester W. Strauss

THE revival from the disturbed economic conditions, as the result of the 'Great War,' has had its effects in Chile, whose predominating revenue is due to the export tax on nitrate. This tax amounts to 80% of the total custom duties of the country and approximately

There appears to be another extensive low-grade copper property to be added to the type of deposit exploited at the Braden and Chuquicamata mines, as the result of the exploratory work of the Andes Exploration Co. The property in question, the Potrerillos, is at 13,000 ft. altitude; it is reached from the port of Chañaral, in Atacama, and has been under development for two years by the Anaconda Copper Co. Otherwise no new properties of magnitude have been developed, but several 'possibilities' are under option to American interests.

The nitrate industry, which was hard hit, as a result of the world crisis, at a time when production was attaining proportions commensurate with the most economical results, has made a good recovery from the depression, only to be confronted by a dearth of shipping facilities and excessive freight-rates. The present situation tends toward curtailment of production to prevent an accumulation of stocks, as a further decline of prices would compel the shut-down of many plants and a reversion to conditions that existed when the War broke out, namely, an exodus of labor. In August 1914 an arrangement was effected by the Government to aid producers by advances on the nitrate delivered at the various ports; up to date over 80% of the funds advanced have been returned with interest. On December 31, 1914, only 38 plants were in operation as compared with 127 at the end of 1913, and 115 at the end of 1915. The following figures (in quintals of 46 kilo. = 101.44 lb.) indicate the effect of the War on the industry and the recovery that has been made since August 1914:

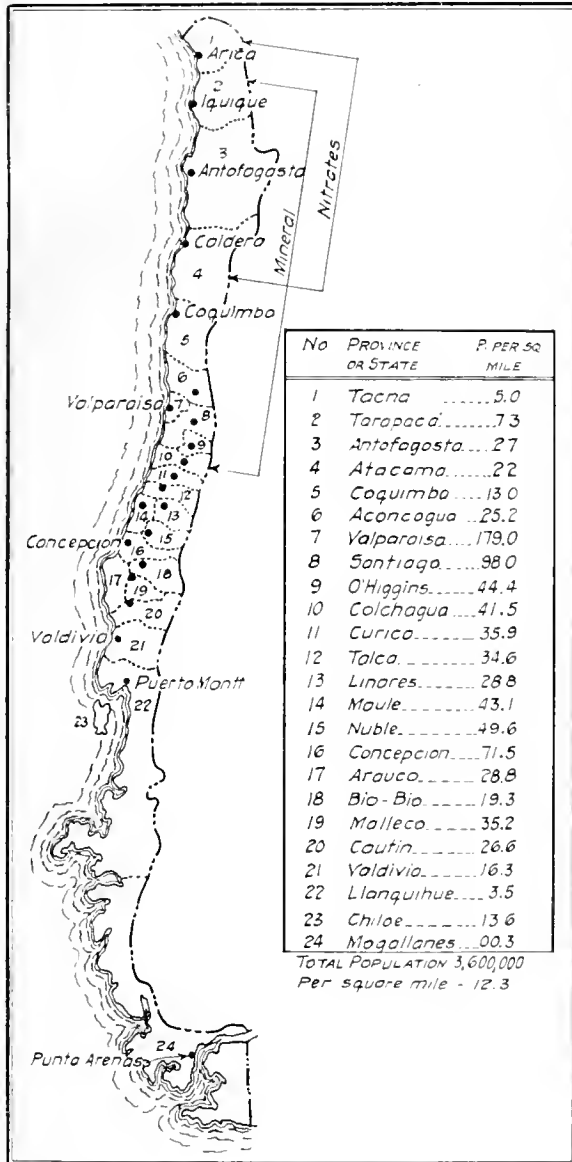

MAP OF CHILE.

The Braden mine is in the province of O'Higgins. The Chuquicamata mine is in the province of Antofagasta.

50% of the total Government income. The notable progress in 1915 has been the increase in production of nitrate and copper, now both handicapped by the scarcity of transport facilities for shipments abroad. The increased output of copper is from the Braden Copper Co., Chile Copper Co., and various local smelters.

| | 1913 | 1914 | 1915 |
|----------------------------|------------|------------|------------|
| Production, Jan.-July | 35,388,811 | 37,862,106 | 15,610,634 |
| Exported, " " | 30,481,463 | 30,538,756 | 22,878,761 |
| Production, Aug.-Dec. | 24,877,584 | 15,649,115 | 22,557,869 |
| Exported, " " | 29,047,647 | 9,611,717 | 21,104,899 |
| Total production | 60,266,395 | 53,511,221 | 38,168,503 |
| " exported | 59,529,110 | 40,150,473 | 43,983,660 |
| Production, December 1915 | | | 5,538,151 |
| Exported, " " | | | 5,174,087 |
| " January 1916 (est.) | | | 6,200,000 |
| Stocks, December 31 (est.) | 10,396,000 | 23,556,000 | 17,039,000 |
| Exported to United States: | | | |
| January-July | 9,398,404 | 8,026,675 | 10,950,930 |
| August-December | 4,314,379 | 3,642,850 | 7,474,941 |

Export, Jan.-Dec. 13,712,783 11,669,525 18,425,871

The United States is the largest purchaser since Germany has been eliminated from the market.

The rising prices of coal and fuel-oil, in particular, as well as other supplies, has resulted in higher operating costs, and the scarcity of shipping has placed the nitrate industry in a trying position. The sudden withdrawal of the Panama Canal as a shorter route, due to the big slides in October, made itself appreciated in the decline of the price of nitrate; numerous ships were tied up at

Colon and Balboa until it was definitely known that no traffic was possible. The loss by demurrage was accentuated by the additional cost in the long trip through the Straits of Magellan. The following figures give some idea of the fluctuations in the price of nitrate (duty paid alongside) per 46 kilo. and freight rates per 2240 lb., in U. S. currency, during the past three years:

| | 1913 | 1914 | 1915 |
|--|--------|--------|--------|
| Price of 25% nitrate, prompt delivery quotation on December 31 | \$1.92 | \$1.38 | \$1.94 |
| Freight rates (steamer carriers) quotations on December 31 | 7.20 | 20.10 | 30.00 |

Beginning in January 1915, the price rose steadily, reaching \$2.28 in October; but the closing of the Panama Canal and the freight famine caused a decline to present prices. Many of the plants are shipping double-refined nitrate above 96% NaNO_3 , which averages 8 cents more per 46 kilo., and affords a slightly higher marginal profit. His Excellency Sr. Luis Sanfuentes, who became President of Chile in December 1915, has taken much interest in arriving at a practical means of lifting the accumulating nitrate stocks. The endeavor to utilize the twenty-odd German steamers—disregarding the sailing vessels—that are lying in various Chilean ports must first meet with some approval from the British and German governments. The latter is doubtless not inclined to sell or risk its merchant ships, which will be needed once peace is attained. Recently Gibbs & Co. (an English firm) bought a small steamer (3000 tons capacity) from the Compañía Sud Americana de Vapores, a Chilean company, the sale of which caused much local discussion. The British government is subsidizing numerous steamers of the Pacific Steam Navigation Co.'s fleet that have been plying on the West Coast, but many of these ships will continue in the service as heretofore.

Through the efforts of Sr. Agustin Edwards, Chilean Minister to England, arrangements are being brought to a successful issue whereby the British government will effect lower freight-rates. This circumstance should reflect in higher prices for nitrate on the Coast. There appears to be a general tendency on the part of the producer not to sell ahead. It behooves the Chilean government to help exportation by reason of the increased revenue from the tax imposed.

The Chilean government has offered two of its transports (total 15,000 tons capacity) as nitrate-carriers to the United States, terms being on a ton-rate. Three bids were made; the bid rendered by Gibbs & Co. has been accepted, being 117.5 shillings (\$28.20) per long ton by the Straits of Magellan, or 102.5-107.5s. (\$24.60 to \$25.80) by the Panama Canal, the charter being granted for two trips, the return cargo to be optional to the Government. The lower rate by the Canal is to a port on the Gulf of Mexico; the higher rate to a port on the Atlantic Coast.

The Dupont Nitrate Co., the one company owned by and operating with capital from the United States, produced about 530,000 quintals of 97% or double-refined nitrate, being the output from their Delaware and Carolina properties; another property was purchased early

in the year. The company is also an extensive buyer of nitrate.

There continues to be considerable Governmental discussion as to effecting an organization that would eliminate the speculative movements in the price of the nitrate, which fluctuations do not benefit the producers but disgust the consumer; this elimination of the middleman will lead to a better appreciation of nitrate through the control of, and steadiness of, the selling prices.

Some experimenting has been done at various plants toward increasing extraction; the Hardinge mill and Butters filter have given encouraging results at one plant. Numerous schemes have been suggested.

Despite the part success in Germany of the production and application of ammonium sulphate (at a probable higher cost than Chilean nitrate), that country will undoubtedly be again in the market, once peace is assured, which is evidenced in the purchasing of nitrate ground by German interests.

The bright spots are in copper and iron mining. The production of copper has probably attained the high mark of 1876 (52,308 metric tons). The iron mines continue to be in the development and construction stage. It is an interesting fact that capital from the United States is responsible for the advances made in the extensive developments of these metals in Chile. The total copper exported from Chile during 1915 as compared with 1914 is given below, also the copper produced during the respective years. These figures cover bar copper, copper matte, and minerals.

| | 1914 | 1915 |
|----------|-------------|-------------|
| | Metric tons | Metric tons |
| Exported | 40,444 | 45,022 |
| Produced | 44,665 | 52,000* |

*Estimated.

The total copper production of Chile from 1811 to 1915, inclusive, has been 2,387,000 tons. The 1915 production places the country as the third in rank of the world's copper producers. It seems likely that operations for 1916 may result in exceeding Japan's production (68,072 tons for 1914) and entry to second place. Nearly 50% of the 1915 production is from properties (Braden and Chile Copper companies) controlled by capital from the United States.

The largest copper producer, as yet, is the Braden Copper Co., being responsible for 30% of the country's total output. The following figures indicate the scale of operations during 1914 and 1915:

| | 1914 | 1915 |
|----------------------|------------|------------|
| | Short tons | Short tons |
| Ore hauled from mine | 894,491 | 1,198,167 |
| Ore milled | 900,299 | 1,195,858 |
| Concentrate produced | 84,783 | 104,847 |
| Concentrate smelted | 87,925 | 102,868 |
| Blister produced | 14,152 | 17,647 |

The adoption of nodulizers in December 1914 to dry the flotation concentrate and reduce the sulphur content (from 28 to 18%) has given excellent results. The concentrate agglomerates into masses up to a foot in diameter. Four nodulizing-kilns will be in use; three capable of handling 215 tons of concentrate, resulting in 180

tons of nodules, per 24 hours are actually in service. The kilns are oil-fired; the gases pass through a dust-chamber and out to a stack. Nodulizing has resulted in better smelting work and lower costs, the latter due to less coke consumption in the blast-furnaces. Some of the concentrate (50 tons per day) is sintered; the sulphur content is reduced from 28 to 12%. Raw concentrate is also smelted, about 85 tons per day.** The acid plant has proved itself a success, but leaching of the concentrate has not been started on anything but an experimental scale. The acid production at present is in excess of requirements for the Minerals Separation process. It has been unofficially stated that the mill will be increased to 6000 tons daily capacity and such improvements effected as to increase the monthly output to 2500 short tons of copper; during the last quarter of 1915 the monthly output was at the rate of 1800 tons of metal.

The operations of the Chile Copper Co. at Chuquicamata began in May and have been undergoing the usual experiences of a new treatment plant operating under novel conditions. Since August the monthly output has been about 1500 short tons of ingot copper. The deposit is stated to contain over 400,000,000 tons of 2% copper ore, which makes it the premier property of the world as regards tonnage of commercial mineral.

All the smelters in the country, with the exception of the Braden plant, are custom plants. These are now increasing their outputs, aided by the high freights on shipments of ore to the United States and England. Freight on bar copper to the United States is \$5 per long ton; minerals pay from \$4 to \$5 per ton, in sacks. Contracts for large tonnage are said to exist at lower figures. There are four active smelters producing bar copper, as follows, in metric tons of fine copper.

| | 1914 | 1915 |
|----------------|------|-------|
| Gatico | 2388 | 3000 |
| Catemu | 3537 | 3500 |
| Nataigua | 2481 | 3500 |
| Lota | 3503 | 3948* |

*Includes purchased matte.

The first and last are situated on the coast (the Lota smelter is close to the coal mines it controls); the other two are inside from Valparaiso. Catemu and Nataigua are planning to smelt with reverberatories, using native coal, probably to be pulverized, in view of the high price of coke.

The most important matte-producing smelters are as follows, the production being given in metric tons of fine copper.

| | 1914 | 1915 |
|-----------------|------|-------|
| Chañaral | 1499 | 2500 |
| Caldera | 3004 | 3400 |
| Carrizal | 969 | 1000* |
| Panucillo | 2482 | 2700 |

*Estimated.

With the exception of Carrizal, the other plants produce matte varying from 46 to 50% copper; Carrizal matte is under 40% copper.

*This and the following data have been extracted from the November issue of the *Teniente Topics*, published by the staff of the Braden Copper Company.

Other smelters exist, but they have been either in intermittent operation or are small producers.

Coke costs 85 to 100 shillings (\$20.40 to \$24) per long ton, aboard ship, as against 35 to 40s. (\$8.40 to \$9.60) in normal times.

Of the smelters mentioned above, the year 1916 will show increased production at the following:

The old Gatico furnace, 140 by 38, has been lengthened to 213 by 38, which, it is stated, will increase the monthly tonnage treated from 3000 to 5000 tons, resulting in an output of 400 metric tons of copper per month; new converter-stands, blowing-engine, and accessory plant have been installed. The mines controlled have been undergoing vigorous development and preparation.

The directors of the Sociedad Industrial de Atacama are planning to convert the matte produced at Caldera, at present about 600 tons per month.

Improvements under consideration are anticipated to raise the individual yearly output at Catemu and Nataigua to 5000 metric tons of copper.

The Guayaean smelter, near Coquimbo, has been idling owing to the re-organization now under way. The smelter of the Compañía Minera de Calama, near Calama, has been operating spasmodically and is now shut down during a period of restoration. There are several properties that treat their mineral in small furnaces and sell the resultant matte to local smelters making bar copper.

The mines that have no smelting plants and formerly shipped their products abroad are hard hit by the high cost of freight, barring the few which have had long-time freight contracts. The less fortunate companies are shipping to local smelters. The principal districts from which ores are being shipped are Tocopilla, Collahuasi, Chuquicamata, Copiapó, and Los Condés.

Silver mining continues to be a declining industry; the famous Huantajaya and Santa Rosa districts near Iquique and the Compañía de Minas de Beneficiadora de Taltal, inside from the port of Taltal, are responsible for more than 65% of the total silver produced exclusive of that contained in blister copper, matte, and mineral exported. Figures for 1915 are not available at present, the following data are of interest:

| | 1913 | 1914 |
|---------------------------------------|-----------|-----------|
| | Oz. | Oz. |
| Total silver of commercial value..... | 940,000 | 882,000 |
| Total silver reported | 1,272,000 | 1,176,000 |

Several properties are under development in the once famous Chañareillos district.

Gold mining is an unimportant industry, in which vein-mining contributes less than placer work.

| | 1913 | 1914 |
|-------------------------------------|--------|--------|
| | Oz. | Oz. |
| Total gold of commercial value..... | 14,540 | 10,670 |
| Total gold reported | 22,340 | 24,000 |

Less than 3% was locked up in copper products. No mills of note are in operation.

Lead mining is of interest because of the gold and silver in the lead ores. In 1913, 74.5 metric tons of lead was exported, as compared with 68.8 tons in 1914. One

ing property produced in a small way, but the War cut off its market, as the sorted product was shipped to Germany. In 1913, 50 metric tons of zinc mineral was ex-

The values of the principal metallic and non metallic minerals produced during 1913 and 1914 are as follows: data for 1915 not available yet:

| | 1913 | | 1914 | |
|---|-----------------|---------------|-----------------|---------------|
| | Quantity | Value | Quantity | Value |
| Gold | 1,116,929 grams | \$275,200 | 1,016,896 grams | \$200,000 |
| Silver | 29,567,564 " | 502,900 | 36,581,082 " | 430,800 |
| Copper | 42,263 tons | 11,413,700 | 44,665 tons | 11,318,900 |
| Iron | 14,100 " | 191,520 | 63,505 " | 157,240 |
| Coal | 1,282,150 " | 8,778,800 | 1,086,946 " | 7,829,000 |
| Nitrate | 2,772,254 " | 114,771,300 | 2,163,356 " | 101,382,940 |
| Iodine | 436,974 kilo. | 1,848,400 | 488,952 kilo | 2,068,270 |
| Borax | 50,225 tons | 2,531,350 | 31,907 tons | 1,608,140 |
| Sulphur | 6,647 " | 287,150 | 10,008 " | 432,350 |
| | | \$149,510,330 | | \$126,327,640 |
| Total value including items not mentioned above | | \$141,661,517 | | \$127,332,972 |

ported, compared with 8 tons in 1914.

The coal mining industry, confined to the southern part of Chile, is responsible for 1,086,946 metric tons in 1914, the coal is semi-bituminous, fairly high in ash and not of high steam raising quality. It is used principally on coast steamers and the Chilean State Railways. The excess demand for coal has created a market for imported coal, chiefly English and Australian (the tonnage from the United States is small), exceeding 1,000,000 tons per year. The War has affected this importation, causing a scarcity and high prices, primarily due to lack of ships; this condition has been accentuated by the temporary closing of the Panama Canal. Local coal is selling at present for 30 shillings (\$7.20) per ton on board ship at the ports of the principal mines. The price in normal times is 22s. \$5.25 per ton. Australian and English coal is up to 80s. \$19.20 per long ton, and scarce at that price, as against 29 to 32s. \$6.96 to \$7.68 in normal times. These high prices would appear to be an inducement to ship coal from the United States if steamers were available and the passage through the Panama Canal open to large carriers. The development of this business would create a return freight for nitrate. The scarcity of high quality steaming (bituminous) coal is not likely to be relieved during the War.

Petroleum has also risen in price, California crude oil being quoted at 56 shillings (\$13.44) per metric ton on the coast, while 30s. \$7.20 prevailed in normal times.

Of more than passing interest is the establishment of the National City Bank of New York in Chile. The Government has granted the necessary authorization so that the opening of the head office and its branches are to follow soon; the capital of the branch is to be \$1,000,000. The advent of 'dollar credit' should do much to foster commercial relations between Chile and the United States.

During 1915 there have been discussions at various times as to imposing export duties on copper minerals and products, also on iron ores. It is not likely that such a step will be taken. At present the following export taxes exist:

| | | | |
|---------|-----|------------|-----------------------|
| Nitrate | ... | \$0.56 per | 101.4 lb. (46 kilo.) |
| Iodine | ... | 0.48 " | 2.2 " (1 ") |
| Borax | ... | 2.28 " | 2204.6 " (metric ton) |

The year 1913 represents the highest production as yet attained; in 1903 the total value was \$61,356,511.

Coupling-Hook for Electric Locomotive

The accompanying coupling-hook is used in disconnecting a train of mine-cars from the electric haulage locomotive when the train is connected to the end of the motor opposite to that at which the motorman's seat is situated. To effect this disconnection, the motorman pulls a cord that is attached to the hook of the offset eye—the other end of the hook is attached to the chain coupling of the motor. This causes the hook to turn in

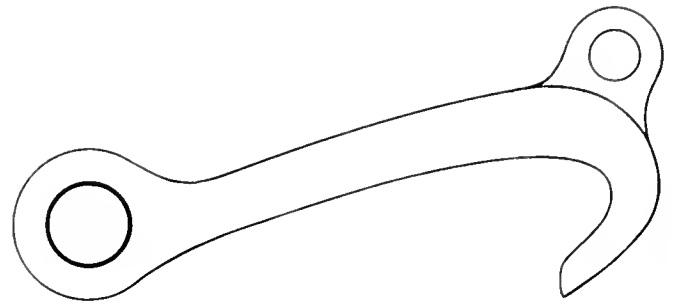

IMPROVED COUPLING-HOOK.

the connecting-chain link and to disengage from it. The use of this hook makes it unnecessary for a man to get his hands between the motor and the cars, and in some cases it saves the labor of one man on the train. The hook is particularly satisfactory for the uncoupling of a train when it is in motion, as the former way of accomplishing this by hand was dangerous. The hook is used in the Leonard mine of the Anaconda Copper Mining Co. and was the invention of John R. Jones, a motorman. The excerpt is from *The Anode*.

The Matabambra copper mine in Pinar Del Rio, Cuba, is shipping 6000 tons of high-grade copper ore per month to the United States. This will be increased to 9000 tons in a few months. The company is about to erect a concentration plant.

Platinum at the Boss Mine, Goodsprings, Nevada

By Frank A. Crampton*

IN September, 1914, the announcement was made of a discovery of ore of the platinum group in the Boss mine at Goodsprings, Nevada. For one reason or another very little that is worth while, although much in quantity, has been written about the mine, and it is the purpose of this paper to supply first-hand data hitherto unavailable.

This mine was located in 1885 as a copper claim, and was worked in a desultory manner until 1914, when gold was found. In September of that year, in an assay of a sample of shipping ore, platinum was noted by H. K. Riddal, assayer for the owners. This, in itself,

Underneath is a blue, fine-grained, crystalline limestone of Middle Carboniferous or Pennsylvanian age.

The beds are badly faulted and broken by a complex system of folding. The folding is due to a number of quartz-monzonite intrusions and to a general uplift caused partly by an extinct volcano, the Little Devil peak, eight miles south-west of the Boss.

It is chiefly in the dolomitic limestone that the ore is found, this rock being easier of replacement by mineralizing solutions, but the shaly and cherty dolomitic limestones are also somewhat mineralized. On the bedding contacts of the dolomites and the dolomitic shales and cherts a distinct replacement has occurred at places where the solutions have been restricted in their flow. So far as mine development shows, there is no ore in, or below, the beds of darker limestone, though in some of

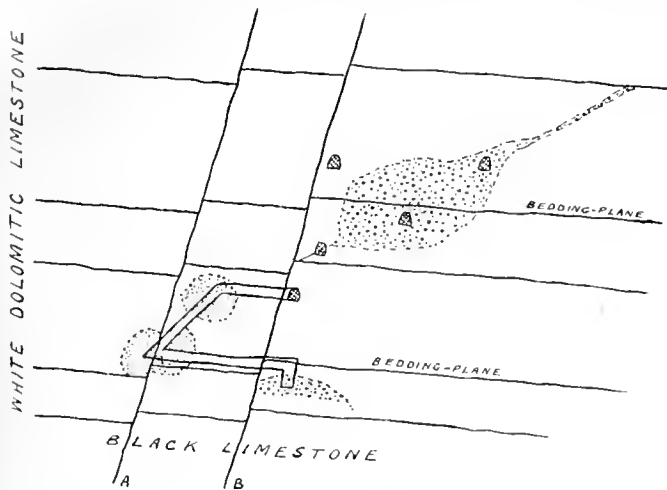

SECTION OF THE BOSS MINE.

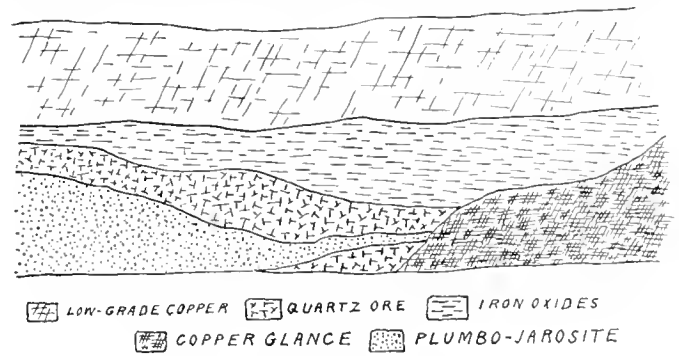

CROSS-SECTION OF BOSS OREBODY.

does not appear out of the ordinary, but when it is considered that platinum was known to at least two engineers eight years prior to this fact, the fact seems worthy of comment. The explanation is simple. The owners were not sampling and assaying frequently, if at all.

The mine is situated in the Yellow Pine mining district of Clark county, Nevada, 12 miles west of Jean and 8 miles south-west of Goodsprings. The property lies on the west slope of the Spring range, the general geology of which has been described by J. E. Spurr in Bulletin No. 208 of the U. S. Geological Survey. The formation is distinctly sedimentary, consisting mainly of limestone, sandstone, and occasionally beds of conglomerate or shale. The upper rocks of the range nearest the mine are dolomites of Middle Carboniferous age. Between these beds distinct layers of cherty and dolomitic limestone occur. Many fossils are found, principally erinoids, though I have found what was apparently a trilobite. These fossils are peculiar to the chert and shale, but there are fossils in the upper dolomites.

them ore exists on the contacts of these beds. This fact is notable, particularly where the white and blue limestones form contacts with quartz-monzonite porphyry, the matrix in such cases being usually the porphyry itself, and so differs from the other mines in there being no appreciable replacement of limestone.

The mineralization apparently was a sequel to a minor but general settling of the country, yet prior to any marked upheaval; consequently the bedding-planes at the time of the mineralization, though locally faulted and shaken, were normally in a horizontal position. The mineralizing solutions followed the bedding-planes, as they afforded more easy passage. These replaced the dolomite. In several instances the solutions have left the bedding to follow more open fractures. As a rule the replacement along the bedding is of minor importance. The chief factor in any replacement is a tightening in the channel of flow. This system of mineralization is confusing, and often leads to the erroneous idea that the ore has been confined to fractures and faults, whereas such is not the case.

Along the mineralized beds the thickness of ore may

*Superintendent, Platinum Gold Mining Company.

vary from a thin seam to many feet depending upon the character of the limestone through which it passes, its susceptibility to replacement, and its porosity or shattered condition. There is a distinct system of replacement, but owing to tightening of the beds and the more open faults, to the more open beds and the tighter bedding faults, there is apparently no conformity. The mineralizing solutions, replaced in the beds above, dropped to the beds below through bedding faults, there to follow a bedding plane and again to drop. The result resembles step faulting.

The orebodies are similar in so far as the mineralization took place in practically the same manner and under like conditions. The mineralizations do not seem to have had the same source; at least, they happened at periods widely separated. The solutions apparently have followed bedding-planes, mineralizing them to a slight extent; when they came to open beds, they followed these downward; and as the dolomitic or shaly limestones were reached, they made large replacements, and continued downward and horizontally along and through the other beds, to repeat the mineralization again under favorable conditions. It is at these points, either where the solutions were forced to seek a bedding-fault or at the foot of the fault where they had again to follow a bedding-plane, that a marked replacement is visible. It does not necessarily follow that there would be a replacement in the bedding-faults or near them; many small replacements have occurred in minor bedding-faults, but none of any consequence has been noted. Some large replacements have been found in the bedding-planes, but as a rule any replacement along a bedding-plane is of minor importance. The chief factor in any of the replacements is a tightening in the channel of flow.

There are three definite systems of faulting. The most important has a course of N 55° E; the second approximately N 5° W, and a third series N 25° E. The great fault is easily traced for several miles and steps on the north-west side, a distance not determined, through 12 or 15 ft. The lateral thrust of this is normal and 10 ft. to the north. The second series appears at frequent intervals and displaces the orebody at each intersection, vertically about 5 ft. and laterally 8 ft. These faults are irregular in dip.

It is important to note here that the minor faults apparently played no part in the mineralization; that they were subsequent to the mineralization is proved conclusively by the fact that brecciated ore is occasionally found in the fault-zone, and in some instances many feet from known ore. The faults have played a minor part, however, in a secondary replacement and re-deposition of metals, as some kidneys of the oxides of iron and copper occur close-by. None of these are of any consequence or of commercial size or value, the largest does not exceed a few cubic feet, although some of the kidneys assay high.

The fault system is important, for two miles distant on the great fault is the Oro Amigo, a prospect in which

ore carrying platinum has been found. Still nearer the Boss and about a mile away is another, the Betty Brown, which shows traces of these metals. That two other prospects along the same fault show platinum ore is significant, but the connection is not clear.

At the base of the mountain below the Boss occurs an intrusion of quartz monzonite porphyry. This forms a sheet between two beds of the darker lime-stone, and apparently does not penetrate to the upper beds of lighter dolomite. This porphyry outcrops at several points along the line of the great fault, but always to the north, while the ore lies south. The fault, no doubt, is due directly to some intrusion, and it is logical to assume that the one from which the outcropping sheets of quartz-monzonite porphyry originated was the cause.

Generally speaking, the mineralized body of the upper level is highly oxidized and constitutes a zone of low-grade copper carbonate. Underlying this in the more shallow workings is a core of quartzose material with a soft filling of gray or yellow powdery material. This is described by Adolph Knopf in Bulletin 620A, of the U. S. Geological Survey, and determined by analysis, as bismutho-plumbo-jarosite. Merging into the gray quartz as depth is attained are limonite, hematite, and magnetite. These form small seams at the outer extremity of the ore-zone; in depth they gain magnitude, the gray quartzose bismutho-plumbo-jarosite in turn becoming less. As this disappears, chalcocite takes its place. The chalcocite ore increases in proportion when iron oxides disappear. The upper capping of low-grade copper appears to be uniform in size while the other ores vary as described. It is worthy of note that cross-sections at all points in the main orebody, though the composition of it may differ, will appear nearly uniform. There is no large mineralized zone exposed on the second level. The mineralized masses below the second level and on the third have been so thoroughly leached that they cannot be considered as ore. They consist of limonite, magnetite, and hematite, with a thin casing of malachite. Throughout this mineralized zone the platinum and gold are present in traces only, while copper, except in isolated kidneys is less than 2%. This is substantiated by the occurrence of chalcocite ore beneath this zone and 40 ft. south. This ore contains platinum to less than 0.05 ounces, and gold of the average gold content, but is comparatively high in silver. On the chalcocite, much as placer gold in creek-beds, is a seam rich in platinum, but in the bulk-ore there is none. This is important, for it suggests re-precipitation. Assays show that platinum and palladium are concentrated with the high-grade copper ore on the upper levels. That the platinum has not migrated to the levels below would indicate a leaching under different chemical conditions and at different periods of time. The upper part of the mineralized body usually carries but little gold and platinum, while the base of the deposit holds the high-grade seams. Contrary to general belief, the Boss is not a high-grade mine, and with the exception of a single pocket that contained a few hundred pounds of very rich stuff, the occurrence

of the high-grade plumbo-jarosite is confined to a seam rarely as much as an inch thick.

Two ore-shoots are defined. The copper one, generally speaking, caps the gold-platinum pipe. The upper zone is much leached, the copper having been precipitated in the form of malachite on the limonite that forms the upper portion of the higher-grade quartzose pipe. As depth is attained, the leaching is less apparent, and the copper forms a mass containing more chalcocite, with some native copper. The leached portions of this mass assay 6% copper, 0.12 oz. gold, and 0.04 oz. platinum per ton, while the enriched and less leached portions show copper 17%, gold 1.2 oz., platinum metals 1.72 oz. This would seem to indicate that the copper minerals are responsible for the presence of platinum. Possibly the leaching and enrichment of the copper ore caused a segregation of the platinum metals, for in many samples the gold is negligible and the platinum high. In one instance a sample showed 0.32 oz. gold and 58 oz. platinum metals. At the extreme east of the ore-zone some chalcocite was found that assayed only 0.04 oz. platinum.

The fact that in different sections the same types of ore vary greatly in platinum content is confusing. A possible explanation is offered by the fact that as depth is attained the valuable contents become less segregated and more uniform, owing to the mineralized zone becoming more compact and the possibilities for leaching less throughout the mass. The quartzose material forming the core or pipe contains the greatest amount of platinum. This pipe is of a grayish vesicular quartz in the centre of which is the plumbo-jarosite, a soft gray to yellow or green powdery material crumbling to the touch and with the soapy feeling of silver chloride.

The vesicular quartz forms the greater portion of the orebody, but assays the lowest: gold 1.40 oz.; platinum 0.84 oz.; or about \$60 per ton. The enrichment throughout is uniform and seems to indicate a definite mineralization. The plumbo-jarosite is erratic, varying between \$10 and \$200 per ton; this does not include the

high-grade seams that form a mere fraction of the ore. On account of their extreme thinness, true samples are nearly impossible, but the ore varies between \$6000 and \$48,000 per ton, according to the width. The thinner the seam the higher the assay. This is by far the most important segregation of metals in the mine. The quartz has apparently held its grade consistently while the softer plumbo-jarosite underwent a re-deposition and a decided segregation.

It is probable that leaching and chemical action are responsible for the core, and that the deposit was principally of copper. The preponderance of platinum in

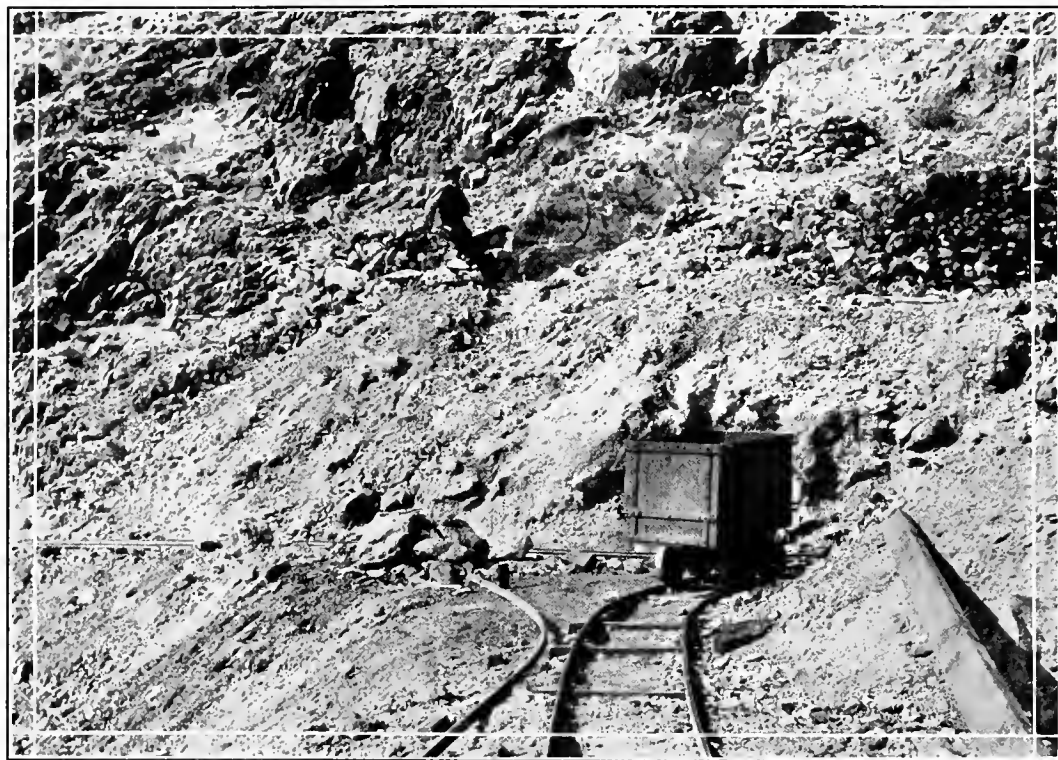

ENTRY AT No. 1 LEVEL, BOSS MINE.

The smooth face of rock 10 feet above the car marks the face of the big fault.

chalcocite and plumbo-jarosite, or in the core of quartzose material, leads to the conclusion that during the migration the copper and platinum metals made enrichments and (note Knopf) consequent segregations. The chalcocite deposition occurs in the extreme innermost working and at the maximum depth. The plumbo-jarosite ore occupies the same relative position in the mineralized body that the chalcocite does at greater depth. This, in turn, would indicate that the core was at one time chalcocite but an additional leaching and chemical action carried away the copper, leaving the plumbo-jarosite as residue. This theory is borne out by the occurrence of chalcocite on the third level, where it carries little or no platinum except in a superficial seam. That the mineralized bodies on the third level carry little or no platinum metals would indicate that the segregation of the rare metals is in the ore-zones above, and most decidedly in those nearest the surface.

The occurrence of platinum metals in ore, particularly in ore of copper or nickel is not unusual, but no ore hitherto known has contained the metals in high enough proportion to make it commercially valuable. The Boss, in this respect, stands alone. Platinum is known in the nickel ores of Sudbury, Ontario, and at the New Rambler mine in Wyoming, at the latter, however, the rare metals do not appear to be uniform throughout the mass. Only one ore occurrence similar to the Boss has been known, but the total value and tonnage was insignificant. This was at Broken Hill, Australia, and was described

by James F. Kemp, U. S. G. S. Bulletin 193, pages 83 to 86.

Authorities differ as to the origin of platinum ores, but the general opinion prevails that the known deposits originated from thermal springs. This theory does not seem applicable to the Boss, and it is quite certain that the platinum was once disseminated with copper throughout the mineralized zone, and that subsequent leaching and re-precipitation is responsible for the exceptional segregation of platinum metals, as found at this mine.

Manganese Mining in Brazil

Imports of manganese ore into the United States have been irregular during recent years, the quantity in 1914 being 283,294 long tons. Of this, 113,924 tons came from Brazil. During 1915 Brazilian imports were of considerable importance, but were checked by shortage of ships, yet they contributed 90% of the imports to this country. Production of Brazil has increased to meet the large demand, the output in 1915 being 350,000 tons, an increase of 80,000 tons over 1914, and 170,000 tons over 1913, according to Joseph T. Singewald, Jr., and Benjamin Miller.

Except a small quantity of manganese from the State of Bahia, the output comes from Minas Geraes. The two productive districts are Miguel-Burnier and Lafayette a Queluz, 20 miles apart. The former is at the southern edge of the iron-ore region of Minas, and the latter a short distance south of it. Save the Rodeio, all operations in the Miguel-Burnier area are controlled by Carlos Wigg. The Rodeio has a monthly output of 1000 to 1200 tons; the other property produces 100 tons per day.

The Burnier manganese ore occurs in the Itabira iron formation, which is a sedimentary series of Algonkian age. It is the same formation that includes the great iron-ore deposits of this part of Brazil. Near the manganese mines it shows a rapid succession of itabirite, schist, calcareous schist, and limestone, mostly the first named.

At the Section 9 mine the manganese bed is from 33 to 50 in. wide, and 2000 ft. long. The mines are usually started as open-cuts, but as the orebodies are so narrow, underground work soon takes their place. The walls are soft, and considerable timbering is required. The ore is mostly of finely crystalline compact manganese oxides, with many bumps like those found in the brown iron ores. The ore contains 50% manganese, 1% silica, and 0.03 to 0.05% phosphorus.

The Queluz district is now the most important area. The principal mine is the Morro de Mina, producing 700 tons daily, owned by the Companhia Morro de Mina, a Brazilian concern. The Mineragão de Agua Preta, a German corporation, produces 2000 tons per month of rubble ore from the east end of the Morro de Mina. A

Belgian company, Société Anonyme de Manganese de Ouro Preto, mines 3000 tons monthly from its property south of Lafayette. A number of other mines are idle in this district.

Geologically the Queluz deposits are quite different from those at Miguel-Burnier. They occur in supposed Archean rocks consisting of granite, gneiss, and schist. The ore occurs as elongated masses of more or less lenticular shape within these rocks. The immediate wall-rock is thoroughly decomposed. Horres of similar material occur in the orebodies. The ore is similar in appearance to that of the Burnier district. The manganese content is from 48 to 52%, silica 2%, and 0.07 to 0.09% phosphorus.

The Morro de Mina is the largest manganese deposit in Brazil. In 1915 it yielded 200,000 tons, and 1,000,000 tons to date. Reserves are 10,000,000 tons, the largest in the world, according to the manager, J. de A. Lustosa. In the ore-bearing area of 300 by 800 metres are four important lenses. Mining is mostly by open-cut and by hand. Costs in 1914 were 60c. per ton. Freight to Rio de Janeiro is \$1.50 per ton and from there to the United States, \$5 per ton. About 500 men are employed, who are well treated by the company. All ore is passed over a 2 cm. screen, the oversize being shipped. The under-size, about 15% of the total, containing 35% manganese, is stored for future washing or other treatment.

ONTARIO had 17 productive gold mines in 1915; of these 12 were at Porcupine. The Hollinger produced \$3,000,000 from ore averaging \$9.67 per ton; the Dome \$1,325,000 from ore averaging \$4.79; the Acme \$900,000 from ore averaging \$9.69; the McIntyre \$747,000 from ore averaging \$7.31; the Porcupine Crown \$600,000 from \$12.92 ore. The Tough-Oakes mine, at Kirkland Lake, produced \$551,000 from \$21.04 ore, or practically an ounce per ton. The mines of the Porcupine district have paid about \$5,000,000 in dividends from 1910 to date. The 1915 gold production of Ontario was \$8,386,956 or 44% of the total for Canada.

MIZPAH TRACHYTE, in which the principal large and rich silver veins at Tonopah are found, consists of 65.5 to 76.25% silica, 12.84 to 18.5% alumina, 0.1 to 3.86% ferric oxide, 0.16 to 1.8% iron oxide, 0.09 to 1.7% lime, 0.16 to 1.5% magnesia, none to 2.99% sodium oxide, and 3.2 to 6.31% potassium oxide.

*Abstract from *The Iron Age*.

Recent Patents

1,163,286.—PROCESS OF RECOVERING ZINC FROM AN ACID SULFITE SOLUTION. Charles S. Vadner, Salt Lake City, Utah. Filed May 26, 1914.

1. The process of recovering zinc from an acid sulfite solution which consists in electrolyzing the solution, partially neutralizing with a reagent that can partially neutralize the acid that may be formed and continuously electrolyzing for the recovery of the zinc and elimination of the SO₂ gas.

2. The process of recovering zinc from an acid sulfite solution which consists in electrolyzing the solution, partially neutralizing the solution with the carbonate of a metal and continuously electrolyzing for the recovery of the zinc and elimination of SO₂ gas.

1,161,351.—MAGNETIC ORE-SEPARATOR. Samuel N. Smith, New York, N. Y., assignor of one-half to Herman W. Hoops, New York, N. Y. Filed February 8, 1915.

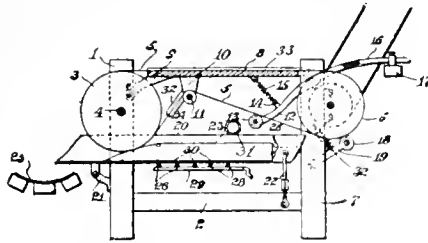

1. In a magnetic ore separator, the combination with drums, of which one is magnetic, of an endless apron passed over the same, a pan closed at the rear end and open at the front end and having its front end below the magnetic drum, which extends into the same, and deflecting partitions projecting upward from the bottom of the pan, which partitions are connected with the pan at the rear and gradually converge toward each other, substantially as set forth.

1,161,945.—CONCENTRATOR. Albert J. Matter, Portland, Ore. Filed May 5, 1913.

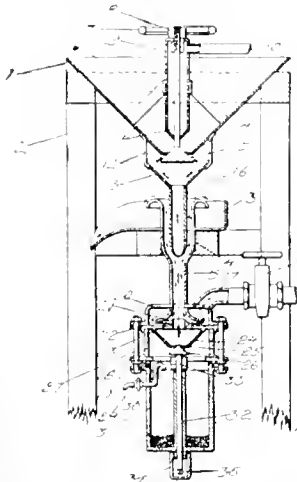

A mineral separator comprising a sand feed pipe vertically disposed and having a tapering lower end; the intermediate portion being of tubular form, and a vertically disposed separating tube having a cylindrical portion of its upper end so disposed as to entirely surround said sand feed pipe, leaving an unobstructed water passage of uniform cross sections around the outside of said sand feed pipe, the lower end of the cylindrical portion of said separating tube converging at a point adjacent to the lower end of said sand feed pipe and

continuing downward in the form of a tube having the same cross sectional area as the water passage aforementioned.

1,167,835.—APPARATUS FOR SEPARATING THE METALLIC AND ROCKY CONSTITUENTS OF ORES. Dudley H. Norris, San Francisco, Cal. Filed Apr. 5, 1915.

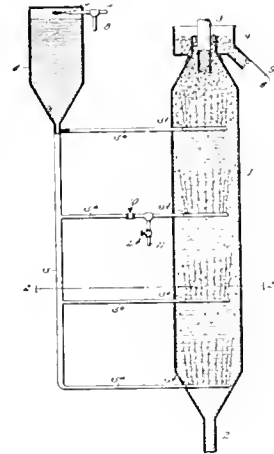

1. An apparatus for separating the metallic and rocky constituents of ores comprising means for introducing water containing air in solution into a flowing mixture of crushed ore and water at a number of different points along the path of travel of the mixture so as to cause nascent bubbles of air to form continuously in said mixture and rise to the surface thereof to carry off the metallic particles of the ore.

2. An apparatus for separating the metallic and rocky constituents of ores, comprising a member that forms a passageway, means for causing a mixture of crushed ore and water to flow through said passageway, and means for discharging aerated water into said passageway at a number of different zones so as to cause nascent bubbles of air to be created in the mixture for the purpose of carrying the metallic particles of the ore upwardly to the surface of the mixture.

1,167,619.—BUBBLE-MAKING MACHINE. Esten Beeler, New York, N. Y., assignor, by mesne assignments, of one-fourth to Herbert Beeler, New York, N. Y. Filed June 27, 1914.

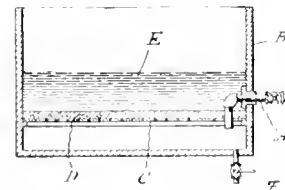

1. An alkaline solution of a stable compound of tyrosin and mercury for therapeutic use, said mercury compound having the empirical formula C₉H₉O₂NHg.

2. An alkaline solution of a stable compound of tyrosin and mercury for therapeutic use, said mercury compound being obtained by heating a solution of tyrosin and a mercuric compound, as the oxid or a salt of a weak acid.

1,167,700.—PROCESS OF EXTRACTING ZINC FROM ITS ORES. Frederick Laist and Frederick F. Frick, Anaconda, Mont. Filed Aug. 13, 1915.

1. A cyclical process of extracting zinc from oxidized ores

thereof containing iron which consists in leaching the ore with dilute sulfuric acid oxidizing the ferrous sulfate by means of a manganese compound in a state of oxidation higher than the manganous state precipitating the ferric iron, electrolytically depositing the zinc from the purified solution with insoluble anodes, and utilizing the resulting acid solution containing manganese in its higher states of oxidation for the extraction of zinc from additional portions of the ore.

2. In a cyclical process of extracting zinc from oxidized ores thereof the steps which consist in electrolyzing, with insoluble anodes, a solution containing salts of zinc and manganese, depositing the zinc in metallic state, and utilizing the resulting acid solution containing oxidized compounds of manganese for the extraction of zinc from its oxidized ores.

1,167,779 CONCENTRATING TABLE Michael J. Morley, Hayden, Ariz. Filed Feb. 16, 1914. Serial No. 818,942. Renewed June 10, 1915.

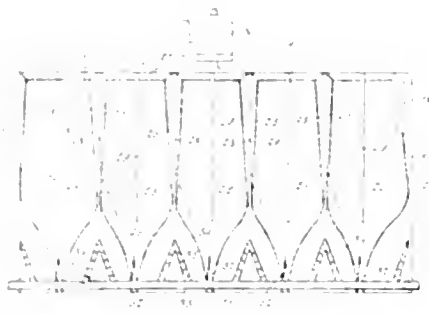

1. A concentrating table having a lateral reciprocatory motion and a series of settling areas, lateral ridges defining said areas and terminating at the concentrates discharge side of the table, said ridges being oblique to the direction of motion of the table and having oppositely sloping sides, riffles on the apices of the ridges and terminating short of the concentrates side of the table, means for discharging wash water on the ridges adjacent to the aforesaid side of the table beyond the riffles, and riffles in the settling areas parallel to and co-extensive with the first-mentioned riffles.

1,169,444—TREATING METALLIC SULFIDS, &c. Uley Wedge, Ardmore, Pa. Filed June 5, 1913.

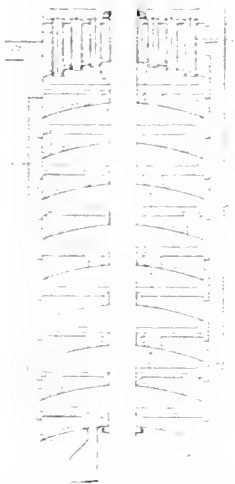

1. The within described continuous process of producing metal from sulfur compounds containing the same, said process consisting in first subjecting the compound, at a temperature sufficient to vaporize the sulfur, to an atmosphere containing a reagent which will oxidize the metal without promoting the oxidation of the sulfur, and then continuing the subjecting of

the oxid thus formed to a reducing atmosphere at a temperature sufficient to convert the oxid to metallic form.

1,167,925 APPARATUS FOR THE EXTRACTION OF ZINC Martin M. Pearlman, Clarksburg, W. Va. Filed Mar. 9, 1916.

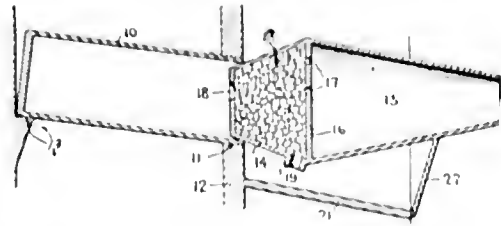

1. The combination with means for the extraction of zinc including a retort having an open outer end, of a combined filter and condenser consisting of a hollow casing provided intermediate its ends with a transverse partition dividing the casing into an inner filtering chamber and an outer condensing chamber, the inner end of the casing fitting within the open end of and engaging the walls of the retort to form a closure for the same.

1,169,381—APPARATUS FOR SINTERING AND SMELTING ORES. Arthur S. Dwight, New York, N. Y. Filed Mar. 31, 1910. Serial No. 552,579. Renewed June 12, 1915.

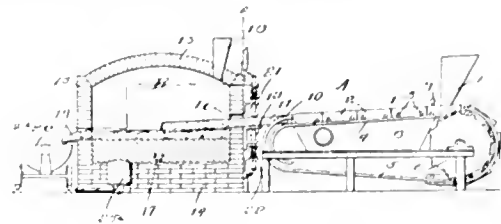

1. In an apparatus of the class described the combination of a moving platform adapted for the conveying of a continuous layer of ore, means for sintering the ore on the platform into a continuous cake, and means for passing an electric current through a portion of the cake adjacent its advance end, substantially as set forth.

2. In an apparatus of the class described, the combination of a means for forming and continually advancing a continuous layer of ore, means for sintering the advancing layer into a continuous cake, and means for passing an electric current through a portion of the cake adjacent its advance end, substantially as set forth.

1,169,276.—CONSTRUCTION OF TUBE-MILLS AND LININGS THEREFOR. David Jack Nevill, Denver, Colo., assignor to The Stearns-Roger Manufacturing Company, Denver, Colo., a Corporation of Colorado. Filed Mar. 18, 1913.

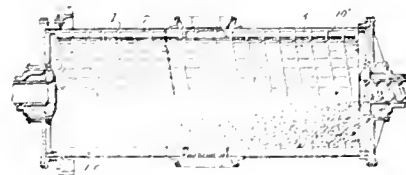

1. In a grinding mill, a shell or casing, a lining therefor comprising a plurality of juxtapositioned sections, each section comprising a plurality of segments provided with longitudinal teeth and a transverse reinforcing rib, and means to expand said segments circumferentially in said shell or casing, said means comprising wedge shaped keys adapted to be inserted in positions laterally of the sections and having their outer faces substantially flush with the outer face of the lining sections.

REVIEW OF MINING

As seen at the world's great mining centres by our own correspondents.

ELY, NEVADA

NOTES ON THE TUNGSTEN AREAS OF WHITE PINE COUNTY.

Mining of tungsten ore bids fair to be the largest industry in White Pine county, excluding operations of the Nevada Consolidated Copper Company.

It is reported that tungsten has been found in the Hamilton district, 45 miles west of Ely.

In Robinson canyon, 3 miles above Ely, just west of the old stage-station, Mr. Beech has found some hübnerite.

At Cherry creek, 50 miles north of Ely, west four miles through Cherry Creek canyon and two miles north on the west side of the range, the American Smelting & Refining Co. has taken over a large scheelite prospect. A Mr. Kimball of Salt Lake City optioned it to Nelson and others, for \$30,000, making a 10% cash payment, then turning it over to the A. S. & R. Co. for \$70,000. Recently the company has been moving freight from the railroad station to the mine, preparatory to active operations. Kimball retained a part of the ground, organized a company, sold some shares at 5c. each, and his development was so promising that he raised the price to 75c. Another company is being organized by Cherry Creek people for other claims nearby. Across Steptoe valley, from Cherry creek, on the east side of Shell Creek range, tungsten has been found.

Twenty-five miles south-east of this place, at Tungstonia (the Sims-Olsen property) for several months A. R. Shephard has been developing a hübnerite prospect. In the past two months, he has had a mill at work, making shipments of over 60% product. This is the largest producer known in this area, and probably in the United States. The main vein is 12 to 20 in. wide, traceable on the surface for 3000 ft. There are several other veins from 2 to 5 ft. wide.

Some 40 miles south of Tungstonia, at Sacramento pass, the Doyle Mining Co., organized and controlled by a San Francisco firm, has been operating a scheelite property several months. A small mill is operated.—South of Sacramento pass, 20 miles, on the west side of Snake range, and under Mt. Wheeler, the U. S. Tungsten Co. has been working a mill for many months with satisfactory results. The daily yield is about 1000 lb. of over 60% concentrate. Recently the company commenced some placer work (ground sluicing) and is finding a good deal of tungsten, including some large nuggets, without having reached bedrock. Both north and south from the U. S. T. Co.'s property, for some 8 or 10 miles in each direction, many prospects have been found and located.

In the neighborhood of Scheelite, a new camp on Willard creek, north from the U. S. T. mine, some Salt Lake City people have been developing all winter, under the management of A. D. Meyers. They have ordered a mill, which they intend to erect as soon as the condition of the roads permits its transportation.—There is considerable work being done on many prospects in this vicinity. South of the U. S. T. mine, some 20 odd miles, in the old Minerva district, 20 years ago work was done on several low-grade silver veins, which were abandoned. This was located late last fall by rancher Hudson as a silver property. Millick brothers and Jappy Fox found scheelite in the dumps, and a 5 to 6 ft. vein was opened in several places, containing 1% scheelite, with bunches of high-grade ore. They jumped Hudson's location, claiming that it was not properly staked, later agreeing to pay him \$10,000 when sold. W. Stewart recently sold the property to Salt Lake City and

Boston people. A payment of \$3000 cash was made (which is 1% of the total price) over a period of 5 years, with a 20% royalty applying to the purchase price. These people say that they will install a mill in the near future. In four days two of the Millick brothers recently panned 265 lb. of concentrate from old dumps that assay 60%, worth about \$600.

Over the range from the Minerva district, on the east side, and 8 miles west of Garrison, is the Bonita scheelite property of J. D. Tilford. About 8 or 10 months ago, he bonded and leased it to a San Francisco firm, who erected a small mill, and worked it until the water for steam and milling operations froze. Last month they gave up their bond and lease, owing to disagreements and the meddling of the owner.

South of the Bonita, at the head of Big wash, under Mt. Washington, at an elevation of 9500 ft., W. L. Chapman and A. D. Taylor late last fall discovered the best and highest grade scheelite prospect in the county. The deep snow in January drove them out, after having made several shipments of better than 70% crude ore. This week they are digging out the snow for an active campaign. About 40 miles south-west of the U. S. T. mine on Mt. Patterson, just across the line in Lincoln county, several veins of hübnerite were found late last fall. Many prospectors are going into the hills, though a little early, as only about one-third of the ground south-east exposures are now free of snow. It is probable that many of these large gaps will be filled in with new discoveries, making one of the largest tungsten areas in the United States.

On March 24 the Consolidated Tungsten Mines Co. was organized at Ely, with a capital of 500,000 \$1 shares, to develop 30 claims on Williams creek, 45 miles south-east of Ely. J. D. Murphy is manager. A number of hübnerite veins have been opened, containing 1.4 to 13.3% tungsten. Mining is done by adits. Nevada Consolidated people are largely interested.

DEADWOOD, SOUTH DAKOTA

CUSTOM-MILL INVESTIGATION.—FREE ASSAYS FOR PROSPECTORS.—

LITIGATION CLOSES MINE.—NORTH HOMESTAKE.—WOLFRAMITE FROM THE HOMESTAKE.

At the regular monthly meeting of the Deadwood Business Club it was proposed that investigation be made of the possibilities of erecting and operating a custom-mill at Deadwood. Considerable discussion ensued, and the matter was finally turned over to the mining committee, with a request that it look into possible ore-supply, cost of plant, and other matters. Preliminaries are well in hand, and as soon as the snow disappears from the mountains, the committee will get in the field and examine various properties which might be tributary to the mill. At a recent meeting of the committee there were present a number of mine-owners including Charles A. Chase, general manager, and E. R. Graham, superintendent, of the Mogul Mining Co. The latter stated that at the Mogul they were prepared to receive, and were at present treating customers; were willing to give financial assistance to lessees to enable them to secure machinery, tools and equipment; and to find lessees who would take over and operate properties that contained ore. It was also announced at the meeting that the Golden Reward and New Reliance mills treated customers. Ore transport to the railroads received some consideration at this meeting, and Mr. Graham suggested that the com-

committee examine into the feasibility of securing a motor truck which might be used in hauling ores at various near by points. He thought that a 5-ton truck could be used to advantage, and would be of great benefit to mines that were from 2 to 5 miles distant from the railroads, such haulage, he thought, could be done at 1 to 1½ the cost of haulage by horses. Altogether it appears that the discussion started will be of value to the mining industry, it will at least give some advertisement to the properties that the Club's committee will examine, even though the mill should not be built.

At a recent meeting of a joint committee from the Deadwood Business Club and the Lead Commercial Club with State Regent Albert Anderson and Dean O'Hara, of the State School of Mines, details of a plan were practically completed by which the institution will make assays of gold and silver for 25c, and qualitative determinations for tungsten free of cost. The samples must be sent to the School by the secretary or some other officer of one of the Black Hills commercial clubs, it being the intention of the School to extend this service to worthy prospectors. It will thus devolve upon the clubs to see that the School is not imposed upon. Further, it is the intention of the clubs to pay the fees to the School, so that the prospector will not be under any expense. This is the result of an effort made by the clubs to secure a free assaying service for the gold and tungsten seekers. The School is doing the work under authority given in a law passed by the State legislature in 1903, which established a State mining experiment station at the School, but for which no appropriation has ever been made. At the legislative session next winter a concerted effort will be made to secure funds to carry on the work, in which case assays might be free of cost and other assistance rendered the mining industry.

Mining and milling has been suspended at the Rattlesnake Jack property as the result of litigation between the owners, W. Sansom, of New York, and C. B. Harris, of Galena, S. Dak. Mr. Sansom is understood to have offered to buy or sell, and it is hoped that the affair will be settled out of court, for since Mr. Harris has established a home at Los Angeles, he has spent but little time at the property and desires to leave the country. The mine is a valuable one; it has been a producer for years and last summer a 10-stamp mill was completed and started. This plant is equipped for concentration and cyanidation, and of late has been making a recovery of about 93% on a \$20 mill-feed.

Since development was resumed at the North Homestake last summer a drift has been run south from the 600-ft. station, a distance of 600 ft.; from its end cross-cuts have been advanced both east and west over 100 ft. each way. Practically all of this work has been done with the aid of a jackhammer mounted on a column. Quartz has been cut in the cross-cuts.

From the first two cars of wolframite which the Homestake shipped from the Golden Summit claim, more than sufficient was realized to reimburse the company for the purchase of the Hidden Fortune group, of which the Golden Summit claim is a part. The claims were purchased from the now defunct Hidden Fortune Mining Co. some two years ago. The Homestake now has the third car-load nearly ready for market.

TORONTO, ONTARIO

PORCUPINE, KIRKLAND LAKE, AND BOSTON CREEK DISTRICTS.—
FLOTATION OF COBALT ORES.—NICKEL ONCE MORE.

Porcupine news is as follows:

At the Hollinger, recent developments on the 1275-ft. level are of a decidedly encouraging character. In sinking to this depth the winze passed through a quartz-porphry formation, the gold-content of which was considerably lower than in the upper levels. The vein is now in the basalt, where the value is above the Hollinger average. The head-frame at the new shaft is nearly complete. The annual report of the company will be considerably delayed this year, as the staff has been

weakened by enlistments in the army, and the final decision of the Government as to the war-tax on mining companies is being awaited.—The Dome Lake mill has been closed down for two weeks during the installation of the new cyanide plant, which is expected to be ready for operation about the end of March. Underground work is in progress as usual.—The new vein on the 400-ft. level of the Vipond has been opened for 165 ft., averaging \$13 per ton. The ore is heavily mineralized and contains much free gold. Some ore has been found on the 500-ft. level, but nothing of consequence.—Sinking will shortly be resumed on the North Thompson. The shaft, now at 300 ft., will be deepened to 500 ft. Plans for a new mill are being considered.—The starting of the 150-ton addition to the McIntyre mill has been delayed by an accident in No. 5 shaft. It is proposed to haul the ore from the McIntyre Extension and Jupiter mines for treatment at the mill by motor trucks, pending the installation of a carrier system.—At the Porcupine Crown the new steam hoist is in operation, and much development is being done at 700 ft. Low-grade ores are being developed on the upper levels. The mill is treating an average of 125 tons daily.—The Standard, south of the Dome Lake, is being developed by the Premier Gold Mining Co., controlled in Boston.

The Tough-Oakes at Kirkland Lake is treating about 120 tons of ore per day. The output in February is estimated at about \$45,000.—The Beaver Consolidated of Cobalt is developing the McCane property in the Kirkland Lake area, on which it has an option for one year. The shaft is down 200 ft., where a station will be cut.—The Wright-Hargraves, east of the Tough-Oakes, which has a rich vein on the surface, is being opened.

There is a good deal of activity in the Boston Creek district.—The R. A. P. Syndicate has done about 180 ft. of driving on the 100-ft. level, where the vein is opening well with a good deal of free gold.—The Miller Independence has installed a boiler and compressor, and is erecting a small stamp-mill. A shaft has been started.—The Crown Reserve, which has under option the four McCrea-O'Neill claims, has cut a vein at a depth of 10 ft., 19 in. wide and rich in free gold.

Much interest has resulted at Cobalt by flotation tests conducted at the Buffalo. It is stated that flotation is suitable for Cobalt ores. The Buffalo has consequently decided to install a 600-ton plant for the treatment of tailings.—The McKinley-Darragh is installing a 150-ton flotation plant, which is guaranteed to save 500 oz. per day by higher extraction. Ore reserves at the end of 1915 were 1,875,000 oz., with an average of 15 oz. per ton, or only 257,820 oz. less than at the end of 1914.—At the Gifford-Cobalt the main shaft has been dewatered and machinery installed. Diamond-drilling will be done on the 200-ft. level to determine the extent of the ore-body, which is thought to be an extension of the Beaver vein system.

The nickel question is assuming a more acute phase, and appears likely to become a leading political issue. The feeling in favor of having all nickel ore refined in Canada is developing unexpected strength. A noteworthy sign is the stand taken by the Liberal press, which was until lately indifferent or opposed to any interference with existing arrangements. The conditions arising out of the War however, have brought about a complete change in public sentiment, and the agitation, which was formerly confined to extreme Protectionists and scaremongers, now receives the support of a large and influential element, on the ground that Imperial interests demand that the disposal of the product of Canadian nickel mines should be under strict Government control. In the present temper of the public the hand of the Government is likely to be forced, more especially as the Liberals evidently mean to take advantage of the movement as furnishing a good political cry. Before the War nickel was sold to the British government for 34.8c. per pound; the price is now 37.2c. The solicitor-general, Hon. Arthur Meighen, favors an export duty on nickel matte to encourage refining in the Dominion.

THE MINING SUMMARY

The news of the week as told by our special correspondents and compiled from the local press.

ALASKA

The report of the territorial mine inspector, William Maloney, covers 1915. The estimated mineral production is \$31,826,940, an increase of over \$12,000,000. Copper contributed \$14,633,950 and gold \$16,752,000. There were inspected 168 placer mines, 31 quartz mines, and 30 dredges, employing 3000 men. There were 23 fatal, 92 serious, and 387 slight accidents. There was an ample supply of labor everywhere. Brief notes are given on all the mining districts. The names of dredging, lode mining, and placer companies are included.

KETCHIKAN

(Special Correspondence.)—Some increase in mining activity is noticeable in this district.

The Mt. Andrew mine has resumed operations after a brief shut-down during the winter. Small shipments are being made to the Tacoma smelter, and preparations are being made to increase the output.

The Goodroe mine will continue to ship ore to the Granby smelter at Anyox, B. C. This mine is unique, as bornite is the predominating ore-mineral, and it is the only locality in south-eastern Alaska where bornite has been found in quantity. Platinum is also present in the ore, and should receive payment owing to the present scarcity of the metal.

C. Lancaster has succeeded in interesting capital with a view to re-opening the old Sea Level properties.

At the Rush and Brown mine a large amount of ore has been broken in the stopes, and shipments will probably be increased to double the usual amount. Ore is being developed in the lower levels with good results in both grade and extent of orebodies. The magnetite ore is said to give better results in both copper and gold in the deeper workings than nearer the surface.

Ketchikan, March 7.

The Sea Level Development Co. has been organized at Seattle to re-open the old Sea Level gold mine in the Ketchikan district. The mine is near tidewater, where is a 30-stamp mill. Pumps are being installed, a hoist and compressor have been purchased.

ARIZONA

The State Bureau of Mines contemplates publishing a directory of the operating mines in Arizona, but is finding it somewhat difficult to keep up with the progress, as so many new mines are being started each day.

GILA COUNTY

(Special Correspondence.)—Considerable activity is evidenced in the mining districts around Payson this spring, owing partly to the visits of mining engineers to the region last fall. J. Parke Channing spent two days here and looked at a few of the prospects; other mining men have been here recently. Some shook their heads and murmured: "Too far from a railroad." It's awful to contemplate, but it's true. Yes, it is too far for timid spirits. Mr. Channing cheered us somewhat on that score when the fact of the great distance from the railroad was mentioned; he said: "One good producing mine will bring in a railroad soon enough." The high price of copper has stimulated the dormant interest in many prospects around Payson. Is it not like the trials of Tantalus to have such quantities of shipping ore? Assuming we were

25 miles to a railroad; add 80 miles to this and you have the distance by wagon-road to Globe or Miami: \$60 ore does not pay; at least \$75 ore must be extracted to make profits. Still we are shipping in small lots by parcel-post.

Boardman, McFarlane, and Pratt have made a number of shipments from the West Star, which assays 15% copper, \$8 gold, and \$4 silver. Others have shipped ore from the Silver Glance group, yielding \$120 in gold, silver, and copper. Considerable development is planned for the coming season at the West Star. An adit of over 200 ft. will be driven to cut a 2-ft. vein at about 135 ft. depth.

On the Bailee group, A. J. McDonald has just completed an adit over 200 ft., for the purpose of cutting a high-grade gold vein at 140 ft. Assays returning \$40 have been received, and a small mill will be erected. The George Washington gold prospect on the outskirts of Payson, owned by Mr. McDonald will also come in for a share of development this season.

Edward Oliver is now enlisting New York capital for the exploitation of gold claims situated about 4 miles west of Payson. Recently he opened high-grade ore on the Western Excursion, a west extension of the famous Excursion (patented). Four feet of low-grade ore just fills one end of a 50-ft. shaft in the Western. Mr. Oliver evidently hesitated in accepting the view commonly held that low-grade ore constituted the entire deposit, and on thorough investigation, about 14 in. of \$20 ore was discovered outside the shaft in an open-cut. It was a red hematite ore on the hanging wall, the balance of ore being white, worth \$6 per ton.

The Pittsburg Tonto Copper Co., formerly the Schell property, will resume operations this spring under the management of D. T. Clinton of Belle View, Pennsylvania. Shipments of 25% copper have been made from this property in the past. The vein is over 40 ft. wide, and contains 2% copper and \$2.50 gold. An 18-in. high-grade streak of chalcopyrite, running with the dike from which the above-mentioned shipments were made, together with the prevailing high price of copper, seemed attractive to the newly-formed company which recently took over the 32 claims in the group. Not the least of the assets consists of the water-power of the Tonto river, 1500 miner's inches being available. The claims are on both sides of the river in the foot-hills of the Sierra Anches. The present owners propose to sink a shaft at least 200 ft. and will install a gasoline hoist and two drill-compressors immediately. Although 80 miles from Globe, the nearest railroad point, this handicap evidently does not deter venturesome spirits; in fact, greater obstacles have been overcome in the history of mining. More power to them.

Payson, March 12.

The 100,000 tons of copper ore in the Joe Bush dump of the Inspiration company is being removed before under-cutting and caving starts underground. The dumps at the Colorado shaft will soon be cleared away. Several parts of the ground surface show signs of caving operations.

On March 22 the International smelter at Miami dispatched East 10 and the Old Dominion 9 cars of copper, totaling 4,461,800 lb., a record shipment, from Arizona. It was valued at \$1,195,000.

MOHAVE COUNTY

Californians, including A. C. Parsons, C. H. Gilman, H. H. Moore, and L. Tevis, have financed the Oatman North Star Mines Co. to exploit 250 acres in the centre of the Oatman dis-

trict. A shaft is down 80 ft. in the lode, but the main shoot is expected at 100 feet.

The Gold Road mill is treating ore from the Gold Ore company's mine, where rich ore has been opened to 530 ft. About 1000 tons will be treated.

At 345 ft. in the Nevada-Arizona, the Lucknow vein is 12 ft. wide, of good value. At 500 ft. is 2 ft. of \$70 ore. The mill is to resume since a supply of water has been secured.

The Comanche and Pinkham claims at Chloride have been acquired by the Needles Mining & Smelting Co., which operates the Tennessee mine at Chloride and a reduction plant at Needles, and is a subsidiary of the F. S. S. R. & M. Company.

PINAL COUNTY

Drilling at the Ray Hercules has found ore beyond the fault. Plans for the mill are being prepared by George Bradley. J. M. Callow will design the flotation plant.

YAVAPAI COUNTY

The Henrietta gold-copper mine has been exploited by the Big Ledge Development Co. since last October. The lower adit is in 1461 ft., with 650 ft. to go to be vertically under the main shaft. Three shifts are driving over 50 ft. per week with machines. Thirty men are employed. There is an equal number at the Butternut, two miles south of the Henrietta, owned by the same company. This is a copper-gold mine. In charge of the mines are L. E. Le Due and J. P. Trebilcock.

Backed by Chicago capital, in which F. A. Wheeler is the head, a 12,000-ft. adit is to be driven into the Bradshaw mountains to explore at a depth of 1800 ft. The portal will be a mile from the Crown King mine. The Fairview, Gladiator, Lincoln, Nelson, Spring Green, and War Eagle gold-silver mines will benefit by this drainage, development, and transport adit.

Ore crushing has been started at the old Yuma mine, 11 miles from Tucson. A large sum has been spent on equipment and development. The mine was formerly a gold producer, but is now yielding tungsten and molybdenum, and \$3 per ton in gold.

CALIFORNIA

AMADOR COUNTY

A clubhouse is being erected by the Plymouth Consolidated for its employees, a new departure on the Mother Lode.

Foundations are being laid for the new mill at the Treasure, near the Fremont at Amador City. The Fremont shaft is being sunk from 2450 ft. to 2750 feet.

The Old Eureka Mining Co. has been incorporated in Delaware with \$3,000,000 capital for the purpose of pumping out and exploring the old Eureka mine, which was purchased in February from Mrs. Betty Green by a syndicate headed by William R. Thornton, William B. Dickinson, Charles D. Prazier, Franklin K. Searle, Charles Briggs, Chester A. Congdon, and George E. Kenner. Only 100,000 shares, par value \$10, will be issued now. The mine has not been operated since 1886.

BUTTE COUNTY

According to Richard Phillips, manager and controller of the South Banner mine, four miles north-east of Oroville, on the Feather river, a four-mile transmission line is being connected with the Ore company's mains to supply current for a central compressor-plant, which will give air for hoisting and other purposes. At present steam hoists are used at the South Banner and Angusky shafts, which are down 400 and 600 ft. deep respectively in good ore. The former is to be deepened 100 ft. Two 1000-lb. stamps are used for testing the ore.

CALAVERAS COUNTY

(Special Correspondence.)—The gravel mine owned by W. A. Swank has been incorporated under the name of the Gold Bar Mining Co. There is about 1½ miles of channel. It is expected that the mine will be in full operation within the

next 60 days. J. J. McIntire is president and general manager.

The McCann gravel mine, in the Chill Gulch district, has been bonded and work has commenced. The adit is in 900 ft., and is opening the channel known as the Blue Lead. This was worked in the early days and yielded well.

The Bachman and the Big Four mines have been bonded by G. Algewahr, of Fourth Crossing. They are near the Thorpe mine, which is in the hands of Eastern capitalists, and under the management of Mr. Algewahr. Work on the Bachman and Big Four will be started as soon as possible.

San Andreas, March 18.

The new mill of the Calaveras Copper Co. is treating 200 tons of ore daily, yielding 16 to 19% copper concentrate. This quantity is to be increased by 50%. A new coarse-crushing plant is to be erected at a cost of \$15,000. Mine development continues satisfactory.

NAPA COUNTY

A number of old quicksilver mines near Calistoga are being re-worked. At the Oat Hill 40 men are employed.

SAN BERNARDINO COUNTY

Optimistic news comes from Atolia, which now has a weekly called the *Tungsten Review*. New discoveries are reported and claims change hands. Placer scheelite continues to be found in fair quantity. Good progress is being made with the Atolia company's new mill, which will be larger than the one burned. The ore is broken in a 10 by 18-in. Joshua Hendy crusher, and further reduced by rolls. Half of the product is fed to two 5-ft. Huntington mills. The discharge passes over two Deister roughing-tables, where the richest material is extracted. From the tables it passes to vanners. The other half of the material goes to an 8-ft. Marcy ball-mill, the capacity of which is from 30 to 40 tons per 24 hours. The crushed ore is discharged through a 30-mesh screen onto a Deister roughing-table. From there it goes to a Dorr classifier. The slime from both units is thickened for concentration by three 8-ft. Callow cones, and then passes over three double-deck Deister tables. Tailing is stored for future use. The tailing runs from 1 to 3% calcium tungstate. A conservative estimate places the amount available for treatment at 200,000 tons.

Each separate piece of machinery has its individual motor, there being more than 25 motors required. The mill will use 30,000 gal. of water each day when at full capacity, and it will produce from 5 to 7 tons of concentrate per day. This, together with the output of the jigs, will make the average daily production of tungsten concentrates about 7 tons. The No. 1 mine will soon be lighted by electricity. An electric hoist is to be installed at 900 ft. to serve the prospecting winze below that depth.

The Pash placer, in the Stringer district, has changed hands for \$5000.

SHASTA COUNTY

At Kennett the Mammoth company has three copper furnaces in blast treating its own and Balaklala ore. Good progress is reported from the long adit being driven. The Greenhorn copper mine, near Tower House, has resumed shipments to Kennett.

The Afterthought copper mine at Ingot is under option for sale. Zinc was a nuisance in treatment several years ago.

SISKIYOU COUNTY

On the Grenada section, about 6 miles from Montague, near the Southern Pacific line, the Shasta Development Co. is to drill for oil. Two 13-in. holes will be put down. Oil may be struck at 2500 feet.

TUOLUMNE COUNTY

(Special Correspondence.)—The Atlas mine near Tutletown has a new body of ore, and the future of the property looks promising. J. Whitney is superintendent.

The Saratoga gravel mine, adjoining the Springfield Tunnel

property, is being worked under new management, and gravel will be mined in the near future.

The Street mine in the Tuttletown district has been unwatered by San Francisco people. It is equipped with a five-stamp mill.

The old Patterson, with a past production of \$1,500,000, is to be unwatered shortly.

Tuttletown, March 18.

YUBA COUNTY

On March 26 No. 15 dredge of the Yuba Consolidated company was launched at Hammonton, the ceremony witnessed by 2000 people. The buckets are of 17 cu. ft. capacity and will dig to a depth of 82 ft. Work is to be started on No. 16. The Yuba Construction Co. builds these boats.

COLORADO

BOULDER COUNTY

According to A. P. Ardourel of Boulder, he has sold one of the largest tungsten properties in the Nederland district for \$200,000 to New York people.

There is keen competition among tungsten-ore buyers, re-

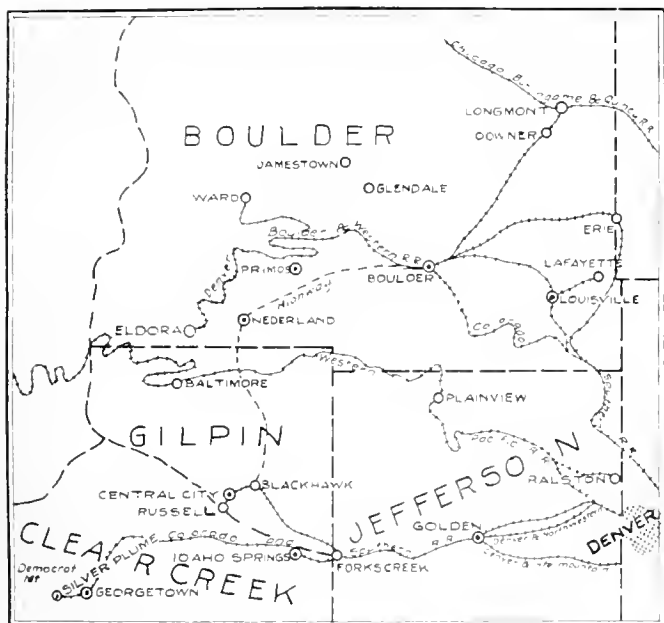

THE TUNGSTEN DISTRICTS OF BOULDER COUNTY, COLORADO.

sulting in \$90 per unit being paid by the Colorado Tungsten Mines Co., which is higher than that offered by the Boulder Tungsten Production Co. W. M. Long is in charge of the former company, which has a mill at South Boulder. The Boulder company is making large profits from its custom plant, over \$1000 per day. The mine adit is in 500 ft., and yields 35 tons of 4% ore daily.

The Mojaba Mining Co. of New York has bought the tungsten claims of Chris Bracken at Boulder Falls for \$100,000. A mill will probably be erected.

CLEAR CREEK COUNTY

(Special Correspondence.)—The Mosher lease at the Lake mine, situated on Pewabic mountain, was sold this week to E. D. Quigley of Denver, representing Oklahoma people, for \$15,000 cash. The ground controlled is above the Big Five adit-level, and extends to the end-lines of the claim, a distance of 1200 ft. During the past 18 months Mosher & Co. have been credited with a production of \$200,000.

E. Renner & Co., leasing at the Bellevue-Hudson mine, have opened a 10-in. streak of smelting ore for 20 ft. that assays as high as 1800 oz. silver per ton.

J. J. Hoban, manager of the Wyoming Valley company, states that as soon as the frost is out of the ground excavation will be started for a compressor-plant. The adit is in 600 ft., and within 800 ft. the French Flag-Silver Age properties will be completely drained.

The sum of \$40,000 was deposited in the Bank of Georgetown this week to be used in equipping the Malm mill at Georgetown. Mrs. Alice H. Brownlee of Idaho Springs, who is financing the scheme, states that the plant will be completed and in operation within 90 days.

Idaho Springs, March 17.

The old Colorado Central mine has been acquired by oil people, who have re-opened it after many years' shut-down.

IDAHO

BLAINE COUNTY

A good revival in mining is expected this season in the Wood River region of central Idaho, of which Hailey is the centre. In 1915 the output of the county was 1405 oz. gold, 120,000 oz. silver, 1,200,000 lb. lead, 1,110,000 lb. zinc, and 6000 lb. tungsten. A good lead-silver development was made in the Red Elephant company's adit. It is considered as important, and proves that failure of faulting displacements than from exhaustion of the ore in depth. Zinc is also being mined in the district, the largest company being in granite. The Camas lode, 12 miles west of Hailey, occurs in granite, and is worth larger exploitation.

IDAHO COUNTY

Around Elk City there are over 100 men employed. The Mineral Zone or Parr property produces 16 tons of gold ore daily. At the South Fork mine on the Clearwater river five stamps are dropping. A mill is to be erected at the Center Star. Good developments are reported from the Grangeville, Black Pine, Hercules, and Cumberland. The Buffalo Hill placers are to be re-worked. A dredge to replace the one constructed six years ago is to be built by the Elk City Dredging Co. of Spokane. The ground was prospected last year by a Keystone drill, averaging 35c. per cubic yard.

The old Hogan mine near Orogrande, 50 miles from Grangeville, is to be re-opened. Debts have been paid, and sufficient capital secured for operation. Several lode and placer properties near Orogrande are promising.

SHOSHONE COUNTY (COEUR D'ALENE)

During February the Interstate-Callahan produced 5810 tons of zinc and 455 tons of lead concentrates, yielding a profit of \$278,287.

A first-aid contest was held at Kellogg on March 13, between 9 teams (54 men) from the Bunker Hill & Sullivan mine and mill. The K. T. Dump team won with 96%, Mill Carpenters' team second with 89.25%, and Mill team third with 89%. Good prizes were given. The manager, Stanly A. Easton, presided at a banquet following.

Rich tungsten ore continues to be produced by the Golden Chest and other mines near Murray.

A 150-ton mill is to be erected at the Constitution mine on Pine creek this summer. A saw-mill will cut lumber from the property.

On April 5 the Caledonia company will pay a dividend of 3c. per share, equal to \$78,150.

MICHIGAN

THE COPPER COUNTY

(Special Correspondence.)—Exploration on the lands of the Torch Lake company will probably commence early in the spring. This company owns two sections in what now seems to be promising mineral territory, which extends from the Kearsarge lode to the sandstone. Recent developments at the

New Assolati have an important bearing. The surface has been eroded by glaciers for many years, 20 or 30 years, in fact. Twelve years ago some diamond drilling was done, but the results were not encouraging. In fact, only one core showed a reported value.

There is no producing mine in the Lake Superior district which seems to have as bright a future as the Allouez. People here do not fully appreciate the possibilities of this mine for the reason that the property has been, for a period of 40 years, a practical failure.

The Thompson stampmill of the Copper Range Consolidated Co. will be rebuilt. This mill, at Beacon Hill, about midway between the Champion and Baltic mills of the same corporation, had a number of advantages, particularly of site.

At the Quincy stamp-mill No. 2 head has a new foundation. All of the 24 in. low pressure stamp-cylinders have been replaced with the old 20 in. cylinders for higher steam pressure. In No. 1 mill, 24 stall type bulljigs have been installed, and 12 in No. 2. Three more rollers have been put in No. 1, making roller equipment similar to that of No. 2 mill.

The average pay to miners working in the Calumet & Hecla mine for February was \$1.35 per shift. Practically all of these miners work on contract, a system that has been in vogue in the C. & H. since the earliest days. This compensation compares favorably with the wages paid miners in any copper centre in the world, and these employees receive advantages in house-rentals and other ways that make for certain reduction in the cost of their living.

Notwithstanding the large amount of conversation that continues to find its way into print relative to the purchase of the Tamarack by the Calumet & Hecla, the general belief here is that no such deal ever will be consummated. The C. & H. interests are indifferent on the subject. They will buy no lawsuits, however. They do not wish to take over Tamarack unless they can take it over with absolute assurance that there are to be no recalcitrant stockholders to make trouble, and start suits about it. And they are willing to sell their interest in Tamarack for substantially less than it cost them or they will buy out others.

Houghton, March 29.

Exploration at the White Pine Extension has been so satisfactory that the company is to build a railway six or seven miles to the White Pine line.—Mineral (66% copper) is to be hauled from the White Pine mill to the Hubbell smelter in small steel cars.

The Calumet & Hecla reports as follows for February:

| Mine | Copper | | |
|-----------------|-----------|------------|-----------|
| | in pounds | in pounds | |
| Almeek | 1,544,671 | La Salle | 81,993 |
| Allouez | 814,142 | Osceola | 1,893,838 |
| Calumet & Hecla | 6,911,579 | Superior | 252,098 |
| Centennial | 172,629 | Tamarack | 659,626 |
| East Republic | 874,437 | White Pine | 313,573 |

MISSOURI

JASPER COUNTY

With a mine in sheet-ground and a 350-ton mill, the Milan company at Prosperity sold its property last week to W. Kenebel and others for \$125,000.

The better smelter market reflected on the ore market last week, the range being from \$90 to \$115 per ton. The output of the Missouri-Kansas-Oklahoma region was 3997 tons blende, 598 tons calamine, and 1136 tons lead, averaging \$98, \$68, and \$94 per ton, respectively. The total value was \$536,484.

MONTANA

According to C. S. Warren, of Butte, recently at Spokane, more prospectors than ever will commence in Montana when the snow clears away. The country will be finely combed, as it were.

LAUREL AND CLARK COUNTY

In the Grass Valley district, four miles west of Helena, there is increased activity. Favorable reports come from the Rock Rose and Carbon Hill mines, the latter a silver-lead property.

Developments are encouraging in the Eastern Belle, Madden, and Allen in the Scratch Gravel district, which was recently visited by Helena businessmen.

The Helena Mining Bureau is busy in the old Park gold district, six miles south of Helena.

SHELDON COUNTY

The North Butte company's Granite Mountain shaft is 2165 ft. deep, on its way to 3600 ft. A station will be cut at 3200 ft. A wide lode has been cut at 700 ft. The monthly output is 2,250,000 lb. copper.

The Butte & Great Falls company has purchased the Dewey and four other claims adjoining the company's property, for \$50,000 cash and 25,000 shares. H. H. Hanson owned the Dewey. The Butte & Great Falls is well financed for extensive exploration.

NEVADA

ESMERALDA COUNTY

A Davis Calyx drill is being installed at 700 ft. in the Silver Pick Consolidated. Good ore is being opened at 500 and 600 ft., according to G. F. Dyer, the manager.

Surface prospecting by the Reorganized Cracker Jack company has given fine results, three well-defined veins, yielding gold by panning, having been stripped for a considerable distance. A hoist, compressor, machine-drills, etc., have been ordered.

During 1915 the Goldfield Consolidated Mines Co. produced 385,900 tons of \$10.37, and 1154 tons of \$23.53 ore. The profit was \$1,558,308. Dividends absorbed \$1,601,617. Development covered 34,603 ft. Total costs were \$1.03 per ton lower.

The 50-ton flotation plant at the Goldfield Consolidated is giving 90% extraction on the gold-copper ores.

During February the Jumbo Extension produced 2595 tons of ore worth \$79,000, of which \$25,000 was profit.

HUMBOLDT COUNTY

In reply to a correspondent who asks where antimony occurs in this county, we would say in the Antelope Springs, Bloody Canyon, Jackson Canyon, Juniper Mountain, Lovelock, Red Butte, Rosebud, Seven Troughs, Star Canyon, and Winnemucca districts.

NYE COUNTY

Additional water supply has been secured for the Round Mountain Mining Co. by purchasing the Round Mountain Power & Water Co.'s properties, including the water of Jefferson and Shoshone creeks. This will allow of more extensive sluicing at Round Mountain.

Ten mines at Tonopah last week produced a total of 8514 tons of ore worth \$179,952.—The Belmont shipped 173,155 oz. bullion.—The Tonopah Mining Co. has declared its regular quarterly dividend of \$150,000. At the mill an average of 53 (out of 100) stamps is crushing 1950 tons of \$15 ore per week.—The Rescue-Eula continues to produce 15 to 20 tons daily from the new shoot.—For the first two weeks of March the West End cleaned-up 55,619 oz. bullion, worth \$42,000.—During February the Extension treated 7985 tons for 177,618 oz. bullion, and \$69,523 profit.

NEW MEXICO

The 'Advancement Number' of the *New Mexico State Herald* of Santa Fe consists of 64 pages devoted to all industries in the State, which produced \$100,000,000 in 1915, mining contributing 20%. The State has an area of 122,503 square miles and a population of 360,000. Some good illustrations show the work of the Chino Copper and other companies.

WASHINGTON**STEVENS COUNTY**

A carload of lead bullion is shipped daily from the Northport smelter to its refinery in Pennsylvania. This is from one furnace. The smelter yard has a good stock of concentrate awaiting reduction. Another furnace is soon to be blown-in.

WISCONSIN**IOWA COUNTY**

(Special Correspondence.)—The New Jersey Zinc Co. at Highland has its new 8 by 18-ft. shaft in the clear in the largest deposit of blende and zinc carbonate ever opened in this district. The 'range' has been proved by drills to be nearly a mile long and over 150 ft. wide. Carbonate ore is selling at \$60 per ton, basis of 40% zinc. This district is noted chiefly for extensive deposits of this class of zinc ore.

At Mineral Point the works of the New Jersey Zinc Co. is engaged in the manufacture of zinc oxide and sulphuric acid. At the former, 300 men are employed and the plant is always busy. The warehouses contain 40,000 bbl. of finished oxide, and large shipments are made daily. Four to seven 25-ton tank-cars of commercial sulphuric acid are shipped weekly; 80 men are given employment in the acid department. Two zinc ore refineries are kept going constantly, employing 100 men.

At Mifflin the two Coker mines, on a single deposit of zinc ore, and owned in fee by the New Jersey Zinc Co., are producing 1700 tons of mill ore daily. Shipments of concentrate average 350 tons per week, all sent to separating plants at Mineral Point. There are eight other active shippers in this district.

Mineral Point, March 16.

CANADA**BRITISH COLUMBIA**

At the Granby Consolidated company's Hidden Creek mine daily shipments to the Anyox smelter are 2500 tons of 2 to 3% copper ore. About 400 miners and 600 smelter-men are employed; the former receive \$3.50 per shift, with a bonus of 25 to 75c. per shift, according to the price of copper. At Phoenix the mines are sending 3000 tons per day to the Grand Forks smelter. Employees are 400 and 200, respectively. The Mamie mine at Hadley, Prince of Wales island, Alaska, sends 200 tons per day to Anyox. Other small mines contribute. During the second half of 1915 the Anyox and Grand Forks plants reduced 377,660 and 571,502 tons of ore, respectively, yielding a total of 19,894,527 lb. copper, 22,934 oz. gold, and 188,649 oz. silver. The profit was \$1,513,181. Dividends absorbed \$449,955.

Hydraulicking will be started toward the end of April at the Union mine on Siwash creek, near Vernon, according to the superintendent, I. S. House. One No. 5 giant, with a 5 to 7-in. nozzle, is used under a 110-ft. head. The gravel channel is 200 ft. wide, and a maximum bank of 90 feet.

Better zinc-silver ore has been opened on No. 7 and 12 levels of the Rambler-Cariboo than in the upper levels.

KOREA

During December the Oriental Consolidated company's output was \$144,472 from 26,621 tons.

The three mills worked steadily during December, as there was plenty of water, and there were few stoppages of Okura's power supply. The extraction obtained in the Taracol cyanide plant was 89%, while that for the Maibong tube-mill was 106%, the latter due to a hang-over in the zinc-boxes, from the previous month, when the extraction was only 75.7%. It is hoped to be able to maintain a more even output from the Maibong tube-mill as soon as all details are arranged in routine order. The February output was \$116,800, a reduction due to lower grade and short month.

PERSONAL

J. B. TYRRELL is in London.

HORACE V. WINCHELL was at Grass Valley this week.

H. G. WRIGHT is superintendent of construction at Anaconda.

W. G. PERKINS has transferred his offices from London to Petrograd.

J. A. AGNEW has returned to London from the United States and Mexico.

WALTER H. WEED was in San Francisco on his way to Mariposa county.

ARTHUR W. JENKS has been examining mines in Mariposa county, California.

H. E. COLLERAN, treasurer of the Seoul Mining Co., was here this week from Denver.

HARRY L. ROSCOE is chemist for the Quincy Mining Co., succeeding ROBERT F. WOOD.

ROBESON T. WHITE sailed from New York on March 18, returning to the Caucasus.

F. J. BRULE is superintendent of construction at the Great Falls zinc plant, Montana.

W. J. KELLY is now in charge of the Douglass mine, in the Pine Creek district, Idaho.

M. R. HULL has left Anaconda to become chief engineer to the Arizona Copper Company.

WILLET G. MILLER is in London in connection with his work on the Ontario Nickel Commission.

EDMUND JESSEN has resigned his position of consulting engineer to the Engels Copper Company.

GORDON R. CAMPBELL, of Calumet, Michigan, secretary of the Calumet & Arizona Mining Co., is in Arizona.

JAMES W. ABBOTT is lying seriously ill at St. Luke's hospital in this city. He is recovering, we are glad to add.

M. YAMASHITA, of the Ikuno mine, operated by Mitsubishi & Co., left on the *Tenyo Maru* for Japan on March 28.

CHARLES J. STAKEL, of the Cleveland-Cliffs Iron Co., is now superintendent of the Republic mine at Republic, Michigan.

EDWIN E. CHASE has taken his son, R. L. CHASE, into partnership, with new offices at 1028 First National Bank building, Denver.

BRENT N. RICKARD, assistant superintendent at the Monterey plant of the A. S. & R. Co., was married in San Francisco last week.

ASSOCIATES OF THE ROYAL SCHOOL OF MINES and other former students in that college of mining are requested to get in communication with E. B. LICHTENBERG, the secretary of the R. S. M. Association, which is an organization founded in 1914 to promote the best interests of the School and of its graduates.

Obituary

CARLOS E. HUSK, surgeon-general of the mining department in Mexico for the American Smelting & Refining Co. died on March 20 at Laredo, Texas, of typhus fever. Dr. Husk had conducted a party of physicians, consisting of Dr. Peter Olitsky and Dr. B. S. Denzer, of Mount Sinai hospital, to Matehuala, to combat typhus among the employees of the company, and a great deal of good had been accomplished. Both Dr. Husk and Dr. Olitsky were stricken with the fever, and were taken to Laredo in the special train with the company employees who had been instructed to leave Mexico. Dr. Husk was very well and favorably known among the mining fraternity in Chihuahua and other parts of Mexico. He had resided in Santa Barbara, Chihuahua, for several years, having charge of the company hospital at that place. He was interested in several mining properties in the vicinity of Santa Barbara. Dr. Husk leaves a wife and a host of friends to mourn his loss.

THE METAL MARKET

METAL PRICES

San Francisco, March 28

| | |
|--|--------|
| Antimony, cents per pound | 14 |
| Lead, 92.5% pure, cents per pound | 9 |
| Pig lead, cents per pound | 8.00 |
| Platinum, soft metal, per ounce | \$88 |
| Platinum, hard metal, 90% iridium, per ounce | \$69 |
| Quicksilver, per flask of 7 lb. | \$2.00 |
| Spelter, cents per pound | 22 |
| Tin, cents per pound | 16 |
| Zinc-dust, cents per pound | 30 |

ORE PRICES

San Francisco, March 28

| | |
|---|--------|
| Antimony, 50% product, per unit of 15, or 20 lb. | \$2.25 |
| Chalcopyrite, 40% copper, 60% iron, California, per ton | 8.00 |
| Magnesite, crude, per ton, FOB | 8.00 |
| Magnesite, plastic, no iron and lime, calcined, ton, 25 lb. | 30.00 |
| Magnesite, refractory, 11% iron, dead-burned, ton | 35.00 |
| Manganese, 50% metal, 8% silica, per ton | 12.00 |
| Tungsten, 80% W ₂ O, per unit of 20 lb. | 70.00 |

A recent statement for 714 tungsten concentrate at Boulder, Colorado, was at the rate of \$5 per unit. The Colorado Tungsten Mines Co. is paying \$20 for 60% product. Later on last week a contract for Boulder advanced the price to \$105. Nine-tenths of mixed grades of wolframite from the Wasp No. 2, Santa Fe Co., realized \$8 per unit.

New York, March 22

Considerable business has been done in antimony ore, sellers making concessions in price. On March 21 the price was around \$2.00 per unit.

Spelter, 92.5% pure, with a demand and \$5 per unit has been reported.

EASTERN METAL MARKET

(By wire from New York.)

Market for copper is fairly active and firm, lead is firm but spelter is steady but dull.

SILVER

Below are given the average New York quotations, in cents per ounce, of fine silver.

| Date | Average week ending |
|---------|---------------------|
| Jan. 28 | Feb. 16 |
| Feb. 29 | Mar. 13 |
| Mar. 31 | Apr. 6 |
| Apr. 13 | Apr. 20 |
| Apr. 27 | May 4 |
| May 11 | May 18 |
| May 25 | June 1 |

Monthly averages

| 1914 | 1915 | 1916 | 1914 | 1915 | 1916 |
|------------|-------|-------|-------------|-------|-------|
| Jan. 27.58 | 28.87 | 26.76 | July 24.90 | 27.52 | 29.00 |
| Feb. 27.58 | 28.87 | 26.76 | Aug. 24.35 | 27.11 | 29.00 |
| Mar. 28.11 | 28.25 | 26.74 | Sept. 23.75 | 26.77 | 29.00 |
| Apr. 28.11 | 28.25 | 26.74 | Oct. 23.12 | 26.40 | 29.00 |
| May 28.11 | 28.25 | 26.74 | Nov. 22.49 | 26.08 | 29.00 |
| June 28.11 | 28.25 | 26.74 | Dec. 21.87 | 25.76 | 29.00 |

London, March 28.—The London market for silver is quiet and steady. The price of silver is 25s. 6d. per ounce. The price of silver is 25s. 6d. per ounce. The price of silver is 25s. 6d. per ounce.

London, March 28.—The London market for silver is quiet and steady. The price of silver is 25s. 6d. per ounce. The price of silver is 25s. 6d. per ounce.

COPPER

Prices of sale to date, New York, in cents per pound.

| Date | Average week ending |
|---------|---------------------|
| Jan. 28 | Feb. 16 |
| Feb. 29 | Mar. 13 |
| Mar. 31 | Apr. 6 |
| Apr. 13 | Apr. 20 |
| Apr. 27 | May 4 |
| May 11 | May 18 |
| May 25 | June 1 |

Monthly averages

| 1914 | 1915 | 1916 | 1914 | 1915 | 1916 |
|------------|-------|-------|-------------|-------|-------|
| Jan. 14.21 | 15.70 | 14.00 | July 12.20 | 13.60 | 15.00 |
| Feb. 14.46 | 14.88 | 14.92 | Aug. 12.34 | 13.75 | 15.00 |
| Mar. 14.11 | 14.88 | 14.92 | Sept. 11.92 | 13.16 | 15.00 |
| Apr. 14.11 | 14.88 | 14.92 | Oct. 11.10 | 12.50 | 15.00 |
| May 14.11 | 14.88 | 14.92 | Nov. 11.75 | 13.18 | 15.00 |
| June 13.97 | 14.75 | 14.92 | Dec. 12.75 | 13.67 | 15.00 |

Inspiration will pay its initial dividend of \$1.25 per share on May 1. Tennessee Copper has declared its quarterly of 70¢ per share. Grand Consolidated pays \$1.50 on May 1. Utah Consolidated pays 75¢ on April 10.

LEAD

Lead is quoted in cents per pound, New York delivery

| Date | Average week ending |
|---------|---------------------|
| Jan. 22 | Feb. 16 |
| Feb. 23 | Mar. 13 |
| Mar. 14 | Apr. 6 |
| Apr. 7 | Apr. 20 |
| Apr. 21 | Apr. 27 |
| Apr. 28 | May 4 |
| Apr. 29 | May 11 |
| Apr. 30 | May 18 |
| May 1 | May 25 |
| May 2 | June 1 |

Monthly averages

| 1914 | 1915 | 1916 | 1914 | 1915 | 1916 |
|-----------|------|------|------------|------|------|
| Jan. 4.11 | 3.73 | 5.95 | July 3.89 | 5.59 | 6.30 |
| Feb. 4.02 | 3.83 | 6.23 | Aug. 3.86 | 4.67 | 6.30 |
| Mar. 3.91 | 4.01 | 6.23 | Sept. 3.82 | 4.62 | 6.30 |
| Apr. 3.86 | 4.21 | 6.23 | Oct. 3.69 | 4.62 | 6.30 |
| May 3.90 | 4.21 | 6.23 | Nov. 3.68 | 5.15 | 6.30 |
| June 3.90 | 5.75 | 6.23 | Dec. 3.80 | 5.31 | 6.30 |

On the basis of 80% metal, ore at Joplin is selling at \$100 per ton.

The F. S. S. & R. Co. is said to have a large stock of lead which will be sold at high prices. In 1915 the company produced nearly 90,000,000 lb. of metal, and in 1916, 100,000,000 lb. is expected.

QUICKSILVER

The primary market for quicksilver is San Francisco, California being the largest producer. The price is fixed in the open market, according to quantity. Prices, in dollars per flask of 75 pounds:

| Date | Week ending |
|---------|-------------|
| Jan. 28 | Feb. 16 |
| Feb. 29 | Mar. 13 |
| Mar. 31 | Apr. 6 |
| Apr. 13 | Apr. 20 |
| Apr. 27 | May 4 |
| May 11 | May 18 |
| May 25 | June 1 |

Monthly averages

| 1914 | 1915 | 1916 | 1914 | 1915 | 1916 |
|------------|-------|--------|-------------|--------|--------|
| Jan. 29.25 | 51.90 | 232.00 | July 37.50 | 95.00 | 235.00 |
| Feb. 29.25 | 60.00 | 235.00 | Aug. 36.00 | 93.75 | 235.00 |
| Mar. 29.25 | 78.00 | 235.00 | Sept. 36.25 | 91.00 | 235.00 |
| Apr. 29.25 | 77.50 | 235.00 | Oct. 33.00 | 92.90 | 235.00 |
| May 29.25 | 75.00 | 235.00 | Nov. 35.00 | 101.50 | 235.00 |
| June 29.25 | 90.00 | 235.00 | Dec. 33.10 | 123.90 | 235.00 |

A good supply of quicksilver is said to be coming in from Mexico.

New Idria reports an output of 6250 flasks in 1915, averaging \$74 each, a decrease of 300 flasks. Of the \$459,028 profit there was paid \$150,000 in dividends. The previous year left a deficit of \$15,010. Prospects for 1916 are good.

ZINC

Zinc is quoted as spelter, standard Western brands, New York delivery, in cents per pound.

| Date | Average week ending |
|---------|---------------------|
| Jan. 22 | Feb. 16 |
| Feb. 23 | Mar. 13 |
| Mar. 14 | Apr. 6 |
| Apr. 7 | Apr. 20 |
| Apr. 21 | Apr. 27 |
| Apr. 28 | May 4 |
| Apr. 29 | May 11 |
| Apr. 30 | May 18 |
| May 1 | May 25 |
| May 2 | June 1 |

Monthly averages

| 1914 | 1915 | 1916 | 1914 | 1915 | 1916 |
|-----------|-------|-------|------------|-------|-------|
| Jan. 5.14 | 6.20 | 18.21 | July 4.75 | 20.54 | 22.00 |
| Feb. 5.22 | 6.05 | 19.39 | Aug. 4.75 | 11.17 | 22.00 |
| Mar. 5.17 | 8.40 | 19.39 | Sept. 5.16 | 13.14 | 22.00 |
| Apr. 4.98 | 17.03 | 19.39 | Oct. 4.75 | 14.05 | 22.00 |
| May 4.91 | 17.03 | 19.39 | Nov. 5.01 | 17.20 | 22.00 |
| June 4.84 | 22.20 | 19.39 | Dec. 5.40 | 16.75 | 22.00 |

On the basis of 60% metal, ore at Joplin is selling at \$2 to \$11 per ton, calamine, 60% metal, \$70 to \$85.

A zinc retort plant, to reduce flotation concentrate, is to be erected by J. E. Hibdt, of Tulsa, Oklahoma.

TIN

Prices in New York, in cents per pound.

| Date | Average week ending |
|---------|---------------------|
| Jan. 22 | Feb. 16 |
| Feb. 23 | Mar. 13 |
| Mar. 14 | Apr. 6 |
| Apr. 7 | Apr. 20 |
| Apr. 21 | Apr. 27 |
| Apr. 28 | May 4 |
| Apr. 29 | May 11 |
| Apr. 30 | May 18 |
| May 1 | May 25 |
| May 2 | June 1 |

Monthly averages

| 1914 | 1915 | 1916 | 1914 | 1915 | 1916 |
|------------|-------|-------|-------------|-------|-------|
| Jan. 37.85 | 24.40 | 11.76 | July 21.60 | 27.38 | 33.00 |
| Feb. 35.75 | 37.23 | 42.50 | Aug. 20.20 | 34.27 | 33.00 |
| Mar. 38.10 | 48.76 | 42.50 | Sept. 22.10 | 33.12 | 33.00 |
| Apr. 36.10 | 48.25 | 42.50 | Oct. 30.40 | 33.00 | 33.00 |
| May 33.29 | 39.28 | 42.50 | Nov. 33.51 | 39.50 | 33.00 |
| June 30.72 | 40.26 | 42.50 | Dec. 33.60 | 38.71 | 33.00 |

Tin is firm at 49.50 cents.

Eastern Metal Market

New York, March 22.

The situation in lead continues to dominate interest of the market. The independent producers are getting 8c. and over, New York, while the A. S. & R. Co. here continues to quote 7c. Its quotation is nominal, however, as it will not sell at that price. It is offering April shipment on the basis of its own average price for the month, and not on the price it may quote from day to day. Its latest move is supposed to be in furtherance of its desire to check the runaway market. The domestic and foreign demand is heavy. Copper is firm, but quiet again, after a brief spurt of activity. New England consumers still find difficulty in getting the metal they have purchased, because of the freight embargoes. Zinc is also quiet after a few days of buying, during which prices rose again. The tin situation is much easier because of fairly large arrivals in the past few days. Antimony is scarce for immediate delivery, and the price is stronger. Aluminum is quiet and unchanged.

The great difficulty today is in finding metals which can be delivered promptly and this fact, together with the abnormally high prices, is imposing a strain on consumers, of which they are complaining. It will be realized that they would suffer a heavy loss should there be any substantial decline in the metals they use, especially if they have contracted far into the future. This does not matter so much with the War business, but industrial consumers feel that they are in danger and are worried.

COPPER

After a spurt of activity which lasted but two or three days, in which a moderate tonnage was taken, the market is dull again, but slightly firmer. Near-by metal is easier to obtain, but most of the interest continues to be in forward positions, consumers being well supplied so far as their immediate needs are concerned. June and July deliveries of electrolytic range from 26.50 to 27c., while prompt is quoted at about 28c. Some sellers are asking 27.50c., cash, 30 days, but this is because they have little to offer. Lake, for July and later delivery, is quoted at 27.12c. Activity in copper has been retarded by the freight situation in New England, some of the mills in the Naugatuck valley having shut-down for lack of materials, while others have curtailed operations. In one case, a carload of Lake copper was shipped from Buffalo, N. Y., to a point in New England by express at an extra cost to the consumer of several hundred dollars. The producers show firm faith in the future, and are holding to their quotations, paying little heed to concessions offered by second-hands. The London electrolytic market has stood at £136. European statistics received here on March 17 show decreases in the stocks of copper in the United Kingdom and in France. The figures show that on the 15th they totaled 7988 tons, against 9811 tons on February 29, and 8777 tons the 15th. Exports up to and including March 21 amounted to 12,567 tons.

ZINC

From March 14 to 21 quotations for zinc climbed upward under the stimulus of fairly good buying, especially for April, May, and June delivery. Spot, which is extremely scarce, sold at 18.25c., New York; March commanded 17.75c.; April, 17.25c.; May, 16.75c.; and June, 16.25c. The London market is stronger and has imparted some of its strength to the New York market. The spot quotation at London on the 21st was £92. As in the case of copper the market has been adversely affected by the railroad-freight conditions in New England, consumers not seeking to buy more metal when they cannot get what they already have bought. Viewed in its entirety, the week has not presented many features of interest, and to a large extent the market is a waiting one.

The quotation for sheet-zinc is unchanged at 25c., in carload lots, f.o.b. mill, 8% off for cash. Exports totaled 1295 tons.

LEAD

The situation in this metal is mixed and without precedent. Prices are hard to determine, when it is desired to give a definite figure. The A. S. & R. Co. is nominally quoting 7c., New York, but it is not selling for March delivery at that price. On April deliveries it does not quote, but will accept business on the basis that the price to be paid will be the average of its own quotations for that month. This lends uncertainty to what the buyers will be called on to pay, and perhaps explains why so many of them are paying the premium prices demanded by independent producers. The latter have been getting up to 8c., New York, and over. Up to the present time, and since the quotations of the outsiders exceeded those of the leading interest, it seemed fair to give as the market, the average of the A. S. & R. Co. quotations and those of the independents, but since the big producer is not selling, except under the arrangement referred to, it seems more fair to quote the prices of the independents, and in the future this will be done as long as they do business at prices over those of the A. S. & R. Co. So far as prompt business goes, the quotations of the big interest are pronounced as fictitious by the trade. It is following its course with a view of checking the upward tendency of the market, but so far it has failed. Russia and Japan have continued heavy buyers, the latter in particular being eager to get the metal. Sales have been made at 8 to 8.12c., delivered at Pacific ports. On March 16 sales were made at 8 to 8.25c. f.o.b., smelter, and on the following day there was business on the basis of 8c., New York. One inquiry which came out this week called for 1000 tons for export, and in this case one producer refused to quote on the ground that it was his duty to care first for domestic consumers. The demand has continued heavy, munitions' needs being behind most of it. At the present time the market is strong, and there is talk of 10c. lead. Exports of this month, up to and including the 21st, totaled 3473 tons. The London market is strong at £36. The high price now prevailing in New York has brought out some re-sale lead, a few consumers being among those willing to sell.

TIN

The strong market for spot tin has broken under the influence of larger arrivals, some of which were unexpected. Up to yesterday the month's imports totaled 2378 tons. The steamer *Suruqa*, from Singapore, arrived on the 20th with 1135 tons, and this arrival alone was enough to ease the market. In addition, however, there were other arrivals of 100, 215, and 400 tons, as well as some smaller ones, and in the week spot tin dropped from 54 to 49.62c., the quotation of the 21st. The week has been a rather quiet one, although on the 20th between 300 and 400 tons was taken at 50.50c. The quantity now afloat is 5450 tons. In March, at least, there is now no danger of any shortage, and somewhat easier prices may be expected. The situation at London, in the matter of shipping licenses, continues uncertain.

ANTIMONY

Chinese and Japanese antimony is quoted at about 45c., duty paid. Spot metal is extremely scarce, and deliveries are uncertain because of the upset freight conditions. For instance, a buyer expected to get some antimony from the Far East by way of a Southern railroad, but it came by way of the Canadian Pacific, and when it reached the northern part of New York State, the New York Central Railroad refused to handle it. Japanese sellers are reported to have made some concessions in their prices. Forward shipments are quoted at 34c., in bond. Needle antimony is quoted at 23.50 to 24 cents.

BOOK REVIEWS

FlotATION PROCESS. Compiled and edited by T. A. Rickard. P. 364. Ill., Index. For sale by MINING AND SCIENTIFIC PRESS. Price, \$2.

It is fairly safe to say that flotation is in course of producing a greater revolution in the world of metallurgical method than any other process that has been introduced since the cyanide process for the extraction of gold and silver. Not only is it exercising the minds of those interested in the recovery of copper, lead, and zinc, and other base metals, from their ores, but it is even encroaching on the territory of gold and silver, where the cyanide process has for many years been almost impregably entrenched. The appearance therefore of this publication is particularly appropriate at this time. The book is a compilation by the Editor of the MINING AND SCIENTIFIC PRESS of all the articles that have appeared on the subject in that paper during the past eight or nine months.

The volume starts with a useful glossary of terms employed in the process, and the opening chapter consists of a paper by T. A. Rickard presented to the Canadian Mining Institute at the March 1916 meeting. This paper, though the latest of all in chronological order, is intended to act as a general introduction to the subject, and it answers this purpose admirably, discussing in turn the physics of the process, the various methods and devices for applying it, the history of its inception and development as illustrated by the various patents secured to protect it, and commenting on the psychological factors involved in its career. With the exception of this opening chapter all the articles follow one another in the order of their publication, an arrangement adopted to facilitate the linking together in the mind of the reader of the various ideas and arguments as they were consecutively developed from week to week by the different writers.

A large proportion of the articles consist of attempts to formulate a workable theory to account for the phenomena displayed, and though this aspect of the matter may seem to some readers of less practical importance than that of the commercial results of the process and the *modus operandi* of tests and working plants, yet those who are occupying themselves in the business of theoretical research are performing a very real and practical service for the industry, because up to the present experimental work in the application of the process has been almost entirely empirical or, in other words, has been conducted on the "hit or miss" method. It is obvious that if definite rules could be formulated that would determine beforehand, if only approximately, the methods and conditions necessary for any given class of ore, progress on the commercial side would be much more rapid.

In this effort to get at underlying principles it is inevitable that divergent views should be freely expressed, but when this leads to friendly criticism and discussion, as is the case in the present instance, a real advance in the knowledge of the subject is likely to result.

The two articles by T. A. Rickard entitled "What is Flotation?" were designed to set forth in simple language for the benefit of the uninitiated the somewhat meagre information at that time available, and the fact that the author was himself *in statu pupillari* as regards flotation does not detract from the usefulness of the work. Even if some of his statements do not quite square with the theories of the experts, his fearless expression of them has succeeded in causing some, at least, of these experts to come forward and expound their views to the public, and has aroused an interest in the fundamentals of the process that is not likely to subside for some time to come.

The discussion thus started by the Editor of the MINING AND SCIENTIFIC PRESS has elicited a number of valuable contributions to the theory of the process, among which those of

Messrs. Durell, Ralston, Norris, and Coghill seem especially suggestive. The first named propounds a theory that gas bubbles mechanically held in a pulp are powerless to float mineral particles, and that to be effective the gas must go into solution in the liquor under such conditions that it is liberated, or brought into being as a bubble, at the surface of the particle it is destined to float. This is a possible hypothesis, but the arguments he adduces seem hardly conclusive, and evidence to the contrary as cited from the case of Minerals Separation, Ltd. v. Miami Copper Co. in a communication by James A. Block. He is also committed to a theory that gases occluded in the mineral particles play a vital part in the physics of flotation, a view that is strongly contested by Mr. Ralston, who offers two alternative hypotheses, one based on the action of interfacial tensions, and the other on the electrical charges carried by suspended particles. This electrical theory of flotation is further advocated by Thomas M. Hains and discussed in more detail in a paper by F. A. Fahrenwald. The phenomena and laws of surface tension are set forth in two instructive articles by Will H. Coghill; and Dudley H. Norris has a stimulating dissertation on 'Molecular Forces in Flotation.'

There is also an excellent article by 'an occasional contributor' on the 'Effects of Soluble Components of Ore on Flotation,' discussing the emulative effect on the efficiency of the circulating mill-water of soluble substances derived from the ore. Most of the facts given have been recognized for some time by practical workers but have not hitherto been published.

Contributions to the book describing actual working conditions on flotation mills that are in the producing stage are singularly scarce, but there are valuable notes on the principles of testing, the use and functions of various oils, and the disposal of flotation concentrate both by smelting and cyanidation. Regarding the latter point, which is dealt with in a careful and elaborate paper by Charles Butters and J. E. Clennell, the reader should not assume that the conclusions therein arrived at are necessarily applicable in general to all concentrates recovered by flotation because the writers seem to have chosen an unusually difficult ore for their tests, when regarded from the point of view of the cyanide process.

Among the most valuable chapters in the book are the two entitled 'Testing Ores for the Flotation Process,' by O. C. Ralston and Glenn L. Allen, wherein the writers explain in detail the laboratory testing of ores by the various methods and applications of flotation. This may be considered the latest and most reliable information published and the student just beginning experimental work in the process will find it invaluable. There is one department of the subject on which fuller information and explanation would have been welcome, and that is oils, their characteristics and uses. This deficiency is, however, made good to some extent in the chapter on 'Oils Used in the Flotation Process,' by another 'occasional contributor.'

The Editor is to be congratulated on having been able to elicit such a fund of varied and valuable information on the subject in spite of the tendency toward mystery and secrecy that has enveloped it for so long. It seems difficult to believe that the restrictions imposed by the Minerals Separation Co. against full and free discussion in the press and elsewhere are really rendered necessary by the exigencies of patent litigation, and the Editor of the MINING AND SCIENTIFIC PRESS in the course of his articles has repeatedly protested against the embargo this company has attempted to lay on useful knowledge. The futility of such a policy in the long run is evidenced by the appearance of this volume, which, although it comprises almost the only literature on the subject (with the exception of the book by Theodore J. Hoover published nearly four years ago) will no doubt be followed by others from time to time, to the great and lasting benefit of the individual metallurgist and the mining community at large.—E. M. H.

HYDRAULIC TABLES. By Joseph H. Harper. P. 192. Ill. D. Van Nostrand Co., New York. For sale by MINING AND SCIENTIFIC PRESS. Price, \$2.

This book is designed to lighten the labors of the user of hydraulic formulae. The main body of the tables is divided into four parts, for flow in pipes, by D'Arcy's and by Kutter's formula, flow in open rectangular channels by Kutter's formula, flow in open trapezoidal channels by Bazin's and by Kutter's formula, and flow in egg-shaped conduits by Kutter's formula. The latter table is divided into three parts, for flow when running one-third full, two-thirds full, and full. All the tables are computed for several different conditions of roughness. Besides these tables there are others with considerable miscellaneous data, and also a discussion of the various formulae. An appendix contains a number of charts showing by means of curves, the different results obtained by the use of the different formulae.

INDUSTRIAL LEADERSHIP. By H. L. Gantt. P. 128. Ill. Yale University Press, New Haven, 1916. For sale by MINING AND SCIENTIFIC PRESS. Price, \$1.

The five lectures comprising this book were heard by the senior class of the Sheffield Scientific School in 1915. The methods of industrial leadership are based on the system of scientific management evolved by Taylor, with whom the author was a co-worker; the chief doctrine of this school is that efficient management of labor increases profits and wages.

A novel point brought out is that an impartial study of the Lawrence strike showed that the labor leaders had a much better understanding of the problems involved than the employers, and that no permanent industrial peace can be hoped for until the employers are better educated. The great profits of the Ford automobile are held to disprove the old theory that great profit can only be had by high prices. A fault of the book is the failure to consider the strenuous objections of the trade unions to scientific management.

THE CANADIAN MINING MANUAL FOR 1915. Edited by Reginald E. Hore, editor of the *Canadian Mining Journal*. P. 406. Ill. Published by Mines Publishing Co., 263 Adelaide St., W. Toronto. Can be obtained through the MINING AND SCIENTIFIC PRESS. Price, \$2.

The editor states in a preface to Canadian readers that "one of the main objects of the publication of this book is to carry into other countries reliable information concerning the minerals and mines of Canada." The total mineral production of the Dominion in 1915 was \$138,513,750, of which metallic products were \$77,046,982; the similarity in the relative importance of the productions of nickel, gold, copper, and silver is noteworthy; nickel was \$20,423,348; gold \$18,936,971; copper \$17,726,307; silver \$14,088,397. Among the non-metallic products, asbestos was \$3,491,450; coal \$31,957,757; pyrites \$1,028,678. The chapter on Canada in general is contributed by John McLeish, chief of the Division of Mineral Resources and Statistics at Ottawa; the chapter on Quebec by Theo. C. Denis, superintendent of mines for that province; the chapter on Ontario by T. W. Gibson, deputy minister of mines at Toronto; J. T. Sterling writes on mining in Alberta; and F. W. Gray on the coal trade of Nova Scotia. Of most valuable interest is the latter half of the book, devoted to an alphabetical list of mining companies operating in Canada, with a brief description of each, giving address of the head office, situation of the mine, production and treatment of the ore, names of the officers and staff, and other pertinent details when the importance of the operation warrants it. The companies listed include everything in mining from the Atlantic Grindstone Co. of Nova Scotia to the Yukon Gold Co. of the Yukon. The book is more carefully edited than is usual with publications embracing such a variety of information, and Mr. Hore is to be congratulated on a difficult job well done.

COMPANY REPORTS

MASS CONSOLIDATED COPPER CO.

Results at the Mass mine in Michigan in 1915 were much better than in the previous year. Cash assets increased \$167,473. Development covered 4728 ft. Reserves are up to the normal quantity. The mill was improved and added to. Seven lodes contributed to the output. The mill treated 323,335 tons of ore, yielding 4,638,452 lb. refined copper, equal to 14.35 lb. per ton.

DALY-JUDGE MINING CO.

The report of O. N. Friendly, general superintendent of this Park City, Utah, company, to the general manager, G. W. Lambourne, covers the year 1915.

Development on three veins totaled 12,017 ft. to a depth of 1600 ft. The underground equipment and haulageways were considerably improved. An electric-hoist of 2500-ft. capacity, at 2200 ft. per min., is now being installed. A steel head-frame was erected. The mine was never more encouraging as to prospects for ore.

Crude ore sold amounted to 5809 tons, worth \$23.93 per ton. The mill treated, by water concentration and oil flotation, 63,935 tons, yielding 10,828 tons of lead and 7169 tons of zinc concentrates. The output was 644,935 oz. silver, 642 oz. gold, 10,954,273 lb. lead, 9,775,097 lb. zinc, and 2,984,875 lb. copper, sold for \$1,041,414. Dividends (6) amounted to \$300,000. The balance is \$678,907.

HOMESTAKE MINING CO.

The report of this well-known company, operating in South Dakota, covers the past year. As has been the custom in the past, the remarks of the new superintendent, Richard Blackstone, are brief, as the following will show:

"Operations at the mine and mills of the company, for the calendar year 1915, have been continuous. The erection of the new equipment [ascribed from time to time by our correspondent at Deadwood.—EDITOR] has been about completed and will soon be in operation. The Pocahontas mill has been completely re-built during the year. One-half of the Amicus mill has been re-built and rapid progress is being made toward its completion. These repairs were made with no material stoppage of milling capacity. The Columbia ditch has been re-built with permanent vitrified pipe. The dead-work, or development in the mine, has been carried on without interruption, having in view the outlining of areas of new ore-bodies and determination of the value of the same. During the year, there was excavated 1001 ft. of raises and 17,114 ft. of drifts. Preparations have been completed for sinking the Ellison shaft to the 2000-ft. level. The mine and the reduction plants are in first-class condition. The measured ore reserves are large and sufficient to supply the mills for many years."

During 1915 there was treated 1,573,822 tons of ore, realizing an average of \$4.08482 per ton. The revenue from 246 bars of bullion was \$6,428,787. Sale of wolframite netted \$19,237. Including \$897,596 brought forward from 1914, and sundry income, the total revenue was \$7,423,379.

Some of the larger expense items were as follows: operation of mills, \$381,701; operation of shafts, \$369,355; mining, \$2,050,151; machine-shop, \$102,367; blacksmith-shop, \$69,413; foundry, \$96,741; cyanidation, \$302,622; taxes \$232,967; water, \$113,623; general expense, \$115,089; central steam plant, \$161,947; and hospital and recreation hall charges, \$62,369. The service rendered by the blacksmith-shop, foundry, and machine-ship was charged to mine and mill accounts, and is included therein.

Dividends totaled \$2,210,208 on 251,160 shares. The balance to profit and loss account was \$1,032,933. Costs, including everything, totaled \$2.6561 per ton.

RECENT PUBLICATIONS

LABORATORY TESTS OF A CONSOLIDATION LOCOMOTIVE. By E. C. Schmidt, J. M. Snodgrass and R. B. Keller. Bulletin 82. P. 129. Illustrated. University of Illinois Engineering Experiment Station, Urbana, 1915. Price, 65 cents. Notes of value to railroad men.

WYOMING AND McDOWELL COUNTIES, WEST VIRGINIA. By Ray V. Hennen and Robert M. Gawthrop. P. 783. Ill. maps, index. West Virginia Geological Survey, Morgantown, 1915. This detailed county report covers one of the principal areas of the great Pocahontas or smokeless coalfields of West Virginia, giving a complete account of each coal bed, with analyses, estimates of unmined tonnage, and topographic and structural maps showing the elevation, dip, and strike of the principal coal beds, including the famous No. 3 Pocahontas, covering the Counties of Wyoming and McDowell, the latter leading every other county in this State in the production of coal of the highest grade by several million tons annually. Price, with case of maps, delivery charges paid by the Survey, \$2.50, but for combination price with other publications, see general circular of publications. EXTRA copies of geologic maps, \$1 each, and of the topographic map, 50 cents each.

Department of Mines, Ottawa, Canada, 1915.

PRODUCTION OF COAL AND COKE IN 1914. P. 39. A total of 27,571 men mined 13,637,529 tons of coal worth \$2.45 per ton. The coke output was 1,915,253 tons.

PRODUCTION OF IRON AND STEEL IN 1914. P. 35. The pig-iron made was worth \$19,002,856.

COPPER DEPOSITS OF THE EASTERN TOWNSHIPS OF QUEBEC. By J. Austen Bancroft. P. 295. Ill. map, index. Department of Mines, Quebec, 1915. An interesting investigation into a number of deposits, some of which might develop into fair producers.

SUMMARY REPORT OF THE MINES BRANCH OF THE DEPARTMENT OF MINES FOR 1914. P. 232. Ill. maps, charts, index.

A lot of useful data is contained in this bulletin.

PRODUCTION OF CEMENT, LIME, CLAY PRODUCTS, STONE, AND OTHER STRUCTURAL MATERIALS IN CANADA IN 1914. By John McLeish. P. 69.

The total value was \$26,009,227, a decrease of 15.5 per cent.

U. S. Geological Survey, Washington, D. C., 1915:

ANTIMONY, ARSENIC, BISMUTH, SELENIUM, AND TELLURIUM IN 1914. By Frank L. Hess. P. 31.

COBALT, MOLYBDENUM, NICKEL, TIN, TITANIUM, TUNGSTEN, RADIUM, URANIUM, AND VANADIUM IN 1914. By Frank L. Hess. P. 24.

MINERAL PRODUCTION OF THE UNITED STATES IN 1914. A summary. By H. D. McCaskey. P. 69. Chart.

Some useful information is contained in these bulletins.

A RECONNAISSANCE FOR PHOSPHATE IN THE SALT RIVER RANGE, WYOMING. By G. R. Mansfield. Bulletin 620-O. P. 19. Maps. **GEOLOGY AND OIL PROSPECTS OF CUYAMA VALLEY, CALIFORNIA.** By Walter A. English. Bulletin 621-M. P. 25. Maps.

GASOLINE. Letter from the Secretary of the Interior, transmitting certain information, in response to a Senate resolution of January 5, 1916, relative to the production, consumption, and price of gasoline. P. 27. Chart.

Gasoline production last year was 41,600,000 bbl., of which 6,500,000 bbl. was exported, increases of 6,685,000 bbl. and 1,500,000 bbl. respectively. There were practically no stocks at the beginning of 1916, against 2,000,000 bbl. a year ago. The big rise in price can be traced to causes related to supply and demand.

INDUSTRIAL NOTES

E. P. Worden, formerly of Fred M. Prescott Steam Pump Works, Milwaukee, has been appointed chief engineer for Henry R. Worthington, Harrison, New Jersey.

E. C. Reybold, Jr., for a number of years connected with the Hendrie & Bolthoff Mfg. & Supply Co. of Denver, is now with the Dorr CYANIDE MACHINERY Co., Denver, being secretary of this company.

P. P. Bourne, formerly chief engineer of Blake & Knowles Steam Pump Works, East Cambridge, Massachusetts, is again associated with the INTERNATIONAL STEAM PUMP Co. in connection with special engineering work, at the main office, 115 Broadway, New York.

The DENVER QUARTZ MILL & CRUSHER Co., Denver, has just received a repeat order from the Luckie 2 Tungsten Co., at Boulder, Colo., for a No. 1 Denver quartz mill. The constantly increasing price of tungsten is causing a heavier output from the mines near the Luckie 2's mill, and necessitates this additional equipment. Last December the company purchased a No. 1 quartz mill.

The Bunker Hill & Sullivan Mining & Concentrating Co. recently awarded a contract to the TRAYLOR ENGINEERING & MANUFACTURING Co. of Allentown, Pennsylvania, for three silver-lead blast-furnaces, 48 in. wide by 180 in. long at the tuyeres, having a smelting-column of approximately 20 ft. 6 in. These furnaces are equipped with a double tier of jackets, the lower ones being provided with Traylor patented welded tuyeres. This contract was awarded the Traylor company solely on the superior design of its water-jackets.

The present expedition of the United States Army into Mexico brings to light an interesting condition governing preparedness in our ability to quickly mobilize. THE WHITE Co. furnished 28 motor-trucks together with volunteer drivers and mechanics on 24 hours' notice, taking the trucks from stock of those regularly sold for mining work. These form the first regular Truck Company of the Army. In the event of an additional call, many similar trucks could be furnished and those in use in mining districts might be requisitioned.

Electric mine-hoists are described and illustrated in a splendidly prepared bulletin, No. 15, of the LIDGERWOOD MANUFACTURING Co., New York. The publication is 9 by 12 in., covering 30 pages of heavy smooth paper. Since 1890 the firm has been developing these hoists of all sizes, with a view to safety and continuous operation. The strain on hoist-motors is of great importance, therefore they have been carefully studied. The bulletin shows single and double hoists for all purposes, a gathering hoist, indicators, sheaves, and cages. A page is devoted to data required for estimating on electric mine-hoists.

Bulletins 154 and 110 have just been issued by the A. S. CAMERON STEAM PUMP WORKS, 11 Broadway, New York. The former is devoted to Cameron centrifugal pumps. Sectional views are used to illustrate both the single and double-suction open-impeller types, and the booklet gives tables of capacities, speeds and horse-powers. The other publication covers the Cameron line of duplex-pumps, including both piston and plunger types, with single and compound steam-cylinders for general service, boiler-feeding, tank-service, water-works, hydraulic-elevators, automatic-pumps and receivers, brewery, quarry and mining work. The catalogue is well illustrated, and also contains tables of sizes and capacities. Copies are free on request.



EDITORIAL



T. A. RICKARD, Editor

ANTIMONY continues in demand. In San Francisco \$2.50 per unit is offered for 40% ore, the price rising to \$3 per unit for over 60% ore.

CARRANZA paper currency is quoted at 2 cents on the dollar. This indicates the improbability of war with anybody whose dollar is quoted at 100 cents.

FULLY a dozen new magnesite kilns have been built in California during the last two months. This State possesses deposits of magnesite yielding both the more and the less fusible varieties required for furnace-lining and tiling respectively.

TESTS made during 1915 on a working scale (4407 tons) in the experimental mill of the Copper Queen Consolidated Mining Company have demonstrated that rock containing 1.3% of copper can be called 'ore' and it is probable that 1% material can be exploited profitably, by aid of water-concentration and flotation.

ACCORDING to the *Metal Bulletin*, published in London, arrangements have been completed, with the approval of the British government, for the complete and perpetual elimination of the German shareholdings in the firm of Henry R. Merton & Co. Mr. Henry Gardner becomes head of the newly constituted business, which is now entirely divorced from the Frankfurt Metallgesellschaft.

NOT long ago we commented on the fact that the Butte & Superior Copper Company did not produce copper, but zinc. We note now that a circular has been sent to the stockholders proposing to change the name. Whether 'zinc' is to be substituted for 'copper,' or whether the company will give itself a chance of digging gold, tungsten, or some other good thing without further nominal impropriety is not stated.

QUICKSILVER is being won from alluvial deposits on the Klamath river, in Siskiyou county, the cinabar ore from the sluices containing 4% mercury. The high price has prompted re-treatment of dumps at old lode mines in California, like the Napa Consolidated, where stuff containing only 0.12 or 1% is being sluiced and concentrated on Deister roughing tables. The New Idria also is using water concentration.

NEW YORK is taking from Boston much of its former importance as a centre of mining speculation. United States Smelting has now found an official market

on the New York Exchange, following in the recent wake of American Zinc, Butte & Superior, Alaska Gold, and Greene-Canaan. Seven mining companies, aggregating over 3,000,000 shares have thus been added to the New York list, at the expense of Boston. The total dealings during a couple of months in three of these stocks on Wall Street has been equal to half of all the trading on the Boston exchange. Centralization is convenient, but we are sorry to see Boston lose its importance as a centre for the business of mining.

DISEASE is not a pleasant subject but occasional discussion of it is necessary in order to promote sanitation. In this issue we publish an article by Mr. Rush M. Hess on a disease to which miners appear to be particularly subject, namely, hookworm. We believe that the information given by Mr. Hess in regard to the detection and prevention of the malady will prove of the greatest practical benefit to miners. We urge every superintendent to read the article carefully, for it affects the welfare of his men and their efficiency as workers.

TO what proportion the business of patenting has grown is made clear by the report of the Commissioner of Patents for the year 1915. This states that \$2,022,141 was received for applications and \$211,045 for copies, the total receipts being \$2,290,773, as against a total expenditure of \$2,053,442, leaving a surplus of \$237,331. The total surplus earnings of the Patent Office now deposited with the Treasury of the United States amounted to \$7,785,506 on December 31, 1915. During last year 40,321 patents were issued to citizens of this country and 4334 to residents in foreign countries. Applications have increased from 21,638 in 1875 to 70,069 in 1915, but the maximum to date was recorded in 1912, when the number was 70,976. Since 1871 the United States government has granted 1,012,595 patents and the rest of the so-called civilized world has granted 1,293,064, from which it may be inferred that patenting is a luxury highly developed in this country.

CORDIAL support should be given to the effort being made by the Chamber of Commerce of the United States to enlist public interest in commercial preparedness for the intensified competition for trade in foreign markets that is sure to be one of the consequences of the War. Additional commercial attachés and trade commissioners are demanded, but we hope that the question of quality will not be subordinated to quantity. Men of unusual intelligence and adequate linguistic versatility are required for such purposes. They are necessary as

collectors of information and scouts for markets. In London and Paris an earnest effort is being made to organize for post bellum trade. President Wilson recognizes the timeliness of organized effort, for, when addressing Congress in December, he referred to "the day of readjustment and recuperation" that must follow the European war, and mentioned "the necessary instrumentalities of information." Let us prove that a democracy can organize itself, for peace at least, as well as any autocracy.

CORNISH mining has been heartened by the discovery of a rich ore shoot in the East Pool mine. This old property was re-opened on the initiative of Mr. W. J. Loring, of the firm of Bewick, Moreing & Co., guided by a geological examination made by Mr. J. Malcolm MacLaren. The discovery was not due to mere luck, but to a careful study of a series of faults and logical reasoning therefrom. It is only fair to add that Mr. Loring's attention to East Pool was drawn by Mr. James M. Holman, of Holman Bros. at Camborne, whose drills finally broke a way to the ore-body.

DISCUSSION is an important feature of this issue. Our honored friend, Mr. E. P. Mathewson, the manager of the Anaconda smelter, offers valuable comment on our recent remarks concerning the training of mining engineers. He deprecates excessive specialization. Evidently our suggestion on the subject was misunderstood, we advocate the study of a specialty only after a broad training has been obtained, and not as a substitute for the general preparedness preceding a professional career. Mr. John B. Simmons describes an advanced scheme of prospecting, the ingenuity of which will be appreciated even if it does not meet with immediate endorsement. Mr. Herbert Lang, a veteran metallurgist and an inventor not unfamiliar with the vagaries of the Patent-Office, offers some pertinent remarks on a subject that is of particular interest just now. He is followed by Mr. H. G. Prost, a patent attorney, who supplements his interesting letter appearing in our issue of March 18. To Mr. John Allingham, an experienced millman, we are indebted for a short cut in estimating the tonnage of slime.

AMONG the articles recently declined by us, as being unsuitable for publication, was one explaining "Why people buy mining stock," in which the chief argument for buying such stock was based on the dividends paid by mining companies. The author, of course, was able to present imposing totals, showing how much more than the original capital of a selected number of rich mining companies had been returned to shareholders. Among others, he quoted the Comstock as having distributed enormous profits. And all this, it may be assumed quite fairly, was intended to whet public appetite for a puling wild-cat in Nevada or Arizona. The mining industry offers excellent chances for the use of money in speculation, but this sort of "guff" has outworn its day. The return on nominal capital affords no criterion of the

amount of money won or lost in the purchase of stock in a particular mine. If the public could buy into good mines on the ground-floor, the record would be flattering indeed, but, as a matter of fact, much money has been transferred from the guileless many to the guileful few by means of some of the richest mines in the world, simply because the innocent and ignorant bought stock when the mine was enormously over valued. As for the Comstock, the chicanery and gambling connected with mining companies operating at Virginia City did much more harm than good to the industry. Whether a mine will enrich or impoverish the buyer of stock, in a company controlling it, depends upon the particular stage in its development at which the shares are bought.

Geology of Tonopah

The silver-mining district of Tonopah, in Nevada, is one of the few localities in which the relationship of mineral deposition to structural geology has been diagnosed with such definiteness as to aid the mine superintendent in his search for ore. The diagnosis will always be associated with the name of J. E. Spurr, for to this geologist we owe the first clear analysis of the petrographic conditions and to him also we are indebted for several contributions of knowledge on a matter of vital interest to the miner. In a recent number of *Economic Geology* he reviews the evidence gathered at successive periods from 1902 to 1915. We have read this review with keen appreciation, for in his outline of the development of ideas on the basis of cumulative observation and his frank acknowledgment of minor errors of inference he writes in the true spirit of science, which is to recognize the logic of facts whether the heavens fall or the earth is disrupted underfoot. On the whole, even his first study of the district has been confirmed by actual mining, which has demonstrated that the most productive veins are in a trachyte that was covered or intruded by a number of later eruptives. The names of the various rocks have been changed more than once during the past 12 years in such a way as to perplex those interested in the local geology, but that has been the case in many other mining districts, and must be accounted one of the penalties of scientific progress. Both the effusive volcanic rocks and the ore deposition that makes them interesting belong to the Tertiary period. The oldest known rock in the locality of the mines and the one traversed by the richest veins is a trachytic flow, the lower portion of which is glassy and barren of ore. These older veins were formed in the trachyte before it was covered by later extrusions. After the trachytic eruption came several others at intervals, differentiated as andesite, rhyolite, and dacite, most of them followed by a period of vein-formation, but none of such economic importance as that which enriched the trachyte. Of the later veins the most interesting is associated with a sill of rhyolite that cuts through the trachyte and the older veins. Mr. Spurr regards the ore as a magmatic residuum closely associated in its origin with the alkaline-

silicious magmas from which these eruptive rocks were derived.

Two points must be noted. The first is that the vein formation and ore deposition took place at no great depth. Allowing for erosion and the successive accumulation of volcanic rocks, it is demonstrable that the depth at which the veins were formed did not exceed 2000 feet and that the oldest and richest orebodies came into existence at a time when the surface at that period was even nearer to the place of mineralization. Mr. Spurr regards mineralizing solutions as the end-products resulting from the differentiation of magma, so that distinct metal-groups may be deposited at different temperatures from solutions having the same source. According to him, veins characterized by the sulphides, tellurides, and selenides of silver, with the tellurides of gold, such as are found at Tonopah, are characteristic of a shallow depth, a Tertiary age, and a fine-textured or glassy volcanic rock. They belong to a period of comparatively low temperature and a place near the surface. The heat underground in this district is still remarkable, the water encountered in a deep drill-hole from the bottom of the Mizpah shaft showing a temperature of 108° F. This linking of variation in temperature and pressure with the deposition of recognizable groups of minerals is important. In advocating the theory, Mr. Spurr is following upon the idea, previously advanced by him, that relatively long-sustained temperatures at the critical point of precipitation for a given mineral group are necessary for the accumulation of an ore deposit of economic importance.

Another interesting feature is the penetration of thin dikes and tongues of intrusive lava appearing now as a glass. In places this lava had to pass through passages too narrow to admit even the smallest solid inclusions, which were filtered out. It would appear as if the pressure exerted by this liquid magma had sufficed to enlarge the opening into which it had been admitted. Thus Mr. Spurr concludes that although the quick chilling of the lava into glass indicates that the rocks penetrated were cold and inferentially at a shallow depth, yet the lava was able to lift several hundred feet of rock in order to make room for itself. In one case, that of the West End-MacNamara lode, it is inferred that a large flat-lying quartzose vein was formed by the creation of an opening that was filled with ore while it was being enlarged; that is, the silicious solutions exerted sufficient pressure, along an old line of weakness, to lift the overlying rocks and support them during the interval required for the crystallization of the quartz and its accompanying minerals. This is a bold bit of constructive imagination and should stimulate further research. Indeed, most of the ideas quoted above are in the nature of audacious theories, stimulating to observation but requiring verification before becoming acceptable as safe guides. It is to be noted that the relatively flat veins of the district do not reach the surface and so relief of pressure upward was not obtainable by the solutions that enriched them. The reasoning adopted by Mr. Spurr

brings veins and dikes closer together, making them both the result of magmatic differentiation and invasion. Instead of thinking of such veins as the result of the corrosion of the walls of a fissure, we are asked to regard them as the filling of a crevasse, the opening of which is accompanied by up-welling solutions representing the residuum of magmatic segregation. They may be compared to the cracks in ice, which are filled by water as the crack advances.

These theoretical considerations may not seem to assist the search for ore, but, as a matter of fact, they stimulate study and give a point to research. At Tonopah they have prompted a great deal of careful investigation, not only by Mr. Spurr but by Messrs. J. A. Burgess, W. H. Grant, and George H. Garrey, besides several of the mine managers, notably Messrs. F. H. Bradshaw, John A. Kirchen, and John W. Chandler. The result has been not only to elucidate the structural geology of the district but to facilitate the search for ore, the distribution of which is dependent largely on structural conditions. For the early work at Tonopah the Geological Survey is responsible, for at that time Mr. Spurr was a member of the Survey, but his later investigations have been made on account of the Tonopah Mining Company, which Mr. Burgess also served as geologist. This company and others in the district have shown an enlightened appreciation of the aid that economic geology can give in actual mining operations, and to them is due no small measure of the credit for the knowledge thereby obtained, to the gain not of themselves only, or of the Tonopah district, but of the art of mining.

The Bunker Hill Smelter

In our issue of October 2, 1915, we stated that the Bunker Hill and Sullivan Mining and Concentrating Company intended to build a lead smelter. We are now able to announce that Kellogg has been selected as the site for this reduction works. The choice hovered for a time between several localities on Puget Sound, certain points on the lower reaches of the Columbia river, and the vicinity of the mine itself. In choosing the last the management had to decline a most friendly offer from Spokane as well as the allurements of tide-water, but the factor of railroad rates proved decisive. The rate from Kellogg to New York is established at \$12 per ton for pig lead, and no unfriendly influence is likely to be able to enforce an increase. From Northport also the rate to New York is \$12 per ton, but to this must be added \$2.75 per ton on concentrate, of which two tons will yield one ton of pig lead, so that the total freight comes to \$17.50. To Spokane the rate from the mine is \$1.75 per ton of concentrate, equivalent to \$3.50 per ton of lead, making the total from the mine to New York \$15.50. To lower points on the Columbia river the freight is \$3.50 per ton on concentrate, which again must be doubled to get at the equivalent in lead. The rate by the Panama Canal to New York is only \$5, but to this \$1 must be added for interest and insurance on

the long water haul, so that the total is \$13 per ton. Thus Kellogg offers an advantage. Moreover, it is the home of the company's mining and concentrating operations and offers every hospitality to further metallurgical reduction. The wages paid at Kellogg are higher than on the Coast or down the river, but it is understood that the bonus now being paid to the miners on account of the high price of lead will not apply to smelter operatives. Hitherto the output has taken the form chiefly of various concentrates, which have been shipped to the East Helena and Selby smelters. It is proposed to treat at Kellogg such products as are not covered by existing contracts, that is, the lower grades and the higher grades of concentrates and the ores produced by subsidiary companies. The new smelter will be built on the Bingham and Giovetti ranches, just below the mine. It will consist of three blast furnaces, each 18 by 180 inches at the tuyeres, and a roaster equipment comprising one Wedge furnace and four Dwight Lloyd sintering machines. A sampling-mill, a bag-house, and a refinery for separating the precious metals will constitute other parts of the plant. The relations of such parts is made clear in the article describing the Selby lead smelter, which article, by a coincidence, appears on another page of this issue. The Kellogg smelter will employ 300 men and will have a capacity of 900 tons of charge, 80% of it lead ore, per diem. It has been designed by the firm of Bradley, Bruff & Labarthe. Construction will commence forthwith and the plant is expected to be completed in a year from date. The greater portion of the material and equipment has been ordered already. The concentrates and ores to be treated carry a high percentage of lead, and the iron is present chiefly as a carbonate, not a sulphide, so that the sulphur content will be low. Any danger of fume nuisance will be further prevented by use of a bag-house. Electric power will be supplied by the Washington Water Power & Light Company, which gets its energy from the Spokane river and Long lake in Washington. The smelter will be served by the Oregon-Washington Railroad & Navigation Company, which is a north-western subsidiary of the Oregon Short Line, tapping Huntington, Spokane, and Portland. It remains to add that another independent smelter, the one at Northport, on the Columbia river, at a point close to the boundary between British Columbia and the State of Washington, started to work under the management of Mr. Harry L. Day last month. As most of our readers are aware, Mr. Day until quite recently was the president of the Federal Mining & Smelting Company, a Guggenheim or American Smelting subsidiary. He controls the Hercules, Tamarack, and Chesapeake mines in the Canyon Creek district, also in the Coeur d'Alene region of Idaho and only 15 miles from Kellogg. The ore from these mines likewise used to go to East Helena and Selby. The Northport smelter has a capacity of 600 tons of charge, say, 480 tons of lead ore, in each case one-third of capacity being held in reserve. Mr. Day sends his lead bullion to the Pennsylvania Smelting Company, at Pittsburg, of which he

obtained control recently, so that he is independent as to smelting, refining, and marketing. Undoubtedly the operations of these two independent smelting units, at Northport and Kellogg, will have an important bearing on the development of the Coeur d'Alene and encourage those mine operators in the Northwest that have complained, not without reason, of the excessive rates levied by the big smelting combinations.

The Selby Smelter

On another page we give a description of the smelting operations at Selby. San Francisco has reason to be proud of that metallurgical establishment. It has played a notable part in the mineral development of the Pacific Coast region. To it have come some of the earliest products of mining districts now famous. Jim Gardner, the pioneer of the Coeur d'Alene, came to Selby with his first shipment of ore and thus prepared a way for the long-continuing business between this smelter and the great Bunker Hill & Sullivan mine. Some of the first Utah lead ore also came to San Francisco, from the Emma mine. Before the railroad was available eastward, the Arizona lead product and the rich silver ore of the Silver King mine came to Selby. So did the early output of the Slocan district in British Columbia. In later years the development of Tonopah was assisted by the market offered by the Selby smelter for the siliceous silver ore of Nevada. Indeed, before a great system of railroads gave varied facilities for the shipment of the products of the mines, the fact that a lead smelter was in operation on the Bay became a decisive factor in promoting the development of the region tributary to San Francisco. Even today, despite the growth and variety of smelting facilities in the West, this establishment of the Selby company is no mean asset to the community. The photograph of the works, at the head of the article, is in itself suggestive, for the vessel seen alongside the smelter-wharf will suggest traffic overseas. A ship is ever the spur to imagination. To the smelter comes coke from Germany and Australia; concentrate from Korea and Mexico. From the smelter goes lead to New York, silver to Hongkong, and gold to the Mint. The white paint made from its lead is laid on the battleships at the Mare Island navy-yard and the bluestone derived from its refinery aids the agriculture of California, while the lead shot and bullets manufactured at Selby fly far, after duels and after game of a less innocent kind. Indeed, the variety of products and by-products is remarkable. For instance, besides producing lead, silver, and gold, each in ingot form, this establishment makes sheet-lead, pipe, traps, and a variety of minor lead articles, for instance, the buttons employed for weighting women's dresses and the 'sinkers' used by fishermen. A smelter like this is an industrial organism of great interest; in itself it illustrates the diversity of use to which mineral products are put and suggests the growing complexity of the scheme of living we call civilization—concerning which in the year 1916 the less said the better.



DISCUSSION

Our readers are invited to use this department for the discussion of technical and other matters pertaining to mining and metallurgy. The Editor welcomes the expression of views contrary to his own, believing that careful criticism is more valuable than casual compliment.

Training of Mining Engineers

The Editor:

Sir—Referring to your editorial on this subject in your issue of March 11, I beg to offer the following.

First, I agree with you in your "cheerful negative to the first question." I also endorse your remarks down to the point where you suggest specialization in teaching engineering, but here I take a strong exception to your proposal.

During the last thirty years, it has been my good fortune to have had to do with training of more young engineers, fresh from college, than perhaps any other man in the profession in the United States; and I have found that those who have been most successful are those who have had the least specialization in their college training. My belief is that the duties of the technical college, so far as engineering instruction is concerned, should be confined to the furnishing of a course of general studies that would train the mind of the student to think for himself, should ground him well in mathematics, physics, chemistry, with a short course in assaying, and enough surveying to make him familiar with the instruments in common use. In so far as metallurgy is concerned, he should, if possible, be taken to plants where the principal types of machinery and metallurgical apparatus are in use, and be shown their purposes without being allowed to operate them. A similar course of demonstration should be made with mining students, and, wherever possible, the students should be compelled to take practical work in some line of engineering during the summer vacation.

In addition to the studies mentioned above—as many students come to the technical college with insufficient grounding in the "three Rs"—the examination for entrance should be made stiff enough to insure a proper course of preparation. In connection with the college work there should be some instruction in accounting, and in the writing of readable and logical reports; but by all means cut down the specialization in engineering colleges to the minimum. It must be borne in mind that the young men entering such colleges have, in most cases, no idea what their future in life will be; and when they graduate they are, at best, only prepared to enter upon the study of the engineering profession. They have to seek employment, and if only trained along narrow lines they cannot get, at the outset, just what they want. Many instances occur to me where men took the civil engineering course in college and became mechanical engineers in practice, and *vice versa*; also where men had

specialized in mining and had, in actual life-work, become metallurgists.

Let us suppose a man specializes in flotation—according to your suggestion—and he goes out into the world landing at a place like Butte, and finds all the jobs in the flotation plants filled, he naturally takes the first job that offers—it may be that of a 'mucker' in one of the mines. If he has the right stuff in him, he will stick to that job until he becomes shift-boss and from there his career will gradually be upward, but he will never again think of flotation.

Another thing to be remembered is that the teaching staff in our colleges cannot be expected to be in a position to give the special training outlined in your editorial. Again I say, cut down specialization, but give the student the best possible ground-work, so that he can think, act, and study on his own account, and be prepared to tackle any problem coming under the heading of engineering.

E. P. MATHEWSON.

Anaconda, March 15.

How to Prospect

The Editor:

Sir—Apropos to the symposium on prospecting, which ran in the pages of your paper for a period last year, I beg leave to offer the following:

What is the matter with prospecting? It is easier to recognize that there is something wrong than to be able to offer helpful constructive criticism on why it is so, or to offer a suitable remedy for the condition.

In the last decade I have witnessed several periods of mining activity in Nevada, the State that, from its expanse, its undoubted mineral character, and the nakedness of its rock exposures, would seem to offer the best possible field for prospecting. Yet the reward in new discoveries, barring those made almost simultaneously in several parts of the State immediately following the finding of Tonopah, have, with a few minor exceptions, been pitifully few and of no great importance. One can hardly refrain from asking, why?

While crossing the desert recently, I chanced to doze reflectively in a comfortable arm-chair in the observation car of an overland train. Mirages danced playfully across the alkali flats in the heated afternoon sunshine. With no directing will, the mind responded to the atmosphere and soon a mirage clearly visualized engrossed my attention. Across the horizon to the south I saw a moving object—a house on wheels moving down the middle

of the valley. The 'house' was attended by objects of lesser size, also mobile. Closer inspection revealed the objects to be a first class prospecting expedition, consisting of a large auto-truck carrying under an enlarged covering a complete assay office, with rock breakers and an equipment for making rough, wet and dry, concentration tests of ores or of gravels, and with the camp equipment to shelter and feed a party of half a dozen men. The lesser objects proved to be small autos, 'Fords' if you will, capable of running up the side-draws and canyons that debauched upon the valley every few miles in traversing its course. These little machines, each manned by one or two capable prospectors, were the 'business getters,' the means of gathering the rock samples expeditiously and in quantity and the gravels from the draws, for immediate testing at the assay 'office' moving down the middle of the valley.

I saw in this vision a solution of many of the most serious obstacles to successful prospecting, the obvious consideration of those at all informed in the matter. The principal advantage of attacking the problem in force and with such an equipment is that an expedition like this can make use of the combined services of the trained technical man and the 'old time' prospector, can at the same time cover more real ground in a systematic way at a less expense per square mile, can test samples immediately with greater certainty and at smaller expense, and finally can spend \$10 in a collective way that will produce the results gained by spending \$20 in the hap-hazard fashion of two decades ago. Thus equipped we are not trying to fight today's battles with yesterday's tools; those served and passed a generation ago in scenes and fields less combed over, aye, even virgin. Every valuable vein discovered and every mine found, unless it be of a new type such as the low-grade porphyry copper deposits of recent exploitation, leaves one fewer deposit undiscovered, and makes the subsequent finding of valuable deposits less a matter of chance and more a matter of systematic and scientific search. Possibly with such an equipment other new types of mines may be uncovered. It can be said without evil that there would be fewer 'bench-warmers' around the principal hotels in Western cities awaiting the appearance of the 'expert' for some mysterious Eastern syndicate, for the purpose of foisting upon said expert an alleged mine that has been handled about for 20 years, if the expert could but prevail upon his Eastern syndicate to equip him with a modern prospecting outfit as above described. Mines are found as well as made, contrary to the flippancy current observation. If the expert changed his methods somewhat, he might also change the recurring annual report to his directors that he had "in the year just past turned down some 365 mines and near-mines," had spent \$100,000 upon his staff in the quest, but had found not a single prospect worth considering. To my personal knowledge in the past two years two splendid mines that had been presented on desirable terms to such an expert were passed over for want of careful and intelligent consideration, mainly because the consideration of the other 363 prospects confused his

better judgment. In a word, to my mind, there is nothing the matter with prospecting, the lapses are in the men and in their means and methods; the times and conditions and requirements have changed, and so must the methods of attacking the problem if results are to be obtained.

JOHN B. SIMMONS,

San Francisco, March 8.

The Patent Game

The Editor:

Sir—Your somewhat optimistic view of the workings of the Patent Office at Washington, in the issue of January 29, almost reconciles me to the fate of being an inventor. My feelings, however, are hardly as hopeful as yours. I fear the patent machinery of our Government has seen its best days and will have to be rebuilt, at least, if not scrapped bodily. You instance chiefly the evil of litigation, so unavoidable in bringing new inventions into use; but this, in my opinion, is but one of the evils that the times have brought. The Patent Office, we are told, was instituted with the statesman-like and philanthropic object of stimulating invention, benefiting inventors, and subserving the interests of the general public. The results at first were excellent, no doubt. A Yankee who had found a new and improved way of making a wooden spool, wooden nutmegs, or what not, could at that time go ahead and construct his machinery and shop, with his own hands perhaps, and then proceed in peace and quietness to enjoy the fruit of the honest labor of his brain and hands. But times and customs have changed; wooden nutmegs have fallen under Dr. Wiley's displeasure; spools are no longer made in small shops a dozen at a time, but in great factories where millions are turned out in a day, under the domination of a soulless corporation. The Yankee's small triumph has been swallowed up in the general progress of the age, and the inventor has become a part of the controlling trust, or he has been retired to obscurity by its influence. His patents are only valuable for keeping somebody else out of the business. The same tendencies have overtaken the Patent Office also, and it has become a sort of industrial concern, in which, I fear, quality of work is often sacrificed to quantity. As long as the issued patents were counted by hundreds or by thousands and the individual issues could be kept comfortably within the recollection of a few men, the quality was good and the output satisfactory; but when as now it has mounted to millions, and a highly specialized and numerous staff of examiners is employed, many objections have to be made as to the quality of the work. It is hardly too much to say that the Office has fallen perceptibly away from its former efficiency and is approaching a condition in which it will totally fail to stimulate inventors, to benefit the general public, or to reward anybody whatever, except the flourishing class of patent attorneys who, if one may judge from the multiplicity of their advertisements, make a pretty good thing of it.

Adverse impressions like these are strengthened by an inspection of the Patent Office *Gazette*, an enormous publication, as unintelligible as it is bulky, which is issued once a week, as a kind of compendium of its labors. If the reader be skilled in translating 'patentese,' the jargon adopted by the Office to conceal its thoughts, he will come to agree with me that the patent powers of our country deal mainly in trifles, its output consisting almost exclusively of the merest threads and patches of invention, but done up in packages that to a tyro look like the real thing.

Why is it that the greater part—I almost said all—of the output of the Patent Office is the veriest rubbish? Have our inventors degenerated into snappers-up of unconsidered trifles, and become mere grubbers after shreds of invention and discovery, searching as searches the industrious fowl among rubbish heaps for the crumbs of former feasts? How does it happen that in the whole weekly deluge there is so little worth mentioning, let alone worth patenting? The answer may be as follows:

You can easily patent an invention for doing what nobody wants to do, or for doing in an inferior manner what is already better done; but difficulty arises when you seek to secure a real improvement, or a reasonably complete patent. The Patent Office, by virtue of its duties and responsibilities, has become afraid of big things, but revels in small ones. Nothing is too minute and insignificant to patent. The Office moves along certain fixed paths that lead to the light in only one direction. Your invention may be new, but the chances are that it is old. To find out you must make a formal application for patent on a thing that is, perhaps, forty years old. There is no *index rerum* in the Patent Office—it knows no way of facilitating an inquiry. With the aid of your attorney (necessary unless you would fall a victim to the Examiner's satire) you prepare an application at a cost of \$30 up, and having forwarded it, you sit down to wait four or six months, to ascertain what the Office should have been prepared to tell you promptly, namely, the state of the art; which means, what fellows have blundered onto the ground before you. The Office eventually replies. You are informed that your application is rejected as lacking novelty, and you are furnished a list of, say, 20 patents of this and other countries covering, in the opinion of the Examiner, the ground ahead. Now let us see how this affects the inventor. If you are an old hand at the business you would have expected something of this kind. The fair form of the inventor's offspring is totally eviscerated. One man has the heart, another the liver, another the lights, while to another has been given the skeleton. The inventor is in despair. But wait, says the attorney: here is a bit of skin that everybody has overlooked; we can patch it up a little and maybe hang a valid claim on it. But what's the use, says the inventor: nobody would buy skin. Well, the money having been paid over and the Patent Office moved to action once, the rest seems easy; the application is narrowed down to conform to the state of the art, and eventually a kind of patent is got. Every-

thing becomes easy after the Examiner has pared things down enough. If a man really wants or needs a patent of this kind he can get it by hanging on, for it is strongly suspected that the people at Washington sometimes give one to a man to get rid of him. I can understand this, but I cannot understand how a man can be so lacking in sense as to accept it.

Patent seeking has now degenerated into a game in which skill in framing the papers counts for more than the inventor's ingenuity. As the value of your prospective patent rests upon the validity and scope of the final claims, your lawyer has come to play too great a part in the adjudication. He is pitted against the Examiner, and if he proves lazy, incompetent, or unfaithful, you are lost. It doesn't matter what you have devised, your fortunes are in the hands of two men who naturally are concerned solely with getting rid of you. What the inventor loses through ignorance of the patent game, added to what he loses by the carelessness of his attorney, plus whatever the Examiner can deprive him of, leave what we find in the *Gazette*: a poor return for so much brain fag. It is no wonder that so few patents are worth the paper they are printed on. I don't imagine that one patent in a hundred pays the inventor, nor that one in a thousand ever benefits the general public, which, by the way, seems to have been lost sight of in the scramble, and perhaps it is as well, for whatever good could come to it is altogether too remote and fanciful to consider. Why not refrain from such a losing game? Why, when we discover in an old machine a new hole to put a screw in, or when we invent a new means of stirring up the mud in a cyanide-tank, why cannot we go quietly to work without any fuss, and do it, without appealing to the Patent Office, at no end of expense to ourselves and annoyance to them, for protection for our insignificant little alterations and so-called improvements? This question brings us to the nub of the whole argument.

The number of patents is so great and their scope so uncertain, that any projected improvement in construction is almost certain to run afoul of vested rights, to our cost and discomfiture. It is almost inevitable that among the million and more of American patents there is at least one upon which we would unwittingly infringe. It appears then that the American law acts to protect the inventors of one generation against the next; and, as often happens, enable those who have taken out patents, which they have suffered to remain inactive, to levy tribute on people who really wish to use their inventions. This, in my opinion, is the worst feature of our system. The engineer or builder who may desire to put in use improvements that he has devised, is debarred from so doing because of the existence of possible prior inventors, the majority of whom have never put their ideas into practice. I submit that this is an undesirable condition, none the less because it was foreseen by the framers of the law. The best recourse in this case is to have a search made of all the existing patents, which will generally indicate where the danger lies. Some patents

may have to be bought outright, some royalties may have to be paid, but in any event a good deal of time and some money is well expended to clear the road ahead. From the point of view of the engineer intent upon building new things, the situation is sufficiently annoying, and some of them go so far as to characterize patents in general as an intolerable nuisance. They hold that the whole crop of patents should be canceled and utterly done away with. Personally, I would not hesitate to cast my bushel or so of patents into the discard along with the rest, if by so doing I could get a free hand in designing things as I wish, free from interference from others.

It is not, of course, to be expected that the policy of our Government, so long persisted in, will be altered in any material particular, since the general public has not yet become dissatisfied with the workings of the Patent Office. But in the future when the rapidly expanding files have grown, as they inevitably will, to an unmanageable bulk, some action will have to be taken in the interests of inventors and the public alike. I should think that some useful editing might be done, making existing records more accessible and more intelligible. You have remarked on the difficulties that the courts meet in endeavoring to adjust rival claims, and upon the tendency of patentees to obscure and extenuate their claims. Judicious pruning on the part of properly qualified officials, I should think, would go a long way to ameliorating such conditions. The least the authorities should do is to curb the verbal ingenuity of the patent attorneys, many of whom take delight in spinning out claims to a wholly unnecessary extent, adding largely to the difficulties of everyone whose business brings him to deal with such things. As it stands now, no one can fully comprehend the scope of even an ordinary patent—I doubt, if in the majority of cases, the inventor himself knows precisely what he has patented, and I am sure the public does not. Some patents have as many as 40 or 50 claims, couched generally in unfamiliar language and presenting the subject in a manner entirely strange even to the inventor, who of all men may be least likely to understand it in its new phase. I pity the judge who has to wade through such a mess of claptrap. I think, on the whole, that the Government might change its policy profitably, gradually if need be, to the practice in Germany, granting few patents and only after strict scrutiny, then standing behind each patent so as to make it valid without the seasoning process of court action that seems inescapable with us.

HERBERT LANG.

Oakland, February 26.

The Scope of a Patent

The Editor:

Sir—The matter of interpreting the scope of a patent claim is so generally misunderstood, and unfortunately in many instances through misinformation, that a great service to the inventor would be performed if he could be given only a superficial knowledge of the subject. This misinformation is used to work a great injustice to

the inventor, since he misinterprets the scope of his claim, bases his calculations and expends his money on the false assumption that he has a broad claim which covers his invention, and finally comes to grief.

The matter is a simple one, yet it is often difficult for an inventor to understand it. Assume that a man has invented an apparatus which in its complete form comprises a combination of six elements. A narrow claim on the invention will include all six of the elements and the inventor, upon reading this claim and finding all six elements contained therein, believes that his invention is fully covered. The claim, however, only covers the combination of elements contained therein, or their equivalents, and in order that the claim be infringed, the infringing device must contain the six elements. If it contains only five of the elements, it is not an infringement, and it is not a very difficult matter in many instances to dispense with the sixth element.

A claim only covers the combination of elements set forth therein or their equivalents and does not cover an apparatus that does not embody all of the elements of the claim.

H. G. PROST.

San Francisco, March 23.

Estimating Slime

The Editor:

Sir—In estimating slime tonnage the following may be useful, more especially to those who appreciate short cuts:

Pounds of dry slime per cu. ft. of pulp =

$$\frac{\text{weight of 1 cu. ft. pulp} - 62.5}{x}$$

$$x = \frac{\text{sp. gravity slime} - 1}{\text{sp. gravity slime}}$$

In practice, a cubic-foot box and the weight of one cubic foot of water can be counter-balanced, so that the excess, when the box is filled with pulp, can be directly read, and divided at once by x .

JOHN ALLINGHAM.

Oakland, March 28.

CORRECTION. Asbestos production of Quebec in 1915 was erroneously given on page 474 of this journal of April 1 as \$2,895,935. This should be 114,115 tons valued at \$3,544,302, an increase of \$648,367, but below the total for 1913. Rock mined amounted to 2,134,073 tons, producing asbestos worth \$3,118,524, or \$1.46 per ton.

IDAHO has an area of 84,800 square miles, which is more than that of Missouri, Washington, Kansas, or South Dakota. Its population of 400,000 exceeds that of Wyoming and Nevada combined. The principal mineral output is lead, the production of which in 1915 was 377,000,000 lb. Shipments of zinc ore and concentrate during 1915 contained zinc valued at over \$11,000,000.

EUCALYPTUS OIL. The oil distilled from one of the Australian gum-trees, the *eucalyptus amygdalina*.

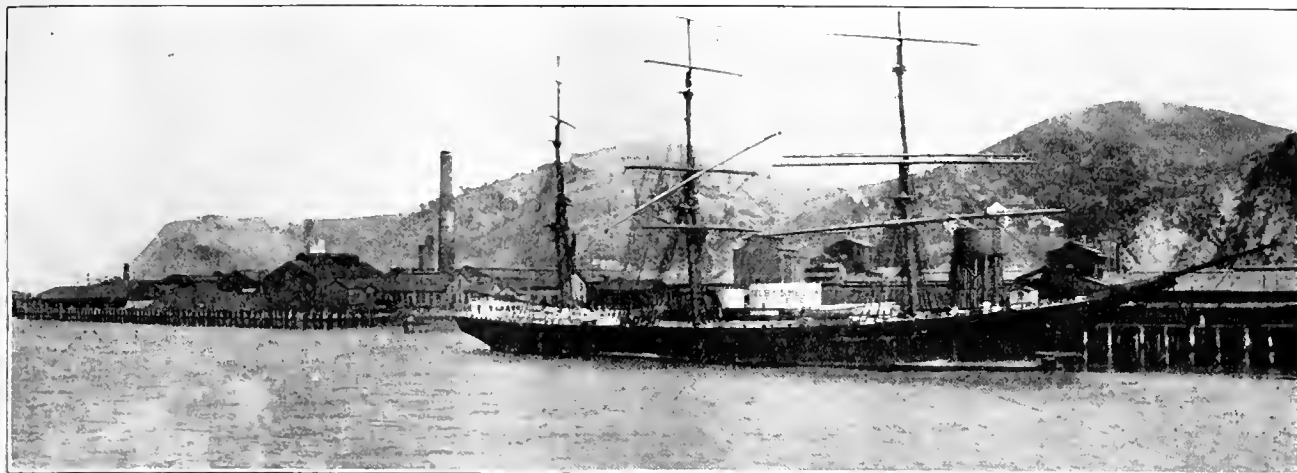

THE SELBY SMELTER AND WHARF.

The Selby Lead Smelter

By T. A. Rickard

SAN FRANCISCO is an important mining centre, for it serves as a distributing point for engineers, machinery, and supplies to the Pacific Coast, to the mineral regions of the Great Basin, to the rich South-west and the romantic North-west, from Alaska to Peru, and across the sea to Japan, Korea, and Siberia. As a metallurgical centre, it can boast among its residents several metallurgists of international reputation and on the shores of the Bay at least two noteworthy smelting establishments, the Selby lead works and the Mountain Copper plant. But for an unreasonable prejudice we might have been able to claim a big copper smelter, for the construction of such a reduction plant was actually started in 1906 at South San Francisco. Lack of appreciation for the antiseptic qualities of sulphur dioxide on the part of the untechnical public prevented that useful undertaking from coming to fruition: it was nipped in the bud, so that today our most important smelting establishment is the one that was founded by Thomas H. Selby.

That worthy pioneer came to California from New York in 1850. He established a hardware and iron business that prospered deservedly. In 1864 he built a shot-tower at the corner of First and Howard streets, where it stood as a conspicuous landmark until destroyed in the earthquake-fire of 1906. He imported his lead from England and Spain; but finding this inconvenient and costly, and knowing that there was lead nearer home, he decided to build a small plant to reduce local lead ores and thus supply the requirements of his factory. Thereupon he organized the 'San Francisco & Pacific Lead Pipe & Shot Works.' In 1875 he bought a block of land on Black Point, now the site of the California Fruit Cannery Association plant, where he built a couple of

smelting-furnaces, to which he added a lead refinery and a plant for parting the gold and silver, as well as a copper sulphate annex, gradually increasing his equipment as the business expanded. In 1876 he died and the enterprise became incorporated under its present name; the Selby Smelting & Lead Company. His son, Prentiss Selby, became general manager, with A. J. Ralston as president and H. B. Underhill, Jr., as secretary. The last is happily still with the company, as its president. At the time when this new start was made the Comstock mines were in bonanza, so that a large part of the bullion from Virginia City was refined at Black Point. In 1879 the Selby company absorbed the Pacific Refinery & Bullion Exchange, previously the San Francisco Assaying & Refining Works, at 416 Montgomery street. The office of the Selby company was transferred to this building and remained there from 1879 to 1907, for it was one of the few down-town structures that escaped the earthquake-fire.

The site at Black Point soon became inadequate for the expanding operations, so that in 1884 the company purchased the present site near Vallejo Junction and 29 miles east of San Francisco, on the strait of Carquinez, which forms part of the estuary of the Sacramento river. This article will describe the plant and its operations as I saw them recently.

Entering the smelter-yard I noticed two bars of fine silver, each of 1100 oz., on a truck. Upon inquiry I was informed that they were going to Joseph Mayer, a manufacturing jeweler at Seattle. Next, Mr. Eugene B. Braden and Mr. E. N. Engelhardt, who were piloting me, stopped to look at a truck full of small pieces of slag. From their remarks I learned that slag of egg size was being sent to the Goldfield Consolidated mill, in Nevada,

to aid in the reduction of gold precipitated from cyanide solution.

In the office Mr. Engelhardt showed me an old photograph, from which it could be inferred how much the plant had been extended. This has been done conveniently, for the dumping of slag has continuously enlarged the site available, so that the smelter now covers an area 1100 ft. by 100 ft. more than it did in 1890. Not only has the slag dump proved useful in this way, but the greater compactness of a modern equipment has tended to restrict the superficial dimensions of the plant as a whole. A number of hand-rabbed roasting-furnaces, for instance, are now replaced by four sintering machines. The blast-furnaces, it is true, have been increased in size, those first built being 30 by 72 inches, as against furnaces of 36 by 141 inches now in use, but even this is small in comparison with those built at Anaconda, which are—or were, for they are being dismantled now to make way for reverberatories—87 feet long.

Going to the ore-bins, it is evident that one feature of the operations is the large number of small lots, that is, under 5 tons. Any lot less than a carload (15 tons being the minimum on the Southern Pacific and 30 tons on the Santa Fe railroad system) is charged \$10 extra, on account of the labor of handling and accounting. Parcels of specimen ore weighing as little as 10 lb. are received. The smallness of some shipments is due to ignorance in regard to the processes involved. Some earloads are too poor to pay the freight, let alone the smelter charges; these are used for grading and are marked 'overboard.'

Among the shipments to be seen on the occasion of my recent visit was the concentrate from the Alaska Gastineau, or Alaska Gold Mines, near Juneau. This first came in the form of two products: (1) a galena concentrate containing 20 oz. gold, about the same amount of silver, and 50% lead, (2) a pyrite concentrate assaying 6 to 10 oz. gold, the same of silver, and 5 to 8% lead. It was found that the iron pyrite, containing over 40% sulphur, exhibited such a tendency to oxidize, even to the point of ignition, as to endanger any ship that brought it. When under its own pressure in the hold it proved particularly dangerous. On one occasion this concentrate actually set fire to a wharf at San Francisco. The pyrite probably is porous and so favors rapid oxidation. This Alaskan concentrate is so agglomerated, by incipient fusion, or spontaneous sintering, that it has to be re-crushed before sampling. Now an intimate mixture of the pyritic and the lead concentrates is made, resulting in a product assaying 15 oz. alike in gold and silver with about 25% lead. This mixing increases the difficulty of sampling. Another mine producing easily combustible pyrite is the Green Mountain, near Raymond, in Mariposa county. Shipments of this copper ore burned several box-cars, leading to the use of iron gondola-cars, and compelling the mixing of it with other ore before shipment to Tacoma, for it was forwarded to that copper smelter on Puget Sound.

Among recent shipments may be mentioned silver-lead ore from Mayo, on the McQuesten river, in the Yukon.

This assayed 25% lead, 260 oz. silver, and \$30 in gold.² One of the oldest shippers to Selby is J. J. Gunn, who sends a few sacks of silver-lead ore, hand-picked, from Loyo county. He has been contributing for 25 years.

It is a rule of the Selby sampling department that ore must never touch wood or cement or any material likely to catch the fine stuff and so 'salt' a sample either way, up or down. Three separate rooms are maintained for the final reduction of the samples; high grade, medium, and low-grade. The floors are covered with sheet-iron. The shipper or customer is allowed to watch the operations through the iron-screened doors, of which there are so many that good observation is facilitated. These screened doors evoked the remark "safety first"—to be taken in either of two ways. All the sampling is done by hand, except the final reduction in small fine-grinding machines. No bucking-board is to be seen. The shipper or his representative can check the moisture determination by drying his own sample, the desiccating being done by steam-heat, so that over-heating is impossible.

Among the lots that I saw undergoing sampling was some chalcopyrite ore from the Island Mountain mine, which is in the south-western corner of Trinity county and is owned by Frank A. Leach, formerly Director of the Mint. The shipment was said to represent the blasting of a big piece, or 'boulder,' of ore detached from the outcrop. Another interesting product was a cream-colored granular material gathered during the dry season by skimming the enriched slime on the settling-ponds of the mills at Tonopah. It assays \$20 to \$40 per ton.

The superintendent of the sampling department, Charles Richards, has been in the company's employ for 30 years. One of the melters, William Stewart, has 28 years to his credit, and the foreman of the melting-room, William Kitchen, can boast 32 years; while James K. Bulger, now manager of the gold and silver department has a record of 37 years. Indeed, the appearance of the men at work does not suggest unhealthful conditions. I take it that in a smelter, as in life generally, good sense assists a man in preserving his health. As I watched a rubieund operator at the side of a big kettle full of molten lead, I noted that he stood to windward. Care and instinctive observation will enable a worker to avoid injury to his health.

In the room reserved for high-grade material, I saw 25 tons of black silver precipitate (from a cyanide mill) being sampled. At the Mexican mine from which this came it had been deemed safer to ship this product, containing 20,000 oz. silver per ton, in this non-merchantable form rather than risk the danger involved in trying to export silver bullion, which might be seized by bandits, including some one or more of the so-called governments.

All of the concentrates go to the sintering machines; in their ordinary condition they are too finely-divided for treatment in the blast-furnace. From the various bins the concentrates and fine ores are trammed to an ordinary elevator and thence along an upper floor to steel bins.

²See also M. & S. P., July 24, 1915. 'Silver Discovery on the Yukon.' By D. Saunders.

These, called 'feed-tanks,' are cylindrical, with conical bottoms. Eight of them have a capacity of 50 to 60 tons each, and two hold from 80 to 90 tons apiece. The contents of these are fed onto a conveyor-belt, the flow being regulated by a gate set for a specific stream of ore $\frac{1}{4}$ inch or less. A good mixture is obtained by the mingling of feed from the various 'tanks.' The speed of the belts and sintering machines is regulated by cone-pulleys. The belt delivers into an auxiliary 'feed-tank' with four pockets placed above the four sintering machines, each pocket having a belt running to a corresponding machine. This, the Dwight-Lloyd machine, consists of a continuous series of grates or 'pallets,'

The bag-house is a building in which are suspended a number of cylindrical bags, 32 feet long and 18 inches in diameter, made of woolen cloth, retaining the natural oil of the sheep, so as to serve as a filter through which the fume is forced by a draft. Thus the valuable and deleterious elements of the fume are eliminated and collected. This device was first introduced by Malvern Hles at the Globe smelter, Denver, fully twenty years ago. It has proved not only an economic factor in lead smelting, but it has done much to lessen popular apprehension in regard to the possible injury resulting from smelter smoke.

At the time of my previous visit, in 1908, the fine ore

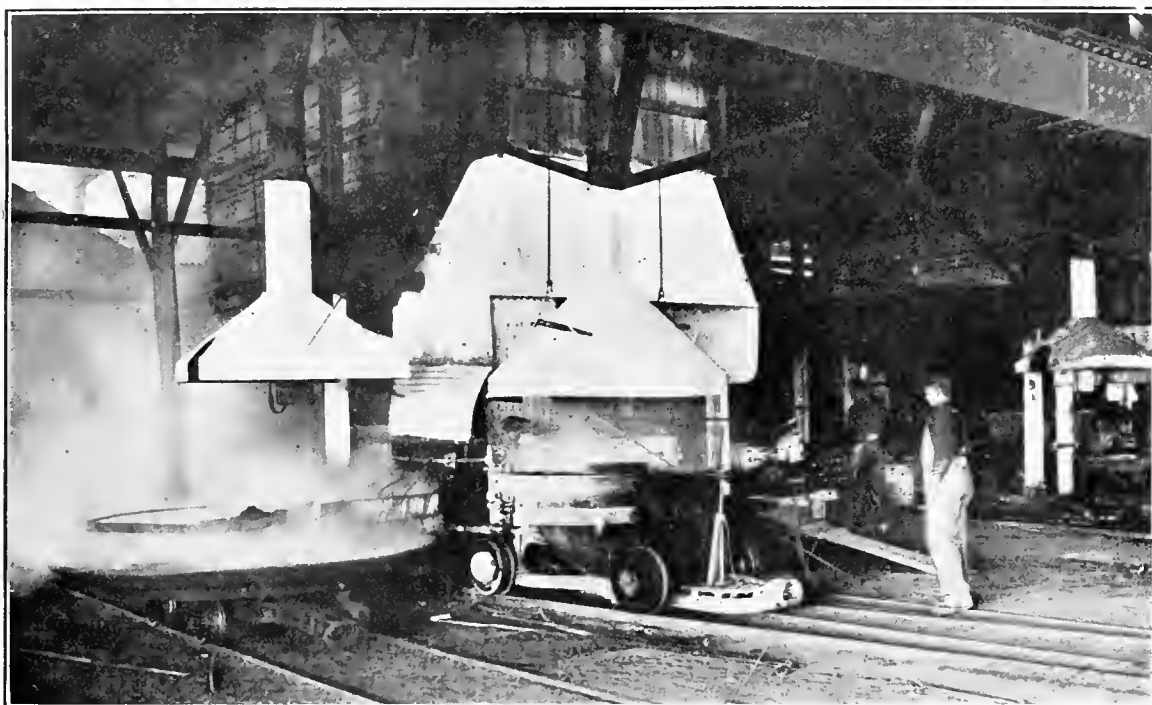

BLAST-FURNACE, WITH SETTLER, SLAG-POT, AND KILKER MATTE-CAR.

there being 42 of them to each machine, and each consisting of 3 linked grates. The 'pallet' is 42 inches wide and 24 inches lengthwise of the line of movement. The travel of this continuous or linked grate is at the rate of 12 to 20 inches per minute, according to the composition of the charge, giving a capacity of 90 to 150 tons per 24 hours per machine. The fire-box or 'muffle' is made of silica-brick and contains an oil-burner, which points across the path of the ore. The burner consumes 40 gal. of 17° B. oil per 24 hours, with air under 80-lb. pressure. At Tacoma illuminating gas is used for this work; at Denver, coal; and at Monterrey, distillate.³ To remove the gases a wind-box, under the muffle, is operated by a Sirocco fan making 900 r.p.m. and giving a suction equal to 8 inches of water. This connects with the bag-house, where the fume is condensed, and thence to the stack.

³The smelter uses only 15 tons of coal per month, for the little locomotive on the slag-dump and a cook-stove. Oil is used under the boilers and on the forges. Steam is needed in the precipitation plant and to steady the furnace-blast.

went to four Ropp roasters, of which only one survives. The sintering machines have replaced the roasting-furnaces, plus the fact that the heavy sulphide ore is treated by the General Chemical Company's works near Martinez for the manufacture of sulphuric acid. The one Ropp roaster that remains is operated during four months of the year only, namely, the rainy season, in accordance with an agreement with the farmers of Solano county, who fear injury due to the fume. The Ropp furnace was the invention of Baron Alfred De Ropp, a Russian nobleman, who was in charge of the smelter before it came under the control of the American Smelting & Refining Co., in 1905. He may be said to have been identified with, and responsible for, the most notable expansion of the Selby business. In the roaster that he invented the ore is turned by a traveling mechanical rabble operated by a cable that passes over a sheave at the upper end of the furnace, so that the rabble is outside the furnace half the time, during which it is being cooled. This marks one of the few occasions when a baron got the best of the rabble.

When the ore has been roasted and sintered (or agglomerated) it goes to the blast-furnace. No bedding floors are maintained at Selby, the necessary mixing of various components of the charge being effected at the bins, in the manner already described. Each sintering machine discharges into a car, which delivers its load on the upper feed floor of the water-jacketed blast furnace, into which it is shoveled by hand. The water-jacket is made of cast-iron and is fed with salt water from the Bay. The cold water enters at the bottom of the jacket so as to keep the sediment stirred and prevent the jacket from burning. The blast is admitted by 8 tuyeres on each side under a pressure of 35 to 40 oz. per square inch. The ore column is 14 ft. high. Each furnace smelts from 180 to 200 tons of charge per day, as compared with 130 to 140 tons seven years ago. This increase is due mainly to the fact that the sintering puts the charge in a better physical condition for smelting; it is more porous to the heated blast, and therefore to chemical change. The total weight of a charge is 9250 to 9500 pounds. Of the total about 80% is sintered ore. Limestone, quartz, and metallic iron are added to produce a fusible mixture and a clean slag. Coke,* in the proportion of 12 to 13%, equal to 9½% fixed carbon, is required. This comes from Australia and Utah. Slag, up to 25% on the charge, is returned to the furnace in order to regulate the physical condition of the furnace and to correct irregularities in its operation. It is found most practicable to make a slag of the following percentage composition:

| | | | |
|------------------------|----|--------------------------------------|---|
| SiO ₂ | 26 | Al ₂ O ₃ | 7 |
| FeO | 28 | ZnO | 6 |
| CaO | 17 | | |

The undesirable alumina comes in the silicious ores from Nevada, largely as alunite. The slag also contains 1.5% MgO, from the limestone, and 1 to 1.5% S, besides traces of copper, antimony, phosphorus, etc.—in fact, minute traces of most of the elements.

The limestone used formerly was the reject from the portland cement works at Santa Cruz. Now the Selby company has its own quarry near Martinez. Some limestone is obtained from the Spreckels quarry, the product of which is employed mainly in the refining of sugar.

When once in the blast-furnace, the smelting of the charge requires six hours. The separation of the lead from matte and slag takes place within the furnace, the lead being drawn off through an Arents syphon-tap. The matte and slag run out into a rectangular fore-hearth, which is placed on a truck, so that the slag, being lighter, overflows into a settler 6 by 6 ft. and 2½ ft. deep, which, in turn, empties into a slag-car of 23-cu. ft. capacity, holding 2½ tons, drawn along the water-front by a small locomotive, by aid of which it is discharged

into the Bay. The matte is tapped at a lower level of the fore-hearth into a revolving Kilter pan or 'merry-go-round.' When cool the matte is broken by sledge-hammers, then passed through crushers and rolls, and sent to the sintering machine to be roasted.

The lead flows from the well of the blast-furnace into moulds and is cast in pigs or bars weighing 90 lb. apiece. It gladdens the heart of a miner to see the lead flowing from the furnace into the mould. The pigs of lead are taken on trucks to the refinery and there elevated to the upper floor, to be delivered into the softening-furnaces (two reverberatories of 70 tons capacity each) in which the processes of softening and liquation are carried out. Liquation, or eliquation, is the process of separating metals by the difference in their melting points. The lead from the blast-furnace in addition to its gold and silver contents, contains copper, antimony, and other metals the presence of which interferes with its industrial utility; hence the necessity for getting rid of them by liquation. The impure lead is melted at a minimum temperature, about 710° F., when the copper comes to the surface in the form of dross, which contains silver and gold also.

The dross is removed by rabbles into a car and goes to a reverberatory for further treatment, whereby the dross is converted into a leady copper matte, which, after being roasted, is returned finally to the blast-furnace. When the copper dross has been removed, the antimony comes to the surface as a scum, which is withdrawn for treatment in another reverberatory furnace, where an antimonial slag is formed. This slag goes to another blast-furnace, where an antimonial lead metal, known as 'hard lead,' is produced. This is sold for making type-metal, babbitt, solder, and other alloys in which antimony forms a useful component. In the near future, instead of casting the lead into pigs at the blast-furnace, it is planned to take the molten metal to the lead refinery, where liquation and its sequel of processes will be conducted in due course.

Copper in any ore is gradually absorbed in the blast-furnace, as metal; it is also skimmed as a dross in the softening furnace and treated in the 'skimming-furnace,' with addition of galena, forming a matte of about 40% copper, which is shipped to Omaha. Returning to the softening furnace: when the charge is 'cooked,' that is, all the copper, antimony, arsenic, etc. have been eliminated, the lead is tapped into desilverizing kettles, 3 ft. deep and 10 ft. diam. There are four of these and they hold 60 to 65 tons each. They are made of cast-iron and are fired by oil, delivered in barges by the Union Oil Co. from the southern oilfields of California. Zinc is added to the lead to collect the silver. The temperature in the desilverizing kettle is raised to the point where a slab of zinc melts readily in the molten lead; this is at 840° F. The zinc unites with, and collects, the silver. It is the old Parkes process. Sufficient zinc is added to desilverize the lead; and as the zinc melts it is mixed, by a mechanical stirrer, into the bath of lead. The scum of zinc that rises to the surface contains the silver, and the gold

*Some of the coke recently received is of North German origin; it was delivered through Dutch ports and brought to San Francisco on French sailing vessels that take wheat and barley back with them. The steam-schooners that bring lumber from Puget Sound are glad to take copper ore—unsuitable for Selby, but sold here—to the Tacoma smelter.

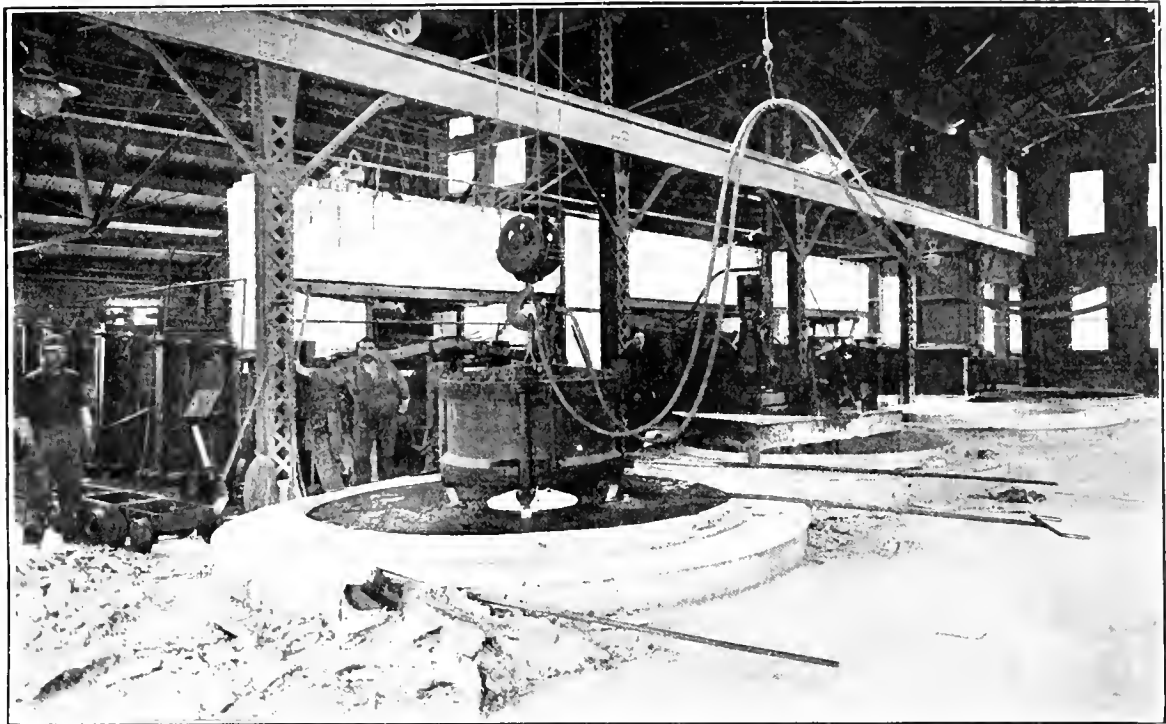

DE-SILVERIZING KETTLE, WITH HOWARD PRESS IN A BATH OF METAL.

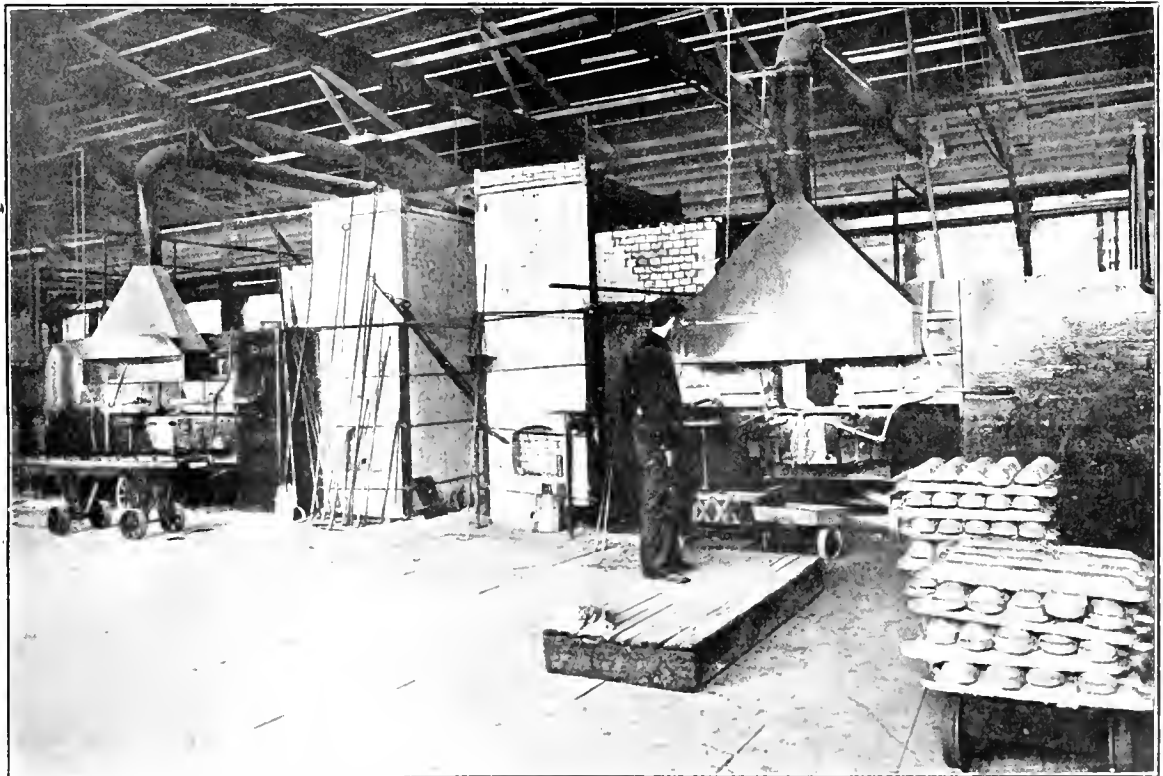

CUPELLATION FURNACES, WHERE THE LEAD, AS LITHARGE, IS REMOVED FROM THE GOLD AND SILVER.

also, both the precious metals deserting the lead. It is a concentrating process. The lead as delivered into the kettle contains about 150 oz. silver and 7 oz. gold per ton; the zinc scum, after being pressed to remove the free lead, carries 3000 to 3500 oz. doré, this last being the metallurgical term for the two precious metals when

mixed in unrefined bar. Literally, doré means golden. Any trace of copper remaining over from the previous treatment is also removed in this zinc scum, which is squeezed in a Howard press so as to extract any uncombined lead. The pressing machine is lowered by a crane into the metal bath and when it has acquired the

temperature of the lead, the scum is ladled into the press. This machine was devised by W. H. Howard, formerly of Pueblo and Garfield, now consulting metallurgist to the A. S. & R. Co. After being pressed the scum from these desilverizing kettles contains 22 to 24% zinc, 10% precious metals, 3% copper, the rest being lead. The scum looks like the native silver, slightly tarnished, to be seen in mines, as in the palmy days of the Mollie Gibson, at Aspen, for example. The molten lead in the kettle resembles mercury, though it is less mirror-like and of lighter lustre. The final scum on the surface of the lead is collected by a wooden rake (which chars, but does not burn) and is lifted out by a flat ladle.

The lead is now free from gold and silver, but still contains some zinc, say 0.5%, and traces of antimony; it is syphoned to a reverberatory furnace on the ground-floor. This syphoning of molten metal is interesting. It is done by means of a 2½-in. iron pipe bent into U shape with one leg longer than the other. The pipe is laid in the bath of lead within the kettle until both are equally hot; then the stop-cock at the lower end is opened and hot lead fills the syphon; the stop-cock is closed; two workmen manipulate the syphon (now full of lead) with tongs and hooked rods so as to get the syphon out of the bath without breaking the column, keeping the end of the short leg within the bath. When the syphon is in place the stop-cock is opened and the lead runs into the furnace below. This has a capacity of 70 tons. Here the lead is subjected to an oxidizing heat whereby all the remaining zinc is driven off by volatilization or is collected as an oxide by the litharge that forms on the surface of the lead; this litharge is skimmed and re-smelted in the blast-furnace.

Finally the lead is tapped into the moulding-kettle, which holds 60 tons, and serves the purpose of maintaining the metal at a suitable temperature while it is being tapped—by a syphon again, but a much smaller one—into 50 moulds, set in a three-quarters circle. Each of these moulds yields a pig weighing 100 pounds of refined lead. When piled in stacks they look handsome.

Now we must return to the treatment of the by-products from the refinery. The zinc dross from the desilverizing process is placed in graphite retorts, where, by distillation, the zinc is driven off in fume that is condensed, as in ordinary spelter practice, yielding metallic zinc and blue powder (zinc oxide), leaving a lead bullion rich in gold and silver. The zinc is first tapped and then the retort is turned over so as to empty the lead bullion into moulds. This doré contains 4000 to 6000 oz. of precious metals per ton. It goes to the cupellation furnace, where the lead is converted into litharge which goes to the blast-furnace while the doré bar is sent to the parting plant. Here the silver is separated by being dissolved in strong sulphuric acid, the resulting silver sulphate being precipitated on copper bars, leaving a copper sulphate solution that is precipitated on sheet-lead hanging from wooden bars. This 'bluestone' or crystallized copper sulphate is dried and then sized by screening before shipment in barrels, each holding 400 lb. The small size is

bought by the farmers for spraying wheat and the larger lumps go to the electric companies to be used in batteries. Some of the bluestone goes to Mexico to be employed as a chemical in the *patio* process.

Coming back to the parting room, the liquor from the condensation of the fume escaping from the kettles has a cherry red or ox-blood color due to the presence of selenium, derived from selenides in the Tonopah and Goldfield ores. This gold and silver selenide is converted to a hydrogen selenide that is reduced by the sulphur dioxide generated by the solution of the silver in sulphuric acid. The gold remains in the kettle as a brown residue, like wet crumbs of sponge-cake; this is washed thoroughly, and melted in graphite crucibles, and sent to the mint at San Francisco. A bar of gold 12 by 5 by 3 inches contains 1700 to 1800 ounces. All the silver in solution is precipitated on the copper in 16 hours; the copper plates are lifted, the silver (which looks like soft clay or cement) is removed, by aid of wooden shovels, into a 'sweetening' car, where it is exposed to jets of steam and water for 5 hours, removing all traces of acid. Having been washed, the silver is placed under a hydraulic press; the cakes resulting are put into a melting-furnace, 70,000 to 80,000 oz. at a time, and then cast into bars. Both the silver and the gold are removed to the vault while still hot. There the orderly array of bars brings home the wealth of California, of Nevada, of Idaho, of Alaska. It is good to 'get next' to the realities of mining and to recognize the purpose of the prospecting, digging, stoping, tramming, hoisting, milling, smelting, refining, and other multifarious operations of a basic industry. That purpose is to extract the metals from the rocky crust of the earth profitably.

Mining Costs at the Portland

During 1915 the Portland mine, at Cripple Creek, produced 280,528 tons of ore at the following cost:

| | Per ton. | | Per ton. |
|------------------------|----------|----------------------------|----------|
| Labor | \$0.3269 | Assaying and sampling..... | \$0.0271 |
| Explosives | 0.1739 | Surveying | 0.0127 |
| Machine-drill charge.. | 0.1046 | Repairs and replace- | |
| Supplies, etc..... | 0.0081 | ments | 0.1525 |
| Tramming | 0.1753 | General expense..... | 0.1256 |
| Timbering | 0.3022 | Office | 0.0162 |
| Hoisting | 0.1322 | Development | 0.0763 |
| Sorting and loading.. | 0.1374 | | |
| Lighting | 0.0261 | Total | \$1.7965 |

The mine was worked for 338 days, with the following results:

| | |
|---|----------|
| Total shifts | 128,266 |
| Average shifts per day | 379.5 |
| Average shifts underground..... | 243.5 |
| Total machine-drill shifts | 27,710.4 |
| Average machine-drill shifts | 82 |
| Average cost per machine-drill shift, besides labor.... | \$1.56 |
| Total cost of explosives per ton broken..... | 0.2141 |
| Tonnage broken per machine-drill shift..... | 13.58 |
| Tonnage handled per shift per man..... | 2.9 |
| Tonnage handled per shift underground per man..... | 4.57 |

Hookworm Disease Among Miners

By Rush M. Hess

INTRODUCTION. Of tropical and sub-tropical diseases, the least known among miners, though perhaps the most far-reaching in its ill effects, is that of the hookworm. Here is a little parasite, one-third of an inch long, that causes one of the most common, most insidiously harmful, and most easily prevented diseases of man. It is definitely known that the weak mentality, depraved morality, and physical anæmia so common in warm countries are directly attributable to this infection. Especially should we of the mining profession acquaint ourselves thoroughly with its prevention and cure, as the mine with its soft warm mud and commonly careless sanitation, makes an ideal place for pollution and infection. For much of the following information I am indebted to the courtesy of the International Health Commission, which is waging a world-wide battle for hookworm eradication.

HISTORY. The symptoms of the disease were described in records of the Egyptian empire, but its cause was not known. Dr. Angelo Dubini, an Italian, discovered the hookworm in 1888, but its anæmic effect was not suggested. About 1877 both Grassi and Colomiatti discovered the worms in anæmic patients. Since then, this parasite, *ankylostoma duodenale*, has been studied carefully, its responsibility for certain types of anæmia demonstrated, and a successful treatment developed. In 1899 Major Ashford identified the hookworm in Porto Rico and in 1902 Dr. Stiles found the same disease in the Southern States. These worms of the New World, however, are of a different species, *necator americanus*, but look like the Old World type; they produce the same symptoms, substantially the same treatment is effective, and they can all be prevented by the same means.

PREVALENCE. Hookworm disease is more or less prevalent in the entire zone lying from 30° north to 30° south of the Equator, or in practically all tropical and semi-tropical countries, which contain more than half the inhabitants of the globe. In Porto Rico, in low-lying districts of Colombia, or the sugar plantations of Ceylon and Dutch Guiana, infection was found to involve 90% of the entire population. In the United States the disease is found throughout the states south of the Potomac and Ohio rivers, in Arkansas, Missouri, Oklahoma, Texas, and California. Prevalence and severity vary from 1% to more than 90%. In particular is infection severe in the mining districts. At one coal mine in Pineville, Kentucky, in 1911, 65% of the men on the pay-roll were infected. In 1902 at Liege, Belgium, the official estimate of infection among underground miners was 26%. In 1902 at the Dolcoath mine, in Cornwall, practically every underground worker was infected. In the same year examinations conducted in Rhenish West-

phalia placed the infection in certain mines at from 19 to 79%. It is probable that all mines in the rainy parts of the torrid zone are, or have been, infected to even a greater degree.

MORAL AND ECONOMIC EFFECTS. The infected individual has his strength sapped, vitality lowered, and physical and intellectual growth stunted. The social and economic importance of the disease is beyond common comprehension. In the course of a few years a once healthy family has become pale and puny; a once industrious family, languid; and a once prosperous family,



HOOKWORMS CRAWLING THROUGH THE SKIN OF THE HANDS OR FEET, MUCH MAGNIFIED.

in debt. Children lose their mental alertness. Laborers infected accomplish only from 35 to 50% of their normal work. A single California mine employing over 300 men is estimated to have lost 20% of the wages paid, or \$20,000 per year, because it had to carry on the pay-roll a large body of men to replace those periodically unable to work because of hookworm anæmia. Beyond question the moral and economic cost of the disease is enormous.

LIFE CYCLE OF THE PARASITE. The life of the hookworm is in two periods. During the first the worms are microscopic and live in the soil (or mine-mud) where they have been hatched from eggs deposited there with the excrement from some infected person. Neither eggs nor larval worms can be seen with the unaided eye. These worms live for ten or twelve months under favorable conditions but cannot develop beyond this point unless they gain entrance into the body of some human being. The larval worms enter the body either by cling-

ing to food which is swallowed, uncooked food not thoroughly cleansed or which has been contaminated by soiled hands, such as strawberries, plums, celery, and lettuce, or more commonly by burrowing through the skin of the feet or hands into the tiny blood capillaries, whence they journey to the heart and lungs. The blood vessels of the lungs being too small for them to pass through, they burrow into the air spaces of the lungs. They then crawl to the wind-pipe and the throat and are swallowed with saliva and food, reaching the intestine, where they fasten by means of their hooks on its wall and begin their blood-sucking. The second period of the life-history begins with their entrance into the intestinal canal. Here the male and female, after molting twice, develop to adult size. From five to eight weeks are required for their growth, by which time they are from one-third to three-quarters of an inch long and about the size of No. 30 sewing thread. They are usually white, but become dark-brown when full of blood. They may live for years. The female deposits thousands of eggs, which never hatch in the intestines, but pass out with the excreta to spread the disease.

PHYSICAL EFFECTS AND SYMPTOMS. The adult hookworm, fastened onto the intestine, saps the blood, wounds the intestine, and poisons the body. In severe cases the blood is reduced to one-fourth or one-sixth of normal. In these cases the victim has a sallow complexion, lips pale, eyes listless, pupils dilated, hair dry and scant, face and ankles often swollen, ulcers on legs, and the abdomen is prominent. The chest is often flat and the shoulder-blades stand out prominently. In children there is a marked retardation in development. Appetite is often perverted, even to a craving for clay. Bodies of victims are so weakened that they are unable effectually to fight the more dangerous germs of tuberculosis, typhoid, and pneumonia. Headaches, dizziness, and inability to sleep are common. Light infections, however, may never be suspected, and the existence of the disease can only be confirmed by the finding of eggs in the excreta by microscopic examination. These eggs in their several stages of development are easily distinguishable. Each female hookworm, and there may be more than a thousand of them in a single victim, deposits some twelve to fifteen hundred eggs daily which are passed from the body to pollute the soil and to spread the disease. Infected persons, going from place to place, spread the infection from one community to another. One careless miner may be responsible for the infection of all the men in a mine.

THE THYMOL TREATMENT. Hookworm disease is easily cured, and permanently if there is no further infection. From one to seven or even more treatments are given, depending on results. Little or nothing is eaten by the patient at noon on the day of treatment. No dinner that night is allowed. At 8 p.m. a dose of Epsom salts is given. The next morning at 6 o'clock, if the salts have acted, half the thymol prescribed should be given, two hours later the rest of the thymol, and two hours later another dose of Epsom salts should be taken, which will expel the hookworms that have been loosened and poisoned by the thymol. Nothing should be eaten on the day

the thymol is taken until the final dose of the Epsom salts has acted well. No alcoholic drinks, oils, butter, or milk should be taken on the day previous to or on the day of treatment. Alcohol and oils dissolve thymol, making it actively poisonous and exceedingly dangerous. The dose of thymol varies with the age of the patient, an adult is usually given 60 grains. Thymol is a poison, and great care must be taken in its use. Deaths have resulted from not following directions.

PREVENTION. Preventive measures against hookworm are simple. The eggs must not be allowed to develop. Therefore excreta must be disposed of in a sanitary way by burning, fermenting, or burying. Do not use for fertilizer unless thoroughly treated. Pollution of ground and mine must be stopped. Shoes should be worn. Above all, sanitary and fly-proof privies are of prime importance. Educate your men.

CONTROL OF DISEASE. At the Continental Coal Corporation, at Pineville, Kentucky, in 1911, among 1800 men of whom 65% were infected with hookworm, there were about 150 cases of typhoid, and bowel complaints were numerous. After measures were taken to eradicate the hookworm, the same force of men loaded over 33% more coal on the cars, and during the summer of 1912 there was not a single case of typhoid and cases of diarrhoea were reduced one-half. At Liege, Belgium, in 1902, infection among underground miners was 26%. In 1912 the infection had been reduced to 2%. At the Dolcoath mine, Cornwall, in 1902, 94% of the men were infected. Simple prophylactic measures taken, resulting in practically a complete eradication. Infection in the Rhenish-Westphalia district, Germany, has been reduced 95% from 1903 to 1911.

No other disease is perhaps so well understood in every detail and can be so satisfactorily explained. Nor is there any other disease against which the lay community can so surely protect itself by simple precautions. Its conquest resolves itself into a problem of education and sanitation.

Mica production in this country varies irregularly. For instance in 1913, sheet mica to the amount of 1,700,677 lb. worth \$353,517 was produced, while in 1914 it was 556,933 lb. worth \$277,330. Scrap mica was 5322 tons worth \$82,543 in 1913, and 3730 tons worth \$51,416 in 1914. Imports in 1913 were 2,239,000 lb. of sheet valued at \$943,000, chiefly from India and Canada. North Carolina ranks first in domestic production, much of the output coming from farmers who work at mica-hunting when crops do not require attention; there are small grinding mills for waste. New Hampshire is also important, in which State the General Electric Co. has a plant for trimming mica. Several of the Western States are now producing small quantities of mica. Like many other minor minerals, mica can be handled best by a dealer in such materials who knows the ins-and-outs of the game, has warehouse facilities, and is in touch with the trade. The U. S. Geological Survey pamphlet on the 'Production of Mica in 1914' gives data on prices and production.

The Mine-Mechanic

By P. B. McDonald

A mine-manager recently remarked that he was having difficulty in securing a capable general mechanic who understood mining machinery. He could, he said, get a lot of men who were good mechanics but knew little or nothing about mines, or he could get plenty of men who knew all about mines but were poor mechanics. In fact, he could find a number of men who were almost good enough, but was encountering difficulty in securing just the proper combination in one man. What the manager wanted was a man to take charge of, and be responsible for, all the mechanical and electrical work at the several mines of his company.

The reason why it seems difficult to find a satisfactory man for head of a mine's mechanical department is because mechanics in general have not been attracted to the mining industry. Again, it requires a mechanic of unusual capability to be fitted for master-mechanic for a mining company. A mine-mechanic cannot be purely a mechanic, or he will be attempting to impose useless details on parts of the plants where such refinements are more of a nuisance than an advantage. In addition to ability and training in mechanical lines, he must have adaptability, resourcefulness, and a little of the spirit of mining. Otherwise he will not harmonize in the scheme of the work and will conflict constantly with the other foremen.

Yet by no means should it be assumed that the machinery and plant at a mine are only rough devices requiring indifferent mechanical skill to keep in condition. The machinery used in mining is becoming constantly more elaborate and specialized. The problems arising in the application of steam and electricity to the economical production of ore are more and more necessitating a broad-gauged knowledge of mechanical engineering, whether known under this title or not. Many a man who never attended an engineering college is a first-rate mechanical engineer, and a master-mechanic for a mining company must be a bit of a mechanical engineer just as he must be also a foreman, a miner, and know how to handle electrical apparatus, a 'chain-gang,' or a mining-machinery salesman.

A tendency is becoming evident with the older and better established mining companies to attract graduates of engineering schools into the mechanical department, where they receive a thorough training in the operation of mining machinery. They gradually get to know not only about the maintenance of hoists, pumps, motors, and the miscellaneous array of apparatus common to the business, but they learn the much more difficult feats of installing new machinery, and adjusting it to the special needs of a particular plant, as well as the knack of repairing second-hand apparatus to be used for purposes for which it was not intended. An engineer that has been given a broad training as assistant to the master-mechanic of a large company becomes exactly the man

whom some smaller operator wants for taking charge of his mechanical department; and it is usually the case that a man prefers to change from working for a big concern to one where the individual is of more relative consequence.

Some mechanics do not like mining because they prefer not to live in a mining settlement. But other mechanics who have lived among mines for years would not live anywhere else. A mining district may appear like a desolate end-of-the-earth when a man first arrives, but a better acquaintance with its people, coupled with an understanding of mining communities in general, may change the views of the new-comer.

You can usually spot a mechanic at the mine by his greasy clothes and dirty face. Withal, he has a different look from his mining brethren. He is apt to be either more in a hurry than the miners or more at leisure, depending on how the various machines are operating. He may be running for a man-hole gasket or hot-water packing, swearing volubly, or he may be merely sauntering around inspecting pumps, boilers, and hoists. If you are at the mine on Sunday or a holiday, you may see the mechanics looking blacker and greasier than on week-days, 'hard at it' cleaning flues, combustion-chambers, or what not. As a rule, at the mines that do not operate on Sunday, the mechanics have to utilize that day for repairing or installing machinery that is too constantly in operation during the week to permit the work being done then. When things are running smoothly, a mine-mechanic's job looks easy. However, it is a case where looks are not in accord with facts, for at repair-time and when troubles arise, such a job is no sinecure.

Minerals of Bolivia

Exports of the principal minerals during 1915 were as follows, in kilograms of 2.2 pounds:

| | 1915 | 1914 | 1913 |
|----------------|------------|------------|------------|
| Antimony | 13,985,044 | 186,077 | 62,050 |
| Bismuth | 568,610 | 437,751 | 390,537 |
| Copper | 17,872,054 | 3,874,272 | 4,019,635 |
| Silver | 77,810 | 72,336 | 81,289 |
| Tin | 39,312,182 | 37,259,617 | 44,594,088 |
| Wolfram | 499,604 | 276,316 | 282,577 |

These products are generally exported in the form of concentrate.

The total value was about 77,000,000 *bolivianos*, or \$30,800,000. The total value of all commodities exported in 1915 was Bs. 84,878,384, showing the importance of the mineral industry. The rubber industry was also prosperous.—*El Diario* of La Paz.

GOLD PRODUCTION of West Africa in 1915 was 412,273 oz., against 419,510 oz. in 1914 and 397,679 oz. in 1913. Some December returns were as follows:

| Mine. | Tons. | Value. |
|----------------------|--------|-----------|
| Abbontiakoon | 11,707 | \$130,000 |
| Abosso | 9,732 | 72,000 |
| Ashanti | 10,778 | 195,000 |
| Cinnamon Bippo | 4,167 | 34,000 |
| Prestea Block A..... | 23,500 | 178,000 |
| Taquah | 5,720 | 82,000 |

Precipitating Action of Carbonaceous Shale in Cyanide Solution

By Paul W. Avery

THE paper* by W. R. Feldtmann on the precipitating action of carbon in cyanide solutions has been of great value to me in explaining many points in connection with the cyanidation of our San Carlos vein here at Esperanza.

When we began the treatment of ore from this vein we noted that extraction reached a maximum in about eight or ten hours. After agitation had been carried beyond this point, say, to 24 hours, the gold content began to rise and sometimes was almost double that obtained in the first eight hours of treatment. Further agitation with stronger cyanide solution caused no appreciable drop in the gold content; the silver, however, continued to decrease. We also have had lot-samples the residue from which would drop steadily to about 50% of the head and there remain with no change either way. The following will show this precipitating action or 'kick-back,' as we call it around the plant:

SAMPLE IC

| Time hours | Gold grams | Silver grams | Time hours | Gold grams | Silver grams |
|------------|------------|--------------|------------|------------|--------------|
| — | 7.11 | 33.55 | 18 | 2.66 | 16.89 |
| 2 | 1.22 | 18.89 | 20 | 2.22 | 15.55 |
| 4 | 1.77 | 18.00 | 22 | 2.00 | 15.50 |
| 6 | ... | | 24 | 2.16 | 15.61 |
| 8 | 1.66 | 17.00 | 28 | 2.22 | 15.11 |
| 10 | 1.77 | 16.67 | 32 | 2.50 | 15.27 |
| 12 | 1.44 | 15.33 | 36 | 2.55 | 12.89 |
| 14 | 1.44 | 16.00 | 40 | 2.55 | 14.33 |
| 16 | 1.88 | 17.45 | 44 | 2.66 | 16.00 |

SAMPLE IB

| Time hours | Gold grams | Silver grams | Time hours | Gold grams | Silver grams |
|------------|------------|--------------|------------|------------|--------------|
| — | 6.66 | 35.22 | 14 | 4.00 | 19.55 |
| 2 | 3.55 | 25.22 | 16 | 4.11 | 20.22 |
| 4 | 3.66 | 24.25 | 18 | 3.78 | 19.77 |
| 6 | 3.33 | 21.55 | 20 | 3.66 | 18.67 |
| 8 | 3.33 | 20.89 | 22 | 3.66 | 17.84 |
| 10 | 3.44 | 20.78 | 24 | 3.66 | 18.50 |
| 12 | 3.88 | 20.45 | | | |

This ore carries about 50% of a black carbonaceous shale; when crushed in solution and flowing through the launders a thin film of graphite may be seen floating on the surface very much like oil. This film of carbonaceous matter must have great precipitating power, as it assays high, principally in gold. Samples of shale from this vein were found to possess variable precipitative efficiencies, which fact possibly explains why we obtained excellent results on certain batches of ore by ordinary cyanidation and poor results on others. The following series of tests on a number of shales will show this:

| | Gold gm. | Silver gm. |
|---|----------|------------|
| Original shale | 0.16 | 30.84 |
| After 2 hours' contact with pregnant solution.. | 13.22 | 64.34 |
| Pregnant solution | 3.80 | 18.37 |
| Solution after contact | 0.09 | 6.57 |

Conditions: 250 grams of shale ground through 100-mesh and then brought in contact with 1000 cc. pregnant solution.

| | Gold gm. | Silver gm. |
|-------------------------------------|----------|------------|
| Original shale | 0.16 | 6.84 |
| Pregnant solution | 7.16 | 49.22 |
| Solution after 96 hr. contact | 4.67 | 46.10 |
| Loss | 2.49 | 3.12 |

Conditions: 100 grams of shale brought in contact with 500 cc. solution,

| | Gold gm. | Silver gm. |
|---|----------|------------|
| Original shale | 0.50 | 3.00 |
| After 18 hr. contact with pregnant solution.. | 9.62 | 18.80 |
| Separated into sand and slime by panning. | | |
| Sand 47.4% | 7.41 | 20.42 |
| Slime 51.6% | 11.83 | 25.50 |

| | Gold gm. | Silver gm. |
|---|----------|------------|
| Separated by screening through 200-mesh | | |
| Oversize 15.9% | 10.17 | 9.58 |
| Undersize 84.1% | 10.66 | 23.34 |

| | Gold gm. | Silver gm. |
|----------------------------------|----------|------------|
| Original shale | 1.00 | 6.67 |
| After 18 hr. contact | 2.83 | 14.17 |
| On-going pregnant solution | 4.08 | 16.55 |
| Solution after contact | 3.80 | 18.10 |

Conditions: 100 grams of shale brought in contact with 500 pregnant solution.

| | Gold gm. | Silver gm. |
|---------------------------------------|----------|------------|
| Original shale | 1.00 | 11.00 |
| After 18 hr. contact | 7.33 | 22.67 |
| On-going pregnant solution | 5.76 | 25.48 |
| Effluent solution after contact | 3.16 | 24.24 |

Conditions: 200 grams brought in contact with 1000 cc. pregnant solution.

| | Gold gm. | Silver gm. |
|---------------------------------------|----------|------------|
| Original shale | 1.22 | 18.45 |
| After 18 hr. contact | 2.00 | 10.67 |
| On-going pregnant solution | 22.64 | 71.96 |
| Effluent solution after contact | 22.40 | 73.72 |

Conditions: 200 grams of shale brought in contact with 800 cc. pregnant solution. In this case the shale has little precipitating power for gold and none for silver.

Experiments to dissolve by cyanide the metal adsorbed by the shale were not successful, in some of the tests bromo-cyanide was used with little or no benefit. We made a great number of tests to find out some way of neutralizing, as far as possible, the 'pre-precipitating' power of this carbonaceous material.

Our tests on sorted samples, after the shale had been separated by hand from the quartzose-calcitic portion,

*M. & S. P., May 22, 1915.

Expt Pachuca, Sp.Gr. = 1.35. Solid in Tanks = 95 Kilo. Liq. in Tanks = 126 Kilo. 43% Solid 57% Moisture. S:L = 1:133

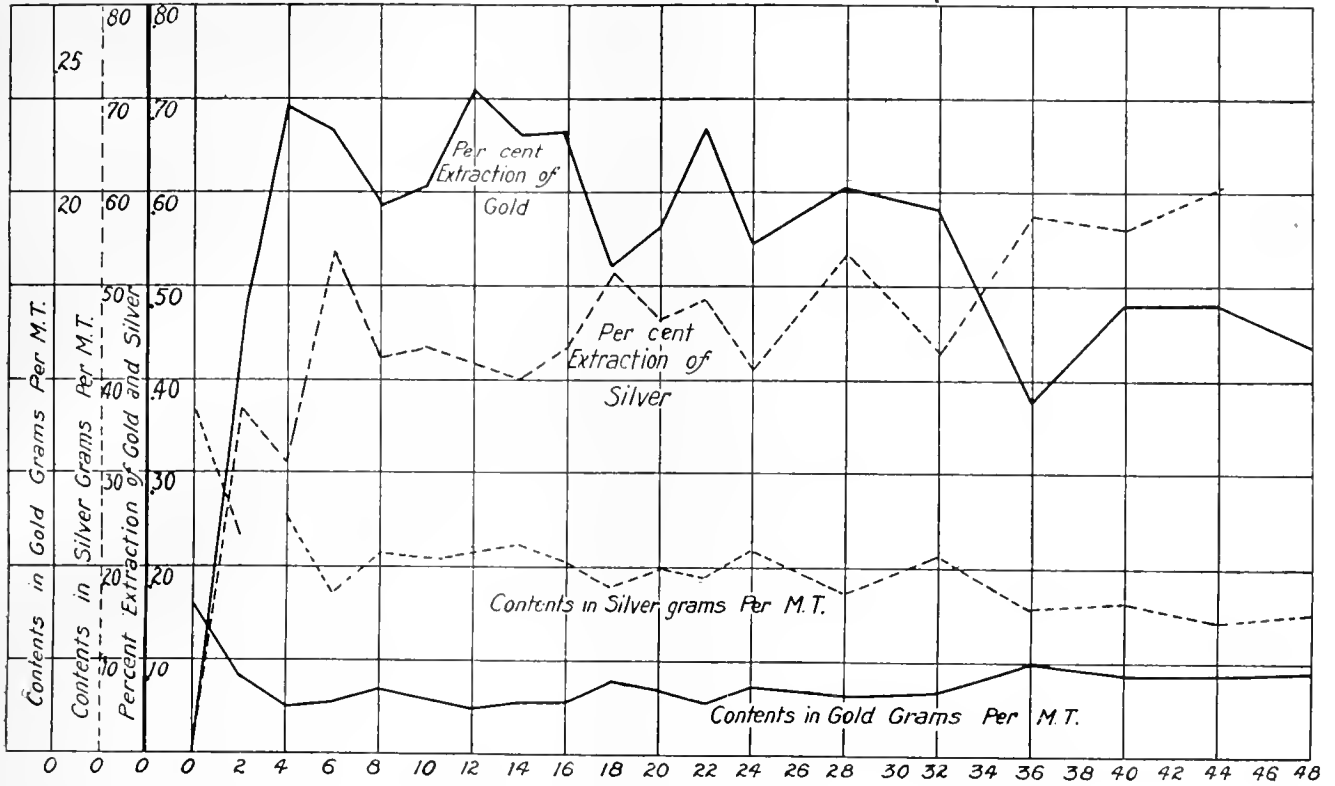

FIG. 1. CYANIDATION OF SAN CARLOS ORE WITHOUT PRELIMINARY TREATMENT.

Expt Pachuca. Sp.Gr. = 1.20. Ratio S:L = 1:266. NaHSO₄ 4-B Kilo. Per.M.T. Solid = 53.5 Kilo. Liq = 142 Kilo.

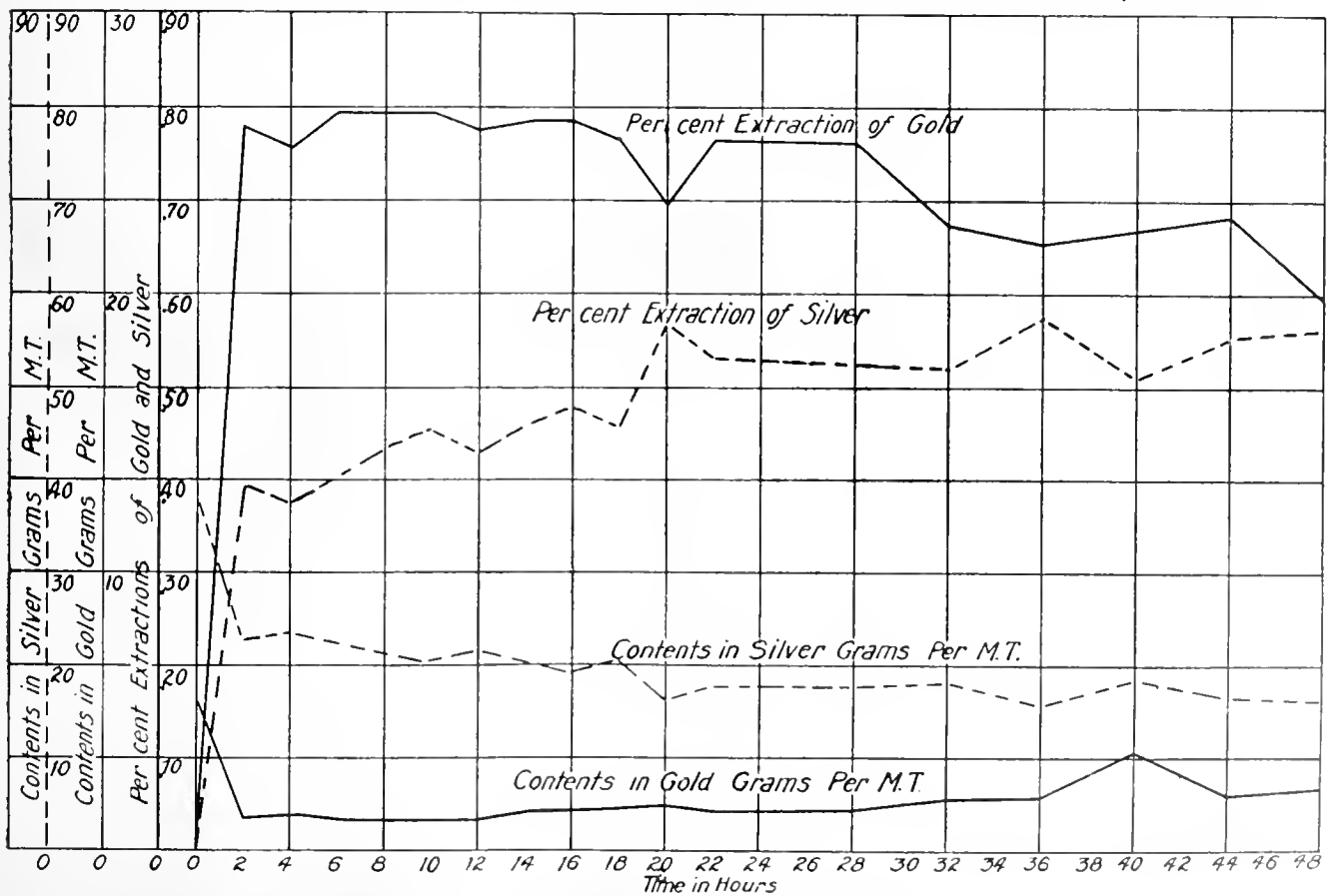

FIG. 2. SAME WITH PRELIMINARY OXIDATION.

showed that the latter had no precipitative power whatever. The shale itself carried but little gold or silver, and if it were possible to hand-pick or otherwise separate the two, our problem would be solved. Separation was tried in drag classifiers, on Wilfley tables, etc., but was found of no avail.

Mechanical separation being impossible, the problem resolved itself into a chemical one, which meant the neutralization of the precipitating power of the shale in the ore by a preliminary treatment in a circuit of its own. This necessitated crushing in water absolutely free from cyanide, with some cheap chemical. We conceived the idea of violent air-agitation in the presence of commercial caustic soda.

Years ago when working on the 'blue ores' of the Black Hills, South Dakota, E. C. Knowles and I tried strong caustic liquors in the presence of air under pressure to break up the refractory sulphides that carried the precious metals in combination. So far as our small laboratory-tests went, the idea was a success, so much so that we took out patents in the United States and Mexico. We described the process as one of oxidation, for without some oxidizing agent no effect was noticeable. After a contact of about 12 hours the 'blue ore' sample, which was a dark-slate color originally, changed to a light-yellow, and upon cyanidation yielded its gold contents readily. We considered that the process amounted to a 'wet roast.' I cite the above to show what prompted us to try caustic soda as an oxidizer in the case of neutralizing carbonaceous shale. After preliminary treatment on the San Carlos ore with caustic liquors as strong as 2%, no difference in color was noted as described in the case of the oxidation of the 'blue ores.' The effect was marked, however, in lessening the precipitating action of the shale.

If strong caustic liquors are required, it will be necessary to filter off and give the pulp a light wash with water before re-pulping in cyanide solution. The reasons for this are obvious, as caustic soda in excess causes poor slime settlement, bad precipitation with zinc, and interferes with the extraction of the gold.

With these objections in view we tried another chemical, namely, commercial sulphuric acid, with encouraging results, but with this decided advantage that there were no ill effects such as noted with caustic soda, no matter how large an excess was added. We have since tried an acid salt—commercial bisulphate of soda—which answers quite as well and is much cheaper.

There is one important point to which I wish to call attention, after studying a number of tests made both with caustic soda and with acid. When the time of maximum extraction has been determined, the treatment should be regulated accordingly and the shaley pulp passed through the filters and out of the plant as quickly as possible. The treatment as outlined above only tends to allay the precipitative power for a time, and if the agitation in cyanide is prolonged unnecessarily this precipitative power may slowly return.

To carry out this preliminary oxidation treatment prior to cyanidation, the finely ground pulp should be

given violent air-agitation in a Pachuca tank with a short column-pipe or without one altogether; the water should not carry a trace of cyanide. If a strong caustic soda solution is used, say, 2%, the liquor will have to be used in a circuit of its own and the pulp filtered, getting at the same time a light water-wash. The pulp then should be ready for cyanide treatment. If low strengths only of caustic soda be required, this step would be unnecessary as regards cost of chemical and interference in subsequent cyanidation. If a commercial acid or commercial acid salt is found effective their use would be more advisable than an alkali, as the constituents of the ore often neutralize any free acidity and cause no deleterious effects in the cyanidation. The large proportion of calcite in the shale here effects this.

Reference to the accompanying curves, one with preliminary treatment and the other without, will show many of the points mentioned. The following series indicates the effect of NaHSO_4 in allaying the precipitative tendencies of the shale:

| SAMPLE IA | | | | | |
|---------------|---------------|-----------------|---------------|---------------|-----------------|
| Time hours | Gold grams | Silver grams | Time hours | Gold grams | Silver grams |
| — | 10.16 | 40.17 | 14 | 1.33 | 18.78 |
| 2 | 1.44 | 21.89 | 16 | 1.33 | 17.78 |
| 4 | 1.33 | 20.45 | 18 | 1.44 | 15.89 |
| 6 | 1.33 | 17.67 | 20 | 1.67 | 15.54 |
| 8 | 1.44 | ... | 22 | 1.67 | 15.33 |
| 10 | 1.55 | 18.23 | 24 | 1.67 | 15.66 |
| 12 | 1.22 | 18.89 | | | |

In the above test the pulp (85% minus 200) was given a preliminary aeration in water with equivalent of 8 kilo. NaHSO_4 per metric ton of ore.

At present I am not prepared to state what effect alkaline sulphide solutions will have in dissolving gold precipitated on our carbonaceous shale. Experiments will be undertaken in the near future to determine this point. Perhaps a combination of the two methods, that is, preliminary oxidation with chemicals in water and post-treatment of the cyanide residues with sulphide solutions, may bring better results than either used singly.

While a few of the satisfactory results obtained by preliminary oxidation were those of large tests (about 75 tons), the greater part were from small lots (from 1 kilo. to 100) and will only be proved or disproved after a continued run on a milling scale of the same ore that formerly gave unsatisfactory results by ordinary cyanidation.

The concentration of this ore by flotation has given some most interesting and satisfactory results, which I shall present at some future date.

THE TWO GREATEST METAL-PRODUCING STATES west of the Mississippi river in 1915 were Arizona and Montana. The output of each was nearly \$90,000,000 in copper, zinc, gold, silver, and lead, as compared to \$60,000,000 for Arizona in 1914 and less than \$50,000,000 for Montana. This output of minerals is exceeded by States east of the Mississippi that produce large quantities of coal and iron ore, and by California's figure of \$95,000,000 including oil to the value of \$40,000,000.

Machinery for Cyaniding Flotation Concentrate

By A. E. Drucker

INTRODUCTION. Since flotation is likely to play a prominent part in the treatment of gold and silver ores, the cyaniding of concentrate on the spot will be of increasing importance. I do not think that flotation will be a cure-all. It will be applied mainly to the treatment of the slime of sulphide ore. Heretofore the methods of concentrating slime on tables, vanners, and buddles have not been efficient. The slimed sulphide escaping in many cases largely accounts for the comparatively low recovery by concentration. Flotation should be the remedy, while tables will continue to treat the coarser products of sand free from slime.

TREATMENT. As far as the cyanide process is concerned, two distinct concentrated products would be obtained with a plant employing sand-tables and slime-flotation cells: table-concentrate, containing coarse sulphide mineral, would require fine grinding with cyanide solution in a tube-mill direct; flotation-concentrate, consisting of very fine mineral, would in the majority of cases not require further grinding prior to cyanidation.

Charles Butters has already pointed out* the difficulty of cyaniding flotation-concentrate where an insoluble oil has been employed. Sulphide particles coated with a thin film of insoluble oil would certainly prevent cyanide solution from coming into contact with the gold and silver. In order successfully to cyanide such a product, some soluble oil that can be readily dissolved by a preliminary treatment is necessary. Oil allowed continuously to enter a solution would soon cause it to become foul and rotten. This should be avoided.

In order to obtain over 90% of the gold value from a sulphide that is amenable to cyanide treatment in a reasonable time (48 hours), it is necessary to grind to 200-mesh. In some cases it would be necessary to pass 300-mesh, while in some exceptional cases (gold telluride and silver ores) where the metals are chemically combined with the sulphide, the finest grinding would not suffice. A preliminary roast would be required.

Concentrate taken directly from tables and not allowed to oxidize can be passed to the tube-mill and ground in cyanide solution without any previous alkaline or water washes. I recommend all minus 200-mesh products to receive a thorough air-agitation in solution followed by counter-current decantation, and vacuum-filtration. Zinc-dust precipitation in Merrill presses of the resulting gold solution, I have found most satisfactory. The presence of small amounts of copper in the solution does not interfere. Strong cyanide solution (0.2 to 0.3%) with a high protective alkalinity gives

the best result. I have found the Aldrich electric cell installed in the barren-solution feed-tank to tube-mill a benefit. Various reducing agents in solution are kept at a minimum.

The general method of treatment which I suggest for the average concentrate is given in the accompanying flow-sheet.

I shall now discuss the most suitable cyanide machinery, and the most improved and simple plant to treat an average concentrate. My decision is based on

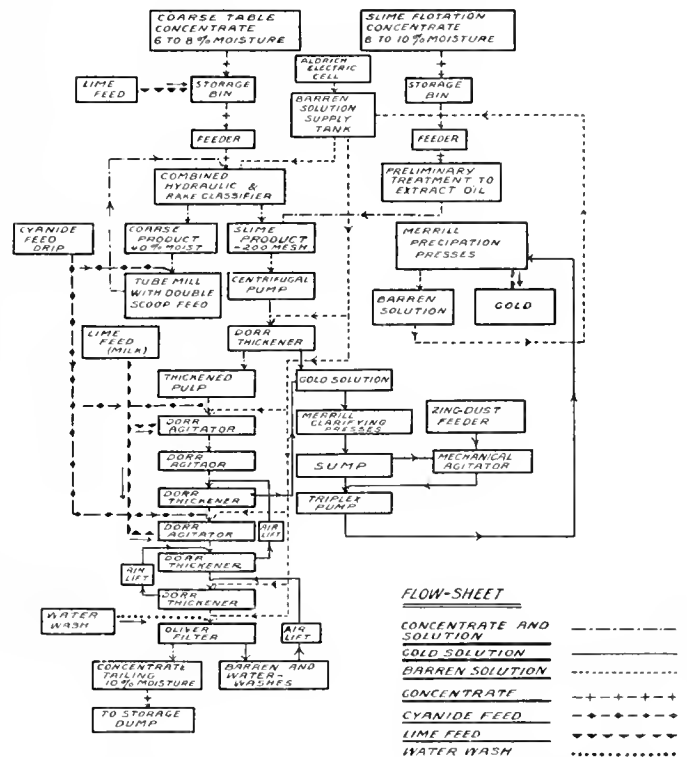

some years of experience in the U. S. A., Mexico, Korea, and Colombia, as well as from the examination of plants in Australia, New Zealand, and South Africa.

GRINDING MACHINERY. For fine-grinding concentrate there are available tube-mills, conical mills, and pans.

Conical mills and pans are good intermediate grinders up to 100-mesh, and to this point they are economical.

The tube-mill in sizes of 3 by 12 ft., 4 by 16 ft., and 5 by 20 ft. would be the more economical and efficient machine for all-slimes (-200), such as is required for concentrate. It is the best all-slimes mill on the market.

CLASSIFIERS. For classifying concentrate prior to fine grinding we have: Callow or Caldecott diaphragm-cones, hydraulic classifiers, Dorr or Akins mechanical classifiers, and the combined hydraulic and rake classifier.

*M. & S. P., November 29, 1915.

Diaphragm-cones and hydraulic classifiers require too much attention in order to produce at all times a uniform feed to the tube-mill. They return too much fine material and are a continual source of trouble.

Dorr and Akins classifiers require little attention and will deliver a uniform feed with 20 to 30% moisture. The chief objection to these machines, when dealing with a heavy sulphide concentrate, is the delivery to the tube-mill of a considerable amount of fine material that does not require finer grinding.

The combined hydraulic and rake classifier in closed circuit with a tube-mill will produce a feed of 30 to 35% moisture. It is easily adjusted to any product and is the most suitable machine for treating concentrate.

PUMPS AND ELEVATORS. For conveying concentrate containing from 6 to 10% moisture, belt and push conveyors are used, while for elevating purposes belt-bucket elevators are common. Elevators are a source of trouble, and if possible should be avoided.

A variety of different pumps is on the market for elevating pulp, but those that are really good are few. Machines used for this purpose are the Frenier spiral, centrifugal, three-throw plunger, air-lift, bucket-elevator, and tailing-wheel.

The Frenier is satisfactory for low lifts up to 8 to 10 feet.

A three-throw plunger pump will give trouble with sandy material. The valves cut out quickly and the packing requires renewing often. Air-lifts are simple, but require large quantities of air for ordinary lifts of 8 to 10 feet.

The old tailing-wheel gives the least trouble of all. It is reliable and the cost of repairs is low. The one objection against it is the high first cost to install.

For moving sand a well-designed centrifugal pump with white cast-iron liners, easily accessible for replacing worn-out parts, will give good satisfaction; the Byron-Jackson pump is an example.

AGITATORS. For the agitation of heavy sulphides we have a choice of the old mechanical agitator with plow-shees revolving at 16 to 18 r.p.m., the Pachuca, or the Dorr machine.

The old mechanical agitator requires too much power to operate.

The Pachuca or Brown agitator is an efficient machine for concentrate, but in the majority of cases the cost of pumping the pulp into these tall tanks is the one serious thing against them. It has also the disadvantage of being costly to erect.

A Dorr agitator, in my opinion, is cheapest in first cost, requires less power, and will operate with the least amount of trouble. It is my choice for a concentrate ground to pass a 200-mesh screen.

The Trent or Hendryx machines are not suitable for heavy sulphide material.

THICKENERS. Apparatus available for thickening pulp prior to agitating and filter-pressing are the old sets of pointed boxes, Callow cones, and Dorr thickeners.

Callow cones or pointed boxes have a low capacity,

and many would be required to do the work of one Dorr thickener of 30-ft. diam. Consequently many separate spigot-discharges would require constant attention in order to obtain a clear overflow and thick underflow.

The Dorr thickener is, I think, the best. It requires only 1 hp., and operates continuously without trouble. The cost for repairs is practically nothing.

FILTER-PRESSES. For the treatment of heavy sulphide we have the Oliver vacuum-filter, the Kelly, and Dehne pressure-filters.

Dehne presses are used extensively for concentrate in Western Australia and at Waihi, New Zealand. Three-inch cakes are formed at 40 lb. pressure and are washed satisfactorily.

The Kelly press is used at the Goldfield Consolidated and the Alaska Treadwell with satisfactory results.

The Oliver filter is now used more than any other for filtering and dewatering concentrate (8 to 10% moisture) in connection with the cyanide and flotation processes. The thin uniform cake ($\frac{1}{4}$ to $\frac{1}{2}$ inch) certainly permits of a more perfect wash than does the 3-in. cakes in a Dehne press. It is the most suitable filter for concentrate.

CLARIFIERS. For clarifying solution prior to precipitation, we have the sand-filter tank or the Merrill clarifying press.

Sand-filters are in common use. An extra tank is always required in reserve; a plant of ample capacity occupies a large floor-space and is expensive to erect.

The Merrill press occupies a small floor-space, has a large capacity, and is readily cleaned without opening the frames.

PRECIPITATION. We have our choice between the ordinary extractor-box, using zinc-shaving, or the Merrill precipitation press, using zinc-dust.

Zinc-boxes are efficient, but occupy considerable floor-space, and are not simple when it comes to the clean-up. There is always the aggravating problem of the 'zinc shorts.'

Merrill presses are compact, thief and fire proof, and allow a quick clean-up. In precipitating strong (0.2 to 0.3% KCN) and rich solution with concentrate treatment, they give good satisfaction.

SOLUTION-PUMPS. Centrifugal, three-throw plunger, and air-lift pumps are in common use for elevating solutions.

Centrifugals are probably used more than any other for elevating to heights of 10 and up to 50 ft. They require considerable attention owing to their high speed.

A three-throw plunger will pump solution to a height of 100 ft. or more. They require little attention, and are economical in every way. I prefer them to centrifugal pumps.

The air-lift is suitable for lifts not exceeding 10 ft., and is particularly useful about a plant using the counter-current decantation process where the lift would not exceed 2 to 3 $\frac{1}{2}$ feet.

PLANT. For concentrate, I recommend a plant consisting of a tube-mill with combined hydraulic and rake

classifier in closed circuit, Byron-Jackson sand-pumps, Dorr agitators and thickeners for continuous counter-current decantation, Oliver filters, Merrill precipitation and clarifying presses, and triplex plunger-pumps for solution.

If possible, the plant should be erected on a side-hill, allowing ample fall throughout. It is well to figure on sufficient dumping-ground below the plant in order to store tailing for a possible future re-treatment.

Every effort should be made toward simplicity of design, and to have as near as possible an all-gravity arrangement. By so doing, the use of troublesome bucket-elevators and pumps can be avoided largely. What does it matter if one is obliged to elevate solutions 60 or 70 ft. from sump to supply tank in order to obtain the desired gravity arrangement?

COSTS AND EXTRACTIONS A modern concentrate-plant such as the one recommended in this article would cost from \$800 to \$1200 per ton of capacity per 24 hours, depending upon the cost for transport, labor, and material.

Treatment costs per ton of concentrate will vary between \$2.50 and \$5, depending upon tonnage, cost of supplies delivered at plant, and labor.

The extraction of gold with the all-sliming process would vary between 90 and 97% on a raw concentrate that is amenable to cyaniding. The Oriental Consolidated, Alaska Treadwell, Esperanza, Waihi, and others are examples.

Simple Test for Nickel

The following directions for a test for nickel have been prepared by W. C. Wheeler, of the U. S. Geological Survey:

Grind to a fine powder a sample—2 or 3 grams (30 to 40 grains); treat in a test-tube with a few cubic centimetres of *aqua regia* (a mixture of 1 part nitric acid and 3 or 4 parts of hydrochloric acid), and boil nearly to dryness; then add enough nitric acid and water to dissolve all soluble substances. Filter if necessary. Dilute to 10-15 cc. (about one-third the contents of a test-tube 6 in. long and $\frac{3}{4}$ -in. diam.), add a gram or more (half a teaspoonful) of citric acid (solid), and dissolve by heating. Make the solution slightly ammoniacal, noting that it should contain no precipitate. To the slightly ammoniacal solution add about 2 cc. (a half teaspoonful) of 1% alcoholic solution of dimethyl-glyoxime. A voluminous scarlet precipitate indicates nickel. The *aqua regia* solution is boiled nearly to dryness to remove from it the large excess of acid and anything, such as hydrogen sulphide, that would cause the precipitation of iron, cobalt, nickel, etc., in the ammoniacal solution. The citric acid will prevent the precipitation of iron and aluminum as hydroxides, but will not prevent the precipitation of sulphides of iron, cobalt, nickel, and some other metals in the ammoniacal solution. If a brown precipitate of iron forms after the solution is made ammoniacal, it contains an insufficient quantity of citric acid.

Notes on Molybdenum

In identifying minerals a knowledge of their characteristics may be as valuable as chemical tests. A short description of molybdenum minerals is given by Frank L. Hess of the U. S. Geological Survey, in 'Mineral Resources.'

Three molybdenum minerals are fairly common—molybdenite, wulfenite, and molybdenum ochre. Molybdenite, molybdenum sulphide, MoS_2 , containing 60% molybdenum, occurs in thin, bright, lead-colored flakes, which bend readily but are not elastic and are easily scratched by the finger nail. The flakes may be so minute that they coat a surface like paint, or they may be several inches across, and they may be regularly bounded by straight lines and piled up into doubly terminated hexagonal crystals. The mineral, however, is more likely to be found in irregular lumps, easily cleavable into thin leaves. Its specific gravity is about 4.5.

Molybdenite is associated with many kinds of rocks and veins, but occurs most plentifully in association with granitic rocks, especially with granite pegmatites. The deposits are invariably pockety.

Wulfenite, lead molybdate, PbMoO_4 , contains 39.3% MoO_3 . It usually occurs as lustrous resinous yellow, orange, or red tetragonal crystals in the oxidized parts of lead deposits. It may be greenish or brownish, grayish, whitish, or colorless. The crystals are generally platy, but may be nearly cubes or double pyramids. The mineral is very brittle. It has a hardness of 2.75 to 3 and a specific gravity of 6.7 to 7.

Molybdenum ochre, hydrous ferric molybdate, $\text{Fe}_2\text{O}_3 \cdot 3\text{MoO}_3 \cdot 7\frac{1}{2}\text{H}_2\text{O}$, generally forms a bright yellow powdery mineral, though it also appears in small radial crystals. It is a weathering product of molybdenite, but is probably never found in sufficient quantity to be of commercial value.

Powellite, calcium molybdate, CaMoO_4 , is a white or grayish mineral formed by the weathering of molybdenite. In some specimens tungsten replaces a part of the molybdenum. Like molybdenum ochre, it is not found in deposits of sufficient size to be of commercial value.

Any of these minerals, except molybdenite, may be tested by heating a small piece in a porcelain crucible (a particle half the size of a grain of wheat is enough) with a drop of sulphuric acid until the fumes have nearly ceased. When the crucible has cooled, it will have a beautiful deep blue coating.

Molybdenite must be oxidized before it can be tested in this manner. It may be oxidized either by boiling it to dryness with two or three drops of nitric acid or by powdering and roasting it in the air for a few minutes. The sulphuric acid is then added and the test performed as indicated.

When molybdenite contains no mica, or other substances harmful to steel and difficult to separate, it is most valuable.

Prospecting for Phosphate Rock

*In prospecting for phosphate rock in the Rocky Mountains, the search should be confined to rocks, generally limestone, near the top of the Carboniferous system. In the central portion of this area the formations in which phosphate is most likely to be found are easily recognized.

One of the chief difficulties that presents itself in prospecting for phosphate in the Rocky Mountain region of Canada is that of recognizing the rock when it is found. It bears a close resemblance in appearance to the limestones and magnesian limestones, as well as to certain of the cherts found abundantly in Upper Carboniferous strata. The prospector should provide himself with acid and employ it freely. An excellent receptacle for this purpose is one of the larger bottles in which ink for safety-pens is sold. These are provided with a rubber cork, pierced by a glass tube drawn out to a narrow opening at one end with a collapsible rubber bag at the other. The whole is enclosed in a light wooden case with a screw top. The bottle should be filled with hydrochloric acid diluted with an equal volume of water.

In examining any specimen of dark rock a few drops of acid should be dropped on it. If effervescence results, the rock is limestone. If not, the specimen should be pounded with the hammer to bruise it, and the powder so produced should be treated with the acid. If it now effervesces, it is a magnesian limestone. If it still shows no effervescence, scratch it with a hammer or knife. If a narrow line having a bright metallic appearance is traced on the surface of the rock, it is harder than the steel and is a chert or fine-grained quartzite.

If the specimen belongs to none of these, it should be examined with a lens, when, if phosphate rock, it will probably show a surface studded with minute black spheres or circles. This is the oolitic structure. The rock, if massive, will be distinctly heavier also than common rocks. Sometimes upon breaking it a fetid odor can be noticed. In order to be certain that the specimen contains phosphoric acid, it is necessary to make a chemical test as follows:

Powder some chips of the rock in a mortar until the material will pass a 100-mesh sieve. Place as much of the powder as can be taken up readily on a 25-cent piece in an ordinary small enameled cup, add 30 cc. water and 10 cc. concentrated nitric acid. Filter, or decant the fluid if it is clear, into a glass beaker, and add 100 cc. water, then a little saturated solution of ammonium carbonate. This will probably make the clear solution somewhat cloudy. Nitric acid should then be added drop by drop until the solution clears again, and gives a faint but distinct acid reaction with blue litmus paper.

*Abstract from 'Discovery of Phosphate of Lime in the Rocky Mountains,' by Frank D. Adams and W. J. Dick, published by the Commissioner of Conservation, Ottawa, Canada, 1915.

The solution is then warmed to a temperature of 70 or 80° C., and 50 cc. of a concentrated solution of ammonium molybdate is added, drop by drop, while the solution is being stirred. This solution is allowed to stand in a warm place for 15 minutes; if phosphoric acid is present, a bright yellow granular precipitate of phosphomolybdate of ammonia will appear.

If it is desired to determine approximately in the field the proportion of phosphoric acid, the following method, essentially that used by the U. S. Bureau of Soils in the examination of the phosphate beds of the West, may be employed:

The sample is crushed in an iron mortar, pulverized in a small porcelain mortar, and finally put through a 100-mesh screen. Two grams of the powder is weighed and brushed into an enamel cup; 25 to 30 cc. water is added, and then 10 cc. concentrated nitric acid. The cup is covered with a watch-glass, placed on an iron plate over a coal-oil burner, and the contents allowed to digest for seven or eight minutes. After cooling somewhat, the insoluble material is filtered, washed thoroughly on the filter, and the filtrate made up to 200 cc. with water. This solution is thoroughly mixed, and 20 cc. of it is taken for analysis. This is diluted with 30 cc. water and a little saturated solution of ammonium carbonate is added; then sufficient nitric acid to dissolve any precipitate and render the solution acid. The beaker is placed on the hot plate, heated to 70 or 80° C., and 100 cc. concentrated solution of ammonium molybdate is added, drop by drop, with constant stirring. After standing 10 minutes, the solution above the precipitate of ammonium phosphomolybdate is decanted and filtered, and the precipitate washed until the washings give no acid reaction. The filter and its contents are then returned to the beaker, a little water added, and then a standard solution of potassium hydroxide from a burette until the yellow precipitate dissolves. A few drops of phenol-phthalein are added and standard nitric acid (matched against the potash solution) is run in from a burette, drop by drop, until the pink color of the indicator—phenol-phthalein—disappears. The quantity of nitric acid used, subtracted from the amount of potassium hydroxide, gives the number of cubic centimetres of the latter solution required to dissolve the yellow precipitate. The potassium hydroxide employed should be of such strength that 1 cc. equals one milligram of phosphoric acid.

In order to be certain that all the phosphoric acid has been precipitated, it is well to add another 25 cc. of the ammonium molybdate solution to the clear filtrate from the yellow precipitate, and allow the beaker to stand on the warm plate for another half-hour. The standard solution of potassium hydroxide, as well as the standard nitric acid, should be carefully prepared in a laboratory, and taken into the field in stout-stoppered glass bottles.

DIVIDENDS paid by American mining companies in 1915 totaled \$75,383,387, compared with \$60,323,529 in the year 1914.

Emergency Repairs for Rock-Drills

By Wm. H. Washburn

At a mine at Sealevel, Alaska, the pistons and cylinders of the rock-drills became worn, and leaked so much air as to seriously impair their efficiency. The necessary repair-parts could not be expected to arrive within a month owing to the delays incident to distance, which included 700 miles of steamer-transport from the source of supplies. Meanwhile, we undertook to make such temporary repairs as would tide us over. The pistons were of solid steel, without expansion-rings, and it was necessary to enlarge them to fit the cylinders. We procured some block tin from the cannery near Ketchikan. After cleaning one of the pistons thoroughly and dipping it in hydrochloric acid, it was immersed in melted tin, and we succeeded in making a coating, about $\frac{1}{8}$ inch thick, adhere to it perfectly. A lathe in which the tin-coated piston could be turned to fit the cylinder was now necessary. A piece of 1 by 6-inch iron was bent to the form, shown at *A*, for the frame, in which $\frac{3}{4}$ -inch holes were drilled and tapped at *bb* to receive the head and tail

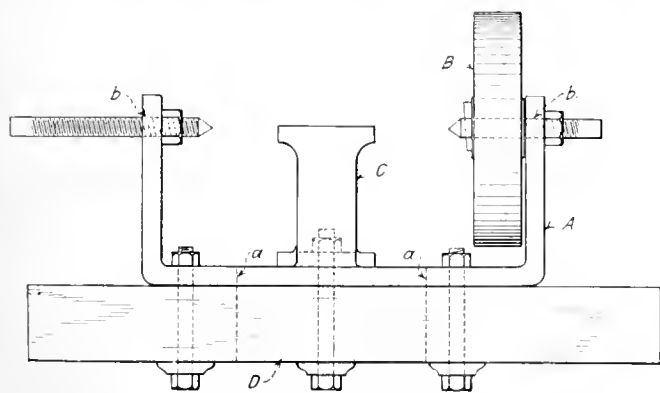

AN IMPROVED LATHE.

centres. These were held firmly in place by jam-nuts. On the head-centre was mounted a loose wooden pulley *B*, run by a belt, by which the piston was revolved by means of a lathe-dog, in the usual way, holes being bored in the pulley for the dog. Both centres being dead, and held solidly in place by jam-nuts, the piston was revolved without vibration, while being turned. A 1-inch slot was made in the base of the frame and the base-plank *D* from *a* to *a*, to receive the bolt holding the tool-rest *C* in place. The tool-rest was made of a piece of $\frac{3}{4}$ by 3-inch iron, the end of the part resting on the base of the frame being split and spread, to make it more rigid. With this machine, the piston was turned by a hand-tool to a perfect fit. When the drill was tested in the mine, it seemed to work as well as new. The rest of the drills were then repaired in the same way, until they were all doing efficient work.

The tin coating on the pistons wore better than expected, being still in good condition, when the repairs that had been ordered arrived a month later. By set-

ting up a movable support for the tail-centre, inside the frame, the distance between the centres was shortened, so we turned out several air-valves for the drills, to replace some that were worn, and not working well. These valves were made of tool-steel having several annular grooves in them, and were only 4 inches long. They proved satisfactory in operation. Later we found this home-made lathe to be useful at various times, when making minor repairs on other machinery.

CANNON are discussed in a recent issue of the interesting periodical *Through the Meshes*, published by a manufacturing firm at Cleveland. The 42-centimetre (16.53-in.) mortar, which no war correspondent has ever seen, is stated on the authority of a German officer to be as high as a six-story building, when the gun is elevated and ready for shooting. The caterpillar-tractor wheels are probably 30 ft. diameter. The so-called photographs of 42-em. guns published in the newspapers are only the 30.5-em. Skoda howitzer. Many people appear to believe that a cannon is aimed by sighting along its barrel; on the contrary, artillery fire can be directed only by a man possessing a thorough knowledge of trigonometry, geometry, and calculus. But the guns of today are not the first cannon of large bore. At Ghent, in 1411, a cannon of 25-in. bore, 18 ft. long, weighing 13 tons, was constructed of wrought-iron bars held together by iron rings. This fired a 700-lb. granite ball. In 1468 at Constantinople, 19-ton bronze cannon of 19-in. bore were used, to fire a stone weighing 600 to 700 lb.; they were so unwieldy that they had to be retained in one position, and were kept loaded for months at a time. With these cannon the Turks killed 126 sailors and nearly wrecked six British men-of-war in 1807, when Sir John Duckworth retreated from the Sea of Marmora. Previously, at the siege of Constantinople in 1453, Mohammed II, who conducted the siege, constructed a bronze mortar of 36-in. bore that fired a 600-lb. stone. A caravan of 60 oxen and 200 men worked two months hauling this gun 150 miles to the scene of action. The trial shot hurled the stone a mile and buried it six feet in the ground. This ponderous cannon could be loaded and fired only seven times per day, but finally it became overheated and burst. At Waterloo, 101 years ago, the artillery range was but 1200 yards at the beginning of the battle, and only 200 yards before the battle was over. In Nelson's day, firing at a range of 1000 yards at sea was considered an extreme distance.

SALT LAKE CITY has a population of 100,000, an altitude of 4250 ft., and is ten miles from Great Salt Lake. When the city was founded in 1847 by the Mormons, two years before the gold rush to California, the whole plateau region lay far beyond the advancing wave of western civilization, and the settlement was an isolated oasis in a vast desert. Today the city is an important centre and distributing point for mines in Utah, eastern Nevada, and southern Idaho. Great Salt Lake is $6\frac{1}{2}$ times 'saltier' than the ocean, containing 22 $\frac{1}{2}$ % of solids.

Leaching Copper at the New Cornelia, Arizona

The following notes are from the report of the general manager of the Calumet & Arizona Mining Co., J. C. Greenway, for 1915. They refer to results of experiments conducted during the past 18 months on the oxidized copper ore at Ajo, and briefly describe the large leaching plant that is being erected to treat 20,000,000 tons of 1 1/2% copper ore.

Process work was continued throughout the year. A 40-ton experimental plant was completed on January 31, and immediately put in operation. To December 31 there had been leached 291 charges, or approximately 12,222 tons. There were two distinct periods in this work. The first was from the starting of the plant on February 1, to charge No. 81. It was then decided to waste the entire supply of the solution in the system and begin with new solution. Charges No. 82 to 90, inclusive, were discarded. The second period began with charge No. 91 and continued throughout the year.

Results for the first period were as follows:

| | |
|--------------------------------|-------|
| Average heads, copper per cent | 1.248 |
| Average tails, copper per cent | 0.294 |
| Average extraction, per cent | 71.4 |
| Average pounds per kw. h. | 0.72 |

The second period gave the following results:

| | |
|--------------------------------|-------|
| Average heads, copper per cent | 1.337 |
| Average tails, copper per cent | 0.256 |
| Average extraction, per cent | 80.6 |
| Average pounds per kw. h. | 0.958 |

The 1-ton plant was operated from August 8, 1914, to November 3, 1915, with the following results:

| | |
|--------------------------------|-------|
| Average heads, copper per cent | 1.325 |
| Average tails, copper per cent | 0.283 |
| Average extraction, per cent | 79.0 |
| Average pounds per kw. h. | 1.125 |

In the belief that these results amply justified the immediate construction of the permanent plant, an appropriation of \$4,200,000 was recommended in December to the directors and was granted.

The construction work now under way, and which, when completed, will put the New Cornelia property on a production basis of 36,000,000 lb. of copper per year, may be briefly described as follows:

This mine will be opened so that three 100-ton steam-shovels can be used for loading the ore into cars. The ore will be hauled approximately one mile to the treatment-plant, where it will be dumped directly from the cars into a large gyratory-crusher. Five 70-ton switch-locomotives and fifty 20-yard side-dump cars will be used on this mine service and ore-haulage.

The coarse-crushing plant will be equipped with one No. 24 gyratory-crusher, four No. 8 gyratory-crushers, driving-motors, and an electric traveling-crane.

From the coarse-crushing plant, the ore, reduced to about 3 1/2 in., will be conveyed to the fine-storage bins having a storage capacity of 10,000 tons.

From the storage-bins the ore will be conveyed to the

fine-crushing plant, where it will be reduced to 1 in. This plant will contain 12 Symons disc-crushers and an electric traveling-crane, with the necessary motor equipment. An ore-sampling plant will be erected between the fine-crushing plant and the leaching-plant.

From the crushing-plant, the ore will be conveyed to the leaching-vats, where it will be bedded in even layers through the tank being filled. There will be 11 lead-lined leaching-vats, each 88 ft. square by 15 ft. deep inside, having a capacity of 5000 tons of ore each, and one sludge-tank of the same dimensions. Each vat will have its pumping equipment for circulating and advancing its solution at the rate of about 8000 gal. per minute. The leaching-vats will be arranged in two rows with a central structure between, which will support the conveyors carrying the ores to them, and the circulating pumps and necessary launders. After the copper is extracted from the ore and the tailing washed and drained, it will be loaded into cars by an excavator of the Hulett type. The tailing will be hauled to the dump in side-dump cars on the afternoon shift, the cars and locomotives used at the mine on the morning shift being available for this service.

This plant will have five wash-water and acid-solution storage-tanks of 430,000 gal. capacity each.

The neutral solution from the leaching-plant will be pumped to four sulphur-dioxide absorption-towers, approximately 20 ft. diam. and 40 ft. high, for the reduction of the ferric iron to suit the requirements of the electrolytic plant. From the absorption-towers, the solution will be pumped to the electrolytic-plant, where it will be circulated through the electrolytic-cells and the acid solution returned to the leaching-plant. The tank-house will consist of two main aisles each 80 ft. wide and 270 ft. long, and will contain 152 lead-lined electrolytic-tanks approximately 30 ft. long, 4 ft. wide, and 5 ft. deep, with the necessary cranes, pump-circulating equipment and sumps.

The power-plant building will be of steel and concrete, approximately 126 ft. wide by 200 ft. long. The boilers and turbines will be in the same building, but separated by a partition. The boiler-room will contain five 822.6-hp. Stirling boilers set for oil-firing, economizers, and feed-water equipment. The turbine-room will contain two 7500-kw. steam turbines, the motor-driven direct-current apparatus for the electrolytic-plant and the switchboard.

The plant will be provided with a water-storage tank of 300,000 gal. capacity at a suitable elevation. Two oil-tanks of 15,000 bbl. capacity each, and four acid-tanks of 150,000 gal. will be provided and arranged with reference to the unloading tracks so that oil and acid will flow by gravity directly from the cars to the tanks.

Further work will be done in water development, and an electric-driven pump, with a capacity of 750 gal. per minute will be installed at No. 1 well. A 10-in. pipeline will be laid from No. 1 well to the storage-tank at the plant. A general office and laboratory will be added to the plant.

CONCENTRATES

Readers of the MINING and Scientific PRESS are invited to ask questions and give information dealing with technical and other matters pertaining to the practice of mining, milling, and smelting.

GOLD-AMALGAM from the Brunswick mill, Grass Valley, California, yielded 39.3% gold in 1915. In crushing 22,004 tons of ore, 12,046 oz. of quicksilver was fed to the batteries.

MALAPAI, the name given in Arizona to the dark volcanic rock, usually in the form of lava-flows, capping a *mesa*, is a corruption from *malpais*, meaning bad lands, from the Spanish *mal*, bad, and *pais*, country. The rock is generally a variety of basalt.

SHAREHOLDERS are free to re-locate mining claims abandoned by their companies. A shareholder does not stand in the relation of trustee to his fellow shareholders, but a director or other officer of the company does stand in that fiduciary position and therefore cannot re-locate a claim under such circumstances. This has been decided by the courts.

IN LOCATING mining claims on lands within the limits of railroad grants, it must be kept in mind that if railroad patents have already been issued, these patents are controlling until set aside in appropriate proceedings brought usually on the part of the United States Government to cancel such patents on the ground that they have been issued through fraud, mistake, etc. There is also a time limit and such patents can not, in the absence of fraud, be attacked if 6 years have elapsed after the date of the issuance of the patent. As to whether fraud on the part of the railroad company suspends the running of the statute is a question now before the Supreme Court of the United States for determination.

LABOR LIENS. A correspondent refers to the case of *Dahlman v. Thomas*, 153 Pac. 1065 (Wash.) This case held that the owner of mining property was liable for liens for labor performed at the instance of persons holding an option on the property, even though the option contract was recorded and a notice posted on the mine in the name of the owner, disclaiming liability. The case held in substance that where the owner benefits by the improvements placed upon the mine in pursuance of the terms of the option, that this provision practically makes the prospective purchaser the agent of the owner. This case was decided December 18, 1915, by the Supreme Court of Washington on an appeal from the Superior Court of Whatcom County, Hon. Ed H. Hardin, Judge.

TUNGSTEN DETERMINATION by a quick method is that of W. J. Faust of Deadwood, South Dakota. He uses a fusion-powder containing potassium chlorate, potassium nitrate, sodium carbonate, and sugar. Taking about 1 gram of this powder, mixed with an equal amount of crushed ore (if the ore is low grade using pannings) an almost instantaneous fusion is effected by applying a

match. The result of the fusion is a granular mass, which is rubbed a moment in an agate mortar, then placed in a test-tube with hydrochloric acid and sheet or granulated-zinc. A little boiling will yield a blue-colored solution if tungsten is present. The test is one that can easily be made in the field; the equipment necessary to conduct it can be carried in a coat-pocket and it no doubt will be widely used by prospectors.

MERCURY occurs in Cobalt, Ontario, ores according to investigation by G. H. Clevenger in *Economic Geology*. It was first identified there in 1910, during experiments in treating the high-grade silver ore, when something interfered with accurate estimations. When the Nipissing refinery was completed, and the first charge treated, the mercury collected in the flue convinced skeptical metallurgists and others that the metal did exist in the ore. Twenty-two determinations on Nipissing ore yielded from 0.26% in certain ore to 4.74% in nuggets, one La Rose nugget yielded 1.34%, one nugget from the Coniagas jigs gave 1.48%, leaf-silver at the Chambers-Ferland 0.8%, and O'Brien tetrahedrite 0.5 to 0.58%. Generally the purer forms of leaf silver contain less mercury than the more impure nuggets, containing more antimony. Individual masses of the metallies show considerable variation in the percentage of quicksilver, but ore mixtures as treated in the mill show a far more regular content. It seems that mercury occurs as an amalgam, rather irregularly distributed in the metallic portion of Cobalt ores, with a tendency for the dyscrasite to contain more quicksilver than the purer forms of silver.

MINERAL LANDS. There was a period of time when considerable doubt existed as to the application of the words, "mineral lands," contained in the railroad grants. The Department of the Interior was at first inclined to the view that this term used in the reservation clauses applied only to the more valuable metals. The question however has been set at rest by the Supreme Court of the United States, which has held that "mineral lands," as used in these Acts, "include not merely metaliferous lands but all such as are chiefly valuable for their deposits of a mineral character, which are useful in the arts or valuable for purposes of manufacture." The case in which this question arose involved a deposit of granite, and this substance was included in the general category of building-stone, and the Land Department has held that marble, slate, limestone, and sandstone come within this classification. Lands containing these deposits to be exempted from the railroad grants must contain the substances in such quantity and value that they are the subject of location under the mining laws. The Land Department has frequently applied the test that they must be of special value as distinguished from the surrounding country. In other words, a location of granite in territory where the entire surrounding formation is granite, would not satisfy the requirement of a mineral deposit of special value, sufficiently to justify a mining location.

REVIEW OF MINING

As seen at the world's great mining centres by our own correspondents.

LEADVILLE, COLORADO

PROGRESS AT THE HARVARD—ELEVATION AND HIGH METAL PRICES

REGAIN THE ALICANTE AND WILSON MINES—ELEX BEILER
RUBY, LITTLE EDEN, AND THE SHAVER KING.

The Leadville Unit of the United States Smelting, Refining & Exploration Co. began pumping through the Harvard shaft on Fryer hill at noon on March 29. Delivering 1500 gal. per minute, the pumps are gaining an average of 12 ft. a day on the water. The shaft is 157 ft. deep, and before pumping the water-level stood at the 219 ft. mark, leaving 167 ft. to be drained. At the present rate it would require only two weeks to upwater the property, but as water is lowered the efficiency of the pumps is decreased. Draining of the immense stopes

pleated while pumping is in progress. A new air compressor is being installed for sinking. A large double drum hoist, with a lifting power of 5000 lb. at the rate of 400 ft. per minute has just been put on its foundation, and will soon be ready. A complete machinshop is being equipped, and a permanent pumping plant for the bottom station is being assembled.

The quick work of Mr. Lee in getting started at the Harvard has aroused admiration among local mining men. It took just 14 days to erect a surface plant, repair the shaft, cut a station, install machinery, and get the pumps in operation, all in severe and stormy weather.

The Denver Mining & Milling Co., with E. T. Miller and O. H. Cold as manager and superintendent, has taken a long-term lease and option on the old Alicante property near Wortman, on the main line of the South Park branch of the Colorado & Southern, about 10 miles north of Leadville. The property was more recently known as the John Reed, and was operated by the Burma Mining & Milling Co. several years ago. The Burma company did extensive development in the mine, sinking a shaft of 150 ft. and driving over 500 ft. on the vein. A huge deposit of low-grade lead-zinc ore was opened, and a large mill equipped with rolls and Wilfley tables was erected. This process did not prove successful under the prices offered for the concentrate at that time, and the property was abandoned. The new company from Denver is now installing a complete flotation plant in the mill, a process that has been found to be highly efficient in concentrating the ore. Three carloads of machinery have been unloaded at the siding, which was recently put in to the mill from the main line. The adit will be equipped with modern machinery, as all work will be done through it. The preliminary work is being rushed, and the management reports that the property will be operating early in April. Mining men familiar with the John Reed state that it is one of the biggest low-grade lead and zinc properties in the district. The present metal market is so much higher than that prevailing when the mine was last operated, that the ore cannot now be considered low-grade. With a flotation plant for concentration, the property promises to be one of the most successful in the district. The mill has a capacity of 200 tons per day.

The Progress Mining & Milling Co., an Eastern concern, has taken over the Wilson mine and mill near Robinson. William B. Brooks, one of the early-day mining and milling men of the Leadville district is manager. A large tract of mining land has been secured in connection with the Wilson property, and operation will be on an extensive scale. The ground controlled by the company is rich in lead and zinc ores of comparatively low grade. The Wilson, which is 1100 ft. deep, has been one of the heaviest producers of lead-zinc ore in the district, and when last operated large bodies were exposed. A 250-ton mill stands on the property equipped with Wilfley tables and rolls, a combination that was extensively used throughout the country for concentrating low grade lead-zinc sulphides. This plant is to be replaced by flotation machines that are now being installed in the mill. Mining will be done through the Wilson and Columbus properties, where immense bodies of ore are easily accessible. The company will produce 250 tons daily. An office has been opened at 120 East Chestnut street, Leadville.

Charles J. Moore, well known in the West, and formerly consulting engineer for the Portland company at Cripple Creek,

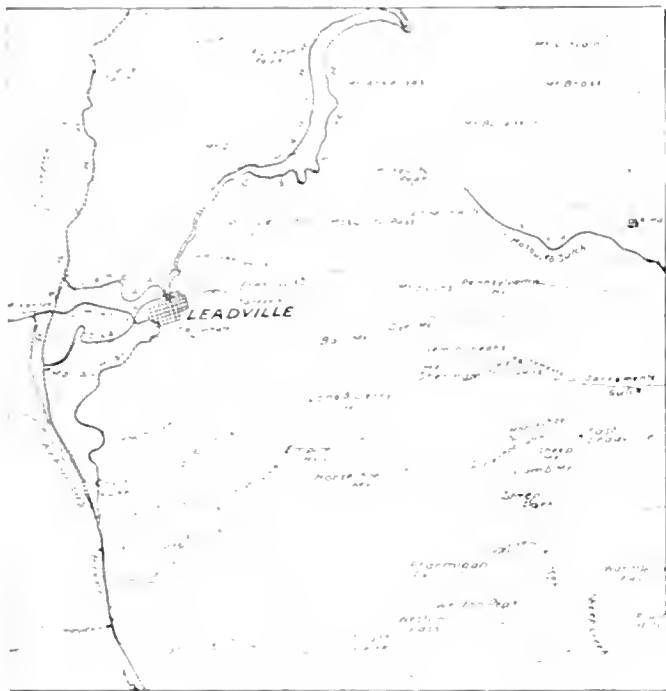

THE LEADVILLE DISTRICT, COLORADO.

and other workings will also retard the lowering of the pumps in the shaft. The manager, H. S. Lee, and superintendent, E. H. Hamilton, estimate that it will require 30 days to drain the workings, providing that all connections with adjoining shafts are open and will allow free passage of water. Otherwise progress will be somewhat slower to avoid danger from rushes of water through partly drained levels. Sinking the Harvard shaft several hundred feet through the parting quartzite into the second contact is expected to commence on July 4. Meanwhile a campaign of thorough exploration will be carried on throughout the territory controlled by the Leadville Unit. As the water is lowered, the workings in all of the shafts in the area will be examined, samples will be taken of all ore exposures, and a comprehensive geological map will be made. Should any orebodies of value be encountered in this campaign, shafts on which they occur will be equipped with machinery. The surface plant at the Harvard will also be com-

is preparing to operate the famous Ella Beeler property near the head of Iowa gulch. Mr. Moore has been associated with mining in the Leadville district for a number of years, and is familiar with the Iowa gulch area where he has operated other properties in the past. The Ella Beeler is one of Leadville's historical properties. In the early 80's the Carlton brothers operated the mine with great success. At that time some of the richest lead and silver ore that has ever been mined here was taken from the Ella Beeler. The ore was found close to the surface, and there never has been extensive development below 300 ft. Mr. Moore will do some deep mining. All of the ore-shoots have been traced to water-level, and there is no doubt that large bodies of rich silver and lead will be opened, following the draining of the mine. A strong company has been organized to finance the undertaking, and it is planned to have the work underway early in April.

The Lanyon Zinc Co., a Colorado mining and milling corporation, composed of a number of well-known Leadville and Denver mining and business-men, has undertaken extensive operations throughout the Leadville district. During the winter the company has been working the Ruby property in the Weston Pass district, where one of the largest zinc carbonate mines in the State has been developed. The Ruby is now equipped with a complete pumping and surface plant and is prepared to operate on a large scale. Several large veins of carbonate have been opened, varying in width from 3 to 7 ft. The ore is all high grade, averaging around 40% zinc. Fifty tons a week has been shipped all winter, but a much larger output is planned for the coming spring and summer. The Ruby is 10 miles from the nearest railroad siding at Hayden, and it has been a difficult task to keep the wagon-road open throughout the winter. Transportation of ore by motor-trucks is being considered by the company, and it is possible that this system will be tried during the summer.—The Little Ellen property near the head of South Evans gulch has also been taken over by the Lanyon company. Prospecting is now in progress, and present indications point to the opening of another large zinc producer. The mine has been one of the rich producers of gold, lead, and copper ores and more recently, zinc carbonate.—The Silver King on Yankee hill, and the Modoc on Carbonate hill are now controlled by the Lanyon company, and the work of cleaning-out the mines is now under way. On the Silver King several promising veins of zinc carbonate have been opened in the adit, which is about 300 ft. into the hill. These veins dip away from the workings, and preparations are being made to sink an interior shaft on the ore.

MEXICO CITY, MEXICO

FRANCISCO VILLA: HIS TRIUMPH AND HIS DOWNFALL.

Now that Villa has the honor of being hunted by a large part of the regular army of the United States, it may be of interest to mining men—always compelled to be students of native psychology and politics—to review the events that have degraded Villa from the triumphant revolutionist of January 1915 to the common fugitive from justice of today.

At the Aguascalientes military convention of October 1914, when Villa found that even his alliance with Zapata had not given him a majority of delegates, he moved his army closer, and obtained by intimidation what was impossible by persuasion, namely, the election of his candidate, Eulalio Gutierrez, as provisional President. Gutierrez, before becoming a revolutionary 'general' had been a foreman in the mines of Bonanza, Zacatecas. Though without formal education, he was intelligent, and his long service with foreign companies had taught him the advantages of wisdom, sobriety, and honesty—qualities rare in Mexico. Therefore, when he arrived in Mexico City in November 1914, to organize the government, he announced his intention of "moralizing" the Revolution, and selected for his cabinet some of the most honorable and best

educated Liberals he could find. The new government functioned smoothly, until Gutierrez found that "morality" did not suit Villa, who was blithely pursuing his own ways of vengeance and pillage in the capital, and regarded the President as merely a convenient marionette. When matters came to a show-down, Villa controlled the army and Gutierrez only saved his head by a flight to San Luis Potosi with a few thousand of his personal troops in January 1915. Owing to disaffection among his northern garrisons, and lack of ammunition for his army and oil for moving his trains, Villa left Mexico City soon after Gutierrez, abandoning the "sovereign" Convention and the capital to the hordes of Zapata, which were then also holding Puebla City and the whole region west to the Pacific coast.

When Carranza withdrew from Mexico City, in November 1914, his cause was apparently lost. But Fortune had not really departed: she had only made herself invisible. He still had the cannon taken from the Federal arsenals of the capital, and the rifles, ammunition, uniforms, and other equipment secured from the mustering-out of the Huerta army in September 1914. Moreover, he had thousands of horses, looted from everywhere, and hundreds of automobiles, mostly lifted from their owners in Mexico City. But best of all he controlled Tampico, which furnished the only motive power of the railroads, and, by sending an ultimatum, he got Bryan to abandon Vera Cruz city and thus secured the chief source of customs revenue in the country.

The two leading generals who had adhered to Carranza were Alvaro Obregon and Pablo Gonzalez, in charge of the North-west and Eastern army divisions, respectively. And Carranza's reviving strength was shown at the opening of 1915 by the capture of Puebla City on January 5 and of Mexico City a month later by the forces of Obregon. During February, Obregon gave the capital a "castigation" for its dislike of Carranza, which culminated with his enlistment of 5000 skilled workmen from the local branch of the Casa Mundial (I. W. W.) and their shipment, along with thousands of their wives and children, to Orizaba to form the Red brigade.

The subsequent career of the Red brigade was both comical and bloody. Sent to garrison Tampico, after a little drilling at Orizaba, it soon was tempted to attack the Villistas at Ebano, an oil town some 30 miles west of the port. Composed as the brigade was of the butchers, bakers, and candle-stick-makers of the capital, who, like the mass of Mexican City workmen, are alcoholic degenerates, it soon fell into a panic when it encountered the disciplined villagers of General Tomas Urbina, who defended Ebano. The panic resulted in flight, hundreds being cut down by Urbina's pursuing cavalry before reaching the port.

In early March, General Obregon evacuated the Capital and moved his army north-west along the Central railway to attack Villa. Pablo Gonzalez, with his eastern division, was left as a rear-guard to keep open communications with Vera Cruz, by way of Pachuca and the Mexican railway; but Mexico City and its connecting railways, nearly as far east as Ometusco, were abandoned to Zapata.

Obregon, with his army of some 14,000 men reached Celaya without trouble, but there he was attacked by Villa with a larger force. But Villa's famous Northern division was not the same army that drove Huerta from Torreon and Zacatecas. Thousands had been killed in those bloody sieges and their places taken by degenerate city recruits. On the contrary, Obregon's army included 6000 Yaqui and Mayo Indians, the best rifle-shots in Mexico, and thus it was able to repulse the attacks of the larger Northern division, even though led by Villa himself.

After the drawn first battle of Celaya, Obregon heeded the request of the foreign consuls and moved his army to some hills outside of town. Here he was soon attacked by Villa, whose army had only retired a few miles west along the Central railway. In this attack on Obregon's chosen position, Villa

fell into a trap and having lost 5,000 men and half of his cannon he was obliged to beat a hasty retreat toward Leon where he had left General Angeles with a small army as a rear guard.

The truth was that success and much newspaper notoriety had turned Villa's head and after the fall of Huerta, he had got to imagine himself to be what his flatterers dubbed him, the Mexican Napoleon. Jealous of the real cause of his success, Felipe Angeles, he had deliberately left him behind in the Celaya campaign. After his defeat, Villa recalled Angeles and most of his northern garrisons and finally mustered an army of some 40,000 men near Leon. Obregon meanwhile had been busy and by drawing the armies of Generals Dignez and Murguía from Guadalajara and several brigades from Vera Cruz he was able finally to equal the number of his enemy. But Villa had the advantage of position, for he had Obregon shut up in Trinidad, the first station east of Leon, and for a week (of the five weeks that the siege lasted) had his communications cut with the Gulf coast.

Though Angeles had Obregon surrounded he was able to do him but little damage, owing to the lack of the cannon lost by Villa at Celaya. Nevertheless, Villa became impatient at the want of results, and had Angeles arrested for incompetence and threatened to shoot him. Diverted from this insane idea by his friends, Villa soon released Angeles, but the aim had been done. The insulted general at once resigned his command and left for the United States.

With Angeles went also his Yankee gunners and with them departed Villa's last chance of victory. Though Villa had still many ex-Federal officers, with a military education, while Obregon had practically no officers but self-taught ones, the autocratic methods of the former negatived the superior skill of his personnel, while the latter never made a move without a council of war.

Obregon now bided his time, and one May morning at dawn he succeeded in surprising Villa's troops in their trenches and in capturing a large part of their cannon and equipment. Next day he entered Leon in triumph while Villa's demoralized army was in full retreat by train toward Aguascalientes.

The defeat at Trinidad broke the power of Villa; it not only lost him his cannon and many of his best veterans, but destroyed his halo as an "ever-victorious" which had previously drawn to his colors thousands of hardy Mexican Liberals and radicals, and many foreigners. His contempt of law and of obregon's "democratic rights" except his own, which had been so glaringly evident in his controversy with President Obiterro, had already alienated much of his Liberal following, and after his defeat, the purely mercenary also began to leave him. Now reduced to a following of a few thousand, Villa has turned like a wild bull at bay and raided the country all round him. It is first discovered his "greatness" and this caused his later ruin. The entrance of Uncle Sam's soldiers may pacify the North and enable mining to resume, but what the South, too, could also be similarly pacified!

DEADWOOD, SOUTH DAKOTA

MINING AND SCIENTIFIC PRESS MINERAL EXHIBITION

A new record is set as to the value of tungsten ores in the Black Hills when on the 17th, the Wasp No. 2 Mining Co. sold 20 tons of mixed tungsten ores for \$30 per unit. The carload was valued at over \$600,000. A new tons of hand-sorted ore, and three grades of concentrates (35, 45, and 65%) made up the lot. This shipment was the result of a little more than a month's actual operation of the new concentrating plant. This started on January 9, and on account of various difficulties, such as the failure of a ball-mill, which had to be replaced, a short lack of water for a few days, and some changes in the treatment method, such as the abandonment of jigging, lost considerable time. The low-grade dump which had been accumulated from hand sorting of high-grade ore, has nearly

all been put through the concentrator, and the plant will in the future be operated largely on ore blocked out in the mine.

A feature of the fourth annual auto-show at the Deadwood auditorium is the mineral exhibit. This includes all classes and character of Black Hills ores and mineral products, well arranged. Not the least interesting feature is the exhibit of Kirk G. Phillips estate, dealers in assay and mill supplies. At this booth, in charge of W. L. Faust, demonstrations are made of his quick method for determining tungsten, published on the Concentrates' page of this issue.

TUCSON, ARIZONA

TUNGSTEN DEPOSITS IN PIMA COUNTY, PRODUCTION, TESTING.

Tungsten ore has been developed over an area four miles long by more than a mile wide in the Arivaca district of Pima county. The veins, of which there are three principal ones, and many subsidiary stringers, strike east and west, and are continuous throughout the length of the tungsten-bearing area, finally disappearing beneath the alluvial on the west and continuing east into a gold-bearing area. The principal veins have been prospected by trenches and shafts, at varying intervals, for a distance of three miles, showing a high proportion of good shoots. Development at present is confined principally to those largest and richest shoots, of which there are five.

These vary in width from 2 to 8 ft., and from 50 to 100 ft. in length. To the greatest depth attained, 150 ft., they retain their width, and are continuous.

The National Tungsten Co. of Tucson owns practically the entire area, and has made regular shipments of from 10 to 15 tons of concentrate for the past 8 months from its Las Guijas mine, managed by Arthur L. Kelley. The mines are as yet only mere prospects, and the mill is still in the experimental stage. The product has maintained a \$10,000 monthly payroll, besides furnishing supplies and equipment necessary for operation. The geological features are much the same as those of other districts containing tungsten, namely, the country rock is a coarse-grained biotite-granite, with its accompanying fine-grained acid rock, with some diorite dikes, which are intimately associated with the veins and vary from a few inches to 10 ft. in width. North and east of the granite area is andesite breccia and limestone, in contact; south and west lies a desert of 20 miles to the Baboquivari range, also granite.

The tungstates of commercial importance are those of iron and manganese, in the minerals wolframite and hübnerite. Some stoltzite is present, but only discernible at times as a gray thread-like streak on the concentrating tables. Pyrite and chalcopyrite are at times more or less troublesome, and silver, up to 50 oz. per ton has been found in specimens, these being as high as \$5 per ton in gold. But the precious metals have not been found in commercial quantities. Some ferberite has been brought in for sale by Mexicans, showing that there are deposits of this mineral within a reasonable distance.

Chemical analyses of the ores for their tungstic-acid content are satisfactorily made at the plant by the method given in J. Ohly's 'Analysis, Detection, and Commercial Value of the Rare Metals,' as follows:

Quantitative determination. Reduce the ore to a very fine powder, weigh off one gram and digest for 12 hours (cover night) at a gentle heat with a mixture of four parts hydrochloric and one part nitric acid, till yellow pulverulent tungstic acid remains. Evaporate to dryness on water-bath, and take up with water acidulated with hydrochloric acid. Filter and wash the residue, consisting, besides the yellow trioxide, of silica and sometimes small quantities of niobic acid, with alcohol, and treat the mixture on the filter with ammonia. Place the filtrate in a large weighed porcelain crucible, evaporate to dryness on the water-bath, and heat the residue of ammonium tungstate to decomposition. Weigh the crucible with the remaining trioxide and calculate the percentage.

THE MINING SUMMARY

The news of the week as told by our special correspondents and compiled from the local press.

ALASKA

FAIRBANKS

The 10-stamp mill at the mouth of the Chena river is to crush tungsten ore from Johnson and Ewers' mine on Gilmore creek.—Considerable tungsten occurs in the Ott Mining Co.'s property on Fairbanks creek. When the ore is low in gold, it is high in tungsten, and vice-versa.

JUNEAU

February returns of the mines on Douglas island are as follows:

| | Mexican | Treadwell | United |
|-----------------------|----------|-----------|----------|
| Ore crushed, tons | 17,535 | 68,796 | 43,939 |
| Gold yield | \$22,118 | \$107,557 | \$84,116 |
| Average per ton | \$1.26 | \$1.56 | \$1.91 |
| Operating expenses | \$25,193 | \$100,830 | \$72,307 |
| Construction expenses | 10,542 | 8,256 | 14,680 |
| Loss | 13,838 | 2,605 | 3,702 |

VALDEZ

The Granite Gold Mining Co., which owns and operates properties near Valdez, will commence dividend payments in April, when 2c. per share, or \$8600, will be disbursed, according to official announcement. The capital is 500,000 shares at

long, opened in the property, and recent reports state that the lower adit has been extended to cut the vein at 800 ft. vertical depth, materially increasing the ore reserves. The mill now is treating 60 to 70 tons daily, and about 50 men are employed. B. F. Millard, Valdez, is president, treasurer and general manager of the company; W. R. Millard, also of Valdez, is first vice-president and superintendent; O. S. Larson, Seattle, is second vice-president; and J. W. Gilson is secretary.

ARIZONA

GILÁ COUNTY

(Special Correspondence.)—The American Smelting & Refining Co. intends spending \$160,000 in improvements to its smelter here. At present the company is building a sampling-mill with a capacity of 75 tons per hour, to cost \$40,000, as well as an ore-bin, capable of holding 7000 tons. Both are near the present plant, and are to be finished by July. Further improvements to the plant covering the remainder of the appropriation will be made in the near future.

Hayden, April 1.

At the Inspiration mill work is under way on the tailing-dam. The site has a capacity for many years' work.

During 1915 the Arizona Commercial Mining Co. produced 44,353 tons of ore, yielding 3,592,274 lb. copper, 16,512 oz. silver, and 283 oz. gold. The revenue was \$439,412, and profit \$211,775, of which \$31,293 was written-off for depreciation. Including the previous balance the surplus is \$473,715. A power-plant costing \$75,000 is to be erected. Development on No. 14 level is excellent.

MOHAVE COUNTY

(Special Correspondence.)—The following news of the Cerbat, Stockton Hill, and Todd Basin districts in the Wallapai district, from 12 to 15 miles north of Kingman, should be of interest:

The Charcoal Canyon Mines Co. has purchased the Marion group and the Ryan zinc group of claims from the Ryan Cattle Co., and will commence development in the near future. Shafts will be sunk at three places. High-grade zinc has been found in the shaft, and indications on the surface point to large bodies at depth.

The St. Louis mine has been taken over by R. C. Billings and associates. Driving an adit on the vein is in progress, and ore is being sacked for shipment, the value is mostly in lead and silver.

The Champion mine is making shipments of lead and zinc ore, extracted by lessees.

The Arizona Butte Co., on Stockton hill, is placing an order for mining and milling machinery. It has an immense amount of milling zinc and lead ore blocked out in the mine.

The Middle Golconda in Todd basin has cut high-grade ore in a cross-cut adit. The vein is said to be over 50 ft. wide, with the hanging wall not yet in sight.

The Golconda Consolidated Mines is working its mill on ore which is said to be in keeping up to the average of the mine, \$10 to \$14. Mr. Miller of the California Corporation Commission recently examined the properties of this company, and was favorably impressed.

Kingman, March 19.

Since August 1915 nearly 200 companies have been organized

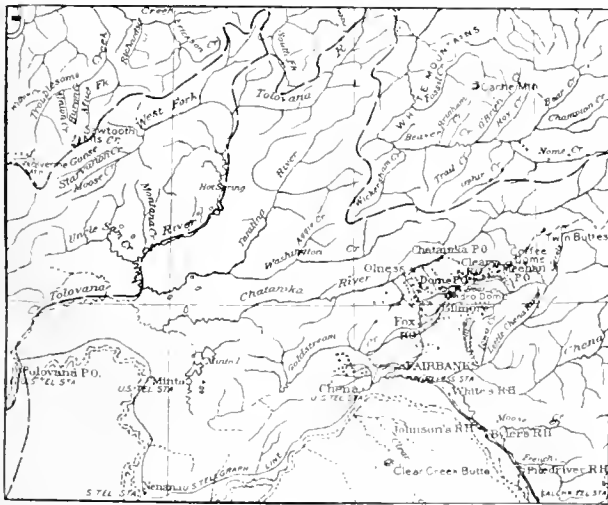

GOLD-BEARING CREEKS IN THE FAIRBANKS DISTRICT, ALASKA.

\$1 each, of which 304,000 shares are issued. The company's holdings comprise three 20-acre claims, covering the vein for 3000 ft. Equipment consists of a 180-hp. oil-burning engine and a 150-hp. electric generator, together with switch-boards, water and oil pumps, and fuel-storage tanks. The generating-station is connected with the power-plant at the mill by a 4800-ft. transmission-line, providing current for a 100-hp. motor, which operates the compressor and auxiliary machinery. The concentrator includes a 10-stamp Hendy mill and a 7-ft. Lane mill, both motor driven; two crushers and one set of rolls, etc. A 4000-ft. corduroy road connects the mine and mill with the wharf at Hobo bay, and the camp is provided with buildings to comfortably house and care for 60 men. The company also owns a 60-hp. gasoline-launch and an 80-ton barge. There are four levels, from 300 to 500 ft.

to be made on the Ontario district. About 100 companies are fully equipped to operate in the state where they are receiving machinery, the remainder either have their machinery ordered or will have their orders at an early date.

A large hoist is being installed at the United Western. It will handle rock and the water encountered at 500 ft. The south-west cross cut at this depth is in 28 1/2 ft., and in the last 20 ft. years 10 to 24 in. wide, worth \$5 to \$16 per ton were cut. A 100-ton hoist, 50-hp. Fairbanks Morse oil engine, drill, Ingersoll compressor, drill sharpener, etc., has been purchased for the Otman United.

The Big Jim company has sold 200,000 shares at \$1.75 each. The buyers' names are not yet known.

ARKANSAS

MARION COUNTY

The new 25-ton per 10-hour shift mill at the Bear Hill mine is in operation. It is modern in every respect. Ore is extracted at a depth of 90 to 150 feet.

A market for 20% calamine ore has been opened at Yellville by W. J. Fene.

CALIFORNIA

HUMBOLDT COUNTY

It is reported that there is a revival in black-sand treatment for platinum along the beaches north of Eureka, and up in Oregon.

MARIPOSA COUNTY

(Special Correspondence.)—The Early mine, near Jersey, is a property with a good past gold production, is being re-opened by Mrs. N. C. McIntyre. An old drift has been re-opened, a shaft sunk 100 ft. below it, and development started both ways from the shaft's bottom. A fair width of good grade ore is being driven on. Litigation is hindering work at this promising prospect.

North-west of Mariposa is the Colorado mine, which is being developed slowly but thoroughly. The vein is yielding up to \$9 per ton in the 10-stamp mill.

Basevada, March 27.

NEVADA COUNTY

The Golden Center company is interested in a 60 days' option on the Alden ranch in the Grass Valley district. This property has yielded a great deal of rich ore.

SACRAMENTO COUNTY

No. 7 ore grade of the Natona company sank on April 1.

SAN BERNARDINO COUNTY

There is increased interest in the new Goldstone district, according to news from Barstow.

The new interstate bridge across the Colorado river below Needles was formally opened for traffic last week. It is on the line of the old Trail's national highway.

SHASTA COUNTY

According to M. E. Dittmar, manager of the Green Horn mine near Tower House, shipments this season to Kennett should yield up to 10% copper per month.

TRINITY COUNTY

In the annual report of the Crown Reserve Mining Co. of Cobalt, Ontario, the following remarks are made by the general manager, Samuel W. Cohen:

"An exploration and examination campaign was vigorously prosecuted, and, as a result, one property located in Trinity county, California, was taken under lease by the Globe Consolidated Lease Incorporated Co., in which we own the control. This property consists roughly of 2500 acres of mining lands, together with water-power, timber, and other rights necessary for mining. The property is fully equipped with a modern cyanide-mill, saw-mill, machine-shop, power-house, etc.,

and everything necessary for the complete operation of a mine of about 150 tons per day. The property has produced about \$600,000 of ore of an average value of \$10. Inasmuch as the property is a going concern, and there is a 1500-ft. ore-shoot with an average width of 6 ft. and value of about \$9. from above which all the gold has been produced and below which practically no development has been done, there is every reason to expect a favorable future for the property, which was acquired on advantageous terms."

Four hundred tons of material is to be hauled by A. G. Frost from Redding to Junction City for the Valdor Dredging Co., which is to erect a dredge on the Trinity river, four miles from Junction.

COLORADO

CLEAR CREEK COUNTY

(Special Correspondence.)—The Climax mine on Columbia mountain has a promising development, an 8-in. vein having been cut, assaying 110 oz. silver and 0.6 oz. gold per ton. The ore was found 1500 ft. from the portal of the adit. J. N. Calder of Lawson is manager.—The Sunshine vein on Albro mountain, owned by C. W. Larchen, has just been intersected by the adit, showing 10-in. of yellow copper ore. It is valued at \$30 per ton in gold and silver.—Construction on the new mill to treat the ores of the Silver King mine at Dumont, will be started early in April. Hendrie & Bolthoff of Denver are owners.—The Skidoo mine, up north Spring gulch, is receiving attention by Chapman & Co. and shipments will commence as soon as the road leading from the property can be repaired.—W. A. Gilman, manager of the New Era mine at Froeland, states that shipments of smelting ore will be made at the rate of 100 tons a month. The ore averages \$100 per ton in gold, silver, and lead.—The Engineers' Leasing Co., operating on the Gunnell mine through the Argo adit, is maintaining a heavy output of mill ore, the product being consigned to the Argo mill.—Work will shortly be resumed on the Lincoln company's holdings, situated on Lincoln mountain. The various levels are to be thrown open to lessees.—The Jackson 50-ton concentrating plant has been overhauled, and is treating ore from the Edgar mine.

Idaho Springs, March 28.

TULLER COUNTY (CRIPPLE CREEK)

The March output was \$1,227,810 from 86,672 tons of ore.

During 1915 the Doctor-Jack Pot Mining Co.'s properties, mostly leased, produced ore worth \$277,433, making \$3,810,000 to date. On January 1 there was \$114,742 cash on hand.

Tungsten ore has been found at the old property of the Wolframite Gold Mining Co., several miles south of Cripple Creek, along the Florence & Cripple Creek line. The owners, F. Hackney and C. B. McHenry, shipped 300 lb. of 23% ore.

IDAHO

IDAHO COUNTY

New York and Philadelphia capital is becoming largely interested in gold properties in central Idaho, both placer and quartz, and extensive operations are planned for the coming season, according to J. M. Hinton, a pioneer mining man of the Newsome-Ten-Mile district of this county. Mr. Hinton states that there is promise of greater activity in the Clearwater basin, as soon as weather conditions permit, than ever before, and he predicts that the season's output will be approximately \$1,000,000 net. In the Newsome region there are several properties that have been practically idle for some months which are being re-opened, while those that have been operated at reduced capacity are being extensively developed with a view to increasing the output. The old Harmon and Morrow mine, the discovery of which created so much excitement several years ago, is being worked steadily, and new development is revealing ore-bodies that were not suspected to exist. The value is increasing with depth, and the shoots are becoming more extensive. The owners are glad that the

interests that had it under bond soon after it was discovered allowed the option to lapse. Smith brothers, operating the New York and Georgia claims with 15 men, recently opened a new 8-ft. vein in the lower adit that yields \$15 per ton on plates. It is 80 ft. to the next upper level, and exploration has proved that the intervening ground is in the stopping area. They have shipped 700 tons in the last few weeks that returned \$12,000, and there are 500 tons on the dump that assay about \$10 per ton, which will be treated as soon as a concentrator, recently ordered, is installed. On the Wonder group, in which eastern men are interested, a raise is being put up on ore from the 400-ft. level, and the value is uniform throughout. Conditions in the entire district never were more promising, and the belief is general that the Northern Pacific railway soon will extend its line from Stites, the present terminal.

At the Una mine, Ora Grande, the main adit is in 900 ft., and nearly under the vertical shaft, which is in a wide vein of \$7 ore.

SHOSHONE COUNTY (COEUR D'ALENE)

The Bunker Hill & Sullivan company is producing 40,000 tons of ore per month, yielding 3300 tons of lead in concentrate, and employing 800 men in all departments. There are 500 ft. of cross-cuts and drifts on the level 1000 ft. below the Kellogg tunnel. These workings are at a vertical depth below the original outcrop of 2300 ft. and, following the dip of the vein, at an inclined depth of 3500 ft. The geological conditions on this level are normal, and give no indication of any change from the conditions that have prevailed throughout the entire depth of the mine. There is no perceptible variation in either the grade or character of the ore and no apparent change in the size of the orebodies, according to Stanly A. Easton, the general manager. The company also manages the Caledonia, Ontario, and Sierra Nevada. The Ontario produces 1000 tons of concentrate per month, and employs 150 men.

The new smelter for the Bunker Hill will be at Kellogg. Its daily capacity is to be 900 tons of ore and concentrate. Grading will be commenced in a few days, and construction will employ 500 men. It will be complete early in 1917. Some of the structural material has already been delivered, while contracts have been let for the remainder.

The Alice mine, adjoining the Morning at Mullan, has been re-opened under lease by Granville A. Collins and others of Seattle. The mine is well opened and equipped to supply the 150-ton mill with lead-silver ore.

According to Chester T. Kennan of Colorado, the Murray district tungsten deposits are very promising, and will possibly rival those of Colorado and California.

Interest in the Pine Creek district continues to grow. Wallace men have taken preliminary steps for the construction of a railway from the Oregon-Washington Railroad & Navigation line at the mouth of the creek to the Constitution mine, 10 miles, and a branch up the west fork about 3 miles to tap a timber and mining area. W. H. Herrick is the leading spirit. Capital has been secured. The survey, in charge of F. Merriam, of Wallace, is half complete. Construction will commence at an early date.—The Hilarity zinc-lead mine is to be re-opened by J. M. Porter and others.—According to Judge George Turner and others of Spokane, who control the Constitution mine, an electrolytic plant of 100-ton daily capacity, to cost \$425,000, may be erected at Spokane in the future. The ore averages 30% zinc, besides some lead and silver.—Aside from the Douglas mine, which is operated by the Anaconda company, the best known working properties on Pine creek are the Highland-Surprise, Constitution, Nabob, Sidney, Amy-Matchless, and Little Pittsburg. All are reached by a wagon-road from Pine Creek siding, on the O. W. R. & N. line between Kingston and Kellogg. There are also valuable antimony mines in the district, including the Coeur d'Alene Antimony Co. The prevailing formation along Pine creek is the Pritchard series of slates, which until quite recently was

regarded as unfavorable to the formation of bodies of commercial ore.

On May 1 the Tamarack & Custer Consolidated Mining Co.

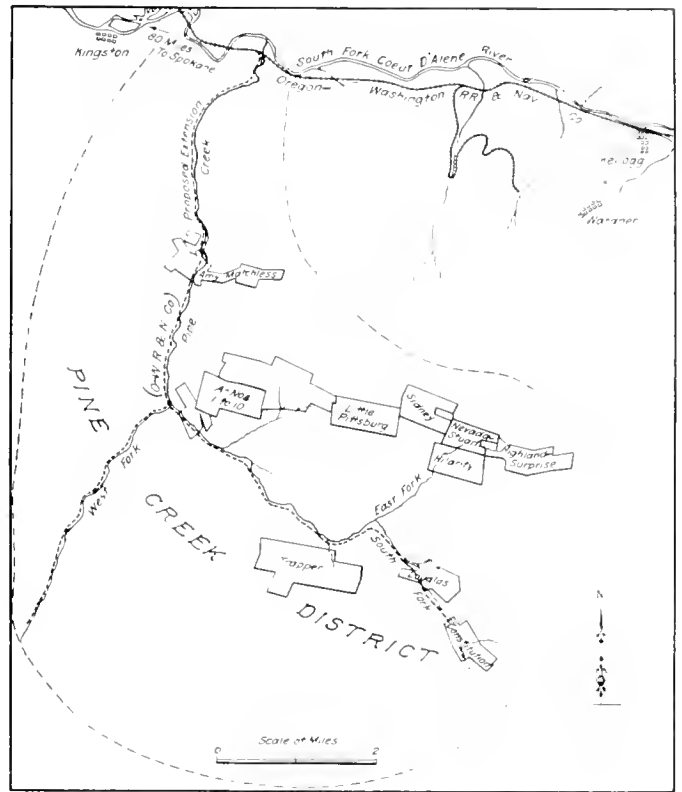

MAP OF PINE CREEK DISTRICT, COEUR D'ALENE, SHOWING ITS RELATION TO WARDNER AND KELLOGG, THE LATTER WHERE THE NEW SMELTER OF THE BUNKER HILL & SULLIVAN IS BEING ERECTED.

will pay its initial dividend of 2c. per share, equal to \$35,530. A 600-ton mill, to cost \$150,000, is being planned.

MISSOURI

JASPER COUNTY

The ore market at Joplin last week was practically unchanged. The output of the region was 6518 tons blende, 459 tons calamine, and 1148 tons lead, averaging \$97, \$70, and \$98 per ton, respectively. The total value was \$792,307, and for 12 weeks \$9,588,443.

Two men were killed and two injured in the Consumer mine at Joplin, when a slab of rock 50 ft. long, 30 ft. wide, and 2 ft. thick fell from the roof. Forty other men had a narrow escape.

MONTANA

CASCADE COUNTY

Many old mines in the Neihart district of northern Montana are being re-opened. A large amount of silver ore has been extracted in the past. The Big Seven and Ripple were always worked to some extent, and produce silver-gold-lead-zinc ore. Cost of transport is high. A mill is to be erected at the Ripple to treat mine and dump ore of good value. Last September the Anaconda company leased the Queen of the Hills and Galt mines.

Work at the Great Falls zinc plant is progressing favorably. The Clifton-Applegate Co., contractors, have excavated 100,000 cu. yd. of earth in preparing the site, and the foundations of the various divisions are in the following condition at the time of writing, according to *The Anode* for March:

Roasters—concrete is being poured and the foundations will

be complete in a few days. Electrolytic forms are practically completed. Lead casting forms are practically completed, and the leaching and power plant forms are being placed in position. As necessary adjuncts to the work there have been installed ten or eleven buildings as follows: office, shops, boiler house, locomotive round house, while a warehouse is now being built. Construction tracks, piping, etc., have been placed as the work demands, these being extended and changed from time to time.

LEWIS AND CLARK COUNTY

The manager of the East Helena smelter of the A. S. & R. Co., Frank M. Smith, states that low grade lead ores are now in demand.

SILVERBOW COUNTY

With the moderation of the extreme cold weather February saw considerable progress made in construction work in all departments at the Anaconda company's Washoe works. The reconstruction of the concentrator has been completed, and the remodeled portions are now in commission. The oil flotation department is in full operation. No. 2 roaster is practically complete, and one-third of the furnaces are in service. The large reverberatory furnace, which has been under construction at the converter plant for the purpose of retreating converter slag, is also complete and in service. The construction of the last two of the Great Falls type of converter is now well under way. The addition to the zinc plant is also nearing completion and will probably be in operation during the present month. At the present time all indications point to an early completion of all construction work begun during the past year, and the output of the smelter will doubtless be greatly increased in the near future.

A few deep holes drilled in the west side of the Bullwhacker open-cut, which was crumbling away, when blasted brought down 5000 tons of 4% copper ore last week. A body of 2 to 8% ore was also exposed. Considerable underground development is under way. Monthly shipments are 2000 tons to Tacoma. Some ore will go to Garfield, Utah.

The Butte & Great Falls company is to construct an aerial tram from the mine to the Great Northern railway, over two miles.

NEVADA

HUMBOLDT COUNTY

A rush seen in Rye patch gold district last week, on the strength of rich ore being found, according to news from Lovelock.

Five feet of \$80 ore has been opened in a winze below the 300 ft. level of the Crown Point at Rochester.—The Rochester Mines now produced \$38,800 in the past four weeks.—Promising developments are reported from the Packard Extension.

Stopes of 1500 ft. in the Seven Troughs Coalition are yielding \$200 to \$700 ore.

NYE COUNTY

Production of Tintic last week was \$580 tons valued at \$17,700. The Tintic company shipped bullion worth \$57,600. The Murray vein at 1540 ft. in the Extension is 27 ft. wide. The West-Tonopah property is now controlled by Eastern Consolidated with G. Kirchen of the Extension as general manager. The mine, opened to 850 ft., has been closed since 1907. This closure is of importance to the district.

NEW MEXICO

GRANT COUNTY

Two 500-hp units of the Burro Mountain Copper Co.'s mill at Tyrone are nearing completion, and should be working early in May. All machinery is motor-driven, direct-connected. All launders and pipes are below the floors. A 300-ton storage-bin supplies a No. 1 Symons crusher, which reduces the ore to 3-in. size. A 48-in. sorting-belt feeds three 48-in. Symons

disc crushers, which make a 1/2-in. product. Allis-Chalmers rolls reduce this to 5 millimetres (1/4 in.). From Cole shaking screens the over-size returns to the rolls. The fine ore is delivered to a 1000-ton bin. Feeders, belt conveyors, weighing machine, and a roughing distributor take the ore to six Hutchart tables. Concentrate passes to vnts. Tailing is reduced in Marathon mills. Following are four thickeners and classifiers, hydraulic deslimers, and sand tables. Slime goes to Rock flotation machines, the tailing from which passes over Senn pan-motion tables. The recovery will be over 80%, 60% being saved on the Hutchart tables. August Sandberg designed the mill assisted by C. E. Rork.

SOCORRO COUNTY

Higher prices for silver have added activity to the Mogollon district. The Alberta mine and Deadwood mill have resumed. The new road from Magdalena, N. Mex., will be finished in a few months. Preliminaries are complete for the highway from Greenlee county, Arizona, into the Mogollons.

OKLAHOMA

OTTAWA COUNTY

It is estimated that the Commerce district will produce \$5,000,000 of zinc and lead ores in 1916 (\$1,000,000 being reported to the end of March), against \$2,500,000 in 1915, \$1,700,000 in 1914, \$1,200,000 in 1913, and \$628,000 in 1912.

The new and fourth mill of the Picher Lead Co. will treat 140 tons per 24 hours. Construction is to start soon.

OREGON

JOSEPHINE COUNTY

A large deposit of iron, with indications of manganese, has been located by W. B. Sherman and others of Grants Pass, about 8 miles from the California & Oregon Coast railway, being constructed from that town to Crescent in California.

UTAH

BEAVER COUNTY

On February 29 the Horn Silver Mining Co., in the San Francisco district, resumed dividends. The money for this was from the Caldo company, which bought the tailing dump for \$150,000, of which \$25,000 was cash. The material is being treated by flotation. During 1915 development covered 1313 ft. Lead-silver, zinc, zinc-lead, and copper ores, and old slag shipped totaled 30,057 tons, yielding \$165,889. The operating profit was \$18,312. The surplus is \$100,449.

JUAB COUNTY

At a depth of 1700 ft. in the Iron Blossom a drift will be driven 2000 ft. to connect the south or No. 1 workings with the new copper orebody in the north, 600 or 700 ft. lower than the present stopes.

The Dragon Con. is sending 80 tons of low-grade ore to the Tintic Milling Co. Some good copper-gold-silver ore is shipped. High value in gold is lately reported from the north end.

Work is being resumed at the East Tintic, North Tintic, and Zuma mines.

SALT LAKE COUNTY

To haul ore from the Alta Tunnel, Cardiff, and Maxfield mines in the Big Cottonwood district to the Murray smelter the Alta Tunnel & Transportation Co. is to use caterpillar-tractors, according to the manager, Fred V. Bodfish.

When the snow has cleared away the Wasatch company at Alta will commence its 4000-ft. drainage and transport adit. This will cost \$60,000. The company has just marketed another car of ore that averaged 69.60 oz. silver, 10% lead, 10% copper, and 14.70% zinc, with net value of \$82.60 per ton.

SUMMIT COUNTY

The Big Four concentrating plant at Atkinson's is to be enlarged to 750 tons per day.

WISCONSIN**LAFAYETTE COUNTY**

The Benton district is shipping 50 cars zinc ore per week, and is booming. There are not enough buildings to house everybody. New producers with new plants are the Hird, Treganza, and Longhenry. Meetings have been held quietly at many points between mine operators, ore-separating companies, and agents representing a large smelting concern, for the purpose of pooling issues and building an independent zinc smelter at or near the site of the National Separating Co. at Cuba. A scarcity of drill-rigs is seen everywhere in the field. Mill-wrights are engaged on work planned a year ahead. Four miles of rock and tailing roads have been laid to connect all outlying producers with track which was finished on March 15. The Wisconsin Zinc Co. unloaded 30 cars of cypress lumber at this station during the month to be used in the early construction of two new power and milling plants, and one power plant to supply current for the company's mines and mills in this part of the field. Oil engines have been introduced by the Frontier Mining Co. for underground work. The elaborate drilling program that has been at maximum pitch for a month is daily finding rich zinc ore in virgin soil. Not a foot of land is available for leasing purposes in the two townships Benton and New Diggings, which have large bodies of ore underlying the entire districts so named. The Wisconsin Zinc Co. and Vinegar Hill company both employ 650 men, and there are 10 other companies in the district with 50 to 75 men each.

The New Diggings district, practically at a standstill at the beginning of 1915, is now the home of 1000 miners. Drills going everywhere have been rewarded with rich strikes.

CANADA**BRITISH COLUMBIA**

During the current month the Britannia Mining & Smelting Co. on Howe sound will be treating 3000 tons of 3% copper ore daily. The plant is to be increased to 8000 tons capacity.

The Hudson Bay Zinc Co. is being incorporated at Spokane to operate mines near Salmo. The price of the property is \$100,000, payments to be made from ore extracted. Lessees have shipped 150 carloads of 27 to 35% ore, and are now sending 50 tons daily. A 5000-ft. aerial tram is to be erected.

MEXICO**SONORA**

If La Colorado Mining Co. does not resume operations at its mine 37 miles from Hermosillo P. E. Calles, governor of Sonora, will do so for them. The property is in no danger, nor would the employees be, who want work. The property will not be confiscated, but will be administered by the State, profits going to the company.

In the Department of Metallurgical Research of the State School of Mines, University of Utah, there have been established five research fellowships in metallurgy, each having an annual value of \$720. These fellowships are open to college graduates who have had a good training in chemistry and metallurgy, and applications for them will be received up to May 15, 1916.

Those now holding fellowships for the fiscal year 1915-1916, and the fields in which they are working, are: Glenn A. Allen, flotation processes; Richard W. Johnson, hydrometallurgy of zinc; Harper C. Neeld, hydrometallurgy of zinc; Clarence E. Sims, electrolytic processes; M. J. Udy, hydrometallurgy of lead; Harry J. Morgan, cyanidation; and George F. Stoff, losses in milling processes.

By an agreement with the U. S. Bureau of Mines, the work of the metallurgical research department is under the direction of metallurgists of the Bureau, assigned to duty at the University and Salt Lake City.

PERSONAL

W. C. WYNKOOP is at Pike, Sierra county, California.

COREY C. BRAYTON has returned from Salt Lake City.

BEN. S. REVETT has returned to San Francisco from New York.

HEATH STEELE has taken an office at 60 Broadway, New York.

SCOTT TURNER sails from New York for Lima, Peru, on April 8.

W. W. BREEN of Sonora, California, was in San Francisco last week.

JOHN ALLINGHAM, of Oakland, is at Virginia City for Charles Butters & Company.

FREDERICK E. BURBIDGE, of Spokane, has been made general manager for the Federal Mining & Smelting Co. in Idaho.

CHARLES O'CONNELL, manager for the Tough-Oakes gold mine, is returning to Kirkland Lake, Ontario, after a holiday in California.

A. W. STICKNEY, consulting geologist for the Kyshtim Corporation, Russia, is in New York. He will visit Boston and then sail for Russia.

ELTON W. WALKER has returned from Boston to Houghton, and has been made general manager of the Adventure mine, which will be re-opened shortly.

ICHIRO KAMIMURA and HARUYOSHI TOMITA, engineers to the Osaruzawa mine of the Mitsubishi Company, in Japan, are making a journey of observation to our western mines and smelters.

W. A. WASLEY is now mill superintendent for the Lucky Tiger Mining Co. and W. H. FOESTER is cyanide superintendent. W. R. MAYCUMBER, former mill superintendent, has accepted a position with the Chile Copper Company.

H. STONE, of the Murex Co., Ltd., has closed his laboratory in San Francisco and has moved it to Darwin, Inyo county, California, where a mill is being erected to treat lead carbonate. For the next few months tests are to be made at this plant.

Schools and Societies

MACKAY SCHOOL OF MINES, Reno, students are visiting Rochester, Tonopah, and Goldfield in Nevada, and Grass Valley, California.

The UNIVERSITY OF CALIFORNIA summer session begins on June 26 and closes on August 5. No formal examinations are required for entrance; admission is granted to all persons of sufficient maturity and intelligence to profit by the exercises of the session. The tuition is \$15, regardless of the number of courses taken, the usual ones being offered.

The Southern California section of the A. I. M. E. met at Los Angeles on April 4. A feature of the meeting was the reading of a group of valuable papers on 'Mining Conditions in South America.' The leading paper dealt with the structural features and mineral districts of the continent, by Bailey Willis, professor of geology at Stanford University.

The AMERICAN ASSOCIATION OF ENGINEERS announces that it has signed a five-year lease for suite 601-604 at 29 south LaSalle St., Chicago, Illinois. This is the second time in 9 months that the new society has been compelled to enlarge its quarters. It has now a membership of 500, sixty-five per cent of which is in and near Chicago, and the remainder is scattered throughout the United States, Canada, England, Philippine Islands, and even in South America.

THE METAL MARKET

METAL PRICES

San Francisco, April 7

| | |
|--|-------|
| Antimony, cents per pound | 44 |
| Platinum, soft metal, per ounce | \$88 |
| Platinum, hard metal, 90% iridium, per ounce | \$42 |
| Quicksilver, per flask of 75 lb. | \$200 |
| Spelter, cents per pound | 22 |
| Tin, cents per pound | 16 |
| Zinc-dust, cents per pound | 30 |

ORE PRICES

San Francisco, April 7

| | |
|--|-------------|
| Antimony, 50% product, per unit, of 10, or 20 lb. | \$2.25 |
| Chalcopyrite, hard, over 60% Cu, California, per ton | 12.00 |
| Magnesite, crude, per ton, 60% CaO | 8.00 |
| Magnesite, plastic, no iron and lime, calcined, ton | 25.00-30.00 |
| Magnesite, refractory, 11% iron, dead-burned, ton | 35.00 |
| Manganese, 50% metal, 8% silica, per ton | 12.00 |
| Tungsten, 60% Mo, per unit of 20 lb. | 70.00-80.00 |

Tungsten prices of Boulder, Colorado, remain around \$95 per unit, \$115 per unit in New York, and a drop to \$75 is predicted by some reported with the market.

New York, March 29

Large sized quantities of antimony ore have been purchased at around \$2.50 per unit for forward shipment. The demand continues.

Up to \$78 per unit has been paid for forward shipments of tungsten. Forward price delivery \$99 is said to have been given.

Price 70 to 80% percent is quoted for manganese. The U. S. Manganese Corporation will soon produce ore from its mine at Elkton, Virginia. The Crimora Manganese Corporation will have a new plant completed at its manganese mine at Crimora, Virginia, in April. Both concerns have plenty of ore.

EASTERN METAL MARKET

(By wire from New York.)

April 4. Copper is firm, with futures active; lead is quiet but firm; near futures in spelter are active.

SILVER

Below are given the average New York quotations, in cents per ounce, of fine silver.

| Date | Average week ending |
|---------|---------------------|
| Feb. 29 | 56.88 |
| Mar. 1 | 56.75 |
| Mar. 8 | 56.75 |
| Mar. 14 | 56.88 |
| Mar. 21 | 56.75 |
| Mar. 28 | 56.94 |
| Apr. 4 | 56.94 |

| 1914 | 1915 | 1914 | 1915 |
|------------|-------|-------|-------|
| Jan. 27.78 | 48.85 | 56.76 | 47.52 |
| Feb. 17.75 | 48.45 | 56.74 | 47.11 |
| Mar. 7.88 | 48.41 | 56.75 | 48.77 |
| Apr. 28.52 | 49.25 | 56.75 | 49.49 |
| May 28.21 | 49.85 | 56.75 | 51.88 |
| June 28.47 | 49.07 | 56.75 | 55.34 |

A steady demand for silver continues in the silver market. Requirements are heavy in England, Europe, and India.

On March 28 the U. S. Mint took \$52,000 (875,000 oz.) of silver bullion from the Government of Allied troops, especially from the Philippines, to meet demand for small coins (silver), and to satisfy the demand for quantities from one country to another.

COPPER

Prices of electrolytic in New York, in cents per pound.

| Date | Average week ending |
|---------|---------------------|
| Feb. 29 | 27.25 |
| Mar. 1 | 27.12 |
| Mar. 8 | 26.62 |
| Mar. 14 | 26.50 |
| Mar. 21 | 26.48 |
| Mar. 28 | 26.79 |
| Apr. 4 | 26.87 |

| 1914 | 1915 | 1914 | 1915 |
|------------|-------|-------|-------|
| Jan. 14.21 | 20.69 | 24.29 | 19.69 |
| Feb. 14.46 | 21.78 | 26.62 | 17.27 |
| Mar. 14.11 | 21.87 | 26.62 | 17.59 |
| Apr. 14.19 | 26.64 | 26.62 | 17.59 |
| May 13.97 | 19.71 | 26.62 | 18.88 |
| June 13.69 | 19.75 | 26.62 | 20.67 |

February returns are as follows: China, 1,617,329; Grandby, 699,265; Inspiration, 9,300,000; Nevada Consolidated, 8,411,417; Kay, 5,767,987; and Utah Copper, 11,819,972 pounds.

Miami has declared a dividend of \$1.50 per share.

Kennecott paid \$1 per share on March 31, or \$2,500,000.

LEAD

Lead is quoted in cents per pound, New York delivery.

| Date | Average week ending |
|---------|---------------------|
| Feb. 29 | 6.30 |
| Mar. 1 | 6.30 |
| Mar. 8 | 6.60 |
| Mar. 14 | 6.82 |
| Mar. 21 | 7.42 |
| Mar. 28 | 7.96 |
| Apr. 4 | 7.91 |

| 1914 | 1915 | 1916 | 1914 | 1915 | 1916 |
|-----------|------|-------|------------|------|-------|
| Jan. 4.11 | 3.73 | 5.95 | July 3.80 | 5.59 | |
| Feb. 4.02 | 3.83 | 6.23 | Aug. 3.86 | 4.67 | |
| Mar. 3.91 | 4.04 | 7.26 | Sept. 3.82 | 4.62 | |
| Apr. 3.86 | 4.21 | | Oct. 3.60 | 4.62 | |
| May 3.90 | 4.24 | | Nov. 3.68 | 5.15 | |
| June 3.90 | 5.75 | | Dec. 3.80 | 5.31 | |

Lead ore at Joplin, 80% metal, is \$100 per ton.

On April 4 the Bunker Hill & Sullivan company pays two dividends of \$81,750 each. The total to date is \$17,263,500.

QUICKSILVER

The primary market for quicksilver is San Francisco, California being the largest producer. The price is fixed in the open market, according to quantity. Prices, in dollars per flask of 75 pounds:

| Date | Week ending |
|---------|-------------|
| Feb. 29 | 210 |
| Mar. 1 | 200 |
| Mar. 14 | 200 |

| 1914 | 1915 | 1916 | 1914 | 1915 | 1916 |
|------------|-------|--------|-------------|--------|-------|
| Jan. 39.25 | 51.90 | 222.00 | July 37.50 | 95.00 | |
| Feb. 39.00 | 60.00 | 295.00 | Aug. 30.00 | 33.75 | |
| Mar. 39.00 | 78.00 | 219.00 | Sept. 36.25 | 91.00 | |
| Apr. 38.90 | 77.50 | | Oct. 33.00 | 92.90 | |
| May 39.00 | 75.00 | | Nov. 35.00 | 101.50 | |
| June 38.60 | 90.00 | | Dec. 33.10 | 123.00 | |

New York reports light demand. One firm offers \$150, others hold at \$230, and say that England will not lift the embargo on exports. Opinion differs as to the condition of stocks. Recent imports have gone direct to munition makers.

ZINC

Zinc is quoted as spelter, standard Western brands, New York delivery, in cents per pound.

| Date | Average week ending |
|---------|---------------------|
| Feb. 29 | 21.35 |
| Mar. 1 | 20.71 |
| Mar. 8 | 19.92 |
| Mar. 14 | 18.17 |
| Mar. 21 | 17.83 |
| Mar. 28 | 17.79 |
| Apr. 4 | 17.75 |

| 1914 | 1915 | 1916 | 1914 | 1915 | 1916 |
|-----------|-------|-------|------------|-------|-------|
| Jan. 5.14 | 6.30 | 18.21 | July 4.75 | 20.54 | |
| Feb. 5.22 | 9.65 | 19.09 | Aug. 4.75 | 14.17 | |
| Mar. 5.12 | 8.40 | 19.19 | Sept. 5.16 | 14.11 | |
| Apr. 4.98 | 9.78 | | Oct. 4.75 | 14.05 | |
| May 4.91 | 17.63 | | Nov. 5.01 | 17.20 | |
| June 4.84 | 22.20 | | Dec. 5.40 | 16.75 | |

Zinc ore at Joplin, 60% metal, is \$85 to \$115 per ton; calamine, 40% metal, is \$75 to \$87 per ton.

TIN

Prices in New York, in cents per pound.

| Date | Average week ending |
|---------|---------------------|
| Feb. 29 | 37.25 |
| Mar. 1 | 37.12 |
| Mar. 8 | 36.62 |
| Mar. 14 | 36.50 |
| Mar. 21 | 36.48 |
| Mar. 28 | 36.79 |
| Apr. 4 | 36.87 |

| 1914 | 1915 | 1916 | 1914 | 1915 | 1916 |
|------------|-------|-------|-------------|-------|-------|
| Jan. 37.85 | 34.19 | 41.76 | July 31.60 | 37.38 | |
| Feb. 39.76 | 37.22 | 42.69 | Aug. 30.20 | 34.37 | |
| Mar. 38.19 | 48.76 | 50.50 | Sept. 32.10 | 33.12 | |
| Apr. 36.10 | 48.25 | | Oct. 30.40 | 33.00 | |
| May 32.29 | 39.28 | | Nov. 32.51 | 39.50 | |
| June 39.72 | 40.26 | | Dec. 32.60 | 38.71 | |

Tin is strong at 50 to 52 cents.

Antimony continues strong in New York at 45 to 46¢, duty paid for Chinese and Japanese grades. Canadian interests have contracted for 500 tons delivered during the remainder of the year.

Eastern Metal Market

New York, March 29.

Lead continues to present the prominent feature of the market. The price to domestic consumers is about 8c., New York and St. Louis; but this is the quotation of independent producers, and not that of the A. S. & R. Co. The latter disapproves of the present high speculative level of prices, regarding it as unfair to American consumers, regardless of what the nations at war may pay. It is selling on the average of its quoted prices, not on the daily price quoted. For export, sellers have refused a price equal to 8.50c., St. Louis. Again, 8.25c., Chicago, has been done. Copper is firmly held awaiting a renewal of foreign buying, following which domestic consumers are expected to become active. Zinc has been dull and is easier, and, in view of the many offerings, the trade is beginning to wonder if production has been overdone. Ample tin arrivals have eliminated fear of a shortage, but the price stands at 50c. Antimony was strengthened by some good Canadian buying. Aluminum is practically unchanged.

In steel the crest of the high prices appears to have been reached, although it is dangerous to predict these days. Foundry pig-iron, which has been lagging as compared with steel, is showing more activity and prices are stronger. Steel forging-billets are stronger, while the other products show but little change. Pittsburg quotations are 2.75c. for steel bars, 3.50c. for plates, and 2.50c. for shapes. Eastern Pennsylvania makers exact premiums over these prices. Two enterprises for the mining of manganese ore in Virginia, and its manufacture into ferro-manganese for steel-making, have been organized.

COPPER

The market is quiet, but firm, awaiting a renewal of demand from abroad which, when it comes, is expected to stir domestic consumers to activity again. Trading continues to be, so far as there is any, in forward positions. June and July electrolytic is quoted at 26.75 to 26.87c., the lower price being quoted by second-hands and for limited quantities. Immediate shipment is quoted at 28.50c., but a firm offer of 28c. would not be turned down. April and May can be done at 27.25 to 27.50c., and June and July at 27c., 30 days, delivered, equal to 28.87c., New York, and, as already said, this price might be shaded. On one or two days there has been moderate buying, but on the whole the market has been quiet almost to dullness. The freight embargo against New England metal users has been raised occasionally, and this has permitted them to get deliveries of much needed supplies, but their stocks are still low and their situation uncertain. Last week it was reported that the French government was in the market for 2000 to 4000 tons, and yesterday a report was current that the same country was inquiring for 10,000 tons, but no one seemed to know the source of the alleged inquiries, and there is a strong suspicion that these reports were given circulation to build a slow market. It is usually so with reports that first appear on the financial news ticker and in Wall Street papers. Of course, France is expected to buy in the near future. Lake is entirely nominal at 27.12c., June and July delivery. The London quotation for electrolytic is unchanged at £136. Exports to the 28th totaled 20,873 tons.

ZINC

In the past week this metal has been almost continuously dull, and some evidence of pessimism is discerned in the selling trade. The quotation yesterday was about 17.75c., New York, equal to 17.50c., St. Louis, for prompt shipment, while April could be had at about 17.25c., St. Louis, and May at 16.50c., St. Louis. The trade is wondering if the production of spelter is not being overdone, a thought which has its in-

ception in the large number of offerings which are being made. Persons and firms never before heard of in the metal field are said to have spelter to sell, and there can be no question but that production has been crowded to its utmost. Again it is pointed out that the demand from abroad may be lessened in view of a move of the British government to help along production in England. The plan is to subsidize companies which smelt Australian ores. At the same time, the metal so produced will not be available for months to come. Exports from the 1st to 28th, inclusive, were 1405 tons. The London quotation for spot zinc was £95 on the 28th. Sheet-zinc is unchanged at 25c., carload lots, f.o.b. mill, 8% off for cash.

LEAD

The situation continues a most interesting one. Though domestic consumers have paid from 8 to 8.25c., the first-named price is nearer the actual market. Japan and Russia continue anxious to get lead by way of Pacific shipment, but many of the producers profess themselves unwilling to take the business at any price. In fact it is protested on several sides that the domestic consumer must be cared for. The A. S. & R. Co. continues to quote 7c., New York, but this is a nominal figure. Where it is making sales the stipulation is made that monthly averages of its own quotations must govern. The company's method of quoting, or rather not quoting, aroused so much comment that an explanatory statement was issued by Edward Brush, vice-president. He stated that the A. S. & R. Co. desires to do business in a stable manner and not along speculative or temporary lines; that more than 75% of the company's production of lead is sold on average-price contracts; that it prefers to give preference to its regular customers, and that: "If the price of pig lead continues to advance, it will result in decreasing consumption and curtailing the lead industries of the United States. It is not the opinion of this company that this would be advisable, even if the extraordinary demands of other parts of the world are such as to warrant their paying prices for war material that are not warranted by domestic consumption." Earlier in the statement appears the following: "Aside from the amount of lead produced by our own mines, all of the lead that we produce is received from mines with which we have contracts requiring the miner to ship his entire production to our company, and for which the miner is paid daily in accordance with our quoted price. Therefore, the lead that we receive in any month is paid for by us to the miner at our average quoted price for the month." Other interests have shown themselves averse to selling for export. Last week an offer equal to 8.50c., St. Louis, for export by way of the Pacific Coast was declined. At the same time 8.25c., Chicago, was paid, and for the first time in the memory of the trade, lead was shipped west from New York. This week the market has quieted down, and it is hoped that more normal conditions are near. Odd lots in the hands of those who desire to realize profits are coming out. The London quotation on March 28 for spot was £34 15s. Exports to the 28th totaled 4001 tons.

TIN

Fears of a shortage of tin this month have been dissipated by the rather large arrivals of the month, which up to the 28th totaled 3803 tons. There was afloat on that day 4825 tons. The market has been dull for days, except for one or two flurries of fair inquiry for April delivery. The New York quotation for spot yesterday was 50c. The Welsh tin-plate manufacturers are taking little tin, and this may have released some of the recent arrivals. The American tin-plate producers are consuming at a heavy rate.

COMPANY REPORTS

SOUTH EUREKA MINING CO.

The result of operations during the year ended February 29, 1916, has been supplied us by the secretary and treasurer, Edward Fox as follows:

| | |
|--|-----------|
| Ore treated, tons | 145,124 |
| Recovered value of ore | \$3,964 |
| Average yearly tailing loss | 9,375 |
| Average yearly value of ore milled | 1,339 |
| Average yearly value of concentrate | 68,990 |
| Average yearly cost per ton milled | 3.987 |
| Gross bullion production | \$111,633 |
| Gross concentrate production | 163,698 |
| Earnings from investments | 1,730 |
| Earnings from rentals, supplies, etc. | 2,993 |
| Balance paid out in excess of receipts | 2,708 |
| | <hr/> |
| | \$582,762 |
| Operating expense | \$148,013 |
| Construction and equipment | 8,825 |
| Dividends paid (38¢ per share) | 125,354 |
| Material and supplies | 570 |
| | <hr/> |
| | \$582,762 |

This company operates at Sutter Creek, Amador county. It has a deep incline shaft and good 80-stamp mill and concentrating plant.

PHELPS, DODGE & CO.

Copper Queen Consolidated Mining Co., Detroit Copper Mining Co., Moctezuma Copper Co., Burro Mountain Copper Co., Bunker Hill Mines Co., Stag Cañon Fuel Co., Phelps-Dodge Mercantile Company.

With an issued capital of \$45,000,000 Phelps, Dodge & Co. controls the above operating companies in Arizona, Mexico, and New Mexico. The report covers 57 pages. The president, James Douglas, states that the records of the company for 1915 embody some interesting vicissitudes besides those of its statistics.

The total production of the firm's copper companies amounted to 149,478,993 lb. As there was no copper treated for outside concerns on toll this shows an increase of 8,815,679 lb. from company and custom ores over the output for the previous year. This large output was secured although the production, which had been lowered in 1914 by reason of the stagnation of the markets, was still curtailed for two months of 1915, and was further affected by the strike which closed-down the Detroit mines in September until after the close of the year. The Mexican troubles also repeatedly paralyzed railroad transportation between Nacozari and Douglas, and compelled a shut-down of the Nacozari plant for 135 days.

Including copper received from outside sources, 194,925,668 lb. was sold and delivered to buyers at an average price of 16.979¢ per pound, net cash, f.o.b. New York.

Of the total quantity of copper sold and delivered during 1915, there was sold almost equal quantities to the domestic and foreign trade.

The market during the year followed an extraordinary course. When prices advanced, to derive the utmost benefit from the improved market, the blast-furnaces at Douglas were driven to their utmost speed, and the new reverberatory-furnaces smelted daily from 600 to 700 tons of ore. A large reserve of ore had accumulated at the smelter, which was freely drawn upon.

The policy of the company in Mexico has been to employ as few Americans as possible, and to educate Mexicans to take the place of Americans when the latter could be dispensed

with. The experiment was skillfully worked out when James S. Douglas was superintendent, and has been followed by J. S. Williams, who succeeded him, and his aides. It seems quite possible to raise a native community to a commendable standard of living, and to educate a selected number in modern methods of work.

The year passed without any friction at the Stag Cañon coal mines, despite the proximity of the Colorado mines, which were the scene of so much disorder.

The Burro Mountain mines have been put in condition to produce ore, and the mill should start up within a month (March or April).

It is too soon as yet to predict the fate of Tombstone, but initial work leads the management to believe that profits will come from several other metals besides gold and silver.

During 1915 Phelps, Dodge & Co. results were as under:

| | |
|---|--------------|
| Earnings | \$10,981,512 |
| Less ore depletion and plant depreciation | 1,261,937 |
| Net | \$ 9,720,175 |
| Balance from 1914 | 7,517,389 |
| | <hr/> |
| Total available | \$17,237,864 |
| Dividends paid (4) | 9,000,000 |
| | <hr/> |
| Balance for 1916 | \$ 8,237,864 |

Metals on hand and in process are valued at \$14,552,370.

Four dividends of 2½% each, an extra dividend of 1% in March, and extra dividends of 3% each in June, September, and December, in all aggregating 20%, were paid during 1915, amounting in all to \$9,000,000.

The general manager, Walter Douglas, stated that the copper ore extracted from all mines amounted to 1,583,361 tons, of which 809,600 tons was submitted to preliminary concentration and 782,761 tons was smelted direct. The total amount of copper-bearing material smelted, including ore, concentrates, old slag, and cement copper, was 1,129,766 tons. The copper bullion contained 29,840 oz. gold and 1,388,149 silver.

In addition, there were produced and sold 39,412 tons of lead ore and concentrates from the Copper Queen and Bunker Hill mines, yielding 892,000 lb. copper, 9,525,584 lb. lead, 267,520 oz. silver, and 1856 oz. gold.

Of the ore and concentrates smelted, 1,016,716 tons was derived from the company's properties, and 113,029 tons was purchased.

At the mines of the Copper Queen, continued and systematic development by churn-drilling has extended the previously discovered bodies of disseminated ores so considerably as to assure many years' supply for a large concentrator. The copper-content of this ore is above the average of similar deposits now being profitably exploited, and the percentage of recovery, as demonstrated by the experimental mill operated throughout the year, is quite satisfactory. Ore reserves in the Limestone division of the mines remain approximately the same as at the commencement of the year.

At the Burro Mountain mines, development, confined almost exclusively to preparing the known orebodies for extraction, has in some cases materially extended the areas of these deposits. Churn-drilling has also served to discover other ore occurrences which may be of great importance when systematically defined and explored. The property of the Savanna Copper Co., comprising about 2234 acres and adjoining that of the Burro Mountain company, was purchased. Exploratory drifts are being driven from the Niagara adit and No. 3 shaft to prospect a deposit the existence of which was discovered by the Savanna company some years ago.

Operations on the upper levels of the Bunker Hill Mines Company have not as yet developed orebodies of great size or commercial importance. The low-grade material which has been opened in the mines has been thoroughly tested by both cyaniding and concentrating, with inconclusive results. A

profitable market now exists for the manganese ores which occur so generally through some sections of the property, and advantage will be taken of the present high price for this mineral to ship heavily of both ore and concentrate.

In the Phelps Dodge Mercantile Co. the total sales and the net profits slightly exceeded those of 1914.

The superintendent of the Copper Queen mine, Gerald Sherman, reported that exploration and development amounted to 68,432 ft. in the Limestone mine, and 3207 ft. in Sacramento hill (also 42,953 ft. of churn-drilling), in addition to 9924 ft. of special work, and 3772 ft. for development of lead ore. No new orebodies were found, but reserves were kept at the maximum quantity. These were 2,696,940 tons in the Limestone, and 11,633,481 tons of 2.455% copper ore in the Sacramento. There was mined 722,344 tons of 6% ore, 65.9% of the quantity by the square-set method. Direction of scientific underground work is in charge of the geologist, Arthur Notman.

Forest Rutherford, in charge of the reduction-works at Douglas, stated that 7.79 blast-furnaces treated 1,012,669 tons, 1.68 reverberatories 207,677 tons, and 5.3 converters 34,237 tons of various materials; 11.4 roasters also operated. Metal production was 125,144,027 lb. copper, 1,388,149 oz. silver, and 28,840 oz. gold. The laboratory made 111,268 determinations. Little new construction was done. The irregular shipments of ore and concentrate from Nacozari rather interfered with smooth operation.

The general manager, S. W. French, reviewed the Copper Queen's results generally. There was an average of 1883 men at the mines, 965 at the works, and 18 in the hospital department; a total of 2866, against 3178 in 1914. Wages were advanced in May, on the basis of the price of copper. Injured employees received a total of \$41,027, less than half of that in 1914, due to safety precautions. Nine men were pensioned, making 25 in all under this scheme. The employees' benefit association's income was \$62,977, the company contributing \$12,500. The year left a surplus of \$16,465, against \$5700. An average of 76.3% of all employees are members. In the hospital department, Dr. F. E. Shine reported a deficit of \$6456 on an income of \$81,357. A great number of calls, examinations, operations, etc., were recorded.

At the Detroit property, the mine superintendent, Frank W. McLean, reported that development advanced 14,709 ft. Working conditions were good, but the orebodies are decreasing in size. There was one fatal accident. There was extracted 372,710 tons of 2.8296% ore, of which 361,970 tons averaged 2.694%, suitable for milling.

V. P. Hastings, in charge of the smelter at Morenci, stated that the plant reduced 110,286 tons of ore concentrate, flux, etc., yielding 15,333,976 lb. copper.

Development, treatment, and general were discussed by the general manager, M. H. McLean. In the producing area of the mine, results were very encouraging. The mill saved 73.92%. A flotation unit is now at work. There were 1397 men employed. Production was suspended in September 11, due to the Western Federation of Miners' strike, now a matter of history.

Affairs of the Moctezuma Copper Co., at Nacozari, Sonora, Mexico, are described by J. S. Williams, Jr., the general manager. Owing to the revolution in Mexico the mill operated only 135 days. During the greater part of 1915 there was no train service between Nacozari and Douglas, so that it became necessary at three different times to pile concentrate on the ground. This and the subsequent loading of same into cars, was expensive and materially increased milling costs. There was treated 424,027 tons, assaying 3.412% copper, yielding 90,014 tons of 13.316% concentrate, with 83.6% recovery. In actual running time there was 1847.1 tons treated daily. Numerous tests were made with flotation, and a 600-ton plant is to be erected in 1916. The Copper Queen smelter produced 23,990,286 lb. of copper, 599 oz. gold, and 331,836 oz. silver from the concentrate, etc.

Development at the mine amounted to 7572 ft. Ore reserves to a depth of 1200 ft. are estimated at 2,912,830 tons net in place, and 307,142 tons broken in stopes, a decrease of over 250,000 tons. Greater depth is necessary to maintain reserves. The Pilares, 1285 ft., and Esperanza shafts are to be equipped with electric hoists of 2500-ft. capacity, also a steel head-frame at the latter.

Activities of the Burro Mountain Copper Co. in 1915 were directed mainly toward the completion of construction work at the mine and the concentrator, preparatory to entering the field of active production in the early months of 1916, according to the superintendent, E. M. Sawyer. Churn-drilling resulted in 20 holes being put down an average depth of 1030 ft. each, by three machines. The extent of the ore deposit was further proved. The experimental plant has treated 11,009 tons of ore, giving a scheme for the new 1000-ton mill. A

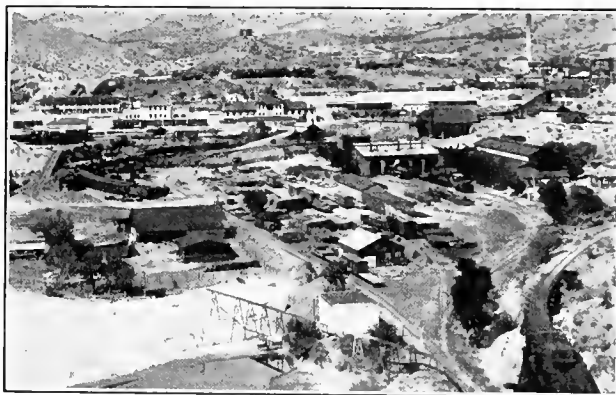

NACOZARI, SONORA, MEXICO.

total of 16,976 tons of ore, etc., was produced containing 1,354,377 lb. of copper. The hospital cared for a good many complaints. A town-site was decided on, and B. G. Goodhue, of New York, has planned the town. The central group of buildings will include a club-house, theatre, hotel, bank, depot, and post-office, as well as the company's general office and the Phelps Dodge Mercantile Co.'s store and warehouse. Sites have been chosen in the neighborhood for churches, and a school-house with ample capacity for present needs. Dwellings are being erected for employees.

The mine superintendent, E. F. Pelton, reports that ore reserves are 2,555,000 tons averaging 2.53% copper. Development last year cost \$5.352 per foot. Duplicate steel head-frames and hoists were installed at No. 2 and 3 shafts. There were 385 employees at the close of the year.

Re-opening the old Tombstone properties by the Bunker Hill Mines Co. has attracted much attention, and in the report of E. Grebe, the superintendent, are some interesting data. Development advanced 5049 ft. Results from prospecting in old workings and in virgin ground give promise of a considerable quantity of ore, generally low grade, above water-level. Marked improvements were made in the equipment for ore transport from mines to mill. Production was 10,746 tons of ore, containing 1373 oz. gold, 109,784 oz. silver, 269,303 lb. lead, 23,760 lb. copper, and 1,171,599 lb. manganese. The experimental cyanide test-plant treated 5788 tons of ore, with a recovery of 79.9% gold, 84.5% silver, and 35.6% lead. There were 297 men employed.

The general manager of the Stag Cañon Fuel Co., at Dawson, New Mexico, T. H. O'Brien, reports that 1,265,671 tons of coal was extracted. From 531,488 tons of washed coal was made 265,753 tons of coke. There were 9 fatal accidents. A good many improvements were made.

W. H. Brophy reports that the Phelps Dodge Mercantile Co.'s gross sales were \$6,210,457, an increase of \$290,234. The net profit was 8.54%. At all the stores were 480 employees.

BOOK REVIEWS

THE FLOTATION PROCESS. Compiled and edited by T. A. Rickard. P. 261. Ill. index. For sale by the MINING AND SCIENTIFIC PRESS. Price, \$2.

The science of flotation unfortunately has been violently attacked by the courts. Judgment has been suspended pending the separation of the contaminating influence of acid, and even "stipulations" from a clarified conception of the prior art. Much truthy argument has resulted, and hindered the experimental work on other ores and the probable general application of the process. From this mixture of patents, principles and processes, Mr. T. A. Rickard has extracted and presented to the mining fraternity, in concentrated form a clear and comprehensive review of the present status of this important subject. All engineers will welcome the publication of this competent, unprejudiced, suggestive, and helpful book on flotation. The application of the physics of liquids and gases to the separation of metals from non-metallic substances promises to revolutionize metallurgical industry and convert much of our present discarded waste into commercial material. Knowledge of the subject is still elementary, the basic principles are but imperfectly understood, and it is only by generous and competent discussion that progress will be made.

The 'Flotation Process' is an edited compilation of a series of articles by many engineers, giving the results, both successes and failures, of their work. It is therefore suggestive. Careful reading will obviate the duplication of failures and initiate further experimentation. The book is of practical value in that the reader is spared other than pointed reference to the early history of the use of oils to mineral separation. Several installations of different types are intelligently described and clearly illustrated. Conflicting ideas and interpretations of the principles involved necessarily exist and are presented in such form that they enlighten the reader. The researches and opinions of such men as Callow, Ralston, Durell, Bains, and others always carry weight, and the discriminating student will separate the concentrate from the froth even in books.

The lack of bias adds to the force and value of the book. Credit is given where credit is due, to all litigants and operators. The book is refreshingly free from party feeling, such as has characterized other writings on this subject.

This handy volume is not a text-book. It makes no claim to finality, but it is a timely contribution to metallurgical literature. It will supply superintendents with up-to-date information on the theory and practice of flotation, therefore serving a useful purpose to the mining profession. -F. H. P.

THE DIESEL ENGINE IN PRACTICE. By J. E. Megson and H. S. Jones. P. 176. Ill. index. Technical Publishing Co., San Francisco, 1916. For sale by MINING AND SCIENTIFIC PRESS. Price, \$2.

This is the second book on the Diesel engine that we have reviewed during recent months, and although there is an interesting lot of information included, it is not worth the price, other things being equal, with the other work. The subject is brought home to California engineers by notes and photographs (not very clear) of two makes of Diesels at the Exposition last year, and mention of the ship *Siam*, which called here. The first chapter gives a brief history of the engine. This is followed by operation of the two and four-cycle machine, with efficiencies, heat balance, etc. Experience with earlier installations is of interest. As fuel-oil is the source of power in the Diesel, a chapter is devoted to it. The effect of altitude is next discussed, as such engines do not develop as much power as at sea-level. Practical directions cover the operation and care of the Diesel, and its life and reliability. The commercial situation and use in ships concludes the work.

MINING DECISIONS

DEPOSIT ON MINERAL LEASE—WITH RECOVERY

Where a plaintiff had made a deposit to secure from defendant a coal-mining lease on certain stipulated terms, and defendant thereafter insisted on adding other conditions to which plaintiffs would not agree, and no lease was as a matter of fact ever executed, plaintiffs were entitled to recover their deposit.

Raccoon Coal Co. v. Faulkner (Kentucky), 181 South-western, 1196. February 2, 1916.

Oil Lease—Form Not a Prerequisite

An agreement between the holder of land under a contract of purchase and a second party, providing that the latter shall take possession of the land and develop oil thereon, rendering to the other a portion of the product in payment of its use, is a lease, irrespective of its form or the designation given it by the parties.

Comins v. Guaranty Oil Co. (California), 151 Pacific, 882. February 5, 1916.

ACQUESCENCE IN OIL-Well DRILLING—EFFECT

Where a land-owner in writing agreed to execute an oil-lease on certain land, and thereafter permitted the proposed lessees and their successors in interest to operate under the terms agreed upon for 25 years, although a lease was not as a fact ever executed, a court of equity will not grant an injunction to restrain further drilling in the area contemplated by the original negotiations, but will deem the acts to have been performed in accordance with some agreement.

De Hart v. Enright (New York), 157 New York Supplement, 46. January 1916.

Utah Land Grants—"Known Minerals"

The Circuit Court of Appeals (Eighth Circuit) has recently decided two important cases affecting coal lands in Utah. In the first cases cited below it was held that the grants by Congress to the State of Utah of specific lands for school purposes under the Enabling Act for that State carried all mineral titles with it as well as non-mineral titles. In the second case it was held that a "floating grant" made to the same State under the Act of July 16, 1894, did *not* pass title to lands known to be coal-bearing at the date of their selection, and that the claimants of said lands had defrauded the United States in alleging their character as non-mineral. The rule of the *Burke* case was invoked to the effect that the action of the Secretary of the Interior is not final where it is based upon *ex parte* fraudulent and false statements of claimants.

Sweet v. United States, 228 Federal, 421.

Milner v. United States, 228 Federal, 431.

Coal Lease—Effect of Failure of Mineral

A mining lease provided that it should continue for 15 years unless the mineable coal in the land should be sooner exhausted, that the lessee should pay a fixed royalty and, in case the royalties did not reach a minimum sum, should pay that sum per annum, and that the lessee should have the right to abandon the lease at any time on account of the thinness of the coal. The lessee opened a shaft and proceeded to extract some coal, but it soon petered out. Thereafter he used the shaft, in accordance with permission granted in the lease, to remove coal mined under adjoining land. Held, that the lessee was liable only for royalties on the coal mined from beneath the lessor's and not from the adjoining land, although the lease was not formally forfeited for some time after the first deposit was exhausted. A mining lease pre-supposes the existence of mineral, and is conditioned upon its existence.

Vandalia Coal Co. v. Enderwood (Indiana), 111 North-eastern, 329. February 2, 1915.



EDITORIAL



T. A. RICKARD, Editor

THIS was a war to end war; now there is much talk of the war after the war, that is, of a trade conflict between the two groups of belligerents, in which tariffs are to replace trenches and economic weapons are to be used as ruthlessly as hand-grenades. Only a confirmed optimist can foresee an abatement of the hatreds and prejudices of today.

PATENTS are again discussed in this issue, and in a most informing manner, by Mr. James M. Hyde, who will be recognized as the defendant in one of the most important litigations now pending over flotation patents. Mr. Hyde is able to see both sides of the problem, for he has been both a patentee and an alleged infringer of patents.

LETTERS under 'Discussion' this week include a timely notification by Mr. E. M. Hamilton, known to our readers as an experienced metallurgist, that cinnabar ores can be treated by flotation. Another metallurgical friend, Mr. F. H. Mason, contributes the very information we wanted concerning the treatment of antimonial gold ore in Nova Scotia. The third letter is a reply to our recent criticism of the State Insurance Commission. We are pleased to give Mr. Will J. French an opportunity to reply; and it must be granted that he makes a good defence.

WHAT the rise in spelter has done for mining is indicated by the annual report of the American Zinc, Lead & Smelting Co., which made an operating profit of \$5,293,878 in 1915 as compared with \$77,692 in 1914. In the last quarter of last year the profit was \$2,344,072 as against only \$320,251 in the first quarter. A working capital of \$3,668,707 is retained, in consequence of the great increase in the value of ore carried. The carrying of stocks of metal and ore is today increasingly burdensome to the big smelting companies by reason of the higher price of the products and the uncertain market.

NEXT Tuesday is the tenth anniversary of the earthquake and fire that proved so annoying to us and to many others in the year 1906. That catastrophe was a pin-prick compared with the calamity now shaking and burning Europe. Turning to matters less portentous, we recall that ten years ago at this time our contemporary at New York celebrated its fortieth anniversary, whereupon we made a kind reference to our "junior" on Manhattan island. This was followed by the destruction of our plant and library, so that since then we have been most careful in anything we have said about

that same useful periodical. We congratulate the *Engineering & Mining Journal* on its semi-centenary and wish it continued life and prosperity.

NAMES are easier given than withdrawn. In naming orebodies and shafts it is well to avoid points of the compass and similar terms. The 'north' shaft may fit until another is sunk farther north and a 'middle' ore-shoot may be descriptive at one stage of development only. We recommend the naming of the principal workings and orebodies after the engineers and directors of a company. It is a compliment and a convenience.

WHEN the punitive expedition crossed the border in pursuit of Villa, it was announced by the President that the troops would be withdrawn as soon as their purpose was accomplished, but no provision has been, or can be, made for contingencies arising from a failure to capture Villa. On that now hinges the next chapter of the Mexican melodrama. Villa is drawing the American troops farther and farther from their base, Carranza refuses to sanction the use of the railways for military purposes, a long line of communication has to be maintained and guarded, that line is subject to attack from bands of brigands or patriots—the distinction is unimportant—and such attack would lead to reprisals. In short, the Mexican question is still sitting on a powder magazine smoking an explosive cigar.

ONTARIO soon will be producing more gold than silver. In 1915 the silver output, mostly from the Cobalt district, was worth \$12,200,000; in the same period gold was produced, chiefly from Porcupine, to the value of \$8,386,956. The Hollinger is now one of the great gold mines of the continent; last year it yielded \$3,000,000, of which \$1,560,000 was paid in dividends, which represents 52% on the capital of the company. The Dome has improved in a gratifying manner, so that a largely increased production is assured. In the Kirkland Lake district, which was wildly boosted three years ago, the real work of development has been rewarded, so that, among others, the Tough-Oakes mine has become a sound enterprise. Altogether this province of Canada is proving itself a splendid mining region, for to the precious metals must be added nickel mining at Sudbury, responsible for an annual output of \$10,000,000 in nickel and copper.

LACK of shipping is going to prove an increasing check to international trade, for the use of vessels for transporting military men and materials, more than the actual destruction of shipping, has diverted a great

many ocean freighters from the trade routes. Rates to British ports are now ten times what they were before the War, and our Department of Commerce has figures showing that ships have carried in one over-sea voyage more than their hull value in 1914. Since then the increment has been 500 to 600%. Lloyd's list gives 2193 ships, representing 3,774,319 tons, as detained, captured or destroyed by belligerents up to January 22. Fully 4,000,000 tons of shipping has been requisitioned by the Allies, while 5,000,000 tons of Austro-German shipping is held at home ports. In short, one half of the total world's tonnage is no longer available for the purposes of normal trade.

OUR contemporary *Practical Engineer* brings forward a suggestion for a new system of measurement. The decimal system is based on the digital counting of human childhood, while the metre represents a division of a quadrant of the earth's surface, just as the yard was the measure of human reach. Both of these are arbitrary units; one is represented by a metal bar in Paris and the other by a metal bar in London. Neither has a scientific basis. Therefore our contemporary offers 5 feet or 60 inches as a convenient unit. It is equal to 1.524 metres, or 152.4 centimetres, and is divisible by 2, 3, and 4, while the length in inches is divisible by 2, 3, 4, 5, and 10. It is suggested that this new unit or *uu* should be adopted by the Pan-American countries, the subdivisions to be selected by a scientific committee chosen by the Pan-American Union. We submit the idea to our readers as something worthy of their consideration.

WE publish a timely article on the geology of the Cottonwoods, that is, the Big and Little Cottonwood districts, in Utah, by Mr. L. O. Howard, our regular correspondent at Salt Lake City. How much such information is in demand by mining operators is indicated by the petition being prepared for transmission to Washington asking that the Geological Survey render available forthwith all the information collected concerning this interesting mining region. The relative importance of the subject can be inferred from the fact that during 1915 there were 55 companies at work in the two districts, producing 27,309 tons of ore, valued at \$605,336, and employing 519 miners. These figures are not particularly imposing, for the operations are mostly on a small scale on young and promising mines. So far the speculative interest excited by the work in progress has been disproportionately big, for out of 10,867,514 shares traded on the Salt Lake Stock Exchange, no less than 6,707,481 represented properties in the Cottonwood and American Fork districts. Evidently there is public interest in this part of Utah, and that justifies the request for scientific information from the Survey. It will be noted that Mr. Howard expresses a poor opinion of the reconnaissance survey, made by Messrs. Butler and Loughlin in 1912, and published in Bulletin 620-I of the Survey. This work was done hastily, and without much good fortune, but it seems

to us that the people of any mining district should not be too severely critical of such tentative work, otherwise the Survey will be justified in withholding such preliminary information for belated confirmation. However, a little criticism will do no harm, it will lessen the self-complacency of the official geologist and stimulate the Survey to better effort.

MERCURIAL is a word to describe the market for quicksilver. It goes up and down with slight changes in the temperature of speculation. After reaching the extraordinary price of \$300 per flask, it has dropped to \$160 and dealings have become a matter of private negotiation. The market is in the hands of a few and for that reason has been anything but representative, as explained at length in our issue of April 10, 1915. Lately the demand for mercury to make fulminate or mine-contacts, anaesthetics or lighthouse mirrors, things maleficent or beneficent, as the case may be, has abated. The market is sensitive. A ship arrives at New York with 400 flasks and dealers are intimidated. The mines of New Almaden are said to threaten a sudden supply—several thousand flasks—from the dismantling of old furnaces, and so forth. But the clean-up of dumps and remnants of various sorts has been in progress for two years at New Almaden, so that the threat may be discounted. The shipment from Italy was sent to the Du Pont works, at Wilmington, to be manufactured into fulminate and then to be returned to Italy, just as another consignment from England was sent across the Atlantic, to the same manufacturer, also to be returned as an explosive. Speculators have been scared, but those who are mining cinnabar need not fear the lack of a good market so long as the War lasts.

RAINFALL at Globe, Arizona, is only 17 inches per annum, most of it coming in the months of July and August. This district is typical of the arid mountainous region in the South-west. Yet the Old Dominion mine at Globe is one of the wettest mines in the country. During the first half of last year, the pumps handled 1,624,740,000 gallons of water, while in March alone over 407,000,000 gallons was pumped, an average for that month of 13,000,000 gallons per day or 9000 gallons per minute. As our readers are aware, the amount of water that it is necessary to pump from a mine bears little relation to the rainfall or seasonal precipitation at surface. In some of the Lake Superior copper mines, for instance, in a region of plentiful rain and snow, the workings are unpleasantly dusty from lack of moisture in the lodes. In the long submarine slopes of the Nova Scotia Steel & Coal Company's iron mine, at Wabana, Newfoundland, only an insignificant amount of water is detectable, despite the weight of the Atlantic Ocean overhead. As is suggested by Mr. P. G. Beckett, the general manager for the Old Dominion Copper Mining & Smelting Company, in a paper prepared for the Arizona meeting of the American Institute of Mining Engineers, the topography and structural geology of a district play an important part in determining the flow of

water in a mine. At the Old Dominion, the Madera diorite, penetrated by one shaft and capping the main workings, resembles a decomposed granite in crumbliness, being "intensely porous." The dacite flow underlying this rock is not, at first sight, particularly porous, "but once fractures in the dacite allow the downward seepage of water from the diorite above, the formation loses all pretense of firmness, absorbs water like a sponge, and becomes sandy, crumbly, and difficult to hold." It is interesting to note that the Calumet & Arizona Mining Company at Bisbee, where similar arid conditions obtain, ordinarily pumps over 1,500,000,000 gallons of water per annum from its Junction shaft. We have known of companies planning shaft-sinking equipment which provided plentiful pumps and boilers to handle the immense amount of water that was anticipated, only to be pleasantly surprised by finding almost none. The reverse case, where shafts have been inundated because of lack of preparation, is not unknown. Obviously an investigation of local geologic conditions is a good precaution before planning any large work of underground development.

Korean Mining Ordinance

Recently we commented on the regulations governing, and restricting, mining by foreigners in China. Now we have before us a copy of the mining laws promulgated on December 24 last, and to be enacted on April 1, by the Japanese government in Korea. Evidently the new regulations are intended to be enforced as soon as it is apparent that the British and American governments will interpose no serious objection. After the Japanese armies had over-run Korea during the war with Russia, a pledge was given to withdraw in due course and a promise was tendered, at the instance of John Hay, representing the United States, that equal rights would be given to other nationals; in short, the policy of the 'open door' was recognized by Japan, meaning thereby that commercial opportunities in Korea would be rendered available to all nations on equal terms. Precisely the same understanding was reached with the British government, which in its treaty with Japan obtained recognition of "the principle of equal opportunities" as was duly recorded in a Japanese official publication in 1907. Just now, of course, the British government is too busy to bother about any commercial question with Japan, and the government at Washington is also somewhat pre-occupied, thanks to Villa and the submarines, so that not improbably sundry foreign secretaries will wake up one fine morning to discover that the 'open door' to mining in Korea has been bolted. It is true, the new regulations provide that those desirous of exploiting mines in Korea must incorporate a company under the laws of Japan, and this, it may be said, places everybody on an equal footing. But the Japanese authorities are well aware that British or American capital is unlikely to be placed in Japanese companies operating under such conditions, of attitude and discretion, as are outlined in this mining ordinance. For instance, the

authorities can compel the employment or discharge of any "technical superintendent" they specify; they can demand that details of every plan for working a mine be filed in advance and become subject to alteration by the Governor General; the qualifications and duties of mine superintendents are to be regulated by the same official and he may examine the entire correspondence of any company. Many of the 64 clauses in the regulations are of such a restrictive nature as to deprive companies of all initiative and power of action in developing their mines. In case of two applications for a given property reaching the mining department on the same day, the Governor General is to issue the permit to whichever applicant he prefers. This would enable a clerk or other person in the office at Seoul to inform his friends that a foreigner experienced in mining had entered an application, giving particulars so that a second application could be filed on the same day. Under such conditions the foreigner would find it difficult to prove collusion or to obtain redress. The royalty to be paid by the holders of mining rights is 1% of the total value of the mineral output, together with a ground-rent of 25 cents per acre, to be paid in advance, annually. These exactions are not unreasonable, but "the total value" is to be decided by the Governor General, and any evasion or attempt to evade the royalties or ground-rent is punishable by a fine equal to three times the amount of the taxes involved.

If we compare these regulations with those in force in Australia, where the warden of a mining district is given discretionary powers in the administration of the leasing system, under which claims are worked there, and if we consider our own mining laws as they would appear to the detached view of a Japanese operator, we must concede that the terms of this ordinance are not without precedent. We in California have a 'blue sky' law whereby the Commissioner of Corporations can exercise a paternal restraint on speculation at least comparable with that of the Governor General in Korea. But neither here nor in Australia is any official allowed such powers of interference as will be granted to him in Korea under this ordinance. Obviously the effect of the regulations will depend more on the manner in which they are administered than upon the rules themselves; conditions can be made comfortable or impossible according as the local government chooses. This introduces a factor of uncertainty highly prejudicial to foreign enterprise. Evidently the mining law enables the Japanese officials in Korea either to shut out the further participation of foreign capital in mining exploitation or to permit of it under conditions agreeable to themselves.

And yet one point more needs to be mentioned. Our readers, having a sense of humor, will appreciate the position of an editor in California criticizing any action of the Japanese calculated to exclude American enterprise from Japanese territory, which Korea has become by a process of benevolent assimilation not unknown in the history of European expansion, in Asia, for example. The people of California, by its legislature, set out to prevent the holding of real property in this State by

Japanese individuals or by Japanese controlled corporations. The government in Korea has not gone quite so far. We would be handicapped in our protest if Japan had not broken both the spirit and the letter of a contract with the United States and of a similar contract with Great Britain. On the basis of those contracts we are justified in demurring to an ordinance that appears meant to exclude further foreign participation in Korean mining enterprise.

The Way of the Reformer

We have been favored with a copy of the correspondence between a mining engineer in Utah and the secretary of the American Mining Congress. This exchange of ideas, developing into a friendly controversy, presents several features that are of general interest. In the first place Mr. Engineer demurs to the inclusion in a committee of any persons either not connected with mining or of those known to be identified with disreputable phases of that business. He objects to making mining operations a mere excuse for share-dealing of an irresponsible kind. He refuses to identify prosperity with a swarm of wild-cats. He is all for scraping the barnacles off the good ship of which he considers himself a responsible officer. He would jettison the lawyers, brokers, promoters, and others that exploit, not mines, but men. Finally, he pours the vials of his scorn on a circular that describes mining "as safe as the manufacture of boots and shoes, when skill and capital are applied to its operation." All of this strikes a sympathetic chord, compelling us to sit back and applaud this Don Quixote of the salt marshes. Then comes the courteous reply of the Secretary, beginning with the disarming statement that a particularly objectionable individual, mentioned by Mr. Engineer, had been refused membership. Don Quixote is told that he ought to join the army of reform instead of tilting at wind-mills; he is assured that the Mining Congress is endeavoring to check just the kind of fraudulent mining of which complaint is made; and he is informed that any effective campaign has been hindered by lack of financial support from Mr. Engineer and his top-lofty friends. As to the creation of a bureau empowered to scrutinize prospectuses and the like, Mr. Secretary is of the opinion that there are already too many "holier than thou" organizations willing to criticize but unwilling to take action in bringing punishment to "those who prey upon the public." Whereupon Mr. Engineer answers less truculently, but he jibes at some of the members of a local committee of the Congress and suggests that "to have such people posing as guardians of the public weal is a pathetic joke." As to financial support, he shies at the suggestion and contents himself with a hint that the operations of the Congress do not appeal to a business man. He jumps on the "manufacturing" idea of mining and enjoys himself while he lashes at a pathetic fallacy. Here he gets Mr. Secretary in a tight corner and tells him a few home truths in regard to the sport of mineral exploration and the essential risk of mining. The money put into mining is usu-

ally the surplus of the wealthy, to whom the idea of safety does not appeal in equal degree to that of luck. From the moral altitude reached by way of the superior insight thus outlined, Mr. Engineer proceeds to tell Mr. Secretary what he ought to do: reorganize, decrease the local council to a small number of Class A persons, who shall inquire into local mining flotations and expose them, when fraudulent; the Congress to publish the reports from its local councils, and sell this record for \$10 per annum; Mr. Engineer will subscribe and get ten others to do so. As to libel suits, they will be few, and of those only a rare one will come to trial. It must be confessed that Mr. Secretary is given a stiff dose, but he takes it like a hero. His reply proves him a diplomat. Expressing appreciation of Mr. Engineer's suggestions, he retorts politely that the Mining Congress has suffered from the fact that men like Mr. Engineer, with definite ideas and the courage of their convictions, have held aloof because some others of its members did not reach their standard. To be effective in influencing legislation the Congress must have a larger membership than would be possible under the exclusive ideas of Mr. Engineer. The control is now in the hands of the kind of men approved by the aforesaid critic and the present standing of the organization testifies to this fact; so says the Secretary. After that the correspondence fades into amiable commonplace. We have given the outlines of the more intensive proportions of it because it expresses points of view often heard around the camp-fire, the hotel lounge, and the club bar. It exhibits the difficulties to be encountered by the reformer. The chief of these is the obtaining of financial support without loss of character. Needless to state we are saying all of this on our own initiative. If we had the say for a few minutes we would give the Mining Congress an income on which it could proceed to enlighten legislatures, prosecute fakers, and educate the public. The only trouble would be that a number of other organizations would make life miserable for us with claims for similar support. Joking apart, the first need of the Mining Congress is regular financial support. It has done good work in getting us the Bureau of Mines and it has undoubtedly stimulated the Post-Office authorities in checking the use of the mails for fraudulent purposes. Other good work could be instanced; for example, as regards the mining law and forest reservation. If some measure of financial contribution could be forthcoming from the industry at large, as, for instance, by a regular donation from all the dividend-paying mining companies, each contributing a relatively small amount, it would be practicable to lift the Congress into a position of greater usefulness. There is need for some such organization. Superior as the engineering societies are in many ways, they are inferior as reflectors of the public at large; they are essentially professional; and the business of mining is more than that. In its varied phases it is an art, a profession, a business, and a trade; yet in the end the artificer, the professional, the business man, and the trader alike depend on public support, and to get that mining must be legitimate and productive.



DISCUSSION

Our readers are invited to use this department for the discussion of technical and other matters pertaining to mining and metallurgy. The Editor welcomes the expression of views contrary to his own, believing that careful criticism is more valuable than casual compliment.

Flotation for Cinnabar

The Editor:

Sir—In view of the present high price of mercury and the frequent references to mercury ore in your columns it may interest your readers to know that cinnabar can be treated very successfully by flotation. The difficulty in treating this ore by mechanical concentration seems to be that with coarse crushing the large particles of cinnabar are for some reason thrown or floated into the gangue, although a good saving is made on the fine material, while if the whole ore is crushed fine before tabling, some of the mineral is reduced too fine to be held on the table and goes off in suspension with the tailing.

By crushing the ore to pass 60-mesh we have succeeded in obtaining very high recoveries by flotation, both with the Minerals Separation type of machine and also with the Callow. For instance: a sample of Californian ore assaying 0.1% mercury, crushed to pass 60-mesh and floated, gave a tailing of 0.01% as reported by one assayer, and zero as reported by another, showing 90% and 100% extraction, respectively. The amount of concentrate recovered was 2.17% of the original weight and assayed 4.15% mercury, but as a high-grade product was not required, no attempt was made to raise the value above this point.

A sample from another district in the same State assayed 0.3% mercury, and when crushed to pass 60-mesh and floated, gave a concentrate assaying 26.8% mercury in 1.12% of the original bulk with a tailing of 0.03%, showing a recovery of 90.95% of the content.

A sample from a third district assaying 0.92% had to be crushed to pass 80-mesh to obtain the best results. This yielded a concentrate containing 18% mercury in 4.78% of the original bulk, with a tailing of 0.06%, giving an extraction of 93.7%.

E. M. HAMILTON.

San Francisco, April 4.

Mine Accident Insurance

The Editor:

Sir—The editorial in your issue of April 1 on this subject deserves a reply. I asked the manager of the State Compensation Insurance Fund, Mr. C. W. Fellows, to write me a memorandum. This is his reply:

“It is said that the State has upheld excessive rates for compensation insurance covering mines. The facts are clearly not in accord with this statement. The Work-

men's Compensation Service Bureau of New York established a rate of \$7.86 for mines in California and in 1914 this rate was followed by practically all the corporate companies. In the latter part of that year the State Compensation Insurance Fund withdrew its co-operation with the Bureau on mining rates and, after an exhaustive study of statistics, found that the pure premium cost, with necessary loading for expense and catastrophe, showed a necessary rate of 5%. When this rate was quoted by the Fund, the Bureau followed by meeting the figure. Some of the corporate companies, however, refused to take the business at that rate, but one well-known insurance company and the Commonwealth Bonding & Casualty Insurance Company of Texas made a strenuous bid for the business. The “well-known insurance company” finally took most of it at a rate of \$3.25. Some risks were written at even less rate by the Commonwealth. The result of this reckless underwriting is indicated by subsequent events. The Commonwealth failed miserably, leaving thousands of dollars of unpaid liabilities and many employers and employees unprotected. The recent examination of the “well-known insurance company” by the California Insurance Department (not the Industrial Accident Commission) showed that the company's losses and expenses, based upon the estimates of its own experts as to unpaid claims, amounted to 117% of its premiums. In other words, it has paid or must pay \$1.17 for each dollar collected. That experience covers its entire compensation underwriting, and as the mining business was written at a greater cut than other lines, it is safe to assume that its experience on mining business will show a much greater loss ratio than its average on all classifications. Is it reasonable to assume that the two companies are ‘perfectly solvent and reliable’?

“These two very apparent results of rate-cutting, which are inimical to the interest of the public, are sufficient justification for the Uniform Rating Statute. This statute merely vests in the State the right to judge from actual statistics the adequacy or inadequacy of rates for the protection of the public against insolvency of insurance carriers. The statement that rates are higher because of State supervision is not borne out by history. Had the State not entered the field, the mining interests would be paying much more (as in 1914) for this insurance than at present. This is demonstrated by the fight which has recently been waged by the Workmen's Compensation Service Bureau to secure the approval of the Insurance Commissioner to a material in-

crease in mining rate, the Bureau insisting that the \$5.75 rate is inadequate. Because the State Compensation Insurance Fund has the only reliable statistical data on the subject, it has been able to keep the approved rate to \$5.75, as against a rate of \$7.71 suggested by the Bureau.

"The State Compensation Insurance Fund operates on the principle that it must collect a premium which will meet all contingencies, but as its expenses are less than other carriers, it has been able to return substantial refunds to policy-holders."

In the foregoing statement Mr. Fellows has clearly outlined the situation from an insurance man's point of view. I am especially interested in the discussion because of the "good-will and co-operation that seems assured between the mine operators and the Accident Commission," to quote your editorial. This co-operation is exemplified in the friendly spirit shown toward the work of the Commission's Safety Department. One important factor in reducing insurance rates is the prevention of injuries in the mining industry of California. Insurance rates are based on the hazard of the occupation and the Industrial Accident Commission is sure that the 'Safety First' agitation will prove successful. One noteworthy indication of this is that in 1914 there were 66 deaths in mining operations in California, and in 1915 there were 60 deaths.

The rates quoted by the State Insurance Commissioner are only tentative rates. If a fuller experience shows that a larger premium was received than was necessary, the State Compensation Insurance Fund will return the excess to mine operators who insure with the Fund, just as has been done with other employers since January 1, 1914. Other insurance carriers can also refund excess premiums, if their financial condition, in the judgment of the State Insurance Commissioner, warrants the course. This plan provides for mine operators paying the actual cost of their insurance and no objection can be raised to this plan. The solvency of insurance carriers is so important that employers and employees should join hands with the State authorities in an attempt to prevent the distressing experiences that have followed the failure of the Commonwealth Bonding & Casualty Insurance Company.

WILL J. FRENCH,
COMMISSIONER.

San Francisco, April 6.

Antimony Gold Ore

The Editor:

Sir—Relative to your foot-note to Mr. Wm. Seward Mann's letter on the 'Treatment of Antimony Gold Ore,' which appeared in your issue of March 25, the difficulty in treating West Gore antimony-gold ore was not the removal of the caustic soda, prior to cyaniding, but that, in parts of the mine, the ore carries a large proportion of metallic antimony, which is not soluble in caustic soda, and which, remaining in the pulp, formed a precipitant for any gold that the subsequent treat-

ment with cyanide dissolved, and thus prevented its removal from the pulp.

The process, which was devised by Mr. J. S. MacArthur, is one of those exceedingly interesting ones in which the reagents used are rehabilitated, and, it would seem, should work both economically and well on an ore free from metallic antimony. The following was the method Mr. MacArthur used: The pulverized ore was leached with a 2% solution of caustic soda until the sulphide of antimony was removed, thus:

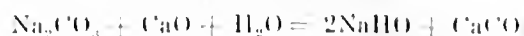

Carbon di-oxide formed by the burning of limestone, was passed through the antimonial solution, precipitating the metal as sulphide, thus:

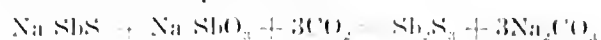

The solution was removed from the antimony sulphide by decantation and filtration, and converted into sodium hydrate, ready for use again, by caustic lime:

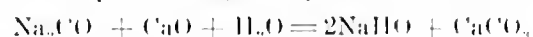

Limestone is generally too cheap a commodity to make it worth while carrying the rehabilitation further, but, if necessity should arise, the caustic soda can be decanted from the carbonate of lime, and the latter burned, giving CO_2 to precipitate more antimony sulphide and CaO to re-vivify the carbonate of soda formed.

Sulphide of soda was also tried on West Gore ore, and, with protracted contact, was found to dissolve metallic antimony, by first coating the particles of metal with sulphide, which, in turn, was dissolved in excess of the reagent. Unfortunately, however, the sulphide also dissolved a marked quantity of gold—about 20%—so the use of it had to be abandoned.

I notice from the annual report of the Department of Public Works and Mines for Nova Scotia that the West Gore mine, after being closed for a number of years, was re-opened in October, 1914, and last year from 10,782 tons of ore, produced 783 tons of concentrate, which contained 1698 ounces of gold.

F. H. MASON.

Panama California International Exposition,
San Diego, Cal., April 1.

NEVADA, with a population of 100,000, had a mineral production in 1915 of over \$25,000,000. Its area is 110,700 square miles, which is nearly twice that of Wisconsin, but the population of the entire State is less than that of Salt Lake City, Tacoma, or San Antonio. Nevada's population of less than one person per square mile is the smallest of any State in the country, comparing with 18 per square mile in California, 50 per square mile in Michigan, and 500 per square mile in Rhode Island. Nevada's production of copper for 1915 rose in value to that of its gold production, each being slightly under \$12,000,000, while its production of silver was valued at \$8,000,000. Nevada ranks with Montana as the premier silver-producing State. The output of zinc increased rapidly in 1915, particularly in the Yellow Pine district and at Pioche.

The Need of a Change in the Patent Law

By James M. Hyde

IN order to promote the invention and adoption of such improvements as are necessary to the best development of the industrial arts, our Government early adopted the policy of granting monopolies to the use of such improvements to inventors for a period of years. This policy is based upon the assumption that the possible possession of such a monopoly of the profit to be gained from the exploitation of an invention will act as a stimulus to those who have inventive capacity, inspiring them to devote their time and resources to devising and perfecting improvements in apparatus and processes valuable in the arts and sciences, and causing them to make public the details of their inventions so that when the patent expires the public may have full knowledge of the invention and may therefore be able to make use of the same; and that the possession of the temporary monopoly will make it possible for the inventor, either by his own efforts or by the efforts of others, to reap such profit from his invention as to warrant the expenditure of the time and money necessary to foster the general adoption of the invention.

As our system now works out, a patent does not, in fact, establish its possessor in a monopoly of his invention. One of our greatest inventors, Thomas A. Edison, is credited with the statement that "a United States patent is nothing more than an introduction to the highest courts of the land," and anyone who has been introduced into that exclusive society realizes the expense which such an introduction entails.

The present position as regards patents is, in brief, about as follows: When one has devised some method or apparatus that he conceives to be new and of such possible value as to warrant obtaining a patent upon the same, he obtains the services of a patent attorney to assist him in the proper filing of his papers and the presentation of his case before the United States Patent Office. For some time past, the standard cost of obtaining a patent has been \$75. Of this amount \$35 must be paid to the Patent Office in fees and \$40 is paid to the patent attorney for his services. The ease with which patents may be obtained is indicated by the meagerness of the patent attorney's fee, and by the further fact that many firms of attorneys guarantee either to obtain a patent or to make no charge for their services. They are entirely safe in doing this, as it is practically always possible to make some modification of an idea, deviating in some slight degree from that which has been done in the past, so that it will be patentable, even though it may be of no value. The patent obtained may not in any way cover the apparatus or process that will actually be used or marketed by the alleged inventor, but he nevertheless may obtain a patent or series of patents upon

which to base claims of patent rights and give him so-called 'talking points.'

When the inventor has obtained a patent he has no means of preventing the infringement of it, except by suing the alleged infringer in a U. S. District Court. Likewise, the individual who believes that a patent is invalid and wishes to challenge its validity has no means of doing so except by infringing the patent and permitting himself to be sued for infringement. If the trial of the issue in the District Court were finally to settle the question of the validity of the patent, the system that is now in use would not be so onerous; but, unless the parties to the suit compromise the issue after the case is decided by the District Court, the case is almost certain to be appealed to a United States Circuit of Appeals, if rights of great value are involved. If the decision of the Circuit Court of Appeals does not lead the litigants to come to an agreement, the defeated side will usually apply for a re-hearing of the case, and if that be denied will appeal to the United States Supreme Court, which fortunately rarely entertains such issues unless a new suit for an infringement has been brought in a different District Court, and appealed to a different Circuit Court of Appeals which has granted a different decision from the Circuit Court of Appeals that first passed upon the case.

There is no one court in which patent cases are heard and which finally passes upon and disposes of them. Infringement suits may be filed in any of the Federal District Courts in the United States, and a patent involving valuable rights is generally made the basis of suits in at least two District Courts and two Circuit Courts of Appeals if one or the other of the litigants is particularly litigious.

Because of the use of high-priced attorneys and expert witnesses on each side, the compilation of elaborate printed records and briefs, the adroit handling of the technicalities of the law, and the necessity of finding a date for the hearings upon the calendars of courts crowded with other matters, the decision as to whether an alleged invention is really patentable may be made to consume years of time and involve enormous expense. Such a system defeats the very purpose of the patent law, which is to foster the rapid development of industry. No adverse criticism of our courts is intended by this statement. The courts do the best they can with a situation of which they are in no sense the creators.

The Patent Office was instituted to determine whether or not alleged inventions are entitled to governmental protection, and to issue patents to those who are entitled to the same. It should be the duty of the Patent Office, and the Patent Office alone, to pass upon the patent-

ability of alleged inventions. The Patent Office is not now so constituted and empowered that it can properly perform this, its only proper, function. The changes in its organization that must be made to enable it to perform its true function fully must be enacted into law by Congress and will be so enacted by Congress only when that body is persuaded that the interests of the country demand it.

Among the changes that have been proposed by those who realize that our present system, instead of fostering the development of industry, places almost insurmountable obstacles in the way of the development of industry, the extreme proposal upon one side is that the search made by the Patent Office shall be so thorough and complete that a patent when granted shall in itself be *prima facie*, incontrovertible evidence of the right of the patentee to the monopoly alleged to be granted by the patent. This proposal naturally is popular with many inventors, with certain members of Congress, and with certain other individuals who have little real knowledge of the difficulties encountered in the just administration of a patent system. The alternative extreme view is that the Patent Office should combine the functions of a bureau of records, in which the inventor may record what he conceives to be the essence and extent of his invention and the date upon which his invention has been made, and an office that shall finally grant a patent only after the patent has been passed upon by the Courts, before which the patentee defending his patent and an interested party contending against the granting of the patent shall have fought out the issue. This proposal is based upon the assumption, which is undoubtedly true, that such an investigation as will determine whether or not an alleged new invention is really novel, the invention of the alleged inventor, and properly entitled to the protection of a patent, can be made only when a contest takes place in which the patentability of the invention is defended and attacked by contending parties having much at stake. The unchallengeability of this assumption should not be taken to mean that no patent is to be granted until the full gamut of the Federal Courts has been run, as is now necessary. It is natural that this solution of the problem has been brought forward by a patent attorney.

The first of these two propositions, that is, that the Patent Office should grant a patent which when once granted shall be unassailable, is untenable because it is absolutely impossible that any investigation depending upon a search in printed records alone, and more particularly in the records of the United States and other Patent Offices, can ever determine that an alleged new invention has not previously been made known and put to use. Anyone who has ever had occasion to make a technical investigation must realize that if the most expert assistance obtainable were used in such an investigation, the paltry sum of \$35, which constitutes the whole Government fee, would be absolutely inadequate to meet the cost of gathering the information desired. The United States Patent Office is reported to have accumulated a large fund from that part of the fee which

is charged for patents, and which has not been expended in carrying on the Office's work; if this be true, it only confirms the assumption that the investigations now made afford a hopelessly inadequate basis upon which to grant countless absolutely unregulated private monopolies.

So large a part of the arguments with regard to the necessity of the modification of the patent law have been made by inventors or patent attorneys that the rights of the public have at times been almost overlooked.

There are no more fundamental human rights than the right of the individual to use for his own benefit all of the knowledge that he may possess; and the right of the State to control and even curtail the rights of the individual in the interest of the rights of the whole public.

A patent is a monopoly granted to an individual for the exclusive right to the manufacture and use of an improvement for a fixed period of time. Concurrently, it is a denial of the right of the public to make free and unrestricted use of such improvement during the life of the patent. Our experience during the past few years has so clearly demonstrated the extent to which the public may suffer from unrestricted private monopolies that we have adopted, as a governmental policy, the curtailment of the development of monopolies and the careful governmental regulation of such monopolies, or near monopolies, as are permitted to exist. It is indeed remarkable, that in the face of the prohibition, or careful supervision, of monopolies as a well accepted governmental policy, our Government is itself, through the Patent Office, in a hit-or-miss fashion, annually creating thousands of absolutely unregulated monopolies of the most valuable kind—the improvements in the arts and sciences that are the very foundation of material progress. To deny or curtail the right of the public to the free use of an improvement in the arts is a very grave matter, and should never be done on inadequate evidence.

The law provides that a patent may be granted to the inventor covering the use, manufacture, or sale of an improvement of apparatus or process. Evidently this is done upon the assumption that the inventor has rendered a benefit to the State by perfecting his invention and making the invention known in its essential details to the public. By many inventors and patent attorneys it is claimed that the rights of the public are not abridged by a patent, as the invention is a thing that did not exist until it was invented by the patentee and in which the public could consequently have had no rights. The history of patent litigation shows that the Patent Office frequently grants to individuals monopolies of that which is already the property of the public; and experience has shown that while certain inventions are attained only after the most careful study and the exercise of great technical knowledge and ingenuity, probably the majority of the improvements made in the arts are the direct outcome of that which has been done before, the logical and necessary next step forward that would be taken by any one of a number of minds dealing with that art. Improvements of this kind should be distinguished from those requiring the exercise of real inven-

tive ingenuity. Industrial work becomes involved to an absurd degree, when every minor and obvious improvement can be made the subject-matter of a patent.

Fortunately, it is not the universal practice of those engaged in the applied arts to take out patents upon all of the improvements in machines and processes devised and used by them; consequently, the records of a Patent Office cannot be a complete record of all the improvements that have been made in the arts. Similarly, although our great body of technical literature is more and more being made a record of the details of machines and practices in use, there are, nevertheless, many improvements in machines and processes that have not been described in technical journals, even though they have come into regular use. It is therefore impossible that the Patent Office can ever be expected to make such a complete search as actually to determine that an alleged invention is so certainly novel that its inventor is entitled to a patent which when once granted can never be challenged. We know, through the fact that many of the patents granted by the Patent Office are held to be invalid by the courts, that the search now made is an absolutely inadequate basis upon which to abridge the right of the public to make free use of a useful apparatus or process.

It is obvious that the solution of our problem is not to be found in having the Patent Office grant irrevocable patents on the basis of its own unaided investigations.

In certain countries every application for a patent is published and anyone having rights which he considers would be unjustly curtailed has a right to file a protest against the issuance of the patent. In Germany, where this system is used, the exact subject-matter of a patent that is causing years of most costly litigation in this country was embodied in an application for a patent which was contested and after a very brief hearing was refused by the German Patent Office.

While the publication of applications for patents would protect the interests of the public to some extent, even this added precaution would not warrant the granting of irrevocable patents, as it would be very likely that no one would be sufficiently alert to object to the issuance of all of the patents that are not novel for reasons which do not appear in the materials referred to by the Patent Office.

As has been previously stated, it is possible, under our present system, that before the validity of a patent can be finally determined, litigation may have proceeded for many years. There have been cases where a patent was not finally held to be valid until within a few months of the time when it expired. This lengthy litigation is extremely costly. It is so costly that a poor inventor cannot possibly maintain his own rights in court without assistance, assistance which usually means the assignment of a great part of the profit possibly to be derived from his invention to those who will uphold his rights. The system as now administered does not fully promote the rapid development and adoption of improvements. Many a man is diverted from the exercise of his inventive talent by the fact that he knows that, if he expends

the time and money necessary to perfect valuable inventions, he will, if poor, be absolutely at the mercy of those who possess more means and thereby dare infringe his rights, and of those who possess more means to defend his rights and can therefore deprive him of the ownership of his invention for the money necessary to defend it. Even where the inventor has the temerity to perfect his invention and go to the expense of patenting it, our present system makes it difficult for him to get his invention adopted, as the uncertainties as to the status of a new patent and the cost of defending the same will prevent many who could profit from the use of an invention from adopting it. The second alternative position originally stated, that is, that patents be granted only after they have been litigated, cannot be upheld if the decision with regard to the granting of the patent is to be based upon fighting out the issue before our Federal courts, as is now done.

What we need most is to get away from the cost and lengthy delays involved in fighting through all the Federal courts of the land to decide whether or not an alleged inventor is entitled to a patent for an alleged invention. There is no reason why the Patent Office cannot be so amplified and empowered that it will finally, expeditiously, and economically dispose of all questions as to the patentability of inventions. It is the logical function of the Patent Office to do this one thing.

Usually it takes but a few hours at the most to explain thoroughly and convincingly, to a man of technical and legal training, the issues of a case that will take several years and the expenditure of a fortune to determine in the law-courts. This is highly uneconomic and absolutely opposed to the best interests of the State, the interest of which can only be fostered by doing all that is possible to promote the perfection of industrial improvements and their rapid adoption. An office that would quickly and finally determine the validity of patents and grant patents that when once issued would be unassailable evidence in determining rights in the Civil courts would protect all who have legitimate interests and thereby foster the most rapid material development of the State. At the present time patents are annually granted by thousands and it is absolutely impossible for anyone to determine whether or not a patent is valid or exactly what it can be held to cover, until a lengthy course of litigation has been gone through. This is nothing but governmentally created confusion, and a businesslike people, used to handling its affairs with sanity and dispatch should not endure the continuance of such a system but should bring about the adoption of a system by which matters of such importance can be settled with ordinary business dispatch.

A careful study of the situation created by our present system, which may have fitted a day when inventions were few and simple, but is entirely unsuited to the present complex of industry, has made it apparent that a few simple modifications would remove most of the unnecessary evils.

As a search is necessary both in the interests of the inventor and the public, a search should be made, but it

should be much more exhaustive and more prompt than is now the practice. To facilitate this work the Patent Office should have more adequate quarters, better library facilities, and a larger staff. If it is necessary to charge a higher fee to enable the Office to do its work better, it should be done. Such salaries should be paid to the examiners and assistant examiners as to retain more trained men in the service. The force of each division of the Office should be kept at such a point that not more than a month at the most should elapse between the time an application is filed and the first report upon it is mailed to the inventor. These things are necessary in the interest of the inventor, so that he may learn as promptly as possible whether or not it is probably worth his while to continue his work in perfecting and patenting his invention. The patent, issued after the best possible office search has been made, should be tacitly considered to be tentative, which is all that a patent as now granted is in reality. It should have a status differing from that now given to a patent, in that no injunction should be based upon a patent and no damages should possibly accrue from the infringement of a patent until its validity has been finally established.

It should be the policy of the Patent Office not to grant patents upon such differences in process and apparatus as would naturally be made by a skillful operator. Our present confusion results in part from the fact that patents are freely issued on obvious and minor deviations from practice, and later, after costly litigation, are properly held by the Courts to cover only such modifications as one skilled in the art would be expected to make, and are hence not patentable. The examiners need to be thoroughly impressed with the fact that while the inventor should be allowed all that he is justly entitled to, it is their duty also to see that the rights of the public are not unjustly abridged or jeopardized.

As it is inherent in the nature of the case that a final determination as to the patentability of an invention can only be reached when there is an incentive to those whose rights will be abridged by the patent to fully represent their rights and for the applicant for the patent to do the same, and as it is the proper function of the Patent Office to investigate the patentability of alleged inventions and grant patents when they are deserved, a Patent Court should be an integral part of the Patent Office and all questions as to the patentability of improvements should be cheaply, promptly, and finally determined by this court.

The judges of this Patent Court should be so adequately paid that their continuance in the Government service would be assured. They should be men familiar with the patent law and of such technical training and experience as to be able to comprehend the technical issues coming before them. The rules governing the conduct of cases before the Patent Court should be extremely simple. The rules governing the California Railroad Commission, which is able to turn out an amount of work never approached by the law-courts, because it does not permit of elaborate and involved procedure, could well be made a model for the rules governing the conduct of

cases in the Patent Court. The procedure should be so simple that it would be possible for any inventor desiring to do so to personally represent his own case. If any expert testimony should be found necessary for the clarification of issues being tried before the Court, the Court should appoint its own expert to investigate and report. The system of expert-witnesses now in vogue is absolutely indefensible.

Such a court as that which has been herein proposed should be able to dispose of practically every case in one hearing. It would be constituted of men to whom neither the patent law nor the nature of the technical questions involved in a patent suit would have to be interpreted, and who would, because of their expert knowledge and experience, determine promptly where justice lay.

The decision of this Court as to matters of fact should be final and no appeal from its decision should be possible save as to interpretations of the patent law, and the Appellate Court to which such matters might possibly be submitted should also be an integral part of the Patent Office and should be the court of last resort for all questions concerning the patentability of inventions.

It should be possible to bring the question of the validity of a patent before this Court, either by a suit for infringement or by a petition to have the patent declared invalid for reasons properly set forth. In either case anyone desiring to be heard should be permitted to submit evidence, as it is not always to the interest of contending inventors to present all of the evidence which is obtainable.

The majority of patents are of so little consequence that they would probably never come before this Court. Its membership should, however, be sufficiently large, made up of men of sufficiently diverse technical and legal training and so divided into divisions sitting independently in Washington or elsewhere that all questions would be disposed of by it promptly; and it should be specifically provided, that whenever the Patent Court had so much work to do that cases could not receive prompt attention, more judges should be appointed, as it is absolutely necessary to the interests of industry that matters of this kind be decided promptly.

It is entirely prejudicial to the interests of the State to have the adoption of an invention delayed unnecessarily; and no greater financial loss can be inflicted upon an inventor than to deprive him of the enjoyment of the profit of his invention during a considerable part of the period for which his patent is granted.

Those who profit by our present system have usually been well represented before the congressional committees investigating the necessity of the modifications of the patent law. If the rights of the public are to be protected it is necessary that the attention of the individual members of Congress be drawn to the radical changes in patent law which are needed and that committees representing the great technical societies should go before the patent committees of both houses of Congress to urge the adoption of the changes necessary if the interests of the public are to be safeguarded.

Washoe Reduction Works, Anaconda—III

By L. S. Austin

THE SLIME-FLOTATION PLANT

The overflow from the two 7-ft. Anaconda classifiers in one unit of the concentrator amounts to 400 tons daily, containing 2.5% copper from a 3% ore. This product is now sent to the thickener plant, thence to the round-table plant, where 53% of its contained copper is recovered, the tailing of that plant being run to waste with 1.1% copper still retained. It is for the purpose of making a closer recovery, so that but 0.25% copper shall be left in the slime-tailing that an additional flotation plant is being erected. This is situated midway between the thickener plant and the round-table plant

Callow machines in this building. The products of the M. S. machines are three, a spigot-discharge from the last compartment, which will go to waste, a concentrate from the first six compartments, a middling product from the remaining eight. Launderers carry the concentrate to an elevator, the middling to another elevator at the centre bay of the building. The launderers are so laid out that in case of break-down of either of these elevators it will only be necessary to re-set the controlling launder-gates in order to use the third or spare elevator to take its place. Steam is used for heating the entering pulp and for warming the building. The middling, of

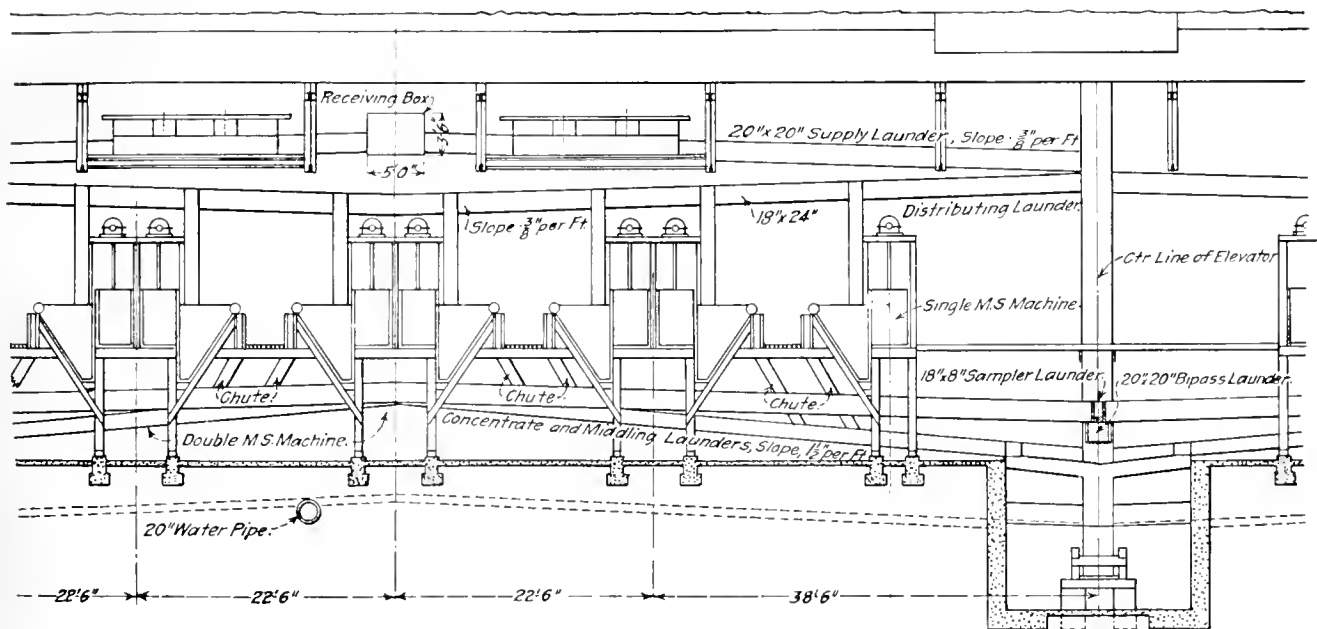

FIG. 8. LONGITUDINAL SECTION OF PART OF THE SLIME-FLOTATION PLANT.

(see the general map, Fig. 1). It contains the mechanical agitators of the Minerals Separation Co. The frothed concentrates, discharged from these, will flow to the boot of the bucket-elevator in the central elevator-tower, and will thence be laundered by gravity to any one of the five 50-ft. thickener-tanks and thence by elevators to the Oliver filters to yield a moist slime-concentrate.

Referring to Fig. 8, the building, 147½ by 68 ft., is occupied by the Minerals Separation separators except the middle space where the elevators are, there being ten machines in each half of the building. The slimed pulp enters by launder to an overhead receiving-box, thence by a supply-launder to the various distributing launders and so to the heads of each machine. Note the slight grade of ¾ in. per foot—enough for such fine material. As in the sand-flotation plant, the pulp goes through the 14 compartments of the agitator in series. There are no

course, is returned to the head compartments of the agitators, while the concentrate passes by launder to the thickener-building, as already mentioned.

THE ZINC PLANT

A new undertaking of the company will be the treatment of zinc ores and the recovery of the zinc in pure form by electrolysis. Zinc ores of 20% or over are to be roasted if necessary to the production of sulphate, or if oxidized, then leached directly by the use of sulphuric acid, and the zinc precipitated upon stripping sheets. A few cathodes of hard lead are used for making these sheets. The anodes are of hard lead. A current of 40 amp. per sq. ft. is to be carried and the plant is to have an output of 10 tons of metal daily.

This 10-ton plant has been pushed to completion on account of the sudden rise in the price of zinc. Normally more time should have been spent in working out

the process in the one-ton plant that had been erected. It was felt, however, that the pressing forward of larger size operations was justified. The installation includes not only the building called the zinc plant, but the zinc plant power-house, the latter adjacent to the leaching plant.

Nor has this been all: To supply electric energy the company has had available large motors and generators, not used at the electrolytic refinery at the old works. It had the use of the crushing equipment of the converter plant, now idle because acid-converter lining-material is superseded by the basic lining. A 10-ft. Hardinge mill, also on hand, has been utilized. It has been possible to employ two of the McDougall roasters of the leaching plant close-by with all conveniences for cheaply moving and storing ore. Electrolytic tanks were obtained from Great Falls, where they are being made by the hundred for the new electrolytic refinery now being constructed there. The company has sheet-lead already purchased at lower prices, also its own expert lead-burner. It has an Oliver filter and Garred thickener filter, also motors, shafting, etc.

The tanks for the new zinc plant, purchased from a California firm and made of redwood, after erection needed no preliminary swelling by being filled with water, and did not leak.

In outline the process may be briefly given as follows:

Ore containing 14 to 20% zinc is crushed to 40-mesh; roasted in two McDougall roasters of the leaching plant; tank-agitated with a 6% solution of sulphuric acid, further agitated in the Mineral Separator Co.'s agitator of 14 compartments with additions of crushed limestone to neutralize the acid solution, and in a later compartment, with a little zinc-dust to get rid of copper, thickened at a Garred filter, the thickened pulp filtered by an Oliver filter, and the tailing run to waste. The solution, pumped from the Oliver filter, joins that from the Garred machine, the two being introduced into another Mineral Separator Co.'s agitator, and there further agitated with the addition of some zinc-dust for the precipitation of 0.1% of copper still remaining, and of cadmium. This turbid solution is successively settled in boxes and in a large tank, then goes to large storage tanks with filter-bottoms, from which a clear solution can be withdrawn to the electrolytic tanks.

There are six rows or cascades of tanks, each cascade consisting of seven tanks set on a descending grade, so that the solution can flow from tank to tank. In each are 22 cathodes and 26 anodes, giving 924 cathodes in all. At the end of each cascade is a Pohle air-lift of lead, by which the flow is lifted to the head of the next cascade adjoining. The flow is thus through the whole six cascades of the system. The entering stream is to carry 5% zinc and no free sulphuric acid, and to leave the tanks still retaining 3% zinc and 6% acid. This removal of not half the zinc is all that is considered prudent, since the acid is there developing ready to redissolve the zinc from the cathodes. The current is de-

livered at a density of 30 amp. per sq. ft. The drop between anode and cathode, with about a 2-inch interval, is 1.28 volts, or a total pressure of 90 volts with 8000 amp. representing 720 kw. With sheets 2 by 3 ft. this represents 360 amp. per sheet. The anodes are of pure chemical lead. The starting sheets, made in several of the cells, are deposited on aluminum cathodes and are built up about $\frac{1}{2}$ in. thick, weighing 10 lb. each.

The electrical equipment, installed in a separate power-house, consists of three motors and six generators. Each motor drives two generators by a rope drive. Each generator is built for 270 kw., or for the six, 1620 kilowatts.

THE 2000-TON LEACHING PLANT

Two years ago Frederick Laist presented a paper at the Butte meeting of the American Institute of Mining Engineers (Vol. XLVI, pp. 362 to 382) on the subject of leaching tailing at the Washoe works, with a description of the experimental plant for the chloridizing roasting, and leaching of the tailing. At the Salt Lake meeting of the Institute in 1914, he together with H. W. Aldrich had a paper entitled 'Experimental Leaching at Anaconda' describing an 80-ton experimental plant, the fore-runner of the 2000-ton plant now fully in operation at the Washoe works, the subject of this article.

The process in brief is to subject tailing that has accumulated for years, and that contains 0.50 to 0.65% copper, to a brief roasting at a temperature calculated to convert the copper sulphides into sulphate and oxides. The resultant roasted product is leached with additions of dilute sulphuric acid, the copper-bearing acid filtrate being sent to tanks, there to be precipitated on scrap-iron. The final precipitate of 55 to 70% copper is transferred for treatment to the anode furnace of the converter department.

Referring to the group of buildings at the south-east side of the grounds, there will be seen a small building (Fig. 2) marked 'unloading-bin,' having a railroad track threaded through it, and long enough to contain three 50-ton dump-bottom cars. The tailing, containing 4 to 6% moisture, is loaded into a train of three cars from a sand-tailing dump situated below the works and accumulating there for years. The train having been set within the building, its load is discharged through a grated floor, the bars of the grate having 2-in. openings. Frequently stones of fist-size, and larger are thus sorted out of the sand. The tailing falls into a hopper-bottom bin of 300 tons capacity, shown in cross-section in Fig. 9, and is drawn off by 22 spouts at 4-ft. intervals upon short endless-belt feeders. These feeders are set in motion as soon as the cars are discharged, and the bin is emptied, the tailing being taken away promptly by a 36-in. conveying-belt. This 36-in. belt discharges upon another inclined one that raises it to command a double hopper-bottom bin of 6000-ton capacity in the 'storage-building,' Fig. 1, or as in Fig. 10, wrongly marked 'de-watering bins.' A movable tripper discharges it into any part of the 6000-ton bin as desired. Beneath this at 12-ft. intervals are spouts at the points of

the hoppers. From them a system of 18 feed-belts on each side (36 in all) delivers to a 24-in. horizontal conveying-belt extending the length of the building. The sand-tailing is withdrawn through any of the spouts as desired for supplying the leaching-plant.

As may be traced on the sectional elevation of the plant, Fig. 10, the course of the tailing is beneath tracks horizontally to the 'motor-house,' then by incline-conveyor to the top floor of the roaster-building. A parallel incline-conveyor takes coal and salt from the 'coal and salt building' also to this top floor. The tailing is moved the length of the roaster-building by two conveying-belts and by tripper is shot into any desired roaster-hopper to the right or left. The coal being in much smaller quantity is more simply transferred by car and put into the hoppers.

In the roasting department are 28 roasters of the McDougall type, in four rows; they are 20 ft. in diameter, having air-cooled shafts and arms. Each furnace has six hearths with fire-boxes on opposite sides of the third hearth. Coal from the hoppers is drawn off on the sheet-steel floor at this level, so that the boxes are hand-fired. The hearths are maintained at a low red heat (665°C). The salt is not added to the furnace-charge but into the leaching-tank. The ore is fed to each furnace by an endless belt-feeder. On the first or upper hearth it is dried. On the second hearth no visible heat appears except the flame at the time of firing. On the third hearth there is a red heat, brighter at the time of firing, with some sparks. On the fourth hearth the charge is dull red, with an occasional spark at the passage of the rakes. On the fifth hearth visible heat had nearly disappeared; and on the sixth, where some air is admitted at the doors, an occasional spark may be seen, falling through the drop-holes.

Fig. 10 shows the position of the two lines of belt-conveyors for the calcine, one line to each two rows of furnaces. Before delivery to the conveyors the ore is first cooled, then moistened with water. To accomplish this, as the figure shows, a revolving inclined cylinder-conveyor 18 ft. long, parallel with the belt-conveyor, delivers the ore to another cylinder at right angles, the ore falling thence upon the conveying belt. The first cylinder is lined with $\frac{3}{4}$ -in. cooling-pipes having circulating water, the ore arriving at the discharge-end properly cooled. Axially into the second feed-cylinder is spurted a jet of water that dampens the ore to about 1% of the moisture, thus preventing any loss of dust in conveying.¹

To remove the furnace-gases each line of furnaces is provided with steel flues (as shown by circles in the roaster plant, Fig. 10), which lead the header at the south end of the roaster-building, thence into a steel stack 15 ft. diam. by 200 ft. high. The off-take at each furnace rises vertically into the steel flue.

In the leaching-building (see general plan, Fig. 1) are ten large leaching-tanks, 50 ft. diam. by 14 ft. deep,

in two rows, and of 1100 tons capacity each. These tanks have a grated slat-bottom covered with cocoa-matting, the matting being held down and protected by wooden gratings having openings 4 in. square. There is a good reason for this, as the fibre of the cocoa-matting becomes weakened by the acid, and impact of the sluicing stream would tear it, were it not protected by the grating. This was inserted as the result of experience in the 80-ton plant. The tanks serve for ore-storage so that one of them is always in course of being filled while leaching and emptying proceeds in the others.

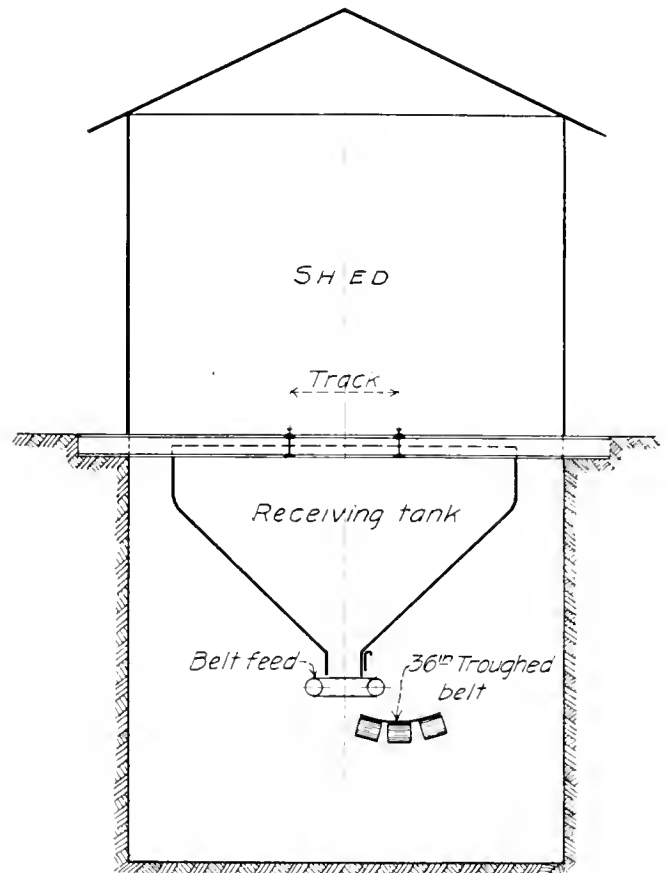

FIG. 9. UNLOADING BIN.

The calcine from the roaster-building is brought by either one of the two inclined conveyors, one delivering to a long horizontal belt-conveyor over the first row of tanks, the other to the conveyor over the second row. Each of these tank-conveyors has its own movable tripper; thus the whole flow from the roaster-plant can be delivered to any desired tank.

We come now to the method of distributing ore into a tank. There are two traveling bridges, one over each row of tanks, and each bridge set, when filling, over the centre of the tank, carries a distributor of 100 tons hourly capacity. The distributor is a framed truss hung at its centre from the bridge and revolving about a vertical axis so that its arms reach the periphery of the tank. The ore, falling from the tripper, is received on an endless-chain scraper-conveyor, which moves outward toward the circumference. In so doing it drops

¹This double arrangement seems to the writer more complicated than needful for the purpose to be attained, but he is bound to say that it is the result of careful experimenting.

the ore through openings regulated by slides, each opening being so adjusted as to give the proportion needed for filling the tanks evenly. When leaching has been completed, the contents of the tank are hoisted out through five bottom discharge valves in about 8 hours, using two hose lines with nozzles of 1½ inch diameter.

Adjoining, and at a level 17 ft. below the floor of the leaching building, so that the tanks can drain to them, is the shed containing the five solution tanks, 50 ft. diam. by 14 ft. deep, of 800 to 900 tons capacity each. From these tanks, by means of centrifugal pumps, the solutions are sent to any desired tank. Counting from the north end of the building, the tanks have stored in them the following enumerated solutions:

In No. 1 tank, No. 1 solution containing 5% H_2SO_4 and 8% $NaCl$.

In No. 2 tank, No. 2 solution containing 1% H_2SO_4 and 8% $NaCl$.

In No. 3 tank, copper solution containing 1½% H_2SO_4 , 2% Cu , and 8% $NaCl$.

In No. 4 tank, storage for the wash-water from the leaching tanks. This wash-water would, of course, contain a little acid, salt, and copper.

In No. 5 tank, also a storage for the wash-water, as in No. 4.

The following is the order of treatment when leaching a charge: First there is run on top of the filled tank 250 tons of No. 1 solution. This sinks through the ore and drains to the copper-solution tank and thence in a regulated flow to the scrap-iron launders or vats. The outflow from the launders goes back to No. 2 solution-tank, deprived of its copper, but containing basic salts of iron and alumina. It is consequently necessary to waste some of this solution in order to keep down the contents in basic salts, which tend to precipitate where built up to over 1½% in the solution.

Second. Salt is added to the extent of 15 tons per tank from a salt-bin at the foot of an inclined belt-conveyor next to and parallel with the calcine-conveyor. This is layered on the surface of the charge by the distributor. This is to dissolve the silver.

Third. No. 2 solution goes on, following down after No. 1's solution. It is strengthened to 20% H_2SO_4 , as has been already specified, by addition of 52% acid at the tank, and amounts in all to 150 tons.

Fourth. 100 tons of No. 2 solution of 1 to 1½% H_2SO_4 is added. Both the strengthened and the weaker No. 2 solutions drain to No. 1 tank, where it arrives containing

The adjustments of this charging machinery have not been altogether attained, but no doubt can be. One is disposed to compare it with the Blaisdell sand-distributing and excavating apparatus.

As No. 2 solution flows upon the leaching-tank, sulphuric acid of 52 B. is added to it from the 190-ton acid-tank in the building adjacent to the steel stack at the south end of the roaster-building. By this means the outflowing solution is brought up to 20% H_2SO_4 . Since the acid of this solution is largely exhausted before it has sunk through the ore, there are no solutions high in acid going to any of the solution-tanks.

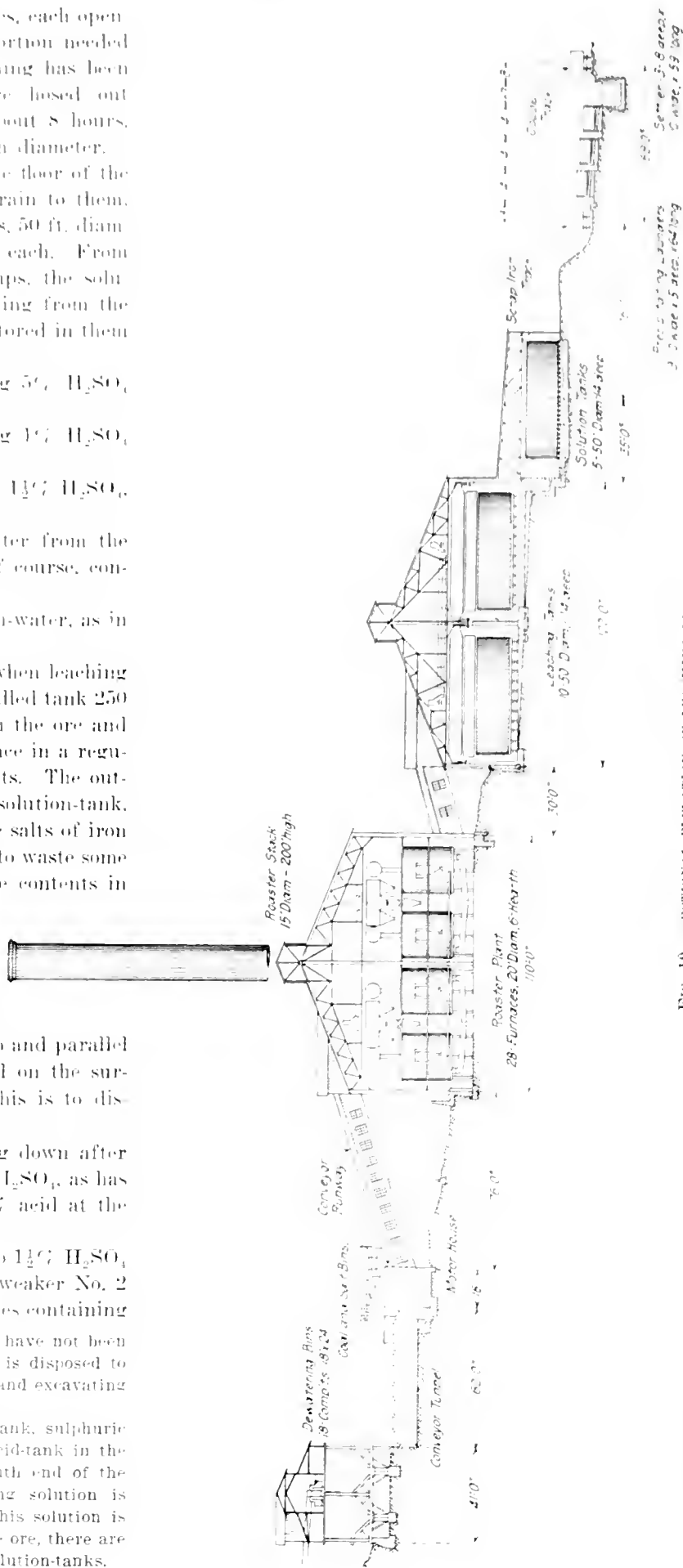

FIG. 10. SECTIONAL ELEVATION OF LEACHING PLANT.

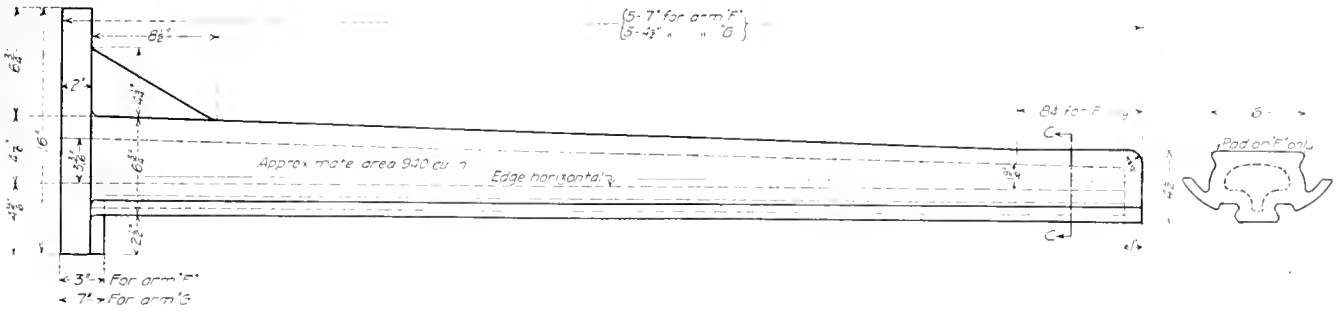

FIG. 11A.

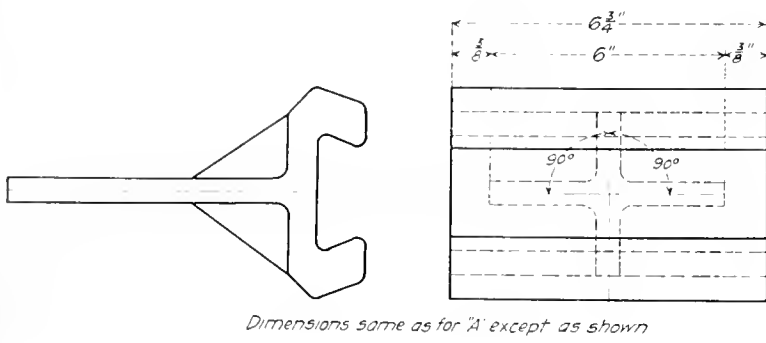

FIG. 11E.

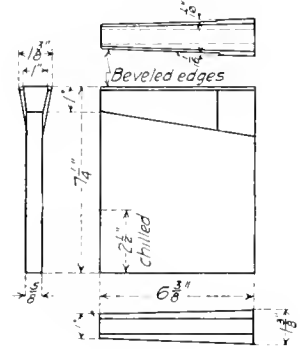
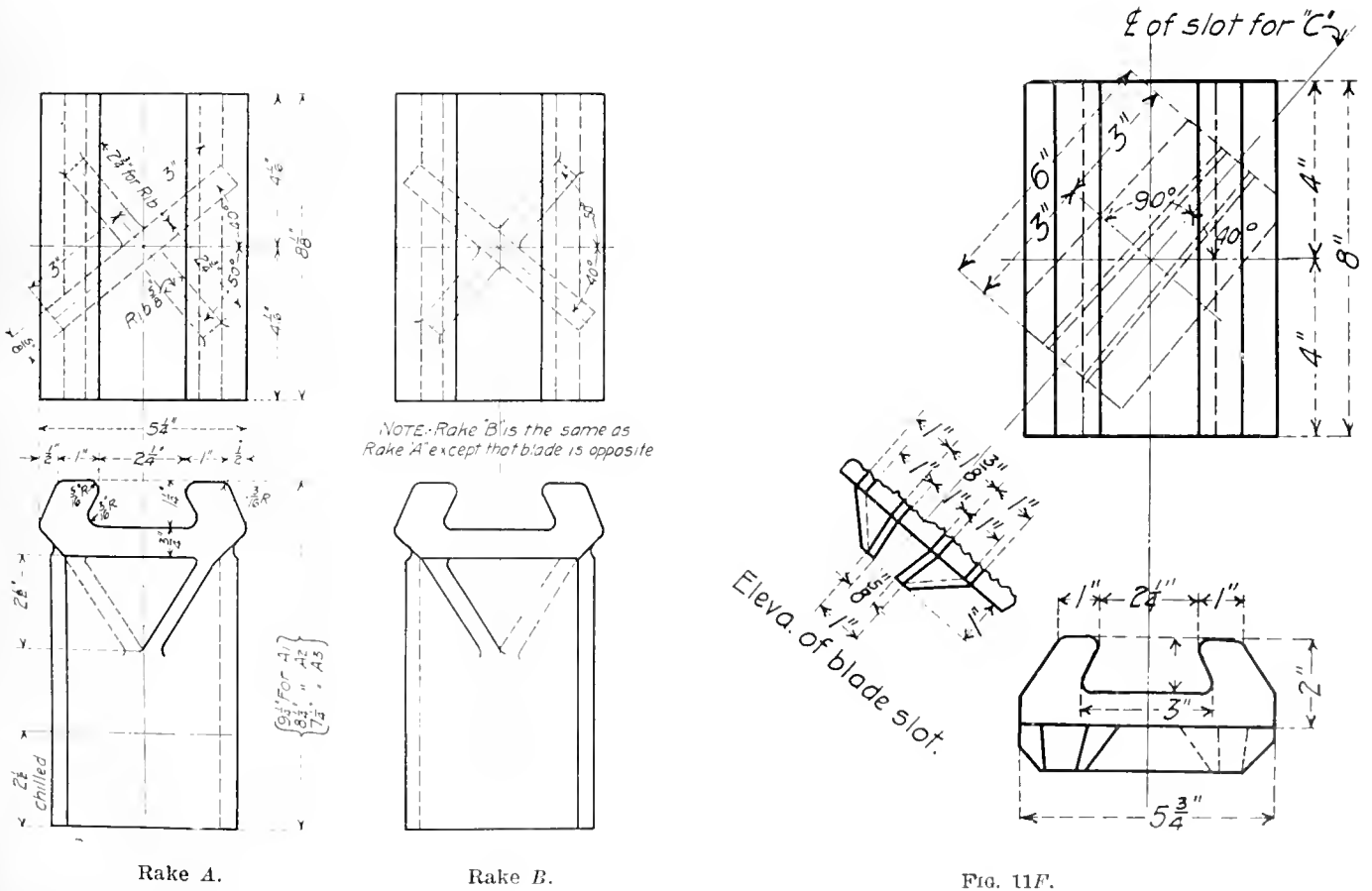

FIG. 11G.



Rake A.

Rake B.

FIG. 11D.

FIG. 11F.

5% H_2SO_4 and enough salt, picked up from the salt layer, to raise the solution content to 8% $NaCl$. It is used as No. 1 solution on the next tank to be leached.

Fifth. Clear fresh water from the water supply line is run on. This drains to the wash water tanks, No. 4 or 5. This wash water, containing some acid, salt, and copper, is added to No. 1 solution, as needed, to supply the necessary wastage of that thrown away to get rid of basic salts and that carried off in the tailing.

The cycle of operations takes 120 hours, of which 8 hours is devoted to emptying the tank, 11 hours to filling, 101 hours to leaching.

There are three scrap-iron launders or vats having false perforated bottoms, each divided into three compartments by partitions. These are filled with scrap, much of it large, from the accumulating supply of the Washoe works. It is valued at \$6 per ton. Choicer scrap, used at the copper precipitation plants at Butte can be bought for \$8.50 per ton. The precipitate is washed off by a hose-jet from the scrap-iron surfaces, and, going to the bottom of the tank, is flushed into the settling-tank parallel with and adjoining the precipitating-launders. After draining, it is excavated by a clam-shell grab and loaded upon cars for final treatment.

For further particulars and a full description, see E. P. Mathewson's article in the *Engineering and Mining Journal* of April 24, 1915, to which the present article is to be regarded as supplementary.

THE 100-TON ACID PLANT

This is intended to supply, not only the 2000-ton leaching plant at the Washoe works, but for meeting commercial demands; and it indicates that a serious attempt has been made to utilize the sulphur fume, now so abundantly escaping from the main stack of the smelter.

The plant manufactures its acid according to the standard lead-chamber process. In principle, the sulphur dioxide, arising from the roasting of pyrite, is immediately conducted, together with the excess air of roasting, and some nitric oxide, into a series of large leaden chambers in which it is continuously brought in contact with steam (or water-spray) and this nitric fume. The latter acts as a catalizer or go-between in transferring the oxygen of the air to the sulphur dioxide.⁴

To produce 100 tons of acid daily, some 85 tons of fine concentrate, containing 36% sulphur, is required. This is first dried in a Ruggles-Coles drier placed at the east end of the main roaster-building. The dried ore is withdrawn from the storage-hopper at the drier into a 50-ton hopper-bottom car, so designed that it may be closed by hinged lids or covers to prevent the possible escape of dust in the transfer to the acid plant, fully a mile away.

The roasting is performed in two Wedge furnaces

22½ ft. diam., having seven hearths. It was attempted at first to operate the furnaces with air-cooled arms and rables, but, owing to the high temperature developed in the roasting, this had to be given up, and water-cooling substituted. The roasted ore, still retaining 7.5% sulphur, is returned by car for reverberatory furnace treatment at the main works.

The roaster gases, containing some air and about 8% sulphur dioxide, pass through a dust catcher which is 32 ft. diam. by 11 ft. high, and settles out much of the dust.

In the so-called nitre plant or chamber are six boxes 2 by 2 by 4 ft. long, called 'nitre pots.' Here the sodium nitrate, decomposed by addition of sulphuric acid, gives off nitric acid fume, and leaves a residue of melted sodium sulphate, the latter being tapped from the boxes from time to time into overflow-pans just outside the nitre-chamber.

In plan, the Glover chamber is shown in Fig. 11 as containing clay pipes set vertically. As a matter of fact the space is filled with acid-proof tiles 12 by 18 by 1.5 in. thick. These are set on edge to form a checker-work for the downward passage of the gases. Distributed over this checker-work, trickle two mingled streams of acid, the chamber acid of 52 B, and the nitrous sulphuric acid from the Gay Lussac towers of 60 B. It is the nitrous fume from the latter acid that is taken up by the SO_2 gas, so that there is a recuperation of this expensive chemical.

The outflowing acid from the Glover tower enters a vat, marked 'acid tank,' cooled by water-cooled lead pipe-coils, the temperature by this means being reduced from 82 to 5°C.

From the Glover tower the gases are sucked through five cooling chambers, then driven by a fan in series through 18 cooling-chambers and 6 main chambers, all made of 6-lb. sheet-lead $\frac{1}{16}$ in. thick. One would naturally ask, why are there so many expensive cylindrical chambers provided between the main ones? It is for the more thorough mixing of the reacting gases as they pass alternately up and down. The gases enter the first main chamber at 95°C. (the boiling point of water at Anaconda) and escape at the end of the last one at 35 to 40°C. in summer, and at 15 to 20°C. in winter. The acid is a little weaker at the last chamber and circulates in a contrary direction from the gases. It issues at a concentration of 52° Baumé.

Lead-burning consists in fusing together lead sheets, using a blow-pipe flame of hydrogen gas and compressed air, with lead wire for solder upon the freshly-scraped surface of the joint. Easy as the work seems to be, it requires much skill. The easiest joints are those made with the sheets laid flat. With care, vertical joints can be made readily, but overhead ones are the most difficult. Each side of the main lead-chamber, 96 ft. long, was made of four sheets each 24 ft. wide by 36 ft. high. A sheet of this size was assembled on a platform from narrower sheets and burned together into one. The platform was hoisted to stand on edge and the top of the

⁴The gases, issuing from the main stack of the works, present similar conditions for making sulphuric acid, except that the sulphur dioxide is soon diluted and there is no catalizer present. Otherwise, especially in wet weather, we might expect it to rain a dilute solution of H_2SO_4 upon the place beneath.

sheet was turned over and nailed to the beam forming the top corner of the chamber. All the side-sheets being in place the final vertical joints were made. The flat top was then added. The framing of the sides and top are suspended from the roof-trusses, and the lower edges of the sides dip beneath the acid into a tray or shallow tank 2 ft. deep. This makes an air-tight seal, although the sides hang loose in the tray. Wooden posts bear against the sides to prevent bulging and the sides are secured to the posts by lead strips burned to the sheets. The end posts of the extreme main chambers have had to be reinforced by I-beams. In setting these, while the plant was in operation, one slipped from its sling, and its end tore a hole in a side sheet, causing the escape of a cloud of gas and driving away the working gang. Under the direction of the superintendent, however, the fan was stopped, the I-beam removed and the break covered by a sticking-plaster of building-paper painted with hot tar. Upon this was clapped a square of sheet-lead that was immediately burned into place.

From the last cooling-chamber the gases pass to the 21

Gay Lussac scrubbing-towers, where they meet the acid trickling downward through the hard-burned coke with which the towers are filled. The acid takes up the remaining fume of nitrous oxide to form nitrous vitriol. The gases escaping contain 96% of nitrogen and 4% of oxygen, the SO₂ having been absorbed. The towers are made of acid-proof tile laid in acid-proof cement. Some leakage occurs through the joints, so that the corroding acid reaches the adjoining framing. To avoid this it will be necessary to go back to the usual construction, using a sheet-lead shell. The coke-filling also accumulates lead sulphate and gradually crumbles. It will be replaced eventually by tile, as in the Glover tower.

The chambers stand 16 ft. above the ground-level, and this leaves room below for the six acid-tanks, and the so-called 'acid eggs,' a name derived from the earlier shape of these receptacles. There are eight of these marked 'blow cases,' each 4 ft. diam. by 21 ft. long. Into them is run acid from the acid-tanks. By compressed air the acid is raised to the top of the Glover or the Gay Lussac towers, or put into the tank-ears, by which it is sent away

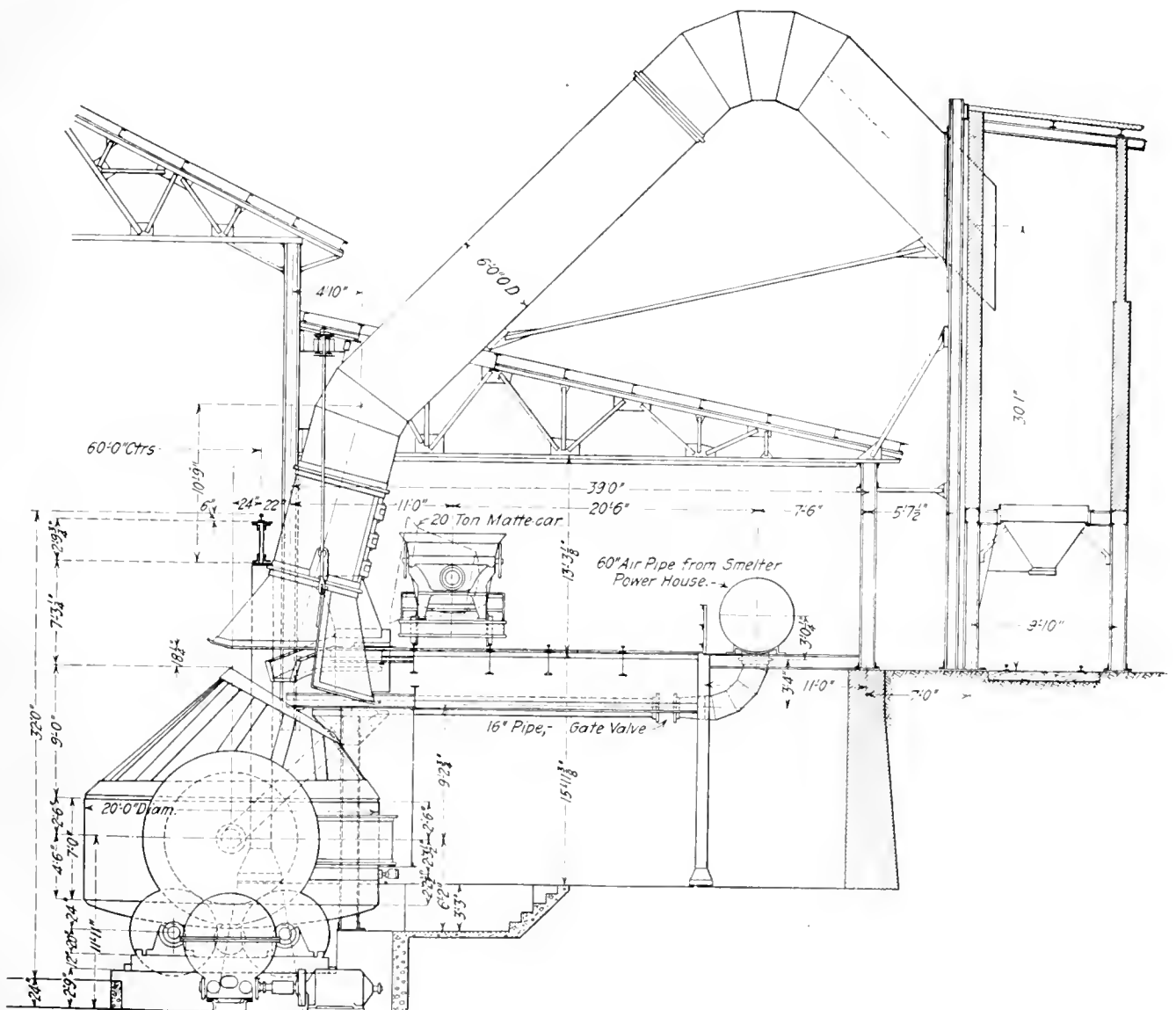

FIG. 12. ELEVATION OF 20-FT. CONVERTER.

into commerce. There are no pumps or moving parts subject to acid action.

DETAILS OF THE McDOUGALL ROASTER

The peripheral drop-holes of the even-numbered hearths have been doubled in length and recessed two inches into the exterior wall, thus increasing the diameter of the hearth by 6 in. and the effective roasting area by 6%.

The rabble arm and its appendages have been thus improved. Fig. 11A is a side elevation and end view of the Kelly arm, the end view showing the upturned edges of the arm upon which the flue-dust accumulates, thus protecting the arm against the heat. One arm of each hearth has a pad marked 'pad on F only,' over which is slipped a top rake, Fig. 11E. This rake in its travel breaks off any accumulation of flue-dust, which coming up through the drop-hole, tends to attach itself to the roof of the hearth. In Fig. 11D are seen the two solid cast-iron right and left-hand skewed rakes, marked A and B, by which the ore is moved to the periphery or to the centre of the hearths, as may be desired. In the case of a peripheral discharge, one outer blade is chosen, which is set to plow the ore inward from the walls into the drop-holes. In Fig. 11E is shown a rake with its blade without bevel. This is put in at any desired time and place for the purpose of scraping off any ore that has stuck to and accumulated on the hearth. Fig. 11F represents another kind of rake. It consists of a holder marked D, which, like the rakes A and B of Fig. 11D, is dove-tailed to slip over the arm, but carries on its lower part a tapered beveled slot, and in this slot fits a blade, Fig. 11G. If this blade becomes worn or broken, it can be easily removed from its holder and another blade substituted. The ordinary solid rake is much more difficult to replace.

THE 20-FT. CONVERTER

Fig. 12 gives the elevation of the 20-ft. Great Falls converter as installed in the converter building.

This converter is driven by a 100-hp. mill-motor, and can be completely revolved on its riding-rings. Outside one ring is set the spur driving-gear that meshes into the driving-pinion below.

Adjoining the elevated track, which carries the 20-ton matte-car, are two pouring-spouts, having movable launders, so that the flow of the matte may be properly directed into the mouth of the converter.

Air at 15-lb. pressure is admitted by a 5-ft. pipe from the smelter power-house. The air enters the converter through 31 independent tuyeres each of $1\frac{3}{4}$ in. diameter.

The hood leads off by a 6-ft. goose-neck to the large dust-chamber adjoining the converter-building.

There are three traveling cranes in the converter-house.

In operation these converters work more quietly than the smaller ones, there being but little material slopped out. The molten bath is most agitated at the back, that is above the tuyeres. The molten contents cascade toward the front, and sometimes send up jets that shoot

above the mouth of the converter. The bath changes progressively from green-yellow to full yellow and the reverse. A reddish-yellow cast is also observable. On the bath, toward the front, appear darker-colored spots apparently due to the beginning of formation of crusts.

Fig. 13 shows two converters in operation; the one in front blowing, and the other pouring. Fig. 14 illustrates the operation of the slag-casting machine, which is seen in the act of receiving slag from a ladle moved by a traveling crane. On the front cover of this issue the reader will see the Great Falls type of converter under construction in the smelter-yard.

The *Cornish Post & Mining News*, published at Camborne and Redruth, Cornwall, contains in a recent issue, beside a column of Michigan and Butte personals, a note on 'The Other Kind of Mining.' It states that: "the mining reports made by certain engineers after the War to Directors will be weird reading. Instead of dealing with the metallurgical content of the rocks there will be reference to a tunnel driven close to the enemy's trenches, strict secrecy being observed and no casualties from counter-mining. Instead of advising that payable ore has been struck, the engineer may advise that taking the angle of least resistance into account and the size of the charge, a satisfactory crater can be formed by the explosion and a general advance of troops rendered practicable. It must be a novel and extraordinary experience to carry on underground warfare. In Cornwall our miners have been known to proceed warily towards the abode of a subterranean enemy, but the enemy has been a passive resister, a huge body of water silently awaiting the blow of the pick that will release its pent up volume. By cautious prodding, the lake has been tapped and drained gently away. In other cases the water has been holed into unexpectedly as at Wheal Owles, where a score of miners lost their lives. But the mining engineer who is engaged in destructive mining at the front, commands a large body of human moles who dig as silently as possible through the earth until their gallery or galleries are underneath the trenches of the enemy. All the time they know that a similar body of miners is working toward their own trenches and machine-gun emplacements. It requires the highest kind of sustained courage to remain at a listening-post in a narrow tunnel day and night knowing that your enemy is gradually getting nearer, and that you may be blown up. No story of Jules Verne, Edgar Allen Poe, or H. G. Wells equals in living interest the facts of this underground warfare. Some explosions are only intended to shake up the ground without making a crater at surface; others are intended to blow the enemy and his works into fragments. Science, initiative, endurance and sustained courage are called for; and when the story of our tunneling corps in Belgium, France, and Gallipoli can be told, the public will be amazed at the ingenuity, the fortitude, and the efficiency of our colliers, our tin-miners and their intrepid leaders, some of whom have laid down their lives after exacting a heavy toll in dead from the enemy."

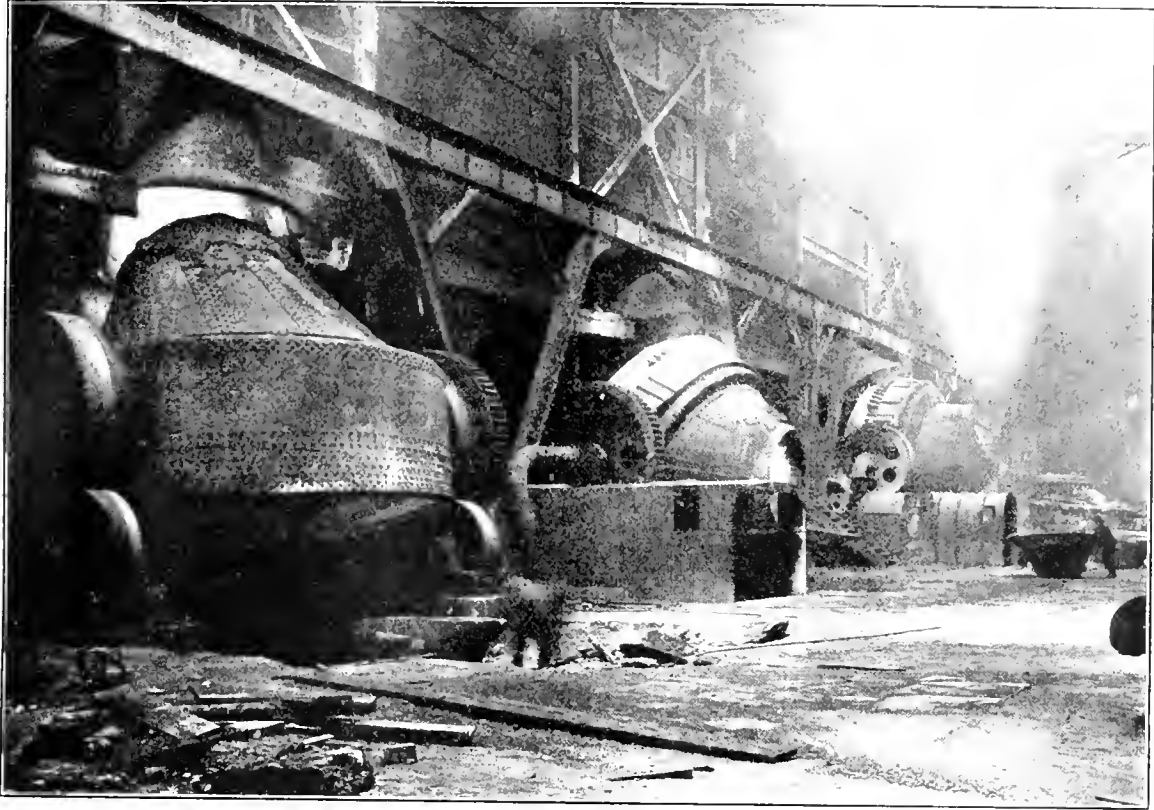

FIG. 13. TWENTY-FOOT CONVERTERS, ONE BLOWING, ONE POURING.

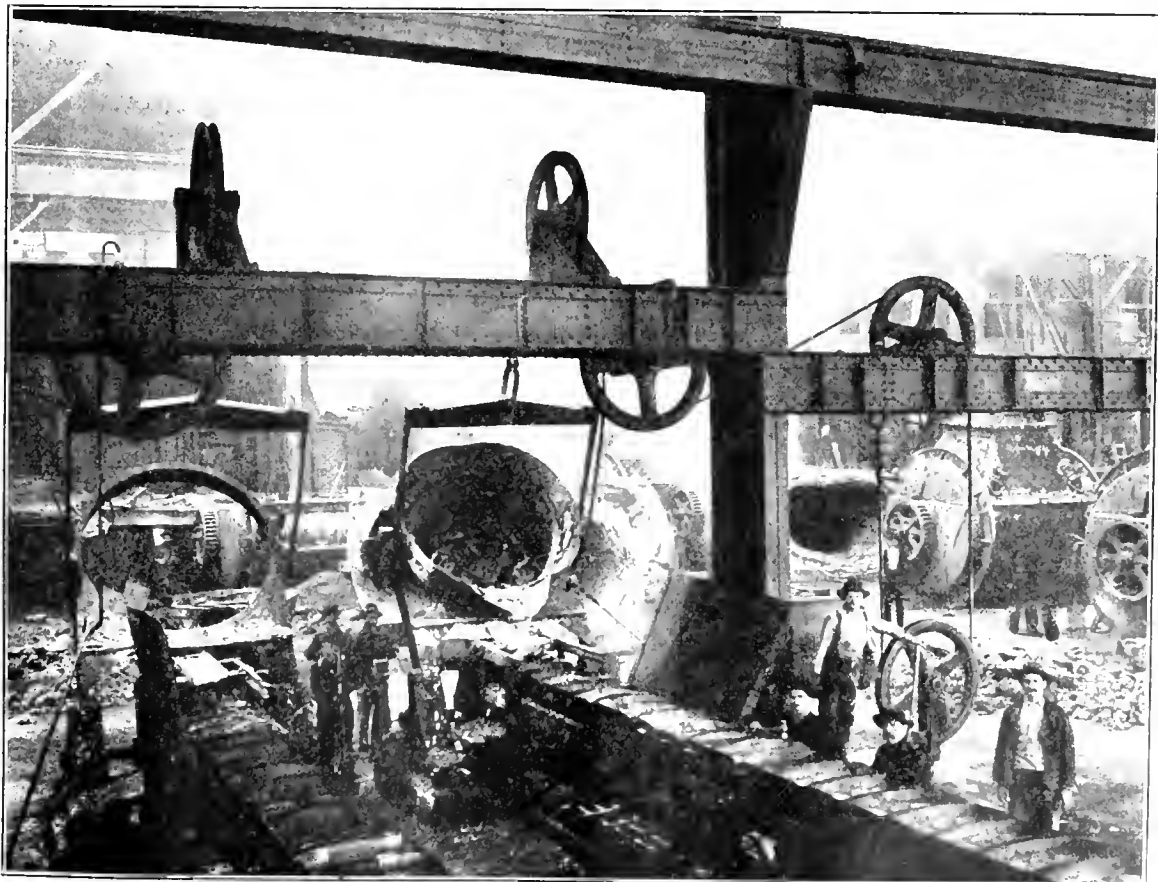

FIG. 14. CASTING CONVERTER SLAG AT THE CONVERTER BUILDING.

Antimony Veins at Bernice, Nevada

By Willard Mallory

GEOGRAPHY. The Bernice mining district on the western slope of the Clan Alpine range, Churchill county, Nevada, is 40 miles north-east from Wonder and 70 miles south-east of Lovelocks. The district is served by freight-team from Fallon, Nevada, a distance of 90 miles and a good day's drive by automobile. At present there are two producing mines; the Antimony King mine at Bernice, and the Lofthouse mine 5 miles south-west. The greatest local elevation is Grant's peak, 7500 ft., eight miles south-west of Bernice. From this point the western slope of the range descends rapidly to 4000 ft. and then gradually to the floor of Dixie valley, said to be 2800 ft. above sea-level, the lowest point in the State. Sedimentary rocks are well represented in the district, flanking the intrusive granite or monzonite that forms the crest of the range. The upturned edges of the tilted strata appear along the trend of the ranges. The predominating strike is north-west and south-east across the trend of the range, the dip being north-east.

ORE OCCURRENCE. The lower slate member of the sedimentary series is the only formation important as a source of antimony. All the mines or prospects examined occur within this horizon. The rock is an indurated shale, weathering yellowish to reddish-brown in color. Highly developed cleavage in two directions at high angles to the bedding causes it upon weathering to break into small thin shingles and pencils. Igneous rocks are conspicuously absent within this horizon.

Stibnite, the sulphide of antimony, is the only ore of commercial importance. Cervantite, the yellow oxide of antimony, forms thin coatings on the stibnite at the surface and massive thicknesses, eight to ten inches, in the weathered sections of some deposits, but this mineral quickly gives place to stibnite below the surface. One low-grade deposit carrying disseminated stibnite in quartz was observed, showing yellow altered surface material for a depth of six feet.

Antimony occurrences throughout this district are closely associated with isolated limestone strata. At the Antimony King mine there are two of these strata averaging 8 ft. wide and 300 ft. apart. They have the same strike and dip as the enclosing slate, and their trend is marked by prominent outcrops. The most persistent stratum is traceable for three miles. This rock is a fine-grained silicious limestone, massive and bluish-gray. It contains small cubes of disseminated pyrite. Normally it weathers grayish-white, but in some sections for continuous distances of a quarter of a mile these croppings are stained yellow by antimony oxide. Numerous prospect-holes furnish unaltered exposures showing specks of stibnite through the mass of the rock, also thin sheets of crystalline stibnite in cleavage and joint planes, but these antimony-bearing limestones do

not furnish ore in any commercial quantity, as so far noted.

ANTIMONY KING VEIN. The Antimony King vein is a true fissure with quartz-filling. It cuts the slate at nearly right angles and intersects the two limestone strata. It can be traced on the surface for 900 ft.; strike N 10° E, dip 50° W. The quartz-filling is from 1/4 inches to 1 foot wide, any portion of which may be replaced by solid stibnite. Both walls have a parting of black slaty gouge. The slate wall-rock is altered and carries disseminated cubical pyrite. Sphalerite is the only associate of the stibnite in the vein itself; it occurs but sparingly and at wide intervals.

This vein is regarded as remarkably persistent for an antimony deposit. The best ore-shoots occur south of the intersection of the vein with the southern limestone stratum. Here the lower drift has opened up the vein continuously for a distance of 200 ft. to a depth of 100 ft. A faulted segment of the limestone strikes nearly parallel with the vein at this intersection, and for a distance of 70 ft. this segment has become incorporated into the lode, forming a 'lime spur' lying next the hanging wall. The best orebodies occur in the quartz under this lime spur, where solid stibnite in widths up to 2 ft. has been discovered and mixed massive stibnite and quartz in widths up to 4 ft. This 'spur' feathers out on the south strike of the vein and the ore becomes less massive in character, showing a banded structure of alternate stibnite and quartz. Northward through the slate the vein, though small, continues with occasional good shoots of ore until it intersects the northern limestone stratum, beyond which it is apparently barren.

A genetic relation between the limestone and the orebodies is strikingly shown in the vein described, and is apparent throughout the district. The Lofthouse mine, six miles south of Bernice, is noteworthy in this respect. The vein is a fissure with quartz-filling and has the same direction of strike and dip as the Antimony King. The limestone stratum associated with it is the only one in an immense thickness of enclosing slate. In this mine the ore is less massive, occurring in fibrous and needle-like forms. Another illustration is furnished by a prospect a mile north of Bernice. Here an erratic quartz stringer, six inches wide, originates in the slate and intersects nearly at right angles a limestone stratum 10 ft. wide. On both sides of the lime the quartz is barren, but where it passes through the lime it widens to 8 inches and nearly all the quartz gives place to coarse fibrous stibnite.

In conclusion, the antimony deposits of merit or promise are essentially quartz-filled veins in slate, but deposits of importance have been found only where such veins are associated with silicious limestone.

ARIZONA has an area of 113,020 square miles, which is nearly twice that of Michigan. Its population of a quarter of a million is about that of Denver. Arizona's output of gold, silver, copper, lead, and zinc in 1915 was \$88,551,000.

Geology of the Cottonwood Districts

By L. O. Howard

INTRODUCTION. The Cottonwood districts are situated in the central portion of the Wasatch range, which overlooks Salt Lake City on the east, and cover the upper portions of two east-west canyons, Big Cottonwood and Little Cottonwood, the divide marking the boundary between the two districts. The Park City district joins Big Cottonwood on the north-east, and the mineral zone extends from Park City through the Cottonwoods into American Fork canyon, which heads over the divide south of Little Cottonwood. The mouth of Big Cottonwood canyon is ten miles south and five miles east of Salt Lake City. Little Cottonwood is three miles south of Big Cottonwood. The principal properties in the two districts cover an area seven by six miles at the widest part. The principal town is Alta, in Little Cottonwood, 11 miles up the canyon. It is reached by stage from Sandy, on a branch of the San Pedro, Los Angeles & Salt Lake railroad. The trip up Big Cottonwood is made by automobile from Salt Lake in two hours, and most of the properties can be reached by this means. Ore and supplies are transported in Big Cottonwood by wagon, the ore being hauled either to the smelter or to the railroad at Murray. A spur runs from Sandy up Little Cottonwood to Wasatch, $2\frac{1}{2}$ miles above the canyon entrance. An aerial tramway is operated in the summer months to transport Little Cottonwood ore to Tanner's Flat, leaving a gap between that point and the railroad of $3\frac{1}{2}$ miles, over which ore must be hauled in wagons. The expense of the necessary snow-sheds and the danger from slides makes a railroad up the canyon to the mines an uncertain enterprise at this time. It is probable that a new aerial tramway will be the ultimate solution of this problem.

The district has had a regular but small output since 1867, having produced in that period \$20,652,910.¹ Last summer marked intensive development, and a largely increased production is anticipated for 1916.

TOPOGRAPHY. The region is one of high relief. The Wasatch range extends northerly and southerly for 200 miles. Its western border is marked by a steep fault-escarpment overlooking the Salt Lake valley. The crest of the range is near this western border, the slope eastward being long and less steep. The main divide lies from one to six miles east of the crest. The range is cut by many east and west canyons, with deep dissection and steep walls in the lower portions. Big and Little Cottonwood, especially the upper portions, are much marked by glaciation, indicated by rounded hills, U-shaped valleys, hanging lakes, and moraines. Abrupt cliffs terminate both canyons. Alta and Brighton have eleva-

tions of 8700 ft. The surrounding ridges rise to above 10,000 ft. These conditions make adits the logical means of development.

STRATIGRAPHY. The following notes on the sequence of the formations are based on work done in 1912 by F. F. Hintze, Jr., published in the *Annals of the New York Academy of Sciences*,² checked as to part of the section by my personal observations.

The sediments exposed range from the Archean to the Jurassic. Misunderstandings have arisen from a too close study of the formations about the more productive mines on the Alta side, and the difficulty of mapping the strata there without previous study of the sequence exhibited in Big Cottonwood. The geologic section includes great thicknesses of shales, quartzites, and limestones, from Algonkian to Jurassic, lying unconformably upon Archean schists and gneisses exposed near the mouth of Big Cottonwood. The great Cottonwood quartzite and slate series, variously estimated at 1000 to 6000 ft. in thickness, lies at the base. Unconformably overlying it are 700 ft. of Lower Cambrian quartzite and 150 ft. of Middle and Lower Cambrian shale, a dark, sandy, micaceous, thin-bedded shale, which in turn underlies the ore-bearing limestone of the Ordovician. This shale is found in the canyon below the Maxfield mine, near the head of South Fork and near Superior gulch in Little Cottonwood. The Ordovician limestone, exposed and mined in the Maxfield, and known locally as the Maxfield formation, is found on the top of Kessler's peak, at the south end of Reade & Benson's ridge, and southward in Little Cottonwood. The contact of the Alta shale and the Maxfield limestone is one of the markers in the district, and is the lower boundary of the ore-zone so far developed. The Maxfield formation, consisting of interbedded limestone and shales, is of a characteristic wormy appearance and light-gray to white. In it are found the ores of the western mines, the Maxfield, Cardiff, Fuller, Sells, and those north of Alta.

Overlying the Ordovician unconformably is nearly 1500 ft. of fossiliferous Devonian limestone, also productive. Next in the series are the limestones and shales of the Mississippian, the Reade formation, nearly 1000 ft. thick. The lowest member is a massive bluish limestone, the middle a thin-bedded sandstone and shale, overlain by a fossiliferous blue limestone. The lowest member is exposed at the north end of Reade & Benson ridge, between South Fork and Day's Fork. A great unconformity exists between the Mississippian and the Lower Pennsylvanian, the latter represented by the Weber quartzite, composed of an even-textured fine-

¹Butler, Loughlin, and Heikes; Bull. 620-I, U. S. G. S., p. 194, 1915.

²Vol. XXIII, pp. 85-143, 1912.

grained rock. It is exposed near the Government forestry station in the upper part of Big Cottonwood canyon. Above it lies the Park City formation, which has been so productive of bonanza ore in the adjoining district. As deposited on the north side of the canyon it includes several hundred feet of limestone, with intercalated shale and quartzite. It has not been of great economic importance in the Cottonwood district.

Next above is the Woodside shale, dark red, fine-grained, and carrying no ore. It is succeeded by the Triassic Thaynes formation, in which occurs the ore of the Scottish Chief mine on Scott Hill, on the Park City divide. As exposed on the north side of Big Cottonwood, it consists of 450 ft. of intercalated sandstones, limestones, and shales, with sandstone predominating in the lowest member, separated from the more limy beds above by 115 ft. of red shale. The upper 630 ft. is predominantly limestone. The Anka-reh shale, which overlies the Thaynes, is exposed on the divide. It consists of 1100 ft. of red shale with some beds of coarse gray sandstone and a few beds of limestone. Just over the divide and along part of the ridge is the highest formation in the district, the Nugget sandstone.

IGNEOUS ROCKS. Three large masses outcrop. The geologists of the Fortieth Parallel survey mapped these as Archean, on which they supposed the sedimentary series was deposited. Geikie,³ Emmons,⁴ Boutwell,⁵ and Hintze⁶ are in agreement as to their intrusive character. Near the mouth of Little Cottonwood is a great mass of porphyritic granite extending nearly to Superior gulch, and in contact with the Cottonwood quartzites and shales along the divide between the canyons. This contact crosses Little Cottonwood at Hawley's Flat, about 1½ miles west of Alta. The more basic granodiorite outcropping near the centre of Alta extends under the amphitheatre in the south fork of Little Cottonwood, into Big Cottonwood near Twin Lakes, on the Lake Catherine pass, and forms the western wall of the head of the canyon, composing the ridge between Brighton and Solitude gulch. It extends also southeast to the head of Snake creek. Still farther east is a third mass, the quartz-diorite forming Clayton peak, and appearing on the walls at the south head of Big Cottonwood under Pioneer peak, and north-east in the Park City district.

Although no evidence has been brought forward by other investigators to connect the Alta and Clayton Peak masses, and Butler and Loughlin give no reasons for their opinion, the latter map the two as one mass and call it all quartz-diorite, reserving the name granodiorite for the Little Cottonwood granite. This results

in an unfortunate confusion of terms. When the more recent writers decided to change the classification of these rocks contrary to all evidence and the previous report of Boutwell, it would have carried more weight had they given their reasons for the change. Hintze speaks of the three separate masses, granite, granodiorite, and quartz diorite, and notes the absence of surface connection between them, while calling attention to the probability of their being differentiations of the same magma. Recently, in making examinations near the head of Big Cottonwood, I had occasion to prepare thin sections from samples taken from that part of the Alta mass which forms the ridge between Brighton and Solitude gulch, exposed on the west side in an old tunnel. This is the portion of the mass to which Boutwell refers when he says: "The Alta mass has made its way up through Paleozoic sediments overlying the Cambrian at the head of the canyon (Little Cottonwood), cutting across Carboniferous limestone, which it has metamorphosed highly, and extends eastward to form the western wall about the head of Big Cottonwood canyon, probably inducing the formation in the abutting truncated limestone of contact metamorphic minerals and ore-deposits."⁷ Examination of these thin sections gave conclusive evidence of the character of the rock and agrees with the statements of Boutwell and Hintze. From these masses, dikes and sills have penetrated the surrounding sediments, metamorphosing them highly, and exerting a great influence on the formation of ore deposits.

STRUCTURE. The intrusive masses have domed the sediments, which dip away from the intrusions on all sides, generally at angles of 35° to 45°, with local variations from this dip. The western half of this dome has been cut off by the great Wasatch fault, and has been depressed to form the floor of the Salt Lake valley. In a particular zone the sediments have been much folded and faulted, the result probably of a great over-thrust from east to west. This is illustrated in the accompanying section from Alta in Little Cottonwood north-west to Argenta in Big Cottonwood, east of the Maxfield mine. This section is taken from Hintze. Along the ridge between Big and Little Cottonwood east from Superior gulch, the beds dip about 45° to the north-east and appear in the following sequence: Brigham quartzite, Alta shale, Maxfield limestone, Benson limestone, Cottonwood quartzites and shales, Brigham quartzite, Alta shale, Maxfield limestone, Benson limestone, Reade formation, etc. This duplication of beds has been thoroughly proved. As shown by the section from Alta to Argenta, its only effect on the north side of Big Cottonwood is to duplicate a portion of the Brigham quartzite. Within this zone of over-thrusting there is much crumpling of the beds and many minor faults. The line of the over-thrust can be traced from the south side of Big Cottonwood up South Fork, down Superior gulch, crossing Little Cottonwood, up Peruvian gulch into the head of American Fork canyon at Min-

³Geikie, Archibald, 'Archean Rocks of the Wasatch Mountains,' *Amer. Jour. Sci.*, 3rd ser., vol. 19, pp. 363-367, 1889.

⁴Emmons, S. F., 'The Little Cottonwood Granite Body of the Wasatch Mountains,' *Amer. Jour. Sci.*, 4th ser., vol. 16, pp. 139-147, 1903.

⁵Boutwell, J. M., 'Geology and Ore Deposits of the Park City District, Utah,' U. S. G. S., Prof. Paper 77, pp. 66-67, 1912.

⁶Hintze, F. F., Jr., 'A Contribution to the Geology of the Wasatch Mountains, Utah,' *Ann. N. Y. Acad. Sci.*, vol. 23, pp. 85-143, 1912.

⁷*Op. cit.*, p. 67.

eral Flat. Its age is believed to be contemporaneous with the first disturbances in the region and to precede the intrusions.

There are two systems of faults, a NW-SE system and a NE-SW system, the origin of which is not clear, and is variously explained. They are considered by Hintze⁸ to be strike-and-dip faults. He states that the NE system was the earliest and that the NW system occurred after mineralization, since faults of this system displace the ore. Butler and Loughlin⁹ believe that both systems were the result of the intrusions, calling attention to their being radial to and concentric with these intrusions. They consider the Superior fault to be a reverse fault, concentric with the Alta mass, and not

stone, and that there is a deeper limestone on Reade & Benson ridge than was at first supposed. Exact measurements have been difficult. The fault-trace dies out in crossing Big Cottonwood, although in line with the fault-plane the western side of these same beds has evidently dropped on the north side of Big Cottonwood, indicating, until further evidence is available, that the fault is possibly pivotal, with its fulcrum between the Cardiff and the mouth of South Fork.¹⁰ Butler and Loughlin note but few local faults that are definitely later than the ore deposition, although there is reason to believe that many of the minor faults between Superior and Silver Fork, and these two great faults also, have displaced the ore-bearing fissures. A consensus of

opinion prevails that the great Wasatch fault and its accompanying minor faults were much later than the ore deposition, and that the period of subsequent readjustment covered a long time.

There is a tendency among some of the operators to regard each of the north-south gulches leading into Big Cottonwood, namely, South Fork, Day's Fork, Silver Fork, Honeycomb gulch, and Solitude gulch, as lines of faulting. They have no definite proof to offer, and are doubtless letting generalities lead them into unsound conclusions, depending rather on 'hunches' than on exact observation and critical reasoning.

It is obvious that much detail work must be done before the different systems of faulting can be satisfactorily classified, and it is equally obvious that this work will not be done until the Government can be induced to order a thorough study of the region. There is no district in the State where the need is more urgent. Underground develop-

ment now being done should clarify the geologic structure, especially in the north-eastern portion of the Big Cottonwood district, where both main systems of fissuring appear to be well mineralized.

ORE DEPOSITS. These may be placed in three classes, vein or fissure deposits, contact-metamorphic deposits, and bedded deposits. The division between these types is not clear-cut, all evidently having been formed during the same periods of mineralization, and being genetically connected with the intrusive stocks of quartz-diorite and grano-diorite, or their off-shoots. In the vein type there is invariably some replacement of the walls, and where favorable limestone beds are intersected by the fissures, replacement-deposits are formed. Contact deposits are found especially along the north side of the Alta grano-diorite, the limestone being highly metamorphosed in the vicinity of this stock, with the development of typical contact minerals, such as diopside, garnet, magnetite, pyrite, and in the Mountain Lake mine the boron

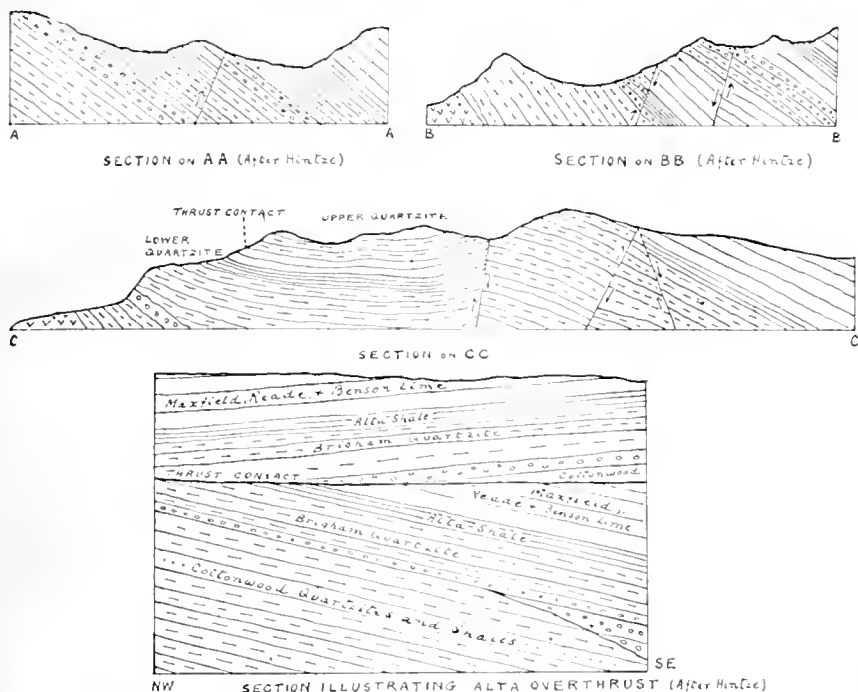

SECTIONS ACROSS THE COTTONWOOD DISTRICT. (See map on page 561.)

necessarily much later. The fault at the south end of Reade & Benson ridge they consider in the same class.

At the head of Silver Fork, just north of Alta, is a fault that Hintze estimates to have a displacement of 500 to 600 ft.; this he is unable to classify as normal or reverse. He inclines to the view that the block between this fault and the Superior fault has gone down farther on the west than the east, and that the minor faults between these two were a part of the same disturbance.

As the most pronounced fault in the district, except the Alta over-thrust, the Superior fault deserves brief description. Its trace is observable from below the Cardiff mine in the South Fork of Big Cottonwood, over the ridge, and down Superior gulch in Little Cottonwood, the trend being nearly north and south. Appearances in South Fork indicated normal faulting, but more pronounced evidence in Superior gulch shows that it is a reverse fault, with nearly vertical displacement. This interpretation shows the Cardiff to be in the lower lime-

⁸Op. cit., p. 137.

⁹Op. cit., p. 179-182.

¹⁰Hintze, p. 139.

mineral, ludwigite. At the surface these zones often contain from 1 to 2% copper with some silver and gold, the oxidized minerals surrounding a core of sulphide. The metamorphism is most marked in zones parallel to grano-diorite dikes, and at varying distances from them. The white limestones appear to be the more highly metamorphosed, some thin sections showing complete alteration to diopside. Not much development has been undertaken on the typical contact deposits.

The vein deposits occur in rocks of varying characteristics, in the Cambrian shales and quartzites of the Toledo and Cardiff, the Ordovician and Devonian limestones of the Emma and City Rocks, and the Thaynes of the Scottish Chief. For a detailed description of these veins I refer the reader to pages 202 to 208 of the Survey bulletin by Butler and Loughlin. The outcrops are in places soft ochre-stained limestone members, in others hard, porous, rusty, and silicified, changing with moderate depth to a soft earthy hydroxide of iron, containing chimneys rich in lead and silver oxidation products. The width of the veins varies from 1 to 20 ft., with an average of 3 ft. They dip at high angles, usually to the north-west, from 55° to vertical. The wall-rock in the Fuller, Cardiff and Branberg is quartzite; in the City Rocks, Butte, Oregon and other veins to the east it is white limestone, the vein tending to pinch in the hard blue limestone. The vein-stone of the Fuller, City Rocks, Savage, Montezuma, Butte, Oregon, South Hecla, and Albion, has been soft earthy hydroxide of iron with cerussite, anglesite, manganese dioxide and argentite. It occurred mainly in chimneys from 50 to 200 ft. long, pitching with the strike of the veins, and separated from each other by about equal amounts of barren vein-matter. Chlorides are invariably absent. Wulfenite is a common mineral.¹¹ The oxidized ore persisted below water-level, where development ceased. Where opened on some of the lower levels, the ore in these veins has been found to be 6 to 18 inches wide, consisting of a mixture of chalcopyrite, galena, sphalerite, and tetrahedrite in a gangue of quartz. Molybdenite is common. While the oxidized ore has been usually of a shipping grade, the sulphide ore of the lower levels more often requires milling.

The bedded deposits have proved the largest and richest. They are found at the intersection of mineralized fissures with certain favorable limestone beds, and where found in quartzites and shales, are usually in limestone beds. The white porous limestone is the most favorable for these deposits also. The deposits are generally lenticular, with strike and dip conforming with that of the formation, and the longest dimension along the dip. They are often 200 ft. long, and extend 100 to 500 ft. in depth. Their thickness varies from 1 to 30 ft., but averages about 10. They are usually connected by narrow seams of ochreous material or pipes of mineral. In the limestone the ore has the same characteristics as in the fissure deposits.

In some of the mines, notably Alta Consolidated, it has been noted that where the ore is in the shale, it appears as galena, sphalerite, pyrite, and tetrahedrite. Ore deposits of the bedded type have been found in the Emma, Flagstaff, Columbus, Alta Con., Prince of Wales, Cardiff, Maxfield, Rende & Benson, and Carbonate. In the Vallejo and North Star the form taken was that of pipes and shoots.

Ore has been found in fissures in the Brigham quartzite in the over-thrust zone. Little attention has been given to prospecting the quartzite below the lowest limestone beds. A narrow vein following the bedding of the quartzite is now being explored in the Logger ground, in the north-western portion of the district, below the limestone series. Bunches and lenses of oxidized lead and silver ore in a clay gangue, and streaks of high-grade chalcocite have been found.

Still farther west in the Algonkian quartzite and slate series, chalcopyrite and galena are intimately mixed with barite and quartz in porphyry, but no development has been done on these narrow stringers.

RELATION TO PARK CITY DISTRICT. There has been talk about the Cottonwood mines being in the same formation as those of Park City. A glance at the geological section shows thousands of feet geologically between the Ordovician and Devonian of Cottonwood and the lowest productive formation of Park City, the Weber quartzite. The orebodies of Park City are genetically related to the Clayton Peak stock of quartz-diorite, whereas those of Cottonwood are more intimately related to the Alta stock of grano-diorite. No commercial deposits have been developed in association with the Little Cottonwood granite, although much low-grade molybdenite is found in connection with it in Little Cottonwood, near White Pine and Red Pine gulches.

Referring again to Butler and Loughlin's designation of the Alta mass as quartz-diorite and the Little Cottonwood granite as grano-diorite, the following quotation distorts the actual conditions. They say: "Around and closely associated with the Little Cottonwood stock of grano-diorite, intruded into the pre-Cambrian and early Cambrian rocks, few if any deposits of commercial importance have been developed, while most of the important deposits of the belt are associated with the Clayton Peak stock of quartz-diorite."¹² This statement becomes true only when for "grano-diorite," we substitute "granite," and for "Clayton Peak stock of quartz-diorite," we say "Alta stock of grano-diorite."

One other statement of Butler and Loughlin is worthy of note here. They say: "A study of the ore deposits of the State indicates that as a general rule the greatest mineralization occurs toward the top of intrusive stocks or in the adjacent sedimentary formations at a corresponding horizon, and therefore it is not probable that the mineralization in the Cottonwood-American Fork area was so extensive as that in the Park City district."¹³ However, this should not be a cause for much

¹¹Hess, F. L., 'Wulfenite at Alta, Utah.' U. S. G. S. Bull. 340, p. 238, 1906.

¹²*Op. cit.*, p. 225.

¹³*Op. cit.*, p. 226.

apprehension on the part of the Cottonwood operators, for the mineralization may well be less than in the 'bonanza' Park City district, and yet justify and reward intelligent efforts to open profitable mines.

SUMMARY. 1. The sedimentary series of the Cottonwood districts consists of interbedded quartzites, limestones, and shales, ranging from Archean to Jurassic, of which the Lower Cambrian quartzites and shales, and the Ordovician and Devonian limestones have been the most productive.

2. Beds from the Algonkian through the Devonian have been duplicated along the divide between the two

districts by a great over-thrust, probably of the same age as the main Wasatch folds, late Cretaceous.

3. Igneous activity is represented by three intrusive stocks of granite, grano-diorite, and quartz-diorite, which have domed the sediments, of which those associated with the grano-diorite stock have been the loci of ore deposition.

4. Coincident with the intrusions, radial and concentric fissures and dikes were formed, along which subsequent mineralization deposited the primary ores. The NE-SW system in the central zone appears to be more mineralized than the NW-SE system. Oxidation has

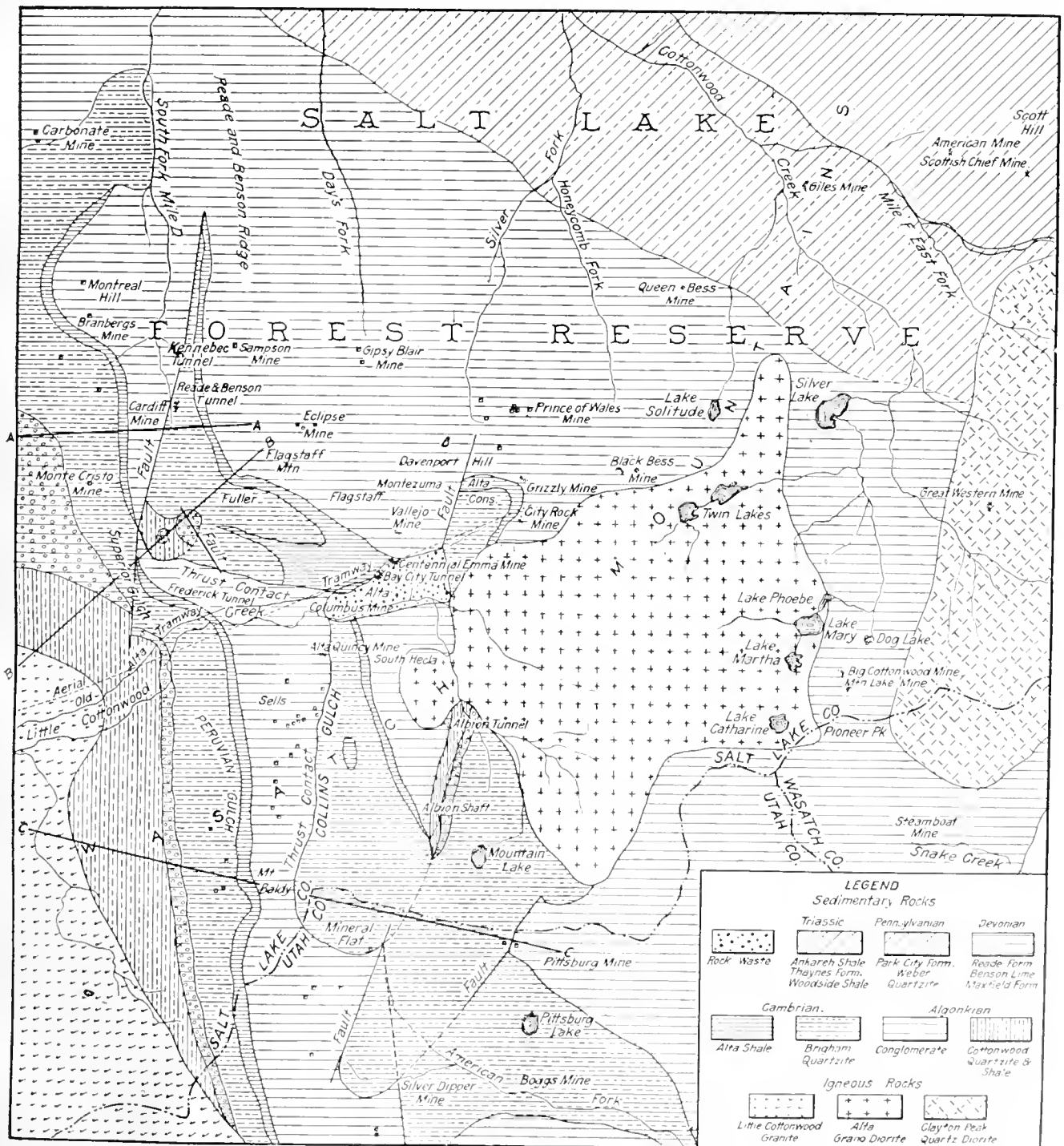

GEOLOGIC MAP OF BIG AND LITTLE COTTONWOOD MINING DISTRICTS, UTAH.

converted the primary galena, chalcopyrite, sphalerite, and tetrahedrite into high grade 'carbonate' ores.

5. Later faulting in a north-south direction caused the drop of the large block between Superior gulch and Silver Fork, with the production of a complicated series of minor faults, some of which cut off the ore-tissures and make development difficult. This faulting was probably contemporaneous with the great Wasatch fault, which dropped the western half of the dome below the floor of Salt Lake valley. The existence of a pivotal fault, with its fulcrum between the Cardiff and the mouth of South Fork, is indicated.

6. Ore deposits are of three types, fissure, bedded, and contact-metamorphic, and appear principally in certain limestone beds of the Brigham, Maxfield, and Benson formations. The white porous limestone seems to be most favorable to ore. The three types grade into each other, and are genetically related to the intrusion of the grano-diorite.

7. The fissure deposits occur in Cambrian shales and quartzites, Ordovician and Devonian limestones, and to a limited extent in the Triassic Thaynes formation which is more closely related to the Park City district. The ore occurs in chimneys having a high pitch and dip, usually about 3 ft. thick.

8. The bedded deposits are in the form of lenticular masses of little thickness, but having considerable length and depth, in certain favorable limestone beds, at contacts of the limestone with other beds, and at the intersection of fissures with these beds and contacts.

9. Contact deposits have been formed in certain limestone beds that have been highly metamorphosed by the intrusives, the typical contact minerals, diopside, garnet, magnetite, pyrite and ludwigite being prominent.

10. The past production has come mainly from the soft beds containing the products of oxidation of galena, argentite, tetrahedrite, chalcopyrite, and various sulph-arsenides and sulph-antimonides. Chlorides are generally absent. Wulfenite is common. This ore has assayed above 100 oz. silver and 38% lead. The sulphides are found more often in the quartzites and shales, and are not so rich. With these molybdenite is common.

11. The ore deposits do not occur in the same formation as those of Park City, but are several horizons lower, and it is noted that the mineralization in the Cottonwoods is not as extensive as in the Park City district.

COLORADO'S output of gold, silver, lead, zinc, and copper in 1915 was \$43,100,000, compared with \$33,460,126 in 1914. Colorado's area of 103,925 square miles is over twice that of Pennsylvania; its population of over 800,000 is greater than that of Montana and Arizona combined, though its metal output is much less.

LATIN-AMERICAN COUNTRIES have an area three times that of the United States, and a population equal to that of this country. The foreign trade of Latin-America in 1913 was \$2,800,000,000; that of the United States was \$4,200,000,000.

Mineral Production of Rhodesia

The following table gives the output for 1915:

| | Quantity | Value |
|--------------------|------------|------------|
| Gold, ounces | 915,929.36 | £3,823,168 |
| Silver, ounces | 185,231.83 | 17,146 |
| Copper, tons | 3,511.52 | 217,643 |
| Lead, tons | 27.77 | 557 |
| Chrome iron, tons | 60,580.75 | 201,910 |
| Asbestos, tons | 2,010.41 | 32,190 |
| Coal, tons | 309,763.00 | 123,192 |
| Diamonds, carats | 272.05 | 1,916 |
| Copper matte, tons | 9.50 | 285 |
| Ironstone, tons | 9,622.13 | 1,699 |

Total £4,421,806

In 1914 the grand total value from all sources was £3,882,996. The increase in value is therefore over £500,000, of which about half is due to the gold yield.

PUMPING EQUIPMENT at the Old Dominion mine, Globe, Arizona, has both steam and electric units, the latter for the deeper levels. Steam pumps on the 1000, 1200, and 1400-ft. levels lift direct to water-storage tanks on surface and to a drain tunnel; electric pumps on the 1400, 1600, and 1800-ft. levels lift the water to the main station on the 1200-ft. level to be relayed to surface. Four of the steam pumps are Prescott triple-expansion duplex type; and four are Nordberg triple-expansion fly-wheel type. The steam pressure at the pumps is 134 lb. The triple-expansion fly-wheel pumps, which are used in normal times, consume 18 to 18.2 lb. of steam per water horse-power. The electric pumps on the lower levels include an Aldrich vertical quintuplex single-reduction plunger pump with 150 hp. A.C. motor; this lifts 900 gal. per minute a height of 400 ft. In the same station with the quintuplex pump are three vertical, triplex, double-reduction pumps, run by D.C.; these also lift 400 ft., the largest having a capacity of 470 gal. per minute, the smallest 180 gal. Below are two horizontal, quintuplex, Aldrich pumps, each with a 250 hp. A.C. motor; pumping 600 ft., these have a capacity of 1100 gal. per minute each.

BOLIVIA, although shut off from the rest of the world by other countries, is reached by three excellent railroads. One extends inland from the port of Mollendo, Peru, and two from the ports of Arica and Antofagasta in Chile. From Arica to La Paz, Bolivia's mountain capital, is 30 hours by train. La Paz, a city of 70,000 people, has street-cars, electric lights, telephones, and modern buildings. The south-western part of Bolivia, where are the important mines, is a barren plateau. The northern and eastern parts of the country are vast rolling lands and prairies drained by branches of great rivers that empty into the Atlantic. Of the South American nations, Bolivia has the highest proportion of pure Indian population. Mining is the chief industry. In 1913, the United States furnished 7½% of Bolivia's imports.

Rapid Method for Tungsten

By M. L. Hartmann

The accurate methods* for the determination of tungstic oxide in ores are longer and more laborious than is desirable for control work in mining operations. The great activity in the production of tungsten ores has created a demand for a rapid method accurate enough for the purpose stated. The following schemes, modified from the more accurate *aqua regia* method have been used successfully.

Treat one gram of the very finely ground ore with about 50 cc. *aqua regia* in a 4-oz. flask. Heat the solution, but do not boil; shake the flask frequently. When the solution is evaporated to about 10 cc. and no black particles remain undissolved, dilute with 50 cc. hot water and allow to stand for half an hour. Filter through an ashless paper, and wash the residue thoroughly with hot water slightly acidulated with hydrochloric acid. Ignite the paper with the residue of silica and tungstic acid in a weighed platinum crucible with free access of air. Fill the crucible with hydrofluoric acid, evaporate to dryness, ignite and weigh as tungstic oxide. The final product should be bright yellow in color.

With certain ores there is some difficulty in getting all the material into solution by this method. In this case fusion of the sample in sodium carbonate by the longer and more accurate method is the only real solution of the difficulty. With large quantities of tungstic oxide, there is danger of injury to the platinum crucible by alloying it with tungsten produced by reduction by means of the burning carbon of the filter-paper. It is better to burn the paper on a platinum wire, and allow the ash to fall into the platinum crucible. If the residue contains a large amount of silica, the evaporation with hydrofluoric acid should be repeated.

It is frequently necessary to make the determination when a platinum crucible is not available. Without platinum ware it is not possible to make the evaporation with hydrofluoric acid to remove the silica. Under these circumstances the following method can be used:

Decompose one gram of the ore with *aqua regia* as described above. Add 50 cc. hot water, and let stand for half an hour. Decant the solution through a filter-paper, and wash the residue in the flask several times by decantation, using about 50 cc. hot water slightly acidulated with hydrochloric acid. Keep back in the flask as much of the residue as possible. Add about 20 cc. ammonium hydroxide solution (200 cc. strong ammonia, with 1000 cc. water and 10 cc. concentrated hydrochloric acid). When the yellow tungstic acid is all dissolved, transfer the residue by means of the ammonium hydroxide solution to the filter-paper, and wash thoroughly with water. This residue should be pure white (silica). Evaporate the solution to dryness in a weighed porcelain crucible, ignite gently to drive off the ammonium salts,

and finally heat strongly to constant weight. The tungstic oxide thus obtained will be contaminated with a small amount of silica, therefore the results are usually a little high by this method.

In either case it must be borne in mind that at best these methods are only approximate and that there are several chances of error. They are useful only as rapid methods for mine-control work.

A Flotation Machine

Herewith is a drawing of the flotation apparatus used at the mine of the Suan Concession, in Korea, a company under progressive American management. It was em-

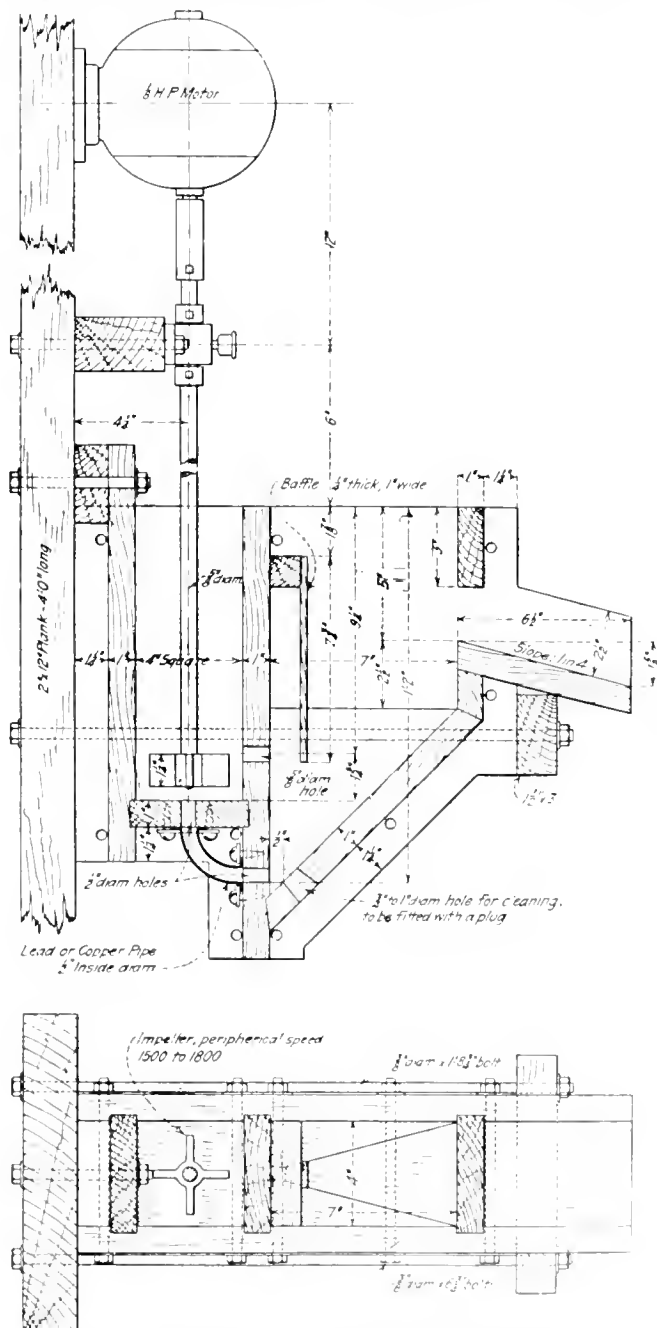

ployed to check small-scale tests and for removing chalcopyrite from scheelite. The capacity is 100 pounds of crushed ore per hour. The total cost, including motor, is under \$50.

*See *Pahasapa Quarterly*, South Dakota State School of Mines, February 1916.

CONCENTRATES

Readers of the MINING and Scientific PRESS are invited to ask questions and give information dealing with technical and other matters pertaining to the practice of mining, milling, and smelting.

FLUE-DUST from the Copper Queen blast-furnaces amounts to 4.29% of the charge smelted.

TROMMELS and *kulibinas* washing machines at the Lena gravel mine, Siberia, have been replaced by long sluices of the Alaska type, resulting in less losses of gold and lower costs, namely, 56 to 35 cents per cubic yard.

COST of producing steam power at the Copper Queen reduction works, where oil is used direct under boilers, and other boilers are in the reverberatory-furnace flues, is \$60.436 per hp.-year. An average of 4507 hp. is developed.

CONCENTRATE from the Brunswick gold mine, Grass Valley, California, is shipped to smelters for treatment. In 1915, 376 tons, worth \$70.311 per ton, cost \$17.125 per ton. The amount of mineral in the ore averaged 1.71 per cent.

STEAM-SHOVELS find their principal use in mining at open-cut iron mines, such as in Minnesota, and at the extensive 'porphyry' copper mines. At the Wasp No. 2 mine in South Dakota a steam-shovel handles gold ore up to 500 tons per day.

WORKMEN deprived of a forearm through accidents can be fitted with a magnetic hand. As devised in Germany, this hand permits a workman to operate a file, plane, lathe, etc. The hand contains an electro-magnet, and connection with electric current is made by the foot or the other arm.

DYNAMITE and linoleum consume over 20,000 tons of wood-flour, costing \$300,000, per year. A white flour is demanded for the dynamite, as the freshness of the explosive is indicated by a light color. The flour must be very absorbent, so that the nitro-glycerine will not leak out. Wheat flour is also used in dynamite.

'SUBMERGENCE' in air-lifts, as used for raising water from mines or oil from wells, is the depth that the air-pipe is submerged below the pumping level of the water or oil. The 'percentage of submergence' is the proportion of the total length of pipe submerged in the water when pumping. Low lifts require proportionately more submergence than high lifts; for a lift of 20 ft., 66% submergence is necessary; for a lift of 500 ft., 41%. In some cases of deep pumping the submergence is only 30 per cent.

A STEEL HEAD-FRAME is generally considered to cost 50% more than a timber structure of the same kind, but is, of course, much more satisfactory. An 85-ft. two-post steel head-frame recently erected at the Brunswick vertical shaft at Grass Valley, California, cost a total of

\$5873. Of this cost, \$4086 was for materials and \$1787 was for labor. Of the materials, the structural fabricated steel cost \$3587 and the sheaves \$384. Of the labor cost, the erecting-contractors were paid \$676; \$112 was paid for concrete foundations; and \$291 for work of an engineer and draftsman.

AN ELECTRO-HYDRAULIC shovel, as used by the Penn Iron Mining Co. at Vulcan, Michigan, employs water under pressure to perform all the operations except propelling, for which a separate motor is best suited. A motor-driven centrifugal pump mounted on the shovel discharges into a pressure tank; there are water-cylinders and plungers with a suction-tank into which the cylinders discharge and from which the pump draws its supply. One man operates the shovel, the average speed being three or four dippers per minute; by utilizing the water as a medium, peak loads are avoided in the electric power requirements.

PLATINUM is found in some copper ore near Ketchikan, Alaska, and the miners consider that they should receive payment for the platinum content of the shipments sent to the smelters. As far as can be found no smelter in the Pacific Coast States pays for platinum in such ore. During 1914 refiners of platinum sand, gold bullion, and copper matte reported that 3430 oz. of new refined platinum was recovered by them. Of this quantity 525 oz. came from domestic crude placer platinum, and at least 2500 oz. was derived from domestic sources, the remainder from foreign material treated in the United States. The price of platinum has risen considerably of late, and as will be found quoted on the metal page of this journal each week, is from \$88 to \$92 per ounce.

OIL AND GASOLINE are used at mines for many purposes, and frequently cause fires which are difficult to put out. A soda-foam is now on the market that will extinguish fires in receptacles containing from a gallon to a 55,000-bbl. tank. Foam has many distinct advantages. It can be thrown to a distance of more than 30 ft., and can be used on highly inflammable liquids without spattering them or without spreading the fire in the least degree. It floats on the lightest oils, and, being discharged in a state of continuous expansion, it spreads itself completely over an oil surface in the form of a blanket, entirely shutting off atmospheric oxygen from the burning surface. In its application as a stream, or jet, none of the carbon dioxide is lost in transit. This gas is carried in minute gas-bubbles direct to the seat of combustion in the form of a foam blanket, which remains for almost an hour. The foam has a cooling effect on all fires, but this is especially noticeable in oil fires, the oil being cooled below its flash-point, thereby preventing re-ignition. The foam is adhesive, sticking to ceilings and walls, or anything upon which it is thrown, and there remains until long after the fire is extinguished. The foam damages nothing and can be readily removed by washing. For small fires the mixture is sold in apparatus similar to the ordinary fire extinguishers.

REVIEW OF MINING

As seen at the world's great mining centres by our own correspondents.

BUTTE, MONTANA

BUTTE & SUPERIOR, ANACONDA, BUTTE-BALLAKLAVA, EAST BUTTE, BULLWACKER, AND LABOR TROUBLE AT PILOT BUTTE.

The Butte & Superior company treated 54,380 tons of ore during February (29 days), a daily average of 1875 tons, in a mill that was originally designed for 1000 tons. An idea of the improvements in treatment can be gained by a comparison with the corresponding month of 1913:

| Month of | Ore treated, tons | Ex-traction, per cent | Concentrates, tons | Zinc concentrates, pounds |
|---------------|-------------------|-----------------------|--------------------|---------------------------|
| February 1916 | 54,380 | 91.94 | 14,866 | 15,645,000 |
| February 1913 | 16,100 | 76.85 | 5,154 | 4,886,710 |

Five new sets of ball-mills and tube-mills are being installed.

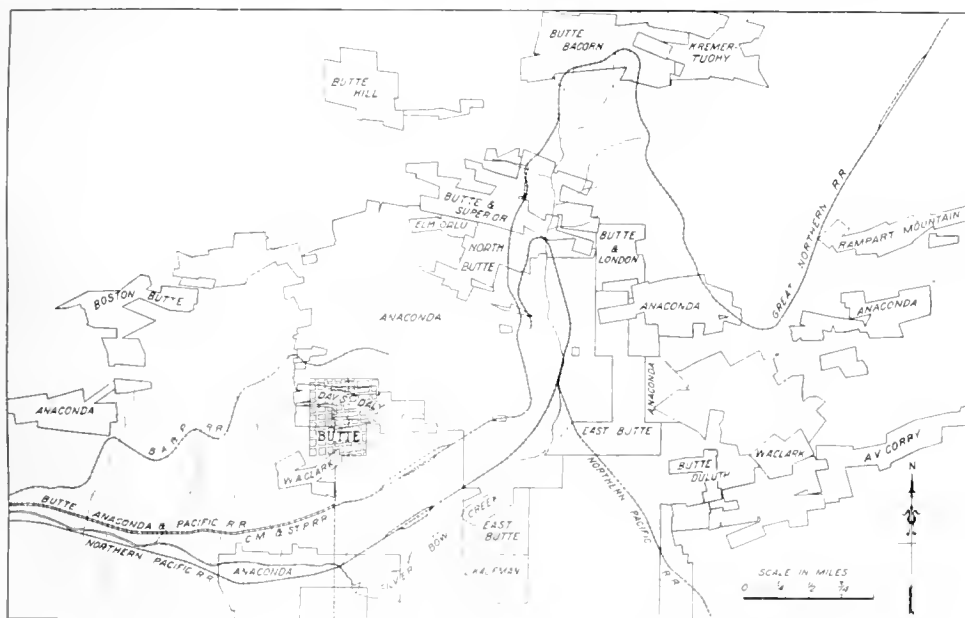

PRINCIPAL PROPERTIES AT BUTTE, MONTANA.

Some new filter-presses and a new compressor with a capacity of 5000 cu. ft. of air per minute will also be erected. The reported cutting of a large new orebody on the 1600-ft. level is the same that is being worked on the upper level. It is wider at 1600 ft. than on the levels above, and averages from 18 to 20% zinc. The new shafts are down 300 ft. Raising on the shaft has been started from the 1200 and 1300-ft. levels, and it is expected that the shaft-raises will be up to within 750 ft. of the surface by the time the shafts reach that depth.

The Robert Emmet lodes No. 1 and 2 were purchased at public auction from the Butte Copper Co. by the Anaconda company. The consideration was \$55,000, but the buyer already owned a 1/3 interest in No. 1, and a 2/3 interest in No. 2, so that the amount that will be paid the Butte Copper Co. for the balance of the two will be about \$39,000. It has not been decided whether this money will be used to further develop other properties of the Butte Copper Co., or whether it will be distributed to the shareholders.

In accordance with the terms of its option on the Douglass

property the Anaconda company has started development. The Douglass is one of the promising zinc-lead prospects of the Pine Creek district of the Coeur d'Alene, Idaho. There are about 1200 ft. of adits in the property, and these will be extended. The ore so far opened averages 17% zinc and 6% lead. If sufficient ore can be blocked-out it will be treated by the new wet process developed at Anaconda. (This process does not recover the lead). The option is in the form of a lease and bond, and runs for a period of three years from December 16, 1915. The total consideration is \$256,050. The outstanding shares of the Douglass company total 853,000; the rest of the 1,200,000 shares authorized are in the treasury of the company. The purchase price represents 30c. a share on the outstanding stock. Royalty to be paid on all ore shipped is \$3 per ton and will apply on the purchase price.

The experimental zinc plant at Anaconda is yielding 9 tons of zinc a day. It is being enlarged, and will soon have a capacity of 25 tons. Construction work is being rushed on the zinc plant at Great Falls. This plant will have a capacity of 70,000,000 lb. of zinc per annum, and will cost about \$2,000,000. It was planned to have the work completed in July. The company is receiving all the copper ore its works can treat.

It is understood that arrangements have been made with the Anaconda company whereby it will mine for the Butte-Ballaklava the ore that is now being developed in a drift from the High Ore mine that corresponds to the 2200-ft. level of the Ballaklava. This is 600 ft. below the bottom of the Ballaklava shaft. The Ballaklava is now mining 250 tons of ore per day. Most of the ore comes from 800, 1000, 1200, and 1600 ft. Considerable development is being done on the 1600-ft. level.

The fire in the Pennsylvania mine in which 21 men lost their lives is gradually being brought under control, and concrete bulkheads are being put in to confine it. The air-shaft which caved soon after the fire started is being re-timbered, and new pipe-lines for compressed air are being put down. The upper levels are producing some ore, and about 300 men are at work clearing up the lower levels, where the fire has been driven back, and putting them in shape to operate again. The normal capacity of the Pennsylvania is about 800 tons per day, and the output will be increased as conditions warrant it until the former daily average is being handled.

A shift-boss shot and killed a station-tender working under him at the Pilot Butte mine. The trouble started when the shift-boss sacked a socialist for not doing his work properly. The latter was one of the leaders in the Miners' Union trouble in June, 1914. All the men known to be instrumental in creating disorder at that time were blacklisted by the Anaconda company. The North Butte and Butte & Superior companies use the Anaconda company's 'rustling-card' system, so

those men with anarchistic tendencies were forced to seek employment at the smaller independent mines. Many of them found work at the Pilot Butte. The station-tender and the man that was discharged were socialists of the same order. The shift boss was underground between shifts early one morning and the station-tender argued with him for discharging the socialist. The station-tender jumped on the cage when the boss was ready to go up, and they went to the surface together. At the shaft-collar the station-tender started an attack, but the shift boss broke loose and ran for the office. He secured a gun and fired at the other as he was coming through the door. The shot proved fatal. The shift-boss was released on \$10,000 bonds, which were furnished by the president of the Pilot Butte company.

At the close of business last month the East Butte company had about \$175,000 cash and copper on hand. The output for February was 1,277,160 lb. compared with 1,060,000 lb. in January. The average copper content of the ore being mined now is considerably less than that extracted in 1915. However, with the 20% increase in production, the company should show a profit of \$100,000 per month, at the present price of copper. The ore developed at 1500 ft. is of higher grade than that at 1200 feet.

About 150 tons of ore per day is being shipped from the Bullwhacker to the Tacoma smelter. The ore contains about 1% copper, which occurs as chrysocholla. Ore extends close to the surface, and the glory-hole system of mining is employed. The west wall caved-in recently, and several hundred tons of ore fell to the bottom. The accident occurred between shifts and no one was injured.

JOPLIN, MISSOURI

NORTH WEBB CITY MILL TO BE MADE ONE OF THE LARGEST IN THE DISTRICT.—SLUDGE DEPARTMENT OF LARGE CAPACITY AT A. W. C. No. 4.—DRAINING AURORA LAND, AND LARGE DIKE TO PROTECT MINES.

The Hurry Up Mining Co.'s old 300-ton concentrating plant, in the north Webb City district, is to be dismantled and replaced with a practically new one of 400 tons' capacity per 10 hours. The mill is one of the pioneers of the North Webb City field, having operated almost continuously since it was erected 10 years ago. During periods of both high and low ore prices the plant has been a steady producer and in recent months, since prices have been so high, has been working double shift. The re-constructed plant will be equipped with rougher-jigs, one cleaner-jig, crushers and rolls, tailing-elevators, everything being new except the framework of the plant. In addition to the new machinery at the mill the company will begin hoisting ore from what is known as the Florence shaft, 1000 ft. northeast of the mill. Work of construction on the mill and tramway and on a new 1200-ton hopper at the mill will be started the middle of April. Electric power will be used. The company is operating in a sheet-ground district where the recovery of blende and galena average between 2 and 3 per cent.

One of the largest sludge-mills of the district is being constructed by the A. W. C. Mining Co., in conjunction with the work of building its new No. 4 plant, on a 160-acre lease of the Luke land, in the west Joplin district. The sludge department is 200 ft. east of the mill, and slime will be fed by launders from the main plant. Sludge first passes into a 10 by 40-ft. concrete settling-tank, after which it goes to a 36-ft. Dorr thickener. There will be 11 tables in the sludge department. The No. 4 mill is the fourth of a series of plants to be built by this company. Work of construction on this mill was under way before the transfer of the property, several weeks ago, for \$200,000, to Gibson and associates. The mill will have a capacity of 400 tons a shift, and will be operated full time. Electric power will be used throughout. A double-compartment shaft, 7 by 12 ft., will supply ore, which comes from

sheet ore formation at a depth of 120 ft. The plant has two rougher jigs, one cleaner, one 18 in. breaker, one set of 24 in. rolls, and two sets of 36 in. rolls. The mill is in a district that has commanded considerable attention recently. A short distance to the north is the Samson mine, recently purchased by W. Kenefick for \$125,000. Immediately to the north east is the Gibson mine, and to the east are the S. V. Ramage and the Once More mines, all of which are equipped with large concentrating plants. A few years ago no development was under way in this particular part of the field, the ore generally being too thin to operate at existing low prices.

A 10-acre tract of the United Zinc Co.'s land at Aurora, that has been under water for more than a month, is now being drained with a 10-in. Texas pump installed by W. H. Hunter, of Aurora. More than a dozen small operating companies are awaiting the drainage of the land before resuming work. Although each mine is of comparatively small importance in itself the combined output from all the properties has made the tract a big producer. Heavy rains recently caused every mine on the land to be flooded. The work is conducted at varying levels, no mining having been undertaken below a depth of 100 ft. Much of the ore consists of calamine and lead, occurring at shallow levels, some of the mining being done within 25 ft. of the surface.

Lead and calamine in soft ground are indicated in recent drilling on the Rose land, south of Joplin, and following these drill-strikes a new shaft is being sunk. It is now down 109 ft., and is expected to open 'pay-dirt' at a depth of 125 ft., extending down to 135 ft. In this company are James Clark, Jake Warren, J. B. Avery, and A. S. Baldry. The development of shallow mines in the south Joplin field is becoming extensive, and many good discoveries have been reported recently.

Plans for the building of a 1200-ft. dike on the United Zinc Co.'s land at Peacock, 5 miles north-west of Joplin, have been altered somewhat and much more money is now to be spent in this work than at first proposed. Instead of constructing an earth and rock dike, the new work will consist of concrete, the wall being 3 ft. wide at the base, 1 ft. wide at the top, 12 ft. high, and 1200 ft. long, protecting the mining ground from flood waters of Spring river and Center creek. A. B. Bensch, of New York, has acquired a lease on 493 acres of the United Zinc Co.'s land at this point, and has installed two large Texas pumps, and will put in another in the near future. All the pumps are to be operated by electricity. Several weeks will be spent in draining the old Peacock mines, which were highly productive from 1899 to 1909, but which have not been in operation for a number of years. Mr. Bensch plans to begin the construction of a large concentrating plant in the near future.

PETROGRAD, RUSSIA

CONDITION OF RUSSIAN GOLD DREDGING IN 1914.

The report on gold and platinum dredging in Russia during 1914 has been issued by the Consultative Committee of the Gold and Platinum Producers. It is somewhat briefer than usual, excepting the tabular matter, which gives many details. It is stated that the question-forms issued by the Committee were filled and returned by 13 gold-producing concerns controlling 58 dredges, three more boats than in 1913. There was an improvement in particulars given on 53 boats, five more than in the report of 1913. Four companies failed to make any returns at all, namely, the Moscow Timber Co., the Orsk Gold Co., the Northern Yenissei Gold Co., and the Spassky. As was to be expected, the time worked was short of that in the preceding year, though certainly not so far below as a state of war might have justified. The hours worked were 2951 per dredge compared with 3302 in 1913, and 3437 in 1912. The quantity of gravel washed shows a reduction that is a fair proportion compared with peace times. What is perhaps more surprising is that the returns in gold and platinum, though of course lower than those in 1913, are

relatively higher per dredge and in total. The quantity of gravel washed per dredge was 18,451 cubic sajenes (1 sajene = 7 feet) in 1914, against 19,502 in 1913 and 16,806 in 1912. The resulting production of gold per dredge was R92,860 (1 ruble = about 50 cents) in 1914, against R92,360 in 1913, and R84,200 in 1912. The reduction in working hours per dredge made 10.6%, but the average gravel washed and the average precious metal produced made respectively a reduction of 5.39%, and an increase of 0.5%. The total quantity of gold and platinum produced by the dredges in Russia and Siberia in 1914 showed a decline of R149,730 compared with 1913, making a reduction of about 2.5%. The grand total of gold and platinum produced from 58 dredges according to the table made R5,205,290. But dealing only with the 53 dredges, respecting which complete details are available, the quantity was R4,921,580; or an average of R92,860 as is stated above. The results per dredge for previous years have been given for purposes of comparison, but one need only say that in 1910, when the result was R73,000, and again in 1906, when the result per boat was no more than R54,100. This, as can be understood, does not necessarily indicate increased efficiency to the extent of the difference between the figures of 1906 or 1910 and 1913, because the dredges now at work are considerably larger.

The vexed question of duty or no duty on imported dredges or parts thereof, and sinking apparatus, is always being discussed by mining men on the one hand, and the advocates of Government revenue on the other; but an important decision has been taken by the Committee not long ago appointed to examine the conditions of the Russian gold industry, with the object of suggesting measures for its extension and improvement. It is now announced that the Committee has taken at least one important step, and has resolved that it is now time and would be of great advantage for the development of the industry, and for the increase of the gold reserves of the Russian empire, to establish for 10 years from the day that peace was arranged, the duty-free importation of dredges or parts thereof, or apparatus for investigating gold-bearing areas. At present immense areas of low-grade sands are allowed to lie unexploited, which might give Russia the gold which is so necessary at all times, especially at present. The Gold Industries Committee on its part is taking advantage of the new situation, and is giving evidences of energy and enterprise in the sense that it would place the dredging business in Russia on such a level as would insure the production not of R4,232,000 or R6,348,000 of gold, but many times this value. The concession to the gold industry indicated would make Russia a great market for dredges as well as parts thereof, and at the same time would stimulate the domestic factories to develop the cheap, rapid, and extensive and modern construction of gold-dredging machinery and accessories. It may be mentioned that the guiding hand in the Committee is D. E. Konovaloff, who thoroughly understands the business.

It may be mentioned that, in consequence of the loosening of organization, which naturally accompanies war conditions in distant industrial centres, the clandestine removal of gold has become a grave question. In past years it was well-known that considerable quantities of metal was being removed from the country by improper means, and it is found that in 1914 this had increased considerably, also in 1915. How this affects the question of the registration of gold and platinum will no doubt be made clear later on, but it is obvious that registration is not a complete remedy for what must always be a strong temptation in the goldfields.

SILVER LAKE, CALIFORNIA

NOTES ON MANGANESE DEPOSITS.

About 30 miles west of the Tonopah & Tidewater railway, with which it is connected by a fair wagon-road, is the Owl Head manganese mine. The nearest post-office is at Silver Lake, in San Bernardino county, 45 miles distant. A 30-hp.

caterpillar tractor of 20-ton capacity hauls ore to the line, making a round trip in 30 hours. The present output is 200 tons monthly. The property is at an elevation of 2000 ft. above sea-level. The deposit was discovered by R. L. Mann, the owner, in 1911. The accompanying section illustrates the

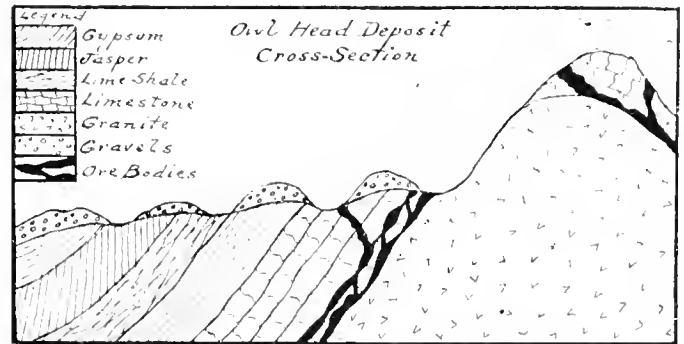

SKETCH SHOWING OCCURRENCE OF MANGANESE.

geologic conditions. In what may be called 4 "ore occurrences" are 10 deposits of manganese of various lengths and thicknesses. The product sent to market contains 76.80% manganese dioxide, 6.56% manganese oxide, 3.93% barium oxide, 0.022% phosphorus, 3.58% silica, 1.12% ferric oxide, 1.03% alumina, 2.85% lime, 1.45% magnesia, and 2.6% moisture, etc. There is also in reserve a large quantity assaying 45% metal, with less than 3% iron, 5% silica, and 0.02% phosphorus.

CRIPPLE CREEK, COLORADO

GOLD YIELD IN MARCH.—TUNGSTEN EXCITEMENT.

Gold output from the mines of the Cripple Creek district in March, as reported by the mills and smelters, is as follows:

| | Tons | Average value | Total value |
|--|--------|---------------|-------------|
| Golden Cycle, Colorado City..... | 35,000 | \$18.00 | \$630,000 |
| Portland, Colorado Springs..... | 11,500 | 23.10 | 264,500 |
| Portland-Victor mill, Cripple Creek.. | 17,500 | 3.17 | 55,475 |
| Portland-Independence, Cripple Creek.. | 14,900 | 2.03 | 30,247 |
| Isabella, Cripple Creek..... | 2,160 | 2.40 | 5,184 |
| Caley-Jerry Johnson, Cripple Creek.. | 1,312 | 4.50 | 5,904 |
| Smelter, Denver and Pueblo..... | 4,300 | 55.00 | 236,500 |

Total86,672 \$14.17 \$1,227,810

On April 10 the Golden Cycle paid its monthly dividend of 2c. per share, equal to \$30,000.

The March production from the Beacon Hill estate of the El Paso Consolidated is reported as being 2900 tons. This is the largest quantity recorded for any month in over three years. With the starting on April 1 of the split-check system for lessees, optional with them, the output is expected to be considerably increased.

Much interest has been aroused in the district by the report of a rich tungsten discovery between Dale and Wilbur, about 10 miles south-east of Victor. A trial shipment of between 250 and 275 lb. of wolframite, said to contain from 60 to 72% of tungstic trioxide, has been tested here and sent on to Denver for further analysis. The Wolframite Gold Mining Co., a Colorado corporation with offices at Wheeling, W. Va., controls the claims where this ore was found. Gold, silver, and copper are also in the ore. Some of the old time excitement prevails among prospectors; many have set out on foot with pack-horses or burros to locate claims and obtain leases from the ranchers who own the land near the find. Quite a few claims have already been located, but weather conditions lately have somewhat delayed the fortune-seekers.

THE MINING SUMMARY

The news of the week as told by our special correspondents and compiled from the local press.

ARIZONA

In Bulletin No. 17 of the State Bureau of Mines, A. C. Rubel discusses coal in Arizona. This mineral is found in the Deer Creek field of eastern Pinal county, and the Black Mesa field of Coconino, Navajo, and Apache counties. The coals are not of high grade, and generally considered the deposits are not likely to be worked in the immediate future.

GREENLEE COUNTY

On March 29 the employees and the Arizona, Detroit, and Shattuck companies signed an agreement covering general rules for working conditions, grievances, and wages in the Clifton-Moreno-Metcalf district. It is to be printed in English and Spanish, and is about 1000 words in length.

At 100 ft. and 800 ft. in the Shattuck-Arizona 7% and 6% copper ore has been opened. The daily output is 150 tons of lead and 550 tons of copper ore.

MOHAVE COUNTY

As depth is reached in the Oatman district water is encountered, and at 500 ft. up to 1000 gal. per hour is the flow. Pumps are to supersede bailers. The water is of good quality for domestic and mine use. Water supply has been a problem, and this will help, aided by the piped supply from the Colorado river, 12 miles distant.

YUMA COUNTY

According to the *Parker Post* there is unusual mining activity prevailing in the northern part of this county.—The Empire-Arizona is shipping by auto-truck to Parker.—Development is reported as good in the Billy Mack and Zerolite-Mammon mines.—The Swansea made a profit of \$22,000 in February from 4% copper ore. A large orebody has been opened.—The Planet is shipping 40 tons of 18% ore daily per motor-truck to the railway.—Manganese claims on the Planet range are to produce 200 tons a day. They are 8 miles from the railroad.

CALIFORNIA

AMADOR COUNTY

(Special Correspondence.)—The Amador Star Mining Co., 3 miles north of Plymouth, is sinking a vertical 3-compartment shaft to 500 ft. and will then cross-cut to the vein at that depth. The property is equipped with a steel head-frame, 200-hp. electric hoist, and air-compressor. This was formerly known as the Rhetta mine. Bayliss C. Clark is superintendent.

The old Orr or Creek Ledge mine prospecting shafts are being unwatered for sampling and exploration. This work is being done by the Plymouth Consolidated company or kindred interests.

Plymouth, March 29.

The Plymouth company has raised wages 25c. per shift, effective April 1.

BUTTE COUNTY

As the electric properties of the Oro Water, Light & Power Co. have been absorbed by the Pacific Gas & Electric Co., its dredging department is to be transferred to a new company, the American Gold Dredging Co. The Victor dredge of the company near Oroville sank on April 5. It had nearly completed digging a small area, and was then to be dismantled.

CALAVERAS COUNTY

(Special Correspondence.)—The Vanciel brothers are open-

ing the Star and Excelsior mines at Eugene. These properties produced a good deal of gold and copper years ago.—The McNulty mine, owned by the Malsplna brothers, joins this property on the south. All have production records, back in the sixties, when ore was shipped to Swansea, Wales. With the present high price of copper, and enough working capital it is expected these mines will soon be among the regular producers.

Eugene, March 25.

(Special Correspondence.)—Coughanour and Olesen and others are operating the Napoleon mine. An oil-flotation plant, with a capacity of 50 tons per day, is treating the ore, which is crushed in a Hendy ball-mill through a 60-mesh screen, 80% passing 80-mesh. The owners are working on ore left by early operators, when the best was hand sorted and shipped to Swansea, Wales, for treatment.

Copperopolis, March 25.

(Special Correspondence.)—At the Mountain King mine, sinking is proceeding from the 500 to the 700-ft. level. The vein, followed by the working shaft, lies at an incline of 30° to the east, and at the bottom of the shaft, shows a width of 7 ft. of good ore. Work is done with electric power. A 10-stamp mill will be kept crushing ore from the bottom of the shaft. C. M. Brown is superintendent.

Hodson, March 27.

(Special Correspondence.)—The Gray Lead mine has been sold by T. Porteous to S. F. Johnson and others of New York. This mine was once a good producer, and has been opened at depth by a cross-cut adit, exposing a good vein. Assays returned \$166 over a width of 18 in. A recent mill-run by lessees on another vein of this property averaged \$70 per ton.

The Zacaterre mine, in which sinking has been in progress, is opening satisfactorily. A quartz vein, 12 to 24-in. wide, assaying \$40 per ton, has been exposed in the shaft. T. Porteous' stamp-mill has been leased by the Zacaterre people.

At the Deerfoot mine sinking has been done, good-grade ore being opened.

West Point, April 5.

INYO COUNTY

As soon as the Wilshire Bishop Creek mine can be financed work will be resumed and the mill enlarged to 150-ton capacity. The Consolidated Wilshire Mining Co. has been formed to do this.

Fourteen tungsten claims 8 miles west of Bishop have been sold to A. J. Clark of Los Angeles. Fully \$40,000 must be spent before production commences. A mill will be erected.

During the five months ended February 29 the Cerro Gordo Mines Co.'s profit was \$40,250. Shipments of 1000 tons of zinc ore monthly are being made.

NEVADA COUNTY

For \$25,000 the Columbia Consolidated Mines Co., managed by E. C. Klinker, has purchased the claims of the late Fritz Meister, on Canyon creek, three miles above Washington. A working arrangement has been made also with the Ocean Star owners, whose property adjoins the Columbia. The two 10-stamp mills will be started.

The Texas, Guild, and Niagara quartz mines in the Willow Valley district have been bonded to W. H. Tuttle of Reno. The first has a 515-ft. shaft and 10-stamp mill.—The Montana, Willow Valley, Buckeye, Cold Springs, Benton G., and

Lone Star claims, of 1000 acres, were recently consolidated here.

The North Star Mines Co. has declared its regular quarterly dividend of \$50,000.

Owners of the Union Hill mine were recently paid another installment of \$25,000 on the purchase price of \$79,000 by the present operators.

During the year ended March 1, 1916, the Golden Center of Grass Valley Mining Co. did 2200 ft. of development; crushed 7969 tons of ore; recovered gold worth \$112,352 and concentrate valued at \$21,638, a total of \$133,991, an average of \$16.81 per ton; paid \$58,000 for property, etc.; erected plant costing \$35,401; made a profit of \$49,843; and paid \$21,990 in dividends. Good developments are expected during the current year. C. A. Brockington is superintendent. Additions are to be made to the mill, and a cyanide plant has been designed.

PLACER COUNTY

The Live Oak, Big John, Red Bird, Black Oak, and Annie Laurie mines, near Colfax, are being re-worked.

SAN BERNARDINO COUNTY

Near Danby the Gold Reef Mining Co. has acquired title to extensive holdings in a promising district. It has adopted the leasing system of development. Leases are limited to 500 ft. along the lode, but lessees are not restricted to one lease. Work must be done continuously. The conditions of leases are 10 years at 10%, with privilege of renewal. All original development costs are to be returned to lessees from output before royalties accrue. Therefore money goes into the ground and must come out again before the holding company participates. The lodes are said to be of the Oatman character. A report has been made by Ellis Mallery.

SHASTA COUNTY

During March the Mammoth Copper Co. shipped 2500 tons of 40% zinc ore to Kansas smelters.

TRINITY COUNTY

Two thousand acres of gravel claims near Hayfork have been bonded to E. T. Wiltsee for \$50 per acre. Drilling has commenced in charge of J. A. Scott of San Francisco. 'Pay' is 12 to 18 ft. deep, and averages 6c. per yard. A large dredge is contemplated.

TUOLUMNE COUNTY

(Special Correspondence.)—A company operating in this county is negotiating to acquire the Dreisam mine, at Arastraville. It is expected that the deal will be consummated within a few days, and that the mine will be re-opened without delay.

The Pine Log Gold Mining Co., composed of residents of Stockton, will shortly begin mining operations on the south fork of the Stanislaus river, just below the mouth of Five-Mile creek. The property, acquired under lease from a San Francisco company, is a bar that was partly worked in the early days with good results. A wagon-road is being constructed to facilitate the transportation of machinery and supplies. A steam plant and pump will be installed as soon as possible, and if the water cannot be handled in this manner a dam will be constructed across the river and the stream conveyed to a point below the property in a flume. Henry W. Schroeder will direct operations.

A Cameron pump with a capacity of 400 gal. per min. is being installed on the 500-ft. level of the Rawhide mine.

Considerable new machinery has been erected at the Dutch-Sweeney mines since the properties were taken by the present operating company. A residence for W. J. Loring, the general manager, has also been built. The extraction of ore and the development of new orebodies is giving employment to a large number of men, and results are said to be highly satisfactory. The group includes the Dutch, Sweeney, and App mines.

The Shore and Oliver mines, situated on Table mountain,

near Jamestown, have been bonded to A. M. Hennessy, of San Francisco. Work must be commenced within 60 days, by the expiration of which time a substantial payment is to be made.

Fred Stucki is developing a vein 18 to 48 in. wide near the Mohican mine, which yields \$10 gold per ton.

Fifty tons of high-grade ore from the Live Oak mine is being treated at the Black Oak. The operators, Stage and Blackburn, expect to be milling from 50 to 100 tons per month in the near future.

Sonora, March 27.

YUBA COUNTY

A dredge for the Guggenheim interests will soon be constructed between Hammonton and Park's Bar bridge, opposite Brown's Valley, as a spur track is being laid to the Yuba

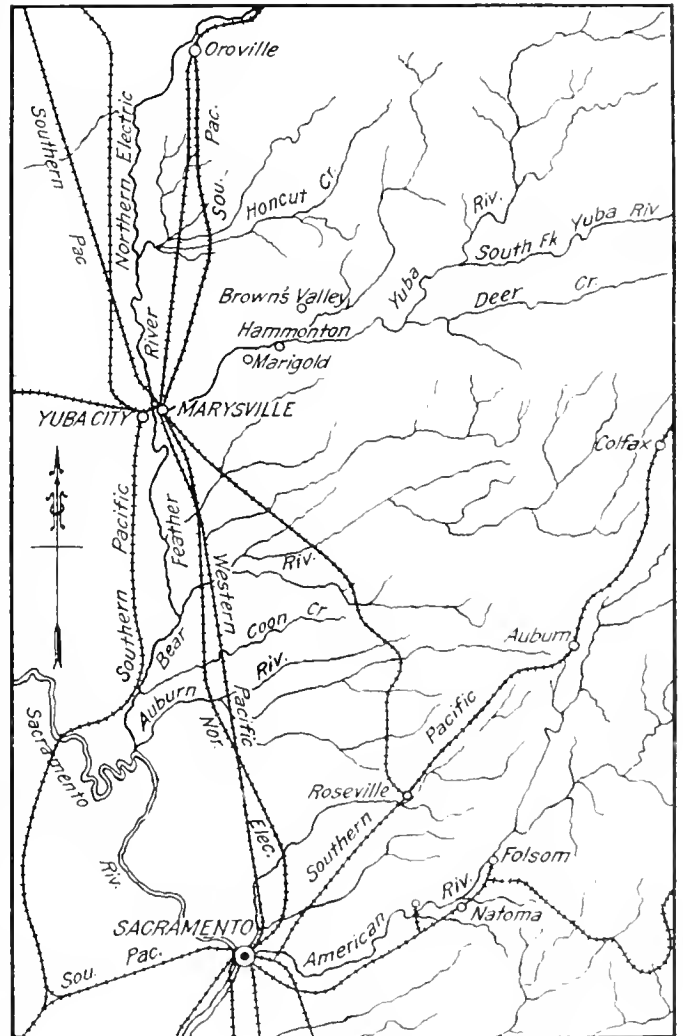

MAP SHOWING OROVILLE, YUBA RIVER, AND NATOMA DREDGING DISTRICTS OF CALIFORNIA.

river by the Southern Pacific company. The boat is on its way from the East. Other dredging companies on the Yuba are the Marysville at Marigold and Yuba Consolidated at Hammonton.

One hundred tons of chrome-iron ore daily is being extracted from the Woodleaf Canyon mine in the northern part of this county. A. Brendt is in charge of 50 men.

COLORADO

BOULDER COUNTY

The Omaha tungsten claims of C. C. Ficco on Boulder creek have been sold to Kansas City people for \$60,000.

A mill to cost \$50,000 is to be erected in Boulder canyon by the Tungsten Metals Corporation of Boulder, which has acquired several properties.

The Boulder Tungsten Production Co. is to rebuild the Coburn mill at Eagle Rock, making it of 50-ton capacity. John G. Clark is in charge.

DOLORS COUNTY

After having its property worked by lessees for a long time the Rio Mining Co. has resumed operations on its own account at Rio.

LAKE COUNTY (LEADVILLE)

On April 2 fire at Leadville destroyed city property valued at \$50,000.

The Robert Emmet, Forest City, Result, Gonabrod, and Ranchero claims of the Small Hopes-Boreel Mining Co. in Stray Horse gulch have been sold for \$500,000 to the Empire Zinc Co. The property has been worked through the Robert Emmet shaft. High-grade zinc-lead-silver ore occurs at 600 ft., and recent production has been over 1000 tons per month. Several shafts in this area are down 1000 ft., and some are 1350 ft. deep. The new owner is to unwater the shafts. The Small Hopes company is composed of well-known business and mining men, with Frank Zaitz as president.

As at the Penrose shaft of the Down Town company a pump-motor at the Harvard shaft of the U. S. S. R. & E. Co. burned out last week, delaying unwatering somewhat. Peculiar conditions are responsible for this trouble.

OURAY COUNTY

During February the Camp Bird made a profit of \$36,000 from 2320 tons of ore.

Thirty inches of good copper ore has been opened in the 1000-ft. adit of the Calliope claims, four miles south-east of Ouray. The Harper-Larson Development Co. is doing the work.

Some high-grade tungsten ore is being mined near Ironton.

MISSOURI

JASPER COUNTY

During the last week of March there was little change in the ore market at Joplin; prices ranged from \$85 to \$115 per ton for 60% zinc product. The Missouri-Kansas-Oklahoma region produced 1683 tons blende, 409 tons calamine, and 1375 tons lead, averaging \$100, \$84, and \$99 per ton respectively. The total value was \$850,768. The principal producing areas were Webb City-Carrerville, 2661 tons blende and 643 tons lead; Joplin, 1902 tons blende and 110 tons lead; Duenweg, 685 tons blende; Galena, 556 tons blende and 83 tons lead; Miami, 385 tons blende and 385 tons lead; and Oronogo, 317 tons blende and 74 tons lead.

MONTANA

GALLATIN COUNTY

Through the efforts of Thomas Michner of Salesville, the holdings of the principal placer mining companies in the Gallatin valley, near the Yellowstone National Park, comprising approximately 6000 acres, have been taken over by the Gallatin Gold Dredging Co., a corporation recently organized at Spokane, capitalized for 2,000,000 shares at \$1 each. Directors of the new concern are Dr. William B. Pickrell, Dr. Frederick Eppen, and George Harding, Spokane; H. D. Chapman, Chicago; H. M. Rhelling, Denver; and Mr. Michner. It has taken Mr. Michner six years to consummate this deal. The ground, comprising one of the richest placer fields in Montana, has never been worked, except at the lower end, where considerable coarse gold was found, leading those who have examined the deposit to think that good gravel will be encountered all the way up the stream. The pay-gravel is from 300 ft. to half a mile wide, and extends 22 miles down the west fork of the Gallatin river from a point near the north-east corner of the Yellowstone Park. Half of the stock of the Gallatin Gold Dredging Co. has been taken over by Dr. Pick-

rell, Mr. Chapman, Mr. Harding, and Mr. Rhelling, who will supply the money to thoroughly prospect the holdings and later to install dredges to work the deposit. The corporation takes over the properties of the Eureka Development and Hercules Dredging companies, comprising 1200 acres of patented and 4800 acres of unpatented land, much of which is exceptionally well suited to dairying and stock raising. The agricultural area will be leased from the company by Mr. Michner and associates, who will embark in the livestock business as a side issue, as there is a large territory adjacent that can be used for open range.

SILVERHAWK COUNTY

The Butte-Detroit Copper Co. is being organized with a capital of 2,500,000 \$1 shares, which are offered to the public at 70c., to operate the Ophir mine at Butte. The shaft is to be sunk from 1000 to 2000 ft. W. L. Cruden of Butte is managing director, with Sir Henry Pellatt and Sir Frederick Borden on the board of directors.

The Pilot-Butte property of 5 acres has been finally sold to the Anaconda company for \$1,100,000. This gives the late shareholders \$12.50 per share. The mine is opened to 2600 ft. Considerable zinc ore occurs.

The Butte-Alex Scott company is being liquidated, and shareholders will receive \$10.50 per share for the first distribution. The property was purchased by the Anaconda.

Liabilities of the Butte & Duluth Mining Co. are \$42,369 for wages, \$118,628 for accounts payable, and \$500,000 outstanding bonds.

The Butte & Bacon company is to be reorganized, by forming the Great Butte Copper Co. with a capital of \$1,000,000 in \$1 shares, with exchange of shares and sale of 400,000 at 66c. each. The Calumet shaft of the Butte & Anaconda will be purchased for \$19,000, and exploration commenced at a depth of 1500 feet.

The du Pont Powder Co. has purchased 1200 acres of land near Butte on which to erect a dynamite plant costing \$500,000. This will supply explosives for mines in Idaho, Montana, and Utah. Increased mining activity decided the company to construct this plant. Nitrate will come from Chile, while acid will be secured at Butte from the smelters.

NEVADA

ESMERALDA COUNTY

Gold-copper ore of fair grade has been opened in a number of workings of the Florence Goldfield.

In raises put up above the 1175-ft. level of the Sunflower claim of the Merger company, the shale-lattice contact has been opened 5 to 20 ft. above the cross-cuts, but shows no commercial ore.

The Jumbo Extension continues to ship 100 tons daily, some good ore coming from the 800-ft. level. Exploration at 890 ft. at the Velvet shaft is in virgin ground, and results are watched with interest. The main east cross-cut at 1017 ft. is being driven to the Velvet.

Drilling is in progress at 700 ft. in the Silver Pick.

The 50-ton flotation plant of the Nevada Metal Extraction Co., on foundations of the old Florence Goldfield mill, is ready for work. A. F. Mead is in charge.

At the Pioneer, 60 miles south of Goldfield, the mill is treating up to 40 tons per day. A rich shoot was recently opened at 170 feet.

The estimated production of the Goldfield Consolidated company for March is as follows:

| | |
|--------------------|-----------|
| Ore mined, tons | 30,000 |
| Gross extraction | \$210,000 |
| Operating expenses | 156,000 |
| Net realization | \$ 54,000 |

The 50-ton flotation plant is recovering 92% of the gold and 99% of the copper. This is so satisfactory that a 500-ton unit,

of 24 Callow cells and accessories, has been ordered. This will cost \$18,000. The flow-sheet is extremely simple. Concentrate is to be treated as at present. Coal-tar, creosote, and pine-oil are used, costing 8c. per ton treated.

The Booth company is paying 10c. a share, or \$100,000, on April 26. This is from cash on hand, not from mining operations.

ELKO COUNTY

Mines at Jarbidge now show more ore developed than before, and additions to mills are contemplated. Operators are arranging with county officials to co-operate in constructing a good road from Elko to Jarbidge, to be serviceable in all seasons.

NEW MEXICO

DONA ANA COUNTY

The Bennett-Stephenson, Memphis, Torpedo, and all the principal properties from the Modoc to the Excelsior in the Oregon Mountain district, have been bonded to Phelps, Dodge & Co., for \$1,500,000. These mines have produced a good deal of lead, silver, copper and zinc ores. Development has been spasmodic in recent years.

OKLAHOMA

OKMULGEE COUNTY

A zinc smelter is being constructed at Henryetta by the Pieher Lead Co. of Joplin, Missouri. It will have 3200 retorts, and is to cost around \$225,000.

SOUTH DAKOTA

LAWRENCE COUNTY

A site for a mill is being examined by the Oro Hondo company.

To treat the low-grade wolframite in its Golden Summit claim the Homestake company is to erect a concentrating plant. This will consist of 5 stamps, a Wilfley table, and Deister slime-table, able to treat 20 tons a day. The mill is expected to be ready late in May. The Golden Summit deposit is an arc-shaped flat body, 8 to 10 in. thick at the centre, tapering to the ends, the whole being 4 to 6 ft. wide. It is persistent.

The Columbia mine at Keystone was recently examined by R. Blackstone of the Homestake company.

Two weeks ago the Wasp No. 2 company dispatched tungsten ore and concentrate valued at nearly \$100,000. The average per unit of 20 lb. was \$82. Some of the ore contained 15%, and concentrate 63%.

Fluorite, used by steel and glass manufacturers, has advanced to \$12 per ton, causing the Echo Mining Co. in the Maitland district to increase its operations.

UTAH

JUAB COUNTY

The Colorado and Beek Tunnel companies are to be merged under the name of Colorado Consolidated Mining Co. The mines have produced \$5,200,000 and \$2,000,000, and paid \$2,600,000 and \$675,000 in dividends, respectively. The metals produced are lead, silver, copper, and gold.

Up to 60% manganese ore has been opened at 225 ft. in the Tintic Delmar mine.

MEXICO

The trouble in Mexico effected mineral shipments across the border of the United States during March; these consisted of \$143,800 gold, \$348,700 silver, and \$1,857,500 copper. Nacozari sent 10,028 tons of copper ore and concentrate, and El Tigre 220 tons of silver concentrate and some cyanide bullion.

HIDALGO

Profit of Santa Gertrudis from 20,944 tons in February was \$86,400.

PERSONAL

Note: The Editor invites members of the profession to send him particulars of their work and appointments. This information is of unquestioned interest to our readers.

JOHN BALLOT is at New York.

F. H. HAMILTON is at Toronto.

F. O. WILLIAMSON of Chicago is in San Francisco.

WALTER STRACHE has returned to New York from Brazil.

DAVID T. DAY of Washington, D. C., is at the Palace hotel.

RAUL MADERO is in New York; JULIO MADERO is in Jalisco.

W. B. DENNIS has returned from New York to Carlton, Oregon.

ARTHUR W. STEVENS is at Denver, on his way to Leadville and Ouray.

E. B. THORNHILL has joined the staff of the Metals Recovery Co. at Cobalt.

REN TAYLOR is manager at the Wettlaufer mine, South Lorrain, Cobalt.

LEO VON ROSENBERG was in the Ray and Prescott districts, Arizona, recently.

A. H. BROWN has resigned as manager of the Hudson Bay Mines, Ltd., at Cobalt.

F. H. DAKIN, superintendent of the Gray Eagle copper mine, in Siskiyou county, is here.

G. A. JOSLIN has left the Ray Consolidated and is in Kansas City on professional business.

A. FREITAG, superintendent for the Nevada Packard Mines Co. has returned to Rochester, Nevada.

WALLACE E. PRATT has resigned from the Philippine Mines Department to engage in private practice.

FRED. G. FARISH, manager for the Lluvia de Oro Mining Co., is living for the present at San Diego, California.

H. FOSTER BAIN, editor of *The Mining Magazine*, is on his way to Johannesburg to study conditions on the Rand.

A. W. OLIVER, cashier of the Eagle Ore company, has been appointed general manager. KARL V. SIMPSON succeeds Mr. Oliver at Cripple Creek.

ED. C. MORSE left for Alaska April 3 to resume charge of the 40-ton quartz mill of the Princeton Mining Co. at Dolomi, on Prince of Wales Island.

T. S. O'BRIEN, formerly general manager for the Original Amador Mines Co., has joined the staff of the Joshua Hendy Iron Works of San Francisco.

JOHN F. HAYLORD, director of the engineering college of the Northwestern University, will deliver the address to the graduating class of the Michigan College of Mines.

J. W. WHITEHURST has returned to San Francisco from Contra Estaca, Sinaloa, Mexico. He leaves for Salida, Colorado, where he will be for the next two months, after which he will return to Mexico.

GEORGE M. TAYLOR, general manager of the Portland Gold Mining Co.'s mills at Cripple Creek and Colorado Springs, recently gave an address on tungsten before the Chamber of Commerce at the latter place.

FRANK A. ROSS of Spokane was honored at the recent inauguration of Dr. ERNEST O. HOLLAND as President of the State College of Washington, by having conferred upon him the degree of Master of Science in engineering "in recognition of his service to the mining industry of the great West."

W. S. HOLLOWAY has been awarded the military cross for conspicuous gallantry during mining operations. The official notification says: "Whilst endeavoring to rescue an officer who had been incapacitated he was buried by a fall of earth and timber. He succeeded in extricating himself, and eventually reached and dragged the incapacitated officer to a place of safety." Mr. Holloway was in charge of the Gwendoline mine in Korea for Jardine Matheson & Co., and is serving as lieutenant with a tunnelling company of the Royal Engineers.

THE METAL MARKET

METAL PRICES

San Francisco—April 11

| | |
|--|-----------|
| Antimony, cents per pound | 44 |
| Electrolytic copper, cents per pound | 29 |
| Pig lead, cents per pound | 8.00-8.80 |
| Platinum, soft metal, per ounce | \$88 |
| Platinum, hard metal, 10% iridium, per ounce | \$92 |
| Quicksilver, per flask of 75 lb. | \$1.12 |
| Spelter, cents per pound | 22 |
| Tin, cents per pound | 46 |
| Zinc-dust, cents per pound | 30 |

It is semi-officially announced in Petrograd that the Russian government's proposed monopoly of platinum will not take effect. Russia produces 93% of the world's total.

ORE PRICES

San Francisco, April 11.

| | |
|---|-------------|
| Antimony, 50% product, per unit, of 17, or 20 lb. | \$2.25 |
| Chrome, 40% and over, f.o.b. cars California, per ton | 12.50 |
| Magnesite, crude, per ton, f.o.b. | 8.00 |
| Magnesite, plastic, no iron and lime, calcined, ton | 25.00-30.00 |
| Magnesite, refractory, 11% iron, dead-burned, ton | 35.00 |
| Manganese, 50% metal, 8% silica, per ton | 12.00 |
| Tungsten, 60% W/O, per unit of 20 lb. | 65.00-75.00 |
| Vanadium, 10% vanadic oxide, per lb. | 0.50 |

A 10% premium is being paid on the \$75 per unit schedule by the principal tungsten buyers at Boulder, Colorado.

Wolframite of various grades from the Wasp No. 2 mine, South Dakota, recently averaged \$82 per unit; the total was nearly \$100,000.

New York, April 5.

Antimony, 50 to 100-ton lots, forward price per unit, \$2.60.

EASTERN METAL MARKET

(By wire from New York.)

April 11. Export sales caused advances in copper; lead is dull, spelter is strong, though less active.

SILVER

Below are given the average New York quotations, in cents per ounce, of fine silver.

| Date | Average week ending |
|------------|---------------------|
| Apr. 5 | 61.62 |
| " 6 | 61.75 |
| " 7 | 61.62 |
| " 8 | 61.75 |
| " 9 Sunday | |
| 1915 | 62.25 |
| 1916 | 62.50 |

Monthly averages.

| 1914 | 1915 | 1916 | 1914 | 1915 | 1916 |
|------|-------|-------|-------|-------|-------|
| Jan. | 57.58 | 48.85 | 56.76 | July | 54.90 |
| Feb. | 57.53 | 48.45 | 56.74 | Aug. | 54.35 |
| Mch. | 58.31 | 50.61 | 57.59 | Sept. | 53.75 |
| Apr. | 58.32 | 50.25 | | Oct. | 51.12 |
| May | 58.21 | 49.87 | | Nov. | 49.12 |
| June | 56.43 | 49.63 | | Dec. | 49.27 |

Prices continue to rise. Confidence as to the future of the market is felt in London.

Silver worth \$275,000 (299,000 oz.) was sent from San Francisco to the Orient on April 5. Stocks in Shanghai amount to 996 bars and 14,417,000 oz. in specie.

COPPER

Prices of electrolytic in New York, in cents per pound.

| Date | Average week ending |
|------------|---------------------|
| Apr. 5 | 27.00 |
| " 6 | 27.50 |
| " 7 | 27.50 |
| " 8 | 27.50 |
| " 9 Sunday | |
| 10 | 27.75 |
| 11 | 28.00 |

Monthly averages.

| 1914 | 1915 | 1916 | 1914 | 1915 | 1916 |
|------|-------|-------|-------|-------|-------|
| Jan. | 14.21 | 12.60 | 24.30 | July | 13.26 |
| Feb. | 14.46 | 14.78 | 28.62 | Aug. | 12.34 |
| Mch. | 14.11 | 14.87 | 28.65 | Sept. | 12.02 |
| Apr. | 14.19 | 15.24 | | Oct. | 11.10 |
| May | 13.97 | 15.71 | | Nov. | 11.75 |
| June | 13.60 | 15.75 | | Dec. | 12.75 |

U. S. S. R. & M. Co. paid common stock \$1 per share on April 7, and \$7 1/2c. on preferred stock, both quarterly. March production was as follows: Kennecott, 10,150,000 lb. Anaconda,

26,600,000 lb., the largest since March 1912, when it was 26,800,000 lb. The first quarter of 1916 is 25,300,000 lb. greater than in that of 1915. Miami, 4,192,000 lb. Greene Cananea, 5,388,000 lb. Michigan copper country, total of 21,000,000 pounds. Champion pays \$6.40 per share, and United Verde 75c.

LEAD

Lead is quoted in cents per pound, New York delivery.

| Date | Average week ending |
|------------|---------------------|
| Apr. 5 | 8.00 |
| " 6 | 7.75 |
| " 7 | 7.75 |
| " 8 | 7.75 |
| " 9 Sunday | |
| 10 | 7.75 |
| 11 | 7.75 |

Monthly averages.

| 1914 | 1915 | 1916 | 1914 | 1915 | 1916 |
|------|------|------|------|-------|------|
| Jan. | 4.11 | 3.73 | 5.95 | July | 3.80 |
| Feb. | 4.02 | 3.83 | 6.23 | Aug. | 3.86 |
| Mch. | 3.94 | 4.04 | 7.26 | Sept. | 3.82 |
| Apr. | 3.86 | 4.21 | | Oct. | 3.60 |
| May | 3.90 | 4.24 | | Nov. | 3.68 |
| June | 3.90 | 5.75 | | Dec. | 3.80 |

Under certain conditions the Consolidated Mining & Smelting Co. of Canada is paying \$7.25 per 100 lb. to mining companies in British Columbia sending their lead ore to Trail. This is from April 1 to June 30, after which the next three months will be settled for on the basis of \$8.30.

On April 20 the Hecla company of Idaho pays 10c. per share, or \$100,000.

QUICKSILVER

The primary market for quicksilver is San Francisco, California being the largest producer. The price is fixed in the open market, according to quantity. Prices, in dollars per flask of 75 pounds:

| Date | Week ending |
|---------|-------------|
| Mch. 14 | 235 |
| " 21 | 210 |

Monthly averages.

| 1914 | 1915 | 1916 | 1914 | 1915 | 1916 |
|------|-------|-------|--------|-------|-------|
| Jan. | 39.25 | 51.90 | 222.00 | July | 37.50 |
| Feb. | 39.00 | 60.00 | 295.00 | Aug. | 50.00 |
| Mch. | 39.00 | 78.00 | 219.00 | Sept. | 76.25 |
| Apr. | 38.90 | 77.50 | | Oct. | 53.00 |
| May | 39.00 | 75.00 | | Nov. | 55.00 |
| June | 38.60 | 90.00 | | Dec. | 53.10 |

Quicksilver prices continue to sag considerably. Rumor reports that the du Pont Powder Co. has found a substitute for the mercury used in making fulminate for explosives.

ZINC

Zinc is quoted as spelter, standard Western brands, New York delivery, in cents per pound.

| Date | Average week ending |
|------------|---------------------|
| Apr. 5 | 18.00 |
| " 6 | 18.25 |
| " 7 | 18.37 |
| " 8 | 18.62 |
| " 9 Sunday | |
| 10 | 18.75 |
| 11 | 18.87 |

Monthly averages.

| 1914 | 1915 | 1916 | 1914 | 1915 | 1916 |
|------|------|-------|-------|-------|------|
| Jan. | 5.14 | 6.30 | 18.21 | July | 4.75 |
| Feb. | 5.22 | 9.05 | 19.59 | Aug. | 4.75 |
| Mch. | 5.12 | 8.40 | 18.40 | Sept. | 5.16 |
| Apr. | 4.98 | 9.78 | | Oct. | 4.75 |
| May | 4.91 | 17.03 | | Nov. | 5.01 |
| June | 4.84 | 22.20 | | Dec. | 5.40 |

The New Jersey Zinc Co. has declared another extra dividend of 10%, making 24% for three months.

TIN

Prices in New York, in cents per pound.

| 1914 | 1915 | 1916 | 1914 | 1915 | 1916 |
|------|-------|-------|-------|-------|-------|
| Jan. | 37.85 | 34.40 | 41.76 | July | 31.60 |
| Feb. | 39.76 | 37.22 | 42.60 | Aug. | 50.20 |
| Mch. | 38.10 | 48.76 | 50.50 | Sept. | 33.10 |
| Apr. | 36.10 | 48.25 | | Oct. | 30.40 |
| May | 33.29 | 39.28 | | Nov. | 33.51 |
| June | 30.72 | 40.26 | | Dec. | 33.60 |

Tin is strong at 55 cents.

Antimony is firm at 45c. for Oriental metal, duty paid. Aluminum is unchanged at 59 to 60 cents.

Eastern Metal Market

New York, April 5.

During the past few days there has been a heavy business in copper for export. Great Britain and France have been the big buyers, and Russia also is expected to become active. Estimates place the amount taken at 100,000,000 lb. Practically all of the purchasing was for war purposes. The market advanced with the movement, and from 26.87 to 27.50c. was paid for large lots for June, July, and August shipment. The quotation for lead was sagging a week ago, but it braced-up as a result of the action of the A. S. & R. Co. in advancing its price \$10 per ton on March 30. Independents again are asking 8c. at both New York and St. Louis. Zinc is moderately active, prices are a little stronger, and greater activity is looked for. April delivery tin is tightly held because of the continued difficulty in getting licenses to ship from London. The A. S. & R. Co. announces that it is ready to supply small quantities of domestic refined tin for experimental purposes, after which it will consider contracts at prices based on average quotations. Antimony and aluminum are unchanged.

The pig-iron production in March was 3,337,691 tons, or 107,667 tons a day, against 3,087,212 tons in February, equal to 106,456 tons daily. It thus will be seen that it is now being produced at a rate equal to 40,000,000 tons yearly, while steel ingots are made at 43,000,000 to 44,000,000 tons a year.

COPPER

Since March 28 an enormous business has been done in electrolytic copper for June, July, and August delivery, at prices ranging from 26.87 up to 27.50c., although the lower price may have been shaded a little in view of the great quantity taken. The purchasing was done by the British and French governments, and it is not thought to be ended, as Russia is expected to come in the market. It is estimated (and the figure is purely an estimate) that 100,000,000 lb. of copper was taken. A good business was done on future positions of Lake also. Domestic consumers did not figure in the buying nearly as much as was expected; in fact, the demand for ordinary and peaceful purposes is commonplace. The big business was war business. In its early stages the buying was conducted very quietly, and the magnitude of the movement was not apparent until it was well under way. Deals were closed singly with the larger producers, the activity being especially notable on March 29. The business continued into this month, despite advancing prices, and April 3 the market closed strong at 27.50c., 30 days, delivered, at which price large sales were made. On the 4th a good business was done also, and electrolytic was almost unobtainable at 27.50c., 30 days, delivered, some of the sellers asserting that they were sold-up to August. Prompt copper is not plentiful, but can be had at about $\frac{1}{2}$ premium over the price for June, July, and August, but the market so far as business goes is in futures. Lake is nominal at 27.50c., cash, New York. European statistics show that British and French stocks are steadily dwindling. March exports totaled 24,006 tons.

ZINC

In view of the heavy buying of copper the zinc trade is optimistic, and thinks that a correspondingly large movement in its metal is not far off. As it is, there has been a steady, if moderate, demand for April and May spelter for several days, and the market has a decidedly better tone. Producers do not think that the smelting of zinc in Great Britain, even with Government assistance, will cut much of a figure for some time to come, in view of present difficulties. The scarcity of ships and the hindrance to shipping constitute a great obstruction to getting a sufficient supply of ore from Australia or else-

where. Great Britain, however, after the War, will be in a position to take some of the spelter business heretofore enjoyed by Germany. It is also considered that the greatly increased production in this country will be absorbed. The domestic brass mills have not been buying as heavily as they did a few months ago, for the reason that they have not had as many or as large contracts to cover as they had earlier in the War. The galvanizing trade continues to operate considerably below normal, but galvanized products are practically an indispensable product and it must buy, at least on the dips of the market. The New York price yesterday (April 4) was 18c., and that at East St. Louis 17.75c., for prompt, while April was held at about 17.75c. New York, May at 17.75c., and June at 16.75c. The London quotation on April 4 was £91, a decline of £2 from the previous day. March exports were 1705 tons.

LEAD

The situation in lead has continued interesting. The A. S. & R. Co. gave the trade a jolt. Its statement, to which reference was made in last week's notes, created the impression that it did not countenance and would not support war prices: as a result the quotations of independent sellers sagged to 7.87c., New York. On the morning of Thursday, March 30, lead was offered at 7.75c. East St. Louis. About noon on that day the A. S. & R. Co., announced an advance of \$10 per ton, making its New York price 7.50c., thereby stiffening the market, and sending the outside price back to 8c., both at New York and St. Louis. In fact, March 31 business was done for domestic delivery on the basis of 8.25c., Chicago. It was believed, prior to the advance, that the prices of the leading producer and the independents were drawing together and that the abnormal condition would not last much longer. Some of the trade is inclined to view the company's action rather bitterly, saying that a part of the time when it was opposing high prices it was not selling at all, but that it was ready to sell on a higher price, when it learned through its superior European connections that foreign buying was about to be resumed. This week there has been an excellent demand from abroad. The A. S. & R. Co. might argue in the face of criticism that it said nothing about protecting foreign war consumers. On the other hand A. S. & R. Co. domestic consumers will have to pay a higher price also, in view of the fact that settlements are made on the average of its daily quotations. The New York quotation of independent producers is now 8c., and that at St. Louis is 8c., also. The A. S. & R. Co. St. Louis quotation is 7.42½c. Exports in March amounted to 4151 tons.

TIN

Of great importance in this metal is the statement of the A. S. & R. Co. that it is now ready to supply consumers with tin smelted from Bolivian ores at its new plant at Perth Amboy, N. J. This tin has been successfully used in tinning copper-plates, and it is hoped that it will be acceptable to makers of tin-plate. It is proposed to dispose of the tin at a price based on average quotations. It is expected to be 99.80 to 99.90% fine. During April the company will supply small quantities for experimental purposes. There is a big demand for April tin, but sellers are few because of the continued difficulty experienced in getting licenses to ship from London. Tin in London, but with delivery in New York not guaranteed, is unsalable at 1½c. under what can be obtained for April shipments. The New York quotation for spot yesterday was 50.62½c. Despite all the scares in March the deliveries in that month reached the excellent total of 4726 tons, of which 2126 came *via* Pacific ports. In stock and landing on March 31 was 2746 tons. The quantity afloat on April 4 was 5149 tons.

COMPANY REPORTS

NEVADA HILLS MINING CO.

This company operates in Churchill county, Nevada, and the report of the general manager, E. A. Julian, covers 1915. Development totaled 1812 ft., costing \$11,187, a much less footage than in 1914. The life of the mine is limited. Leasing will be reverted to when it is decided to close. Work was not very encouraging.

The mill treated 64,939 tons of ore and some tailing, averaging \$5.58 per ton, with 81.7% recovery, a decrease of 7%, but this was planned deliberately, and was not really a loss, other things being considered. Costs recently were \$3.59 per ton for all departments. The net profit was \$39,142. An option has been taken on the Oro Fino mine in Esmeralda county.

BARNES-KING DEVELOPMENT CO.

The report of George T. McGee, manager of the Barnes-King Development Co., covers 1915. Mining and treatment continued throughout the year at the North Moccasin mine. To end litigation the Kendall property of 266 acres was purchased for \$100,000, on terms. Over 6000 ft. of development was done in the North Moccasin. To treat some unoxidized ore, a roasting furnace was erected to prepare it for cyaniding. The mill treated 47,938 tons of ore averaging \$9.80 per ton, with 89.7% recovery. Cyanide consumption was 0.4 lb., lime, 4.03 lb., and zinc, 0.43 lb. per ton. The roasted ore extraction was 81.3%, and cyanide and lime consumption 1.3 lb. and 21.5 lb. respectively. At the Piegon-Gloster mine a great deal of construction and development was done. The Norman adit was driven 900 ft., with a 124-ft. raise at the end. The mill treated 14,956 tons of \$7.34 ore, with 85.2% recovery. The Shannon mine was taken under option for \$228,000, on terms. The Gloster mill is to be re-modeled at a cost of \$35,000 to treat Shannon ore. The year's profit was \$147,968. A dividend was recently paid.

A 300-ton daily capacity aerial tram, 2½ miles long, from the Shannon mine to the Piegon-Gloster mill, is to be erected by the Riblet Tramway Co. for the Barnes-King Development company.

NORTH STAR MINES CO.

Improvements costing \$109,412, and a threatened suit with the Empire company over extra-lateral rights were prominent features of this Grass Valley, California, company's operations in 1915. Construction included a head-frame, hoist, bins, and sorting plant at the Central shaft. Late in 1914, at 6225 ft. on the incline, the North Star shaft cut a vein with a south-west dip, a dip almost the reverse direction from the North Star vein. The adjoining company later on claimed the apex of this vein, and serious litigation was averted by arranging boundaries. The vein will be a large producer in the near future. This suit and new plant have been described in this journal recently.

Development covered 5988 ft. The orebody at 3400 ft. was further opened, indicating a considerable quantity of fair ore. Work on the North Star vein at 5000 and 6000 ft. east has failed to find the downward extension of the good lodes at 5000 and 5300 ft. Although 5529 ft. of work was done in the Champion mine, no shoot of importance was discovered above the 2400-ft. level; results were disappointing.

From stores above the 3400, 4000, and 4300-ft. levels of the North Star mine there was extracted 117,606 tons, of which 8046 tons was sorted as waste. The mill treated 109,860 tons, averaging \$9.92 per ton, at a cost of \$5.74 per ton treated. Mining cost \$2.822, and development \$8.20c per ton mined, while milling and cyaniding cost 47.8 and 35.8c per ton treated respectively. The Champion mine yielded \$295,334 from 38,350 tons.

The recovery of precious metals was 97.4%, amalgamation saving 80.37, and cyanidation 19.63% of the total recovered.

The year's revenue was \$1,295,084 from gold produced. Dividends totaled \$250,000, four equal to 10% on the capital.

The results to date are 1,358,394 tons, averaging \$12.846, giving a total of \$17,459,527, of which \$1,787,040 was paid in dividends.

AMERICAN SMELTING & REFINING CO.

An editorial in the Press of April 1 commented briefly on the results of this great concern; the following notes give more details of operations in 1915:

Earnings of the various properties after deducting expenses, etc., show an increase of \$5,430,505 above those of 1914, and totaled \$16,242,120. Earnings during the first half were \$6,002,395, for the second half \$10,455,195. From this was deducted \$1,829,687 for depreciation and depletion of ore reserves, \$795,000 for employees' bonuses and welfare work, and \$554,429 for re-valuation of investments, etc. Of the balance of \$13,053,305, the preferred shareholders received \$6,001,814, and common shareholders \$2,001,080, leaving \$5,050,381 to be carried to profit and loss account. Expenditure on purchase of property and mines, also construction, was nearly \$4,000,000. During 1916 this outlay will be at least \$5,000,000. Mexican properties generally were unproductive and unprofitable. Work at the mines and smelters was very irregular. The plants were kept in good order. Profits of the new zinc plants in Colorado, Oklahoma, and Utah were satisfactory. The value of metals on hand in process amounts to \$35,600,000. Cash in bank at the end of 1915 totaled \$18,612,460. Employees received earnest consideration, especially in welfare work, safety, and education.

Some statistics of the past two years are as follows:

| | 1915 | 1914 |
|--|---------------|---------------|
| Men employed (excluding Mexico) .. | 15,556 | 12,179 |
| Wages and salaries paid (excluding Mexico) | \$11,392,503 | \$10,212,591 |
| Average wages per employee per 8-hr. day | \$2.44 | \$2.33 |
| Ore mined, tons | 1,578,611 | 1,266,702 |
| Coal mined, tons | 214,822 | 257,942 |
| Charge smelted, tons | 4,153,092 | 4,171,258 |
| Bullion refined, tons | 579,080 | 588,718 |
| Coke produced, tons | 120,660 | 129,650 |
| Coal used, tons | 604,204 | 514,619 |
| Coke used, tons | 401,511 | 447,761 |
| Oil used, bbl. | 829,304 | 576,528 |
| Gold refined, ounces | 2,672,702 | 2,510,911 |
| Silver refined, ounces | 76,117,453 | 77,604,483 |
| Lead refined, tons | 296,986 | 316,591 |
| Copper refined, pounds | 551,798,000 | 529,686,000 |
| Metal products manufactured, pounds | 37,835,899 | 40,122,817 |
| Zinc refined, pounds | 26,154,000 | 15,748,000 |
| Acid, pounds | 34,124,000 | 21,234,000 |
| Nickel, pounds | 1,120,556 | 356,187 |
| Income: | | |
| Gold | \$55,239,405 | \$52,515,549 |
| Silver | 38,007,727 | 42,690,226 |
| Lead | 27,279,350 | 24,551,632 |
| Copper | 89,027,089 | 71,712,527 |
| Other metals | 6,105,291 | 2,431,410 |
| Value of products of company's mines | 3,820,166 | 3,135,809 |
| Value of manufactured products | 3,507,276 | 2,665,958 |
| Miscellaneous income | 1,791,511 | 1,222,514 |
| Total of year's business | \$224,777,815 | \$200,925,625 |
| Net profit available for dividends | \$13,053,304 | \$9,031,565 |
| Net profit to volume of business per cent | 5.807 | 4.494 |
| Prospects of the company in Mexico are not bright. | | |

BOOK REVIEWS

THE MECHANICAL WORLD ELECTRICAL POCKET BOOK FOR 1916. P. 240. Ill., index. The Norman-Remington Co., Baltimore. For sale by MINING AND SCIENTIFIC PRESS. Price, 25 cents.

This is the companion volume to the mechanical pocket book which was reviewed in the March 25, 1916, issue of this journal. The two books are similar and contain a large amount of valuable information in their respective lines. They are perhaps not quite so useful to Americans as they are to British engineers, but in either case, the purchaser need have no fear of failing to get his money's worth. A diary for 1916 is included in the volume.

INDUSTRIAL LEADERSHIP. By H. L. Gantt. P. 128. Ill. Yale University Press, New Haven, 1916. For sale by MINING AND SCIENTIFIC PRESS. Price, \$1.

The five lectures comprising this book were heard by the senior class of the Sheffield Scientific School in 1915. The methods of industrial leadership are based on the system of scientific management evolved by Taylor, with whom the author was a co-worker; the chief doctrine of this school is that efficient management of labor increases profits and wages.

A novel point brought out is that an impartial study of the Lawrence strike showed that the labor leaders had a much better understanding of the problems involved than the employers, and that no permanent industrial peace can be hoped for until the employers are better educated. The great profits of the Ford automobile are held to disprove the old theory that great profit can only be had by high prices. A fault of the book is the failure to consider the strenuous objections of the trade unions to scientific management.

REINFORCED CONCRETE CONSTRUCTION. By George A. Hool. Vol. III. Bridges and Culverts. P. 684. Ill., index. McGraw-Hill Book Co., Inc., New York. For sale by MINING AND SCIENTIFIC PRESS. Price, \$5.

This is probably the most comprehensive and useful treatise in English that has appeared upon the subject. Part I deals with the arch bridge. The calculation of stresses by the theory of elasticity is explained, together with the use of both influence lines and the ellipse of elasticity. Particular cases such as the design of unsymmetrical arches and those with elastic piers are discussed. Chapters are devoted to details of arch bridges and to construction of arch bridges. The design of the three-hinged arch by both the usual and the influence-line method is explained. The chapter devoted to patents is particularly useful in view of the number of patents which interfere with the free use of results of research in this field of engineering design. A large number of typical designs of arch bridges and details are then given. Part II is devoted to slab and girder bridges and includes chapters on slab bridges, simple and continuous-girder bridges, and cantilever bridges. Another chapter deals with the use of reinforced concrete in the construction of piers and of solid floors in ordinary steel-bridge construction. Part III discusses culverts, separate chapters being devoted to the calculation of the proper waterway for a given drainage area, and to pipe, box, and arch culverts. The rest of the book is contributed by other authors and concerns particular portions of the subject with which they were especially qualified to deal. Thus A. W. Ransome, a concrete-machinery manufacturer, contributes some valuable data on construction plant. L. H. Allen, connected with a construction company, discusses estimating. W. J. Titus considers the subject of artistic design. A. M. Wolf, a constructing engineer, describes in detail the methods of construction of several large reinforced concrete bridges.

RECENT PUBLICATIONS

LIGHT OIL FIELDS OF WYOMING. By L. W. Trumbull. Bulletin No. 12. P. S. Map. Cheyenne, 1916.

EIGHTH ANNUAL REPORT of the Geological Survey branch of the Department of Mines, New Zealand. P. 52. Illustrated. Wellington, 1915.

PETROLEUM RESOURCES OF THE UNITED STATES. By Ralph Arnold. Reprint from *Economic Geology*. P. 18. Illustrated. The estimated supply is 5,763,100,000 barrels.

LOBLOLLY OR NORTH CAROLINA PINE. By W. W. Ashe. Forest inspector. P. 176. Illustrated. Bulletin 24. North Carolina Geological and Economic Survey Raleigh, 1915.

An excellent description of a useful wood.

SEVENTEENTH ANNUAL REPORT of the mining industry of Idaho for 1915. By Robert N. Bell, State inspector of mines. P. 134. Illustrated. Boise, 1916.

A résumé appeared in the PRESS of March 18.

QUARRY MATERIALS OF NEW YORK—GRANITE, GNEISS, TRAP, AND MARBLE. By D. H. Newland. P. 212. Ill., index. New York State Museum Bulletin. Albany, 1916.

In 1913 the total value of the above rocks was \$6,763,054.

SUMMARY of Railway Returns for the fiscal year ended June 30, 1915. P. 23. Bureau of Railway Economics, Washington, D. C., 1916.

Contains summarized statistics of railroads in the United States.

LEWIS AND GILMER COUNTIES, WEST VIRGINIA. By David B. Reger. P. 660. Ill., maps, index. West Virginia Geological Survey. Morgantown, 1916.

Mineral deposits of the region consist largely of oil, gas, and coal, also clay, shale, and sandstone. Some large gas-wells have been found in Lewis county. A great deal of work has been done in compiling this publication.

University of California, 1916:

THE OWL REMAINS FROM RANCHO LA BREA. By Loye Holm⁶²¹ Miller. P. 8. Illustrated.

NOTES ON THE CAPROMERYX MATERIAL FROM THE PLEISTOCENE OF RANCHO LA BREA. By Asa C. Chandler. P. 10. Illustrated.

CORALS FROM THE CRETACEOUS AND TERTIARY OF CALIFORNIA AND OREGON. By Jorgen O. Nomland. P. 18. Illustrated.

RELATION OF THE INVERTEBRATE TO THE VERTEBRATE FAUNAL ZONES OF THE JACALITOS AND ETCHEGOIN FORMATIONS IN THE NORTH COALINGA REGION, CALIFORNIA. By Jorgen O. Nomland. P. 12. Illustrated.

THE STRATIGRAPHY OF THE PENNSYLVANIAN SERIES IN MISSOURI. By Henry Hinds and F. C. Greene. With a chapter on Invertebrate Paleontology, by G. H. Girty. Vol. XIII, second series, Missouri Bureau of Geology and Mines. P. 407. Ill., map, charts, index. Rolla, 1915.

This report supplements volume XI, which mostly dealt with the coal deposits, and covers the formations that contain little or no coal. The Pennsylvanian series occurs in the north-west part of the State. In the field-work the various limestones were traced, where possible, across the State from Kansas to Iowa, and correlations made with those States, most of them being adopted by the neighboring States. A great deal of interesting information is included in this publication.

INDUSTRIAL NOTES

Improvements in Shoveling

Managers who operate their mines or mills on an efficiency basis have given considerable thought to shoveling. At first this would seem too paltry an operation to be systematized, as, indeed, it has appeared to many. But Frederick W. Taylor, conducting experiments at the plant of the Bethlehem Steel Co., was actually able to produce a tangible saving in shoveling costs of \$36,117.69 in one year. This was effected by giving the men shovels that would hold a load of exactly 21 lb., different types of shovels being used for materials of different weights, since the 21-lb. load shovel was found to handle a maximum yardage with minimum effort for the shoveler. Such shovels have since come into wide use in mines, their efficiency having been established beyond question.

A still later development has been effected through making the shovel's digging-edge of chrome-nickel steel which, obviously, lengthens the life to an appreciable extent and also does away with bending the edge through contact with hard material. The steel wears down to a thin edge without being otherwise affected. Such a shovel is illustrated herewith. It holds a 21-lb. load, its edge is of nickel-steel, and it is known as the 'Wyoming-Mayari Red-edge Shovel,' manufactured by the Wyoming Shovel Works, Wyoming, Pennsylvania. For the Pacific Coast, Harron, Riekard & McCone, San Francisco, are the selling agents.

Personnel of THE DORR COMPANY successors to the Dorr Cyanide Machinery Co., is as follows: John V. N. Dorr, president, was educated as a chemist and after several years in industrial chemical research, including two years spent in the laboratory of Thomas A. Edison, came West and engaged in metallurgical work. He obtained his cyanide experience largely in the Black Hills, South Dakota, where after a period as chemist he leased and operated a custom cyanide plant under the firm name of Lundberg & Dorr, and later erected and operated the first plant (The Lundberg, Dorr & Wilson mill) to use the Moore filter. In this mill the Dorr classifier was developed. He later devised the Dorr thickener in the Mogul mill while acting as consulting engineer to that company. A. L. Blomfield, consulting engineer to the company, is a graduate of Mel-



THE WYOMING
SHOVEL.

CUTTING EDGE OF
SHOVEL.

bourne University. After a number of years with Bewick, Moreing & Co. as metallurgist, having charge of several mills in Australia, he came to the United States and for eight years was superintendent of the Golden Cycle mill at Colorado Springs. The mechanical engineering staff of the Dorr Company has at its head W. A. Neill, who, for the previous 11 years was chief engineer of the mining department of the Allis-Chalmers Mfg. Co. In that capacity he had broad ex-

perience in designing cyanide and concentration mills, mine-holsts, and various special machines. H. S. Coe, a Stanford University man with some 12 years' experience in mine examination and mill work in Mexico, Korea, and Central America, has charge of the laboratory and research department. P. M. McHugh, a Colorado School of Mines engineer, has been associated with the Dorr Cyanide Machinery Co. for the last 5 years and will act as metallurgical sales manager. H. N. Spicer, formerly with Bewick, Moreing & Co., will continue in charge of industrial work at New York. Wm. Russell, metallurgist, formerly with the McArthur-Forrest Co., who has been in charge of the London office since it was started, will continue there.

Bulletin No. 9 of the L. C. TRIM ENGINEERING CO., LOS ANGELES, deals with its 'Universal' cyaniding machine, which will collect and thicken a charge and afterward agitate the same charge; or will thicken and agitate in the same tank simultaneously; or will decant, clarify, and replace water with solution or solution with water; or will perform any action necessary to accomplish the complete treatment of mixed sand and slime, or slime alone, which are agitated simultaneously and so efficiently that the sand in the charge is treated in one-fourth the time required for leaching.

Bulletin 1417A of the ALLIS-CHALMERS MANUFACTURING CO. is of interest to smelting men, as it deals with furnaces and accessory equipment. Small copper and lead furnaces for remote districts and small mines are made when ordered; also up to the 44 by 180-in. water-jacketed blast-furnace for lead ore, and 18 by 192-in. for copper ore. Some useful notes, illustrated by plans and photographs, cover tuyeres, steel jackets, molds, slag-pots, settlers, charging-barrows, dump-cars, and blowers.

The AMERICAN MANGANESE STEEL CO. of Chicago has for distribution the following bulletins: No. 52, 'The Komata Liner for Pebble and Ball Mills;' No. 56-A, 'Crusher Wearing Parts for Jaw-Crushers;' No. 63, 'Amseco Manganese Steel Chain and Sprockets—All Types;' and No. 65, 'Missabe Manganese-Steel Dippers and Vanderhoef Fronts,' also 'Repair-Parts for Steam-Shovels and Dipper Dredges.'

An excellent booklet has been published by the UNION CONSTRUCTION CO., San Francisco, describing the construction and operation of the company's churn-drills for placer prospecting. A notable feature of the Union drill is the ease with which it can be knocked-down when necessary and transported by mules.

A tungsten concentrating mill is to be erected by John T. Duncan of Boulder, Colorado, on his Black Prince property, two miles below Boulder Falls in Boulder canyon. The contract for the equipment has been given to the DENVER QUARTZ MILL & CRUSHER CO. The mill is expected to be in operation by June 1.

Additional evidence of the activity in the mining industry is furnished by the new equipment purchased in districts all over the country. During the past month the REDWOOD MANUFACTURERS CO., San Francisco, has supplied wood stave pipe, in varying sizes, to more than a dozen companies.

Four new magnesite kilns are being erected at Portersville by the JOSHUA HENDY CO. of San Francisco. These cost \$6000 each without lining. Ten or twelve kilns have been erected during the past two months in this State.

The VANADIUM-ALLOYS STEEL CO. of Pittsburg has just issued two folders descriptive of its Vasco choice and Vasco non-shrinkable grades of tool-steel.



EDITORIAL



T. A. RICKARD, Editor

SILVER has risen to 64c. Prospects are good for a continued rise. The movement of troops from India has been accompanied by the transfer of silver coinage to Egypt and Mesopotamia.

IN its issue of April 1, the *Engineering and Mining Journal* publishes a concentration formula as something new. This formula was originated by Mr. Jesse Scobey, now at Pittsburg, and was published by us in our issue of September 21, 1901, with an appreciative editorial note.

ANOTHER big deal in copper is announced in New York. Our correspondent states that between 100,000 and 125,000 tons has been taken by the British and French governments for delivery over the remainder of this year and the early part of 1917. Further buying on behalf of the Russian and Italian governments is expected.

PACHUCA will win increased prominence by reason of the rich silver-bearing orebodies found on the 1400-ft. level of the Real del Monte mine, operated by the United States Smelting company. The ore is said to average \$30 per ton and to represent \$15,000,000. This part of Mexico has suffered but little direct injury during the period of misrule, although it has been difficult to maintain a supply of things necessary to mining operations on a large scale.

TRADER names disregard both dictionaries and family bibles. The title of the interesting article by Mr. F. H. Mason suggests a typographical error, for Mr. Ambrose Monell is sufficiently well known to our readers to ensure a quick detection of an error in the spelling of his name. Apparently the dropping of an 'l' was designed to make editors and proof-readers sit up and take notice. In any event this useful new alloy will serve to perpetuate the honorable name of a brilliant financier.

VILLA'S death may have been "greatly exaggerated"; at the time of this writing confirmation is lacking. Meanwhile the attack on American troops at Parral, in which some Carranzista soldiers participated, augurs ill. It will be a marvel if the punitive expedition returns to the border without further attack, provoking counter-attack and leading to larger operations. The issue is not in the hands of either President Wilson or General Carranza, but in that of an ignorant and emotional population, easily misled by military adventurers posing as patriots. On this side also the public is being fed daily

with a vast mess of misinformation from the correspondents of a sensational press. Every morning we have two or three pages of flapdoodle. Never was journalism so pitifully inefficient and so flagrantly irresponsible. Our own local newspapers appear to be written by office-boys for chamber-maids.

FRANCE is taking a large part of our copper production. During the seven months ending on January 31, the shipments to that country amounted to 75,560 tons, as compared with 42,500 in the corresponding period of 1914. England took 43,488 tons, as compared with 66,608 tons in the seven months of 1914. Russia has increased from 1867 to 12,207 tons, while Holland, which formerly served as a door to Germany, has decreased from 15,082 tons to 1372 in the two periods specified. Italy's demand from American sources of supply remains steadily at about 4000 tons per month.

SENSE of proportion is essential in mining as in business in general. Merely for the sake of doing something, it is not advisable to over-do other things. Henry Ford's idea that nothing is impossible until it has been proved so, is excellent in many ways, yet continued exhibitions involving more energy than judgment may do more harm than good. It is true of some companies, as of some men, that their sustained success is directly due to what they persist in not doing. That busy type of man who is always fussing about things, some of which are not worth doing at all, is neither convincing nor effective. Exaggeration of trivialities is likely to turn an executive into an office-boy.

NEXT June, Messrs. H. C. Perkins and Hemen Jennings will join Mr. F. W. Bradley, president of the three mining companies operating at Treadwell, in a visit to Alaska, for the purpose of appraising the Alaska Treadwell, Alaska Mexican, and Alaska United mines preparatory to a consolidation of these three contiguous properties, which have long been under the same management. Owing to the increasing depth of the mines, the pitch of the orebodies, and the need shortly for sinking the central shaft, it becomes advisable to join the three properties in ownership as well as management. We congratulate the shareholders on the trio of engineers by whom the appraisal will be made.

PREPAREDNESS has been advanced a step by the selection of 250 engineers to co-operate in a survey of national resources available for military and naval pur-

poses. These representatives of the five engineering societies will act for a total membership of 30,000 men. Among those nominated we note the following mining engineers: Arizona, John C. Greenway; Alaska, Philip R. Bradley; Colorado, D. W. Brunton and Thos. B. Stearns; Utah, Lafayette Hanchett; Idaho, Stanley A. Easton; Montana, E. P. Mathewson; Nevada, W. E. Trent; and Minnesota, Horace V. Winchell. In California the five nominated are Wynn Meredith, G. W. Dickie, Charles W. Merrill, A. H. Babeock, and Edmund O'Neill. All of these selections will find hearty public approval. The European war has shown the advisability of mobilizing the engineering talent of a country and utilizing its services both at the front and in the manufactory. The President and the Secretary of the Navy have shown a good deal of sagacity in this matter.

DISCUSSION this week includes a letter from Mr. Frank H. Probert, an experienced engineer, who has been lecturing recently before the School of Mining in the University of California. He endorses the opinion expressed by Mr. Mathewson as to the necessity for giving a broad training to mining students. To Mr. P. G. Beckett, the manager of the Old Dominion mine, in Arizona, we are indebted for many practical details concerning steel-sharpening, as compiled for him by the superintendent of the mine, Mr. I. H. Barkdoll. The present status of professional activity is the subject of a letter from Mr. Frank A. Ross, a public-spirited engineer who takes a prominent part in the mining affairs of Spokane. Among other matters, he touches upon the propriety of professors practising as engineers. To Mr. T. W. Gruetter, a studious metallurgist, we owe an interesting note on the treatment of antimonial gold ore, supplementing the data given by Mr. Mason in our previous issue. Finally, the Manitoba mining law is outlined and discussed by Mr. W. K. Harding, of Chicago. This should be read in connection with Mr. Franklin W. Smith's scholarly article on 'The Law of Mines' and our own criticism of legislation recently proposed in Congress.

LACK of shipping is becoming an increasingly serious factor in commerce. For instance, the freight on nitrate from Chile is now \$30 per ton as against a normal rate of \$5 to \$6. Hawaiian sugar is being shipped to San Francisco for transport across the continent to New York by rail, simply because vessels can be most profitably employed in short voyages; otherwise direct shipment through the Panama Canal would be natural. The re-opening of the Canal last Saturday is a welcome event, but the frequent blocking of that short cut has caused merchants to feel uncertain considering traffic through the Isthmus, so that relief will not be felt at once. This will affect ore shipments, for instance, those of tin concentrate from Bolivia to the new smelter at Perth Amboy. Tin is now being produced there, and the American Smelting & Refining Company, owners of the plant, are distributing samples of an unusually pure metal. Their operations in Chile involve a large amount

of freight; thus the Chuquibambata and Braden mines will require 460,000 tons of freight during the next two years. That gives a good idea of the bigness of the operations now in progress at those two copper mines. The Andes Exploration Company, controlled by the Anaconda Copper Mining Company, will also be erecting a large plant, making a further demand on shipping from New York. Such facts as these suggest the congestion of maritime traffic threatened by the withdrawal and destruction of shipping in consequence of the War.

COMMENT concerning the slowness with which the quotations of copper companies respond to the rise in the price of the metal is almost unnecessary. Of course, those who are well informed realize that the market is abnormal, so that any calculations of future profit on present prices are ridiculous. The buyer of stock should distinguish between gambling on that fact for a quick deal and buying shares to hold them as an investment. The price of copper on the latter basis is somewhere between 15 and 17 cents per pound, allowing for an enhancement of value in the coming years. Moreover, it should be known that the costs given in brokers' circulars are largely theatrical, for the low operating expense per ton just now is due largely to the magnified scale of working, the selection of better-grade ore, and the rejection of low-grade material on account of hurry. All this means eventual wastage and cost. In short, the showing made by the great enterprises exploiting disseminated copper in Arizona, Utah, and Nevada, for example, is not to be considered as a guide to those who are thinking of buying shares on an investment basis, that is, for income.

CANADIAN taxation of profits in excess of 7% applies to gold mines, which, the world over, are suffering from the fact that the War has caused the value of the material—labor, machinery, and supplies—used in mining to appreciate as measured in terms of the gold itself, which, being the standard of value, remains fixed. In short, gold has depreciated as measured in commodities. This is urged by Mr. F. H. Hamilton, a recognized financial authority, in an interesting article appearing in the March issue of *The Mining Magazine*. He suggests forcibly that the imposition of a tax on profits above 7% disregards the essential features of the business of exploiting a gold mine, which is a short-lived rapidly-wasting asset entailing a risk that calls for much more than a 7% return on the money involved in its purchase and equipment. In any case, the yield from such a tax will be small and the harm done to a stimulating industry will be great. To the British, and to their allies, it must be a source of satisfaction that 60% of the gold production of the world is obtained from their own dominions, and 8% from Russian territory. As 20% is won in the United States, there only remains 12% for the rest of the world, and of this the Austro-German dominions contribute only a fraction, the statistical record often crediting the relatively small yield from imported ores to domestic production, which is negligible. We do

not wonder, therefore, that any check on gold mining is denounced as a blunder. When the great accounting takes place, the fellow with the yellow stuff in his till will be best able to meet his obligations.

The Mining Law

We have received a copy of H. R. 12275, which is "a bill to revise, amend, and codify the sections of the Revised Statutes of the United States relating to the location of mining claims on the public domain, and for other purposes." This bill has been introduced in the lower house of Congress by Mr. M. D. Foster, chairman of the House Committee on Mines and Mining. He sends us a copy of the proposed enactment and asks us to comment upon it. Our contemporary in New York refers to the author of this legislative exhibit as Dr. Foster, from which we infer that he is a Doctor of Divinity, because the wording of the bill suggests the assumption that a special providence waits to protect the application of it in the big world outdoors. The text contains many typographical errors, for which there is no excuse in a document intended to be taken with the utmost seriousness. Apart from these blemishes, the phrasing is marked by such prolixity and lack of cohesion as promises plenty of scope for confusion, in the field and in the courts. If the existing law, which has become crystallized in practice through long years of laborious interpretation, is to be superseded, it should be replaced by one offering the minimum of ambiguity and the least opening for litigation. In this respect H. R. 12275 is radically defective.

The principal changes in the law are as follows: (1) Discovery of a vein or lode is to be no longer a primary condition. (2) Where no outcrop exists the prospector can make a temporary location, which holds good for one year, when he must peg a permanent claim. (3) He has the option between two kinds of claim: the present one, 1500 by 600 feet, carrying extra-lateral rights, or a new one, 2100 feet square, giving him no rights outside his surface lines extended vertically downward, but granting the choice of applying the full width of the claim on the dip of the lode. (4) Both the oblong claim, with its extra-lateral right, based, as formerly, on the possession of an apex, and the square claim, with no such right, are subject to the privilege of the owner of a prior oblong location to follow a vein or lode, outcropping on his claim, on its dip into the territory of an adjacent junior location. (5) But this privilege of the prior location is limited to the two years after the junior location has been made and during those two years the prior locator must either remove the ore to which he is entitled or he must establish the position of the vein or lode passing from his claim into that of his neighbor. (6) To do that, he is permitted to enter upon the surface of the junior location "and drill or explore by vertical openings, or enter the workings of such junior locator * * * to aid in making such survey and identification of his vein or lode."

It is not worth while to refer to other amendments of

the existing statute. Those outlined will suffice to indicate the nature of the changes suggested. They bristle with possibilities of litigation in every other line. Mr. Franklin Smith says that the old law contained a Pandora's box of mischief; this is true equally of its proposed substitute. If the miner is to have a substitute for the law with which he has grown familiar, he is entitled to expect one that will not drive him first to a lawyer and then to a geological expert in order that he may learn what it means. Why don't these law-makers start with a few definitions, if for no other reason than to clarify their own minds before they undertake to guide others? Let them begin with defining "vein or lode" and then "outcrop." No committee incompetent to give such definitions should essay the task of preparing a legislative measure dealing with the subject. It has been stated that Mr. Foster obtained the assistance of engineers in the Bureau of Mines, but we are able to assert that the bill does not represent the ideas of the Bureau; it is the compilation of one man—a politician in a hurry. It has been prepared without the assistance of those best qualified, namely, those who have had experience in the ownership of, and the litigation over, mining property. Such experience was made available to members of the Committee on Mines and Mining, but like most politicians, they did not like experts able to tell them too much; they preferred to muddle through in their own unscientific way. They ignored the opinion of the mining community as expressed on various occasions, and particularly at the meeting organized by the Mining and Metallurgical Society at Washington last December, that opinion having crystallized into a resolution that any legislation to be of permanent benefit must be preceded by a systematic investigation by a commission chosen for this special purpose. A bill to create such a commission was introduced by Mr. E. P. Taylor, of Colorado, and killed by Mr. James Wickersham, of Alaska, as soon as it was introduced in the House, but the sincerity of the Alaskan representative was mercilessly exposed shortly afterward by the *Engineering and Mining Journal*—a public service, well done. Then the member for Illinois, Mr. Foster, introduced his blundering bill of 73 pages, while in the Senate, Mr. Reed Smoot presented a brief bill abolishing the extra-lateral right but ignoring that of discovery. Another effort is to be made by Mr. Thomas J. Walsh, senator from Montana, who is co-operating with the Mining and Metallurgical Society in an effort to introduce a piece of legislation more serviceable than the inchoate measures of the gentlemen from Illinois and Utah. The position has been complicated by the introduction of a leasing bill applicable to non-metalliferous deposits, such as coal, oil, and salines. This is disliked intensely in parts of the West but it is favored by the Administration and the passing of it is assumed in Mr. Foster's bill; see Section 2328a. The outlook is not good. A big problem is being tackled piecemeal, by legislative patchwork. In order to do justice to a complex subject and to perform a big task efficiently, it is advisable that the mining law be revised in connection with cognate laws affecting the entire sub-

ject of administering the public land. Perpetual tinkering, here and there, only makes for unrest, irritation, and confusion. As regards our mining regions, the harm has been done, the territory virgin to new legislation is circumscribed, most of the ore deposits have been covered, if not discovered, and the introduction of regulations based on a radically different principle will only be justified if it is the result of careful investigation and sagacious preparation. That description does not apply to H. R. 12275.

The Man Who Sits Back

You know him; he leans back in his chair, cocks his cigar at an aggressive angle from the corner of his mouth, looks superciliously wise, and says nothing while you others are in the midst of an eager frank discussion. He knows all about it, you are given to understand, but he does not think it worth while to contribute from the wealth of his wisdom. That type of man crosses the trail of all of us who are keenly participating in technical progress and scientific research. If you mention the work done by somebody else, he tells you that he himself did the same thing long ago but did not care to rush into print. If you speak approvingly of another man's contribution to current knowledge, in the shape of an article or paper, he calls it 'piffle' and conveys the idea that if he were to tackle the subject something really worth while would result. If you suggest that he ought to do so, he retorts that he is too busy for such inconsequential labor, and he sits back in his chair with an access of self-complacency. He depreciates the work of others; he depreciates their willingness to add to the stock of experience by writing; he belittles their effort to advance the cause of technical progress by speaking at engineering meetings. All these provoke his disdain. And yet all the while he is only a four-flush, a simulacrum, for he does not know so very much, he could not write about it with any skill, nor could he stand on his feet and speak clearly for ten minutes at a stretch. He is a false alarm, and in time he is not only discovered; he discovers himself. Giving nothing, he receives none; not being co-operative, he is let alone. The insolence of an incommunicative self-detachment leaves him isolated on a little ragged reef of crumbling conceit. The great procession moves forward while he stands sneering in a darkening side-street. Those whom he discounted have won credit from their fellows; the men who gave freely from their little store of knowledge have garnered a rich harvest of scientific truth; the exchange of professional experience has brought mutual good and culminated in cordial co-operation, without which nothing really big can be done in this world. The man who used to sit back has taken a back seat for all time.

Avoid him, he is a bad oyster in the feast of life. Avoid his pestilential pose. We address ourselves to the younger men, for our contemporaries are their own philosophers. As a matter of fact, the man who sits back is no longer young; he never was; at an early period in his jaundiced life he lost the essential marks of youth—gen-

erosity, expansiveness, comradeship. His years may be few, but he is a shriveled miser who guards his little hoard while the lordly galleons go sailing past the nearby headland. The instinct of youth is to give and to exchange ungrudgingly. Have you ever thought how little of what you know is original—your own, as it were? Fully 95% of what we know has been given to us without payment: in books, in teachings, in talk with associates. The price of a book or the fee for a course of lessons we do not count as a *quid pro quo*, it is merely an honorarium such as you give the keeper of the king's treasure when he admits you to the vaults of the palace of knowledge. We are in debt for what we know and the debt is like the one we owe our mother, unpayable, never to be liquidated, save in making good use of the gift. Having been so freely enriched, it remains for us to give in turn to those that follow. Consider what metallurgy would be today if each man had worked like an alchemist in his cell or a conspirator in his cellar. Eliminate the clearing-house of ideas and man would be insolvent. The individual contribution is so small that by itself it is of little avail; single bricks that make no buildings until arranged in orderly fashion. Even as it is, with all the social impulses that lead to co-operation, it is probable that the world has lost much that it could ill spare through secrecy and the failure to record. We recall a mining engineer at Denver who died leaving a mass of notes, intelligible only to himself, with the confession that he had intended to arrange and systematize them some day. That day never came; another came instead. A fire such as that in San Francisco, ten years ago, destroyed whole libraries of knowledge, many not yet printed. One family of engineers is reported to have maintained a record of their own experiences for the use of their own family, but the flames swept it into smoke and they were bankrupt of their selfish gains. Bah! that sort of thing is meaner than the man who called on a sick friend and ate all his grapes. And it is so pitifully futile. The best way to gain information is to give it. Nobody learns as much from a book or an article as the man who wrote it. The effort to put a lot of amorphous notes into crystalline literary form is a mental discipline; it discloses the holes in the writer's information; it causes him to co-ordinate what he knows on the subject so that he himself cannot forget it easily. Otherwise it passes like smoke from a camp-fire. Consider the mines you visited or the mining districts you traversed ten years ago; how much do you remember about them that has technical value now? If you had written an article on them, for publication—and that use of writing is the only one to ensure care and finality—you would not only have arranged the bundles of impressions in portable shape, but you could now refresh your memory by the written word. So, we say to the young man, pay no attention to the man who sits back and sneers at the generous effort of others. Or, if you are curious, ask him to show you the fruits of his philosophy. In an earthen vessel on his mantel you will find them: Dead Sea apples, the apples of Sodom, bitter and dry.



DISCUSSION

Our readers are invited to use this department for the discussion of technical and other matters pertaining to mining and metallurgy. The Editor welcomes the expression of views contrary to his own, believing that careful criticism is more valuable than casual compliment.

Mining Education

The Editor:

Sir—Within the last five years the Royal School of Mines, London, the Colorado School of Mines, and Columbia University have had to fill the chairs of mining. The same problem now confronts two other technical colleges in this country. The responsibility of the executive committees having to make these appointments is great, and the personality, influence, and ability of the appointees will probably be reflected in the mining history of the next half century. Hence the subject of the early training of a mining engineer is deserving of deep thought and constructive discussion. The comment of Mr. E. P. Mathewson in your issue of April 8, and the editorial on this subject in the issue of March 11, confirm, in a general way, my own convictions, except that I would even more strongly emphasize the necessity for sound training in the keystone of all scholarship: the ability to read and write the English language. This should be taught in the grammar grades, continued in the high-school, cultivated and exercised in the mining colleges. On this solid foundation erect a framework of knowledge of the natural sciences, chemistry, physics, mechanics, and allied subjects; reinforce it with a study of business economies, then build up the superstructure by teaching the principles of mining in the class-room and by practical demonstrations and personal contact with actual operations in the field. Mining colleges at the best can only teach the alphabet of mining science, which the student will use in later life to spell success or failure. The instruction should be competent, but general rather than highly specialized.

In the school of riper experience, the student will coordinate his ideas and discriminate between that which is essential and that which is superfluous; he will drift unconsciously into a particular line of work as opportunity offers, but on leaving college his knowledge should be sufficiently broad to enable him to apply himself intelligently to any branch of the industry. The late Clement Le Neve Foster, addressing the graduate students at the Royal School of Mines, London, in 1896, said, in part: "Gentlemen: You have been trained during these three years in the principles of chemical, geological, mining, and allied science; you are filled with theories and saturated with technical terms. You have studied the sedimentaries, igneous, and metamorphic rocks; of mineralogy you have had enough. Just one last word: after all there are only two kinds of rocks

which are of importance—ore and waste. The thing is to know the difference."

The old order of things echangeth. With improved methods of treatment, the 'waste' of today may be the 'ore' of tomorrow and it is probable that the abandoned mines of the past will be the profitable mines of the future. This progress will be retarded unless the student has a good general working knowledge of all branches of the industry. His vision must be large and his mental attitude plastic. Had I a son to educate for the profession, I would wish that his early training be given in one of the old English schools, such as Eton, Harrow, or Rugby; to be continued in such an institution as the Michigan College of Mines, where efficient theoretical and practical instruction is given, spending his vacations at different mining centres in contact with men and methods; then a year or two in the field that he might find himself and the particular work for which he was best fitted, and later a post-graduate course at Columbia, Harvard, or some other first-class university, to round out his education or develop his specialty. Above all things, I would wish him to care for his body as well as his brain, to cultivate and maintain a manly relationship with his fellow-men. *Mens sana in corpore sano.*

We are living in the age of specialists, the general practitioner is *passé*. Individualism or specialization is to be encouraged, still I hold that the curriculum of a mining college should be broad in its scope; that mining students be trained in the essential sciences; that they be informed of all phases of current practice, and that they specialize in that greater university—the mining field.

FRANK H. PROBERT.

San Francisco, April 10.

Drill-Steel Sharpening at the Old Dominion Mine

The Editor:

Sir—Our mine superintendent, I. H. Barkdoll, has compiled the following notes on steel sharpening in answer to your enquiry. The drill-steel used by the Old Dominion Copper Mining & Smelting Co. is of four kinds: Leyner steel; piston-drill steel; stoper steel; and Jack-hammer steel. Leyner steel is made from 1½ round, hollow Keystone bars. It is cut into four lengths, 2 ft. 9 in., 4 ft. 9 in., 6 ft. 9 in., and 8 ft. 9 in. Shanks and bits are made on a No. 5 mechanical sharpener, and gauging is done automatically when sharpening, only one

heat being taken for each shank or bit. The different gauges on the Leyner steel are 2½ in., 2 in., 2 in., and 1½ in. Four point cross bits are used, with shoulders ½ in. thick and cutting edge drawn to 90° pitch. Stoper steel is made from inch grooved Keystone steel cut into lengths of 2, 3, 4, 5, and 6 ft., with bits gauged 1½, 1½, 1½, 1½, and 1½ inch. Jack hammer steel is made from ½-in. hexagon hollow Keystone, cut into lengths 2, 3, 4, 5, and 6 ft. and gauged the same as the stopper steel; both the four and six point bits are used, depending on the ground to be drilled.

Sharpening and tempering of all steel is by the same process. Hollow steel before heating is thoroughly cleaned and blown out by means of a steel tube attached to a spring-valve on the compressed-air line. A single heat is taken for the punching and sharpening operation, the bits being heated for 2½ in. in a quick fire. After heating, the hollow steel is punched in the centre by an air-punch (made from a No. 2 mechanical sharpener fitted with an air-cylinder punch), enlarging the hole sufficiently so that, when sharpened, it will not close. It then goes to the sharpener, where it is sharpened and gauged at one operation. Stoper and piston-drill steel are treated in the same manner except that a shorter heat is taken, as no punching is required, being all solid steel.

Piston-drill steel is made in the following manner. Starters are cut from 1½-in. Keystone grooved steel 2 ft. 4 in. long, with shanks drawn on one end to fit the drill-chuck. The 2nds, 3rds, 4ths, and 5ths are made by welding 1½, 1½, and 1½-in. grooved steel, cut 2 ft. 4 in., on 1½ hexagon steel, making the total lengths 4, 6, 8, and 10 ft. The gauges for this steel are 2½, 2½, 2½, 1½, and 1½ in. These are also cross-bits, ½ in. thick at the shoulder, with the cutting edge drawn to 92° pitch. This steel is standard for all our types of piston-drills such as Sullivan, Wood, Holman, and Ingersoll-Rand 3-in. machines and does not prove too heavy for 2½-in. and 2½-in. machines. This standardization of piston-drill steel is made possible by having the chuck-bushings in all machines standard, and allowing only one class of steel for each class of drill.

All tempering is done by re-heating, which hardens where hardness is required, while the remainder of the drill remains soft and tough. In tempering, after sharpening, with the same heat the drill is often hardened too far back and the bit is liable to break in hard ground. The tempering heat is as short as possible with an even slow fire to a cherry red, then dipped in pure water. The water is kept at an even temperature by having the intake-pipe at the bottom and the overflow on top, with the water in continuous circulation. In tempering shanks we heat about an inch of shank, dip, and draw to a light-straw color. Much depends, of course, on the class of steel used. Breakage on our steel averages ¼% of the pieces used, or 3 in 600.

P. G. BECKETT.

Globe, Arizona, March 27.

Is Mining Engineering on the Wane?

The Editor:

Sir—Your editorial of March 11, 1916, on this subject, is so clearly to the point and touches so nearly the future of independent, or unsalaried, engineers that it merits comment. Questions of this kind are apt to be received skeptically by some and ignored totally by others, particularly in technical circles, but the fact remains nevertheless that certain recent changes in business methods are reacting upon the professions in a manner that gives rise to grave concern and calls for earnest consideration by engineers of every class.

First of all comes a recognition of the fact that this is an age of transition in almost everything—in morals, religion, art, science, and, especially, in business; moreover, that changes such as are now in progress require fundamental readjustments of the plans, pursuits, and personal ambitions of those affected, namely, the independent or unsalaried engineers. But, inasmuch as the salaried engineer of today is certain to become, by the law of succession alone, the unsalaried engineer of the future, both may be classed as one for the purposes of this discussion, which, then, includes all engineers.

Your editorial is certainly right in maintaining that mining engineering, *per se*, is not on the wane and never will be while civilization exists; yet the business of independent consulting mining engineers shows unmistakable signs of a rapid decline. Both the editorial and the paper by Mr. Arthur L. Walker, which it quotes, attribute this decline, first, to the Mexican revolution, which turned loose upon the United States a small army of competent engineers and thereby glutted the market, so to speak; second, to the European war, which closed several important mining regions; third, to a prolonged financial stringency, which suppressed new enterprises and stopped those in progress; fourth, to a surplus of mining graduates who, by the way, usually work for practically nothing to gain experience; fifth, to the modern demand for specialists in every line.

Manifestly, all of these have been contributing causes, but they do not include the most important, direct and, perhaps, most permanent causes that threaten the business of independent engineers; in fact, all but the last two are of a temporary nature and may be neglected; even the present excessive output of mining graduates may automatically regulate itself in time, but the demand for specialists must continue to increase and the question then is: will these specialists themselves be able to maintain their independence in the face of the new conditions, which may be stated as follows: first, the consolidation of mining interests by which nearly all of our great camps have become dominated by single companies, each of them maintaining its own highly organized engineering staff and seldom employing outside talent; second, the gradual disappearance of the small development syndicate and its grubstaked prospector, due to this same consolidation movement. Just as the consolidated meat-packers have exterminated at once the village butcher and a thousand bidders in the open

cattle-markets, so this modern consolidation idea is banishing small mining operators from whom the independent engineer once realized much business and who numbered hundreds instead of dozens, as at present; third, and most important cause of all, perhaps, is the growing custom of furnishing public service through the medium of at least six different kinds of organized engineering talent of the highest order, namely, the staffs of our government bureaus, public utilities corporations, great mining companies, powerful exploration syndicates, mining machinery houses and, last but not least, our universities and colleges. Seldom does any one of these institutions, or corporations, throw business in the way of the independent engineer, but all of them take it from him; and in the case of universities and colleges especially the strange spectacle is frequently presented of the professor coming into direct and sometimes ruinous competition with his former students, thereby giving rise to much bitter complaint.

Personally, I defend the right of a professor to enter the field of public service, provided that his fees equal or exceed the highest obtainable by any established engineer operating independently in that field, in which case the question is reduced to a matter of relative ability. In other words, if the professor ranks so highly as an engineer that the client prefers to pay a premium for his services then that client certainly has a right to exercise that preference and the competition is justified as between man and man. Otherwise, the prestige, publicity, salary, student aid, and equipment facilities enjoyed by the professor give him so great and undue an advantage over the engineer in business for himself that the latter is practically eliminated from the competition, other things being equal.

These, then, are conditions that call for earnest consideration by the engineer both of today and tomorrow. He must anticipate the time when younger men will displace him and he must ask himself what he can then do for a living. Until quite recently every ambitious engineer has been warranted in dreaming of the day when, ripe in experience and with a reputation well earned, he may strike out for himself and accumulate a competency for old age such as no engineering salary is likely to supply; but what about such dreams in the future? Are they likely to be realized, or not? Are these dangers fancied, or real?

FRANK A. ROSS.

Spokane, March 20.

Antimonial Gold Ore

The Editor:

Sir—Referring to the remarks by Wm. Seward Mann on 'Treatment of Antimony Gold Ore' and your own notes on the same:

There is a cheap way of making this caustic soda, namely, by electrolysis of salt solution (NaCl). If, in such solution, the sulphides are made the cathode and a little phenol-phthalein indicator added, the usual discoloration for alkalinity will surround the sulphides while

the current passes. Thickness of film of antimony, silica, or grease determines the kilowatts consumed, electric power being cheap near many mines. Hydrogen is also formed and will remove oxide coatings. Care must be taken to avoid mixing the hydrogen with the oxygen from anode, by using a porous diaphragm and carrying away the oxygen. Otherwise explosions might result such as probably blew up the submarine lately and the recent explosion in the chlorate plant at Niagara Falls.

My experience with electrolytic amalgamation has convinced me that metallurgists have overlooked a good thing. For example, I believe electrolysis of NaCl with Hg cathode could be applied to picking up the floured 'quick' from cinnabar ore. Also, electrolysis without mercury, for removing oil from flotation concentrate. As the NaCl electrolysis is a reversible action, it can be worked cheaply. By-products, such as chlorine for chlorinating, or bleaching-powder for chasing the enemy from our borders with gas could also be made. From 16 lb. NaCl + H₂O, 11 lb. caustic and 9.8 lb. chlorine can be produced per indicated horse-power day. These are Castner's figures from practical work. But I am afraid I am taking too much of your space.

T. W. GRUETTER.

Medford, Oregon, April 3.

Manitoba Mining Law

The Editor:

Sir—The Legislative Assembly of Manitoba, Canada, has recently assented to an Act that censors and controls the public offering of mining and other shares within the Province.

This Act is characteristic of the direct and efficient way with which Canadian law-makers define methods of procedure which must be followed within their jurisdiction. It would be well for our legislatures to consider the actions of our thorough-going neighbors to the North in the supervision of an industry which on account of its economic possibilities provides fruitful material for the operations of those mining promoters and stock-peddlers who show scanty regard for truth, reason, or good business.

Manitoba has done little mining. In 1915 she contributed less than 1% of Canada's mineral industry, but recent activity and promising discoveries have prompted her policy of preparedness. While over three-fifths of Manitoba's 252,000 square miles is not particularly adapted to agriculture, it is largely underlain by rocks of the Pre-Cambrian age with numerous occurrences of the Keewatin and Huronian which are conspicuous in the Sudbury nickel, Cobalt silver, and Porcupine gold districts of Ontario.

Prospecting is now under way on a considerable scale and as a direct result of gold discoveries in the Rice Lake district, initial development of a number of properties with satisfactory results and an earnest attempt on the part of both the Government and a majority of the developing interests co-operatively to suppress any possible 'blue sky' promoting, the Manitoba Sale of

Shares Act, as amended, now stands as a welcome monument to the advocates of fair play. Extracts hereinafter given are from Chapter 175 of the Revised Statutes of Manitoba, 1913, as amended by Chapter 105 of 1914 and Chapter 96 of 1916, copies of which may be obtained from the King's Printer for Manitoba, at Winnipeg, Canada.

With respect to developing mining companies, this Act provides that it is unlawful for any person or persons, corporation or company, or any agent acting on his, their, or its behalf, to sell or offer to sell, or to directly or indirectly attempt to sell, in the Province of Manitoba, any shares, stocks, bonds, or other securities of any corporation or company, syndicate or association of persons, incorporated or unincorporated, without first obtaining from the Public Utility Commissioner a certificate to the effect set forth in the Act and a license from such agent in the manner provided for. A fine of from \$50 to \$500 is imposed upon any person convicted of doing anything forbidden by the Act.

"It shall also be unlawful for any printer, publisher, newspaper proprietor, or other person hereafter to print, publish, or advertise in this Province, in any newspaper, magazine or other periodical printed and published in this Province, or otherwise in this Province issue, put forth or distribute, any advertisement, circular, letter or other document containing any offer to sell or solicitation to purchase any of such shares, bonds, stocks or other securities, unless the company, corporation, association or syndicate whose shares, stocks, bonds or other securities are so offered for sale shall have first obtained from the commissioner the certificate aforesaid."

The procedure to obtain permission to sell securities requires the filing, properly verified, of "a statement showing in full detail the plan upon which the company proposes to transact business; a copy of all contracts, bonds or other instruments which it proposes to make with or sell to its contributors; a statement which shall show the name and location of the company, corporation, syndicate or association, and an itemized account of its actual financial condition, and the amount of its property and liabilities, and such other information touching its affairs as the commissioner may require."

The Commissioner is authorized, upon examination of the required information:

"* * * if he finds that such company is solvent, that its articles of incorporation or association, its constitution and by-laws, its proposed plan of business and proposed contracts contain and provide for a fair, just and equitable plan for the transaction of business, and in his judgment promise a fair return on the shares, stocks, bonds and other securities by it or by such person offered for sale, the commissioner shall issue to such company or person a certificate reciting that such company has complied with the provisions of this Act, that detailed information in regard to the company and its securities is on file in the commissioner's office for public inspection and information, that such company is permitted to do business in this Province, and such certificate shall

also recite in bold type that the commissioner in no wise recommends the securities to be offered for sale by such company." (Section 10.)

The following extracts have recently been enacted to bear particularly upon the present mining situation:

"For the purpose of facilitating commercial, industrial and mining undertakings in Manitoba, it is enacted that whenever it shall appear that a company, whose undertaking, being of the nature aforesaid, has not been developed and that it is therefore not known that a fair return is promised upon its shares, stocks, bonds or securities, so as to justify a certificate under section 10 of this Act, such company may apply for a special certificate in respect of shares, stocks, bonds or securities, and permitting the offer by the company to the public for purchase of shares, stocks, bonds or securities by the company.

"The commissioner shall grant such special certificate upon the company establishing to his satisfaction that the proceeds of all sales of the unissued stock of said company will be paid to an incorporated or licensed trust company, in Manitoba, or other trustee approved by the commissioner, less a deduction in his discretion for commission for the sale of such stock and reasonable expenses incident to the office management of the company advertising, and in trust to apply such net proceeds to the development or operation of the undertaking of the company only.

"Any shareholder may sell from time to time any of the shares held by him in any company which has obtained a special certificate as aforesaid, personally or through his agents or upon any stock exchange, and no sale or attempt to sell by any such individual shareholder, his agent or brokers, shall be an infraction of this Act."

"Certificates for shares offered for sale pursuant to the provisions of this section shall have conspicuously written or printed on the face of them the words 'development stock'."

Any company or person obtaining the Commissioner's certificate may appoint one or more agents who must obtain a license from the Commissioner. This license must be carried by the agent and produced by him to every person with whom he proposes or offers to do any such business, and is subject to revocation at any time for cause appearing to the Commissioner sufficient.

Semi-annual reports are required to be made to the Commissioner showing the detail business conditions of a company, and no amendments to the constitution or by-laws are operative until filed and approved. The Commissioner is given all powers necessary to investigate or correct the operations of a company at any time as may seem to him just and equitable.

W. K. HARDING.

Chicago, April 3.

POTASH production of Germany in 1915 amounted to 6,799,757 double hundred-weight (220 lb.), against 9,039,883 in 1914, and 11,103,694 in 1913.

Monel Metal

By F. H. Mason

EVERYONE has heard the joke of the prospector who said he had discovered a brass mine. A brass mine, however, is a metallurgical, rather than a natural absurdity, for copper and zinc may occur together in nature in proportions suitable for the formation of brass, but, up to now, the metallurgist has not found a way of reducing them from their combinations to form that alloy. This is not the case with monel metal. Monel metal is an alloy, consisting of about 30% of copper and 70% of nickel—I shall deal with its exact composition later—and is reduced directly from the nickel-copper ores of Sudbury, Ontario.

Before dealing with monel metal, it might be well briefly to outline the methods by which nickel is extracted from the Sudbury ores, with the view to showing how much simpler it is to extract monel metal directly from the ore than first to extract the nickel and afterward alloy it with the desired proportion of copper. The direct reduction to monel metal has one serious disadvantage. The Sudbury ores sometimes contain appreciable quantities of the platinum group of minerals, which may be recovered from the residue from the Mond process, but which pass into the monel metal in the case of direct reduction to that alloy. On the other hand, the proportion of these precious metals is too small to affect the physical properties of monel metal, and likewise generally too small to pay the cost of the round-about method of first reducing to nickel when monel metal is the desired product.

The Sudbury nickel-copper ores consist essentially of pyrrhotite, with which is associated a number of nickel-bearing minerals, such as pentlandite (FeNiS), millerite (NiS), polydymite (Ni₄S₂), and rarely gersdorffite (NiSAs), and niccolite (NiAs), together with chalcocopyrite and comparatively small amounts of silicious matter. Of course the composition of the ores varies in different mines and in different parts of the same mine, but for the purpose of this article the ores may be considered to contain about:

| | |
|-----------------|------|
| | % |
| Nickel | 4.5 |
| Copper | 2.0 |
| Iron | 52.0 |
| Sulphur | 34.0 |
| Insoluble | 7.0 |

The ore is roasted in large heaps which, when well started with cord-wood, burn for three or four months, at the end of which time the sulphur content is reduced to 10 or 11%. The roasted ore is smelted in rectangular water-jacketed furnaces, together with green highly silicious ores, or, if the latter are not available, with silica. In this way much of the iron is fluxed off as

silicate, more sulphur eliminated as dioxide, and a matte containing about 30% nickel-copper obtained. The furnace-matte is run into converters and blown to about 80% nickel-copper, silica being used as a flux. As the slag from this operation contains appreciable quantities of metal, it is returned to the blast-furnace. Up to now, this is as far as the metallurgy of nickel is carried at Sudbury. The Mond Nickel Co. ships the matte to Clydach, in South Wales, where it is subjected to that beautiful metallurgical process invented by Ludwig Mond, in which the nickel is converted into a gas at a temperature far below the boiling point of water; and the International Nickel Co. ships its matte to Bayonne, New Jersey, where some of it is reduced to nickel and some to monel metal.

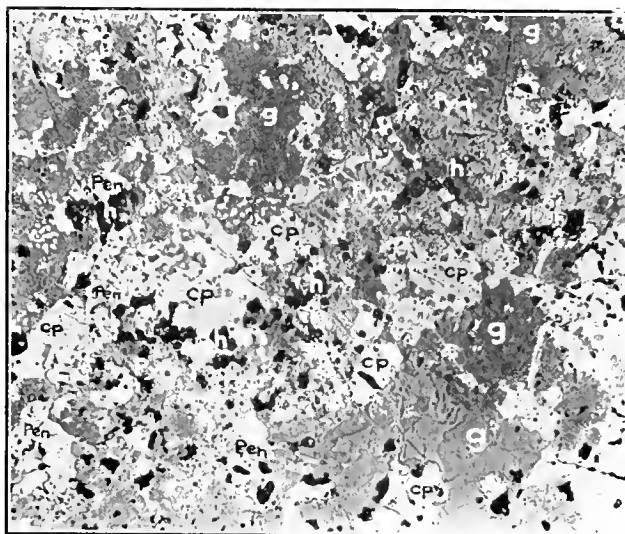

MICRO-PHOTOGRAPH OF ORE FROM CREIGHTON MINE, SUDBURY.
 g is gangue, feldspar, and hypersthene.
 cp is chalcocopyrite.
 pen is pentlandite.
 pyr is pyrrhotite lightly fumed to give color contrast.
 h is hole in surface.
 Magnification, 19 diameters.

The process for the separation of nickel from copper at Bayonne is based on the fact that the sulphides of iron and copper are soluble in alkaline sulphides, while the sulphide of nickel is not appreciably soluble in these substances. The matte obtained from Sudbury is smelted in a reverberatory furnace with salt-cake and coke for a protracted period, during which the matte is stirred, from time to time, with green poles. The poling thoroughly mixes the substances, and the gases given off from the green wood help the coke in reducing the salt-cake to sulphide. When the process is considered to be complete, the matte is allowed to settle, the lighter sulphides

of iron and copper in solution in sodium sulphide tapped off first, and the heavier sulphide of nickel after. It generally takes at least two treatments to complete the separation. The nickel matte is then desulphurized, and the metal obtained.

At Clydach, the Sudbury matte is pulverized to 60-mesh and roasted to oxide; it is then treated in vats with dilute sulphuric acid, at a temperature of 85° C., which dissolves about two-thirds of the copper oxide, the remainder being so protected by the nickel oxide, which is not appreciably soluble in the dilute acid, that further solution of the copper is prevented. The mixed oxides from this operation are filtered, dried centrifugally, and, without washing, placed on shelves in a tower, and reduced to metal by water-gas rich in hydrogen at a temperature of 250° C. When the reduction is complete the metals are transferred to another tower and subjected to the action of carbon monoxide at a temperature of 50°; the CO combines with nickel and forms carbonyl of nickel, and this gas is transferred to the decomposer, where it passes through granulated nickel at a temperature of 200°. At this temperature nickel carbonyl is decomposed into nickel and carbon monoxide, the nickel is deposited on the granules, which, of course, increase in size, and the CO is returned to the volatilizing-tower, where it combines with fresh nickel, which, in turn, is carried again to the decomposer. A point is reached in the volatilization somewhat similar to that which occurs in the sulphuric acid vats, only the reverse, where the copper forms a protective coat on the nickel, and prevents further attack from the CO; the residual metals are then re-oxidized by roasting, and returned to the sulphuric acid vats. Thus, it will be seen, there is a continual procession of the mixed metals from the roaster to the acid vats, then to the reducer, then to the volatilizer, and back again to the roaster. The final residue, insoluble in acid and unvolatilizable by CO, contains the platinum group of metals. A small quantity of nickel passes into the sulphuric acid, and is recovered by occasionally evaporating the mother liquor to dryness, igniting, and treating the residue as above.

It will be seen, then, that the processes in use for separating the nickel from the Sudbury matte are exceedingly complex. The International Nickel Co. refuses admission to its works, so that the exact method used by the company in producing monel metal, like that of producing nickel, is not known—the description in this article being taken from Andrew Monell's patent specification—but the metallurgist will readily see that the blowing of the nickel-copper matte to blister and subsequent refining presents no serious difficulties, and is infinitely less intricate than the separation of nickel from nickel-copper matte by any known process.

Monel metal is silver-white, but assumes a blackish-gray cast on prolonged exposure to air. It is exceedingly ductile, can be rolled into thin sheets, and drawn into wire so fine that it resembles a silk thread; it resists acids, and, notwithstanding the change in color, appears to be unaffected by the atmospheres of coast and manu-

facturing cities. For these reasons, it makes an ideal roofing material, and can be used in infinitely finer sheets than is possible with copper.

Considerable range in composition of the metal is possible without appreciably affecting its physical properties. The composition varies as follows:

| | % | |
|---------|-------|---------|
| Nickel | 68 | to 72 |
| Copper | 27 | to 32 |
| Iron | 0.5 | to 1.5 |
| Carbon | 0.072 | to 0.15 |
| Sulphur | 0.014 | |

It melts at 1350° C., has an annealing temperature of 875° C., and can be rolled at temperatures between 900° and 1200°. A remarkable quality is that it retains 80% of its tensile strength at 555°, while ordinary steel retains only 7% at the same temperature.

The following are the results of physical tests

| | Hot-rolled rods. | Sand-cast rod. |
|--------------------------------|------------------|----------------|
| Elastic limit, pounds | 58,873 | 37,427 |
| Breaking strength, pounds | 86,899 | 78,236 |
| Elongation in 2 in., per cent. | 40 | 38 |
| Reduction of area, per cent. | 60 | 34 |
| Specific gravity | 8.94 to 8.95 | 8.86 to 8.87 |

Modulus of elasticity, 22,000,000 to 23,000,000 pounds.

Electrical resistivity, 256 ohms per mill-foot.

Electrical conductivity, 4 when copper equals 100.

Thermal conductivity, 29 when copper equals 100.

It will be noticed, in looking at the analyses of the Sudbury ores, that they contain more iron than many ores that are smelted for the production of that metal, and if roasted they would be fairly rich iron ores. Some time ago, experiments were conducted under the auspices of the Mines Branch of the Canadian Department of Mines with a view to making nickel-steel directly from the Sudbury ores, and samples of the briquetted roasted ore and pig produced were on exhibit at the Canadian Pavilion at the P. P. I. E. But there the research appears to have ended, on account, I believe, of the copper, as well as the nickel, going into the pig. The slagging off of huge quantities of iron when nickel-steel is in so great demand seems wasteful, and, one would think, research should be stimulated with the view to making nickel-steel, like monel metal, direct from the ore. Nor, theoretically, would the problem seem to present insurmountable difficulties. Microscopic examinations have proved clearly that the nickel and the copper of the Sudbury ores occur independently of each other, so that the difficulty encountered in treating roasted matte with dilute sulphuric acid in the Mond process—that is, the protective coating of nickel oxide preventing part of the copper going into solution—would not be expected in leaching the roasted ore with sulphuric acid to remove the copper. If the copper could be removed in this way, it should be possible, one would think, to briquette and smelt the ore, or convert it into an iron-nickel sponge, and recover both iron and nickel in the operation. There are other methods of eliminating the copper and subsequently reducing the iron and nickel together, which will occur to the metallurgist.

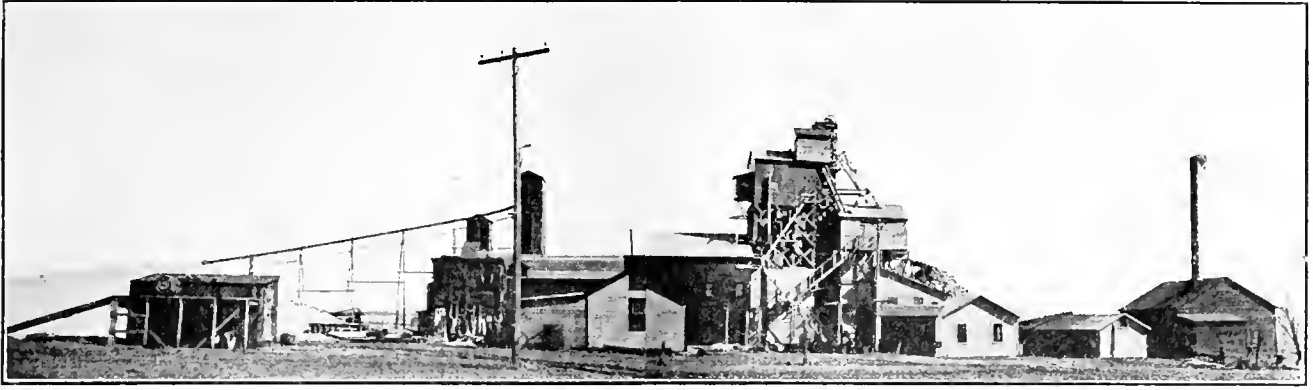

WEST SIDE OF THOMPSON MILL.

Concentration of Zinc Ore in Wisconsin

By H. P. Wherry

WITHIN the last year two interesting articles have appeared on the mining and ore-dressing practice of the zinc mines in south-western Wisconsin.* At the time these were published the Thompson mine of the Field Mining & Milling Co., at New Diggings, was being made ready for operation. The methods adopted being distinctly different from any in the district, it is the object of this paper to discuss them in relation to the established practice as described in the two papers mentioned.

Before I decided upon the method and the machinery to be used, I visited the neighboring mills. The essential points brought out by this investigation were: (1) All the ore, coarse and fine, passed through the crusher and thence through a large set of geared rolls, set so that the face of one shell was in contact with the face of the other; in fact, in the majority of the mills of the district all the rolls are so set, an arrangement that must tend

to make an excessive amount of fine; (2) after passing this first set of rolls, the ore was screened in a trommel, the undersize of which went to a jig where coarse and fine material received the same treatment; this required that the jig be so operated as to save the coarse blende, while the fine blende had to take care of itself, so that a part of it was saved, but the remainder was carried into the tailing and was the principle source of loss; (3) although sand jigs were used to treat the re-ground middling from the jigs, no effort was made to concentrate this fine product, which was either lost as tailing or run into a settling-pond from which the water was returned to the mill and the settled sludge periodically washed to waste.

Having these facts in mind, the mill, which was to have a capacity of 500 tons in 24 hours, was designed with the idea of making as small an amount of fine product as possible, as well as to produce the highest grade of concentrate consistent with the maximum zinc recovery. When it was completed, the system was as follows:

The ore was hoisted, in cars by means of self-dumping cages, to an inclined grizzly that fed into a 14 by 18 in.

*'Mining and Milling of Lead and Zinc Ore in the Wisconsin District,' by Clarence A. Wright. Tech. paper 95, Dept. of the Interior, Bureau of Mines, 1915.

'The Wisconsin Zinc District,' by H. C. George, *Eng. & Min. Jour.*, Aug. 21 and 28, Sept. 1, 1915.

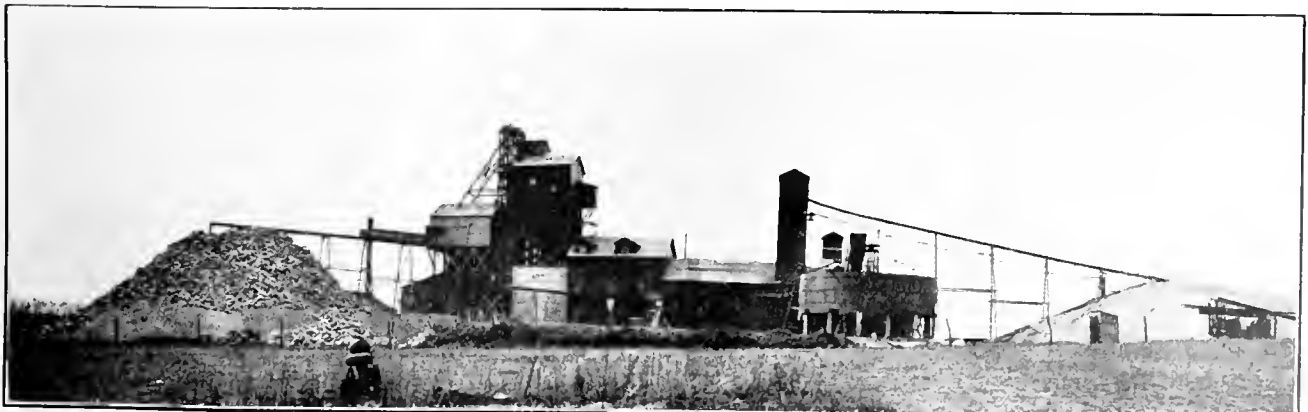

EAST SIDE OF THOMPSON MILL.

Blake crusher, placed on the top of the mill bin. This bin is 20 ft. cube, with an inclined bottom and is set 26 ft. above the ground. The bars of the grizzly were spaced 2½ inches apart; when the car was dumped the fine ore passed through into the bin, where it was mixed with that which was crushed. No sorting was done.

From the mill bin, the ore was fed by an automatic plunger feeder to No. 1 trommel, 3 by 4 ft., having $\frac{3}{4}$ in. round openings. The undersize of this trommel went to No. 2 trommel and the oversize to a shaking launder, which conveyed it to a 24-in. Symons disc crusher set with a 2-in. opening. It then passed to No. 1 elevator, which discharged into No. 2 trommel. This trommel was 4 by 9 ft.; the first half of it was covered with a screen of $\frac{3}{4}$ in. round openings, while the other half was covered with a screen of $\frac{1}{16}$ -in. openings; the undersize of the first screen going to the fine jig; the oversize to the $\frac{1}{16}$ -in. screen, the undersize of which fed the coarse jig while the oversize passed to a set of 14 by 24-in. high-speed Chalmers & Williams rolls, set with $\frac{1}{4}$ -in. openings; these rolls discharged into No. 1 elevator.

At the tailing-end of each jig was a settling-box, the overflow of which went to a sump, from which it was pumped by a Butters 6-in. centrifugal pump to a Dorr thickener 10 by 40 ft. The overflow of this thickener supplied the jigs with water; the underflow fed a Deister double-deck simplex slime-table.

The jigs were of the Cooley type having eight cells 36 by 40 in., using punched-plate screens. The plungers of the coarse jig had a stroke of one inch, making 138 r.p.m.; the first cell had a $\frac{3}{16}$ -in. screen and the others had $\frac{1}{4}$ -in. screens. Concentrates were taken off the screens of the first six cells, as well as from the hutch of cells No. 2, 3, 4, 5, and 6; the product from the hutch of the first cell going to No. 1 elevator. The product off the screen, as well as the hutch, of cells No. 7 and 8 went to No. 3 elevator, which delivered its material to 18-in. geared rolls, set with shells in contact. The product passing the rolls went to No. 1 elevator.

The plungers of the fine jig had a stroke of $\frac{3}{4}$ inch, making 195 r.p.m.; the first and second cells had a $\frac{1}{2}$ -in. screen, while No. 3, 4, 5, 6, and 7 had $\frac{3}{16}$ -in. screens and No. 8 a $\frac{1}{2}$ -in. screen; nothing was taken off the screen of the first two cells, but concentrates were taken off the screen of cells No. 3, 4, 5, and 6; from the hutch of the first cell a lead concentrate was drawn, while the product from the hutch of No. 2 cell went to No. 1 elevator; the hutch of cells No. 3, 4, 5, and 6 produced concentrates; the product off the screen as well as the hutch of cells No. 7 and 8 went to No. 3 elevator.

The Disc crusher and the trommels received water from a 3-in. American Well Works centrifugal pump, taking water from the discharge of the mine-pumps.

The crushing and screening section of the mill was driven independently of the concentrating section, each section being driven by a 50-hp. motor, the object being to prevent losses caused from stopping the mill, for at such times the jigs become overloaded with material and at the time of starting up there would be a rush of

water and more material to the jigs, whereby a large part of the ore on the jig is washed away before it can be concentrated. By starting the concentrating section first and supplying water for concentration while the crushing section remains idle, a large part of this loss is eliminated.

After the mill had been in operation a month, it was demonstrated that the feed to the coarse jig carried a certain amount of fine material that passed through the jig-screens, causing the concentrate of the entire mill to carry a high proportion of lime, as 40% zinc and 4% lime; also that so much water went to the fine jig that the top-water was excessive and thus did not allow the fine material to settle in the jig-cells, but washed it into the tailing. The Dorr thickener proved most beneficial, being able to handle *all* the waste water of the mill (except that lost in the tailing), recovering it as a clear overflow, while its underflow made a satisfactory table-feed and obviated the necessity for a sludge-pond with its periodic cleaning, but the arrangement of connecting its overflow direct to the jigs made a poor water-supply system, especially as in the mine there was a shortage of water, which prevented regulating a steady flow to the mill; in fact, the entire arrangement was such that if either the mine-pumps or the Butters pump stopped there was no water for the mill, thus causing choked and overloaded machines that had to be put in a normal condition before the mill could again be started.

In order to make a cleaner concentrate on the coarse jig and reduce the losses of the fine jig, No. 2 elevator was built and the flow was changed from the original system as follows: the undersize of the first half of No. 2 trommel is sent to No. 2 elevator, which discharges into a settling-box at the head of the fine jig; the settling-box discharges through the spigots onto the jig, while its overflow goes to the sump of the Butters pump; the hutch of the second cell of the fine jig is sent to No. 2 elevator as well as the hutch of cells No. 1 to 6 of the coarse jig and the product of the 18-in. rolls. The concentrates improved to 47-50% zinc, and 1.5% lime.

The water system was also changed; the 3-in. centrifugal pump was discarded; at the side of the mill a pond 50 by 100 ft. was built, into which the mine-water is pumped and the overflow of the Dorr thickener discharges. The water from the pond is then pumped by a 6-in. American Well Works centrifugal pump to the different machines.

After these changes, tests were made on the work of the mill, and the following facts were brought out: (1) the mill-feed assayed 6.9% zinc, while the tailing assayed 1.2% zinc, an 82.50% recovery; (2) the tailing from the coarse jig represents three-quarters of the mill-tailing and assayed 0.6% zinc; (3) the tailing from the fine jig represents one-quarter of the mill-tailing and assayed 3.1% zinc; (4) of the fine-jig tailing 45.81% was coarser than 1 mm. and assayed 0.9% zinc, while 54.19% was less than 1 mm. and assayed 5.6% zinc. It was evident that although the recovery was good there was an opportunity to increase it with an added profit, provided the

blende in this fine product could be recovered as a marketable concentrate; to accomplish this, it would be necessary to remove this fine material from the feed of the fine jig by screening and then treat it upon sand-tables. I had already experimented with a sand-table on the fine material being lost at the mill of the Crawhall mine, belonging to the same company, where the 'rougher and cleaner' system was practised, and, by recovering from the mill-tailing $2\frac{1}{2}$ –4 tons per day of concentrate assaying 38–42% zinc with 2.5–3.0% lime. I had demonstrated that a sand-table could be operated

product to be treated, so that the finer blende has a much higher percentage of pyrite associated with it than the coarser variety.

In order to use the sand-tables, a trommel 30 by 48 in. with a $\frac{1}{2}$ -in. round hole screen was placed to receive the discharge from No. 2 elevator; the oversize of the trommel being sent to the fine jig, while the undersize goes to four Deister cone-baffle classifiers; the undersize of the first two classifiers feeding No. 1 Deister double-deck sand-table, the next two classifiers feeding a second sand-table; the overflow of the two classifiers going to

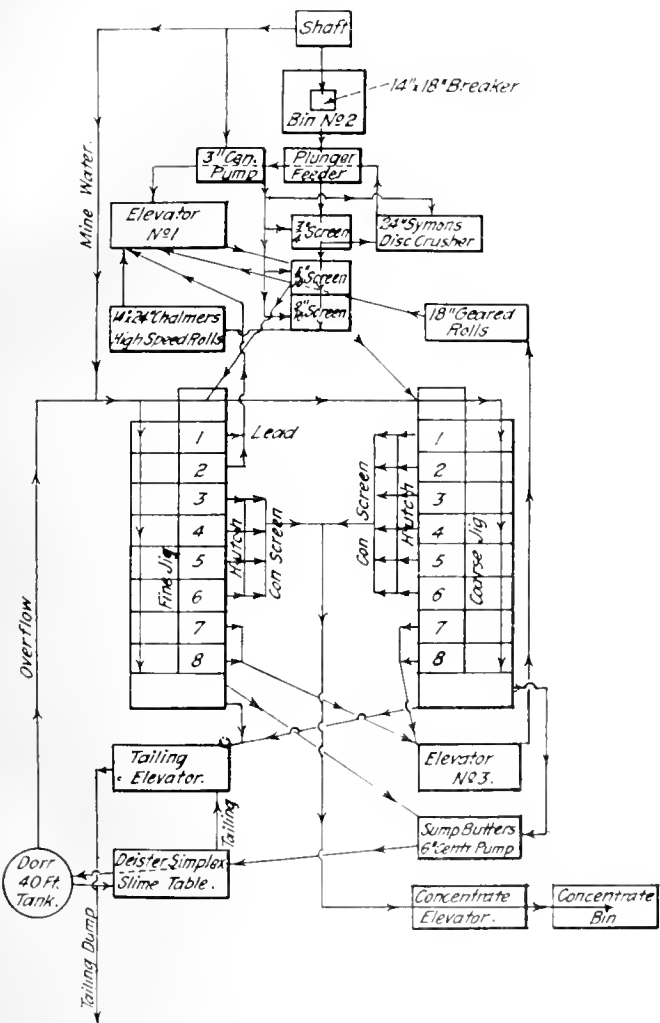

ORIGINAL FLOW-SHEET OF THOMPSON MILL.

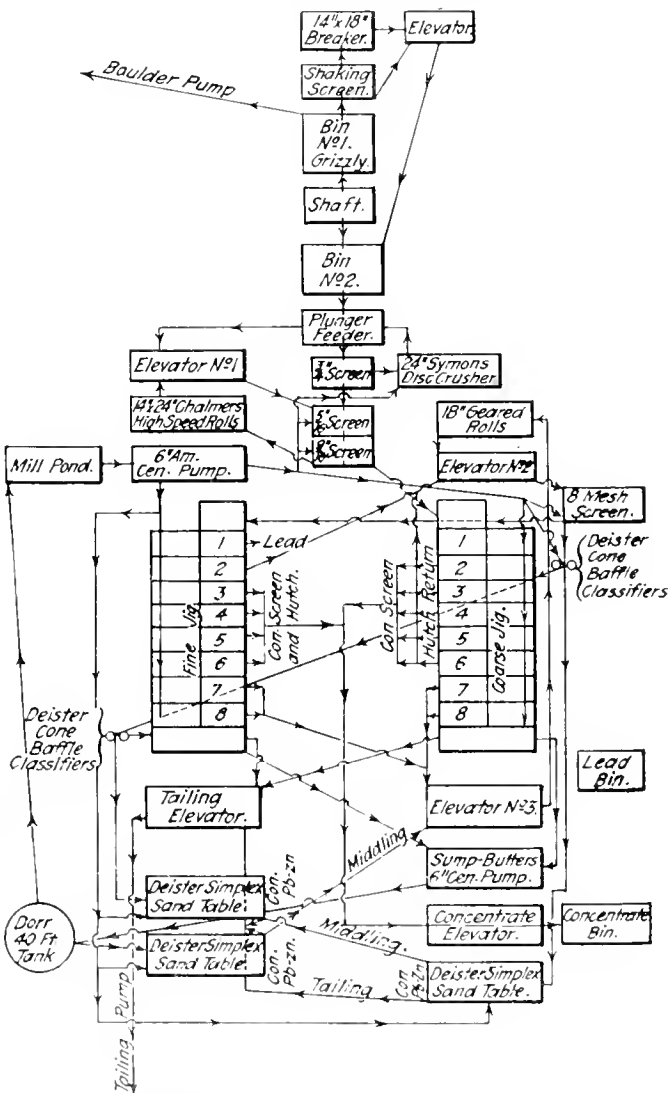

PRESENT FLOW-SHEET OF THOMPSON MILL.

successfully; hence there was no question but that tables could recover the fine material being lost on the fine jig of the mill under discussion. I had also proved in both mills that the slime-table recovered so small an amount of concentrate, which was of such a low grade, 16.75% zinc and 6.2% lime, that it did not pay to treat this material on a separate table, but that it could be handled better by mixing with the feed of a sand-table. The low grade is partly due to the fact that the country-rock of the district is impregnated with extremely fine iron pyrite, which during crushing concentrates in the finest

the Dorr thickener by way of the Butters pump, the discharge of the thickener feeding a third sand-table. All the tables were so rifled as to make a separation between the lead and zinc. The middling from the tables goes to No. 3 elevator to be returned again to the system.

When the tables were tried with this arrangement, it was discovered that the material passing the $\frac{1}{2}$ -in. screen made too coarse a feed for the first table: it was impossible to make a clean separation between the gangue and the minerals; the $\frac{1}{2}$ -in. screen was therefore changed to an 8-mesh wire-cloth screen with 0.078-in. openings; the

product from this was also too coarse, with the result that the concentration was most unsatisfactory. The difficulty was overcome by passing the undersize of the 8-mesh screen to one classifier, the underflow of which joined the oversize of the screen as feed to the fine jig, the overflow passed to a second classifier whose underflow fed the first table. This gave material that the table handled with excellent results; the other two tables operated well from the beginning, the only alteration being in the ridding to improve the separation of the lead from the zinc.

Tests lasting 24 hours were made on the work done by the tables, samples also were taken of the fine-jig tailing and the mill-tailing; the results of these tests are shown in the tables below. During these tests from 4 to 5 tons of concentrates were made in each 24 hours. It will be noted from statement A that the table-feed is practically all less than 20-mesh (1 mm. size); evidently from the difficulty in concentrating material coarser than this size, it is necessary to feed the tables with as little material larger than 1 mm. as possible. Statement B shows the lime in the concentrate to be as low as generally obtained in a jig-concentrate; the lead is a little too high on table No. 1, but it should be possible with careful attention to reduce it to that made by table No. 2; table No. 3 makes a concentrate lower in zinc than the others, because it receives in its feed all the slime of the mill through the Dorr thickener, and this material not only increases the iron in the concentrate, but also causes a tailing of high zinc-content. Statement C compares the sizes from the fine jig before and after the tables were used. Statement D compares the percentage of zinc in the tailing of the fine-jig and mill tailing before and after the tables were used. The results need no comment.

In the articles to which reference has been made, it will be noted that it is stated that the operators have not been able to obtain a clean concentrate from tables, for which reason they are not used in the district, the practice being simply to save as much of the fine material as possible on the jigs. The work done by the sand-table at the Crawhall mill, together with the results from the Thompson mill, as given above, disprove this contention. What has been done at these mills only illustrates what can be done at other mills in the district, as is further proved by the fact that the tailing formerly produced and in some cases that now being produced is being re-treated with jigs at a good profit. The further argument, often heard locally, that table-concentrates are too low in zinc and too high in lime to pay for operating tables, is also a fallacy. The lime can be held within the necessary limits by setting the tables to throw part of the blende into the middling product for re-treatment on the table; as to the percentages of zinc, table-concentrates are a few points lower than that of jig-concentrates and in most cases would have to be roasted; however, it is to be noted that few of the mills produce a concentrate sufficiently high in zinc to be sold direct to the smelter without roasting—it must be roasted; if the concentrates

STATEMENT A

Screen-Analyses

| Mesh | Table 1 | | | Table 2 | | | Table 3 | | |
|------------------|---------|--|--|---------|--|--|---------|--|--|
| | % | | | % | | | % | | |
| On 10..... | 0.0 | | | 0.0 | | | 0.0 | | |
| " 20..... | 3.7 | | | 1.9 | | | 1.8 | | |
| " 40..... | 18.0 | | | 7.1 | | | 6.6 | | |
| " 80..... | 36.4 | | | 36.7 | | | 14.7 | | |
| " 100..... | 7.7 | | | 7.5 | | | 3.8 | | |
| Through 100..... | 34.2 | | | 46.5 | | | 79.1 | | |
| Total | 100.0 | | | 100.0 | | | 100.0 | | |

STATEMENT B

Mineral Contents of Table Products

| | Feed | | | Concentrates | | | | Tailing | |
|--------------|-------|-------|-------|--------------|-------|-------|---------|---------|--|
| | Zn, % | Fe, % | Pb, % | Zn, % | Fe, % | Pb, % | Lime, % | Zn, % | |
| Table 1..... | 7.3 | 3.8 | 0.30 | 35.9 | 18.4 | 1.30 | 1.8 | 2.50 | |
| " 2..... | 6.0 | 3.5 | 0.16 | 35.1 | 18.6 | 0.14 | 2.1 | 2.26 | |
| " 3..... | 5.0 | 7.5 | 0.12 | 21.8 | 28.3 | 0.66 | 1.5 | 4.10 | |

STATEMENT C

Screen-Analyses of Fine-jig Tailings

| Mesh | Before concentrating tables were in use | | After concentrating tables were in use | |
|------------------|---|--|--|--|
| | % | | % | |
| On 10..... | 36.8 | | 31.8 | |
| " 20..... | 33.0 | | 30.9 | |
| " 40..... | 12.1 | | 21.5 | |
| " 80..... | 4.0 | | 10.7 | |
| " 100..... | 5.1 | | 9.7 | |
| Through 100..... | 9.0 | | 1.4 | |
| Total | 100.0 | | 100.0 | |

STATEMENT D

| | Fine-jig tailing Zinc % | Mill-tailing Zinc % |
|---|-------------------------|---------------------|
| Before concentrating tables were in use.... | 3.1 | 1.8 |
| After concentrating tables were in use.... | 1.2 | 0.8 |

from the jigs must be roasted, there is no valid reason why as much concentrate as possible (in some cases 2 to 4 tons per day), should not be saved from the fine material now lost in the tailing, and roasted, thereby yielding a profit. It may be argued that too much of this fine concentrate would be lost in roasting; this has not been found true in our case, for we have roasted many tons with a recovery of 85-87% on the fine concentrate as against 90-92% on the regular mill-concentrates, the former assaying 55% zinc, 2.8% iron, 3.85% lime, and 2.5% lead, as against 58% zinc, 2.1% iron, 3% lime, and 0.8% lead in the latter. However, if the jigs produce a concentrate sufficiently high in zinc to be shipped direct to the smelter, the tables will also produce a correspondingly high concentrate.

It has also been argued by the operators that it is not possible to size the ore before concentration, and produce as good a concentrate as by the systems now in general use; that, if it were possible, the cost of building a mill along these lines would entail too high a first cost. The work at the Thompson mill has conclusively shown that a higher recovery can be made and a concentrate with a lower percentage of lime, and a proportion of lead as

low as that made by the other systems, can be produced by the method of sizing. Further, the first cost of the mill should be no higher than that of the mill built on the lines of established local practice; no more machinery is required than in mills using the 'rougher' and 'cleaner,' or 'one jig' systems; in fact, smaller jigs can be used when sizing, to do the same work as that done by the larger and therefore more expensive ones at present in use; nor does the first cost greatly affect a decision when it is understood that the local practice is to move the equipment of one mine to a new one when the former is no longer productive.

Several tests were made to determine the amount of fine material produced by the system of screening in connection with the use of the Symons disc crusher and rolls spaced between the shells. It was first determined that of the ore hoisted from the mine and delivered to the primary crusher (Statement E), 4.38% would pass a 1-mm. screen; that after passing through the disc crusher and rolls, the feed to the jigs (Statement F) contained 27.83% of product less than 1-mm. size; that, therefore, the crushing machine produced 23.45% of this product. As in one of the articles* mentioned, all the screen-analyses shown were made upon the jig-tailing, a set of screen-analyses was made on the combined jig-tailings, with the result as shown in Statement F. It will be noted that the product less than 1 mm. (that is, on and through the 40-mesh screen) is 12.03 points higher in the jig-feed than in the tailing; this was to be expected in view of the greater friability of the zinc-blende than that of gangue. It will also be noted in comparing this statement with those in the above mentioned article, that this size of product in the jig-feed is in two cases greater than, in one case equal to, and in three cases less than the same product shown in those tabulations; while in the jig-tailing (Statement F), which is the same material as that of the tabulations under discussion, it is 6.8 points lower than the best result given in those tabulations. It would therefore seem that the system of screening and crushing practised in this mill reduced the amount of fine material to a marked degree.

The method of dumping the mine-cars direct to the primary crusher, which was set on top of the ore-bin, developed some bad features: (1) when the crusher was operating, it was impossible to keep the bin from vibrating, the vibration being transmitted to the concrete pillars even when the bin was cross-braced, as shown in the accompanying photograph; (2) if the crusher was out of commission, for any cause, hoisting ceased, or if hoisting stopped, the crusher was idle; (3) it required five men to feed the crusher and break the large rocks that were too large to enter it; (4) it was impossible to sort out barren rock (although tests showed that from 15-20% of the ore hoisted consisted of large rocks containing no zinc), which could have been removed on a sorting-grizzly, thus relieving the crusher of part of its work, while increasing the capacity of the mill.

When it was decided to increase the amount of ore handled to 800 tons in 24 hours it was agreed to change

STATEMENT E

Screen-Analysis on Ore as Hoisted from the Mine

| | % | | % |
|-----------------|-------|------------------------|-------|
| On 3/4-in. | 85.10 | On 1-mm. | 1.31 |
| " 1/2 " | 2.16 | " 40-mesh | 0.90 |
| " 1/4 " | 3.20 | " 100 " | 1.17 |
| " 3/8 " | 1.46 | Through 100-mesh. | 2.31 |
| " 1/8 " | 1.23 | | |
| " 2-mm. | 1.08 | Total | 99.92 |

STATEMENT F

Screen-Analysis

| | Combined jig-feeds % | Combined jig-tailings % |
|-----------------------|----------------------|-------------------------|
| On 1/2-in. | 1.60 | 1.60 |
| " 1/4 " | 25.91 | 18.40 |
| " 3/16 " | 16.53 | 30.20 |
| " 1/8 " | 13.56 | 22.20 |
| " 2-mm. | 5.99 | 5.60 |
| " 1 " | 8.56 | 5.70 |
| " 40-mesh | 7.37 | 2.90 |
| " 100 " | 10.76 | 4.30 |
| Through 100-mesh | 9.70 | 8.60 |
| Total | 99.98 | 99.50 |

the primary section along the lines contemplated when the mill was being designed, although the original idea of a belt-conveyor had to be withdrawn in favor of a stone-crushing plant elevator. The change consisted in building a storage-bin, covered with grizzly-bars, set 5 inches apart, for the cars to dump upon; here the barren rock is sorted out, loaded into the cars and dumped on the waste-rock pile; the large pieces containing blende being broken on a part of the grizzly separated from the dumping and sorting parts. The rock from the bin is fed by a shaking screen having 2-in. round openings, to a 14 by 18-in. Blake crusher; the undersize of the screen and the ore passing through the crusher unite in a catch-box that feeds the stone-elevator and is then conveyed to the mill-bin. By this arrangement, the hoisting can be done independently of the crusher, which can be in operation continuously, if necessary; the mill also has a large storage-capacity in case of delays in hoisting; the crusher can operate continuously and independently of the mine, thus having more working-hours; it can handle more ore and break it to a smaller size better suited for the disc crusher, and thus doing more and better work. In other words, it makes a flexible system, while increasing the capacity of the mill without additional machinery in the concentrating plant proper.

The hoisting equipment at the mine consists of a double-drum electric hoist, made by the Ottumwa Iron Works; both drums are rigid upon the same shaft. This is objectionable, for in case of an accident one cage may have to remain idle, or if trouble arises with one of the drums, there is no means of operating the other drum. Cars of a capacity of one ton are used in the mine and are hoisted in self-dumping cages. At the Crawhall mine, cars of 1 1/2 tons capacity, built to dump as a skip, are used, hoisting being done through an inclined shaft. The experience with the large cars, in both mines, is that they have no advantages over the bucket generally used

in the district but possess some disadvantages; being large and heavy it requires two men to a car; as the men do not like this arrangement, there arises the question of labor difficulties, they permit the men to load rock too large to be handled satisfactorily on the sorting grizzly, the cars, when loaded with large rock, are in reality but partly filled, they are not as easily handled in the mine as buckets nor is it possible to hoist a larger tonnage with them than with the buckets.

The self-dumping cages work well but have the drawback that during winter weather the locking-dogs become frozen, rendering dumping difficult and operation unsafe; it was necessary to board the entire head frame to overcome this trouble; even then, it was only partly successful. The skip-cars do not give this trouble, but the inclined shaft is an unnecessary expense with no advantages over the vertical shaft to recommend it, as applied to the type of ore deposit obtaining in this district.

In conclusion, the new features in the mine equipment are the large cars and self-dumping cages, neither of which have any distinct advantage over buckets, but, on the contrary, are not quite so satisfactory.

The new features embodied in the mill are as follows: a separate motor for the crushing and concentrating sections; the use of a plunger-feeder, which gives the mill a steady feed—an indisputable benefit; sizing, the ad-

vantages of which have been discussed; separating the fine material of $\frac{3}{4}$ -in. size, and less, as soon as it enters the mill, from the product delivered to the Symons disc crusher, which together with the system of screening reduces the work of, and the wear of, the crushing machines; the use of the disc crusher in place of the rolls, which follow the primary crusher in the general mill-practice of the district; and the use of high speed spaced rolls in place of geared (closed and spaced) rolls for re-grinding the oversize product of the screens, which machines in connection with the screening arrangement have markedly reduced the proportion of fine material usually produced; the application of the Dorr thickener instead of a sludge-pond, thus saving a large amount of water while furnishing a good feed to concentrating tables; the introduction of concentration for treating the fine material not saved by the jigs, whereby a marketable product is produced, thus increasing the recovery of zinc and therefore an increased monetary return.

It has been the desire of this paper to present the results of an ore-dressing system new to the district, bringing out some of the difficulties encountered and overcome; its development, advantages, and disadvantages, as compared with other methods in use, trusting that it may be of benefit to others who are working for a higher concentration and a better recovery of the zinc-blende from ores of this type.

Quantitative Analysis for Tungsten*

AQUA REGIA METHOD. This method is old, but is used by many chemists who claim it will give good results. The finely powdered mineral is digested with a mixture of four parts of concentrated hydrochloric acid and one part of nitric acid, until it is completely decomposed; the solution is then evaporated to dryness, which operation should be finished on the water-bath, the chloride of manganese and sesqui-chloride of iron dissolved out, the tungstic acid filtered off, washed with alcohol, dissolved in dilute ammonia, separated by filtration from the columbic acid, the solution evaporated, the residual ammonia-salt ignited with access of air, and the tungstic acid weighed.

FRITCHERLE'S METHOD. This is the standard method for the determination of tungsten in ores, and is given in many publications, sometimes with slight modifications. It is as follows: Weigh into a platinum dish, or crucible, of about 25 cc. capacity, 0.5 gram of the finely powdered ore, add equal quantities of hydrochloric acid and hydrofluoric acid, and digest at slow boiling temperature for about one hour, or until the ore is all in solution, adding from time to time more of each acid. Evaporate down to about half the original volume, to displace the silicon fluoride and excess of hydrofluoric acid. The dish should be covered to prevent loss by splattering.

*Abstracts from Colorado School of Mines Magazine, tungsten and molybdenum number.

The two acids will entirely dissolve most ores, excepting those containing tin oxides, in which case it will be necessary to filter off the insoluble residue.

Transfer the solution to a No. 3 beaker, add 20 cc. hydrochloric acid and 8 cc. nitric acid, cover and boil down to about 10 cc. to expel all fluorine; the tungstic fluoride will be converted into chloride, and in the presence of nitric acid will be precipitated as tungstic acid, H_2WO_4 . Dilute with 50 cc. of hot distilled water, and boil slowly for about half an hour, or until the tungsten is all precipitated, when the beaker should be set back, and kept just below the boiling-point until the solution has cleared. Filter through a Gooch crucible, using an asbestos felt, wash well with hot water, dry, ignite at white heat for five minutes, cool and weigh as WO_3 .

ZELLNER'S VOLUMETRIC METHOD. Zellner describes a volumetric method for use where great accuracy is not required. Fuse the weighed and powdered ore in a platinum crucible with three parts sodium carbonate and one part potassium nitrate; cool, dissolve the melt in hot water and filter. Acidify slightly with acetic acid, dilute to 200 cc., boil, and while boiling titrate with a standard solution of pure crystallized lead acetate. This consists of 16.3 grams of the salt, in one litre of water slightly acid with acetic acid. When titrating, a white precipitate forms and settles rapidly on stirring. The end point is the absence of the formation of precipitate and cloudiness.

[Prospectors preferring a rapid method for determining tungsten quantitatively may refer to the instructions by M. L. Hartmann in the issue of April 15.]

The Law of Mines

By Franklin Wheaton Smith

INTRODUCTION. Although the Law of the Apex from the miner's point of view, has not exactly "brought death into the world and all our woe," it has for many years been anathema to the majority of mining engineers and managers. It has cost mining investors a pretty penny in funds raised or dividends withheld to meet the expense of litigation. It has resulted in the suspension of work for years at a time in not a few good mines. It has caused the paralysis of districts.

THE LAW OF THE APEX. The national mining law is still the inadequate patchwork of 1872. Most of the act is commonplace enough. It prescribes what shall be a valid location, how the ground must be marked, held, and how title in fee simple may be acquired. The maximum size of a claim is 1500 by 600 feet. The end-lines must be parallel. They are assumed to be approximately at right angles, and the side-lines approximately parallel with the vein. It is the ordinary furniture of an ordinary house. But in the middle of the first room is placed Pandora's box. Its mischief-breeding content is this: "The locators * * * shall have the exclusive right of possession and enjoyment of all surface included within the lines of their location and of all veins, lodes, and ledges, *throughout their entire depth, the top or apex of which lies inside of such surface lines extending downward vertically, although such veins, lodes, or ledges may so far depart from a perpendicular in their course downward as to extend outside the vertical side-lines of said surface locations.*"

This right to follow the vein down its slope or dip to any depth, into ground owned by others is called 'extra-lateral right.' No miner may follow his vein horizontally beyond vertical planes projected through his end-lines. If veins were simple continuous sheets of ore between definite walls of rock it would be possible to start at their upper edge or outcrop and follow them to any depth. Few are of that type; many of our largest mines are exploiting orebodies that do not resemble even remotely the vein type. Gold-quartz veins approach the ideal form most nearly, but the task of following such a vein from the surface to great depth is often difficult. Orebodies are not continuous, but are lenses within the vein-fissure. Around their edges the vein may be barren quartz or merely crushed wall-rock. In one vein, between two ore-shoots, each a quartz body several hundred feet long and ten feet thick, the vein was represented by a fissure only an inch wide. When there are several veins in a system it is easy to go astray. Intersections often take such form that the apex may belong to either branch. Under the mining laws of Mexico, for example, or Canada, no trouble could follow. Vertical

planes through all boundaries limit mining rights in those countries. But under our muddle-headed statute the question of ownership would probably be decided by an expensive lawsuit. Perhaps the winner would take over the entire property of the loser in settlement of claims.

The variety of puzzling litigation-breeding problems that can arise is endless. After 43 years of experience with that statute new phases of the question still appear. Few large mining camps have escaped apex litigation between leading companies. Discord between strong interests in a small community may breed many evils, even may poison the political life of an entire state.

HISTORY OF THE LAW. The act of 1872 is defective in other ways, but the Law of the Apex has generated most of the negative blessings that have been invoked on its framers. The history of its origin tells a tale of the results of depending on the Anglo-Saxon genius for muddling through somehow.

The Act applies to no State east of the Mississippi, nor to Minnesota, Missouri, Kansas, and Texas. It was extended to Alaska in 1884.

The mining industry of the Far West was born in California. Gold was discovered in 1848, two weeks before the treaty of Guadalupe Hidalgo transferred to the United States more than half a million square miles of territory, the spoils of the Mexican war. The military governor of California proclaimed the repeal of the Mexican mining laws, but offered no code in their stead. A multitude of gold-seekers swarmed into the new land and took the whole West for their field. At first placer mining absorbed attention. Gold-bearing quartz veins soon were discovered and deeper mining began. In 1859 the rich silver mines of the Comstock lode were discovered in Nevada. Soon miners and prospectors were working over an area comprising one-third of the territory of the United States. Technically they were trespassers on the public domain. Under the laws then existing, only agricultural land could be taken up. Mineral lands were expressly excepted from the operation of the Pre-emption Act of 1841. Congress took no action. This region was remote. Few, if any, members had the knowledge requisite for adequate and wise legislation. The miners were left to 'muddle through' by themselves. They did exceedingly well; they framed laws and regulations adequate for local needs and pushed the development of the West with unexampled speed. When the lawless element seemed in danger of getting the upper hand, when murder became so common that it would be commented on casually in the phrase "Man for breakfast this morning," then the better element drew together, vigilance committees were formed

and the bands of murderers and highwaymen were summarily exterminated.

Each mining district drew up and enforced its written code of regulations. They aimed to secure fair rights and equal opportunity between man and man to explore, develop, and produce. There was variation in detail, but the underlying principle was the same in the thousand or more districts scattered over the mountains and deserts of the West. That principle, old as mining and basic in the laws of other countries, was that ownership was founded on mineral discovery followed by active development. The regulations permitted the holding of the surface necessary to mining operations. Each locator, except the original discoverer, was limited to one claim on any vein. Its length varied, but rarely was over 300 feet.

Here then were conditions under which surface titles were not to be had; the veins were considered, in effect, as movable property apart from the ground containing them; each locator was limited to one claim of short length along the vein. Under these conditions and dealing chiefly with one class of metalliferous deposits (narrow well-defined veins) the idea of extra-lateral right was adopted. The source of this principle is not known. If it was not a spontaneous development, it may have been suggested by English miners, since in one district in Derbyshire it was the custom in certain lead mines. It was also embodied in the mining law of Sweden, but was abolished in part in 1825 and completely in 1885. It is not probable that any of the pioneers knew that a similar law had been in force in Prussia in the 16th and 17th centuries, but had been repealed because of the interminable litigation it had fostered. British Columbia adopted the principle from our law, but dropped it a few years later because it proved a bountiful mother of lawsuits.

After 18 years of active development under these regulations, reinforced by State legislation giving them legal standing, came the first national mining act, that of 1866. It permitted the purchase of mineral land, granting a patent in fee simple after certain regulations had been complied with and the land paid for at the rate of \$5 per acre. In effect it was a summary and average of local regulations supplemented by a land act throwing open the mineral-bearing portion of the public domain. It perpetuated the principle of extra-lateral right. Senators Stewart of Nevada and Comness of California were its chief sponsors. They believed in things as they were, but realized the need for clear titles. At that time litigation on the Comstock lode, with its source in the insecurity of simple possessory titles, was on a scale comparable with the battles fought years afterward at Butte. But he it noted that the latter had their chief source in the Law of the Apex, which became a fearsome thing when applied to the intricate vein systems of that district in Montana.

The supporters of the act of 1866 had to fight proposals to make the sale of mineral lands the source of large revenue. Some advocated selling them to the

highest bidder, regardless of possessory titles. One bill set the minimum price at \$50 an acre. These plans were inspired by the necessity for reducing the national debt incurred during the Civil War. The friends of the Act rightly took the ground that it would be a national calamity to adopt any system that would close the region to the prospector or discourage his efforts. Senator Stewart said: "Miners as a community devote three-fourths of their aggregate labor to exploration, and consequently are and ever will remain poor, while individuals amass large fortunes and the treasury of the world is replenished and augmented." He advocated the principle of extra-lateral right and defended it in these words: "In some cases a person buying a single acre in a rectangular form would have several mines at the surface and none at 500 or 1000 ft. in depth. With such a division of a mine, one owning at the surface and another at a greater depth, neither would be justified in spending money for costly machinery, deep shafts, and long tunnels."

The Act limited the length of a claim to 200 ft., the width being governed by local rules. Each claim, therefore, contained only about one acre. Senator Stewart adhered to the idea of one claim to each locator, and in his mind, seemingly, was the picture of only one type of ore deposit. The huge orebodies of the 'porphyry coppers' were then undreamed of. He summed up the Act by saying: "The plan proposes to allow the miners who have or who may hereafter occupy and improve mines in good faith and according to local rules, to purchase at the rate of \$5 per acre and receive a patent therefor in such form as shall grant the mine with its dips, spurs, and angles to any depth, with such a reasonable amount of surface as the miners shall determine by the local rules to be necessary for the working of the same."

There appears the idea of the vein apart from the land. It has been the source of many troubles. Speaking of the *Sitting Bull* case, nearly twenty years later, Judge Church said: "This case affords another exemplification of the unfortunate results attendant upon the purpose of the Government to dispose of orebodies as things distinct from the soil."

The existing Act "to promote the development of the mining resources of the United States" was passed in 1872. It fixed the present size of claim (600 by 1500 ft.) and set no limit on the number of claims one man might locate, but retained the principle of extra-lateral right. It was time to stop the 'muddling' method of progress, and draft a statesmanlike act that would protect existing interests and encourage development without putting a premium on litigation. The industry was old enough; there were enough able and farsighted men to be called into consultation to have made it possible to draft an adequate act. The opportunity was allowed to pass. In over 40 years there have been no substantial modifications and the Law of the Apex has become the patron devil of the mining industry. It is reviled as such and has deflected attention from other features of the Act that need revision.

LAWS OF OTHER LANDS. Before discussing those features, it may be well to introduce some standard of comparison and touch briefly on salient features of the mining laws of other countries.

The Rand, the greatest gold-producing region in the world, has a series of gold-bearing beds of conglomerate that outcrops for 40 miles and dips steadily away from the surface at a moderate angle. Unit claims are small, only 1.4 acres, but there is no limit to the number that may be held. Vertical planes, projected from boundaries, limit mining rights. Strong companies acquired large holdings from original locators. First came the 'outcrop' mines; back of them the first and second series of 'deep-level' properties opened by vertical shafts. Dikes often accompanied by veins too poor to pay, cut the gold-bearing series. They dip more steeply than the 'reefs,' as the lodes are called, and would offer fine openings for litigation under an apex law. But there is no such law and it has been said: "The excellent character of the mining law of the Transvaal is worthy of more than passing notice. So clear and well-defined is it, that while every square foot of ground is taken up for a length of nearly 40 miles by a width of one to three miles, lawsuits between adjoining companies are practically unknown; and as a result the mining-law expert does not exist on the Rand."

Unless it has been passed within a year, Canada has no Federal mining law although there are acts dealing with phases of the industry. About four years ago an act provided that such a law be drafted and the aid of the Canadian Mining Institute was enlisted. Part of the country will not come under the law; some provinces own the public lands within their borders. In others, British Columbia for example, while the Provincial act will govern the greater part of the area, a Federal act will apply in certain parts. The British Columbia act is that most cited for comparison with our law. Prior to 1892 extra-lateral right was permitted. In that year a non-retroactive law was passed making mining claims 1500 ft. square, and limiting them in depth to the ground within vertical planes passed through their boundaries. The new law has worked well in that respect. As in Mexico, the surface does not pass with the mineral rights. Enough land is allowed for operating needs, the remainder is retained by the Crown.

Of the Mexican law it has been said by a leading authority that it "furnishes the best example of a liberal and progressive system of mining laws of any which has heretofore been adopted in any country." The ownership of all metalliferous deposits on public or private lands is vested in the Nation. Title in fee simple is not granted. The Government gives a perpetual lease for a fixed tax per unit-claim. Failure to pay the tax forfeits the ground. Property rights are secure and mines are transferred as readily as if titles were in fee simple.

The unit claim or *perfozencia* contains 2.47 acres and is a square 100 metres (328 ft.) on a side. There is no limit to the number permitted to one locator. Boundaries bear no prescribed relation to the course of the

deposit. No 'discovery' or proof of mineral character is required. No act on the ground can give title to the locator; his location (denouncement) is made by applying at the proper mining agency for a Government title. Prior to securing title he is prohibited from making any openings more than 33 ft. long or deep and from shipping ore. Mining rights are limited by vertical planes through the boundaries. Surface rights must be acquired by procedure separate from that for obtaining mineral rights. The locator must put up money for his application and pay his annual taxes in cash, as there is no work-equivalent for the latter. This feature bears hard on the penniless prospector. In short, authority is granted to work a prism of ground of definite horizontal dimensions and indefinite vertical depth; instead of a certain length on a vein or lode the underground behavior of which cannot be predicted.

Congress did not impose the Law of the Apex on the Philippines. Claims are square, 300 metres (986 ft.) on a side and vertical planes through their boundaries limit mining rights. Claims are held as in the United States by annual assessment work to the amount of \$100 per claim. A defective feature is that there is no provision for discovery work. By re-locating it is possible to hold ground indefinitely without work. It is necessary, as in the United States, that \$500 worth of development be done before a patent can be obtained. The Philippine government has the right to provide rules for the regulation of mining. The law works a hardship in limiting each locator to one claim on each lode, though this has been decided by the Attorney-General not to prohibit the holding of any number of patented claims by one person or corporation.

[Vertical side-lines apply in Australia and New Zealand. Litigation is almost unknown.—EDITOR.]

THE ACT OF 1872. Aside from the apex feature, the act of 1872 has faults that have in one way or another an unfavorable effect on the industry. The Land Office has full records of patented claims but none at all of claims being held by location and assessment. This places upon the applicant for patent the burden of advertising for someone who may dispute his title.

This bit of dialogue does not exaggerate Uncle Sam's general attitude toward the mineral claimant:

UNCLE SAM: Well, son, what is it?

SON: I want a patent on the Twilight claim in the Moonrise mining district, Apache county, Arizona.

UNCLE SAM: I guess you can have it if you are sure that none of the other boys has beaten you in locating the ground.

SON: Oh, I am sure of that.

UNCLE SAM: I'm not though. I can tell in a minute after your surveys are in if you are trying to take ground I have already sold, but unpatented locations might be ten deep on that Twilight of yours and I'd be never the wiser.

SON: Aren't you rather careless about your property?

UNCLE SAM: Maybe, but I've always had more than

I knew what to do with. Tell you what, though; you go ahead, put up your deposit with the Surveyor-General and pay for the rest of the work. Then before you pay me the \$5 an acre you can advertise your application at your own expense for 60 days. If anybody else thinks he owns that ground he'll probably find out what you are up to and you can settle it between yourselves. My inspectors will drop in and have a look at the ground to see that you are not trying to put one over on me. If no one raises a howl you can have your patent."

DISCOVERY. The Act provides that "no location of a mining claim shall be made until the discovery of a vein or lode within the limits of the claim located." This provision served its turn in the early quartz-mining days but now, like the Law of the Apex, it is a creed outworn.

Cheap transportation and improved technical methods have fostered big undertakings that handle tremendous tonnages of low-grade ore. Copper mining has become a manufacturing industry with scores of millions of invested capital. Great mines have been developed where the barren surface gave promise only to those who could read the obscure signs. In one district this surface may be limestone, tilted, twisted, fractured, perhaps with a little red stain of iron in pockets or along fracture-planes. In another it may be an area of porphyry, fractured, altered, bleached white or stained red, threaded by minute veinlets of quartz.

These mining operations require much capital, large areas, and secure titles, of course. To make it possible to grant the latter, to make the law cover such cases, the word 'lode' has been given the broadest significance. Justice Field ruled that a lode need be neither ore nor an orebody, but was "whatever the miners could follow and find ore." It was decided "that the definition of a lode must always have special reference to the formation and peculiar characteristics of the particular district in which the vein or lode is found." But even so, there have been disputes and under a former administration, decisions of the Department of the Interior, which cannot be appealed to the courts, left miners wondering where they stood.

This is not an attack, direct or indirect, on the principle of Conservation. The question of the comparative value of the land for other purposes would not be overlooked. If the 'discovery' clause were dropped the change would give the miner greater security, but it would foster neither fraudulent locations nor extravagant exploitation of mineral resources. Mineral land costs more than any other kind of land in the public domain. The \$5 per acre paid to the Government is but a fraction of the cost. Including the entire cost of procedure and the \$500 worth of development required, a patented claim of full size (20.66 acres, costs the patentee nearly \$40 per acre.

The demand for a "discovery of a vein or lode" does not exist in the Mexican law; it has been made practically a dead letter in British Columbia. There is a strong sentiment in favor of its omission from the new Canadian act. Certain decisions of the Department of the Interior

between 1910 and 1912 strengthened the sentiment in this country.

POWER OF THE DEPARTMENT OF THE INTERIOR. The Secretary of the Interior holds one of the most difficult positions in the Government. He guards the natural resources of the Nation. It is not often that the country has been as fortunate in the quality of the man holding the portfolio as it is at the present time. The General Land Office administers the public lands. Disputed points are decided by the Commissioner. Appeal may be taken from his decision to the Secretary of the Interior from whose decision there is no appeal.

For 30 years the Department followed the courts' broad rulings on what constitutes a 'lode' and a 'discovery.' This attitude of the courts and of the Department is illustrated by a departmental ruling made in May, 1911. An applicant had been denied his patents. He appealed to the Secretary who directed that they be issued, for the following reason:

"The defendant company has shown its faith in the property by expending about \$100,000 on it. Its good faith and belief in the ground are not impeached. The weight of the evidence shows that some mineral of some kind, however slight, has been found in each claim. The ground has no substantial value except for its mineral uses. The decision appealed from would have the tendency to stifle honest effort in mining explorations and instead of encouraging the development of the mining resources of the country would greatly retard it."

Four months later, under the same Secretary, in the East Tintic case the Department abandoned its long-held attitude and supported its refusal to issue patents with these words,

"It is evident * * * that * * * title to the claims is sought essentially on account of their possible value for certain unexposed deposits supposed to exist at considerable depth beneath the surface, having no connection, so far as shown, with any deposits appearing on the surface. The exposure, however, of substantially worthless deposits on the surface of a claim; the finding of mere surface indications of mineral within its limits; the discovery of valuable mineral deposits outside the claim; or deductions from established geological facts relating to it; one or all of which matters may reasonably give rise to a hope or belief, however strong it may be, that a valuable mineral deposit exists within the claim will neither suffice as a discovery thereon, nor be entitled to be accepted as the equivalent thereof.

"To constitute a valid discovery upon a claim for which patent is sought there must be actually and physically exposed within the limits thereof a vein or lode of mineral-bearing rock in place, possessing in and of itself a present or prospective value for mining purposes; and before patent can properly be issued or entry allowed thereon, that fact must be shown in the manner above stated."

This decision caused widespread alarm in the mining regions. For 30 years there had been a quiet confidence that claims located and developed in compliance with

existing rulings and court decisions would be patented when their owners were ready. This decision was applied in other cases. In effect, it was retroactive legislation by an individual official who had but a short tenure of office. It upset the precedent of years and arbitrarily depreciated the value of the property of many men. Yet there was no appeal to the courts. The policy of Secretary Lane has been broad and liberal, yet vigilant. It has been formulated by an able man who knows the West and its needs. But another administration may see in power a man whose arbitrary acts will again cause trouble and injustice.

Any proposal to limit the power of the Secretary of the Interior should receive the sharpest scrutiny. But is it not reasonable to ask that in a case like the one just cited an appeal to the courts be permitted?

CONCLUSIONS. Only a few main points have been touched upon. Other large subjects have not been mentioned; namely, placer claims, coal lands, and leasehold *v.* ownership in fee. The discussion has been limited to the act under which mineral lands are acquired and held. Mining regulations, touching the safety of workers, hours of labor, and operating conditions in general are not a part of this subject. The changes most needed are:

First, since it is hardly a controversial subject, may be put the need for adequate records of claims that are held by location and annual assessment. Let locators, as condition to clear possessory title be compelled to record their location notices within 90 days, giving full and clear description of their claims. Each county recorder should be required to transmit certified copies to the local Land Office. Most of the public domain has been surveyed. Were this work completed and this recommendation enacted, the maps and records would show what land has been patented, what is held by location, and what is still the property of the Nation.

Secondly, the conditions discussed under 'Discovery,' and the specific point raised in the discussion of the 'Powers of the Department of the Interior' may be corrected by eliminating the demand for a "discovery of a vein or lode." This proposal is believed to have the support of all who are familiar with geological and operating conditions. It has been specifically supported by the Director of the U. S. Geological Survey in these words: "The same knowledge of natural conditions that leads to the suggestion of a repeal of the law of the apex forces the further suggestion that discovery of ore in place cannot be made universally a prerequisite to the location of a mining claim."

Coupled with the repeal of the 'discovery' clause might be a provision for making effective by inspection the existing requirement for \$100 worth of development annually on each unpatented claim. This would tend to reduce 'blanketing,' the covering of a district with claims located by a few men for speculative purposes. Where orebodies are deep-seated, assessment work on the surface is a perfunctory and useless expenditure. It would be well to permit owners the alternative of paying the equivalent tax to the treasury.

Thirdly, the Law of the Apex. This old culprit still has his adherents, for there are always men who fear to change the *status quo*. A change to vertical bounding planes would affect only locations made after the passage of the new act. No existing claim, patented or unpatented, would suffer curtailment of the right it now enjoys. The accumulated experience of the world confirms the wisdom of the 'vertical prism' rule. In some districts in the United States, Bisbee and Morenci, for example, vertical-plane agreements have been in force between operating companies for years. It will be urged by opponents of change that so much ground is located that it is not worth while; that the courts have made the law plain; that the prospector will be discouraged. It is believed that to all such arguments a convincing answer can be returned. This change in the law might be made to carry with it a change in the size of the claim, making it, say 1500 ft. square, as was done in British Columbia.

None of the proposed changes strikes at the rights of the poor man. He does little actual mining on his own account. His profit (aside from 'leasing' or 'chloriding' operations) comes from the sale of claims, usually unpatented, that he has located and slightly developed by his own labor. If the prospective purchaser be made to fear that he will be unable to confirm his possessory title by a patent, the sale will not be made. The poor man is dealt the harder blow. Elimination of the requirement for a discovery of mineral will be to his advantage, as well as to the advantage of operators on a larger scale. The Law of the Apex delivers its worst blows against the operators of successful producing properties.

The shortcomings of the Act of 1872 have been discussed among mining men for years. It is believed that the recommendations made in this article have the sanction of the leaders of the profession, men who have watched the operation of the Act since its birth.

THE ANNUAL COAL output of the world has been for several years about 1½ billion tons, of which the United States has produced approximately 40%, Great Britain 23%, and Germany 20%. These three countries produce 83% of the world's coal. The United States exported but little over 20,000,000 tons in 1912, most of which went to Canada; Germany exported over 34,000,000, the largest customers being Austria, Holland, and Belgium; Great Britain exported 72,000,000 tons, France, Italy, and Germany being the largest customers. Efforts are being made to increase the coal trade of the United States in Latin America and Europe.

GOLD received by the San Francisco Mint during March was 442,027.12 oz. fine, valued at \$9,137,511.53. Australian bars and English coin amounted to 280,178,295 oz. of this. Silver received was 111,635.21 oz., worth \$82,156.07. Gold coinage totaled \$3,920,000 in double eagles, and copper \$2000. For the Philippines was coined ₱169,000 in 20-centavo pieces. Coin, bullion, etc., on hand at the end of the month amounted to \$374,759,344.63.

Oils for Flotation

By Chas. Y. Clayton and C. E. Peterson

INTRODUCTION Flotation is today attracting the attention of the metallurgist, chemist, physicist, and intelligent technical man in general. The application of the process is making great strides, but the success of it is hindered by the lack of knowledge concerning the many variables that affect the operation. A mill may be running smoothly for weeks at a time when, without apparent reason, the froth dies and everything goes wrong. Sometimes a change in the ore does this, sometimes the water supply, sometimes lubricating oils get into the system, and sometimes the tube-mill is to blame. It is up to the flotation man to study these variables more carefully and get a better control of them.

We know that the sulphides, or minerals with a metallic lustre, can be floated either with or without oil and that the carbonates, silicates, etc., cannot be floated so readily. Why do certain oils have the power of selecting certain minerals? Why do certain oils produce a froth? Why do certain oils give a watery froth? Why do some give an ephemeral froth and others a tough one? Of the thousands of oils known, only a few classes have found successful application in this new process. Is it because others will not give results or is it because they have not been tried?

Among the oils used at the present time are the wood-oils, the coal-tars and their derivatives, water-gas tars and derivatives, the fixed oils and fatty acids, petroleum products, and occasionally an essential oil. By a study of these groups and the oils available in each group it will be seen that only a small percentage of the various oils is in use. Why is one oil better than another?

In buying oils for flotation it proves often that the same oil, supposedly, gives different results. The method of manufacture and the care of an oil before it is used play important parts in successful practice. The properties of an oil may vary by reason of oxidation, exposure to light, or slight differences in the method of manufacture, especially the distillation temperature in the common flotation-oils. In wood-oils the composition may

Missouri School of Mines and Metallurgy
FLOTATION LABORATORY.

Machine Hoover type
Experimental Peterson
Dulomite
Gulstone
398% Pb.

All factors constant except kind of oil.

| Test No. | Oil | REAGENTS, FROTH | | REMARKS | Concentration | | Cu Value per cent |
|-----------------|-------------------------|--------------------|--------|--|---------------|---------|----------------------|
| | | Kind | Amount | | Wt. | Percent | |
| D ₁ | Saflor | None | | Thick black skum | 19.5 | 52.074 | 20-72 |
| D ₂ | Linseed (Raw) | None | | Fair skum, no froth | 11.7 | 73.98 | 12-74 |
| D ₃ | Linseed (Boiled) | None | | Practically no froth | 4.9 | 53.31 | 3-50 |
| D ₄ | Neatsfoot | None | | Thin Oil film | 3.3 | 33.086 | 9-25 |
| D ₅ | Olive | None | | Slight skum | 3.2 | 53.67 | 3-54 |
| D ₆ | Petroleum | None | | Oil film; good selector | 4.1 | 76.27 | 4-76 |
| D ₇ | Rapeseed | None | | Oil film | 1.5 | 43.31 | 3.5-43 |
| D ₈ | Sperm | Light | | Froth forms alone, not lasting | 3.8 | 54.90 | 4-55 |
| D ₉ | Turpentine | | | Thin ephemeral froth | 9.48 | 49.91 | 9-50 |
| D ₁₀ | Turpentine ¹ | Light | | Little light ephemeral watery | 4.19 | 26.40 | 4-24 |
| D ₁₀ | Turpentine ² | Light | | Little Ditto Ditto | 1.80 | 50.10 | 2-50 |
| D ₁₀ | Toluol | Light | | Little Very thin froth | 3.84 | 54.52 | 4-50 |
| D ₁₁ | Almond | Light | | Little Small bubbles, not very dark | 7.3 | 53.59 | 7-54 |
| D ₁₂ | Solza | | | | | | |
| D ₁₃ | Lemon | Light | | Fair, thin ephemeral froth | 24.43 | 68.36 | 25-68 |
| D ₁₄ | Peanut | Light | | Little Very little froth | 5.61 | 70.594 | 6-71 |
| D ₁₅ | Sesame | Light | | Little Ditto | 4.77 | 67.17 | 5-67 |
| D ₁₆ | Amyl Acetate | Light | | lots Good ephemeral froth | 14.60 | 45.42 | 15-45 |
| D ₁₇ | Pyrolygenous Acid | Thin large bubbles | | Good selector | 6.40 | 56.97 | 6-57 |
| D ₁₈ | Sedar Wood | Heavy | | lots large, strong bubbles | 23.07 | 47.80 | 23-48 |
| D ₁₉ | Sedar Wood (Crude) | None | | Oily skum, very little or no froth | 9.42 | 72.40 | 9-72 |
| D ₁₇ | Oleic Acid | Heavy | | lots Large, strong bubbles, pink gangue | 76.70 | 13.285 | 77-13 |
| D ₁₈ | Eucalyptus | Heavy | | lots Very Ephemeral | 51.40 | 47.648 | 51-48 |
| D ₂₀ | Orange Peel | Heavy | | lots Thick and Pulpy, rapid, good selector | 20.61 | 75.92 | 21-76 |
| D ₂₁ | Cresylic Acid | Heavy | | lots Dark froth - Ephemeral | 31.90 | 71.28 | 32-71 |
| D ₂₂ | Cresosote | Heavy | | lots Dark froth | 24.20 | 73.60 | 24-74 |
| D ₂₃ | Corn Oil | very slight | | No froth at first, light color later | | | |
| D ₂₄ | China Wood | None | | Practically no froth or skum | | | |
| D ₂₅ | Menhaden (Crude) | Little | | Could not save froth | | | |
| D ₂₆ | Rape Seed | very little | | Could not save froth | | | |
| D ₂₇ | Soya Bean | Little | | Could not save froth | | | |
| D ₂₈ | Menhaden (Refined) | Ditto | | Ditto | | | |
| D ₂₉ | Poppy Seed | Ditto | | Ditto | | | |
| D ₃₀ | Resin | Fair | | Little Fair froth | 15.2 | 48.96 | 15-49 |
| D ₃₁ | Resin (C. P. 300) | lots | | Heavy stiff froth, pink gangue | 22.09 | 37.40 | 22-37 |
| D ₃₂ | Paraffine | very little | | Could not save froth | | | |
| D ₃₃ | Cottonseed | Light | | Little Thick froth | 7.25 | 63.76 | 7-64 |
| D ₃₄ | Cottonseed (Crude) | Poor | | Fair froth, no selection | | | |
| D ₃₅ | Cottonseed (Refined) | Light | | Little Light bubbles | 4.8 | 64.57 | 5-67 |
| D ₃₆ | Cottonseed (Residue) | lots | | lots Heavy, large bubbles | 16.4 | 23.25 | 16-23 |
| D ₃₇ | Wine | Light | | Very black froth | 14.55 | 64.40 | 15-64 |
| D ₃₈ | Male Fern | lots | | lots Heavy froth, mostly gangue | 21.10 | 44.00 | 21-44 |
| D ₃₉ | Pennyroyal | Light | | lots Black froth, small bubbles | 34.30 | 64.00 | 34-64 |
| D ₄₀ | Cloves | lots | | lots Black froth | 34.79 | 70.00 | 35-70 |
| D ₄₁ | Citronella | Ditto | | Ditto Ephemeral | 30.30 | 74.11 | 30-74 |

vary with the species of wood from which it is obtained. The trend of work today seems to be to study flotation from the standpoint of the ore, its electro-static

| Machine Hoover Type (Clayton) Experimenter Peterson | | Missouri School of Mines and Metallurgy FLOTATION LABORATORY. | | | | | | | | |
|---|-----|--|---------------|----------------|---------------------|------|--------------------------|-------------|---------|--------------------------|
| Dolomite Galena | | All factors constant except kind of oil. | | | | | | | | |
| 3.9890 Pb. | | | | | | | | | | |
| Test No. | OIL | | REAGENTS | | FROTH | | REMARKS | Concentrate | | Oil Value Percent Aft |
| | No. | Kind. | Kind | Amt. | Kind | Amt. | | Wt. | Per Ct. | |
| D95 | 46 | Soda Liver | None | | None | | No results | 7.70 | 57.88 | 2-58 |
| D96 | 47 | Sassafras | Small Bubbles | lots | Thin | | small bubbles | 10.60 | 53.96 | 11-54 |
| D97 | 48 | Origanum | Ephemeral | lots | Good | | selection | 16.07 | 66.14 | 16-64 |
| D98 | 49 | Amber | Large Bubbles | lots | Good | | frother | 12.6 | 50.20 | 13-50 |
| D87 | 50 | Kerosene | None | | Thin | | Oil film | — | — | — |
| D35 | 51 | Commercial Jar Oil | Bubbles | lots | formed | | a heavy, stiff froth | 28.0 | 55.28 | 28-55 |
| D36 | 52 | Kel Oil | None | | formed | | an oil film on surface | 11.20 | 68.354 | 11-68 |
| D37 | 53 | Atlantic Fuel | None | | Thin | | film | 1.70 | 46.904 | 1-47 |
| D38 | 54 | Diamond Refined | None | | Thin | | film | 3.98 | 47.056 | 4-47 |
| D39 | 55 | blond Heavy Cognac | None | | Thin | | film | 2.60 | 42.137 | 3-42 |
| D40 | 56 | *8 flotation | Strong | lots | Heavy | | froth, big bubbles | 31.50 | 60.86 | 31.5-61 |
| D41 | 57 | *17 flotation | Diffic | | Thin | | large quantity, black | 31.90 | 75.21 | 32-75 |
| D42 | 58 | *18 flotation | | | lots | | ditto | 34.80 | 70.92 | 35-71 |
| D43 | 59 | *22 flotation | Ephem | fair | Medium sized | | ephem bubbles | 19.15 | 67.874 | 19-69 |
| D44 | 60 | K-3 (S.N.) | Thin | | Little | | Very ephemeral froth | 11.60 | 71.6 | 12-72 |
| D46 | 61 | S.F. Cylinder | None | | | | Oil failed to emulsify | 1.23 | 22.31 | 1-22 |
| D47 | 62 | Spishings Grade | None | | | | ditto | 3.00 | 36.04 | 3-36 |
| D48 | 63 | Black | None | | | | ditto | 2.70 | 25.74 | 3-26 |
| D49 | 64 | Tar (S-Black) | None | | | | ditto | 4.10 | 40.04 | 4-40 |
| D50 | 65 | *7 Suany South PT | | | | | | | | |
| D50 | 66 | Pine Oil #6 | Light | fair | fairly | | stiff froth | 16.35 | 68.85 | 16-69 |
| D58 | 67 | Refined Tar | Light | lots | Small | | fruit bubbles | 20.95 | 71.12 | 21-71 |
| D59 | 68 | Flotation #200 | Heavy | lots | large | | stiff bubbles | 23.35 | 63.57 | 23-64 |
| D60 | 69 | Flotation #300 | Heavy Small | lots | fairly | | stiff froth | 23.50 | 67.72 | 23-68 |
| D61 | 70 | *80 Grade Wood Turps. | Bubbles | lots | Ephemeral | | froth | 5.34 | 61.39 | 5-61 |
| D62 | 71 | *15 Special Turps | Small Bubbles | fair | light | | ephemeral froth | 2.22 | 46.37 | 2-46 |
| D63 | 72 | *15 Grade Wood Turps | Light | | Small | | bubbles, ephemeral froth | 4.40 | 54.53 | 4-55 |
| D64 | 73 | *1580 Special Pine | Good | fair | Small | | ephemeral bubbles | 4.65 | 56.97 | 5-57 |
| D65 | 74 | *350 Grade Wood Pure Pine | Heavy Small | lots | Large, thick, stiff | | bubbles | 17.75 | 52.10 | 18-52 |
| D66 | 75 | (Steam Refined) | Bubble | lots | Ephemeral | | small bubbles | 13.10 | 72.00 | 13-72 |
| D67 | 76 | *20 Flotation | None | | No | | froth, no skum | — | — | — |
| D68 | 77 | *1 S. Cocote #2 Mixture | None | | No | | froth, good selection | 5.0 | 59.80 | 5-60 |
| D69 | 78 | Steam Refined Tar #3 Grade Gas | Light | lots | | | | 37.12 | 69.16 | 37-69 |
| D70 | 79 | House Tar #4 Grade Water | None | | Apparently | | good selector | — | — | — |
| D71 | 80 | Gas Tar #5 Grade Coke | ditto | | ditto | | | — | — | — |
| D72 | 81 | Oven Tar #6 Oil from | ditto | | ditto | | | — | — | — |
| D75 | 82 | Water Gas Tar Coal Tar from | No froth | | | | | 8.55 | 61.86 | 9-62 |
| D76 | 83 | Gas Oven | ditto | | No | | results | — | — | — |
| D77 | 84 | Water Gas Tar | ditto | | ditto | | | — | — | — |
| D78 | 85 | Coal Tar | ditto | | Difficult | | to emulsify | — | — | — |
| D19 | 86 | linseed (Raw) | Resin | 10 gms 20cc | light | Very | light froth | 14.2 | 54.93 | 14-55 |
| D20 | 87 | Pyrogenous Acid | Resin | 10 gms 20cc | None | | No action at all | — | — | — |
| D22 | 88 | Turpentine | Resin | 10 gms 20cc | Good | lots | | 18.3 | 54.58 | 18-55 |
| D25 | 89 | Coal Tar | | | little | | ephemeral froth | 8.24 | 52.34 | 8-52 |
| | | Toluol | | | | | | | | |

seem that the chief factors are:

1. Di-electric strength.
2. Optical properties, the power to absorb certain rays.
3. Insulation value.
4. Viscosity.
5. Saponification value.
6. Water-soluble content.
7. Degree to which an oil (as a whole) is dissolved by water.
8. Facility to be emulsified.
9. Surface tension.
10. Specific gravity.
11. Chemical composition.

In attacking the problem the first step was to classify the available oils into groups. The oils so far tested cover a large field and can be divided as follows: Fixed oils, fatty acids, essential oils, wood-oils (including the resins), coal-tars and derivatives, water-gas tar and derivatives, petroleum and derivatives.

In making this classification we realize that some groups overlap, that is, contain like compounds, but the idea was to get a classification that would show the source and be easily understood. In addition to this general classification, oils were studied in detail and technical articles abstracted, giving a volume of matter too large for publication at this time.

The next step was to classify oils as to their flotation-value. This was accomplished in test-tube and machine tests. By shaking small quantities of oil, water, and ore in a test-tube and noting the action, we obtained a general classification of oils: frothing oils, selective oils, oils that froth and select, and oils that are seemingly inactive. The data were tabulated to aid the machine tests. The machine tests were made in a modified Hoover machine, as shown in the accompanying drawing. The capacity of this machine was 4000 cc. of water and 800 grams of ore, making a ratio 5:1. The agitator gave 1700 r.p.m. The time of each test was 20 minutes.

Since making these tests we have found that it is advantageous to replace the small circulation pipe, connecting the agitator-box and the spitz, with an air-lift. Throughout this work the only variable was the kind of oil.

ORE USED. In tests numbered D1 to D109 an ore composed of dolomite and galena was employed. It gave the following screen analysis:

| | Through mesh | On mesh | Weight Lb. | % | Cumulative % | Lead % | Total lead % |
|------|--------------|---------|------------|------|--------------|--------|--------------|
| 1... | 65 | 80 | 16.25 | 3.25 | 3.25 | 5.34 | 4.30 |
| 2... | 80 | 100 | 33.50 | 6.70 | 9.95 | 4.19 | 7.35 |

charge (so called), etc., and from the standpoint of col-loidal chemistry. We believe that, in addition, a study of oils would give a better understanding of the process and of the variables concerned, while also aiding in the solution of certain theories not yet advanced.

This leads us to the question, what property or combination of properties make oils valuable as flotation agents? Thinking that a careful study of oils and their properties might lead us to the solution of this problem, we made the experiments herewith recorded.

From the scanty literature of the subject it would

Heavy type
Flotation
Petroleum

Missouri School of Mines and Metallurgy
FLOTATION LABORATORY

Standard screens were used.

In tests D110 to D139 we used similar ore. It gave the following screen analysis:

All factors constant except kind of oil.

| No. | Dolomite Analysis | Oil | REMARKS | Percentage | | Cumulative Value Percent | Through mesh | On mesh | Weight Lb. | % | Cumulative Value % | Lead % | Total lead % |
|------|----------------------|----------------------------------|----------------------|------------|-------|--------------------------------|-----------------|------------|---------------|--------|--------------------------|-----------|--------------------|
| | | | | Oil | Froth | | | | | | | | |
| D10 | 5989 Pb. | 1/2 Spermic 1/2 Spermic Acid | 2-30 mesh at 16 mesh | 17.03 | 2.45 | 17.48 | 65 | 80 | 1.0 | 0.20 | 0.20 | 20.22 | 0.885 |
| D11 | | 1/2 Spermic 1/2 Spermic Acid | None None | 33.00 | 2.09 | 35.09 | 80 | 100 | 23.6 | 1.72 | 5.66 | 7.62 | 8.000 |
| D12 | | 1/2 Spermic 1/2 Spermic Acid | None None | 15.10 | 7.79 | 18.77 | 100 | 115 | 28.9 | 5.78 | 11.44 | 1.65 | 5.875 |
| D13 | | 1/2 Spermic 1/2 Spermic Acid | None None | 15.10 | 7.79 | 18.77 | 115 | 150 | 61.2 | 12.24 | 23.68 | 3.15 | 9.210 |
| D14 | | 1/2 Spermic 1/2 Spermic Acid | None None | 34.30 | 5.74 | 40.04 | 150 | 170 | 47.7 | 9.54 | 33.22 | 3.00 | 6.300 |
| D15 | | 1/2 Spermic 1/2 Spermic Acid | None None | 34.30 | 5.74 | 40.04 | 170 | 200 | 116.1 | 29.28 | 62.50 | 3.22 | 20.700 |
| D16 | | 1/2 Spermic 1/2 Spermic Acid | None None | 22.95 | 5.27 | 28.22 | 200 | 220 | ... | ... | 62.50 | ... | ... |
| D17 | | 1/2 Spermic 1/2 Spermic Acid | None None | 22.95 | 5.27 | 28.22 | 220 | 240 | 4.2 | 0.84 | 63.34 | 3.61 | 0.663 |
| D18 | | 1/2 Spermic 1/2 Spermic Acid | None None | 22.95 | 5.27 | 28.22 | 240 | 260 | 59.0 | 11.80 | 75.14 | 1.25 | 10.960 |
| D19 | | 1/2 Spermic 1/2 Spermic Acid | None None | 34.30 | 5.74 | 40.04 | 260 | ... | 124.3 | 24.86 | 100.00 | 6.72 | 36.550 |
| | | | | | | | | | | 500.00 | 100.00 | | 100.128 |
| D20 | | 1/2 Spermic 1/2 Spermic Acid | None None | 23.80 | 7.605 | 24.705 | | | | | | | |
| D21 | | 1/2 Spermic 1/2 Spermic Acid | None None | 27.05 | 7.70 | 25.71 | | | | | | | |
| D22 | | 1/2 Spermic 1/2 Spermic Acid | None None | 44.57 | 6.10 | 25.62 | | | | | | | |
| D23 | | 1/2 No 70 Mx 1/2 No 88 Mx | Good frother | 35.9 | 6.200 | 26.62 | | | | | | | |
| D24 | | 1/2 No 89 Mx 1/2 Spermic Acid | Small Butterbub | 29.44 | 5.1 | 21.55 | | | | | | | |
| D25 | | 1/2 Spermic 1/2 Spermic Acid | None None | | | | | | | | | | |
| D26 | | 1/2 Spermic 1/2 Spermic Acid | None None | | | | | | | | | | |
| D27 | | 1/2 Spermic 1/2 Spermic Acid | None None | | | | | | | | | | |
| D28 | | 1/2 Spermic 1/2 Spermic Acid | None None | | | | | | | | | | |
| D29 | | 1/2 Spermic 1/2 Spermic Acid | None None | | | | | | | | | | |
| D30 | | 1/2 Spermic 1/2 Spermic Acid | None None | | | | | | | | | | |
| D31 | | 1/2 Spermic 1/2 Spermic Acid | None None | | | | | | | | | | |
| D32 | | 1/2 Spermic 1/2 Spermic Acid | None None | | | | | | | | | | |
| D33 | | 1/2 Spermic 1/2 Spermic Acid | None None | | | | | | | | | | |
| D34 | | 1/2 Spermic 1/2 Spermic Acid | None None | | | | | | | | | | |
| D35 | | 1/2 Spermic 1/2 Spermic Acid | None None | | | | | | | | | | |
| D36 | | 1/2 Spermic 1/2 Spermic Acid | None None | | | | | | | | | | |
| D37 | | 1/2 Spermic 1/2 Spermic Acid | None None | | | | | | | | | | |
| D38 | | 1/2 Spermic 1/2 Spermic Acid | None None | | | | | | | | | | |
| D39 | | 1/2 Spermic 1/2 Spermic Acid | None None | | | | | | | | | | |
| D40 | | 1/2 Spermic 1/2 Spermic Acid | None None | | | | | | | | | | |
| D41 | | 1/2 Spermic 1/2 Spermic Acid | None None | | | | | | | | | | |
| D42 | | 1/2 Spermic 1/2 Spermic Acid | None None | | | | | | | | | | |
| D43 | | 1/2 Spermic 1/2 Spermic Acid | None None | | | | | | | | | | |
| D44 | | 1/2 Spermic 1/2 Spermic Acid | None None | | | | | | | | | | |
| D45 | | 1/2 Spermic 1/2 Spermic Acid | None None | | | | | | | | | | |
| D46 | | 1/2 Spermic 1/2 Spermic Acid | None None | | | | | | | | | | |
| D47 | | 1/2 Spermic 1/2 Spermic Acid | None None | | | | | | | | | | |
| D48 | | 1/2 Spermic 1/2 Spermic Acid | None None | | | | | | | | | | |
| D49 | | 1/2 Spermic 1/2 Spermic Acid | None None | | | | | | | | | | |
| D50 | | 1/2 Spermic 1/2 Spermic Acid | None None | | | | | | | | | | |
| D51 | | 1/2 Spermic 1/2 Spermic Acid | None None | | | | | | | | | | |
| D52 | | 1/2 Spermic 1/2 Spermic Acid | None None | | | | | | | | | | |
| D53 | | 1/2 Spermic 1/2 Spermic Acid | None None | | | | | | | | | | |
| D54 | | 1/2 Spermic 1/2 Spermic Acid | None None | | | | | | | | | | |
| D55 | | 1/2 Spermic 1/2 Spermic Acid | None None | | | | | | | | | | |
| D56 | | 1/2 Spermic 1/2 Spermic Acid | None None | | | | | | | | | | |
| D57 | | 1/2 Spermic 1/2 Spermic Acid | None None | | | | | | | | | | |
| D58 | | 1/2 Spermic 1/2 Spermic Acid | None None | | | | | | | | | | |
| D59 | | 1/2 Spermic 1/2 Spermic Acid | None None | | | | | | | | | | |
| D60 | | 1/2 Spermic 1/2 Spermic Acid | None None | | | | | | | | | | |
| D61 | | 1/2 Spermic 1/2 Spermic Acid | None None | | | | | | | | | | |
| D62 | | 1/2 Spermic 1/2 Spermic Acid | None None | | | | | | | | | | |
| D63 | | 1/2 Spermic 1/2 Spermic Acid | None None | | | | | | | | | | |
| D64 | | 1/2 Spermic 1/2 Spermic Acid | None None | | | | | | | | | | |
| D65 | | 1/2 Spermic 1/2 Spermic Acid | None None | | | | | | | | | | |
| D66 | | 1/2 Spermic 1/2 Spermic Acid | None None | | | | | | | | | | |
| D67 | | 1/2 Spermic 1/2 Spermic Acid | None None | | | | | | | | | | |
| D68 | | 1/2 Spermic 1/2 Spermic Acid | None None | | | | | | | | | | |
| D69 | | 1/2 Spermic 1/2 Spermic Acid | None None | | | | | | | | | | |
| D70 | | 1/2 Spermic 1/2 Spermic Acid | None None | | | | | | | | | | |
| D71 | | 1/2 Spermic 1/2 Spermic Acid | None None | | | | | | | | | | |
| D72 | | 1/2 Spermic 1/2 Spermic Acid | None None | | | | | | | | | | |
| D73 | | 1/2 Spermic 1/2 Spermic Acid | None None | | | | | | | | | | |
| D74 | | 1/2 Spermic 1/2 Spermic Acid | None None | | | | | | | | | | |
| D75 | | 1/2 Spermic 1/2 Spermic Acid | None None | | | | | | | | | | |
| D76 | | 1/2 Spermic 1/2 Spermic Acid | None None | | | | | | | | | | |
| D77 | | 1/2 Spermic 1/2 Spermic Acid | None None | | | | | | | | | | |
| D78 | | 1/2 Spermic 1/2 Spermic Acid | None None | | | | | | | | | | |
| D79 | | 1/2 Spermic 1/2 Spermic Acid | None None | | | | | | | | | | |
| D80 | | 1/2 Spermic 1/2 Spermic Acid | None None | | | | | | | | | | |
| D81 | | 1/2 Spermic 1/2 Spermic Acid | None None | | | | | | | | | | |
| D82 | | 1/2 Spermic 1/2 Spermic Acid | None None | | | | | | | | | | |
| D83 | | 1/2 Spermic 1/2 Spermic Acid | None None | | | | | | | | | | |
| D84 | | 1/2 Spermic 1/2 Spermic Acid | None None | | | | | | | | | | |
| D85 | | 1/2 Spermic 1/2 Spermic Acid | None None | | | | | | | | | | |
| D86 | | 1/2 Spermic 1/2 Spermic Acid | None None | | | | | | | | | | |
| D87 | | 1/2 Spermic 1/2 Spermic Acid | None None | | | | | | | | | | |
| D88 | | 1/2 Spermic 1/2 Spermic Acid | None None | | | | | | | | | | |
| D89 | | 1/2 Spermic 1/2 Spermic Acid | None None | | | | | | | | | | |
| D90 | | 1/2 Spermic 1/2 Spermic Acid | None None | | | | | | | | | | |
| D91 | | 1/2 Spermic 1/2 Spermic Acid | None None | | | | | | | | | | |
| D92 | | 1/2 Spermic 1/2 Spermic Acid | None None | | | | | | | | | | |
| D93 | | 1/2 Spermic 1/2 Spermic Acid | None None | | | | | | | | | | |
| D94 | | 1/2 Spermic 1/2 Spermic Acid | None None | | | | | | | | | | |
| D95 | | 1/2 Spermic 1/2 Spermic Acid | None None | | | | | | | | | | |
| D96 | | 1/2 Spermic 1/2 Spermic Acid | None None | | | | | | | | | | |
| D97 | | 1/2 Spermic 1/2 Spermic Acid | None None | | | | | | | | | | |
| D98 | | 1/2 Spermic 1/2 Spermic Acid | None None | | | | | | | | | | |
| D99 | | 1/2 Spermic 1/2 Spermic Acid | None None | | | | | | | | | | |
| D100 | | 1/2 Spermic 1/2 Spermic Acid | None None | | | | | | | | | | |

| Through mesh | On mesh | Weight Lb. | % | Cumulative % | Lead % | Total lead % |
|--------------|---------|------------|--------|--------------|--------|--------------|
| 65 | 80 | 3.7 | 0.74 | 0.91 | 5.90 | 0.955 |
| 80 | 100 | 23.6 | 4.72 | 5.66 | 7.62 | 8.000 |
| 100 | 115 | 28.9 | 5.78 | 11.44 | 1.65 | 5.875 |
| 115 | 150 | 61.2 | 12.24 | 23.68 | 3.15 | 9.210 |
| 150 | 170 | 47.7 | 9.54 | 33.22 | 3.00 | 6.300 |
| 170 | 200 | 116.1 | 23.22 | 62.50 | 3.22 | 20.700 |
| 200 | 220 | ... | ... | 62.50 | ... | ... |
| 220 | 240 | 4.2 | 0.84 | 63.34 | 3.61 | 0.663 |
| 240 | 260 | 59.0 | 11.80 | 75.14 | 1.25 | 10.960 |
| 260 | ... | 124.3 | 24.86 | 100.00 | 6.72 | 36.550 |
| | | 500.00 | 100.00 | | | 100.128 |

The results of the machine-tests are given in tabular form.

CONCLUSIONS. The results are interesting and show the possibility of using a great variety of oils if they were purchasable at a low price. The results also indicate our inability to give to oils flotative values in numerical terms and the impossibility of getting the true values of oils that give no scum or froth, such as the coal-tars and crude petroleum. It is known that these are good selectors. The tabulations show further that oils vastly different in consistence have similar flotative values. They also bring out the fact that a great deal of work must be done before those properties of oils which give them flotative value are understood, for instance, why do oleic acid, cottonseed residue, and others froth and lift dolomite, while citronella, wood-cresote, pine-oil, and others froth and float galena?

The following experiments suggest themselves and are being attempted:

1. To determine whether there is any relation between an oil's selective power and its di-electric constant, or an oil's frothing power and its di-electric constant.

2. The relation, if any, between an oil's selective power and its viscosity or an oil's frothing power and its viscosity.

3. Whether the oil's surface tension or film strength plays any part in an oil's frothing power or in an oil's selective power.

4. Whether the saponification value bears any relation to the flotative value of an oil, either frothing value or selective value.

5. The facility with which oils can be emulsified, and their flotative value.

6. The oil's water soluble content and the value of it to flotation.

7. The degree to which oil is soluble in water, soluble as a whole, and the value of it to flotation.

| Through mesh | On mesh | Weight Lb. | % | Cumulative % | Lead % | Total lead % |
|--------------|---------|------------|-------|--------------|--------|--------------|
| 3... | 100 | 115 | 17.70 | 3.51 | 13.49 | 3.35 |
| 4... | 115 | 150 | 51.53 | 10.91 | 24.40 | 3.69 |
| 5...</ | | | | | | |

| Machine | | Hoover Type | | Missouri School of Mines and Metallurgy | | FLOTATION LABORATORY. | | | | | | |
|--------------|-----|------------------|----------------|--|-------|-----------------------|-------------|---|-------------|---------|-----------|---------|
| Experimenter | | Clayton Peterson | | All factors constant except kind of oil. | | | | | | | | |
| ORE | | Dolomite Galena | | | | | | | | | | |
| | | 3.98% Pb. | | | | | | | | | | |
| Test No. | OIL | | REAGENTS | | FROTH | | REMARKS. | | Concentrate | | Oil Value | |
| | No. | Amt. | Kind. | Kind | Amt. | Kind | Amt. | | Wt. | Per Ct. | Per Ct. | Per Ct. |
| D120 | 115 | | Cubeb | | | Small Bubbles | Little | Watery froth with black slum surface | 4.84 | 50.16 | 5 | 50 |
| D121 | 116 | | Eucalypt | | | Heavy | Large | Heavy black froth | | 38.68 | | 39 |
| D122 | 117 | | | | | | | | | | | |
| D123 | 118 | | | | | | | | | | | |
| D124 | 119 | | | | | | | | | | | |
| D125 | 120 | | Jabum Capable | | | Tough | Large | Med. sized bubbles, carries gangue | 22.41 | 13.3 | 22 | 13 |
| D126 | 121 | | Peppercorn | | | Watery | Large | Black froth forms large bubbles | 4.16 | 32.2 | 4 | 32 |
| D127 | 122 | | Pure Creosote | | | Large | Very Little | No action with tidlers, light froth with more | 5.56 | 26.2 | 6 | 26 |
| D128 | 123 | | Balsam of Peru | | | Large | Large | Watery light froth, carries gangue | 3.97 | 41.5 | 4 | 42 |
| D129 | 124 | | Oil of Amber | | | Small | Small | Same as ref. creosote but more gangue | 10.43 | 42.0 | 10 | 42 |
| D130 | 125 | | Peppercorn | | | Small | Small | | 22.36 | 59.98 | 22 | 59 |
| D131 | 126 | | Black Pepper | | | Bubbles | Large | Slow forming froth, poor selector | 56.28 | 44.00 | 50 | 44 |
| D132 | 127 | | Spearmint | | | Small | Small | | 6.72 | 69.44 | 7 | 67 |
| D133 | 128 | | Rue | | | Small | Small | Slum like froth, tough, carries conc. | 11.67 | 59.20 | 12 | 59 |
| D134 | 129 | | Sandalwood | | | Small | Small | Sum of good conc. not very tough | 35.8 | 67.4 | 36 | 67 |
| D135 | 130 | | Verbina | | | Small | Small | Stiff froth carries gangue | 6.5 | 67.6 | 7 | 68 |
| D136 | 131 | | Sweet Orange | | | Small | Small | Light froth, carries little mineral | 0.99 | 19.8 | 1 | 20 |
| D137 | 132 | | Flotation "A" | | | Small | Small | Small bubbles, carries mostly gangue | 0.85 | 24.4 | 1 | 24 |
| D138 | 133 | | Flotation "B" | | | Small | Small | More mineral than "A" | 0.46 | 24.9 | 0.5 | 25 |
| D139 | 133 | | Flotation "C" | | | Small | Small | Very small bubbles, more mineral | | | | |

8. The quantitative effect of the use of frothing oils and of the use of selective oils.
 9. The relation between a mineral's dielectric constant and its tendency to be floated. The sulphides have dielectric constants approaching infinity.

10. The grouping of oils as made by the chemist and the flotation-values of these various groups and to ascertain if the members of each group have similar value as selectors or frothers.

11. The effect of various salts and amounts of salts on the flotative value of an oil or combination of oils. Do these salts affect the surface of the mineral, do they combine with the oil, etc?

12. To show by micro-photographs how oils and bubbles attach themselves to minerals.

13. Whether classification is an aid to flotation.

[Much duplication of work in the testing of oils for flotation can be avoided by publicity such as the above. We invite discussion of the subject.—EDITOR.]

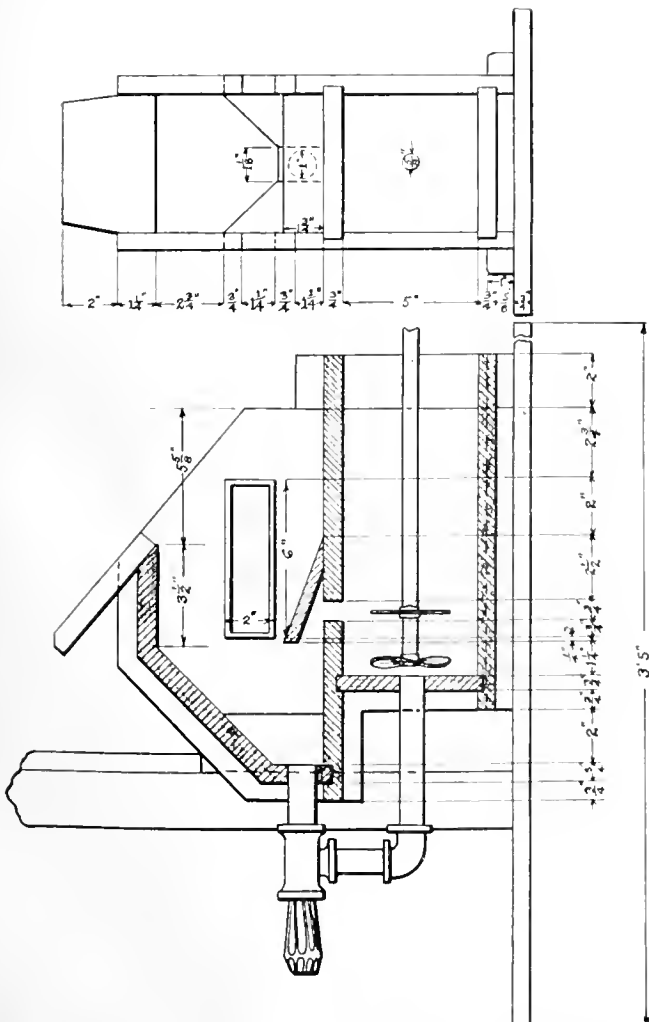

FLOTATION MACHINE USED IN THE MISSOURI SCHOOL OF MINES.

CENTRAL AMERICA is portrayed as a thriving and prosperous region in a new handbook issued by the Department of Commerce, Washington. Mr. Garrad Harris, the author, finds that the United States furnishes 50% of the imports for these republics. The Guatemalan banana industry, which has been attracting American capital, is cited as an illustration of what should be done on a larger scale to promote economic and social intercourse. Letters for Latin-Americans, the author states, should be put into good Spanish, containing no technical terms or 'Americanisms.' A curious result of an innocent Americanism was the distrust felt in British Honduras for American condensed milk that bore the sinister label 'Made at our Plant.' This was interpreted to mean that the milk was artificially made from a plant. When the label was changed, the milk became popular. The title of the new publication is 'Central America as an Export Field.' It contains 229 pages, includes an outline of a route for commercial travelers, and sells at 30 cents.

THE SENECA-SUPERIOR silver mine at Cobalt is said to be nearly worked out. The mine has lasted less than four years, but has produced over 5,000,000 oz. of silver at a notably low operating cost. W. E. Segsworth, the consulting engineer who promoted the company, holds out scant hope of discovering another vein. Profit in 1915 was \$568,501.

BUTTE, the greatest copper-mining city in the world, has a population of 45,000. It has an altitude of over a mile. Built on a bald hill around the rich copper and zinc mines that are its sole support, it is a district of high wages and ambient industry.

CONCENTRATES

Readers of the MINING and Scientific PRESS are invited to ask questions and give information dealing with technical and other matters pertaining to the practice of mining, milling, and smelting.

COST of removing mass copper from No. 12 level of the Alameck mine in Michigan is 1.5c. per pound, exclusive of smelting.

DREDDING RESULTS on the Pato concession in Colombia during 1915 yielded 2% over the drilling estimates, the operations being in closely drilled ground.

CORROSION in pipes is caused directly by air in the water. De-aeration of the water at moderate expense, it is believed, will increase the life of some piping systems four or five times.

SCREENS in the tube-mill circuits at the Nipissing mill, Cobalt, collected 176,158 oz. of silver metallies in 1915, but the practice has been discontinued as the extraction was not improved or cost lowered.

CELLULOSE has been found disappointing as a material for making mine models; it not only warps, but expands and contracts with changes of temperature and humidity so that it is unsatisfactory for this purpose.

ACCIDENTS to the hands and arms of workmen constitute 31% of the non-fatal injuries in metal mines, while injuries to the feet and legs are 36% of the total. The head receives only 7.31% and the face only 4.19% of such injuries.

CONCENTRATE TREATMENT at the Goldfield Consolidated in 1915 cost \$4,109 per ton, equal to 24.2c. per ton of ore milled. This included raw cyanidation, filtering, roasting, acid treatment, cyanidation of roasted material, precipitation of gold and copper, etc.

CENTRIFUGAL PUMPS have given satisfactory results at several Rand mines. At the Crown Mines, centrifugal units lift 1000 to 1200 gal. per minute a height of 2200 to 2500 ft. In that region centrifugal pumps are preferred for handling heavy flows of water.

'STAINLESS' STEEL for use in instruments or cutlery where rusting or tarnishing are especially deleterious is now manufactured in England. Sir Robert Hadfield at a meeting of the Faraday Society indicated that a typical analysis of the steel is: chromium 12.7%, iron 86.6, carbon 0.28, silicon 0.01, manganese 0.12, cobalt 0.45%. Experiments are being conducted to determine this steel's resistance to acids, sea-water, etc.

ALUMINUM DUST, ingots, and plates, used for precipitation of silver, averaged 42.1, 21.04, and 23.64c. per pound, respectively, at the Nipissing mill, Cobalt, in 1915. These high prices make a substitute necessary. Experiments on a large scale with sodium sulphide as a precipitant, the resulting silver sulphide being de-sul-

phurized by aluminum ingots in a caustic soda solution before being reduced to bullion, have been satisfactory, and this procedure will probably be adopted.

AIR-LIFTS have given good service in unwatering mines, and in raising oil from wells, as in southern California. Essentially an air-lift is a pipe, say of 4-in. diameter, extending for 30% or more of its height into the water or oil to be pumped; discharging into this pipe near its bottom is a small compressed air pipe, perhaps of 1½-in. diameter. The discharge comes up to the larger pipe in spurts of alternate water and air. The only equipment necessary is an air-compressor and pipe. In narrow shafts where there is not room to hang a sinker-pump, an air-lift is particularly convenient because all the space required is for the pipe.

VANADIUM ORES do not occur in any particular kind of rock. In Colorado they are found in two forms, in the vanadium mica, roscoelite, which, in minute flakes, impregnates a fine-grained sandstone, to which it gives a sage-green color; also in carnotite, a canary-yellow hydrous-potassium uranium-vanadate, which is also found in sandstone. At Minas Ragra, Peru, where the largest known deposits occur, the vanadium is in the form of a sulphide in an asphaltite vein. Vanadium occurs in large quantities in arid and semi-arid regions, although the vanadium-bearing sandstone has only been found in the United States in Colorado and Utah. Outside of Minas Ragra no vanadium in commercial quantities is found in asphaltites. It is not safe to say that vanadium will be found in any particular kind of rock, although in any one region it would be well to prospect for vanadium under similar conditions known to exist commercially in other regions. The largest use of vanadium is as an alloy in steel; it is quoted at \$1.25 per pound.

PUMP-VALVE facings for the large 18-in. valves of Nordberg triple-expansion fly-wheel pumps in the Old Dominion mine, Globe, Arizona, gave trouble by reason of sand in the water. Brass, steel, fibre, and leather valves were tried. With clear water, the brass valves, costing \$15.37 each, averaged 37 days of service; steel valves, costing \$3.09 each, lasted 70 days; fibre valves, costing \$17.82 each, lasted 105 days; and leather valves, costing \$3.86 each, lasted 64 days. The fibre and leather valves are discarded when worn out, while the brass and steel valves can be re-faced for 55 and 65c., respectively. Finally it was decided that steel-faced valves are best for normal conditions of clear water, while fibre and hard leather valves are best for sandy water, lasting 4 to 6 days. With the Prescott triple-expansion pumps, using smaller valves, hard rubber gave best service. Generally speaking, more and smaller valves are preferred to a few big valves for sandy water; but the reverse seemed true with the large fly-wheel pumps when running at high speed, by reason of breakages of the small valves. These notes are from a paper by P. G. Beckett to be read at the Arizona meeting of the American Institute of Mining Engineers.

Mining in Colorado

By George J. Bancroft

IN attempting to outline recent mining developments in this State, I feel in a position similar to that of the barnyard hen that hatched out a mixed setting of eggs, consisting of ducks, guinea-hens, pheasants, turkeys, and chickens. After a few weeks' growth, it was extremely difficult for the old hen to keep her mixed brood all in sight at any one time. So it is with me. I am as limited in intellect in proportion to the present development of the mining industry in Colorado as the old hen was limited in instinct with respect to her varied family. Mining in Colorado is expanding along the lines that my professor in college taught me was characteristic of an explosive, namely, that it expanded "with equal force in all directions."

Among the metals that are being mined in this State at the present time are gold, silver, lead, zinc, copper, tungsten, iron, manganese, radium, vanadium, molybdenum, uranium, and cadmium, to say nothing of oil, coal, lime, marble, and a dozen other non-metallic minerals.

Inasmuch as I am in no position to describe properly the advances that have recently been made and now are being made, in mining development, I have decided to devote the space, which our editor so generously allows me, to telling something about the activities of a few of our fellow-workers in the mining field, whose operations I happen to know about. Among the gold miners, A. E. Carlton has "come back." For several years it seemed that the trained intellect and fighting force of this splendidly energetic American had been lost to the mining world. Beginning with his wonderful accomplishments in the Vindicator-Golden Cycle deal last year, we again feel the influence of this strong personality. It reminds me of the 'helper' engines that used to couple onto the rear of the Pullmans going over Soldier Summit. You felt the throbbing powerful push from the moment of coupling. A half-dozen rejuvenated Cripple Creek mines, a \$5,000,000 beet-sugar company, and an automobile highway to the top of Pike's Peak are among his more recent accomplishments.

George E. Collins is entitled to great credit for the efficient and economical management of the Mary Murphy* mine near Buena Vista, on the Arkansas river. This mine was always considered a hard proposition on account of the complex character of its ore. Mr. Collins reports a net earning of \$220,415.45 for the fiscal year recently passed. Careful and intelligent milling, coupled with economy and efficiency in all lines, led to the above most gratifying results.

Irving T. Snyder and H. P. Nagel are the two young men who have brought the Vindicator mine to its present

state of efficiency and profitability. This mine, at Cripple Creek, has established a new record for rich gold ore at maximum depth. The manager, Irving T. Snyder, reports the cutting and development of the Ready Money vein on the 2025-ft. level. This is 200 ft. lower than any previous workings on this vein. The volume and grade of the ore are reported as being "very satisfactory." The Ready Money vein is only one of many veins exploited by the Vindicator company. The Golden Cycle shaft of the same company is now down 2225 feet and the work of cross-cutting to the orebodies will soon begin to show results.

Clarence C. Hamlin, president of the company operating the Granite mine, also at Cripple Creek, and James Sylvester Murphy, consulting engineer to this company, are to be congratulated on their success in the consolidation and economical management of the property, which is the consolidation of the Granite, Dillon, Gold Coin, Monument, and Dead Pine mines. While the Granite has been working out its own salvation for some time, it is in the lime-light at present, because of cutting an unusually valuable ore-shoot in the Little Montana dike on the 1400-ft. level.

Cripple Creek is not alone by any means in reporting rich ore at depth. The old mining town of Central City is doing better than for some time past. Very little outside capital has gone into Central City of recent years and much of the wealth produced there was carried to Europe by foreign lessees, so that this district of Gilpin county was much in need of working capital. The European war has kept the prosperous foreign lessees from returning to Europe and the Central City miners have profited enormously from the tungsten mining in this county and in the adjoining county of Boulder. A little home capital being now available, I think it is a fair guess that more good news will soon be coming from the Little Kingdom of Gilpin, as it is known to 'old-timers.' The strike in the Colorado Carr mine appears to be unusually important. This property is under the management of Arthur Most and it is through his efforts that it is again coming to the front as a gold producer.

In the neighboring county of Clear Creek, there is much activity. For instance, the famous old Colorado Central mine above Georgetown is to be re-opened by the Onondago Mines Company. A deal is under way to complete the Malm-process mill at Georgetown and some strong mining men are taking a keen interest in the matter. S. A. Ionides and John Malm of Denver are back of this movement. The strikes in the Big Five 'tunnel' at Idaho Springs continue to yield handsome returns. George Kimball of Idaho Springs has a hand in this development. The Argo mill has added a flota-

*See report on page 614.

tion plant to its present equipment. Kens Shirmer of Idaho Springs and Richard Parker of Denver designed and built it. The old Alice mine has passed through title clearing procedure and is ready to go ahead. George and Edward Reynolds are the energizers at the Alice. They have built a mill with their own hands and thereby made the district self supporting. The Capital, Mendota, Scotia, Seven-Thirty, Pelican, Big-Indian, Ruler, Sunshine, Albro, Santiago, Imperial, and Belden are all in good ore.

In Boulder county, which lies north of Gilpin, there is a regular boom. I was going to say a regular "old-fashioned" boom, but this is not of that kind. In the old days a mining boom was conducted with much stock-selling, much hotel and stock-exchange building, much saloon patronage, and much energy expended in a great many ways other than in mining. The printing-press and whiskey-still were near competitors of the air-drill and rock-crusher in those good old days gone by. This boom of ours in Boulder county is an effective boom, if I may put it that way. At least \$4,000,000 of tungsten ore has been sold in the last year and a half. Practically all the wealth created thereby is re-invested in mining in the neighborhood. I never saw a boom with so little hot air. There are dozens of men in Boulder county making \$25 to \$100 per day with labor of their own hands. The point is that they keep right on using their own hands instead of hiring some one else to do the mining. I came down the hill with eight lessees the other day; they looked much alike, as men are apt to look who are covered with gouge and candle-grease; I induced them to tell me of their earnings. The least fortunate one was making a little less than wages. The most lucky one had averaged \$75 per day for two weeks. I asked the latter what his plans were for the future. "Just keep on digging as long as the ore holds out and the price stays up," was his reply, and that remark is characteristic of the district. No excitement, no inflation, no foolishness, just industrious digging, that is all. There has been little mining engineering work in connection with this boom, the reason being that the district was an old gold-mining camp to begin with. There were plenty of mills in the district, and the ground was, for the most part, covered with claims that were patented years ago. Then again Stein & Boercke of the Primos Chemical Company are intelligent and conservative men. They have been in the tungsten business for 20 years, at least, and they had worked out most of the engineering problems connected with this field during the years when tungsten was only \$4 per unit. Furthermore, Colorado miners do not get excited over apex questions as they used to. There have been few important sales. As a result of these several facts and tendencies, there has been but little important engineering work done so far in Boulder county. There is plenty of work to do in the future, however, provided the price of tungsten is sustained. For instance, some one must evolve a method of saving the tungsten slime. Straight oil-flotation won't do it, because the tungsten mineral is an oxide. A modi-

fied flotation method has been suggested. Norton H. Brown is one of the engineers who is devoting most of his time to tungsten mining. He not only acts as consulting engineer for several mines, but has two mines of his own. Forbes Rickard, Robert Grant, W. A. Schlessinger, and O. R. Whitaker are among those who have made important examinations for prospective purchasers.

Tungsten prospecting is being energetically pursued all over the State. George H. Barnhart of Ouray is opening the old Dunmore claim in the Red Mountain district. E. Frankenberry of Canon City paid \$25,000 for a tungsten prospect near Salida, on the Arkansas river. Nelson Franklin of Cripple Creek is building a tungsten mill at Rollinsville. The Tungsten Metals Corporation of Boulder will build a mill. The Primos Chemical Co. will build central compressor-plants and enlarge its mill. Tungsten is being produced in considerable quantities on Cement creek, in the San Juan. It has been found in the old Silver Bell mine at Ophir. Fred Carroll, the State Commissioner of Mines, and associates have consolidated a group of claims near the Old Bachelor mine at Ouray and will install a flotation mill.

In Summit county, there is more than usual activity. The Wellington, Old Union, Puzzle, Germania, Dunkin, King Solomon, Toledo, St. John, Jumbo, Silver Wave, Country Boy, Jessie, and many others are producing. The old district of Montezuma is commanding a good deal of attention on account of the rising price of silver. The dredges have finished their winter's overhauling and are again pumping gold from gravel to mint. H. J. Reiling is re-investing his Breckenridge gold in a big dredging project in Idaho.

Ezra D. Dickerman of the Star Consolidated at Leadville has taken a contract to produce and ship 70,000 tons of manganese ore to the Colorado Fuel & Iron Co. and allied interests. W. H. Kelso of Grand Junction is shipping high-grade manganese from Thompsons, Utah. E. E. Miller, a mining engineer of Denver, is opening up the old Alicante property near Wortman. Wortman lies between Leadville and Kokomo. He has installed a flotation plant in the old Burma mill. His enterprise is another example of modern processes giving value to orebodies heretofore of doubtful value. F. H. Thompson, manager of the Pioneer mine at Apex, has opened up a nice large body of ore on the Martin vein. W. G. Knappe and E. P. Young are building a cyanide mill for the quartzite ores of Red Cliff.

Zinc production is increasing in all the well-known zinc districts. Kokomo reports three new enterprises and increased production from old ones. Leadville has been mentioned so often in these pages that it is hardly necessary again to refer to it. Furthermore, the activities at Leadville are so varied and extensive that it would require a considerable space simply to outline them. At Rico the old Rico Mining Co., the owner of the largest acreage in that famous district, has come to life again and is actively developing. Other properties are increasingly active. The Tip Top and Weston Pass properties south-east of Leadville are active.

REVIEW OF MINING

As seen at the world's great mining centres by our own correspondents.

LORDSBURG, NEW MEXICO

RÉSUMÉ OF MINING CONDITIONS IN THE STATE

Mining throughout the State of New Mexico is thriving; many old properties are being opened; lessees at the larger properties are doing well, but some are having trouble in obtaining acceptance of their ore at the smelters, the larger contracts having the preference.

At Tyrone, the Burro Mountain Copper Co. is ready for extraction and treatment of its ore, after several years of preparation. While the initial production will be comparatively small, the company will enlarge its operations at all points during the year and by 1917, should be one of the State's largest producers of copper.

The Carlisle mine at Steeplerock has proved to be valuable. Unwatering was finished, and immense orebodies of both low and high-grade complex ores have been revealed. Timbers on the lower levels were found to be in good condition, and the operators have already begun hoisting lead ore, which is shipped to the El Paso smelter. An experimental mill is being erected, probably of 75-ton capacity, including flotation, electrostatic, and wet concentration. Some of the Carlisle ore has been shipped to the test-plant of the Empire Zinc Co. at Canon City, Colorado. The manager, H. K. Welsh, states that there are 200 men working at the Carlisle. The Carlisle Mines Co. has applied for articles of incorporation through its New York attorney.—Near the Carlisle, the Eclipse Mining Co. is developing and preparing for the extraction of high-grade ores contained in the Eclipse lode.

Several new companies in the State to file articles of incorporation recently have been the Black Hawk Mining Co. of Silver City, the Pecos Mines Co. of Pecos, San Miguel county, and the Ophir Development Co. of Jacarilla, Lincoln county. The Gold Bell Mining Co. of Deming is a recent corporation. Its property is north-east of Hillsboro, Sierra county, and was worked in the early days for the high silver-content.—Near the property of the Gold Bell company, John Sully and associates of Santa Rita are preparing to work the Snake mines. An old type Diesel engine has been overhauled and mining on a small scale has commenced.—The Opportunity mine in the vicinity is also being operated.

At Steins, several transfers of properties have taken place. The Oldem lead and zinc claims have been sold to Tombstone, Arizona, interests; and the Panama mines, sold by John Haydon to T. A. Lister and others of Lordsburg. McKenzie brothers are shipping copper ore to El Paso.

M. M. Crocker has sold his tungsten claims at Gage to the Nevada Hills Mining Co., which has begun work and is to erect an experimental mill soon.

The Chino Copper Co. continues its flotation work, and proposes the early erection of another flotation unit near the tailing dam. Twenty-five carloads of concentrate is being shipped daily to El Paso by the company.

In the Pinos Altos region mining has had a relapse. Several lessees are shipping ore, but the boom, recently quite prominent, has subsided.

At Hanover and Cleveland, the Empire Zinc Co. is adding the final touches to its treatment and power plants.

Zinc mining in Luna county is fairly active. The Mahoney property at Tres Hermanas is being operated; the Azure Mining Co. is also developing zinc claims purchased recently.

—Reports from Mogollon are to the effect that a strike was called by machinists at one of the mines. Operations, however, have not been retarded.

In the Lordsburg district the Eighty-Five Mining Co. is sinking its main shaft for a fifth level; the lowest is at 450 ft. Diamond-drilling is still being done at the Atwood mine of this

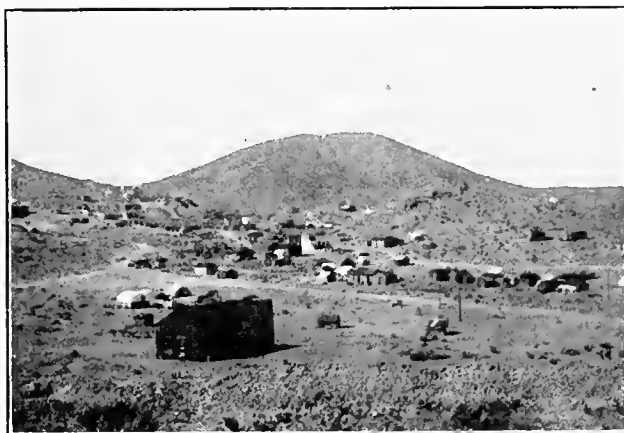

THE EIGHTY-FIVE MINE, LORDSBURG, NEW MEXICO.

company.—Near the Bonney mine, Frank Weldon and others have made a rich strike on the Nellie Gray claims, and are shipping the ore to El Paso. There are a number of lessees at work on different parts of the Bonney. The main Bonney shaft is being unwatered.

PLATTEVILLE, WISCONSIN

CONDITIONS INFLUENCING ZINC PRODUCTION: POWER, ROADS, ETC.

Severe weather at the beginning and end of March (snow and floods, respectively), shortage of electric power for nearly all zinc producers in the southern districts of this region, bad roads, and at times unsettled markets for zinc-blende, combined to curtail ore production at all points. The railroads were badly damaged also. The city of Galena was under water, and communication could only be maintained by boat. Lumber companies lost much building material, cement, and lime. In the southern districts, especially in the Pecatonica, LeFevre, and Galena River valleys, most of the large mines were filled with water. The northern districts were more fortunate, due principally to the fact that they are situated on higher ground.

Treatment of Wisconsin ore appears on another page of this issue.

The power problem is not improving, but the Inter-State Light & Power Co. of Galena may mend matters by the end of April, as complaints have been investigated by the State Railroad Commission.

For years bad roads have been distressful to outlying producers at the spring break-up; this year was no exception. Organized efforts made a year ago in the New Diggings district to induce the Chicago & Northwestern railway to construct a branch from the Galena line at Hazel Green to this new centre failed. Zinc producers and town authorities constructed a four-mile road, costing \$35,000, from New Diggings to Benton. No sooner was traffic started on this road than the

Now we immediately had surveyors at work staking out a ranch as earlier mentioned and the construction commenced. The ill-advised policy of the railway company finds only too many expressions on the part of operators who threaten to get even. The completion of the new road for vehicles resulted in the starting of auto-truck service for carrying ore and supplies.

Ore shipments in March were 37,816,000 lb. blende, 197,150 lb. lead, and 5,998,460 lb. pyrite.

The gross recovery of crude concentrates from all mines was 12,000,000 lb. and net deliveries to smelters 18,000,000 lb. The Mineral Point Zinc Co. delivered to smelter at DePue 1,870,000 lb. high-grade calcined 'jack.' As usual this company secured about half of the output contributed largely from its own mines. The bulk of low-grade ore was about evenly divided between the National and Wisconsin separators.

Boom conditions prevail at all points in the field. New producers with new equipment are being started in every centre. Much capital is being deflected to Wisconsin zinc mining. So great is the demand for drilling outfits that scores of companies are being formed for prospecting alone on contract agreements.

TORONTO, ONTARIO

NICKEL NOTES.—WIDE LOBE IN THE DOME.—NEW CYANIDE PROCESS AT DOME LAKE.—BOSTON CREEK MINES.

The nickel question is still very much in the foreground. An Order-in-Council has been issued by the Government prohibiting the export of nickel ore and matte except to British possessions, but as the Premier explained, it does not interfere with the present arrangement by which the International Nickel Co. secures its supplies of raw material from the Sudbury district, as it will continue to export under special license. The prohibition was intended to apply to another company, not named, which, it was discovered on investigation, had been exporting nickel without an arrangement with the Government, and the destination of the shipments could not be traced. Heretofore any exporter will have to satisfy the British and Canadian governments of the ultimate destination of the metal before a license to export will be granted. This action does not by any means satisfy those who are agitating for all refining of nickel to be done in Canada. As the International company has assured the Government that it intends to proceed immediately with the erection of a refinery of sufficient capacity to satisfy all the requirements of the Empire, probably at some point in Nova Scotia, it is not likely that its supplies will be cut off in the meantime. But judging from the growth of the movement, which has been greatly strengthened by wartime tension and the development of Indemist sentiment, it is altogether probable that as soon as a refining plant is provided, the export of raw material will be put under embargo. The Ontario Nickel Commission is now in Norway and will visit Madagascar and New Caledonia before returning to Canada.

On No. 7 level of the Dome mine the ore-body is 244 ft. wide, averaging over \$5 per ton, with considerably higher gold content in parts. Excavation is progressing for the new steel head-frame, which will be 125 ft. high. March production established a new record, the value being \$173,370 from 34,200 tons of \$5.95 ore. The Dome has taken an option on the Dome Extension until October 15, 1917, under which, if taken up, the shareholders of the Dome Extension will receive 46,000 shares of Dome Mines stock in exchange for the property. In the meantime the Dome Extension will continue operations on the upper level, and the Dome management will undertake exploration work from its No. 3 shaft.

The statement of the Hollinger company for the month ended February 25 shows gross profits of \$169,505 from 39,658 tons of \$2.91 ore. Working costs were \$2.97 per ton.

Much interest is occasioned by the installation of a cyanid-

ing machine now in progress at the Dome Lake. The process is claimed to yield a high extraction at low cost. It includes a drum 15 ft. long and 7 ft. 6 in. diam., lined with a filter medium of porous brick. Pulp flows into a charge tank with a dilution of 1:1, and then into the drum where air is blown into it to displace the water. Cyanide solution is run under pressure, and the drum revolved from 1 to 3 hours. The cyanide solution is replaced by a wash solution, and the pulp taking discharged. Zinc shaving is used for precipitation.

At the R. A. P. syndicate mine, Boston creek, results of recent development have been highly satisfactory. There is high-grade ore in the face of both drifts; east it is 12 in. wide in a 34-ft. orebody, and west 7 in. wide in a somewhat narrower body. The Miller Independence, at Boston creek, has a fine showing. The vein has been opened in three places, and contains free gold and a telluride supposed to be calaverite. A shaft is being sunk to cut the vein at 40 feet.

CRIPPLE CREEK, COLORADO

GENERAL MINING NOTES.

A rich surface discovery was recently reported at the Rotten Hole claim, on the south side of Mineral hill, not far from the north boundary of Cripple Creek. The sugar-quartz found on the surface pans gold freely, and the vein-matter in place gives every indication of being persistent.

The Consolidated Mines & Reduction Co., which recently took over the Ella W. property on Tenderfoot hill, has awarded a contract for 300 ft. of tunnel work. This adit will cut the Ella W. vein at an approximate depth of 85 feet.

During the last fiscal year the Granite company made a total gross production of \$534,150. After all operating expenses, freight, and treatment charges were paid, the net production was \$337,795.

A new cyanide plant is being constructed by W. A. Reed on the former site of the Gaylord mill to treat low-grade ores from the Gold Sovereign dumps. This new equipment will be on the estate of the Dante company, on the south-west slope of Bull hill.

The Vindicator Consolidated has taken over the old La Bella electric-lighting plant at Goldfield, and announces its intention to construct a mill for the treatment of low-grade ores by flotation.

The Isabella mine produced 2385 tons of ore during March; 81 of the 90 narrow-gauge cars billed were shipped by lessees, the other 6 were extracted from the company's recently discovered shoots on the 15th level of the Lee shaft. The Isabella mill is again operating at a profit.

DEADWOOD, SOUTH DAKOTA

CUSTOM-MILL INVESTIGATION.

Further investigation by the mines and mining committee of the Deadwood Business Club of the feasibility of erecting a custom cyanide-plant at Deadwood is bringing to light additional properties which apparently can soon be depended upon to furnish ore for the plant. At the last meeting of the committee a number of property-owners were present who stated definitely that they could produce ore suitable for treatment in the contemplated mill. For various reasons, one of the most common of which was lack of transportation, they had only produced in a small way in the past. All were agreed that a custom motor-truck would enable them to ship at a profit, as in many cases that service would save them \$2 per ton. As a next step in the work it is proposed to engage two of the club members—A. T. Roos and Jesse Simmons—to make detailed investigations of the various embryo shippers with a view to determining the ore reserves in various properties. These men will be expected to sample and report on at least 20 different properties near Deadwood. It is reported that more tungsten deposits have been found.

THE MINING SUMMARY

The news of the week as told by our special correspondents and compiled from the local press.

ALASKA

JUNEAU

During March the Alaska Gastineau mill treated 162,796 tons of \$1.03 ore, compared with 122,856 of \$1.02 in February, and 119,914 of \$1.42 in January. The recovery last month was 77.47%, with 20.3c. tailing, against 78.56% and 19.8c. in the previous month. No. 2 stope of the east fifth level yielded poor ore. Conditions are improving.

ARIZONA

Bulletin No. 18 of the State Bureau of Mines is on vanadium, by P. E. Joseph. Those interested will find a good deal of useful information. While no production has been reported from Arizona, the ore is found as vanadinite associated with lead in Cochise, Gila, Pima, Yavapai, and Yuma counties. Ore containing 10% vanadic acid is worth 50c. per pound.

GILA COUNTY

To improve the relations between the Inspiration Consolidated and its employees, the general manager, C. E. Mills, has issued a circular to them, in which it is desired that they appoint four to act as a committee to confer with the company on grievances and the like.

During one day last week the Inspiration mine produced 18,000 tons of ore. To do this the hoists did not work the full 24 hours. The coarse-crushing plant only operates two shifts, as the bins are of large capacity. Some more standard-gauge 60-ton railroad ore-cars are soon to arrive.

PINAL COUNTY

(Special Correspondence.)—The Ray Hercules Copper Co. is sinking a three-compartment shaft to 1000 ft. depth in the

drilling on 13 acres, of the 207 in the property, had indicated 3,428,774 tons of 2.36% ore. Subsequent work has widened the mineralized area; holes north and east proving 90 to 145 ft. of over 2% ore.

Ray, March 27.

MOHAVE COUNTY

Lenzite crystals have been shipped again from the Arizona Venture Corporation's property in the Cedar Valley district, in charge of W. D. Grannis. These are used in wireless telegraphy.

ARKANSAS

MADISON COUNTY

Aurora is prosperous and busy under the stimulus of high zinc-ore prices.—The most promising of the new mines is the Red Wasp, 2½ miles north-west of the town. Three drill-holes cut good ore. Mining is done at 110 to 160 ft. depth. In 10 hours the 150-ton mill is producing 10 tons of high-grade concentrate; the ore contains 7 to 12% zinc, and the product 60%. The ore slimes easily, and a sludge department has been added.—A good deal of drilling has been done on ground near the Red Wasp, with encouraging results.—East of Aurora the United Zinc Co. is getting good returns.—Farther south the Aurora Union company's new 300-ton mill has been started. Ore is mined at 150 ft., but some occurs at 250 feet.

MARION COUNTY

Zinc-ore shipments from north Arkansas in March totaled 3,928,000 lb., mostly high-grade carbonate. The Red Cloud at Rush yielded 480,000 lb., followed by the Philadelphia with 300,000 lb., Leader, Morning Cloud, and Yellow Rose, with 240,000 lb. each, and McIntosh with 180,000 lb. In Newton county the Big Hurricane and Ponca City produced 300,000 lb. each.

CALIFORNIA

AMADOR COUNTY

The preliminary report of the Plymouth Consolidated for March is as follows:

| | |
|---------------------------|----------|
| Ore milled, tons | 10,750 |
| Gold recovered | \$62,300 |
| Working expenditure | 32,980 |
| Development charge | 5,670 |
| Surplus | \$23,650 |
| Other expenses | 184 |

CALAVERAS COUNTY

(Special Correspondence.)—The Pioneer Chief Gold Mining Co. has purchased the Kane ranch. This property borders on the south fork of the Calaveras river, and contains 203 acres of land which partly surrounds the original Pioneer Chief quartz claim. The shaft on this property is now down 390 ft. The solid body of ore was cut at 320 ft., and continues to the present depth, with an average width of 6 ft., assaying \$8 per ton. At the 350-ft. level the north-west drift is in 47 ft., 35 ft. of which is in \$8 ore, the remainder being in a crushed mass of broken country and ore. The south-east drift on the same level, is in 50 ft. The vein is wider than the drift, which is 7 ft., and is valued at \$9.50 per ton. The foot-wall is solid and hard, while the hanging wall is soft and heavy. At 380 ft. in the shaft, the vein gradually runs into the foot-wall, so that workings from now on may be opened in the foot-wall solid

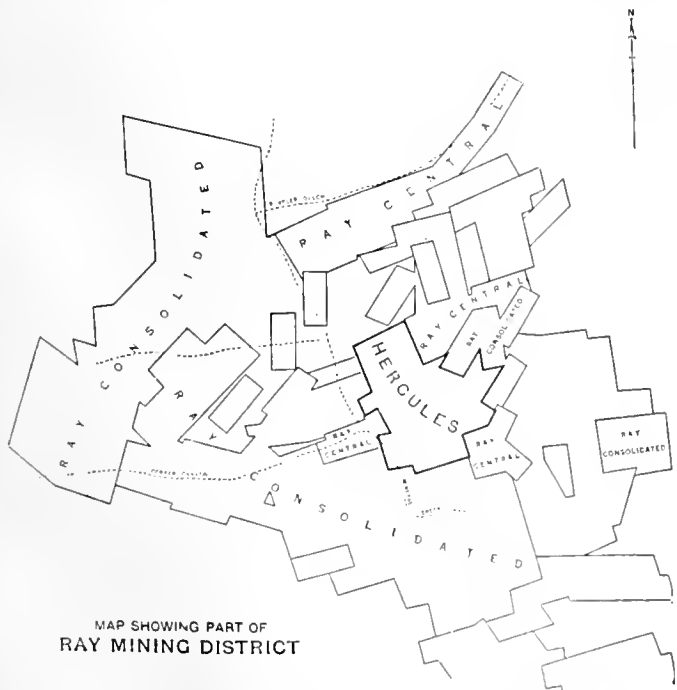

MAP SHOWING PART OF RAY MINING DISTRICT

Grace L. claim, situated within the boundaries of the town of Ray. Plans for a 1000-ton concentrating plant are being prepared, and a mill-site surveyed. Up to October of last year

formation and avoid much of the expense of timbering and re-timbering. It is expected that the 500-ft. level will be reached by May 19. A small experimental plant for milling the ore mined during development, may be installed during the summer. N. J. Martin of San Francisco is consulting engineer, and J. T. King is superintendent.

San Andreas, April 5.

ELDORADO COUNTY

The Springfield district is increasing in activity. The Noonday copper mine was reopened last week with 12 men, while 13 are at the Union. Some more work is being done in the Shingle district.

HUMBOLDT COUNTY

Nearly all the snow has disappeared and the Humboldt Copper Co. is to resume work at its Horse Mountain mine. Diamond drilling is to be started. The Bonnieville company's copper claims are of promise. The Gold-Platinum Mining Co. will probably resume at its placer property on New river. The Corona company is sluicing at Hawkins bar.

KERN COUNTY

(Special Correspondence.)—A 20-ton Lane slow-speed mill and cyanide plant are being erected on the Elephant mine, four miles southeast of Mojave, by Mr. Parnell.—The Mojave Consolidated gold mine was sold at a sheriff's sale March 22 to A. A. Morriss to pay for wages due. This is a good property, but has been burdened with mismanagement. George R. Phillips has been appointed mill superintendent of the Soledad Consolidated Mines Co.'s mill near Mojave.

Mojave, April 9.

NEVADA COUNTY

An antimony vein of good width and high grade has been uncovered on the ranch of R. Johnson, near Grass valley.

PLUMAS COUNTY

The development and equipment of the Walker copper mine, 20 miles east of Portola on the Western Pacific line, is described in the Salt Lake *Mining Review* of March 30 by Will C. Higgins. Utah capital is responsible for the present state of the property. A severe winter curtailed operations, but speed is now in order to get the mine on a producing basis. There are 34 heavily-timbered claims in the group, through which the Bullion vein has been traced for 4800 ft. A shaft has been sunk and adits driven, opening up to 15% ore in good widths. A cross-cut at 125 ft. depth averages 6 to 8% copper and 3 to 4 oz. silver. A cross-cut adit is in 400 ft. to open ore 75 ft. below the shaft-bottom 800 ft. in. Diamond-drilling has recently been done, No. 1 hole being put down 256 ft. from the 65-ft. level. Assays of each 5 ft. for 200 ft. averaged 7.28% copper, \$1.11 gold, and 2.7 oz. silver per ton. Further drilling is under way from the 125-ft. level. Reserves are estimated at 50,000 tons of profitable ore. A Leschen aerial tram, 4200 ft. long, is being erected to carry ore to the new mill, 800 ft. lower than the shaft bins. The tram works by gravity, and has a capacity of 250 tons in 16 hours. The plant will treat 100 tons per 24 hours by straight flotation, using the following machines:

Allis-Chalmers jaw-crusher, apron-feeder, Allis-Chalmers ball-mill reducing to 60-mesh, Dorr duplex classifier, Callow cones, four Callow rougher-flotation cells, one Callow cleaner-cell, and Oliver filter. On 6% ore a recovery of 93% is expected, concentrate to contain 20% copper. The estimated cost of producing 98 concentrate (copper at 17c) is \$27.25 per ton. The product will also contain \$19 per ton in gold and silver.

SAN BERNARDINO COUNTY

Atolia has now a piped water-supply, making residents much more comfortable. Many improvements are under way at the town. Santa Fe officials visited the place last week. Telephone and telegraph service is now available. About 30 jitney-buses are running between Atolia and Johannesburg, Rands-

burg, Mojave, and Kramer. Cheap electric current is ready for service. It is said that Atolia received its name from the first two letters of Atkins, a well known mining man, and the last four letters of DeGolla, an Italian who shipped tungsten to Germany from the district. Eight high-graders were arrested for stealing tungsten ore last week. A scheelite nugget weighing 142 lb., for which \$4 per lb. was offered, was unearthed by Italians 2½ miles from the Atolia mill.

SHASTA COUNTY

Work has been resumed at the Afterthought mine at Ingot. A large copper and zinc plant is to be erected.

TULARE COUNTY

Portersville has added zinc to the list of mineral deposits worked nearby, namely, chrome, granite, magnesite, and manganese. It is reported that an extensive deposit of zinc has been found in the foothills.

COLORADO

CLEAR CREEK COUNTY

(Special Correspondence.)—The Onondago Mines Co. is shipping 20 tons of ore per day from development on the 180-ft. level. The vein there is 7 ft. wide; on the 100-ft. level it is 2 ft. wide. A sorting-house and orebins are to be erected at once, also a loading trestle to the company's railroad spur at the mine. The ore yields \$9 per ton net, but will be sorted into smelting and milling ore. After enough development has been done, a concentrating mill will be built. The manager, T. Kynor, states that the new compressor plant is giving good results and that the air in the mine is much improved.

The manager of the Imperial mines, H. Butler, reports the cutting of a 11-in. vein of copper pyrite.

The Colorado Central Leasing Co. is making good headway in sampling its dumps. E. S. Ward is in charge of the work and is satisfied with the value of the samples taken. A 100-ton mill will be erected in Georgetown, and a tramway built to convey the ore from the mine to the mill a distance of two miles.

The Hollingsworth Mining Co. at Silver Plume in March shipped 150 tons of concentrating ore, yielding two cars of 49% zinc concentrate and 6 tons of 60% lead. There is a good deal of gray copper and ruby silver now appearing in the ore, which may necessitate hand-sorting to save this high-grade product.

At the Mendota mine, Silver Plume, Stephens brothers have completed the addition to their concentrating mill, and will now be able to handle the large tonnage of zinc and lead ore they are mining.

Georgetown, April 9.

DOLORES COUNTY

The Emma gold mine in the Cone district has been optioned to the Tonopah Belmont Development Co.

The report of the Rico Wellington Mining Co. for last year states that the output was 11,904 tons \$8.88 copper ore, 18,132 tons of \$11.69 lead ore, and 629 tons of iron sulphide worth \$4 per ton. The revenue from ore sales was \$105,573. The cash balance was \$3373 at the end of 1915. There was 5985 ft. of development done.

LAKE COUNTY (LEADVILLE)

(Special Correspondence.)—The Derry Ranch Gold Dredging Co.'s boat near Leadville, which has been shut-down during the winter on account of severe climatic conditions, resumed work on April 4. It is expected that the dredge will continue operating through the remainder of the year. This dredge started last fall, and after operating two months, cleaned-up \$69,292, which enabled the company to pay a 25% dividend, and still left a good working balance in its treasury.

Leadville, April 7.

SAN JUAN COUNTY

Ore shipments from the Silverton district in March totaled 134 carloads.

TELLER COUNTY (CRIPPLE CREEK)

On April 11 the Roosevelt drainage-tunnel and the main shaft of the Elkton were connected at a point 4 miles from the tunnel portal and a depth of 1640 ft. Rock broken in extending the adit will now be hoisted through this shaft. The flow of water is 14,780 gal. per minute.

IDAHO

IDAHO COUNTY

Three stamps at the Mineral Zone gold mine near Elk City recovered \$2300 from 15 days' run recently. Prospects are said to be favorable. G. L. L. Baskett is in charge.

SHOSHONE COUNTY (COEUR D'ALENE)

Wages of Coeur d'Alene miners in April will be \$4.50 per day, on account of the high average of lead during March, namely, 7.26c. per pound.

Dividends payable by Coeur d'Alene mines in April total \$716,650, making \$3,154,435 for the four months.

At the Interstate-Callahan the shaft is being sunk 5 ft. daily on its way to 400 ft. below No. 6 level. A hoist was installed underground at this point. During March there was shipped 600 tons of lead concentrate and 6100 tons of zinc ore and concentrate. The profit was \$325,000. The mill is treating 400 tons daily, recovering 92%. A 1200-ton plant is soon to be erected at Enaville. The company's cash on hand and unsettled ore shipments total \$500,000.

Development in the Idora is reported to be very good. New Janney flotation machines are being installed in the mill.

To prevent any conflict with the American Smelting & Refining Co., which has a contract until January 31, 1930, for all of the product of the Bunker Hill & Sullivan mines that contains between 30 and 75% lead, the Bunker Hill company, which has begun construction of its smelter near its properties at Kellogg, is planning to eliminate its water concentration system, according to reports, and the only preliminary treatment the ore will receive before going to the reduction plant will be jigging. Ever since the contract with the A. S. & R. Co. was entered into in 1905, when the Bunker Hill company sold its Tacoma smelter to the Guggenheim interests, the entire output of the mines has been reduced to a concentrate that averages about 63% lead and 20 oz. silver per ton. By abandoning water concentration and substituting a jig treatment the product can be reduced to less than 30% lead. This would leave it free to treat the ore in any way it saw fit, provided its final product was higher in grade than 75% in lead. As the Kellogg smelter and refinery will ship nothing but refined lead and silver, there is no ground left on which the A. S. & R. can base a complaint of violation of contract. The composition of the Bunker Hill company's ore is such that it is practically self-fluxing as it comes from the mine, with the addition of a certain amount of lime. It contains a great deal of iron, as is evident from the tailing-dumps at its concentrators, from which the Northport smelter now is obtaining its iron for flux. The quantity of lime required, while large in the aggregate, will be small in comparison with the tonnage of ore treated. The lime will almost certainly be obtained for the present at least from the vicinity of Northport, and probably from a quarry in the neighborhood of that belonging to and supplying the Northport smelter. The practice of the Bunker Hill will in this respect be just the opposite of the Northport plant. Instead of hauling the ore to the flux the Bunker Hill will haul the flux to the ore.

MICHIGAN

THE COPPER COUNTRY

Copper production in March was as follows:

| Mine | Pounds | Mine | Pounds |
|-----------------|-----------|--------------|-----------|
| Osceola | 1,866,000 | Superior | 324,000 |
| Almeek | 2,160,000 | Franklin | 469,000 |
| Wolverine | 550,000 | Copper Range | 4,300,000 |
| Mohawk | 1,340,000 | Victoria | 200,500 |
| Isle Royale | 954,000 | Quincy | 2,100,000 |
| Calumet & Hecla | 6,150,000 | Hancock | 175,600 |
| Centennial | 228,500 | Tamarack | 684,000 |
| Allouez | 935,000 | White Pine | 385,000 |
| Mass | 442,000 | La Salle | 103,000 |
| | | Lake | 205,000 |

There are 18,000 men working in the mines, mills, and smelters of this region, drawing a total monthly wage of \$1,500,000. A large number of new accounts have been opened in the local banks.

The White Pine Copper Co.'s output in 1915 (8 months) was 2,824,145 lb. refined copper from 114,039 tons of ore with 67% recovery, an average of 24.76 lb. per ton treated. The cost was 16.64c. per lb. The revenue was \$518,318 from copper sold at 18.353c. From the sale of 18,460 shares of preferred stock at \$25 was received \$461,500. Total expenditure was \$705,473. Development covered 8605 ft., against 4721 ft. in 1914. Work at depth is highly encouraging. Sheet-copper, which may become 'mass,' has been found at the contact of shale and sandstone. The tailing, containing high content in copper, is being stored for future treatment by flotation.

Drilling at the White Pine Extension further proves the

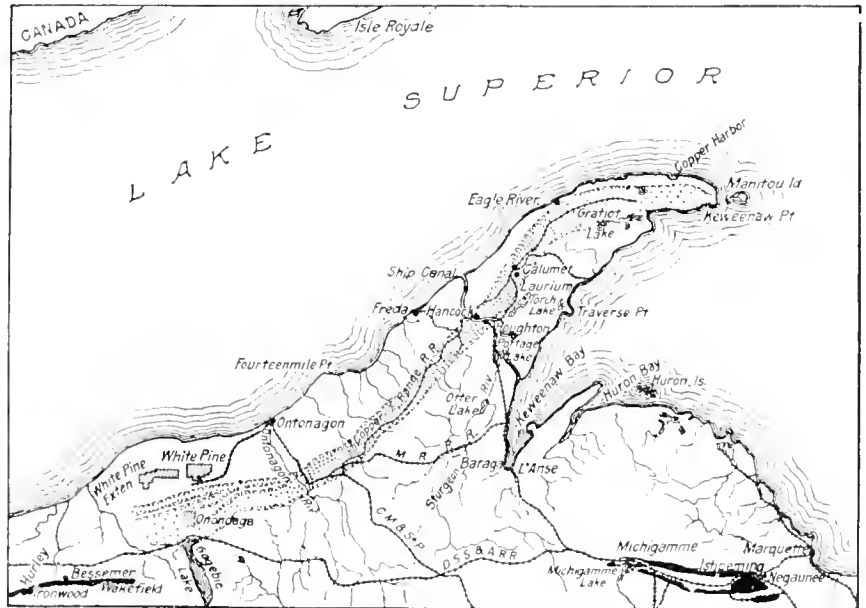

Copper Belt shown thus;—IRON RANGES Iron Deposits shown thus:—

THE COPPER COUNTRY AND TWO OF THE IRON RANGES OF MICHIGAN.

uniformity of copper content. Shaft-sinking is making five feet daily.

When the shipping season opens on the lakes there will be hardly any copper at docks, metal being dispatched 'lot' from smelters by rail.

Tamarack shareholders evidently know the value of the Calumet & Hecla offer for their property, and are turning-in holdings for the \$59 per share.

Exploration on Isle Royale, the island in Lake Superior, is to commence this spring. Its area is 90,000 acres, a good deal of which has been prospected from time to time. Some time ago it was acquired by Thomas F. Cole and others.

MISSOURI**JASPER COUNTY**

The ore market at Joplin was stronger during the week ended April 8, the top price for 60% blende being \$120, and 80% lead \$122.50, while 40% calamine realized \$90 per ton. The output of the Missouri-Kansas-Oklahoma region was 7819 tons blende, 352 tons calamine, and 974 tons lead, averaging \$106, \$82, and \$101 per ton respectively. The total value was \$960,679.

MONTANA

The returns from 9 months' operation of the State Industrial Accident Board show that the number of accidents is decreasing. There are 1163 employers with about 60,000 men in all industries. Of 4822 accidents 107 were fatal, two catastrophes at Butte swelling the number considerably. Compensation in all forms amounted to \$301,150. The Board's expenses in a year were \$19,747, covering everything.

JEFFERSON COUNTY

The Crystal Copper Co., recently formed to operate the Crystal mine in the Cataract district, near Basin on the Great Northern line, 30 miles east of Butte, will probably build a mill. W. H. Weed, managing director, recommends this and deep development. About \$100,000 will be spent in 1916.

LEWIS AND CLARK COUNTY

The *Montana Daily Record* of April 1 contains an interesting description of the Scratch Gravel district, three miles north of Helena, written by R. F. Wilkinson.—Early work consisted of mining silver ore and sluicing for gold.—On the Cruse estate is the Franklin mine, which during the past four years has been re-opened. Its results have been the cause of renewal of interest in the district. From December, 1914, to February, 1916, there has been shipped 137 cars of ore yielding \$226,550, and a profit of \$145,642. The output is now 600 tons a month. Power is supplied by gasoline engines.—The Scratch Gravel Gold Mining Co. is exploring an extension of the Franklin vein. Its shaft is down 300 ft., where there is 30 in. of ore assaying 2.54 oz. gold and 12.5 oz. silver. The output is 300 tons per month, sent to the East Helena smelter. Walter Larsson is superintendent.—One of the newest syndicates to commence work is the Madden Scratch Gravel Mines Co., whose development is very promising. Rich gold-silver ore was mined years ago.—The Crown Butte mine is operated by the Rival Mining Co. of Portland, Maine. About 2000 tons of \$15 ore has been blocked out, and the property is regarded as a valuable one.—The Eastern Belle, Copper Silver Montana, Thomas Flynn, Maverick, Cal. Stevens, G. Gordon, Hermann, Anson, Walsh, Scherrer, Stevens & Kesslers, and Gerry properties are all of merit and are being developed.

SILVERBOW COUNTY

At 1500 ft. in the East Butte, 8 ft. of 6 to 7% copper ore has been cut. In March over 1,300,000 lb. was produced.

During March the Butte & Superior mill treated 56,926 tons of ore, yielding 16,500,000 lb. of zinc in concentrate. The recovery was 92.5%.

The 3000-ft. level of the North Butte mine is opening better than at 2800 ft., especially on the Edith May vein.

Silicious copper ore is required by the British Columbia Copper Co.'s smelter at Greenwood, B. C., and the Bullwhacker company has been asked to supply it regularly.

The Bullwhacker has been leased to J. A. Heilbronner and Patrick Wall, 900,000 out of 1,000,000 shares favoring the transaction. The lessees will operate under the name of East Side Mining Co.

A steam hoist of 4000-ft. capacity, to lift 3½ tons, and costing \$50,000 has been ordered by the Davis-Daly from the Nordberg Manufacturing Co. The engine will be ready for work by September.

NEVADA**HUMBOLDT COUNTY**

An extensive area of copper-gold-silver ore is reported as occurring in the Sonoma range, 5 miles southeast of Winnemucca. The Wolverine Copper Co. is equipping and developing its holdings there.

(Special Correspondence.)—A mining revival in the southern part of this county is predicted. The James Sutherland estate contains the Sutherland antimony mine, in Cole canyon, 16 miles north-west of Lovelock. H. E. Gove has arrived to take charge. By June a large output of antimony is expected.

Lovelock, April 1.

In a winze 50 ft. below 1500 ft. in the Seven Troughs Coalition mine is 8 in. of \$2000 ore.

The new development in the cross-cut from the 450-ft. drift in the east vein of the Rochester Mines Co. has proved the greatest discovery ever made in Rochester hill. This cross-cut runs east toward the foot-wall, and has cut through 30 ft. of ore. The last 1½ ft. is estimated at 500 oz., and the last foot shows native silver, assaying over 1000 oz. per ton. Although this has always been referred to as the 450-ft. level, in relation to some of the other workings, the drifts from the bottom of the Codd and Big Four winzes from which this cross-cut is driven are really about 800 ft. on the dip of the vein. Although the mill lost 7 days in March, the output was \$12,000.

At the Nevada Packard the mill is treating 110 tons of \$10 ore. Mining and milling cost \$2.86 per ton.

LINCOLN COUNTY

At the Prince Consolidated at Pioche is 120,000 tons of tailing in pits assaying 0.11 oz. gold, 10.6 oz. silver, and 6.7% lead, which is to be treated by flotation followed by cyaniding.

NYE COUNTY

Through the additional water supply recently obtained the Round Mountain company is sluicing 1750 cu. yd. of gravel daily.

Tonopah mines last week produced 8429 tons of ore worth \$176,982. During March the Tonopah Mining Co. produced 7740 tons of \$17.30 ore, making a profit of \$50,280. Development at 950 ft. in the Rescue-Eula is very encouraging. The output last week, sent to the West End mill, was 206 tons.

ORMSBY COUNTY

(Special Correspondence.)—Prospecting for copper, silver, lead, and gold deposits is active in the vicinity of Carson City, and several encouraging discoveries have been reported in the past two months. Ten miles south-west of the capital Smith and Foote are developing a free-milling gold claim. The vein is 14 ft. wide, and averages \$10 per ton. Streaks assay over \$1000 per ton.

The Day mine in Brunswick canyon has been taken under lease by W. Knippenberg. A good quantity of copper ore is exposed, and early shipments are proposed. The property has been developed intermittently for several years.

Art Smith and associates are opening copper-gold ore, some of it high-grade, two miles west of Carson City. Shipments may be started before the close of summer.

Five miles from here a promising silver-lead prospect is being worked by E. Sweetland and M. Smith. Some rich ore has been uncovered, and prospecting is proceeding to determine the extent of the orebody. Many abandoned silver-lead prospects are being re-located and worked.

Carson City, April 5.

OREGON**JOSEPHINE COUNTY**

The Black Eagle property near Grants Pass has been sold by W. S. Neill and others to P. H. Walters, P. Wright, and F. Pirth of Seattle for \$175,000. A 50-ton mill is to be erected.

Tungsten ore has been opened three miles above Gold Hill.

UTAH**JUAR COUNTY**

It is proposed by Tintic operators to select a well-situated shaft and sink it to 2500 ft., in order to explore the orebodies below water-level.

The new plant of the Tintic Milling Co. at Silver City is a success, especially the Holt-Dern and Knight-Christensen roasting furnaces.

The Iron Blossom company will pay its quarterly dividend of 10c. per share on April 25. The treasury contains \$342,000.

During 1915 the Dragon Consolidated Mining Co. did 2616 ft. of development, with good results. There was shipped 7805 tons of ore, yielding 2560 oz. gold, 102,144 oz. silver, 14,766 lb. lead, and 490,750 lb. copper, realizing \$103,899. Cash balance was \$38,627, an increase of \$35,000.

SALT LAKE COUNTY

Snow will have disappeared from the American Fork district in a few days, allowing several companies to commence shipping ore.

The Utah Apex averaged 600 tons of ore daily in March, yielding 3,500,000 lb. of lead. Profits are \$100,000 per month. The A. S. & R. and U. S. S. R. & M. companies buy the lead and lead-zinc ores. About 400 men are employed.

SUMMIT COUNTY

The orebody found in the Daly-Judge mine in January has been opened for 180 ft. by a raise, where it is from 1 to 13 ft. wide. Plans for the electrolytic zinc smelter are complete. The company's name is to be changed to the Judge Mining & Smelting Co., with a capital of 500,000 \$1 shares, an increase of \$200,000. Flotation is giving better results each month in the mill. The Snake Creek tunnel is in 14,000 ft., up to the Daly-Judge boundary. The present contract is finished, by J. A. McIlwee, and has been accepted. The flow of water is 19 second-feet, or 8628 gal. per minute.

WASHINGTON

The various copper districts tributary to Spokane promise to be operated to capacity this summer, as prices are high and capital is easy to get for development.—In the Chewelah district of Stevens county the United Copper Co. has a 74-stamp mill and flotation plant treating 225 tons per day, employing 90 men. The Security and Copper King companies are busy with exploration.—In the Loon Lake district the Loon Lake Copper Co. is shipping ore.—At Mullan, Idaho, the National is treating ore in its mill, while the Reindeer-Queen and Carney, near-by, will soon be shipping ore.

STEVENS COUNTY

To treat a large quantity of silver ore at the Deer Trail mine near Turk, a 100-ton mill is to be erected by H. R. Moss, late of Oakland, California, and now of Spokane.

There are 70 men employed at the Electric Point mine, near Northport. The dumps contain over 4000 tons of 60 to 80% lead ore. This is a recently discovered deposit.

CANADA**BRITISH COLUMBIA**

Dividends payable in April total \$277,330, making \$1,142,956 for four months.

Ore received at the Trail smelter to the end of March totaled 117,674 tons from over 20 mines.

MEXICO**HIDALGO**

The U. S. S. R. & M. Co. reports that on the 1400-ft. level of its Real del Monte mine at Pachuca the shoot is of great length. It assays \$30 per ton, and the total silver value is \$15,000,000.

PERSONAL

Note: The Editor invites members of the profession to send him particulars of their work and appointments. This information is of unquestioned interest to our readers.

LESLIE H. WEBB is here.

J. M. HYDE is at Denver.

S. F. SHAW is at Ely, Nevada.

P. H. ARGALL is at Silver City, New Mexico.

JAMES E. JOPLING of Michigan is at Boston.

F. H. MINARD has been examining mines in Colorado.

JAMES S. WROTH has left New York for Santiago, Chile.

F. R. WEEKES is in California on professional business.

R. B. WALLACE has removed from Republic, Michigan, to Gwinn.

RUSS M. HESS has returned from Ecuador to Stoddard, Arizona.

C. H. POIRIER, manager of the Vipond mine at Porcupine, is in New York.

J. H. SMITH, JR., recently at Cerro de Pasco, has gone to Melones, California.

R. B. WATSON, managing director of the Nipissing mine at Cobalt, is at Oatman.

K. C. LI sails today on the *Chinyo Maru* from San Francisco on his return to China.

O. H. FAIRCHILD has been appointed manager of the Ramage mines at Joplin, Missouri.

HENRY M. PAYNE, of New York, has been lecturing on alluvial mining at the University of Utah.

G. W. McDANIEL, field engineer for the Tonopah Mining Co., has returned from northern Canada to Tonopah.

W. H. LANDERS returned to New Almaden on April 15 from Nevada and left on the 19th for Black Butte, Oregon.

W. E. SEGSWORTH of Toronto is preparing to close the Seneca-Superior mine at Cobalt, of which he is managing director.

H. E. JACKMAN of Rochester, New York, is president of the National Mines Co., Ltd., which will explore the King Edward mine at Cobalt.

LEWIS A. LEVENSALER, formerly field engineer for the Tacoma Smelting Co., is now connected with the Tacoma Exploration Co. of Tacoma, Washington.

FREDERICK G. CLAPP, managing geologist of the petroleum division of the Associated Geological Engineers, has removed his headquarters from Pittsburg to New York.

A. H. BROWN has resigned as manager for the Hudson Bay Mines of Cobalt, and of the Dome Lake Mining & Milling Co. of South Porcupine, and is now at his home at London, Ontario.

ROBERT STERLING, who for the past two years has been chief engineer for the Goldfield Consolidated Mines Co., has gone to Colorado as assistant manager for the Primos Chemical Co. at Vanadium, San Miguel county.

A party of the Associated Geological Engineers of New York, consisting of MYRON L. FULLER, FRANK A. HERALD, and RALPH W. RICHARDS, is conducting geological investigations in northern Oklahoma and southern Kansas.

GUY C. RIDDELL, about 10 years superintendent of the East Helena lead smelter of the American Smelting & Refining Co., has resigned to become a director of the Montana Ranches Syndicate, of which he has recently been made a vice-president.

DONALD M. LIDDELL, for several years managing editor of the *Engineering and Mining Journal*, has resigned, and is now consulting engineer with Merrill, Lynch & Co., 7 Wall Street, New York. PERCY E. BARBOUR succeeds Mr. Liddell as managing editor.

The Pacific Coast division of the American Association for the Advancement of Science meets at San Diego between August 9 and 12. Some interesting addresses will be given. Albert L. Barrows is secretary, at the University of California.

THE METAL MARKET

METAL PRICES

San Francisco, April 18

| | |
|---|--------|
| Antimony, cents per pound..... | 44 |
| Electrolytic copper, cents per pound..... | 29 |
| Pig lead, cents per pound..... | 8.00 |
| Platinum, soft metal, per ounce..... | \$88 |
| Platinum, hard metal, 10% Iridium, per ounce..... | \$92 |
| Quicksilver, per flask of 75 lb..... | \$1.50 |
| Spelter, cents per pound..... | 22 |
| Tin, cents per pound..... | 16 |
| Zinc-dust, cents per pound..... | 30 |

A consular report from Cartagena, Colombia, S. A., states that the monthly output of platinum is over 1500 oz. per month by independent producers.

ORE PRICES

San Francisco, April 18

| | |
|--|-------------|
| Antimony, 50% product, per unit, of 10, or 20 lb..... | \$2.25 |
| Chrome, 40% and over, for cars California, per ton..... | 12.50 |
| Magnesite, crude, per ton, for b. cars..... | 8.00 |
| Magnesite, plastic, no iron and lime, calcined, ton..... | 25.00-30.00 |
| Magnesite, refractory, 11% iron, dead-burned, ton..... | 35.00 |
| Manganese, 50% metal, 8% silica, per ton..... | 12.00 |
| Tungsten, 60% W.O., per unit of 20 lb..... | 65.00 |
| Vanadium, 10% vanadic oxide, per lb..... | 0.50 |

All tungsten buyers at Boulder, Colorado, are paying \$75 per unit, with no premiums.

Tungsten: A New York dealer writes: "Though reports from Colorado and Nevada quote around \$100 per unit, I have been unable to find any buyers above \$85 for prompt delivery, New York, and it seems extraordinary that the biggest buyers in this country should pay the high figures in Colorado and not be prepared to accept material at 15% lower in New York. Forward tungsten has again changed hands at \$75, and business for shipment as far ahead as July and August has been contracted around \$70 per unit."

Chrome iron ore production of the United States in 1915 was 1281 tons, worth \$3,734, against 591 tons and \$8715 in 1914.

EASTERN METAL MARKET

(By wire from New York.)

April 18: Copper is quieter but strong; lead has an easier tendency, spelter is steady and quiet.

COPPER

Prices of electrolytic in New York, in cents per pound.

| Date | 28.00 | Mch. 8 | Average week ending |
|------------------|-------|-------------|---------------------|
| Apr. 12..... | 28.00 | " 14..... | 26.62 |
| " 13..... | 28.00 | " 21..... | 26.50 |
| " 14..... | 28.25 | " 28..... | 26.18 |
| " 15..... | 28.25 | Apr. 4..... | 26.79 |
| " 16 Sunday..... | 28.50 | " 11..... | 26.87 |
| " 17..... | 28.50 | " 18..... | 27.50 |
| " 18..... | 28.50 | | 28.25 |

Monthly averages.

| | 1914. | 1915. | 1916. | | 1914. | 1915. | 1916. |
|-----------|-------|-------|-------|------------|-------|-------|-------|
| Jan. | 14.21 | 13.60 | 24.30 | July | 12.26 | 19.09 | |
| Feb. | 14.46 | 14.28 | 25.62 | Aug. | 12.34 | 17.27 | |
| Mch. | 14.11 | 14.80 | 26.65 | Sept. | 12.02 | 17.69 | |
| Apr. | 14.19 | 16.54 | | Oct. | 11.10 | 17.90 | |
| May | 13.97 | 18.71 | | Nov. | 11.75 | 18.88 | |
| June | 13.60 | 19.75 | | Dec. | 12.75 | 20.67 | |

Bradley produced 17,996,000 lb. in March, nearly 1,000,000 lb. above the previous record.

Calumet & Hecla is to supply Germany with 3,000,000 lb. per month at 27.28 and 29% the metal to be stored in New York until the end of the war.

SILVER

Below are given the average New York quotations, in cents per ounce, of fine silver.

| Date | Average week ending |
|------------------|---------------------|
| Apr. 12..... | 62.77 |
| " 13..... | 63.00 |
| " 14..... | 63.21 |
| " 15..... | 63.77 |
| " 16 Sunday..... | 64.00 |
| " 17..... | 63.75 |
| " 18..... | 63.75 |

Monthly averages.

| | 1914. | 1915. | 1916. | | 1914. | 1915. | 1916. |
|-----------|-------|-------|-------|------------|-------|-------|-------|
| Jan. | 57.58 | 48.55 | 56.75 | July | 54.90 | 47.52 | |
| Feb. | 57.53 | 48.45 | 56.74 | Aug. | 54.35 | 47.11 | |
| Mch. | 58.61 | 50.61 | 57.59 | Sept. | 53.75 | 48.77 | |
| Apr. | 58.52 | 50.25 | | Oct. | 51.12 | 49.40 | |
| May | 58.21 | 49.87 | | Nov. | 48.12 | 51.88 | |
| June | 56.43 | 49.03 | | Dec. | 49.27 | 55.34 | |

The closeness of the China exchange to parity, the absence of free selling from the United States, the mintage by Japan on account of Russia, and the extension of the area in which the Indian rupee has to do duty, namely Mesopotamia, Egypt, and East Africa, as well as the re-adjustment of currency in India itself, create a feeling of confidence as to the future of the silver market, according to Samuel Montagu & Co. of London.

Last week the Nipissing shipped 269,399 oz. to London. On April 20 the Nipissing pays a dividend of \$400,000, making \$14,040,000 to date. The company has \$311,917 bullion on hand, also \$533,597 ore and bullion.

Silver produced by the A. S. & R. Co. in 1915 was valued at \$38,097,727, there being 76,117,453 oz. refined. The U. S. S. R. & M. Co. produced 12,218,216 ounces.

LEAD

Lead is quoted in cents per pound, New York delivery.

| Date | Average week ending |
|------------------|---------------------|
| Apr. 12..... | 7.75 |
| " 13..... | 7.75 |
| " 14..... | 7.75 |
| " 15..... | 7.75 |
| " 16 Sunday..... | 7.75 |
| " 17..... | 7.75 |
| " 18..... | 7.75 |

Monthly averages.

| | 1914. | 1915. | 1916. | | 1914. | 1915. | 1916. |
|-----------|-------|-------|-------|------------|-------|-------|-------|
| Jan. | 4.11 | 3.73 | 5.95 | July | 3.80 | 5.59 | |
| Feb. | 4.02 | 3.83 | 6.23 | Aug. | 3.86 | 4.67 | |
| Mch. | 3.91 | 4.04 | 7.26 | Sept. | 3.82 | 4.62 | |
| Apr. | 3.86 | 4.21 | | Oct. | 3.60 | 4.62 | |
| May | 3.90 | 4.24 | | Nov. | 3.68 | 5.15 | |
| June | 3.90 | 5.75 | | Dec. | 3.80 | 5.34 | |

QUICKSILVER

The primary market for quicksilver is San Francisco, California being the largest producer. The price is fixed in the open market, according to quantity. Prices, in dollars per flask of 75 pounds:

Week ending

| Date | Apr. 4 |
|--------------|--------|
| Mch. 21..... | 120 |
| " 25..... | 152 |
| " 18..... | 136 |

Monthly averages.

| | 1914. | 1915. | 1916. | | 1914. | 1915. | 1916. |
|-----------|-------|-------|--------|------------|-------|--------|-------|
| Jan. | 39.25 | 51.90 | 222.00 | July | 37.50 | 95.00 | |
| Feb. | 39.00 | 60.00 | 295.00 | Aug. | 80.00 | 93.75 | |
| Mch. | 39.00 | 78.00 | 219.00 | Sept. | 76.25 | 91.00 | |
| Apr. | 38.90 | 77.50 | | Oct. | 53.00 | 92.90 | |
| May | 39.00 | 75.00 | | Nov. | 55.00 | 101.50 | |
| June | 38.60 | 90.00 | | Dec. | 53.10 | 123.00 | |

ZINC

Zinc is quoted as spelter, standard Western brands, New York delivery, in cents per pound.

| Date | Average week ending |
|------------------|---------------------|
| Apr. 12..... | 19.00 |
| " 13..... | 19.25 |
| " 14..... | 19.25 |
| " 15..... | 19.25 |
| " 16 Sunday..... | 19.25 |
| " 17..... | 19.25 |
| " 18..... | 19.25 |

Monthly averages.

| | 1914. | 1915. | 1916. | | 1914. | 1915. | 1916. |
|-----------|-------|-------|-------|------------|-------|-------|-------|
| Jan. | 5.14 | 6.30 | 18.21 | July | 4.75 | 20.54 | |
| Feb. | 5.22 | 9.65 | 19.99 | Aug. | 4.75 | 14.17 | |
| Mch. | 5.12 | 8.40 | 18.40 | Sept. | 5.16 | 14.14 | |
| Apr. | 4.98 | 9.78 | | Oct. | 4.75 | 14.05 | |
| May | 4.91 | 17.03 | | Nov. | 5.01 | 17.20 | |
| June | 4.84 | 22.29 | | Dec. | 5.40 | 16.75 | |

The American Zinc, Lead & Smelting Co. reports a profit of \$5,293,878 in 1915, against \$77,692 in 1914.—The Lanyon-Starr Smelting Co.'s profits last year were \$373,641. The plant is at Bartlesville, Oklahoma.

TIN

Prices in New York, in cents per pound.

| | 1914. | 1915. | 1916. | | 1914. | 1915. | 1916. |
|-----------|-------|-------|-------|------------|-------|-------|-------|
| Jan. | 37.85 | 34.40 | 41.76 | July | 31.60 | 37.38 | |
| Feb. | 39.76 | 37.23 | 42.60 | Aug. | 50.20 | 34.37 | |
| Mch. | 38.10 | 48.76 | 50.50 | Sept. | 33.10 | 33.12 | |
| Apr. | 36.10 | 48.25 | | Oct. | 30.40 | 33.00 | |
| May | 33.29 | 39.28 | | Nov. | 33.51 | 39.50 | |
| June | 30.72 | 40.26 | | Dec. | 33.60 | 38.71 | |

Eastern Metal Market

New York, April 12.

The past few days brought a renewal of the record buying by the British and French governments, and it is now estimated that 200,000,000 to 250,000,000 lb. of copper has been taken for delivery over the balance of this year and early part of 1917. As was expected, domestic consumers got in line, and also bought heavily. Prices advanced under the stimulus, and 28c., full terms, is quoted for July and August delivery of electrolytic. Lake is held at about 29c., future delivery, although some of its producers are out of the market. Zinc is on the upward trend as a result of moderate but steady buying. Lead is weaker, the 8c. level having been broken; and it is apparent that domestic consumers are holding off for cheaper metal. Tin is higher, following a rather active week. Antimony is lower as a result of there being larger supplies in sight. Aluminum is unchanged, and its quotations are nominal.

The prices of most steel products appear to have reached their crest, but pig-iron is showing additional strength. Buying is less feverish in many directions. The steel mills are filled with orders for months to come, and most of them will welcome an opportunity to shorten their deliveries. The demand for metal-working machinery is good, although the orders are not large individually. They are of a healthy character, however, coming as they do from scattered sources. Buyers of machine-tools are no longer buying without giving proper consideration to their needs, and they show a willingness to wait, if needs be, to get the tool best fitted to their necessities. In short, the great rush of buying equipment for manufacturing war supplies is now well past.

COPPER

Following the tremendous buying of early last week there came a lull, although the market was by no means at a standstill, and prices continued firm. On Monday of this week buying for export started again with a rush, and the demand has been so great that quotations were advanced on all sides though not uniformly. Yesterday (March 11) at the end of the second day of the second big movement electrolytic could not be obtained for July and August delivery under 28c., 30 days, delivered, or 27.87½c., cash, while May and June was quoted at 28.75 to 29c. What prompt deliveries would bring is problematical. Lake, on which early delivery cannot be had, is quoted at 29c. Estimates place the amount of copper taken by Great Britain and France in the past few days at 200,000,000 to 250,000,000 lb., and the end is not yet, for buying in behalf of Russia and Italy is expected. As was to be expected, the heavy foreign buying roused domestic consumers to activity, and they have taken large quantities also. The big export orders are reported to have been divided among the A. S. & R., Calumet & Hecla, and United Metals Selling companies. While no authorized statement has been made concerning the prices paid, they are understood to have been under the current market, in view of their exceptional character. The London market became easier late last week, dropping to £134. As will be remembered the London electrolytic price stood at £136 for weeks. Exports up to, and including April 11, totaled 7017 tons. New England consumers of copper and other metals are still in a bad way because of the freight congestion in that territory. Many of the smaller metal-working plants there have shut-down for want of material. Relief for some points is promised after April 14, as on midnight of that day the embargo, export excepted, will be partly raised. The embargo will remain in force, however, against Naugatuck, Waterbury, Waterville, Torrington, Bristol, New Britain, and Hartford, all great metal-consuming centres. The Remington Arms &

Ammunition Co., at Bridgeport, and the Winchester Repeating Arms Co., at New Haven, have partly solved their freight difficulties by establishing their own steamboat lines across Long Island sound, thereby gaining access to the line of the Long Island railroad, which connects with those of the Pennsylvania and other lines. The Calumet & Hecla recently shipped 50,000 lb. of copper to the East by express.

ZINC

The market has been moderately active, although a good part of the buying is said to have been on the part of dealers who anticipate a stronger market. The brass mills have been the chief buyers. Although the galvanizers are known to be insufficiently covered they are unwilling to buy at present prices, but some of them will be forced into the market in the near future. Prompt and April spelter was quoted yesterday at about 19c., New York, and 18.75c., St. Louis. May delivery is quoted at 18c., New York; June, 17.75c., St. Louis; and third quarter at 16.25 to 16.50c., St. Louis. It will be observed that prices have advanced in the past week. Business should become more active in view of the heavy buying of copper, and the better freight conditions in New England. Sheet zinc is unchanged at 25c., carload lots, f.o.b. mill, 8% discount for cash. The London quotation for spot zinc, April 11, was £98. Exports of spelter, April 1 to 11, totaled 1015 tons.

LEAD

This metal has been dull throughout the past week. The export demand has tapered off, and domestic consumers are inclined to wait for lower prices. They are carrying stocks as small as they dare. The A. S. & R. Co. continues to quote 7.50c., New York, and 7.42½c., St. Louis, but this price only serves to establish the average at which the company sells to those with whom it has contracts. Some of the independents, who perhaps are not over-anxious to sell because of their sold-up condition, have adhered to 8c., both at New York and St. Louis, while others have dropped under the 8c. level. It is reported that down to 7.75c., New York, could be done, but it is said that lead at this price is difficult to find. The average of prices, as quoted by the independents is 7.87½c., New York or St. Louis. Some large foreign inquiries have been before the trade in the past week, but they have not resulted in business. On one of these 8.25c. was quoted, and it is intimated that the producers are more anxious for domestic business than they are for foreign. Exports in the first 11 days of this month totaled only 155 tons. The London quotation on the 11th was £34 5s.

TIN

Tin is higher than it was a week ago; the quotation for spot yesterday (the 11th) was 53c., but on the 5th it was up to 55c. A large business has been done in the past few days, principally in tin afloat and futures, one buyer taking 300 tons, April 7. Tin in London continues an uncertain quantity because of the possibility of shipping licenses being refused. Metal actually afloat therefore commands a premium, as it is certain of delivery unless the ship sinks. Yesterday and today the market has been dull, and some pressure to sell prompt is developing. Up to yesterday 675 tons had arrived this month, and there was afloat 5389 tons. The A. S. & R. Co. has received additional shipments of Bolivian tin concentrate.

ANTIMONY

Prompt Chinese and Japanese antimony is easier at 42.50 to 43c., because of the larger supplies near at hand, though it is admitted that it is difficult for the dealers to actually get some of this metal into their possession.

COMPANY REPORTS

OLD DOMINION COPPER MINING & SMELTING CO. UNITED GLOBE MINES CO. OLD DOMINION CO.

These three companies must be considered together, as the first two are operating companies controlled by the Old Dominion Co. Work is done at Globe, Arizona, and the reports are for 1915.

At the Old Dominion mine the west side orebodies produced 75% of the smelting ore, No. 11 level contributing one-third. At No. 17 and 18 the lode is 35 and 40 ft. wide, respectively, all concentrating ore. Encouraging results were reported from the east side orebodies. Development totaled 14,311 ft., a decrease of 1321 ft. Mining cost \$5.51, an increase of 31c. per ton. Abnormal rain resulted in as much as 13,000,000 gal. per day being pumped in February. In March more water broke through the dacite capping above No. 12 level, resulting in



OLD DOMINION MINE, MILL, AND SMELTER.

No. 18 and 16 levels being flooded, and mining suspended for five weeks. All this made extra work and costs. A total of 2,769,400,000 gal. was pumped, compared with 1,349,210,000 in 1914. Of this, 730,000,000 gal. was sold to the Miami Copper Co. The minimum flow was 5,360,147 gal. on October 28, and maximum 11,492,923 gal. on March 26. I. H. Barkdoll is mine superintendent.

The mill treated 173,046 tons of 1.34% ore, 119,480 of which was custom ore, mostly from the United Globe mine, at a cost of \$1.215 per ton, an increase of 28.2c. The recovery was 85.27%, an increase of 12.72%. Oil flotation gave good results.

The smelter reduced 296,549 tons of charge, almost the same as in 1914, at \$2.755 per ton. The converters yielded 27,736,158 lb. fine copper, at a cost of \$5.36 per ton of metal, a decrease of 29c. After 39 months, making 70,860,000 lb. of copper bullion, the converter was removed for repairs, a remarkable record.

Old Dominion metals, namely, 13,771,681 lb. copper, 40,633 oz. silver, and 621 oz. gold realized \$2,595,131. Profit in treating custom ore, etc., was \$259,415, making a total of \$2,854,546. The net profit was \$1,337,986, plus \$967,293, balance from 1914, a total of \$2,304,279. Dividends absorbed \$810,000, and depreciation, \$767,375, leaving a surplus of \$726,852 for 1916. The total cost per pound of fine copper was 8.9 cents.

In the United Globe, development amounted to 9011 ft. The orebody between No. 10 and 12 levels opened splendidly, with a maximum width of 45 ft. The Kingdon shaft was sunk to No. 16 level from the 14th. It is to be completely equipped in 1916, to allow all Old Dominion and United Globe ore to be hoisted in case of trouble at the A shaft. Several dumps were cleaned up during the year. Smelting oxide and sulphide and concentrating ores shipped to the Old Dominion plants totaled

141,240 tons, averaging 4.08% copper. The yield was 11,536,021 lb. copper, 105,110 oz. silver, and 1509 oz. gold. Total revenue was \$1,154,324. Adding the profit, \$812,251, to the 1914 balance, \$239,598, there was \$1,951,849 available. Dividends totaled \$621,000, and depreciation \$452,380, leaving a surplus of \$277,169 for 1916.

The Old Dominion Co.'s income from dividends, etc., in the above companies was \$1,405,296. Of this, \$1,166,765 was distributed. The 1914 balance was \$433,065, and that for 1916, \$355,696.

MARY MURPHY GOLD MINING CO.

This company operates at Romley, Chaffee county, Colorado, and the general manager, George E. Collins, reports for the past year as follows:

Development in five claims totaled 7248 ft., at a cost of \$7.22 per foot. A considerable tonnage of ore was opened, but less than sufficient to make up for that extracted. A good deal of the ore being mined at present is only rendered workable by high metal prices. Reserves of broken ore are 12,000 tons for the mill, and 100 tons for the smelter, estimated to yield \$125,000 and \$3000 net, respectively. There is enough ore for the mill for 6 to 12 months. Underground work cost \$3.21 per ton. The aerial tramways worked well, and cost 12c. per ton. The mill treated 57,810 tons at a cost of \$1.99 per ton, producing 1925 tons of lead, 1711 tons of iron-copper, and 4700 tons of zinc concentrates worth \$539,524. Bullion was worth \$614, crude ore \$61,976, and tributers' crude ore \$38,931. The total was \$640,144, against \$300,010 in 1914. Flotation of the slime was a success, and increased the quantity of zinc recovered. The ore is very complex and difficult to treat.

All costs amounted to \$5.56 per ton, an increase of 18c., due mainly to mining. The total profit from all sources was \$281,197, less \$47,121 for depreciation and \$13,660 for interest. Dividends were \$50,134. It has been decided to set aside \$110,000 for buying or developing a new property, search for which is now under way.

SENECA-SUPERIOR SILVER MINES, LIMITED

In spite of higher prices for explosives, steel, and mining supplies of all kinds, this Cobalt, Ontario, company extracted silver at 23.45c. per oz., in 1915, a reduction of 7.08c. To do this, exploration (1152 ft.) was curtailed, and broken ore in stopes was sent to the mill. Development did not disclose any new orebodies. Fifteen feet below the collar the winze below the fourth level entered the Keewatin formation. Ore continued in this for 45 ft. The shoot below No. 5 is short and low grade.

The manager, R. H. Lyman, states that the mill treated 25,194 tons. Concentrate shipped was 1014 tons. The production from all sources was 2,047,150 oz. silver, making 5,001,870 oz. to date.

The silver sold at 51.29c. per oz., a decrease of 1.93c. The profit was \$569,991. Six dividends amounted to \$235,219. The balance for 1916 was \$306,586, against \$71,814 carried forward to 1915.

AMERICAN TELEPHONE & TELEGRAPH CO.

A recent writer said that Americans show their appreciation of the telephone and automobile by wanting these appliances to annihilate space, as it were. The report of this great company for 1915 proves what an enormous business is done by wire. At the end of 1915 there were 9,151,221 stations, an increase of 502,228, using 18,505,545 miles of wire. Of this length, 93% is copper wire. There is 10,536,837 miles underground, costing with conduits, \$295,700,000. The gross revenue of the 'Bell' system, including the A. T. & T. Co., was \$239,909,649, a gain of \$13,957,526. After paying everything, including interest, the net result was \$48,056,114, of which \$32,897,065 was paid in dividends. Mines and metal producers should be interested in these notes.

MINING DECISIONS

OIL-PLACER—VALIDITY

A placer-oil location made in good faith by an association of persons who subsequently formed themselves into a corporation for the purpose of developing the property, each owning stock in the corporation, to which the location is conveyed, in proportion to his interest in the claim, is not invalid, there being no evidence that such location was made in the interest of and with a view to enabling the corporation to acquire a greater area of mineral ground than may lawfully be embraced in a single location by a corporation.

McKittrick Oil Co. (Land Department), 44 Land Decisions, 340. August 30, 1915.

AGREEMENT TO LEASE—SAME EFFECT AS A LEASE

Where an agreement to lease for a valuable consideration all the iron ore under certain lands provided for the payment of royalties on minimum ore shipments, and thereafter the lessee entered into possession and expended about \$70,000 in development of the property, the agreement was held to have become a valid-executory contract, notwithstanding the fact that it was in form an agreement to lease rather than an executed lease. The lessee was held liable for the minimum royalties due and for those which should thereafter become due, and could not be relieved from such liability by an assignment of his interest (without the lessor's assent) to a third party.

Hairston v. Hill (Virginia), 87 Southeastern, 573. January 13, 1916.

MINING LEASE—SURFACE RIGHTS ADJUSTED

Where the manager of a mining corporation who knew that his principal, the lessee, had modified the contract with the lessor as to the taking of timber from the surface of the ground, continued in the service of the assignee of the lessee, the assignee was charged with said manager's knowledge of the existence and terms of the original agreement. Said assignee, although entitled under the lease to the use of surface ground upon which to build houses for its employees, may not use the portions of the land devoted to agricultural purposes by the lessor where there is other ground available for building sites. On the other hand, the lessor is prohibited from polluting a stream which supplies water for the boilers used in the lessee's mining operations.

Blue Grass Coal Corporation v. Combs (Kentucky), 182 Southwestern, 207. February 11, 1916.

OIL LANDS WITHIN WITHDRAWAL—NOT TO BE PATENTED.

No title is acquired under or by virtue of a school indemnity selection until the same has been approved by the Secretary of the Interior, and where the selected lands are classified as petroleum in character, withdrawn and placed within a petroleum reserve, the Secretary is without authority to approve the selection for unconditional patent, nor will the State's grantee in such event be protected as a "person who has in good faith located, selected, entered, or purchased * * * under the non-mineral land laws of the United States, any lands which are subsequently withdrawn, etc." as provided in Section 3 of the Act of July 17, 1914, because the land under consideration was in a Naval Petroleum Reserve and hence dedicated to a public use.

State of California *et al.* (Land Department), 44 Land Decisions, 127. June 23, 1915.

NOTE: The same rule was applied even after proof of character, payment of purchase money, and issuance of receipt in Thomas J. Stockley, 44 Land Decisions, 178. July 9, 1915.

QUESTION: A and B are two claims in Alaska that were incorporated; stock was sold and work was done on them before March 1913. Subsequently the claim C was located, and since then the work has been concentrated on the new claim, namely C, to the neglect of both A and B. Are these two claims subject to re-location; also, what becomes of any improvements that were left on A and B?

ANSWER: We assume that what our correspondent means by the statement that the "claims were incorporated" is that a corporation was formed which took over the ownership of the claims. We assume that the claim C was also located by or in the interest of the corporation. Under such circumstances all of the \$300 worth of annual labor can be performed on the claim C, provided such work satisfies the requirement that it shall result in an actual benefit to the other claims. Whether group

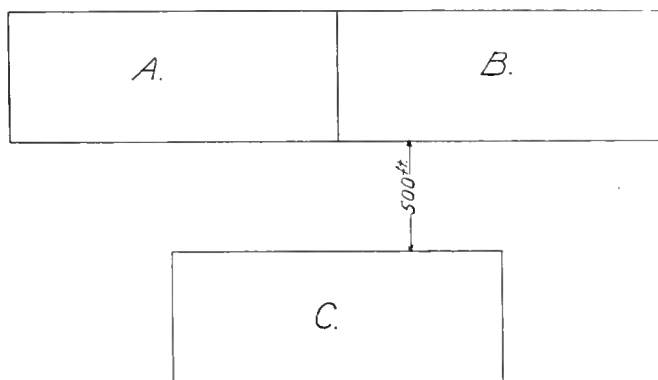

work of this character performed on one claim will satisfy this requirement is always a question of fact. In the diagram submitted by our correspondent, claim C is separated by some intervening distance from the other claims. In jurisdictions like California where the condemnation of private rights of way for mining purposes is not permissible, the objection might be made that work on claim C would not benefit claims A and B because of this intervening space, which might be controlled by a third party who could then prevent any workings from C from being driven across into claims A and B. Frequently the rule is stated that the claim upon which group-work is performed must be one of a contiguous group. The reason for this rule would cease to exist, however, in these jurisdictions where a private right of way for mining can be condemned or where a right of way was secured by contract, etc. If claims A and B were actually abandoned or forfeited the improvements situated thereon would revert to the public domain as a part of the claims themselves, and would become the property of a re-locator. There may be exceptions to this rule arising out of the peculiar circumstances of the case. In the absence of such exceptional circumstances the general rule would apply.

If an applicant for mineral patent withdraws his application because of a protest, any subsequent application filed by him for the same land must be considered in the light of the previous testimony.

BOOK REVIEWS

WEB OF STEEL. By Cyrus Townsend Brady and Cyrus Townsend Brady, Jr. P. 336. Illustrated. Fleming H. Revell Co., New York, 1916. Price, \$1.25.

After we had started to read this book, we stayed up late in order to finish it. The tale is absorbing. If the book was meant to interest and excite, it is an unquestioned success. But it does more, it exemplifies the value of accuracy (that is, science) in the work of the engineer. The first half of the story hinges upon the building of a big cantilever bridge, which falls at the last moment owing to an error of calculation in the design. The main strut, 60 ft. long, proved too weak to carry the stress. The bridge collapsed, killing 150 men at work upon it. The hero, a young man who had criticized the work of the chief engineer, his father, and had yielded to his senior's superior judgment, insists on taking the blame for the blunder; he sacrifices himself out of love for his father and the father's reputation. By assuming the blame he loses the chance of marrying the heroine, who is the bridge-building company's president's daughter. So we have a love tale intermeshed with the web of steel. In the second half of the book a dam is being built in Arizona and again engineering ideas come into play; this time in such a manner as to restore the hero to honor and to his beloved. It is well done. One feature of the book is particularly commendable: drawings and diagrams explaining the engineering details, making them intelligible to the non-technical and all the more convincing to the technical. In short, it is a book that an engineer will enjoy. The authors have achieved their purpose.—T. A. R.

METALLURGISTS' AND CHEMISTS' HANDBOOK. (4 by 7 inches.) Compiled by Donald M. Liddell. P. 603. Ill. index. McGraw-Hill Book Co., Inc., New York, 1916. For sale by the MINING AND SCIENTIFIC PRESS. Price, \$1.

The author of this excellent volume will be remembered from his connection with, and the number of instructive articles he wrote for the *Engineering and Mining Journal*. A cursory glance at the book at once tells the student that it is worth while. Much of the data and many tables are not exactly new, but they have been corrected as far as new values were obtainable. The first section of 52 pages, entitled 'Mathematics,' covers far more tables than usually found in similar works. Metallurgical price and production statistics cover the past 10 years in the important metals (although those for 1915 are not given), also the output and consumption of these. Physical constants occupy 158 pages, dealing with laws of physics, temperature, specific gravity, evaporation, power transmission, hardness of materials, the principal concentrating ores and gangues, gases, and inorganic compounds. Seventy pages are devoted to chemical data, such as laws, the periodic table, atomic weights, brief notes on the common metals and metalloids, detection of the metals (field tests), acids, heat of formation carbonates, sulphides, etc., and the electro-chemical order of the elements. The author is on his special ground when considering sampling, assaying, and analysis. Metallurgists will turn to ore-dressing and cyanidation, and will find more on flotation than on cyanidation, showing the trend of events. The processes and flotation oils are briefly discussed. In the 64 pages on ore-dressing, all types of crushing, grinding, and concentrating machines are described. Coals and oils and refractory materials form a useful chapter. The mechanical engineering and construction section is replete with practical hints, including belt-conveyors, pipe-fittings, rope-knots, and cost of constructing plants. General metallurgy, 108 pages, is simply crowded with notes on every subject coming under this head. First-aid and a good index complete a valuable compilation.

INDUSTRIAL NOTES

Mine-Locomotive Head-Lights

In large well-equipped mines electric locomotives are frequently used for gathering and long hauls. A strong head-light is of great importance for the motor man, and is a warning to miners who get on the track. The new compensation acts make it to the mine operator's advantage to have such illumination. A thorough investigation of mine lighting, including head-lights, has been undertaken by the General Electric Co., resulting in the design of a complete series of loco head-lights. A recent circular on the subject, by P. S.

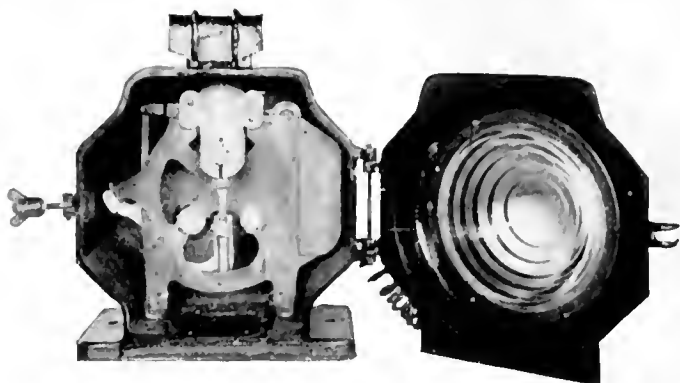

INTERIOR VIEW OF HEAD-LIGHT.

Bailey, is replete with descriptions, photos, and charts, and is of considerable interest. The accompanying photo will give an idea of the manner in which the frame and mechanism of the head-lights are positioned in the casing; the elements of the electrode, link, and lever mechanism being in view, while the magnet is mounted in the rear of the magnetic shield which prevents any deterrent magnetic influence caused by stray flux from the magnet, from interfering with the operation of the arc. The lower electrode consists of a hollow cylinder of sheet-iron rolled up and welded, plugged at one end and filled with a mixture of certain oxides which produce the highly luminous arc. The tube when filled is capped with a metal-disk, and the edges spun over to hold same in position. When the arc is struck the disc burns away rapidly, and the electrode is self-sealing.

PEARSON, PEPPARD & Co. have opened offices in the Woolworth building, New York, to conduct a general business in brass and copper rolling-mill products, steel, and steel products. Both members of the firm have been closely associated with the metal business for several years, in mill products and virgin metals, such as tin, copper, lead, spelter, antimony, aluminium, etc.

Six switching locomotives made by the American Locomotive Co., thirty-six 20-yard all steel automatic-range type Kilbourne & Jacobs dump-cars, and three Osgood special 105-ton shovels are being supplied the Calumet & Arizona Mining Co. by NORMAN B. LIVERMORE & Co. of San Francisco.

To 'brighten' oxidized gold which will not amalgamate on its dredges, the Natomas company installed a 4½-ft. HARDINGE MILL on No. 7 dredge. Results are entirely satisfactory, and six more mills are to be installed on some of the other boats of the company.

The ROESSLER & HASSLACHER CHEMICAL Co. announces that its peroxide of sodium plant at Niagara Falls was burned early in March, and deliveries will be made again by May 1.



EDITORIAL



T. A. RICKARD, *Editor*

WHEN his neighbor's house was burning, he began to think of insurance. Even then some of his friends told him not to be in a hurry, so he started a conversation on the subject, regardless of the sparks that were flying overhead in the gathering gloom. Gentlemen, preparedness is already belated.

CONTINUOUS decantation as applied to cyanidation in the Comacaran mill, in Salvador, is described by Mr. A. B. Peckham in this issue. The article has the merit, among others, of stating frankly both the bad and the good points of this practice, and it can be read therefore with confidence.

ELECTROLYTIC precipitation is a subject of which much is yet to be learned. To that end we are glad to publish an account of the experience obtained at the Minas Prietas mines in Mexico, by Mr. P. H. Crawford, supplementing the information given by Mr. G. H. Clevenger in the comprehensive article appearing in our issue of November 13, 1915.

REFERRING to the Cottonwood and American Fork mining districts in Utah, where an insistent demand has arisen for an investigation by the U. S. Geological Survey, as mentioned in our issue of the 15th instant, we note that the Director, Mr. George Otis Smith, has responded favorably, promising to undertake the work just as soon as the Sundry Civil Appropriation bill has been passed by Congress.

NEW DECREES affecting mining are announced from Mexico City, the Carranza government having issued regulations meant to discourage large holdings of undeveloped claims by imposing a prohibitive tax; but until we know for certain who is to govern Mexico, it is not necessary to inquire closely into such attempts to regulate mining operations. At the present time there is as much doubt as to who will collect the taxes a month hence as there is regarding their incidence.

ZINC smelting in Great Britain has received some measure of Government support at last, the Munitions Department having arranged with the smelting companies to deduct from their excess profit, before taxation, the difference between cost of new construction during the War and before; also a "reward" is to be given for extending their plant, in the form of an allowance of 50% on such cost of construction to be deducted from excess profit before taxation. This is not likely to induce the erection of any large new zinc-smelting works,

but it will cause several of the existing small smelters to enlarge their capacity. We note also that all the Broken Hill companies, except the Sulphide Corporation and the British Broken Hill Proprietary, have signed a 50-year contract with the Associated Smelters for the smelting, refining, and realization of all their zinc and lead concentrates. These arrangements will have their effect on the spelter market in due course.

ON April 12 a great Cornishman passed away: Joseph Henry Collins. He died at the fine old age of 74, with his faculties fully alert and with his harness on. One of the pioneers of technical education in Cornwall, an eager student of the sciences applied to mining, a keen observer, and a consistent exponent of the best Cornish traditions, his leaving makes a big void. Some snob said that Robert Boyle was the father of modern chemistry and the nephew of the Earl of Cork; J. H. Collins was the grandfather of technology in Cornwall and the father of four good mining engineers.

COST of living has been rising steadily since September, the increase since then being equal to 18%. The average price of the principal commodities at the present time is the highest on record. At a period when thrift is desirable and sober thought an obvious necessity, New York is the scene of an orgy of dissipation and extravagance worthy of a drunken sailor. The War has given excess of wealth to a lot of ignorant people and furnished them with the opportunity to disgrace this democracy. Whatever we may think about the rights and wrongs of the great contest in Europe, we may well be sobered by the hearing of so much horror and the sight of so much pain among the civilized peoples from which we, all of us, have originated.

APPARENTLY the organization of a group of New York capitalists, under the name of the American Rand Syndicate, to acquire property on the Witwatersrand meets with cordial approval in London. Mr. Isaac Lewis, of Lewis & Marks, is felicitated on his success in getting the firm of Adolph Lewisohn & Sons to head the new departure. Complimentary remarks are made concerning Mr. W. W. Mein and his coadjutors, now on the ground and commencing their examination. The property to be investigated first is the Grootylei, belonging to the Grootylei Proprietary Mines, having 361,850 shares issued, of which 253,020 are held by the East Rand Mining Estates. The property adjoins the Geduld, Springs Mines, and Daggafontein. Indeed, it is just east of the most promising part of the Rand, known as

the Far East, and containing such famous mines as the Modderfontein and Brakpan. The Grootvlei is a big property, covering 1135 claims or about 1700 acres. The ground has been prospected in a preliminary way, by bore-holes, the Van Ryn reef having been cut at 3340 and 4040 feet on the western boundary and at 2500 feet vertically on the east side. Two shafts were started in 1909, but they were abandoned at depths of 55 and 378 feet, respectively, owing to an inrush of water. The Union Government owns about 80,000 claims in the same locality, so that there is ample scope for prospecting and for new ventures. However, the men who have taken the matter in hand are no tenderfeet and the engineers acting for them are familiar with local conditions, so we expect to see the business tackled on a workmanlike basis.

IN this issue, Mr. Corey C. Brayton has contributed an excellent paper on prospecting and dredging near Nome, a record of recent experience in that sub-Arctic region. In particular he discusses types of machines adapted to the local conditions, which differ widely from those obtaining in regions nearer home. He makes it clear that dredging on the Seward Peninsula is conducted on small rich areas of loose gravel that will last a 2½-ft. bucket-dredge from 12 to 18 months of working time, while the season for productive operations is only four months. Disregard of basic facts explains the failure of several dredges on the coastal plain behind Nome. As to the cost of labor and freight, he says with much truth that "the difficulties of operating in Alaska in general and on Seward Peninsula in particular are always magnified; difficulties mean high cost but not necessarily prohibitive cost." The account of the development and operation of the light prospecting-drill and the flume-dredge are particularly timely, having regard to the near approach of another season.

DISCUSSION this week exhibits its customary variety of interest. Flotation is to the fore in the shape of a contribution by Mr. O. C. Ralston, who continues the useful analysis of the basic principles of the process as outlined by Mr. C. T. Durell and himself. Such scientific controversy, with its free give and take, constructive criticism and friendly comment, is of the greatest usefulness in clarifying ideas and removing misconceptions before advancing to new developments. Messrs. Durell and Ralston furnish a good example of criticism that can be penetrating yet polite. In another part of this issue we give a short article by Mr. L. A. Delano describing flotation practice on the lead ores of south-eastern Missouri. The working details should prove suggestive to other operators. The second contribution to discussion refers to the platinum deposit at Boss Springs, Nevada. This is written by Mr. Adolph Knopf, who wrote the excellent geologic diagnosis published by the U. S. Geological Survey, abstracted in our issue of June 5. Our recent editorial on 'Mine Accident Insurance' elicited a rejoinder from Mr. Will J. French, representing the State Commission; now we are enabled to

present the other side of the controversy as it appears to the California Metal Producers Association, of which a distinguished engineer, Mr. Albert Burch, is president.

MEN of the 'blue and gold' all over the world will be glad to learn that Mr. Frank H. Probert has been appointed the Professor of Mining in the University of California. The profession generally will approve the selection. It is known that since the death of Professor Christy, in December 1911, the chair of mining has not been filled, save by temporary appointees, and it is fair to say that the authorities found it difficult to make a satisfactory selection. Mr. Probert was not among the applicants nor among those suggested for the appointment last year. In February he delivered a short course of lectures and made so favorable an impression that it led to his being considered as a professorial possibility. Enquiry into his career proved a decisive factor. For those who are not informed on the matter and who will be interested, more particularly the alumni of the University, we may state that Mr. Probert is an Englishman by birth, he will be 40 in a few weeks, he had a distinguished scholastic record, winning several scholarships at the St. Olave's Grammar School and at the Royal College of Science. In 1897 he graduated from the Royal School of Mines, London. Since then he has had an interesting and successful professional career as manager of mines and mining geologist, in Canada, Germany, Spain, and in this country. In 1901 he came to the United States, on the suggestion of Mr. James Douglas, to conduct research in the hydro-metallurgy of copper ores at Morenci, Arizona. In later years he has been doing the work of a consulting mining engineer in the West, notably Arizona and Montana. His numerous contributions to technical literature indicate the ability to explain and expound. During the last few months we have had the pleasure of publishing more than one of his writings, and at an early date we shall give our readers a series of articles by him on the surficial indications of copper, the subject on which he lectured recently at both of the Californian universities, at Berkeley and Palo Alto.

DREDGING on a large scale is to be introduced on the property of the Lena Goldfields in the Bodaibo district of Siberia. This will be done on the advice of Mr. W. E. Thorne, endorsed by Mr. C. W. Purington. The selection and designing of the dredges has been delegated to Mr. Henry M. Payne. During the year 1914-1915 the output consisted of 902,459 cubic yards of gravel yielding gold to the value of £1,782,886, or \$8,647,000, at the normal rate of exchange, indicating an average of \$9.58 per yard. The cost is not given, for the actual operations are in the hands of a Russian company, the Lenskoie, the officials of which are not always on the best of terms with the engineers sent out from London or America. In the 1912-1913 report the cost is given as 29s 7d., or \$7. per cubic yard, but even that was not official. Mr. Purington estimates the present cost at 25s.8d., equivalent to \$6.40 per yard. The mining is done by drifting; the figure of cost renders comment

superfluous. Indeed, the technical work done in connection with this important gold enterprise has been pitifully bad, owing largely to conflict between the London directorate and the Russian management. The Consolidated Gold Fields of South Africa holds the controlling interest in the Lena Goldfields, which in turn has a majority of the shares in the Lenskoie company. Mr. Purington estimates the reserve of gravel in October last as 1,821,000 yards averaging 22s.2d. per yard and containing £2,023,550 in gold. Part of this ground can be hydraulicked, part dredged, and the remainder drifted. He gives 180 to 200 days as the possible dredging season, but if the methods in vogue at Dawson are adopted, it will be possible to extend the period of profitable activity far beyond this expectation. Incidentally, an interesting competition has arisen between the Pontiloff works, at Petrograd, and American manufacturers. The former is asking a price of \$500,000 as against an American quotation of \$425,000 for a dredge complete. It might be supposed that the domestic foundry would have much the advantage in bidding for the order, but it is a fact that the freight from Petrograd to Irkutsk is more than it is from Ohio or California to Irkutsk, the distributing point for the Lena region. The scarcity of manganese-steel may compel the use of chrome-steel in the manufacture of the buckets, using manganese-steel for the lips only.

Flotation Litigation

We referred to this subject in our issues of December 18 and January 29. Since then we have learned that the decision in the Hyde case, now before the Supreme Court by writ of certiorari, has been postponed until next October or November. The advancement of the case was due to the fact that in January three out of the nine justices of the Supreme Court were absent from the bench by reason of illness or other causes, thus leaving only six, the smallest number that holds court. One of these six was the former Attorney-General, Mr. James C. McReynolds. If so happened that several Government cases were next upon the calendar at this time, and as Justice McReynolds could not sit as a member of the Court while the cases in which he had been attorney were being heard, it became necessary to pass all of them. This advanced the hearing of the Hyde case by about two months in the most unexpected manner. Inasmuch as both parties in that litigation found it necessary to have demonstrations performed in Court, in illustration of their arguments, it became impossible to present the case on two or three days notice. Therefore, by mutual consent of counsel representing Minerals Separation and Mr. James M. Hyde, the case was set over until the October term. As regards the Miami case, it is understood that Judge Bradford, of the District Court at Wilmington, is a painstaking man and is going through the voluminous testimony with great care, in the intervals of hearing current cases. Hence the delay. The decision may be announced any day.

Metal Prices

No apology is required for referring again to this subject, for it is one that concerns most of our readers. Discrepancies in the quotations for metals, especially copper and zinc, have caused irritation and created suspicion among those who are engaging in the mining and selling of them. In particular, we have received letters commenting upon the discordance between the official prices published by the New York Metal Exchange and those quoted in the technical press—for example, in our own columns. On careful enquiry we find that practically no metal is sold on the so-called Metal Exchange in New York, the quotations issued being largely fictitious. At rare intervals a sale is recorded as having been made on the floor of this 'exchange,' but when it happens the assumption is that the transaction is performed for some sinister purpose, as when spelter was offered by a broker, not regularly engaged in the trade, for the alleged purpose of breaking the price then prevailing—a price considered excessive in certain quarters. It is a fact that this broker was deputized to make the offering at a price lower than the outside market. Again, spelter has been sold on this so-called exchange in small lots and at low prices for the alleged purpose of obtaining a quotation that could be telegraphed to the West with a view to influencing ore-prices. Only the other day, April 5, a dealer in tin made a bid of 55c. for spot tin, receiving no acceptance, and later in the day he offered to sell at 53; the inference being, of course, that the high bid was made merely to boost the price. As regards copper, only the so-called 'standard' variety is sold on the Exchange, on those rare occasions when there is a sale. This material is of no value to the consumer of refined copper. As far as we can learn, this 'exchange' serves some purpose in the collection and distribution of sundry statistics; it is a receiving and distributing point for the daily cablegrams from London; and when united action is demanded, it serves to bring the members of the trade together and furnishes a medium for the expression of their policy. Thus the habitation and the name may be useful on occasion. This happened recently when protests were lodged with the British authorities by the tin committee of the Metal Exchange, thereby securing a modification of the drastic regulations governing dealings in tin. Years ago a good deal of real business was done on the Exchange and some of its members still cherish the hope of a revival, but it is clear that unless there is some assurance of *bona fide* prices, it were better to give the thing a first-class funeral. As now conducted, it is a sham and a snare, as is evident from the confusion it has created among mine-operators. A dealer rises and asks "What shall we make copper today," to which another so-called broker replies "I bid 26," and a third "I ask 28," whereupon the average is called the 'market.' Even this hollow mockery is enacted irregularly. The Official Daily Market Report of the New York Metal Exchange—the name is long enough to be pretentious—is a publication supposed to give the quo-

tations. We have before us the statement for the week March 28 to April 6 and note that it is an elaborate blank despite the active dealings in these metals in progress elsewhere during that period. In short, the Metal Exchange is a fake and the time has come to recognize it as such.

The daily press and many financial papers are not reliable sources of information if precise figures are required in regard to the business done. It may be enough for the general public to know that copper is at the 26c. or the 28c. level, but the actual buyer or seller deals in fractions of a cent. Furthermore, a 'pegged' price is often fixed tacitly and may be quoted long after the market has sagged. Some of the prices quoted in the daily press represent what consumers are paying for metal delivered at their own plants, while others quote for metal at the refinery dock. This corresponds to a spread of $\frac{1}{2}$ cent per pound in normal times, but now that freight is so congested around New York the difference is likely to be increased considerably. In regard to 'spot' copper, either Lake or electrolytic, it should be known that this product has been so scarce of late as to be designated a specialty in the trade. Consumers do not buy from hand to mouth; they must make their purchases sufficiently ahead to ensure the continuation of their operations, so that it is with 'futures,' near or otherwise, that the actual market is concerned in these days. Our New York correspondent has reported repeatedly that immediate shipments command premiums and that these premiums are paid by few important consumers. The business recorded recently has been mostly in June, July, and August deliveries. Sales have been put through in large volume at from 26.75 to 27.50c., yet all the time the daily press and some Wall Street papers have proclaimed 28.50 as the price of copper. It is, and it is not. The fact is that the daily press does not keep in close touch with the market; in this, as in so many other matters, it is crudely careless about accuracy. Further, it may be assumed, for the purpose of business, not philosophy, that if a newspaper or other periodical has a certain clientele it will lean toward the interest of that clientele. In the same way a broker that speculates in metals is an unreliable arbiter of prices, and metal-selling agencies in the East have to make strategic movements that disregard the welfare of individual producers of copper or zinc in the West. The subject is complicated by the interplay of a number of forces, some of them sinister. Since the beginning of the War there have been many disclosures, at Melbourne, London, and New York, indicating that the owners and operators of mines are sitting in a game not conducted according to the rules of clean business, the essence of which is that it is mutually profitable. Again we suggest that one of our professional organizations, the American Institute of Mining Engineers or the Mining and Metallurgical Society of America, should appoint a committee of investigation to enquire into the whole question of metal buying and selling. No subject is of more immediate importance to the mining industry.

Mining Engineers and War

Directors of British mining companies have been requested by the Institution of Mining and Metallurgy to keep in mind the engineers who are serving in the War, so that they may be afforded every facility of return to their former employment when peace is assured. Seven hundred members of the Institution are on active service with the British army and already 30 have given their lives while doing their duty. Of course, mining engineers and metallurgists are serving their country with equal devotion under other flags, but we may be pardoned for taking a special interest in those whom so many of us in the West have known in this and other countries. We are proud of them, for they have made a splendid record, especially in that most dangerous form of warfare: tunneling and laying mines. To them the old meaning of mining has been brought back literally. Among those to distinguish themselves have been Ralph Stokes, formerly at Johannesburg and later with the Canadian Exploration Company in New York; enlisting at the beginning of the War, he is now captain and has received the Military Cross. W. S. Holloway, formerly manager of the Gwendoline mine in Korea, serving as lieutenant in the Royal Engineers, has received the same decoration "for conspicuous gallantry." This cross of honor has also been awarded on proof of similar courage and intelligence to Herbert Eyden, H. C. B. Hickling, Arthur Hibbert, Hugh R. Kerr, and H. R. Ruggles-Brise, all of whom are lieutenants, and to Laurence C. Hill, Lionel E. Hill, Stuart G. Love, R. S. Mackilligin, and C. M. Euan Smith, all captains. Also to Major G. W. Laws, who has received, in addition, the Croix de Guerre from the French. J. Norton Griffiths, well known in South Africa, has been awarded the D. S. O. and is a major. Of all of these men the profession may well be proud. Among the mining engineers from this side of the Atlantic summoned by the call of duty to military service are the following: F. K. Borrow and Harold Riekard, both formerly in Colorado; Fred. B. Reece and J. H. Fennell, recently in Arizona; Morton Webber of New York; Peter N. Nissen, who invented the stamp; Lionel Lindsay and Gelasio Caetani, from San Francisco. Messrs. Lindsay and Reece are graduates of the University of California. Most of these men are holding commissions in the engineering corps or in the field artillery, for both of which services their previous experience helped them. Mr. Caetani is with the engineers of the Italian army; the others are with the British forces in the field. Mr. Webber has seen service successively in Flanders, where he was wounded, at Gallipoli, and in Bulgaria; he has been invalided recently. Whether the mining profession in America may have a similar call in the near future, we do not know; but it is certain that the members of it will be as quick to respond. Meanwhile an effort is being made to organize the engineering societies for effective co-operation with the Army and Navy. That is one of the best moves toward preparedness.



DISCUSSION

Our readers are invited to use this department for the discussion of technical and other matters pertaining to mining and metallurgy. The Editor welcomes the expression of views contrary to his own, believing that careful criticism is more valuable than casual compliment.

Flotation Principles

The Editor:

Sir—I have noted with great interest Mr. Durell's reply, in your issue of February 19, to my discussion¹ of his previous article.² It seems to me that in this reply Mr. Durell has discussed the subject in a manner entirely different from that of the article criticized. It also seems to me that he has related his experiences in Australia in a particularly valuable way and I am certain that the metallurgical profession has read them with great interest. Mr. Durell has also taken us more into his confidence as to why he believes that 'nascent' and 'occluded' gases are the necessary adjuncts of flotation, and has given us references for many of the facts that he has used as a basis for his theory. A parallel paper on much the same subject was sent to the Colorado School of Mines *Magazine* and published by it in the February 1916 number, and later copied in *Metallurgical and Chemical Engineering*, XIV, 50 (1916). Between these two papers of Mr. Durell's, I have been able to obtain a much better understanding of his theory, and this communication is intended to supplement my former discussion.

One of the two papers by Mr. Durell ends with the statement that he has shown "that all processes and kinds of flotation can be satisfactorily explained by gas occlusion and that the bubbles for froth formation are from nascent gas." It seems to me that Mr. Durell might well have added the qualifying phrase, "provided that all of the assumed factors prove to be true." I believe that a rigid analysis of Mr. Durell's logic will show that most of his theory, in spite of all the references given, is still based on some assumption that few, if any, physicists or physical chemists will be willing to accept.

Summing up Mr. Durell's argument, as I now understand it, we have the following: (1) Certain former experiments of Mickle's lead Durell to believe that 'nascent' gases (gas that has been in solution and is on the point of being liberated as free bubbles of gas by any means whatever) are the only forms of gas effective in flotation. Bubbles of gas already existing in the liquid will not attach themselves to mineral particles and cannot be made to do so. (2) This nascent gas can only form into bubbles when there are nuclei present in the shape of solid particles—in this case particles of ore

—and on these nuclei the bubbles of gas grow. (3) Mineral particles containing a large amount of occluded gas are the ones on which the nascent gas tends to collect to the greatest extent, and these are the metallic minerals. (4) The effect of electrolytes is to expel some of the 'occluded' gas from the metallic minerals, and nearly all of the gas in the gangue minerals, the surfaces of the mineral particles acting as septa so that the osmotic pressure of the dissolved salts expels or replaces some of the occluded gas, allowing cleaner flotation. (5) The effect of flotation-oils is to lend stability to the froth of mineral-laden bubbles which form on the surface of the pulp, that is, it causes stronger bubbles by adding the surface tension of the immiscible portion of the oil to that of the water, and, as good frothing oils do not evaporate readily, by rendering the film of water over the bubble less easily evaporated. Further, the oil decreases the adhesive force of the water for metallic mineral particles by forming oil-films around these particles, and the network of oiled particles on the surface of a bubble tends to increase its stability.

Taking up these points in order, let us see how many of them have a firm basis in fact. The first statement is that 'nascent' gas is all-important and that a gas bubble which is already formed cannot be attached to a particle. In this connection it may be of interest to note that in the suit of Minerals Separation against Miami Copper Co. both sides introduced experimental evidence in the Court in which a bubble of air, held on the end of a glass rod, was to pick up mineral particles from the bottom of a glass vessel under various conditions. By merely putting the bubble in contact with the mineral particle no difficulty was experienced in lifting it. The Minerals Separation experts produced moving pictures of this experiment and experts for the Miami Copper Co. actually carried on the experiments before the Judge, who was provided with a large reading-glass. No one has hitherto questioned the reality of this fact.

The second statement is that 'nascent' gas will only form into bubbles when it has nuclei consisting of solid or other particles on which to form. I believe that this fact is fairly well established by physicists, and hence I agree with Mr. Durell.

The third statement is that mineral particles containing a large amount of occluded gas are the ones upon which the nascent gas tends to collect to the greatest extent and that the metallic minerals 'occlude' more gas than do the gangue minerals. The fact that even original igneous rocks from the depths of the earth hold

¹'Why do Minerals Float?' by O. C. Ralston, M. & S. P., October 23, 1915.

²'Why is Flotation?' by C. T. Durell, M. & S. P., September 18, 1915.

large amounts of truly occluded gas is not denied, although Mr. Durell has not mentioned it. But I do not believe that Mickle's experiments give us any data on the amounts of gases 'occluded' by gangue-minerals as compared with metallic minerals. Mr. Durell quotes the experiments of Swinburne and Rudorf as demonstrating the presence of gaseous envelopes on the surfaces of dried mineral particles. This is a fact that no one wants to deny, but it is probable that this envelope of tightly held gas on the surfaces of particles, mentioned alike by Mickle and by Swinburne and Rudorf, has often been confused with the truly occluded gas that is within the substance of the particles. This gas envelope is *adsorbed* on the surfaces of particles and held there with great tenacity so that it is doubtless actually compressed by the molecular forces of attraction—variously named adhesion or what not. I gave references to this fact in my former discussion. This gas envelope, held by a submerged particle, might play an important rôle in the attachment of 'nascent' gas, but as far as I know there is no experimental evidence to prove that it does, and Mr. Durell presents none. He says that Hebron, the associate of Carrie Everson, used a microscope in discovering that the desirable minerals were more porous and presented greater surface than the gangue-minerals, but I know of no other observers who are willing to go on record with such a statement.

James A. Bloek described to me an experiment that he tried in order to test this third point of Durell's, and asked me to check his work. Through the kindness of E. P. Barrett, of this laboratory, this has been done. Using a glass-rod bubble-holder, such as was employed in the Minerals Separation-Miami case, portions of powdered galena and of quartz were tested for flotation in boiled distilled water. The particles of mineral were introduced into the distilled water and then left on the hot plate to boil for several hours. Thereby all dissolved gases in the water were removed, and presumably all of the gaseous envelopes on the mineral particles, and all occluded gas within reach of the surfaces of the particles. Under these conditions, according to Mr. Durell, even nascent gas could not attach itself to the particles, and the bubble in the bubble-holder never should do so. However, the galena and quartz particles were both lifted with comparative ease, in hot water, just removed from the hot plate, and before any gas had time to dissolve in the water or get at the mineral particles. The addition of a small amount of sulphuric acid to the water caused no change in the action of the galena, but the quartz would no longer lift. The experiment was repeated after further boiling of the same water with the same particles, more distilled water being poured in from a large beaker that was boiling at the same time on the same hot plate. The galena in distilled water was tested at intervals for two days and always came up. At that time a small amount of suspended white material from interaction of galena with the water was visible, although the flotation of the galena did not seem to be interfered with. At this point the experiment was discontinued.

No claim is made that this experiment of Mr. Bloek absolutely refutes Mr. Durell's theory, but I do insist that it casts a very serious doubt upon it.

The fourth step in Mr. Durell's argument, involving osmosis with the surface of the mineral particle acting as an osmotic septum, so that ions of an electrolyte diffuse into the mineral particle while "those of the gas leave," rests, I believe, on assumptions. In fact, I think that the whole of this fourth argument will find little support from the rank and file of physical chemists.

The fifth part of the argument, which deals with the effect of oils in *increasing* the surface tension of the water by adding to it the tension of the oil film, I shall leave to Messrs. Rickard, Coghill, and others who have been recently writing on that subject. I believe that their recent papers contain data sufficient to refute many of the claims which Mr. Durell has made. He has had to explain the action of the oil in order to make the remainder of his theory plausible. There are many people who will agree that one of the main functions of the oil is to cause frothing, although they have very definite data to prove that the surface tension is greatly *decreased* under the conditions whereby good flotation is obtained. However, many more definite experimental data on these points are necessary before anyone can state what is the true function of oil in froth flotation.

From what has gone before, it can be seen that Mr. Durell's main arguments have an insecure foundation and that while he has many interesting references on minor points and has evidently reviewed carefully all of the experimental work that is reported, the main points of his theory rest largely on conjecture.

He has stated that both of my hypotheses as to why minerals float involve the use of oil, and that therefore both hypotheses are of no value, as oil is not an essential element of flotation. Without drawing out this argument to burdensome length, let us examine it. With negatively-charged gangue-minerals, positively-charged metallic minerals and negatively-charged air-bubbles, we have all the electric conditions favoring attachment of air bubbles to the metallic minerals and a good reason for their avoiding the gangue. By the use of a flotation-oil we can modify the surface tension and other properties of the water so that it froths better. Let me also state that we have actually seen, by using a microscope, such charged particles move under the influence of an artificial electric field, and know that they have electric charges. I feel that definite experimental evidence of this kind is of much more value than conjecture.

I find that I have been more or less credited with being the originator of the 'electrical theory.' This is a mistake. So far as I know, the first public mention of electric effects, as I stated in my first discussion of Durell's theory, was made by George Riter, and later by J. M. Callow. Both of these gentlemen had spoken to me privately on the subject before their public utterances and I had told both of them that while electric charges were common to all colloids, I did not feel that this was the only property of the particles in question to be considered. I stated so in my former paper and now

wish to reiterate the belief that a comprehensive theory of flotation will have to take many different physical properties of small particles into consideration, among which are their electric charges and the interfacial tensions of the phases involved. In other words, such a theory (which has never yet been enunciated) might be called a 'colloidal' theory, if we remember that many of the special physical properties of the true colloids are important enough to be in evidence even in the coarse suspensions with which we have to deal occasionally in flotation.

Salt Lake City, March 14. OLIVER C. RALSTON.

Platinum at the Boss Mine

The Editor:

Sir—The recent article by Mr. F. A. Crampton on 'Platinum at the Boss Mine, Goodsprings, Nevada,' gives much valuable information, especially with reference to the details of the distribution of certain of the metals throughout the deposit. It is to be regretted, however, that Mr. Crampton has not given us from his intimate knowledge of the Boss deposit some data on the relative distribution of the palladium and platinum. Of these two metals palladium is far the more soluble, approaching silver in this respect. Now the most remarkable geologic feature of the Boss deposit is the great mobility that the platinum appears to have had in oxidizing solutions, and to this unexpected property the extreme localization and enrichment of the precious metals in the Boss deposit is probably due. When the extraordinary resistance of metallic platinum to most chemical reagents is considered this ease of solubility in the zone of oxidation is truly astonishing. This leads to the supposition that in the primary ore, which remains as yet unknown because of the insufficient development of the mine, the platinum is present as a chemical compound that is easily susceptible to oxidation, and that the platinum under the conditions of oxidation, being then in the nascent state, goes readily into solution. An analogy for this supposition is afforded by tin-bearing ore deposits. Under most conditions tin ores are not enriched by secondary processes, because cassiterite is strongly resistant to the natural solvents occurring in the zone of oxidation, but if the tin is present in the primary ore as stannite or other stanniferous sulphide, secondary concentration readily takes place. Until, however, deeper exploration discloses the primary or 'hypogene' ore of the Boss mine, which, as I have elsewhere shown, will be found to contain the sulphides of copper, lead, iron, and bismuth, the problems concerning the genesis of the oxidized ores cannot be fully solved.

One of the closing statements in Mr. Crampton's article is not strictly accurate. The occurrence of platinum ore at Broken Hill, Australia, is not similar to that at the Boss mine. The Broken Hill deposits have recently been described by Douglas Mawson.* The platinum occurs principally in copper and nickel-bearing

gossans of small and irregular dimensions. All the occurrences are closely connected with magnesian igneous rocks, and hypersthene gabbro (norite) is associated with them. It is believed that they represent sulphide segregations from basic intrusions, and that accordingly they are analogous to the platinum-bearing ore in the norite at Sudbury, Canada. The deposit at the Boss mine therefore still remains unique.

Washington, D. C., April 8. ADOLPH KNOPF.

Oxidation

The Editor:

Sir—In referring to the chemical change which gives rise to the formation of oxides, which of the two following terms is the correct one: 'oxidation' or 'oxidization'?

Charles Janin, in 'Mining Engineers' Examination and Report Book,' on page 9, seventh line, speaks of "depth of oxidization." This quotation caused an argument between two men. One man contended that there was no such word as 'oxidization' in the English language, the other man contended that while the word was not correct its use was permissible owing to general usage. Hence this appeal to you.

Seattle, April 17. JOHN T. TOWERS.

[Oxidation is correct. 'Oxidization' is to oxidation what 'preventative' is to preventive.—EDITOR.]

Mine Accident Insurance

The Editor:

Sir—Our attention has been drawn to an editorial on the above subject which appeared in your issue of April 1, and to a reply from Mr. Will J. French of the California State Industrial Accident Commission published in your issue of April 15. This is a matter of grave importance to the members of our association and we are glad that Mr. French has replied to your editorial, because much can be gained by public discussion and a full and fair elucidation of the facts.

The common grounds upon which we can meet Mr. French and the other members of the Commission are:

1. That all reasonable steps for the prevention of mine accidents should be taken by the operators.
2. That the insurance, however carried, should be an absolute and complete protection for our employees; and
3. That we should be allowed to obtain that insurance at as low a rate as is compatible with complete security.

We are bound to give the California State Industrial Accident Commission and the State Insurance Commissioner credit for full honesty of purpose in handling this question, even though we express doubt as to whether they always pursue the proper course, and that the public may know the facts we will ask them if the following statements are not true?

Either Mr. Pillsbury of the Commission or Mr. Fel-

*'Geological Investigations in the Broken Hill Area': Mem. Royal Soc. South Australia, Vol. 2, part 4, p. 317, 1912.

lows, its manager of the State Compensation Insurance Fund, stated in an open meeting in the fall of 1914 that the Commission had no experience on which to base a mining rate and that they felt they should play safe and therefore made the rate 7.86%.

The Commission was then informed that the State of Nevada had been insuring mining risks for more than a year at an average of about 2.2%, and the Commission immediately telegraphed the Nevada Industrial Commission for information on this subject.

The secretary of the Nevada Industrial Commission came from Carson, and after a conference with him, the State rate on mining risks was reduced to 5% for underground men and 3.75% for surface men. Is it not a fact that neither the State nor any insurance carrier ever wrote any considerable amount of mining insurance at so high a rate as 7.86%, and that ever since the reduction made on January 1, 1915, the mining risks carried by the State Compensation Insurance Fund have represented an almost negligible percentage of the total mining risk carried?

We challenge the statement that "the State Compensation Insurance Fund has the only reliable statistical data on the subject." Admittedly, in the fall of 1914 it had none, while the corporation which has written the risks of a large number of our members had been in the same or similar line of business, making a specialty of mining risks, for many years. If it be true that during the past year, the total Workmen's Compensation insurance business of this corporation has resulted in a loss, it is by no means certain that this loss is due to the mining department, in which it has had its longest experience, and still less certain that the mining department of its California business has resulted in loss. On the contrary, it seems to us quite probable that losses incident to unusual catastrophes in Montana, where premium rates lower than those of California prevail, may have had something to do with the temporary loss. In this connection this Association is now collecting data on the experience of some of its members who carry their own insurance. These members have a total of over 2000 employees, and while the information is not yet sufficiently complete for publication, its compilation has advanced sufficiently far to enable us to say that when the figures are complete they will show that the total cost to these companies for carrying their own insurance, including amounts set aside for the payment of deferred and contingent losses will not exceed 2.3%.

The reference in Mr. French's letter to the Commonwealth Bonding & Casualty Insurance Company of Texas seems to us hardly fair. This concern may have written some mining business in California; but, if so, it is not known to the members of this association, the volume of whose pay-rolls equals at least 90% of the total mining pay-roll of the State. On the contrary, that concern, which had been licensed to do business by the State Insurance Commissioner, was made the subject of an independent investigation by our Association, and its policies declined.

That your readers may know how serious this matter

is for the members of our Association, we might add that we estimate that if the employees of all members were insured, the difference between the rate fixed by the State Insurance Commissioner and that which many of our members are now paying would amount to at least \$120,000 per year. In conclusion, we repeat that, while we are glad to co-operate with the Industrial Accident Commission in minimizing the chances for accident, and desire that those of our employees who may be injured be assured of receiving all the compensation to which they are entitled under the law, we do not feel that we should, without vigorous protest, pay \$120,000 per year to assist the State of California in its experiment with the insurance business.

ALBERT BURN,
President.

ROBT. I. KERR,
Secretary-Treasurer,
California Metal Producers Association.

San Francisco, April 18.

McDougall Roaster

The Editor:

Sir—I notice in your issue of April 15 a sketch of the McDougall arm and rabble, to which you refer to in the text as the Kelly arm. This arm is covered by the Thomson-Kelly patent No. 940,488. Please note that the patent is the Thomson-Kelly, not the Kelly, nor the Kelly-Thomson as Hoffman has it.

H. N. THOMSON.

Clarkdale, Arizona, April 17.

Antimony-Gold Ore

In our issue of April 15, on page 542, a typographical error was made by transposing and repeating the last equation. The first equation, illustrating the solution of antimony sulphide in caustic soda, should have been

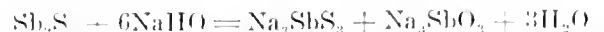

THE EXPANSION of American industry in foreign countries has been hindered by inadequate methods of exchange. The National City Bank of New York is leading the way in facilitating American participation in the development of Latin America and the Orient. Branches have already been established by that enterprising bank in the following Latin American cities: Buenos Aires, Montevideo, Havana, Rio de Janeiro, Sao Paulo, and Santos the latter three being in Brazil. The same house, by securing control of the International Banking Corporation, now has connections at Panama, Colon, Manila, Cebu, Bombay, Calcutta, Singapore, Yokohama, Kobe, Tientsin, Peking, Hong Kong, Canton, Shanghai, and Hankow. A Russian division has been organized with agencies in London and Petrograd.

AVERAGE price received by Michigan copper mines for their product in 1915 was 18.4c. per pound. The highest was 19.83c. paid to the Franklin.

Mining in Northern Arizona

By Charles F. Willis

MINING in the northern half of Arizona has been highly stimulated of late. The name of Oatman has echoed far and wide, but the Oatman boom is bound to be rivaled by the excitement at Jerome. Jerome is the hub of the copper-mining activity of the northern half of the State. While it has been for years a one-mine camp, it is now out of that classification.

One of the most spectacular happenings in Arizona has been the record of the United Verde Extension Mining Co., known as the Little Daisy. This mine is not two years old, but, within its short life, its stock has risen from 30 cents per share to \$27. It is claimed that it will be earning \$4 per share within a few months. While this mine is shipping but 200 tons per day, the ore is practically all from development. During the month of March, 5920 tons of ore was shipped. The company makes a remarkable classification; first-class ore is 30% copper, second-class is 15%. The output in March was 2,000,000 lb. of copper. Practically all the work is centred on the 1400-ft. level, developing a single orebody, which is now 120 by 200 ft., with neither wall reached. A raise has been put up for 65 ft. and the upper limit not found, yet this wonderful orebody averages better than 20% copper.

The excitement attending the success of the Verde Extension is shown by the rapid financing of the Green Monster Mining Co. in the same district. The Green Monster adjoins the Copper Chief, which in turn adjoins the Verde Extension. The directors offered 600,000 shares of stock to the public, allotment being made to the principal towns in Arizona. The stock was to be sold in lots of not less than 1000 shares; within three days the stock was several times over-subscribed.

Jerome, however, is not the only part of Yavapai county where there is mining activity. The Bradshaw mountains are to have an adit similar to the Roosevelt tunnel at Cripple Creek. An adit 12,000 ft. long at a maximum depth of 1800 ft. is planned for drainage and transportation. Notable among the mines that will be tapped at depth are the War Eagle, Gladiator, Nelson, Fairview, Spring Green, and Lincoln. None has produced less than \$500,000 during years of adverse conditions.

The cinnabar mines of Copper Basin are attracting attention, owing to the high price for quicksilver. It is reported that the quicksilver belt of Copper Basin is 1½ miles long and 300 to 600 ft. wide, with an average of nearly 2% mercury. This district has the advantage of accessibility, being but seven miles from the Santa Fe, Prescott & Phoenix railroad.

The Consolidated Arizona Smelting Co. plans to increase the capacity of its flotation plant at Humboldt

from 250 to 600 tons per day. The Blue Bell mine is shipping to the Humboldt smelter six carloads of ore daily. The De Soto mine, also owned by the Consolidated Arizona, is shipping four carloads daily, this mine being limited in output by the capacity of its aerial tram for delivering ore to the railroad.

While the 'boom' period has passed in Mohave county, the work of developing the Oatman, Secret Pass, Union

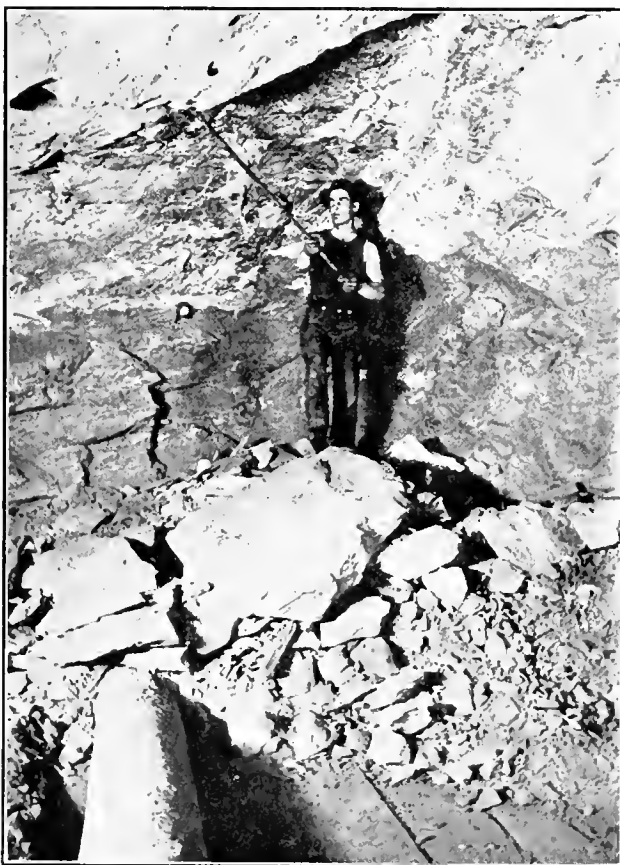

BARRING-DOWN IN A CUT-AND-FILL STOPE.

Pass, Black Range, Golconda, and other districts proceeds steadily. The reported strike in the United Western at Oatman spurred the 160 companies operating in that district to greater effort. Oatman has the distinction of having a mining company owned and operated by women. The Murdock Extension Co., promoted by a group of Los Angeles women, has an option on five claims. The same women are prominent in the political life of Los Angeles; Miss Musa Rollings, secretary of the Murdock Extension, is also secretary of the Women's Democratic League of Los Angeles county.

A large hoisting plant is being installed by the United Western. While this mine has found but 6 ft. of brecciated quartz, quartz is usually an indication of the top

of a body of real ore. The United Eastern Co. continues steady development underground, constantly adding to its reserves. A new three-compartment shaft, 700 ft. from the old shaft, is being sunk, and preparations for the construction of a 100-ton mill are being rushed. J. A. Burgess has just been appointed resident superintendent, resigning the management of the Nevada Wonder mine. The Tom Reed and the Gold Road still continue a steady production of about \$100,000 per month each. Development at nearly all the Oatman mines is conducted on similar lines; a hoist and a compressor are installed and a shaft sunk to 500 ft. before lateral work is started, it being assumed that good ore will not be found near grass-roots.

Northern Yuma county is to the fore. In the vicinity of Parker several prospects are getting under headway. The Empire-Arizona company is making shipment by auto-truck to Parker, and new orebodies are reported.



A road is planned to Parker, to reduce the distance from the mine to the railroad by nine miles. The Billy Mack is producing steadily. It is rumored that strong financial interests will open up this old-time producer on a large scale. The Zerolite-Mammoth, which was recently purchased by Nevada people, is preparing to ship. W. B. Andrews, the manager, is at the mine ready to start development. The Swansea-Planet region is humming with life. The Swansea lease, on the Clara Consolidated mine, held by the Thomas estate, made a profit of \$22,000 in March, and probably will exceed this in April. Three carloads per day are going out of Swansea and the ore is averaging slightly over 4% copper. A new orebody, 36 ft. wide, has been opened, averaging over 5% copper. The Planet is shipping 10 tons per day to Midway, a station on the Swansea railroad. The ore is running 18% copper, and it is a bonanza for the owners. Motor-trucks are employed for transporting the ore. The manganese claims in the Planet range, eight miles from the Swansea railroad, have been sold to a syndicate. Bids are being asked for the transport of ore to the railroad, a haul of eight miles. It is planned to ship 200 tons daily. The Lowell mine, near the Planet, has been sold to Salt Lake City men, who will begin operations at once.

On account of the shortage of cars, caused by the requisition of the Government along the Mexican border, a large stock of copper accumulated recently at the International smelter and the Old Dominion. Finally, a single large shipment was made containing 49 cars of copper, over 2000 tons, valued at \$1,063,870. This is probably the largest shipment at one time from any district in the State.

A plant for the production of metallic molybdenum has been erected at Tucson. Although Arizona produces most of the molybdenum of the United States, there are many deposits to which little attention is paid, owing to the high shipping charges to distant smelters.

Every smelter in the State is working to capacity, and has been receiving more ore than it could handle. The result is shown in increased smelter charges, which will tend to eliminate low-grade ores. Some dissatisfaction is expressed at the new schedules, but it is realized that conditions are abnormal.

Concentration of Zinc at Butte

The following notes are from the report of the Butte & Superior Copper Co. for 1915:

The flotation department was re-built to improve its efficiency and increase its capacity. The greater tonnage treated made it necessary to add to the fine-grinding and slime-settling apparatus. These improvements resulted in the plant treating 60% more than in 1914, with better recovery and lower cost. There was 522,300 tons treated (the last quarter of the year at the rate of 600,000 tons per annum), with 92.21% extraction (95.07% in last quarter), an increase of 3.5%, at a cost of \$1.75 per ton, a reduction of 37c. per ton. Details are as follows:

Average assay of ore: 0.01409 oz. gold, 7.6299 oz. silver, 0.2121% copper, 1.2127% lead, and 17.0211% zinc. Zinc concentrate (152,897 tons) assayed 0.0403 oz. gold, 22.14 oz. silver, 0.573% copper, 2.448% lead, and 53.616% zinc.

Zinc concentrate contained 6164 oz. gold, 3,385,164 oz. silver, 1,751,545 lb. copper, 7,485,489 lb. lead, and 163,956,791 lb. zinc.

Lead concentrate (5274 tons) assayed 0.542 oz. gold, 33,792 oz. silver, 0.386% copper, 37.815% lead, and 13.52% zinc.

Lead concentrate contained 286 oz. gold, 178,218 oz. silver, 40,665 lb. copper, 3,988,679 lb. lead, and 1,426,130 lb. zinc.

The gross value of metals was \$13,244,133, of which \$9,074,152 was profit, and \$4,908,115 was distributed in dividends.

Production of primary spelter in the United States in 1915 was 489,519 tons, an increase of 39%. The value, \$121,401,000, was an advance of 237%, while the domestic consumption was greater by 22%, according to the U. S. Geological Survey. Further notes will be found in our New York metal letter.

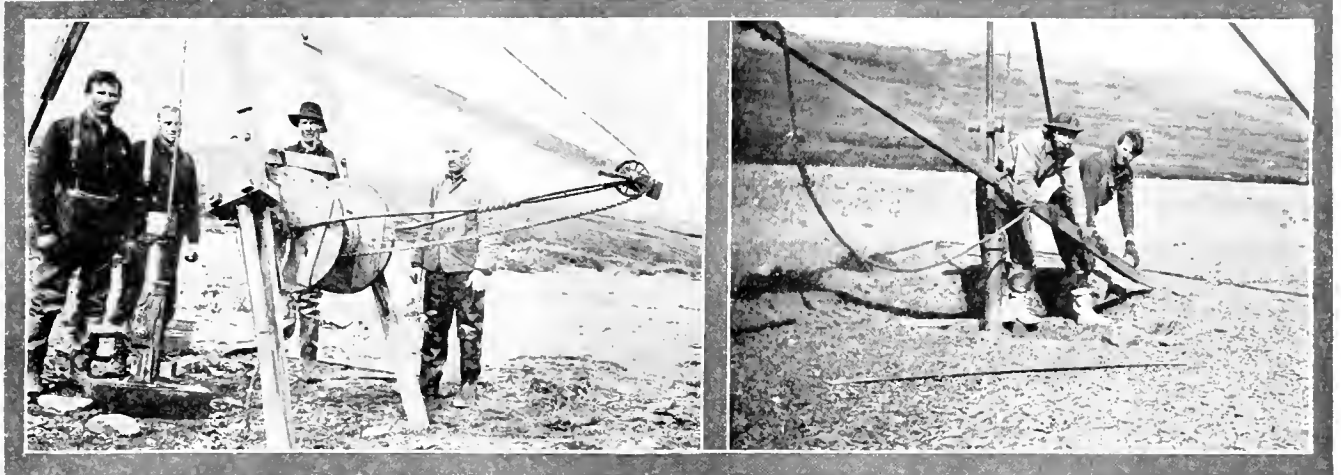

A PLACER-DRILL.

ANOTHER DRILL, IN OPERATION.

Prospecting Before Dredging on Seward Peninsula, Alaska

By Corey C. Brayton

INTRODUCTION. Seward peninsula, just below the Arctic circle, is the most western land of the American continent. Nome, I believe, is the only mining town that is also a seaport, but without harbor or docks. It stands on a sandy beach on the edge of the coastal plain, which extends four miles to the foot-hills. Vessels anchor a mile off shore and handle cargo and passengers by lighters and cable-way. The Government could, at a cost of a few thousand dollars, make Snake river an excellent harbor for small craft such as coast-wise gasoline-boats. As yet, the Government has done nothing to help shipping at Nome; it has done little to aid Alaska (as compared with Canadian treatment of the Yukon) except the present railroad construction and the excellent work of the Geological Survey such as conducted under Alfred H. Brooks. Geological reports have been issued promptly and have been used to a much larger extent than in the States.

The climate of the peninsula during the four summer months is not unlike the winter climate of San Francisco. The temperature begins to drop in September, and by the first of October hydraulic and pick-and-shovel operations cease. The 'freeze-up' comes in late October and puts an end to dredging.

PROSPECTING. The churn-drill as a machine for testing gravel deposits was first used in this region during 1902 by A. A. Allan for J. W. Kelly on Dexter creek. This was a regular oil-well rig with a short tower. It was used in frozen gravel to a depth of 200 ft. Following oil-well practice, the hole was started large, 10 inches, and then tapered. I am told that this method of testing for gold, at least as far as Kelly was concerned, was original. He had not heard of the Keystone drill

which had been employed for similar work in California since 1898.

This Keystone drill was soon introduced and became the standard machine for testing alluvial ground. It was used alike for shallow and deep drilling, in frozen ground and in thawed. In frozen ground no casing is required even though the hole may be 200 ft. deep or more. This soon became the accepted method for tracing the gold concentrate in old channels and beaches, and for testing dredging ground. For the former purpose it was more of a qualitative than a quantitative test. Ordinarily no attempt was made to test a 'pay-streak' thoroughly with the drill. If one or several holes showed 'pay,' a shaft was sunk and the 'streak' was tested with drifts. It was not the general practice in such drilling to wash up the entire content of the hole, but only the parts that looked promising. This is especially the case with the greater part of the drilling in the beach area between Nome and the foot-hills.

In testing dredging ground the method was standard drilling and pumping. The greater part of such ground is shallow, usually less than 15 ft. An average depth would be 10 ft. A considerable area as shallow as 6 ft. has been dredged. Usually there is too much water to dig pits or sink shafts—an economical method of testing where the ground is shallow. The results obtained by the Keystone in this class of work were satisfactory, but the machine was expensive, and fuel and repairs costly. Recently gas-engines have given as good satisfaction as steam at a much lower cost for fuel. While the Keystone gave satisfactory results it was not a machine that the average claim-owner, and every man in Alaska owns from one to a dozen claims, could use for

testing has ground. It was expensive even for those who could afford it.

Lack of roads and the scattering of ownership among a large number of men without either the time or the money for testing the shallow ground created a demand for a cheaper method. It is true that some of the equipment evolved is crude, but if honestly applied the results are not unsatisfactory. The start of development was something as follows: Some miner, who had seen a drill work, wanted to test his own shallow ground. He drove a 2-in. pipe with a hammer to bedrock, pulled the pipe, and found he had some bedrock in the end and a core of gravel above. He probably told his friends, who also tried it. Driving with a hammer is slow and batters the pipe badly, so someone rigged up a heavier weight. Next came a 3-in. pipe and then a 4-in., and with this came the tripod and rope for handling the heavy driving-weight. This is the simplest equipment now employed, though the 2-in. pipe is still used at times by the miner for rough work. Next came the rig with a better application of hand-power, and finally the light gasoline rig. Different types of hand and power rigs have been used, but it will suffice to discuss only a few.

A common tripod type of hand-rig is constructed and operated as follows: Three two-by-fours or poles are fastened together at one end by a bolt or rope lashing from which is hung a single sheave. The rope attached to the driving-weight passes over the sheave and two or three men raise the weight by direct pull. The weight is usually a round bar, $2\frac{1}{2}$ or $2\frac{3}{4}$ in. diam., with a welded driving-head or bolted clamps, the total weighing about 100 lb. The pipe is driven to bedrock, pulled and the core removed. There is nothing new in this rig; it is in common use for many purposes.

The rigs affording a better application of power are not numerous, and not all agree that this type of machine is more satisfactory. In general, the rig is a tripod or frame equipped with a windlass for controlling the length of rope, and a walking-beam. An attempt was made to secure a more efficient application of man-power, and I believe it is an improvement over the straight-pull rig. The operation is the same as above, but the driving-weight is heavier.

Finally came the light-weight power-rig. The first attempts along this line were clumsy affairs. In 1911, Julius Saupe, of Kimball & Saupe designed the first satisfactory rig of this type. It was soon followed by others, till now the light power-rig is generally accepted as the machine for testing ground up to 15 or 20 ft. deep. Each design has a different motion for actuating the bit, and there are other differences. The problem has been to build a light, portable, durable, and fool-proof power-machine that two men can move easily over the ground to be tested. The biggest problem has been to keep down the weight and still have a durable machine of good capacity. No attempt has been made to equip with traction, as the advantages would not justify the extra weight and cost. All have a power-boist for handling pieces of pipe and bit, and another for the sand-pump, though the latter is used only in frozen ground.

The engines are of light weight, and vary from 2 to 4 hp. The bit has two squares for clamps, and ranges from 100 to 150 lb. The clamps weigh 50 lb., making a total weight of 150 to 200 lb. The length of the stroke is 24 to 36 in., at 20 to 60 per minute. The total weight of the machine is 750 to 1300 lb. Each machine has two wheels for moving, and is provided with pipe-wrenches and jacks or, in one case, a power device for pulling pipe.

The light power-rig and the hand-rig make use of a new method as applied to placer ground. The universal method for testing gravel has been drilling and pumping. This method makes use of machines originally developed for drilling oil and water-wells. The first machine used for testing gravel in the United States was a Keystone operated by Newton Cleveland for W. P. Hammon and R. H. Postlethwaite at Oroville in 1898.

The new way is a coring method, locally called pipe-driving or drilling, more frequently the latter. The same idea has been adopted in the sampling of mill-tailing, so it is not original except in its application to placer ground. It has proved highly satisfactory on Seward peninsula because the conditions there are favorable. In other deposits, such as at Oroville, it would, I believe, be an absolute failure.

The creek and river deposits of the Seward peninsula are shallow and thawed. The wash is usually angular and, compared with other deposits, for example in California, is soft. A most expressive term applied to it by a friend of mine is 'square wash.' Some of it is inclined to be slabby. Only a small proportion exceeds 6 in. diameter. It is what may be termed 'loose.' The bedrock is either limestone, frequently metamorphosed to an almost white marble, hard but shattered or scamy, or it may be mica-schist usually decomposed for several inches. These are ideal conditions for pipe-driving or coring.

The general practice is as follows: A single length of 4-in. pipe, the length depending on the depth of gravel, is set on end and driven to bedrock. Experience enables the operator to 'feel' bedrock as soon as it is struck. The pipe is driven into bedrock for a few inches or even a foot or more, depending on the penetration of the gold. During the driving the pipe is rotated by one man with a pair of chain-tongs. The rotation keeps the pipe loose and aids materially both in driving and pulling. The pipe is pulled with a step-jack, a lever, or power puller. A 10-ft. hole can easily and quickly be pulled with a No. 2 jack. In pulling, care must be used to prevent excessive vibration and consequent loss of the bottom few inches of the core. The pipe is hoisted clear of the ground and a galvanized-iron tub is placed under it to receive the core. The most satisfactory method of removing the core is by pounding the pipe with a light hammer. A little experience will enable the entire core to be removed in approximately definite sections, for inspection, but ordinarily only the bedrock and a few inches above are tested separately. Finally the entire core goes to the rocker.

Standard or extra heavy pipe is used, the former being

more easily handled but not lasting as long. No shoe is employed and couplings are avoided by using the longest section possible. Shoes and couplings interfere seriously with both driving and pulling. The end of the pipe is kept sharp by filing, and when split or broken is cut off with a hack saw. A sharp pipe drives much more easily than a dull one. In case more than one length of pipe is necessary, a driving-ring a little heavier than a coupling is screwed on. Otherwise, either a ring is shrunk on or no ring is used.

The ideal pipe would be steel tubing, and though it costs more, it should last longer and should drive with

if not more so, than drilling and pumping. It is true, there is a shrinkage of core caused by compression, or displacement, or possibly by both, but I do not know the proportion of shrinkage, nor does anyone else. It apparently remains constant up to 15 or 20 ft. An operator soon learns his ground and can judge while driving whether he is getting the proper core. When the core is removed it is easy to judge. It is impossible to get too much core and consequently too much gold. It is possible, but not probable, that in a number of holes one may get too little core. Successful salting is impossible with ordinary care on the part of the operator.



THE AUTHOR'S LIGHT POWER-DRILL.



REMOVING THE CORE.

minimum friction, since it has a smooth surface both outside and inside. Pipe friction is most marked with a light rig, both in driving and pulling. It is present in the same proportion with a heavy rig but is seldom noticed.

The advantages of this method are accuracy, speed, and cheapness. It is difficult to convince one who has not used this method that it is accurate. Innumerable reasons can be imagined why it should not be, but the "proof of the pudding is in the eating." The average operator or engineer would say that a small pipe will soon choke by friction and then merely displace material the same as a solid cylinder, but it does not. The core frequently shows discs from 2 to 4 in. thick cleanly cut all around, and as frequently shows equally thick cuts from the end or side of a boulder. Often these are hard rocks. Undoubtedly at times the pipe strikes a boulder and shoves it to one side, so also does a 6-in. pipe. Sometimes a hard cobble a little larger than the pipe will wedge itself into the cutting end and remain there, acting as a plug, but it shows up on pulling the pipe, and a new hole is driven. The method has proved as accurate,

Panning the top end of the core, or barren material, detects salting.

As a proof of accuracy, and accuracy is relative as in all placer testing, I give the results of the testing and dredging that I did on a creek in the Solomon region. This work represents three seasons' operation with a small dredge. The holes averaged 8.3 per acre. In the first season the gold return was a little over the calculated amount, in the second season a little under, and in the third season a little over. Considering the entire acreage the production was 0.3% over the calculated yield. This comparison is based on bullion production from the total yardage dredged, and on carefully calculated test-values. The yardage was calculated at each clean-up, or once every two weeks, from the area staked in advance, and by daily soundings. The average value was determined by giving each hole in each cross-cut line and each line its proper weight. The inside diameter of the pipe was used in calculations and no discount factor was employed. The area dredged was a strip averaging 200 ft. wide. The prospecting was in lines of holes across this strip, the interval between varying with

conditions and the interval between holes ranging from 25 to 12½ ft. The average depth of ground was 7.42 ft. The ground was dredged strictly in accordance with the drilling, the limits of 'pay' being staked in advance of the dredge.

To have dredging check so closely with drilling is unusual. This means simply that the method is satisfactorily accurate under favorable conditions. Of course my average number of holes per acre was high, probably the drilling and pumping method with the same number of holes per acre and using a discount factor would have been equally accurate. I do not mean that our dredge made 100% plus extraction; no one knows what a dredge extraction is, but it is generally guessed to be 80%. There is no practicable method of sampling dredge yardage, but this method of testing apparently makes the same extraction as a dredge, if I may express it thus, and no discount factor need be used.

Although I am not alone in this experience, I have no figures to quote from other operators. One operator, with probably the widest experience of any of us, says his ground dredges at least up to testing and sometimes over. This is his experience with several dredges over several seasons.

As to speed and cost, I give the following figures, obtained with an improved hand-rig; a crew of four men, including the panner, who occasionally helped on the rig, drove 139 holes in 20½ days, averaging 51.41 ft. per 10-hr. day, in ground varying from 4.5 to 9 ft., and averaging 7.56 ft. This was done at a cost of 58½¢ per foot, with the panner at \$7.50, the remainder of the crew at \$5, and board at \$1.34 each per day. The cost per foot includes an item of 4¢, for purchases, about half of which should properly have been charged to equipment. This is probably lower than the average cost for hand-drill work and is given merely as an example.

Illustrations of speed and low cost with a light power-rig are as follows: two men, one the panner, averaged on ground the same as above, 57.3 ft. per day, an average depth of hole of 7.1 ft., at a cost of 27.8¢ per foot; on another test, two men and a panner averaged 79 ft. per day, the average depth of hole being 13.2 ft., at a cost of 34.3¢ per foot. In another case two men and a panner averaged 87.2 ft. per day, average depth of hole 7.3 ft., at a cost of 23.7¢ per foot. As an instance of deep ground, two men, one the panner, averaged 106 ft. per day, average depth of hole 20.2 ft., at a cost of 30¢ per foot. In this case conditions happened to be exceptionally favorable.

The light power-rig should operate at one-third to one-half less cost than the hand-operated rig and at considerably less cost than the heavy power-rig. The number of men required depends on conditions. Usually two men and a panner make the most efficient crew. One man and a panner can handle the work but at less speed. In average ground a panner has little time for anything except panning. The consumption of gasoline is slight, not exceeding a gallon per day; repairs are almost nothing; pipe and rope replacements are varying items, but never high. On a long move the whole outfit is not

a two horse load, and once on the ground horses are unnecessary. In case of transport by man or mule, the machine is easily dismantled. The light power-rig, under conditions where pipe-driving is impossible, can be used as a drilling and pumping machine. On account of its light weight it meets the need in inaccessible localities, where transport is difficult; also for preliminary work anywhere. An objection naturally raised to this machine is the small size of hole and pipe. A 6-in. hole has more than twice the area of a 4-in. hole, but how much more accurate is it? Theoretically, the larger hole is more accurate, but we do not get theoretical results in drilling.

DREDGE PRACTICE. The first mistakes in the building and operation of dredges were natural and came partly from lack of accurate knowledge of what had already been done. The early machines, whether of land or water type, were too light to stand up even under favorable conditions. One of the early dredges was built on Dry creek, at the edge of Nome. This had a horizontal rotating movement mounted on rail-trucks and was equipped with buckets of 1-cu. ft. capacity, screen, table, stacker, etc. It was planned to dig a bedrock-drain to the Third beach. It had some novel features, but was altogether too light. Two similar machines were built, one of which was operated for several seasons on West creek, 30 miles east of Nome. This machine made a little money and demonstrated that, if properly constructed, it was fitted for certain types of deposit.

Another early dredge was operated on the Solomon river, near the mouth of Shovel creek. This was a floating machine, the bucket-line swinging on a boom from side to side while the hull remained stationary. The machine was re-built and finally abandoned for a more modern type. The first really successful dredge was built in 1905 by W. L. Leland, of the Three Friends Co., on Solomon river. This was a 5-ft. California standard machine, but steam driven. It is still operating but is now using electricity generated by a shore Diesel plant.

Seward peninsula finally developed a type of dredge adapted to existing conditions. In the States the Californian type of dredge prevails, as developed to suit deep and tight gravel. In the North similar conditions exist in places, and again there are others peculiar to the region that call for another type, or at best important modifications of the standard type. It is this type in particular that I wish to discuss.

In the United States the requirements for a one-dredge operation have been about as follows: favorable physical conditions with sufficient area and yield to pay for the dredge and a profit in 8 to 10 years, this period being taken as the life of a dredge. Operating factors are favorable, including climate, power, labor, and freight. Ordinarily the grade of the deposit is so low that these favorable conditions are necessary. It has been a question of big area, small profit per yard, and long life. Small rich areas that would last two years at a profit are the rare exceptions, and shallow depth is seldom a controlling factor.

On the Seward peninsula the new conditions are

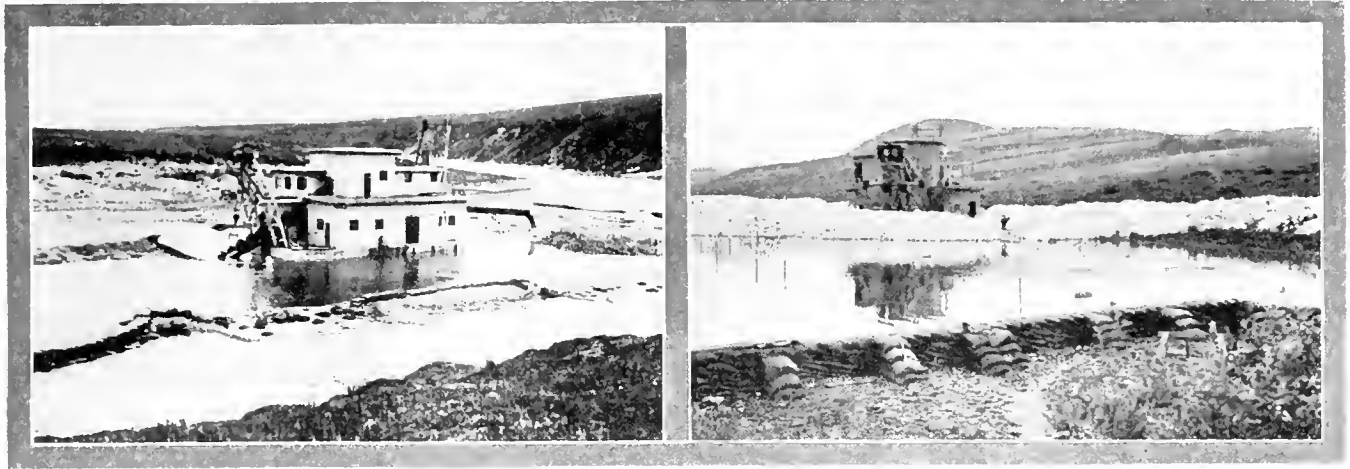

A FLUME-DREDGE.

A SCREEN-DREDGE.

rarely so favorable; usually there offers a small rich area of loose gravel from 5 to 10 ft. in depth that will last a 2½-ft. dredge from 12 to 18 months of working time; high cost of labor; a short season of four months; high cost of power and freight.

There were two ways of designing a dredge that would meet conditions: to ignore standards elsewhere; or to modify known standards. Both methods have been followed, resulting in the development of a type of machine that may not be perfect, but is at least satisfactory. This is called the flume-dredge. Although such a dredge was one of the first to be successful at Oroville, I believe the first builders of flume-dredges in Alaska, Kimball & Saunpe, did not have this in mind, but took the natural course of designing a machine that would float, excavate, and dump into a flume.

THE FLUME-DREDGE. In principle the design is standard, except that a long flume replaces hopper, screen, tables, and stacker. The favorable conditions are shallow depth and loose gravel. These, together with the short life of the deposit, have made it possible to depart so far from standard construction that a first look at this dredge suggests a serious doubt as to its practicality. The construction is extremely light, in fact is almost flimsy, being built strictly for utility. One detail is original: In some machines the spuds are placed one-third the length of the hull forward so as to give a better distribution of tailing. All parts of the machine are in proportion. I shall mention only a few details. The lower tumbler is lubricated by a No. 2 grease-cup on top of the bearing. The digging-spud is made of wood with a steel shoe; the digging ladder is made of two light I-beams. The total weight is half that of standard construction, but the capacity is equal.

Operation is much the same as for a standard dredge and about the same crew is required, though there is no screen and stacker. The flume requires attention when slabby rocks are encountered. This flume is equipped with an undercurrent that removes the fine, but it is doubtful if the saving is as high, especially with fine gold, as with the screen type. It saves all nuggets, and, admitting that the loss is greater, this loss could easily

be less than the additional cost of a screen-dredge.

The advantages of the flume type are: low first cost, rapid construction, low operating-cost, light draft (usually 28 to 30 inches), and ease in dismantling before moving. One builder has made a feature of a design that permits of quick dismantling and assembling, and reduces the loss of timber to almost nothing. In addition to the main framing being bolted, the hull-planks are bolted instead of spiked.

THE SCREEN-DREDGE. The screen-dredge on Seward peninsula follows closely to the standard design, in fact, many of them are of Californian design with no modifications. Some of them fit the conditions under which they are operating, while others are both too heavy and too strongly built. The most common mistake has been a natural one, the draft. In the States, draft is never an item of design on account of greater depth of deposit. A common argument against the screen-dredge is its loss of nuggets. This is taken care of successfully, I believe, by providing an area of large holes at the lower end of the screen. As to gold-saving, the standard table-area is larger than necessary; the gold, though it may be fine, is heavy, and lodges within 4 feet of the screen. The screen-dredge has its field, a choice between the two depending on the conditions.

DREDGING DIFFICULTIES. These, in Alaska in general, and on Seward peninsula in particular, are fairly well known but always magnified. Difficulties mean high cost, but not necessarily prohibitive cost. There are certain fixed facts that must be faced, namely: a working period of four, or at most, five months out of twelve; high wages and freight. The short season means sufficient time in the idle months to put the dredge in condition for continuous operation during the working period. It also means more or less grief in the winter time, if the dredge is not properly laid up, by reason of damage to the hull or machinery. The high wages means an efficient crew, but not quite proportionate to the wages.

Other conditions that affect yardage and cost are serious breakdowns that cannot be anticipated, shallow ground, and power. It is necessary to carry a complete

steps, 1 part for quick replacements during the operating season. There are no shops on the peninsula except at Nome. The ordinary dredge is equipped only with tools for light work.

Shallow ground means frequent steps and it may mean also difficulties in flotation. With a given width of cut and capacity of dredge the advance is naturally faster in shallow ground. This means lost time from stepping and moving lines, but not so much as might be thought, for little digging time is lost, as the ladder is hoisted only a few feet and lines are light and easily moved. If however, the ground is too shallow it may mean digging into bedrock for flotation or building dams to raise the water-level. In such a case the dredge of minimum draft decreases the depth of bedrock removed, or decreases the height of dams. A certain clearance is necessary under the hull, and in making this allowance the well-hole spill must be taken into account. As dredges are built, the open line has much less spill than the closed line. Digging barren bedrock is not profitable. It is much cheaper to build dams, although this may entail to the inexperienced a prohibitive cost. Dams can be built comparatively cheaply. A brief description of dam construction may be of interest, for as with every kind of work, there is an efficient method and an inefficient.

Coal-sacks are filled with gravel two-thirds full, the ends are left open and laid with broken joints in a wall. One tier will hold against 2 ft. of water. As the height increases the dam is braced with sack buttresses; 50 sacks will build 45 sq. ft. of dam, or a wall 15 ft. long and 3 ft. high. When the dam has served its purpose the sacks are emptied and re-used. An intelligent crew with good wheelbarrows and 'run-planks' becomes quite expert at this heavy work. Where the water has to be raised an average of 2 ft. for an entire season, the cost is $1\frac{1}{2}$ to 2c. per cu. yd. dredged. Three factors determine the cost of such a dam: depth to bedrock, grade of ground, and filling for sacks.

The flume-dredge has proved suitable for shallow ground where flotation is a problem.

I shall attempt no further comparison between the screen-dredge and the flume-dredge. Conditions determine which is best suited. The flume-dredge is a new type, and has been adapted to unusual conditions.

POWER. Gas-engines, or, more properly speaking, internal-combustion engines, furnish power except in the case of two boats at Nome that use electricity. In all cases except one, the power-plant is on board and consists of one or two engines. In the latter instance one of them drives only the pump. Both the vertical and horizontal types are used and each has its good points. There is one installation of Bolinder engines using a mixture of common fuel-oil and distillate; one installation of Mietz & Weiss engines uses a light gravity fuel-oil; and one Dow-Diesel shore-plant consumes a light fuel-oil. The others are gas-engines of different makes burning distillate.

The internal-combustion engine has proved satisfactory, but in many respects does not equal electricity.

The requirements for an engine are severe: a continuous and variable load for 21 or 22 hours per day for four months shows up the weak spots. This type of engine is not nearly as well designed and as fool proof as the average automobile engine. But at worst, I believe troubles with the engineer are more frequent than troubles with the engine. Just when and where the first gas engine for dredge-work was used, I do not know, but such installations elsewhere are few, as nearly all dredges are accessible to electric power. With proper installation, the internal-combustion engine should compare with electricity, except in districts of very low rate, favorably both in cost and reliability.

Application of power with internal-combustion engines is different from that of electricity with individual drives. Each machine must be equipped and operated with a clutch. Dredge manipulation is not as flexible, but it could be made nearly so. For example, the bucket-line must at all times run at a constant speed; also the winches, which usually have two fixed speeds. It requires a little closer attention on the part of the winchman and entails more work. An overload may slow down the bucket-line and also the engine to the point of stopping, and starting a gas-engine is frequently not easy. The most important feature of an engine for a dredge is an efficient governor, as there are sudden extreme variations.

An interesting feature in connection with the light power-drill and the flume-dredge is that men inexperienced in dredging elsewhere led the way and developed them.

Mineral Production of Italy

During 1914 the output was valued at \$18,628,343, an increase of \$139,715, according to a Consular Report. The following table gives the quantity and value of the principal ores:

| Mineral | Metric tons | Value |
|-------------------|-------------|-----------|
| Antimony | 555 | \$ 7,293 |
| Copper | 88,953 | 318,181 |
| Gold | 205 | 21,588 |
| Iron | 796,246 | 2,131,842 |
| Lead | 45,538 | 1,759,167 |
| Manganese | 1,649 | 10,947 |
| Pyrite | 335,531 | 1,511,953 |
| Quicksilver | 119,223 | 736,321 |
| Zinc | 145,914 | 2,703,191 |
| Graphite | 8,567 | 50,151 |
| Petroleum | 5,542 | 267,401 |
| Sulphur | 2,371,795 | 5,699,199 |

SHANGHAI is the largest trading port in China. With a population estimated at a million people it has a considerable foreign colony, serving as a distributing point for the goods of many European and American business houses. Being close to the mouth of the Yangtze river, in which valley the British have important interests, there are many English-speaking people in the vicinity, and several English periodicals are published at Shanghai. The stock of silver at Shanghai is always large, generally about 60,000,000 ounces.

Flotation Practice in Missouri

By L. A. Delano

The flotation process was introduced by the St. Joseph Lead Co., at Flat River, Missouri, in the spring of 1914 for the purpose of treating slime. In the early days of the company all of the lead in the slime was lost, being washed into Big river through the mill-races. Later Frue vanners and slime-tables were used to treat a portion of the slime. The recovery was very small, however, compared with that obtained now by flotation.

The ores milled by the company consist mainly of disseminated galena in a gangue of dolomite. A small amount of pyrite, chalcopyrite, and blende are present in some of the ore. It is easily crushed and, the galena being soft, slimes readily. The ore is crushed to pass through 9-mm. screens, and is treated by jigs and tables. The overflow from the classifiers was the portion to be treated by flotation.

The Minerals Separation process was adopted, and flotation plants were built both in the Bonne Terre and the Leadwood mills of this company. The Doe Run Lead Co., a subsidiary, also installed a plant in the Rivermines mill. Each plant was similar, consisting of Dorr tanks for thickening slime, and a Minerals Separation machine for producing the froth.

The Bonne Terre mill produces the largest proportion of slime, it being approximately 20% of the ore milled. The plant there consists of four Dorr thickeners 8 ft. deep and 40 ft. diameter. They handle about 2800 gallons of water per 24 hours, containing approximately 2% solids, or an average of 400 tons of dry slime per day. The speed of the rakes is a revolution in 10 minutes. The slime settles readily, and the tanks maintain a clear overflow, which is used again for mill-circuit water. The thickened pulp averages 25% solids.

The agitation-froth machine contains 16 compartments. The thickened pulp from the four Dorr tanks is brought by pipe to a mixing-box at the head of the machine. The pulp passes through each compartment, froth being removed from the 'spitz' in front of each cell. The impellers are run at 290 revolutions per minute. Various speeds have been tried, but, for the power consumed, this produces as good a result as at the plants that use speeds of 320 and 350 r.p.m. The power consumed at Bonne Terre is 4.5 hp. per cell.

A crude hardwood creosote oil is used. Various oils and mixtures were tried, but none proved as satisfactory. The oil is fed to the machine in alternate compartments by a small 8-cylinder pump, driven from the line-shaft of the impeller-drive. Oil consumption is approximately 0.8 lb. per ton of dry slime treated, or a gallon of oil per ton of concentrate.

The feed to the flotation plant consists of slime of which approximately 90% is finer than 150-mesh. Material coarser than this is more economically treated on tables. The lead assay of the pulp varies at the different mills. At Bonne Terre it averages 5%. The tailing

from the flotation machine averages 0.7% lead. About 88% recovery is maintained. The grade of concentrate averages 52%. The sulphides froth easily, producing large bubbles averaging 65% moisture.

When the plant was installed a mechanical rake was used to remove the froth as fast as it was formed. Later this rake was abandoned and the froth allowed to run over the edge of the 'spitz,' with results fully as good. The froth is broken up in launders and in the pump-box by a fine spray of clear water.

The concentrate was formerly pumped to settling-vats equipped with steam-coils. When a vat was loaded it was allowed to settle for four to five hours, the clear water was syphoned off, and the pulp dried by steam to 20% moisture. The concentrate was then shoveled into cars and shipped to the smelter.

In the summer of 1915 experiments were made to find a method of handling the concentrate-pulp more economically. Settling tests showed that this pulp could be thickened from 90% moisture to about 30%. A small Oliver filter was then tried to determine if it would treat this thickened pulp. The tests were very satisfactory, cakes being formed with moistures as low as 8%.

Consequently a 38 by 6-ft. Dorr tank for thickening the pulp and a 12 by 11½-ft. Oliver filter were installed to handle the flotation concentrate, and thus abandon the steam-drying vats. The filter was started in February, 1916, and has run continuously since. The pulp pumped to the Dorr tank contains 10% solids and is thickened to 65% solids. The rakes are operated at a speed of a revolution in 30 minutes. The pulp is fed into a well in the centre of the tank in which a fine spray is used to break up most of the froth. A baffle-ring extends around the tank near the overflow to prevent the escape of froth.

The Oliver filter receives a pulp averaging 35% moisture. The cake is fairly uniform, being about $\frac{3}{16}$ in. thick, and averaging 13% moisture. The filter is operated with a speed of a revolution in 6½ minutes, and is driven by a 2-hp. motor. The vacuum is obtained by a No. 5 Roots vacuum-pump driven by a 35-hp. motor, and averages 25 inches of vacuum. The actual horse-power consumed is about 30. The pressure or 'blow' compartment on the filter is directly under the scraper.

As yet filtration in this region is in its infancy, the Bonne Terre mill having the only filter in the district. A filter-plant will be installed at both the Leadwood and Rivermines mills.

The St. Joseph Lead Co. treats 700 tons of slime per day by flotation in its two mills, while the Doe Run Lead Co. treats 500 tons. This approximates 15% of the ore milled. The tailing and grade of concentrate at the two plants are about the same.*

The laboratory at Bonne Terre has been equipped with testing-machines of both the Hoover and Jamney types. An extensive series of tests is being conducted to determine the best oils, size of slime, recovery, etc. Canvas tests are being made with the small filter to determine if lower moistures are possible. Tests are also being continued to obtain a higher grade of concentrate.

Working Data on Electrolytic Precipitation

By P. H. Crawford

IN writing this paper it is with the hope that it may be the means of bringing forth other data that may have been accumulated by those directly associated with the actual working of the process. No doubt there are many who have watched the process in all its stages and have noted many things that were of interest, and if all the data were brought together, with the ideas of each operator added, it might throw a flood of light on this method of precipitation and might prove the means of extending its usefulness.

After reading the able article* by Mr. G. H. Clevenger, in which he thoroughly covers the subject up to and including the first six years of its installation at the Minas Prietas works, I venture to give information covering a later period, for, with the knowledge gained during the previous six years, we were enabled to make many changes that not only gave us a better product to smelt, but were the means of reducing the cost.

As stated by Mr. Clevenger, the clean-up at Minas Prietas was crude, by reason of the way in which the boxes were built, but this was somewhat improved on making arrangements to treat some refractory tailing, the whole box-system being changed during the shut-down necessary in order to convert the mill to an all-sliming process, which was essential for this tailing, a rough analysis showing the following base metals: manganese 2.7%; iron 2.8%; copper 0.24%; and lead a trace. About 25% of the silver was locked up with the manganese.

The chemicals consumed, per ton of tailing, during the year covered by this article, were as follows: cyanide 4.5748 lb., 100% KCN, and lime 12.32 lb. Lead acetate was tried, but it did not help in lowering the residues or reducing the cyanide consumption; but, strange to say, on 90% of the alternate charges that were so treated, using from 0.5 to 1.5 lb. per ton of tailing, it gave a higher residue.

During the shut-down the four boxes used for slime-solution precipitation were cleaned out, all the up and down guide sticks being removed, the adhering calcium crust scraped off, those in good condition being replaced and the balance made up from new strips. On replacing, the spaces were increased to hold 20 anodes and 21 cathodes; this reduced the distance from centre to centre and lowered the voltage. The change to more cathodes and less anodes was due to the fact that by starting with a cathode and ending with one we saved two tons of lead and secured the same plating surface. The boxes, as has been stated, were in tandem, in the first two all the compartments were filled, each with 20 anodes

and 21 cathodes, and wired in series of three. This gave 960 sq. ft. per series and 0.3646 ampere per sq. ft. of plating surface, when using 350 amp. In the last two boxes, only the first 8 compartments were filled and these wired in series of 4, thus giving 1280 sq. ft. of surface and at 350 amp. gave 0.2731 amp. per square foot.

The monthly record is shown in Table I, after the boxes had been in operation six months. This shows the great variation from month to month in cyanide regenerated, alkalinity loss, and percentage of metal precipitated, nothing being constant except the ratio of gold and silver precipitated.

To arrive at the average work during a year, the following résumé has been made from the various data:

TABLE II

| Average of 12 months' operation. | | |
|--------------------------------------|-------------|-------------|
| | Gold | Silver, Oz. |
| Head assay-value solution..... | \$1.5835 | 1.2347 |
| Tail assay-value solution | 0.3587 | 0.2613 |
| Value precipitated | 1.2248 | 0.9704 |
| Percentage precipitated | 77.347 | 78.594 |
| | Cyanide | Alkalinity |
| | % | % |
| Head solution tested | 0.04369 | 0.041783 |
| Tail solution tested..... | 0.05997 | 0.035566 |
| Amount cyanide regenerated..... | 0.01628 | |
| Amount alkalinity loss..... | | 0.006217 |
| Percentage cyanide regenerated | 37.262 | |
| Percentage alkalinity loss | | 14.879 |
| | Copper, % | Zinc, % |
| Head solutions assayed | 0.0851 | 0.0069 |
| Tail solutions assayed..... | 0.0730 | 0.0066 |
| Electric current used | 334.25 amp. | 33.08 volts |

In the above table is given the average copper and zinc carried by the head and tail solutions, these not being shown monthly as I had failed to so enter them in my notes, but are the average for the year.

The resulting tail solution was too rich to use as a wash in the slime filter-press, though followed by a good water-wash, so a small 9-compartment zinc-box was placed at the foot of the electric boxes, in the first 8 compartments zinc shaving being used, cut from No. 9 sheet. Fifty to 75 tons of solution were passed through this box in 24 hours. A daily consumption of 10 to 12 lb. of zinc took place. This box was cleaned daily when treating 75 tons and every second day when passing 50 tons. Above the screen each compartment measured 18 by 28, and 18 inches deep. Table III shows a year's work by this small zinc-box.

The cathodes were of tin-plated sheet-iron and the anodes were of two kinds, as mentioned by Mr. Clevenger, lead sheet and lead rods, both being the same as used at Virginia City, except that the 4-in. lead ing stood up 4 in. above the anodes. These anodes were peroxid-

*The Electrolytic Precipitation of Gold, Silver, and Copper from Cyanide Solutions, M. & S. P., Nov. 13, 1915.

TABLE I

| Monthly average | April | | May | | June | | July | |
|-------------------------------------|----------|-------------|-----------|-------------|----------|-------------|----------|-------------|
| | Gold | Silver, Oz. | Gold | Silver, Oz. | Gold | Silver, Oz. | Gold | Silver, Oz. |
| Head value solution..... | \$1.889 | 1.945 | \$1.635 | 1.557 | \$1.939 | 1.707 | \$1.780 | 1.360 |
| Tail value solution..... | 0.419 | 0.382 | 0.318 | 0.260 | 0.378 | 0.293 | 0.221 | 0.170 |
| Value precipitated..... | 1.470 | 1.563 | 1.317 | 1.297 | 1.561 | 1.414 | 1.559 | 1.190 |
| Percentage precipitated..... | 77.82 | 80.36 | 80.55 | 83.30 | 80.51 | 82.84 | 87.58 | 87.50 |
| | Cyanide | Alkalinity | Cyanide | Alkalinity | Cyanide | Alkalinity | Cyanide | Alkalinity |
| Head solution tested..... | 0.0443 | 0.0369 | 0.0436 | 0.0331 | 0.0420 | 0.0327 | 0.0380 | 0.0250 |
| Tail solution tested..... | 0.0727 | 0.0330 | 0.0620 | 0.0306 | 0.0606 | 0.0250 | 0.0585 | 0.0180 |
| Percentage cyanide regenerated..... | 64.108 | | 42.202 | | 44.286 | | 53.947 | |
| Percentage alkalinity loss..... | | 10.569 | | 7.553 | | 23.547 | | 28.000 |
| Electric current used..... | 350 amp. | 34.5 volts | 350 amp. | 34.0 volts | 350 amp. | 33.0 volts | 330 amp. | 32.5 volts |
| | August | | September | | October | | November | |
| | Gold | Silver, Oz. | Gold | Silver, Oz. | Gold | Silver, Oz. | Gold | Silver, Oz. |
| Head value solution..... | \$1.704 | 1.264 | \$1.700 | 1.100 | \$1.430 | 0.888 | \$1.437 | 0.960 |
| Tail value solution..... | 0.311 | 0.232 | 0.339 | 0.208 | 0.338 | 0.206 | 0.312 | 0.208 |
| Value precipitated..... | 1.393 | 1.032 | 1.361 | 0.892 | 1.092 | 0.682 | 1.125 | 0.752 |
| Percentage precipitated..... | 81.75 | 81.65 | 80.06 | 81.09 | 76.36 | 76.80 | 78.29 | 78.33 |
| | Cyanide | Alkalinity | Cyanide | Alkalinity | Cyanide | Alkalinity | Cyanide | Alkalinity |
| Head solution tested..... | 0.0386 | 0.0293 | 0.0357 | 0.0288 | 0.0417 | 0.0382 | 0.0512 | 0.0464 |
| Tail solution tested..... | 0.0580 | 0.0204 | 0.0496 | 0.0186 | 0.0589 | 0.0355 | 0.0618 | 0.0339 |
| Percentage cyanide regenerated..... | 50.259 | | 38.935 | | 41.247 | | 20.703 | |
| Percentage alkalinity loss..... | | 30.375 | | 35.416 | | 7.310 | | 14.009 |
| Electric current used..... | 305 amp. | 31.5 volts | 310 amp. | 32.0 volts | 310 amp. | 32.0 volts | 318 amp. | 33.0 volt. |
| | December | | January | | February | | March | |
| | Gold | Silver, Oz. | Gold | Silver, Oz. | Gold | Silver, Oz. | Gold | Silver, Oz. |
| Head value solution..... | \$1.464 | 0.985 | \$1.280 | 0.870 | \$1.320 | 1.074 | \$1.424 | 1.106 |
| Tail value solution..... | 0.445 | 0.302 | 0.380 | 0.260 | 0.382 | 0.300 | 0.461 | 0.351 |
| Value precipitated..... | 1.019 | 0.683 | 0.900 | 0.610 | 0.938 | 0.774 | 0.963 | 0.755 |
| Percentage precipitated..... | 69.60 | 69.34 | 70.31 | 70.11 | 71.06 | 72.07 | 67.62 | 68.26 |
| | Cyanide | Alkalinity | Cyanide | Alkalinity | Cyanide | Alkalinity | Cyanide | Alkalinity |
| Head solution tested..... | 0.0466 | 0.0600 | 0.0442 | 0.0595 | 0.0495 | 0.0517 | 0.0489 | 0.0597 |
| Tail solution tested..... | 0.0634 | 0.0550 | 0.0547 | 0.0550 | 0.0600 | 0.0417 | 0.0594 | 0.0541 |
| Percentage cyanide regenerated..... | 36.051 | | 23.756 | | 21.212 | | 21.472 | |
| Percentage alkalinity loss..... | | 8.333 | | 7.563 | | 19.342 | | 9.380 |
| Electric current used..... | 340 amp. | 33.0 volts | 350 amp. | 35.0 volts | 350 amp. | 34.0 volts | 350 amp. | 32.5 volts |

TABLE III

Zinc-box average of 12 months.

| | Gold | Silver, Oz. |
|-----------------------------------|-----------|-------------|
| Assay-value head solutions..... | \$0.1450 | 0.3020 |
| Assay-value tail solutions..... | 0.0052 | 0.0039 |
| Values precipitated..... | 0.4398 | 0.2981 |
| Percentage precipitated..... | 98.83 | 98.71 |
| | Cyanide | Alkalinity |
| | % | % |
| Head solutions tested..... | 0.0634 | 0.0550 |
| Tail solutions tested..... | 0.0550 | 0.0690 |
| Amount cyanide lost..... | 0.0084 | |
| Amount alkalinity gained..... | | 0.0140 |
| Percentage cyanide lost..... | 13.219 | |
| Percentage alkalinity gained..... | | 25.454 |
| | Copper, % | Zinc, % |
| Head solutions assayed..... | 0.079 | 0.0068 |
| Tail solutions assayed..... | 0.073 | 0.0108 |

ized in a 1% solution of potassium permanganate to which was added 1% H₂SO₄. When we first began using the lead rods we found they did not last as long, or rather showed signs of deteriorating sooner than they should; this was thought to be due to the rougher surface of the cast-rod. A two-size grooved double wheel-roll was made, the first size slightly smaller than the cast-rod; by the use of two cranks these rolls were turned by hand and the rods passed through the rolls up to the

shoulder and back, then through the smaller and back. With this treatment they received the same surface as the plates and gave as good results. We soon found that the frames got loose and out of shape, so it became necessary to tack wooden strips diagonally across the crate, one on each side. These anodes were peroxidized in a box made to treat three at one time, in which four heavy lead anodes were hung; for while being peroxidized the anode takes the place of a cathode. This box was made to hold just a ton of solution when two inches above the top of the anodes; it was thus an easy matter to make up fresh solution, or add the amount of permanganate necessary to bring it up to standard, or replace the water being broken up by the current. This box was 2 ft. 4 in. wide, 3 ft. long, and 4 ft. 9 in. deep.

Many substances were tried for anodes, some with strange results. Graphite was tried, both in slab and rod shape; in both cases we found that they would not last long. For the first few days they would remain, so far as one could note, in about the same condition as when first submerged, but later they would begin to disintegrate just below the surface of the solution. On painting this section with P & B paint the disintegration would take place just below the paint. It would appear from the above that there was more resistance in the graphite than there was in the solution and the

greater part of the current left the anode at the first opportunity.

Pure tin plates were tried, these were $\frac{1}{16}$ inch thick, they were fastened to a wooden top strip the same as used on the lead sheet anodes, but without lugs, and in place of the No. 14 bare copper wire with which the anodes and cathodes were attached to the 1 by $\frac{1}{16}$ in. copper cross tapes, a piece of insulated copper wire was soldered to the corner and this passed through the lug hole. Three of these were tried, receiving the same peroxidizing treatment as the lead ones, which gave them a steel blue color. After a month they were in the same condition as when first placed in the boxes, except for a slight white crust on the outside. Sixty of these plates were ordered and as fast as made ready they were put in the boxes in place of the lead ones, which were from time to time removed; these remained in good condition, the cathodes on both sides showing as much precipitate adhering as those opposite the lead ones. These 60 tin-plates now being ready, on the first clean-up day they were all collected and placed in a series by themselves. Greatly to our surprise, on the third day we found that over one-half of them were more than half-gone and the others badly pitted, having holes clear through them. Of course, they all had to be removed. What tin was left was smelted down and mixed with lead, $\frac{2}{3}$ of the former being added to $\frac{1}{3}$ of the latter, this making a good solder, which was cast in the rod mould, made to cast six at one time. Having as much solder as we could use on the boxes for several years and thinking it worth while to test this mixture, two frames were fitted with 12 of these rods and put in the boxes as anodes, two years later when the plant was shut-down these two anodes were in very good condition. Had there been enough to fill one series there is no telling but what they would have met the same fate as the pure tin anodes.

When the plant began using lead anodes they were ordered direct, coming in just the right size. These lasted a long time, many for over three years. Later, having accumulated many discards they were smelted in a reverberatory furnace and the clean lead run into moulds. These pigs were melted in an iron pot, in both cases using wood for fuel, and cast into slabs $\frac{1}{2}$ by 12 by 24 inches. A set of rolls was placed in commission and when these slabs were passed through eight or ten times the result would be a large sheet of rolled lead that was cut-down to the size needed for an anode, which was 25 by 48 inches. The dross, which was a mixture of slag and litharge, was ground in a ball-mill, sampled, and shipped to the smelter. I am unable to find in my notes the assay-value of this product, but it carried about \$100 in gold and silver.

It was noted, as time went on and the old lead was used over and over again, that the resulting anodes did not last as long as when new lead was used; this was supposed to be due to the gold, silver, and copper carried by the lead, these metals being, by the action of the current and cyanide, re-dissolved, leaving the anode with a pitted surface and more liable to dissociation. As for the gold and silver, it was thought there was no real loss,

for the reason that on returning the anodes to the boxes these metals would be recovered about as fast as others were being tied up.

After a time the sheet-lead anodes would become hard and brittle, and when one became buckled and was removed to be straightened it was hard to bend it. When they became so old that they would start to crumble, it was found that by placing them flat on the floor and beating with a hammer a hard brown crust about $\frac{1}{16}$ -inch thick would crack off each side, leaving a thin sheet of metallic lead. A shipment of this crust assayed \$33.07 gold and 66.80 oz. silver.

On starting to clean a box, the solution was turned off, the current was by-passed through an insulated one-inch cable by using a knife-switch. The cathodes were then rubbed down with a brush and the box allowed to settle for two hours. About two-thirds of the way down wooden plugs were fitted into each compartment; these were first removed and the solution drawn down to this level; bags made from drilling were then tied over $1\frac{1}{2}$ -inch iron cocks, which were about eight inches from the bottom; when the solution had drained down to these, iron cocks on the opposite side, which were flush with the bottom and drained into a wooden launder running to a cement sump, were opened and all the product that would run was flushed to this sump, which was connected by pump to a small filter-press. Four anodes and five cathodes from the centre of each compartment were then removed to allow men wearing rubber boots to enter and with scoops and small hoes fill buckets with the settled precipitate, the buckets being passed up to a man outside. Three men worked at one time, one in each compartment, taking about an hour to each compartment or four hours for a whole box. The outside man carried the precipitate to a small iron tank, fitted with a filter-bottom and having mechanical agitators driven by the same motor that ran the filter-press pump. Inside this tank was a small box that had a 10-mesh screen for a bottom, all the precipitate being passed through this box by using a water hose. Any calcium crust or pieces of broken anodes were thus kept out, and on being washed were piled to one side. In the tank was fitted a $1\frac{1}{2}$ -inch pipe for a decanter; when the level of the wash-water reached within a foot of the top, this decanter was lowered and the water, which, on account of the agitation carried the fine, was run to the filter-press. After a clean-up was finished the decanter was lowered and all the fine run to the press, the agitator was then stopped and the vacuum turned on and the precipitate dried to within 20% moisture; it was then removed to the dryer. Before installing this tank and screen-box much of the calcium crust and fine lead was smelted with the product.

As will be noted, the difference between 'heads' and 'tails' on the copper contents of solution was only 0.0071%; to try to remove a greater amount, a separate copper-box was installed in one of the lower unused compartments. This was wired in one series having 15 anodes and 16 cathodes which received the whole current and, when using 350 amperes, gave 1.46 amp. per sq. ft.

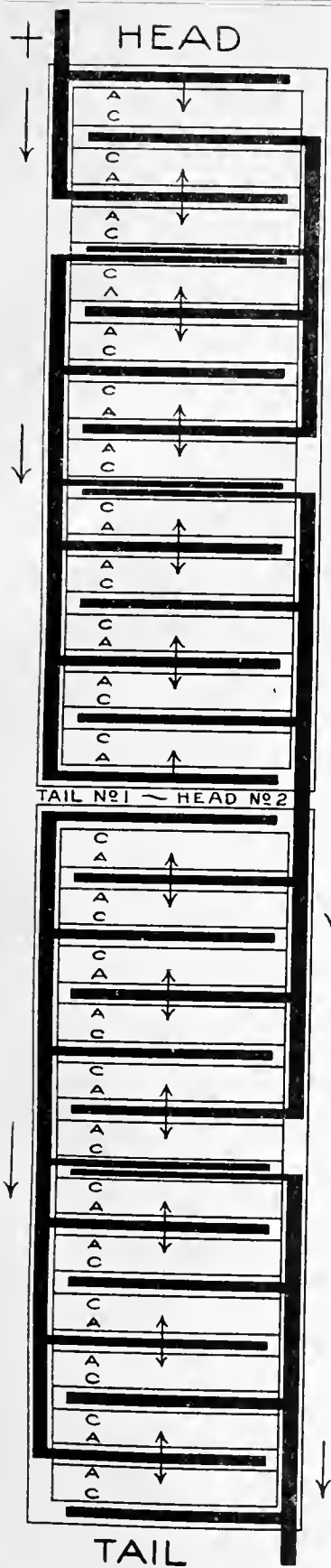

The first is wired in series of three. 60 anodes and 63 cathodes, giving a plating-surface of 960 sq. ft. Using 350 amperes = 0.3646 amp. per square foot.

The second is wired in series of four. 80 anodes and 84 cathodes, giving a plating-surface of 1280 sq. ft. Using 350 amperes = 0.2734 amp. per square foot.

The third and last in the head box is wired in series of five. 100 anodes and 105 cathodes, giving a plating-surface of 1600 sq. ft. Using 350 amperes = 0.2188 amp. per square foot.

The first in the second box is wired in series of six. 120 anodes and 126 cathodes, giving a plating-surface of 1920 sq. ft. Using 350 amperes = 0.1823 amp. per square foot.

All the anodes and cathodes in the above are spaced 3 in. apart.

The second is also wired in series of six, but the anodes and cathodes are spaced 2.5 in. apart, giving 24 anodes and 25 cathodes to each compartment. 144 anodes and 150 cathodes, giving a plating-surface of 2304 sq. ft. Using 350 amperes = 0.1519 amp. per square foot.

If a special box were built with 13 compartments, the last could be wired up in series of 7 and spaced 3 in. from anode to cathode, giving 224 sq. ft. of surface and using 350 amperes would equal 0.1562 amp. per square foot.

out of the precipitate and in case of buckling with this high current diminish the chances of a short circuit. The head solution assayed 0.072% copper and the tail 0.069%. The resulting precipitate gave 76% copper and 13.40% gold and silver combined. After running about a month we did not think the recovery warranted the power consumption necessary to precipitate, so this compartment was cut out.

In the day-time when an anode buckled, which was not often during the last few years, or when precipitate lodged between the cathode and anode, and a short circuit was caused, the connecting copper wire would smoke if it was a bad short-circuit, the smoking being caused by a little candle-grease, which would adhere to the wire as they were daily passed over with a candle attached to a stick to locate warm wires. At night if a bad short-circuit took place it would be noted by the wire becoming hot and showing a dull-red light. When the anode was new the buckled centre could be pressed back in place by inserting a wooden stick between the buckled anode and the cathode, and forcing it back into shape.

The main copper tapes along the sides of the boxes that carried the whole of the current were $1\frac{1}{4}$ by $\frac{1}{4}$ in. and those running crosswise were 1 by $\frac{3}{16}$. The latter were bolted to the main tapes and then soldered on both sides. These tapes would carry the current without getting hot or warm, unless a poor connection was made.

In the last empty compartments there was formed over the surface of the solution a crust, in thickness from a film to $\frac{1}{16}$ in. and in color from white to a light-lemon tinge, the thickness depending on the length of time it remained undisturbed. On punching several holes in the crust, to allow the solution to come on top, it would break off in slabs and sink to the bottom. A rough analysis gave 72.5% CaCO_3 and 1.3% Cu and assayed \$76.89 gold and 74.78 oz. silver. No crust was formed on the last compartment or, if formed, it was carried away before it could make a film, as the solution overflowed the whole length of the end into a launder. No crust was formed in the compartments in use, due no doubt to the disturbed condition of the surface, which was caused by the gases being given off, oxygen at the anode and hydrogen at the cathode. These gas bubbles as they came to the surface seemed to burst and would throw a fine spray of solution upward, this spray was hard on the connecting copper wires, for it was at this point that they would give way first, it being harder on the cathode wires than the anodes, which were protected by the 4-in. lead lug. P & B paint was tried, but did not last long, and could only be renewed when the cathode was out of the box, as it would not adhere on a wet surface.

The best precipitate, both as regards percentage of metal and the ratio of gold and silver to copper was always found in the head compartments and would diminish throughout the remainder of the compartments. To try to overcome as much as possible the precipitation of calcium that seems to take place when the metal contents of the solution diminish, the writer suggests the wiring shown in the accompanying diagram.

As will be seen the two boxes are placed in tandem,

The anodes were made just the same as the others but were $\frac{1}{4}$ in. thick, both the anodes and cathodes being attached by a $\frac{1}{4}$ -in. copper wire to lower the resistance. The anodes were enclosed in sacking to keep any lead

the first is wired in series of 3, the next in 4, followed by 5, the last two both being in series of 6, but the last six compartments have 24 anodes and 25 cathodes, this spaces the anodes and cathodes 2.5 in. apart, but as the current will be very low there should be little danger of buckling and thereby short-circuiting. This should not only lower the amount of calcium precipitated, but give longer life to those anodes receiving such low current.

The cathodes take on a plate of copper and, of course, some silver and gold, but if this is not scraped with some sharp instrument they will last during the life of the average plant. However, the iron once being exposed they soon become pitted and by handling begin to break.

During the year covered by this account there was treated an average of 4920 tons of tailing per month, with an average of 1:3 of solution; there was precipitated about 492 tons of solution per day, the yearly average showed a saving in cyanide of 0.01628% per ton of solution, which would be 160 lb. per day, or 4800 lb. for a 30-day month, which at 20c. would make a total saving of \$960.

The total amount of new lead used during this year was 8677 lb. The total amount in use in the boxes approximately 80,000 lb. If the average life of an anode is two years, and there is no doubt that by using the recovered lead over again it will last that long or longer, then the consumption of lead would be not over 40,000 lb. per year or 3333 lb. per month, which at 5c. per lb. would be \$166.65 per month.

During this year I have the costs for only one month's operations and during this period we treated 5360 tons of tailing; the costs were as follows:

| | Labor | Supplies |
|--------------------------|----------|----------|
| Labor | \$209.25 | |
| Power | 38.35 | \$135.67 |
| Supplies | | 34.96 |
| Repairs | 16.75 | 1.75 |
| | \$264.35 | \$172.38 |
| Total | | \$436.73 |
| Total labor and supplies | | |

As the cost was low for supplies in this month, no doubt a small lead charge was made, perhaps not over 500 lb., but by adding the lead average found above \$166.65, this would give \$603.38, which is high on account of the charge included in the total supplies, but on the average monthly tonnage this would be 12.3c. per ton of tailing. When one stops to think of the saving in cyanide, the actual cost for precipitation was nothing, had the saving been credited to the department whence it was derived.

The generator used was a type G 30 V, 500 amp. speed 750, built by the Eddy Electric Manufacturing Co. and was run by a straight-line steam-engine of 25 hp., making 272 r.p.m. Power cost, including labor and supplies, was about \$10 per hp.-month, which was high, owing to the price of wood used for fuel.

COPPER production of Alaska from 13 mines in 1915 totaled \$6,509,312 lb., extracted from 369,600 tons of ore. The value was \$15,139,129; also \$153,121 gold and \$455,204 silver.

Tin Output

The tin production of the world is about 120,000 long tons annually. Over half of this comes from the Federated Malay States, while Bolivia contributes 18%. The Dutch islands of Banka and Billiton, in the Java sea just south-east of Singapore, rank next to Bolivia in importance. Cornwall produces 6000 tons annually, as do also South Africa and Nigeria combined, while Australia and China contribute 4000 tons each. Cornwall has been famous for tin since prehistoric times, and forty years ago its output was at the rate of 12,000 tons per annum. The North American continent produces practically no tin—only a trivial amount from Alaska. The bulk of the American consumption of tin—and the United States is the largest user of tin in the world—goes to make cans for preserving our plentiful output of salmon, beef, vegetables, fruit, etc. The valuable property of not tarnishing and of being resistant to the decomposing action of air, water, and the common acids and alkalis is what makes tin preferable for plating iron for making cans. Tin ore from Bolivia, unlike Straits tin, is said to contain iron, which lessens the adhesion of the tin to iron plate. This militated against the importation of Bolivian tin into the United States, until the method of electrolytic refining became practicable. The American Smelting & Refining Co., which recently completed a tin smelter at Perth Amboy, New Jersey, had the foresight to arrange with the Bolivian government to ensure that unfavorable tariffs for the export of tin concentrate from that country will not be enacted, as was done in the case of the smelter built in 1904 at Bayonne, New Jersey, to treat concentrate from the Malay States. The Bolivian minister of foreign affairs, it is understood, gave a signed note of assurance that no discrimination would be made by his government against the United States in the matter of export duties on tin or other metals. In early times, before the coming of the Spaniard, the natives of Bolivia made use of tin as an alloy with copper to make bronze. The copper they obtained from the Corocoro region of Peru, where, incidentally, the Anaconda Copper Mining Co. recently has been investigating mines and prospects. The tin of Bolivia is found associated with silver, and some of the mines were worked originally as silver mines.* The region lies at an elevation of 8000 to 17,000 ft. above the sea, being on the bleak Bolivian plateau. Previous to the War the smelting of Bolivian tin was divided about equally between Germany and England. Much of the Straits tin is smelted by the Straits Trading Co. on the island of Pulo Brani opposite Singapore. The Dutch government has a smelter at Banka, and markets its product both in Holland and Java. One reason why Straits tin has dominated the market is because most of it is recovered from alluvial deposits that are worked cheaply by Chinese labor and dredges. The Nigerian tin also is all of alluvial origin.

*See articles on Bolivian tin mines, by Francis Church Lincoln, M. & S. P., March 27, May 8, and July 24, 1915.



THE CYANIDE PLANT.

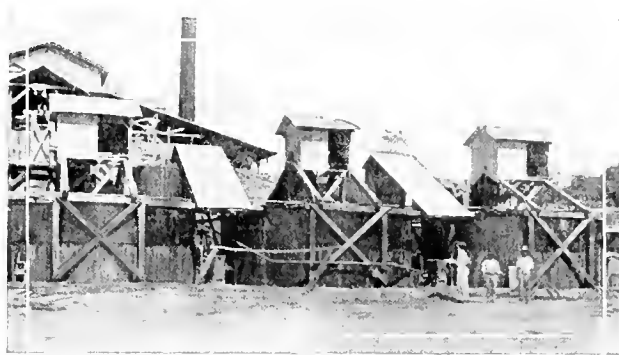

MECHANICAL AGITATORS.

Cyanidation at the Comacaran Mine, Salvador

By A. B. Peckham

INTRODUCTION. The mill of the Comacaran Gold Mining Co. is close to the village of Hormiguero, district of San Miguel, Salvador. To go to the mill you take a Panama steamer for the Port of La Union, on the Gulf of Fonseca. This is a journey of two or three weeks, depending on the number of ports of call. From La Union to San Miguel, a city of 30,000, is a 40-mile journey by rail. From San Miguel to the mill is 12 miles, the trip being made on mule-back. The country is comparatively level with low rolling hills, but the roads are such that no vehicle other than an ox-cart can be used. The other lines of communication between Hormiguero and the outside world include a Government telephone and telegraph line, a cart road to La Union, and a trail to the famous mines of Divisadero and San Sebastian.

THE ORE is an argentiferous sulphide containing 4 oz. of silver and 0.35 oz. of gold. The gangue is quartz and limestone. The associated minerals are pyrite, a little malachite, and iron oxide. The ore is extremely hard. It is brought to the bins by an aerial tramway. From this the ore is trammed by hand in side-tipping sand-cars to the mill-bin, which is of square type.

CRUSHING. The larger pieces of ore are fed by hand to a jaw-breaker of the Blake type, which crushes to 2 inches. Ore of less size is tipped directly into the mill-bin. The ore is fed to the stamps by Challenge feeders of the suspended type. There are 25 stamps, 15 of which are 1300 lb. each and the remaining 10 are 1280 lb. each. Dropping 7 inches at a rate of 108 drops per minute, the duty per day is 7 tons through 3-mesh screen. The stamps crush in a cyanide solution containing 1.5 lb. cyanide and 1.5 to 2 lb. lime per ton of solution. The shoes last 125 days and the dies about 140 days. Both are of forged steel.

TUBE-MILLING AND CLASSIFICATION. The pulp from the batteries flows to a Dorr duplex classifier. The slime from this classifier, which is free from sand, goes to one of two home-made thickeners. The sand is fed to two Allis-Chalmers tube-mills of the Tonopah type, together

with enough battery solution to make a mill-feed containing 60% of sand and 40% of solution. These mills are 4 by 20 ft. They revolve at 30 r.p.m. The sand-discharge from these two tube-mills is diluted with battery solution and flows to a Dorr simplex classifier. The sand from this goes to a 4 by 22-ft. Krupp tube-mill. The liners of this mill are corrugated cast-iron plates, that last six or seven months. The pulp-discharge from this mill is raised by a Frenier pump to the duplex classifier, taking the battery-pulp, thus closing the circuit. The slime-discharge from the simplex classifier, containing fine sand, flows to one of two Butters-Mein revolving distributors for the final separation of sand and slime. These distributors discharge the slime over rings in the centre.

SLIME TREATMENT. The slime from the collectors is raised by two Frenier pumps to the two home-made continuous thickeners. The slime is thickened to a pulp containing 25% dry slime, as this has been found the most economical and efficient dilution. The thickened pulp is raised to two mechanical agitators by air-lifts. These agitators are a combination of mechanical agitator and Parral tank. The circulation of the pulp, which is ordinarily done in mechanical agitators by means of pumps, is accomplished in these tanks by two air-lifts. It takes about 10 hours to fill one of these agitators. When one is filled, the amount of cyanide necessary to raise the pulp from 1.5 lb. cyanide per ton of solution to a strength of 2.5 lb. per ton, together with 10 lb. of lead acetate, is put into a basket suspended under the spout of one of the air-lifts. The air is then turned on and the pulp agitated for eight hours. At the end of the agitation the pulp is pumped to one of three Pachuca tanks. The agitator is now empty and ready to take the stream of pulp from the thickeners when the other agitator becomes full.

The slime is agitated further in the Pachuca tanks for 20 hours. Then pulp in these tanks is drawn off to the first of four Dorr thickeners in a counter-current continuous-decantation system. The time occupied in

lowering a Pachuca depends on the condition of the filling. Ten hours is the time generally occupied in lowering a Pachuca.

CONTINUOUS DECANANTION. There are four continuous thickeners used in washing the treated pulp. Three are 28 ft. Dorr thickeners and the other is home made. The thickeners are numbered 4, 5, 6, and 7. The pulp from the Pachuca tanks, which contains about \$1.50, together with the clear overflow of battery-solution from thickener No. 1, which contains \$1, goes to thickener No. 4. The clear overflow from No. 4 goes to the rich-solution tank, which assays about \$1.75 per ton. This rich-solution tank is labelled *L*. The solution then goes to a filter or clarifying tank *K*, thence through the zinc boxes to the barren-solution tank *L*. The underflow from thickener No. 4, which contains 40% of dry slime, flows to a Frenier pump, where it is mixed with the overflow of thickener No. 6 and raised to thickener No. 5. Before entering the latter the pulp is further diluted by a stream of barren solution from tank *E*.

The overflow from thickener No. 5, which contains value to the extent of \$0.50 per ton, goes to the battery-solution tank *J*. The pulp-underflow of No. 5, which contains 40% of dry slime, is mixed in a second Frenier pump with barren solution from tank *E* and with the overflow of thickener No. 7, which assays \$0.10 per ton, and is raised by the Frenier pump to thickener No. 6.

The overflow from No. 6, which contains \$0.25 per ton, goes to wash the underflow of No. 4, as stated above. The underflow goes to a third Frenier pump, where it is washed with a stream of water and raised to the last thickener in the series, No. 7. The overflow of thickener No. 7 goes to wash the underflow of No. 5, as stated above. The underflow of No. 7 runs to waste. This underflow contains 40% of dry slime that includes \$0.55 of insoluble metal. The 60% of moisture assays \$0.08 to \$0.10 and titrates 0.87 lb. cyanide and 0.75 lb. lime per ton of solution. The accompanying table shows the average results for two months. These are normal results.

the continuous sticking of the thickeners. Instead of changing the angle of the rakes on some of the thickeners, they were run at a speed of one revolution per two minutes. The thickening qualities were not impaired.

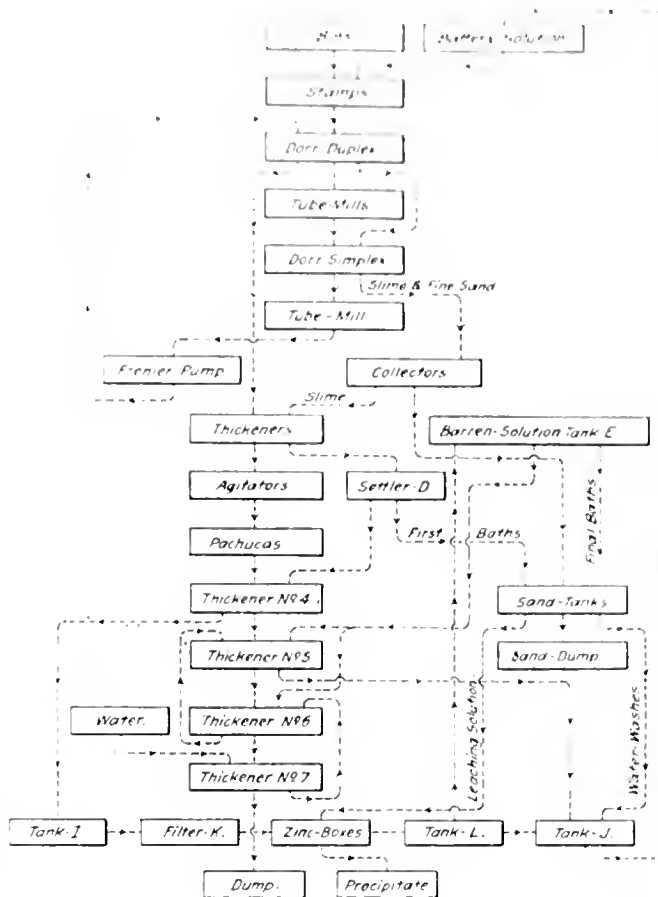

FLOW-SHEET OF COMACARAN MILL.

It was observed, contrary to the claim of manufacturers, that the thickened pulp came out purely by the hydrostatic head, the arms serving only to prevent the bottom from building up and to rake any hard slime that falls from the sides toward the centre.

JULY 1915

| | Solution-assays | | | | | Titration | | | |
|-------------------|-----------------|-----------------|-----------------|-----------------|-----------------|---------------------------------|-------------------------------------|---------------------|---------------------|
| | Thickener No. 1 | Thickener No. 4 | Thickener No. 5 | Thickener No. 6 | Thickener No. 7 | Tailing thickener No. 7 Residue | Tailing thickener No. 7 Undissolved | Thickener No. 7 KCN | Thickener No. 7 CaO |
| Gold, ounces... | 0.0266 | 0.0541 | 0.0171 | 0.0076 | 0.0028 | 0.0228 | 0.0183 | 0.8 lb. | 0.5 lb. |
| Silver, ounces... | 0.0148 | 0.4480 | 0.1500 | 0.0710 | 0.0410 | 0.3710 | 0.3310 | | |
| Value | \$0.79 | \$1.23 | \$0.42 | \$0.19 | \$0.08 | \$0.65 | \$0.54 | | |

JUNE 1915

| | Solution-assays | | | | | Titration | | | |
|-------------------|-----------------|-----------------|-----------------|-----------------|-----------------|---------------------------------|-------------------------------------|---------------------|---------------------|
| | Thickener No. 1 | Thickener No. 4 | Thickener No. 5 | Thickener No. 6 | Thickener No. 7 | Tailing thickener No. 7 Residue | Tailing thickener No. 7 Undissolved | Thickener No. 7 KCN | Thickener No. 7 CaO |
| Gold, ounces... | 0.044 | 0.0707 | 0.0208 | 0.0107 | 0.0038 | 0.0218 | 0.0174 | 0.87 lb. | 1.00 lb. |
| Silver, ounces... | 0.107 | 0.5008 | 0.1744 | 0.0826 | 0.0475 | 0.3835 | 0.3285 | | |
| Value | \$0.99 | \$1.73 | \$0.51 | \$0.26 | \$0.10 | \$0.64 | \$0.52 | | |

THE CONTINUOUS-DECANANTION system was put into successful operation only after several months of experiment and annoyance. In the first place the angle of the rakes had to be changed to 15° in place of 5° or 7°, as sent by the factory. This change was made necessary by

In the beginning, the pulp from the Pachuca tanks was run into the first thickener of the series with the idea of getting rich heads for the zinc-boxes. The solution from the first thickener was then \$3 to \$4 per ton. It was found that the remaining thickeners were unable

to bring the unwashed residue to within \$0.25 of the value of the washed residue. This difficulty was met and overcome by running all the clear overflow from thickener No. 1, which thickens the battery-pulp, into the first thickener of the series. This use of the battery-solution, besides lowering the pulp within practical limits, also causes all solution coming from the batteries to be precipitated before returning. The solution that goes to the battery-solution tank at the head of the mill is in this way brought down to \$0.25 or \$0.30, which is an advantage. The precipitation of the battery-solution also gives the great quantity of barren solution needed for the system.

The advantages of the system are:

1. Low operating cost.
2. A large and elastic capacity.
3. Extreme simplicity and freedom from the mess and work characteristic of slime filtration.

The disadvantages of the system are:

1. The enormous amount of barren solution needed in a plant using the system and necessity of precipitating a great amount of low-grade solution.
2. The impracticability of the system with slime that resists settling, such as some oxidized ores and ore from surface workings.
3. The ease with which the system is thrown out of adjustment by a sudden run of rich ore, especially if the system is being worked to capacity. Double the mill-heads and you have to double the amount of barren solution and water used, or be content to see your tailing doubled. Often the barren solution is not obtainable and the mill cannot assimilate more water.
4. A large amount of water is used and run to waste.

In conclusion it can be said that owing to the low operating cost and the large capacity of the system, it is ideal for mills handling a large tonnage of low-grade ore. It is not the ideal system for a mill that has to handle much ore that resists settling, nor where there is little water.

CLARIFICATION. The solution to be clarified is pumped to two steel tanks, in each of which is a nest of 16 Butters filter-leaves. The solution is drawn through the leaves by a vacuum-pump that discharges the filtered solution to the small steel settling and distributing-barrel in the precipitation-room.

PRECIPITATING AND SMELTING. The solution to be precipitated flows by gravity from the settling-barrel to five zinc-boxes of standard design. The zinc consumption is 0.88 lb. per ton of ore treated. The precipitate is washed into a small steel filter-tank that is connected to a vacuum-pump. The damp precipitate is scooped from the filter and placed in drying-pans. The dried precipitate, including zinc shorts, is mixed with 12% of borax, 10% of sodium bicarbonate, and 18% of assay-slag. The charge is melted down in a Monarch tilting-furnace, using crude oil as fuel. The bar is made in one melt, as double melting was not found worth the expense.

SAND TREATMENT. The sand from the collectors, after four hours of draining by vacuum, is charged into the

leaching tanks. A tank when charged has 80 lb. of cyanide placed under the solution-pipe, the drain-cock is closed, and the tank is filled with battery-solution (80 lb. of cyanide per tank represents 1 lb. of cyanide per ton of sand in the tank). At the end of 12 hours the drain-cock is opened and the tank is allowed to drain for 12 hours. This treatment is repeated twice. This is called the rich-solution treatment and lasts three days. At the end of the third day the drain-cock is left open and baths of barren solution are applied every four hours until the end of the treatment. For 24 hours before a tank is discharged water-baths are applied every four hours and the tank is dried finally by vacuum. The tanks are discharged by hand. Peons shovel the sand into ears beneath the tank and tram the sand 300 ft. to the dump. The work of discharging the sand-tanks is done by contract. The peon contractor receives 24 pesos (\$8 at the present rate of exchange) for charging and discharging an 80-ton tank in the manner described.

A POUND OF ALUMINUM has over three times the volume of a pound of copper. Thus, if the output of the Aluminum Company of America (including its Canadian subsidiary, the Northern Aluminum Company of Canada) estimated for 1914 at 108,000,000 lb., were used entirely for purposes for which volume is the controlling factor, the amount would be equivalent to over 325,000,000 lb. of copper, which is more than the annual output of either Montana or Michigan. Practically no opposition exists to the control of the production of aluminum in the United States and Canada by the Aluminum Company of America. The Southern Aluminum Co. was constructing, previous to the War, at Whitney, North Carolina, a plant designed to give employment to 1200 men. This company, a branch of the L'Aluminium Française, the French company which is estimated to have produced 29,700,000 lb. in 1914 chiefly from works in France, is now reported to have been sold to the Aluminum Company of America, which has various plants in Pennsylvania, Tennessee, New York, New Jersey, and Canada, and is understood to be controlled by the Mellon family of Pittsburg. This organization, with a capital of \$20,000,000, makes no regular statement of earnings, but its president recently announced at Detroit that a profitable return on capital had been earned for several years much of which, however, had been reinvested in improvements. Constant experimenting has been in progress at the company's plants for years; many changes and great expansions have been, and are being, made. Other foreign producers of aluminum have been the British Aluminium Co., which in 1914 is estimated to have produced 19,800,000 lb., mostly in Great Britain; the Aluminium Industrie Aktien Gesellschaft, which in 1914 produced 30,800,000 lb. from Switzerland and Austria; and the Societe D'Aluminio, Italy, which in 1914 produced 1,700,000 lb. The use of aluminum is increasing rapidly; it is in demand for parts of automobiles, utensils, soldier's kits, and as a precipitant in cyaniding plants.

CONCENTRATES

Readers of the MINING and Scientific PRESS are invited to ask questions and give information dealing with technical and other matters pertaining to the practice of mining, milling, and smelting.

TAILING at the Nipissing mine, Cobalt, is to be treated by flotation.

QUESTIONS on mining generally answered by the U. S. Geological Survey amounted to 1000 each week in 1915.

METAL MINES in the United States employed a total of 1,009,236 men in 1914. Of these, 3193 were killed, equal to 3.16 per 1000.

COST of lining basic converters at the Old Dominion smelter, Arizona, is 5.5c. per ton of copper bullion, against \$1.80 with the old acid-type converter.

PURE METALLIC VANADIUM was first prepared in 1904. It is the hardest of metals, being above 7; the specific gravity is about 5.5; the melting-point is 1680° C.

GEARS driving flotation propellers in adjoining cells should revolve in opposite directions, so as to equalize strains on the machine and the power transmission.

DRILL-STEEL has a carbon-content from 0.6 to 1.1%. A steel of 0.9% carbon is recommended, although it requires a little more care in tempering than one of lower carbon.

TO PREPARE and equip the Inspiration mine at Miami, Arizona, for the mining and treatment of 5,000,000 tons of sulphide ore per annum (14,400 tons daily) cost \$625 per ton for equipment and \$208 for advanced underground preparatory work, a total of \$833 per ton.

ACCIDENTS at mines and works are required by law to be reported in Alaska, Arizona, California, Colorado, Idaho, Illinois, Maryland, Michigan, Minnesota, Missouri, Montana, Nevada, New Jersey, New York, Oregon, Pennsylvania, South Dakota, Washington, and Wisconsin. Most of the legislation dealing with this phase of mining is of recent years.

A PORTABLE TELEPHONE, made of aluminum and weighing but 2½ lb., is to be used by patrolmen in the National Forests. For exploratory work in sparsely-settled regions, this instrument is an undoubted convenience. It is said that a field man equipped with this telephone and a few yards of wire can 'cut in' anywhere by throwing his emergency-wire over a telephone line.

LARGE BLASTS of rock are becoming more common with big-scale mining. An immense one took place on November 21, 1915, at Chuquibambata, Chile. In an adit 90 metres long, connected with 20 smaller adits, was placed 67 tons of powder and 17 tons of 65% dynamite. The area influenced by the charge was 400 metres long

and 70 metres deep, and 450,000 tons of 2% copper ore was loosened. The cost was \$31,000 U. S. currency, or P200,000 Chilean. To prevent poisonous gases finding their way into the adjoining workings, concrete walls were erected, while pipes and fans were provided.

ROCK-DUST is used in preventing the starting of mine explosions, and in checking them after they have been initiated. This system seems to have had an advantage over those in which water is applied infrequently, in that more constant protection is afforded, as proved in coal mines near Pittsburg and in Colorado. Limestone dust, 75% passing 100-mesh, was used at Pittsburg. As coal-dust settles in the mine, rock-dust is blown in by a machine fitted on a flat-car running on the tracks of the mine-entry. This dust covers the coal dust, and is blown in at intervals. The U. S. Bureau of Mines has made considerable investigation of this subject.

THE WELDING of metals requires the use of a suitable flux to eliminate oxide between the faces of the two parts welded. Wrought iron is welded more easily than steel; the iron may be so hot that small globules fall off or it throws sparks in the forge, while steel will not stand so much heat without burning. The welding point of steel is generally judged to be when it seems wet or oily on the surface. Thermit welding, for heavy work, employs the heat generated by the chemical reaction in which aluminum takes oxygen from iron oxide; the welded part is stronger than originally by reason of a collar of new metal around the fracture. For welding wire hoops, or one metal to another, electric-resistance welding, employing alternating current is used. Gas-welding, including oxy-acetylene welding, uses gases under pressure which are ignited at the tip of a blow-pipe.

NEVADA is a Spanish word meaning snowy or white as snow, and the name of the State was derived from the Sierra Nevada. The State ranks sixth in size in the Union. Its length from north to south is 484 miles, its width 321 miles, and its area 109,821 square miles. The history of Nevada is chiefly the history of its mines. Since the discovery of the Comstock lode and other famous ore deposits, periods of activity and prosperity have alternated with periods of depression. Each discovery of high-grade ore in considerable quantity has been followed by rapid settlement in that locality and the establishment of one or more towns. In 1896-1893 a sharp decline in the price of silver initiated or accompanied a period of depression in Nevada's mining and general industrial prosperity. Silver is so important a resource of the State that to a large extent even now its prosperity depends on the market for that metal. Of late years, however, an increased production of gold, copper, and recently of antimony, platinum, tungsten, and zinc, has accompanied a gradual and, it is hoped, substantial industrial progress. Prosperous towns have grown-up, and agriculture and related pursuits are becoming firmly established.

Recent Patents

1,169,270.—APPARATUS FOR THE TREATMENT OF ORES. Erich Langguth, Neerpelt, Belgium. Original application filed Feb. 10, 1912, Serial No. 676,869. Divided and this application filed Oct. 4, 1912.

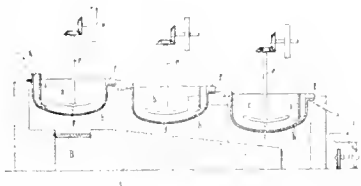

An apparatus for the treatment of an ore containing silver, comprising an integral vat provided with a curved side wall and a bottom wall merged into said side wall by a curved connection and being divided into a main compartment of circular cross section and a secondary compartment of crescent cross section by an integral diaphragm extending to the bottom of the vat and provided with an aperture near said vat bottom to establish communication between said compartments, the said diaphragm being of the same convexity as that of the side wall of said main compartment and being merged into said bottom wall by a curved connection of the same convexity as that of the curved connection first mentioned, whereby the entire inner surface of the diaphragm constitutes an unbroken continuation of the inner surface of said main compartment side and bottom walls, and the outer wall of said secondary compartment being curved so as to merge into the side and bottom walls of the main compartment.

1,176,441.—PROCESS OF CONCENTRATING ORES. Ernest Gayford and George Crerar, Salt Lake City, Utah, assignors to Metals Recovery Company, Augusta, Me., a Corporation of Maine. Filed May 29, 1914.

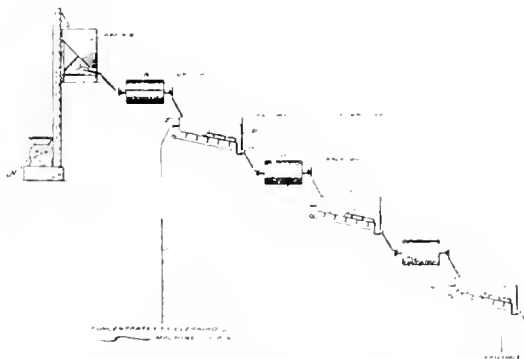

1. The process herein described, consisting, essentially, in progressively reducing, by successive stages, ore mixed with water and a frothable agent having a preferential affinity for metalliferous matter, aerating the mixture resulting from each reduction, and floating off the concentrates liberated at each reduction.

1,175,331.—PROCESS OF CONCENTRATING COPPER VALUES. Richard M. Atwater, Jr., Scarsdale, N. Y. Filed June 17, 1915.

1. The process of concentrating the copper values carried by copper tailings, which consists in treating said tailings in heaps with sufficient sulfuric acid to dissolve a substantial portion of their copper values; causing said values to be brought to the surface of said heaps by capillarity and to re-assume the solid state by evaporation; and suitably removing from said heaps the concentrates thus produced, substantially as described.

1,174,086.—CALCINING FURNACE. George Moore, Joplin, Mo. Filed Mar. 16, 1914.

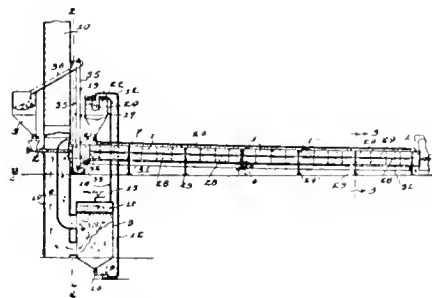

1. In a calcining furnace, the combination with a furnace proper, of means for discharging hydrating waste solids in a sheet against the exterior of the furnace in quantities substantially only sufficient for requiring the waste heat of the furnace for drying.

2. In a calcining furnace, the combination with a furnace proper, of a pipe extending along the furnace above the same, and having discharge apertures opening toward the furnace, and means for delivering hydrated solids to the pipe, the apertures in the pipe being proportioned to permit discharge of such solids on to the furnace in quantities substantially only requiring the waste heat of the furnace for drying.

1,175,616.—ORE SEPARATOR. George H. Davis, Worcester, Mass., assignor to Amerige-Davis Machine Company, Boston, Mass., a Corporation of Maine. Filed July 2, 1912.

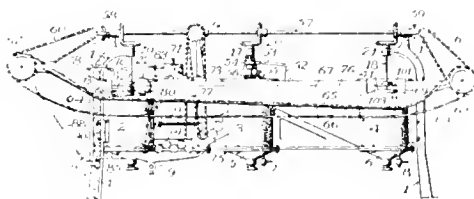

1. In an ore separator, the arrangement for conjoint action of an amalgamating section, a washing section and a screening section, an inclosed passage leading from the bottom of the amalgamating section to the screening section, with a portion of said passageway completely filled with mercury, means for agitating the mercury in said passage, and means for establishing a communication between the top of the amalgamating section and the top of the screening section below the water line.

1,177,109.—PRECIPITATING APPARATUS. Joseph Irving, Jr., Douglas, Ariz., assignor to The Dorr Cyanide Machinery Company, Denver, Colo. Filed Sept. 14, 1915.

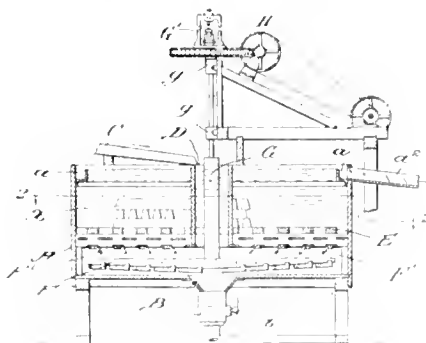

1. A precipitating apparatus, comprising a vessel having a discharge opening at the bottom and a precipitant supporting reticulated frame through which the liquor passes, and slowly revolving scrapers or flutes below the frame for moving the precipitate to the discharge opening and for spreading the same in a layer beneath the supporting frame.

1,171,777.—PRECIPITATOR MACHINE. Frederick B. Kollberg and Max Keady, Bismarck, Ark. Filed Aug. 2, 1915.

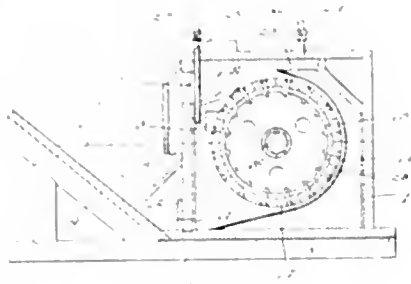

1. Apparatus of the class described comprising a spraying chamber, a frothing chamber, there being an outlet opening through which the spray created in said spraying chamber is adapted to pass to said frothing chamber, a fluid supply communicating with said spraying chamber; and means in said chamber for directing the fluid supplied to said spraying chamber toward said outlet opening, substantially as described.

1,176,128.—FLOTATION SEPARATOR APPARATUS AND PROCESS. John M. Callow, Salt Lake City, Utah, assignor to Metals Recovery Company, Augusta, Me., a Corporation of Maine. Filed Dec. 29, 1914. Serial No. 879,729. Renewed Jan. 21, 1916.

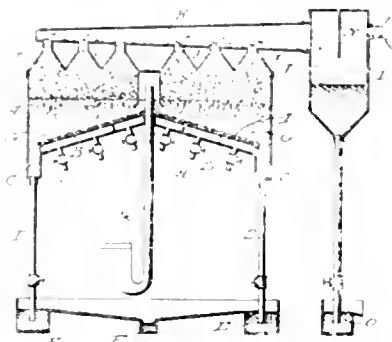

In flotation separator apparatus, the combination with a tank adapted to contain comminuted ore and water and a frothing agent, said tank having a bottom restrictedly open to the atmosphere, and means for producing a suction in said tank to draw air through said bottom to generate bubbles and to destroy said bubbles and remove the mineral particles therefrom.

1,175,782.—CONCENTRATE PREPARING MACHINE. Thomas J. Lovett, Chicago, Ill., assignor to Copper Process Company, Chicago, Ill., a Corporation of South Dakota. Filed Nov. 14, 1912. Serial No. 757,455. Renewed Jan. 29, 1916.



1. In an ore-reducing concentrate-preparing machine, the combination of a pair of gangue-pulverizing mineral-pelleting

pressure members having substantially smooth extended area contact surfaces, one of said members being a floating member, means for relatively reciprocating and rotating said members, and means for feeding ore pieces between said surfaces, said members so disposed, proportioned and cooperatively geared as to support and roll said ore pieces between them, finely pulverize the gangue, pellet form the metals and discharge the materials with the concentrate thus prepared.

1,175,266.—MACHINE FOR REDUCING ORES. &c. Thomas J. Lovett, Chicago, Ill., assignor to Copper Process Company, Chicago, Ill., a Corporation of South Dakota. Filed May 28, 1914.

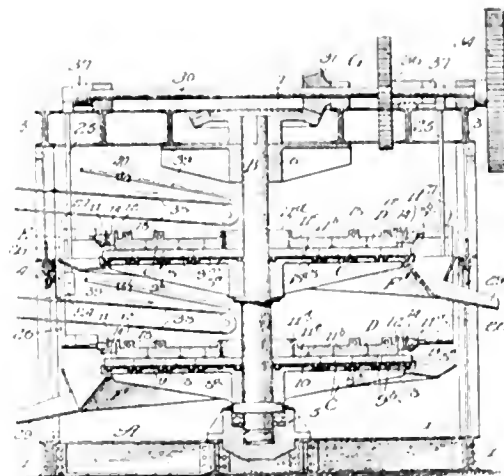

1. In a machine of the character set forth, the combination of a plurality of suitably-spaced rotary members disposed one above the other, co-acting reciprocable pressure-members comprising floating-plates resting upon said rotary members, and means for reciprocating said second-named members in opposite direction.

2. In a machine of the character set forth, the combination of a frame, a vertical shaft journaled therein, rotary members supported by said shaft and fixed to rotate therewith, a reciprocable pressure and distributor-member co-acting with each rotary member and comprising floating-plates resting upon the rotary member, and means for shifting said reciprocable members with relation to the rotary members.

1,177,396.—DESULFURIZING METHOD FOR TREATING REFRACTORY ORES. Edward Hale Dickie, Goldroad, Ariz. Filed Jan. 25, 1915.

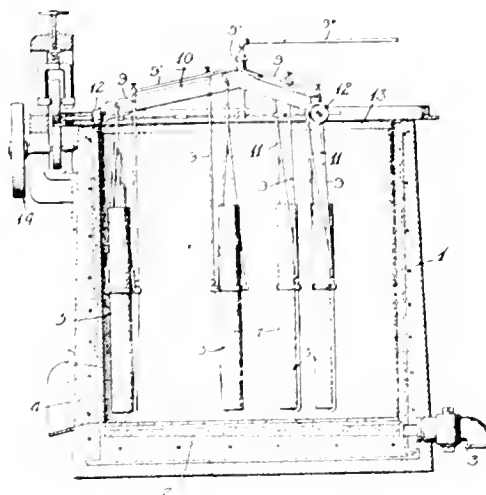

The method of treating refractory ores consisting in mixing the finely ground ore with a solution of caustic soda and potassium acetate, agitating the mixture in the presence of a metallic value precipitant, and finally removing the solution.

REVIEW OF MINING

As seen at the world's great mining centres by our own correspondents.

LEADVILLE, COLORADO

LABOR AND WAGES AT MINES AND THE SMELTER.—SALE OF THE ROBERT EMMET MINE.—THE ZINC SMELTER.

At a meeting of mine managers and operators held here on April 12, all men employed in Leadville mines were voted a 10% increase in wages, to take effect from April 1. The increase is based on the price of spelter, and will remain in force while that metal is quoted at 10c. per pound or more. It is conservatively estimated that 1500 men will receive the benefit of the advance. For years Leadville has been a \$3 centre, miners, shovelers, and trammers all receiving the same pay. This wage has been maintained during periods of depression as well as times of prosperity, with apparent satisfaction to employers and employees alike. The recent advance in the metal markets brought about a change in conditions which made it necessary to adjust wages. The great copper districts of Nevada, Utah, Arizona, and Montana commenced a sliding wage-scale, greatly increasing the pay, and miners from all parts of the country flocked to these places in search of employment, with the result that many other mining areas were left short-handed. Leadville experienced a noticeable lack of efficient men, and conditions were gradually growing worse when it was decided to increase wages 10% all around, although many of the companies that accepted the advance were in no better condition than they were years ago. At present Leadville is a heavy producer of zinc, the greater part of the district's tonnage being that kind of ore. The majority of the men employed in the district are working in zinc-producing mines, which for some time have been making fine profits due to high prices for the metal. There are, however, many properties here that are not producing any zinc ore. Copper, lead, silver, and gold ores are mined extensively. The first two metals command high prices, while silver is steadily advancing, so that companies producing these ores can easily afford to raise wages. Gold properties are the exception, however, and for the first time we find these following, instead of leading the other branches of the mining industry. The companies represented at the meeting are the Western Mining Co., Down Town Mines Co., Star Consolidated Mining Co., United States S. R. M. & E. Co., New Monarch Mining Co., Yak Mining, Milling & Tunnel Co., Iron Silver Mining Co., Ihex Mining Co. and lessees, Garbutt lease, Louisville mine, Dinero Mining Co., George E. Cramer & Co., Porter lease, Mikado mine, Highland group, Burton leases, Robert Emmet, Denver City, Fortune, Luema Mining Co., and the Bowden leases.

Following the recent strike at the Arkansas Valley smelter of the A. S. & R. Co., the company voluntarily increased wages in the plant, taking effect on April 1. The announcement of the advance as posted in the various departments is as follows: "Beginning April 1, 1916, and continuing while there is a sustained price for lead in New York of 6c. or over per pound for the preceding month, the following additions to the present daily wage scale will be paid: on wages up to and including \$2.25 per day, 15c. per day; over \$2.25, up to and including \$3 per day, 20c. per day; and over \$3 per day, 25c. per day." The advance in wages will affect 800 men employed at the plant, which is now operating at full capacity.

However, in spite of the fact that the mines and smelter here have voluntarily raised wages, there is much discontent

among the men, especially the miners, who consider that the increase is not as great as it should be under existing conditions. They argue that with the present strong metal market, mine and smelter operators are in a position to pay labor a higher scale of wages. The miners want \$3.50 a day, and \$4 for machine-men. The local branch of the Miners' Union is holding open meeting for the discussion of the wage question, but as yet nothing definite has been decided upon.

The purchase of the Small Hopes-Boreel property by the Empire Zinc Co. for a sum exceeding \$500,000 is one of the largest mining transactions closed here for several months, and is the cause of renewed activity at other mines in that section. The Small Hopes company, operating through the Robert Emmet shaft, has opened one of the largest bodies of zinc sulphide ore that has ever been found in the district. During the past three or four months the property has been shipping from \$40,000 to \$50,000 worth of ore each month. In addition to the zinc, several shoots of lead have been uncovered, all above water-level at the 600-ft. level. When the Robert Emmet was one of the big mines of the district, a large pumping plant drained the property to the 1300-ft. level. Huge deposits of sulphide ores were uncovered in the lower workings, said to be larger than those now being worked above. Until recently, the ore in the Emmet was not commercially valuable, and the property has been allowed to fill up with water to the natural level. High prices for zinc and lead ores have brought about a change in conditions that make the Emmet one of the richest mines in the district, and the price paid for the ground is stated to be very reasonable. By the transaction, the Empire Zinc Co. secured title to the Robert Emmet, Result, Forest City, Gonabrod, and Ranchero claims in Stray Horse gulch. This tract is surrounded by such mines as the Wolfstone, the largest zinc producer in the State; the El Paso, formerly one of the richest silver mines here; the Greenback, said to be worth \$1,000,000; and the Ponsardin, now shipping \$20,000 of zinc sulphide per month. Mining men who are familiar with the Emmet and other claims in the purchase, state that although the orebodies opened in the Emmet are the greatest ever developed here, those known to exist in the Gonabrod are even greater. There are millions of tons of ore opened, and when the Empire people take active charge, a large output will be maintained. The Small Hopes company will continue to operate the property for 90 days, until its contracts for ore shipments are canceled. During that time it is estimated that \$150,000 of ore will be extracted.

Extensive pumping operations are being planned for the territory surrounding the Emmet. George O. Argall and associates have formed a \$10,000,000 company for draining east Carbonate hill, and have secured leases and options on the R. A. M., Pyrenees, Mikados, Cyclops, and other adjoining ground. This project will unwater a large area of rich territory and will lower the water in the ground purchased by the Empire Zinc Co. It is also reported from authoritative sources that the Western Mining Co. is preparing to unwater its holdings of Carbonate hill, including the Wolfstone, Adams, and Mahala. The Wolfstone is now 1300 ft. deep, and pumping will be done through this shaft. This undertaking will also affect the Emmet ground, and it is thought that the Empire Zinc, instead of installing a pumping plant at the Emmet, will pay these other companies draining royalties.

The Western Zinc Oxide Co. is now preparing to enlarge the

smelting plant for the manufacture of zinc oxide, which has been in operation here for two years. At present, the plant has a capacity of 50 tons per day, but owing to various causes has never reached beyond 30 tons. Another block of four furnaces is to be added as soon as men can be secured to carry on construction work. This will give the plant a capacity of 75 tons per day. James A. Whittington, formerly in charge of the Lehigh Iron & Deque, Illinois, has been secured to direct the building and to manage the plant. The Midland Chemical Co., of Chicago, a manufacturer of lithopone, has purchased a 2% interest in the local concern, and has contracted for the output of the plant. The process for the manufacture of zinc oxide used by the Western company has proved a success. During the two years' operation the plant has been able to treat a quantity of low-grade carbonate ore that could not otherwise be marketed. It has turned out on an average 50 tons per week of oxide that contains from 75 to 90% zinc. This product has commanded a great price, and at present is much in demand. Following the addition of another block of furnaces, a roasting plant will be installed for treating zinc sulphide.

MEXICO CITY, MEXICO

NEW MINING LAW—GENERAL CONDITIONS.—PACHUCA AND EL ORO—MONEY.

A decree is soon to be issued by Carranza making effective the new mining law. An important feature is said to be the discouragement of large holdings of undeveloped ground, compared with the present law which does not limit the number of claims that may be 'denounced.' The new taxes will be based on minimum and maximum precious-metal holdings. The small company, with nine or less claims, is to pay yearly P1 Mexican gold for each claim; from 10 to 50 claims the tax is P12, from 50 to 100 claims P18; and all over 100 claims P24 each. More liberal terms are offered to base metal properties. The export duty on bullion is raised from 7½ to 10%.

Mail from the United States is coming through to Mexico City in about 6 days. Traveling by rail is somewhat uncomfortable, due to difficulty in getting meals and crowded trains. In spite of the poverty-stricken reports there are many people moving about. As most of the freight-cars have been destroyed or are being used as traveling homes for soldiers and their families, it is difficult to get in supplies to mines or ship concentrate. If the latter went out of Mexico like bullion, more speed would probably be shown, as there is an export duty payable in gold. When goods enter the country, duty is added and companies take chances in getting them forwarded. Graft is rampant along the railroad. At Pachuca the Real del Monte company has over \$1,000,000 of concentrate on hand. It secured some locomotives and cars to haul the product to the smelter, but only one train a month was possible. It seems as if there was only one crop grown around Mexico City, *batatas*, from which *pulque*, *mescal*, and other fiery liquors are made. The product is forbidden in the City, but there must be a large demand for it. The rate of exchange has been 20 to 1, but at present P25 are only worth \$1 U. S. currency. All the present money is to be withdrawn and replaced by new paper, which the authorities claim will be more difficult to counterfeit.

Regarding conditions at El Oro it might be said that everything has been quiet for a long time, but things are looking so good today (April 18) that it seems at least two of the companies here will be operating before the end of another week. There has been no trouble with labor here of late, but when work is started it is likely that the mines will be shorthanded, as the majority of the *goats* have gone to their *terras* to look after planting and growing crops.

Carranza entered Mexico City in triumph on April 17, and had the pleasure of riding through the numerous triumphal arches that have been under construction for eight months.

GUADALAJARA, MEXICO

MONEY, MINING, AND CONDITIONS GENERALLY

From Mexican refugees whom I met in New York I gathered that the Mexican peso had not declined as rapidly in purchasing power as it had in exchange value, and I find this to be the case. Take railroad fares as an extreme instance; from Vera Cruz to Mexico City a ticket costs 28 pesos, from Mexico City to Guadalajara it costs 37 pesos. The Mexican peso at the present rate of exchange is worth slightly less than 4 cents in gold, so that the trip from Vera Cruz to Guadalajara requires \$2.60 gold. An additional \$1.50 gold pays the fare to Manzanillo. A ride across the continent therefore will cost about \$110. The journey from the American border to the Guatemalan frontier costs about \$6.50, I have been told. As a consequence of these low rates the cars are crowded to a point where they resemble subway trains during the rush hour. This side of Queretaro a peon woman, as a result of this crowding, fell off the roof of one of the box-cars ahead of the car I was in. We were going at a pretty fair clip and didn't stop to pick her up. Upon arriving at Guadalajara Mr. M., the treasurer of a local company and a prominent citizen, his wife, and myself climbed out of our car-window as the easiest way of leaving the train. It is hard to imagine one of the socially prominent matrons in a city of 125,000 people in the United States climbing through a car-window upon arriving at her native city, especially if she were verging on portliness.

When I arrived at Guadalajara the street-cars were charging ½ cent gold for a ride first-class. I am paying 35 cents gold for room and board at one of the best hotels here. The landlord's monthly rental, which is 600 pesos, has shrunk from \$300 gold to \$24. Cigars cost only 2.4 cents each and an extension of my visitor's card at the club cost 5 cents for two weeks. The place is a veritable paradise for an impoverished and obscure engineer like myself.

The Mexican government has virtually prohibited dealings in exchange and also prohibits the transfer of real estate from Mexicans to foreigners. This last prohibition is, I believe, in a measure justified as real-estate values have dwindled to a point far below their pre-revolutionary figure. In some instances improved property has sold for as little as a fifth of what it would have brought before the revolution.

The *bilim-bique* or paper peso is a *forzoso* currency, which fact has enabled debtors who incurred obligations when exchange was 2:1 to discharge their obligations at four cents on the dollar. A ranch near here sold for \$1,000,000 during the pre-revolutionary epoch and payments were distributed over a long term of years. The buyers have recently met their notes with 4-cent pesos.

Difficulty in securing exchange has produced some curious effects. Merchants realizing on their stocks are unable to replenish them. They are granted no credit in the United States and freight-cars in Mexico being scarce, they must be personally conducted and cannot be secured unless *gratificaciones* amounting to several hundred dollars gold per car are paid to the proper parties. Merchants are not renewing stocks, and being unable to secure exchange are investing their accumulating paper money in real estate or in anything that holds promise of ultimate, tangible, pecuniary return. Promoters have taken clever advantage of the frantic psychology of a rapidly falling exchange and have organized all manner of mushroom oil companies. In their prospectuses they state that a peso in paper invested today will be worth a peso in silver tomorrow. As to mining, it is impossible except in the older and established camps. In Jalisco, Cinco Minas and El Amparo are the only properties operating.

At this juncture a loan would, I believe, save Mexico; but with a steadily depreciating currency and the printing presses working over-time I can't see what is to hold the army together and prevent it from disintegrating into brigandage. At present there is, however, a slowly crystallizing military autocracy, judging by recent work by Gonzales and Dieguez.

THE MINING SUMMARY

The news of the week as told by our special correspondents and compiled from the local press.

ALASKA

The U. S. Geological Survey has issued Water-Supply Paper 372, 'A Water-Power Reconnaissance in South-Central Alaska,' by C. E. Ellsworth and R. W. Davenport, with a section on south-eastern Alaska by J. C. Hoyt. The publication covers 173 pages, including illustrations and maps. The areas discussed are Controller bay, Copper river, Prince William Sound, Kenai peninsula, Willow creek, and others.

FAIRBANKS

It is estimated by local authorities that the Fairbanks region will produce over \$4,000,000 this season, an increase of \$500,000. The Tolovana district may yield \$650,000. Antimony, tin, and tungsten ores will help swell the returns.

JUNEAU

A suit has been started at Juneau over 11 claims on Sheep Creek mountain between the Alaska Gold-Belt and Alaska Taku companies. Both claim the property. At a depth of 2500 ft. the Gould and Curry vein of the Gold-Belt company has been cut by the diamond-drill. The hole is in 1575 ft. horizontally, which is claimed to be a record for such a flat hole. The rods are greased continually. There is danger of water forced through the rods to the bit being frozen. The work was done by Lynch brothers, in charge of A. B. Dodd, the superintendent.

ARIZONA

Gypsum is discussed in Bulletin 19 of the State Bureau of Mines, by Frank L. Culin, Jr. The best deposits in Arizona are in Navajo, Cochise, Pinal, and Pima counties; those in the Santa Rita mountains are of considerable extent.

MOHAVE COUNTY

At 500 ft. depth in the Gold Ore mine, at Gold Road, the shoot is 200 ft. long and 6 ft. wide. A stope above this level has given high assays in gold and silver. Of the 60 tons broken each day, 25 tons is sent to the mill, on account of shortage of trucks.

At 110 ft. from the shaft, on the 485-ft. level, the Big Jim has cut the shoot opened above. So far, it is 26 ft. wide, assaying \$12 per ton. On the 400-ft. level the vein was 4½ ft. wide of \$7.44 ore.

At the Tennessee mine at Chloride steam has superseded gasoline. The daily output of ore sent to the Needles mill and smelter is 300 tons.

Development at 665 ft. in the United Eastern is highly satisfactory. The north drift is out 200 ft. The vein is 40 ft. wide, assaying \$21 per ton. In other places the vein is wide and of high value. The new three-compartment shaft is being sunk on one shift. Good progress is reported on grading for the mill.

YAVAPAI COUNTY

This county's mines are being operated at high pressure. In the last week of March, 114 carloads of ore and 11 carloads of copper bullion were dispatched.

The Crown King district is growing busier. Three mills are working, while the fourth soon will be. The last will treat tailing by flotation.

Rich silver ore, containing some copper, has been opened for 50 ft. in length and 4 ft. in width in the Tuseumbia mine, in

the Bradshaw mountains. The ore is similar to that of Tonopah, Nevada.

The quicksilver claims in Copper Basin of Ross, McNary, and Hall are under option to Bowler and Pell of New York. A large quantity of good ore is said to be ready for the large reduction plant proposed.

CALIFORNIA

Considerable activity is reported from the districts containing chrome-iron ore deposits. Near Stony creek in Amador county a large quantity is to be mined to fulfill a contract. Fifteen auto-trucks are to carry ore from Dickey and Diesbach's mine at Woodleaf in Butte county. The first shipment has been made from Pentz. San Franciscans are developing the Negro Hill deposits in Sacramento county. From Lowrey, in Tehama county, the Noble Electric Steel Co. has let a contract to haul ore to Red Bluff, then on to its smelter by rail. Near Wildwood, in Trinity county, a large deposit is being investigated.

AMADOR COUNTY

Some good ore has been opened at 2800 ft. in the Central Eureka. Twenty of the forty stamps are dropping.

Steady progress is reported from the South Eureka, where 175 men are kept busy. The company is unwatering the Oneida mine nearby. A dividend of \$20,990 was paid last week.

The Argonaut and Bunker Hill companies have distributed \$15,000 and \$5000, respectively.

CALAVERAS COUNTY

(Special Correspondence.)—T. M. Lane is now arranging with Collins brothers of Jenny Lind to allow them to commence operations, as lessees, on the Plymouth Rock or Jenny Lind mine. The property was last worked, in a small way five years ago. It is now intended to install a steam hoist. The ore, which contains copper, gold, and silver, will be hand sorted and shipped to a smelter for treatment. Mrs. Charles D. Lane is owner.

The Nugget Queen or Egan mine has been bonded by L. Estelle Sibbald of Denver, Colorado. The shaft has been unwatered and an examination of the underground workings has been made by Fred G. King of San Francisco, who has left for that city with samples. After his report is received a definite plan of operations will be decided on. The property is supposed to have an extension of the Hodson vein, lying in a westerly direction from there.

Copperopolis, April 18.

It is reported that Sacramento people are to dredge old hydraulic tailing in Chili gulch near Mokelumne Hill.

INYO COUNTY

Tungsten claims 8 miles west of Bishop are to be actively worked this summer. The property of L. E. Stevens and F. M. Townsend is said to contain 50,000 tons of ore available by quarrying. A 200-ton mill is contemplated.

PLUMAS COUNTY

At the Engels copper mine near Taylorsville an adit has been started to open the vein at a depth of 750 ft.

A syndicate is being organized by G. O. Dowden at Portola to operate an option on eight copper claims between the Engels and Walker mines.

NEVADA COUNTY

... 140 acres on Cottonwood creek ... J. Brower and C. H. Miller ... who will construct a dredge at an early date. At Bennett the Noodle Electric Steel Co. has started ...

NEVADA COUNTY

The Grass Valley Consolidated Gold Mines, a new company composed of Golden Center company ... has purchased the Albion Ranch mine ... The property has been closed since

in southern California. The Alabama has a 300 ft shaft and in add of considerable length, the Crystalline has been opened to 600 ft, and according to reliable information has produced \$20,000.

The shafts on what is known as the Ranch mine are being unwatered to lessen the danger to the miners employed in the Springfield Tunnel & Development Co's long adit, now almost up to the old shafts. The adit, which is to be 6000 ft long, already exceeds 3000 ft. The Ranch mine property was acquired by the Springfield company several years ago. The company has cut one of the subterranean channels that traverse its property, and the gravel washed gave encouraging gold returns, but the main channel, from which the best results are expected, will not be reached for some time yet.

A prospect on the Burns ranch, near Soulsbyville, that gives promise of developing into a mine of merit, is being worked by Benjamin Addis and others. A shaft has been sunk and at a depth of 75 ft, a drift driven, revealing some high-grade ore.

The Hope mine, near Sonora, is employing 11 men. It is a pocket-milling vein and has yielded well during the past year. Two or three pockets of generous size were taken out, besides a large tonnage of good milling ore.

Sonora, April 14.

COLORADO

The public sale of the property of the U. S. Reduction & Refining Co. at Colorado Springs was postponed to April 25. The Court has fixed a minimum of \$250,000 for the following: All right, title, and interest of the defendant company in the Standard plant, near Colorado City; the Union plant near Florence, in Fremont county; the Metallic cyanide plant at Cyanide, in Fremont county; the interests of the company in the Cripple Creek Sampling & Ore Co.; the property situated in the Cripple Creek mining district, Teller county; all interest in the plant and site of the United States Smelting Co. near Canon City in Fremont

county; the National plant near Florence, in Fremont county; the National Sampler site near Cripple Creek; all mining claims owned by the defendant company in Summit county; the Brush Hollow ranch of 200 acres in Fremont county, together with all water rights, reservoirs, pipe-lines, franchises, contracts, etc.

CLEAR CREEK COUNTY

(Special Correspondence.)—The French Flag mine in Gilson gulch is to be equipped with a 50-ton mill. The manager, C. H. Ripley, states that ore treatment will commence within 60 days.

The Argo Leasing Co., operating the Doctor Town mine in the Daily district, will construct a 50-ton concentrating mill early this summer. In the mine is a shoot of lead, zinc, and iron ore that is 1000 ft long. A. Hanson of Empire is manager.

Every mill in the Idaho Springs district is operating full time: The Newton is treating 80 tons daily; the Jackson, 50;

TROBEMNE COUNTY

(Special Correspondence.)—It is understood that the Alabama and Crystalline mines, situated north of the Harvard are to be re-opened soon. The properties have been taken over under bond by C. S. Young, for many years identified with oil

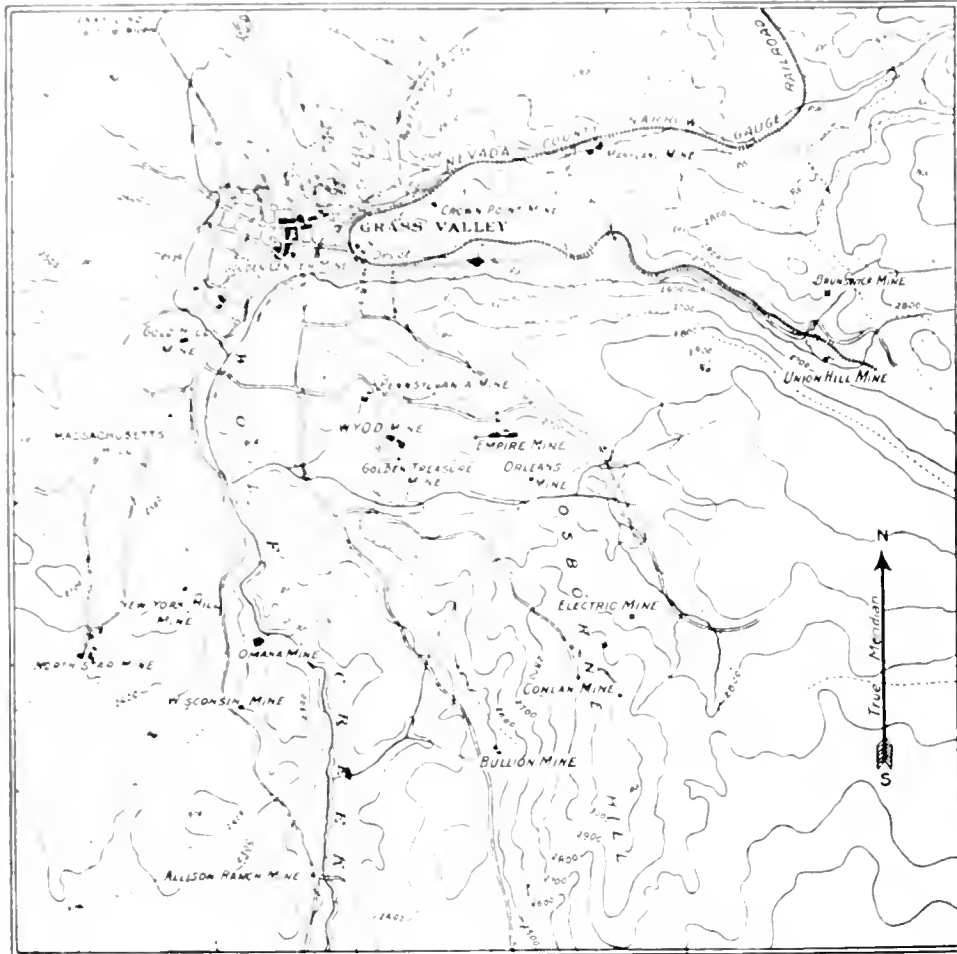

MAP OF THE GRASS VALLEY DISTRICT, CALIFORNIA. (After the U. S. G. S.)

oil. It will be unwatered and re-opened in charge of C. A. Bro. Johnson and a complete plant is to be erected.

The Pennsylvania Consolidated Mining Co. distributed a final dividend of \$1.775 per share on 51,476 shares last week, being the last payment due by the Empire Mines Co., which purchased the property for \$500,000. The Pennsylvania company is to be dissolved at an early date.

The Empire company during the past few months has acquired 430 acres of ground, including the Town Talk placer mine, and the Bogue and Mander ranches.

It is said that the Union Hill mine may come under the control of the company, which has an option on the South Idaho mine.

the Hudson, 75; the Argo, 150; the Stanley 25, and the Ronaldson, 25 tons. Shippers are experiencing difficulty in having their product treated.

Contractors on the Big Five adit are advancing it at the rate of 150 ft. per month. The heading is now nearing the Gilpin County line.

Idaho Springs, April 10.

OURAY COUNTY

Work has been resumed at the Mountain Top and Wanakan mines.—Rich tungsten ore has been opened in the Dunmore claim, four miles from Ouray.—The Adams tungsten mine, said to be one of the best in the county, is tied-up in a law-suit.

SUMMIT COUNTY

Gold worth \$7000, the first of the 1916 dredging season, was shipped from Breckenridge by the Tonopah Placers Co. two weeks ago.

TELLER COUNTY

The flotation plant at Stratton's Independence mill is doing good work. In March 14,900 tons of \$2.63 ore was treated. The capacity will be increased gradually to 1000 tons per day.

IDAHO

LEMHI COUNTY

(Special Correspondence.)—At the Queen mine, 8 miles north of Salmon, work has been resumed at the mine and mill with 20 men.—R. E. Wickham and others who have been blocking-out ore in high-grade gold claims 10 miles north-east of Salmon are erecting a stamp-mill.—The Musgrove property near Forney is being sampled; it probably will be sold. William J. Hoffman has just finished delivering 18,000 ft. of lumber for the Bohanan Dredging & Hydraulic Co.—As the season advances several mine-owners contemplate resumption of operations, which were suspended on account of deep snow and bad roads.

Salmon, April 5.

SHOSHONE COUNTY (COLOR D'ALENE)

With a capital of 5000 \$10 shares, the Idaho Railroad Co. has been incorporated by Herman J. Rossi, W. H. Herrick, and C. F. O. Merriam of Wallace, and W. W. Papesh of Kellogg, to construct a railway up Pine creek from Pine Creek station, on the O.-W. R. & N. company's Wallace branch, to the Constitution mine, a distance of 10 miles, and probably extensions into surrounding territory at a later date. The line will provide transportation for a number of promising mines in the Pine Creek region, including the Highland-Surprise, Nabob, Little Pittsburg, Constitution, Douglas, Amy-Matchless, Coeur d'Alene Antimony, and several others, and undoubtedly will encourage development of many prospects that now are practically dormant. The new company is understood to have secured right-of-way concessions for practically the entire distance, and a preliminary survey has been made.

During the period ended April 2, 1916, the Highland-Surprise Consolidated Mining Co. in the Pine Creek district received \$44,123 from the sale of zinc and lead concentrates (\$27,214) and treasury shares, etc. The cash balance is \$4820; also ore in bins worth \$16,200. A good tonnage of ore is broken in the stopes. The mill will resume when roads are in good order for hauling.

During 1915 the Success Mining Co., in the Nine-Mile district, made a profit of \$898,936, and paid \$555,000 in dividends, against having a deficit of \$92,825 at the end of the previous year. The income was \$1,255,802. Development covered 1375 ft., and other work. Reserves are sufficient to supply the mill for 18 months with zinc ore.

According to the report of J. F. McCarthy of the National Copper Mining Co. of Mullan for 1915, there is enough ore above the 1200-ft. level to supply the mill for two years. When this property was equipped with mill, electric railway, etc., the engineer on whose recommendation the improve-

ments were made, estimated 545,000 tons as available above the 1000-ft. level. When the mill was equipped and in operation, an unexpected barren shoot was found in the mine, which reduced this tonnage, according to the same engineer, to 170,000 tons. The mill was operated in April and May 1914, and the disappointment in mine developments together with the low price of the metals made a suspension of operations seem wise. During this suspension a winze was sunk 200 ft. to the 1200-ft. level. There was an opinion held by those familiar with the property, that the hanging-wall side of the vein contained better ore than any other portion. There was first milled 1200 tons from a drift on the hanging wall of the 1200-ft. level; then 2700 tons from the 1000-ft. level stopes. These tests proved that the ore is disseminated throughout the vein and that there is no segregation of value in either wall. During January was milled 4243 tons of ore from all parts of the mine. This was a stormy, cold month. Daily automatic samples were taken, giving 0.83% copper and 1.99 oz. silver. The mill produced 105 tons of concentrate, containing 22% copper, 52 oz. silver, and 0.05 oz. gold, worth \$10,815 net. This will show a loss of approximately \$1300 above operating expenses. Transport of ore from mine to mill cost 24c. per ton. It is recommended to work the mill two shifts; purchase more mill supplies, another locomotive, and 20 ore-cars, costing \$11,000; and sink to 1400 ft. If development is satisfactory an 8000-ft. adit would have to be driven, costing \$175,000.

KANSAS

CHEROKEE COUNTY

New zinc smelters are being constructed at Weir and Fort Smith. Galena people are largely interested.

MICHIGAN

THE COPPER COUNTRY

The official figures of the Calumet & Hecla and subsidiaries' output in March are as under, in pounds:

| Mine | March | Three months |
|-----------------------|-----------|--------------|
| Ahmeek | 2,175,930 | 4,951,270 |
| Allouez | 1,028,054 | 2,332,294 |
| Calumet & Hecla | 6,234,418 | 18,364,404 |
| Centennial | 252,428 | 563,109 |
| Isle Royale | 1,112,206 | 2,817,911 |
| La Salle | 108,321 | 343,783 |
| Osceola | 1,633,711 | 4,661,933 |
| Superior | 296,380 | 755,875 |
| Tamarack | 594,991 | 1,751,406 |
| White Pine | 345,641 | 1,036,830 |

MISSOURI

JASPER COUNTY

Owing to the large quantity of ore shipped and high prices for same the Missouri-Kansas-Oklahoma region's output in the week ended April 15 was a record, namely, \$1,433,827. A year ago the value was \$369,937. The yield was 11,495 tons of blende, 997 tons of calamine, and 1207 tons of lead, averaging \$107, \$81, and \$100 per ton respectively. For 15 weeks the total is \$12,833,717.

MONTANA

Of the total of 440 miles of railroad to be electrically operated, the Chicago, Milwaukee, and St. Paul has 226 miles worked by electric locomotives, between Harlowton and Deer Lodge. The remainder of the distance, Deer Lodge to Avery, Idaho, is being constructed, that is, fitted with electrical apparatus. The new system is entirely satisfactory, with lower costs than steam, and larger loads.

BROADWATER COUNTY

The Black Friday gold claims, credited with several hundred thousand dollars worth of high-grade ore shipments, two miles

southwest of the famous Keating company's properties at Robertsburg have been taken over for a reported price of \$250,000 by E. N. Breiting & Co. of New York. The deal was negotiated through Sidney Norman of Spokane, and the purchasers were represented by Harry B. Barling, the firm's chief consulting engineer. The mine has been opened to 700 ft. depth. The 500-ton mill is to be enlarged.

LOUIS AND CLARK COUNTY

Eight properties, totaling 180 acres, have been consolidated in the Marysville district and will be operated by the Marysville Gold Mining Co. The arrangement was perfected by L. S. Rogers, O. M. Lanstrum, and M. L. Hewett. Adjacent to the ground are the Drumblummen, St. Louis, Belmont, Bald Mountain, Gloster, Empire, Bell Boy, Penobscott, Shannon, and Bald Butte mines, all well known.

LINCOLN COUNTY

The Snowstorm Mining Co., which operated the Snowstorm copper mine at Larson, Idaho, has been acquired by the Snowstorm Mines Consolidated, to work the Banner and Bangle claims near Troy. A 250-ton mill will be erected a mile from Troy, also one mile of standard and six miles of 36-in. gauge railways and a 1500-hp. hydro-electric power-plant, the whole to cost \$500,000. Over 100 men are to be employed. The mine, in charge of R. E. Walters, has a long shoot of lead-zinc ore.

SILVERBOW COUNTY (BUTTE)

In the second first-aid contest between the Anaconda company's mines held once a week the winners were the Original, Anaconda, and Poulin teams.

Native copper has been found at 600 ft. in the Tropic mine of the Anaconda company.

NEVADA

ESMERALDA COUNTY

Treating dump ore the Nevada Metal Extraction Co.'s flotation plant at Goldfield is recovering well over 90% of the gold and copper. The daily tonnage of \$6 ore is up to 150, and costs will be around \$2.25 per ton. The Florence dump contains over 50,000 tons. Janney machines are used. Concentrate is worth \$70 per ton.

HUMBOLDT COUNTY

Twenty-two miles from Lovelock are the Ragged Top tungsten claims of L. E. Peeson, Makedon brothers, and E. Henning, which have been optioned for a large sum to Eastern people. The scheelite contains from 1.5 to 3.5% tungsten.

LYON COUNTY

According to the annual report of the Mason Valley Mines Co. its smelter at Thompson will be started when a steady supply of ore is assured.

MINERAL COUNTY

To operate the Golden Pen and other claims at Rand, Jesse Knight of Utah will organize the Gold Pen Consolidated Mining Co. Rich ore has been recently extracted.

NYE COUNTY

Two miles south of Belmont are the tungsten claims of Humphrey brothers, P. O. Harris, and M. J. Keely, which have been sold to A. B. Call of Pasadena for \$100,000 on terms.

In the vicinity of Round Mountain there are 60 men engaged in mining tungsten ore. The hills are full of prospectors.

WHITE PINE COUNTY

To haul tungsten ore from the Independent mine to Ely, a distance of 20 miles, auto-trucks are to be used.

Tungsten placers are reported to be of importance in the Snake range, and sluicing has already commenced where water is available.

NEW MEXICO

GRANT COUNTY

Last week the new mill of the Bufo Mountain Copper Co. commenced work, two weeks ahead of the scheduled date.

OREGON

BARBER COUNTY

The holdings of the Cougar Mining & Milling Co., 17 miles from Sumpter, one of the oldest developed properties in the district, have been taken over under an 18-month lease and bond for \$300,000 (on terms) by the United Gold Mining Co., recently organized by Spokane men. The new corporation is capitalized at 1,000,000 shares at \$1 each, of which 100,000 are issued. The officers are Arthur B. Lee president, C. F. Elkensbary vice-president, and Chester C. Robbins secretary-treasurer, who are prominent in Spokane business and professional circles. The largest shareholders in the Cougar company are D. A. Evans and John W. Larkin of Spokane. E. C. Brain of Helena, Montana, is general manager. Development has been done to a depth of 500 ft., and ore exposed is worth \$750,000. A 200-ton mill is in good order, but tube-mills and a cyanide plant are necessary.

SOUTH DAKOTA

LAWRENCE COUNTY

Disagreement among the Rattlesnake Jack owners has resulted in a shut-down. In February 1800 tons of ore yielded gold worth \$9800, with a profit of \$5200.

UTAH

JEAR COUNTY

Iron ore amounting to over 100 tons daily is being mined at the Dragon Consolidated and sent to the International smelter in Tooele county. This ore occurs between the 400 and 800-ft. levels. The mine is also producing lead-silver ore for the Knight Dern mill at Tintic.

A dividend of \$1 per share is to be paid by the Centennial-Eureka company, a subsidiary of the U. S. S. R. & M. Co., the first since September 1913.

SALT LAKE COUNTY

The Tar Baby's adit is in 2120 ft., a vertical depth of 1200 ft. The country is mineralized. The limestone-black rock formation contact is expected to be cut at an early date.

The Michigan-Utah company will have 100 men at work within 60 days. The Triangle Leasing Co. is extracting 50 tons daily.

The Alta Tunnel & Transportation Co.'s adit is in 1950 ft., about half way, with a daily progress of 5 ft. Eventually the adit will enter numbers of mines and solve the ore-transport problem.

SUMMIT COUNTY

On May 15 the Big Four Exploration Co., which is treating old tailing at Atkinson, 7 miles from Park City, will pay 5c a share, equal to \$20,000. The 250-ton plant is being enlarged to 750 tons, by adding 27 Willey, Overstrom, and Deister tables. Steam-shovels are to dig the tailing-dumps.

From royalties, ore and silver sales, etc., the Ontario Silver Mining Co.'s revenue last year was \$72,683. Cash assets amount to \$312,574, an increase of \$12,000. From the 500-ft. level to the surface the mine is under lease, employing 70 men. The shaft has been unwatered to 1700 ft., and a centrifugal pump installed.

WASHINGTON

STEVENS COUNTY

A third lead furnace of 300-ton capacity is being installed at the Northport smelter. The other two are reducing Hercules and Tamarack & Custer ores.

In northern Washington, particularly in this county, highway officials are assisting the mining companies to finance construction of connecting links with the State roads, and are offering every inducement within their power to encourage development of the mineral resources of the region. For the first time in the history of the State, public officers are beginning to recognize mining as an industry worthy of being fos-

tered, and the outlook in this regard is particularly promising, according to the Northwestern Mining News Service of Spokane.

The Norman Mines Co., which is operating the Great Western and Last Chance mines near Northport under lease and bond, has contracted 3000 tons of zinc carbonate (29% metal) ore to the Kusa Spelter Co., Dewar, Oklahoma, delivery to be made at the rate of 500 to 1000 tons monthly.

WISCONSIN

There is a shortage of shovelers in the southern zinc centres of the State. Shovelers and can men are earning \$2.75 to \$3 per shift. Fully 500 more men could easily find employment, and operators claim this shortage is responsible for about one-third decreased output.

CANADA

BRITISH COLUMBIA

On April 10 the Standard Silver-Lead company paid 2½c. per share, or \$50,000, making \$200,000 for 1916 and \$2,000,000 to date. The mine is opened by seven adits, with No. 8 being driven. Crude ore shipments average 50% lead and 85% silver, and milling ore 10% lead, 18 oz. silver, and 10% zinc.

The Hope district is fairly quiet at present, but a revival is expected this season. Some rich gold ore has been sacked by M. Merrick for shipment to the Selby smelter. There is a large area of gold-bearing country unprospected, extending from Ruby creek in the state of Washington through Lilloet and Bridge river to the Chilcooten country. It is not easy ground to prospect. Capital is wanted. A few placer miners are working on the Coquahalla river.

ONTARIO

A steel head-frame at the Hollinger's Acme shaft is almost complete. The large hoist will not be ready at the manufacturers for 10 weeks. Considerable work is being done at a depth of 1250 feet.

At the McIntyre mine the 1000-ft. level station is finished. A 50-ton Callow flotation plant is to be built at the Sable River Mining Co.'s copper mine, between Sudbury and the Soo. The mineral is chalcopryrite.

A 50-ton Callow flotation plant is to be erected by the Penn-Canadian company.

During March 144 tons of high and 6698 tons of low grade ores at the Nipissing yielded \$169,999. Including custom ore the refinery produced 551,921 oz. silver. A winze sunk 150 ft. below the 490-ft. level of No. 73 shaft cut Keewatin and several faults. Further work in this area cut three 4 to 5-in. veins assaying from 500 to 2500 oz. per ton. At shaft 81 Keewatin is expected at 535 feet.

KOREA

The Seoul Mining Co., operating the Suan concession in Whanghai province, Chosen, reports the following for March:

| | |
|------------------------|-----------|
| Bullion produced | \$ 65,090 |
| Concentrates | 75,455 |
| <hr/> | |
| Total recovery | \$140,545 |
| Expenses | \$ 55,000 |
| <hr/> | |
| Operating profit | \$ 85,545 |

Copper is figured at 12c. per pound.

PHILIPPINE ISLANDS

The annual meeting of the Benguet Consolidated Mining Co. was held at Manila during February. The new mill near Bagnio commenced work in September last, yielding a net profit of ₱42,010 in the past four months. The first half of February produced gold worth ₱27,294. The average output will be over ₱40,000 per month. The present 60-ton plant is to be enlarged.

PERSONAL

Note: The Editor invites members of the profession to send him particulars of their work and appointments. This information is of unquestioned interest to our readers.

JAS. W. NEILL is in town.

P. B. McDONALD is at Ely, Nevada.

R. A. KINZIE has gone to Globe, Arizona.

EDGAR A. COLLINS is at La Crescenta, California.

C. B. KINGSTON has left London on his return to Rhodesia.

W. DE L. BENEDICT is expected in San Francisco, from New York.

T. J. JONES has left London on his return to Kyshtim, Siberia.

L. D. RICKETTS, on his return from South America, has gone to Arizona.

FORBES RICKARD was at Lovelock, Nevada, last week, going thence to Chicago.

E. A. WALLEES has been elected president of the Transvaal Chamber of Mines.

VICTOR C. ALDERSON is manager for the Winnemucca Mining & Milling Company, Nevada.

NEWTON B. KNOX has been appointed consulting engineer to the Minas de Phoenicia in Spain.

J. A. BURGESS has been appointed manager of the United Eastern mine at Oatman, Arizona.

A. B. HALL has been appointed consulting engineer to the Aurora Mines Co. at Aurora, Nevada.

HENRY M. PAYNE has been lecturing at several mining schools; this week at Rolla, Missouri.

S. W. COHEN, general manager for the Crown-Reserve Mining Co. at Cobalt, is touring in California.

C. ERB WUENSCHE has obtained an appointment on the staff of the Butters Salvador company in Salvador.

EDWARD E. CARPENTER has been promoted from mill superintendent to manager of the Nevada Wonder mine at Wonder, Nevada.

F. W. SPERR addressed the Gogebic Range Mining Association at Ironwood, Michigan, April 22, on 'The Block Caving Method of Stopping Large Orebodies.'

WILLIAM THOMLINSON, representing British Columbia, has joined W. D. DALGLISH and F. H. MASON on the mineral department of the Canadian Commission at San Diego.

H. P. WHERRY, superintendent of the Fields Mining & Milling Co.'s mines, has resigned to become the head of a new organization to operate the Brown-Level mine, in Wisconsin.

R. B. LAMB has moved his office to 25 Broad St., New York. He is now consulting engineer to the Oatman Southern Mining & Milling Co. and the Pittsburg Mining & Milling Co., both operating mines at Oatman, Arizona.

HUNTER B. SUPPLEE, a well-known mining man in central Idaho, died at Philadelphia on April 6 of heart failure.

A. L. HORNER, general manager of the Springfield Tunnel & Development Co. of Columbia, Tuolumne county, California, died last week after an illness of five months.

The Montana Society of Engineers is arranging a big meeting at Helena on June 6, 7, and 8. Trips are to be made to the lead smelter at East Helena, the power-plant of the Montana Power Co. at Hauer lake, and the Scratch Gravel mining district.

On May 2 the CHAMBER OF MINES AND OIL of Los Angeles holds its annual meeting and dinner. Address will be given by Seeley W. Mudd, Warren C. Kennedy, and Theodore Martin, while Edward L. Doheny has charge of a long film showing the Cerro Azul No. 4 oil-well, brought-in on February 10, 1916. Over 1,000,000 bbl. gushed-out before the well was under control.

THE METAL MARKET

METAL PRICES

San Francisco, April 27

| | |
|---|-----------|
| Antimony, 50% product, per pound | 42 |
| Electrolytic copper, cents per pound | 31 |
| Pig lead, cents per pound | 8.00-8.80 |
| Platinum, soft metal, per ounce | \$80 |
| Platinum, red metal, 10% rhodium, per ounce | \$89 |
| Quicksilver, per flask of 75 lb. | \$125 |
| Spelter, cents per pound | 22 |
| Tin, cents per pound | 50 |
| Zinc-dust, cents per pound | 30 |

ORE PRICES

San Francisco, April 27

| | |
|---|--------|
| Antimony, 50% product, per unit of 1c, or 20 lb. | \$2.25 |
| Chrome, 10% and over, f.o.b. cars California, per ton | 12.50 |
| Manganese, 50% metal, 8% silica, per ton | 12.00 |
| Tungsten, 60% Wo., per unit of 20 lb. | 70.00 |

A drop in antimony ore is expected.

A further recession in the price of tungsten is looked for by the Foot Mineral Co. of Philadelphia in June and July, as a surplus will be thrown on the market. This firm is paying \$58 per unit for 100% product, and a bonus of 25c. per unit for each unit over 100% and a penalty for each under that percentage.

New York, April 19

Dealers report that the situation with regard to South American antimony is exceedingly difficult, inasmuch as there are buyers of the ore in New York, but the shipping difficulties are almost insurmountable. The freight-rate has been doubled, and still it is difficult to find cargo-space. The result is that dealers only offer on the basis of f.o.b. South American ports. The nominal quotation is \$2.00 per unit.

The demand for tungsten is good and the market is firm. Small quantities have changed hands at \$85 per unit, but larger buyers are unwilling to pay over \$80. Tungsten also is adversely affected by the costly and inadequate freight service from South America, from where a large shipment arrived last week.

EASTERN METAL MARKET

(By wire from New York.)

April 27. Copper is strong and active; lead is dull and independent; zinc quote lower; spelter is quiet and weak.

COPPER

Prices of electrolytic in New York, in cents per pound.

| Date | Average week ending |
|---------|---------------------|
| Apr. 19 | 28.50 |
| " 20 | 28.50 |
| " 21 | 28.50 |
| " 22 | 28.50 |
| " 23 | 28.50 |
| " 24 | 28.50 |
| " 25 | 28.50 |

Monthly averages.

| 1914 | 1915 | 1916 | 1914 | 1915 | 1916 |
|------|-------|-------|-------|-------|-------|
| Jan. | 14.21 | 13.60 | 24.50 | 13.26 | 19.69 |
| Feb. | 14.48 | 14.88 | 26.62 | 12.34 | 17.27 |
| Mch. | 14.11 | 14.89 | 26.65 | 12.02 | 17.69 |
| Apr. | 14.19 | 16.84 | 27.50 | 11.10 | 17.90 |
| May | 13.97 | 18.71 | 27.50 | 11.75 | 18.88 |
| June | 13.60 | 19.75 | 28.50 | 12.75 | 20.67 |

Grady's Co. sold a quantity of 3,555 111 lb. in March, an increase of nearly 1,000 lb. over February.

Bradley in 1917 yielded 36,972 lbs. Pb. The net profit was \$1,617,775. Output of Bradley in 1914 was 31,000 lbs.

SILVER

Below are given the average New York quotations, in cents per ounce, of fine silver.

| Date | Average week ending |
|-------------|---------------------|
| Apr. 19 | 61.50 |
| " 20 | 61.50 |
| " 21 Monday | 61.50 |
| " 22 | 61.50 |
| " 23 Sunday | 61.50 |
| " 24 | 61.50 |
| " 25 | 61.50 |

Monthly averages.

| 1914 | 1915 | 1916 | 1914 | 1915 | 1916 |
|------|-------|-------|-------|-------|-------|
| Jan. | 57.58 | 48.85 | 56.76 | 51.90 | 47.52 |
| Feb. | 57.53 | 48.45 | 56.74 | 51.35 | 47.11 |
| Mch. | 58.01 | 50.61 | 57.89 | 53.75 | 48.77 |
| Apr. | 58.52 | 50.25 | 57.89 | 51.12 | 49.40 |
| May | 58.21 | 49.87 | 57.89 | 49.12 | 51.88 |
| June | 56.43 | 49.03 | 57.89 | 49.27 | 55.34 |

Steadiness, then strong upward movements are features of the market. There is strong demand for English and Continental coinage and to some extent for India. American supplies for export are moderate, sellers being reluctant, and as long as this is so, further strength is expected in London. Late in March 6,000,000 oz. was transferred from China to India, suggesting buying by the Indian mint. An April 22 silver worth \$126,362 was sent from San Francisco to China. A report on trade between China and Japan in 1915 shows a remarkable change in value due to the fall in silver last year.

LEAD

Lead is quoted in cents per pound, New York delivery.

| Date | Average week ending |
|-------------|---------------------|
| Apr. 19 | 7.75 |
| " 20 | 7.62 |
| " 21 | 7.50 |
| " 22 | 7.50 |
| " 23 Sunday | 7.50 |
| " 24 | 7.50 |
| " 25 | 7.50 |

Monthly averages.

| 1914 | 1915 | 1916 | 1914 | 1915 | 1916 |
|------|------|------|------|------|------|
| Jan. | 4.11 | 3.73 | 5.95 | 3.80 | 5.59 |
| Feb. | 4.02 | 3.82 | 6.23 | 3.86 | 4.67 |
| Mch. | 3.91 | 4.01 | 7.26 | 3.82 | 4.62 |
| Apr. | 3.86 | 4.21 | 7.26 | 3.60 | 4.62 |
| May | 3.90 | 4.24 | 7.26 | 3.68 | 5.15 |
| June | 3.90 | 5.75 | 7.26 | 3.80 | 5.24 |

QUICKSILVER

The primary market for quicksilver is San Francisco, California being the largest producer. The price is fixed in the open market, according to quantity. Prices, in dollars per flask of 75 pounds:

Week ending

| Date | Average week ending |
|---------|---------------------|
| Apr. 11 | 152 |
| Mch. 28 | 136 |
| Apr. 4 | 125 |

Monthly averages.

| 1914 | 1915 | 1916 | 1914 | 1915 | 1916 |
|------|-------|-------|--------|-------|--------|
| Jan. | 39.25 | 51.90 | 222.00 | 37.50 | 55.00 |
| Feb. | 39.00 | 60.00 | 295.00 | 30.00 | 33.75 |
| Mch. | 39.00 | 78.00 | 219.00 | 76.25 | 91.00 |
| Apr. | 38.50 | 77.50 | 219.00 | 53.00 | 32.90 |
| May | 39.00 | 75.00 | 219.00 | 55.00 | 101.50 |
| June | 38.60 | 90.00 | 219.00 | 53.10 | 123.00 |

ZINC

Zinc is quoted as spelter, standard Western brands, New York delivery, in cents per pound.

| Date | Average week ending |
|-------------|---------------------|
| Apr. 19 | 15.25 |
| " 20 | 15.00 |
| " 21 | 18.75 |
| " 22 | 18.75 |
| " 23 Sunday | 18.75 |
| " 24 | 18.75 |
| " 25 | 18.50 |

Monthly averages.

| 1914 | 1915 | 1916 | 1914 | 1915 | 1916 |
|------|------|-------|-------|------|-------|
| Jan. | 5.14 | 6.30 | 18.21 | 4.75 | 20.54 |
| Feb. | 5.22 | 9.05 | 19.99 | 4.75 | 14.17 |
| Mch. | 5.12 | 8.40 | 18.40 | 5.16 | 14.14 |
| Apr. | 4.98 | 9.78 | 18.40 | 4.75 | 14.05 |
| May | 4.91 | 17.03 | 18.40 | 5.01 | 17.20 |
| June | 4.81 | 22.20 | 18.40 | 5.40 | 16.75 |

TIN

Prices in New York, in cents per pound.

| 1914 | 1915 | 1916 | 1914 | 1915 | 1916 |
|------|-------|-------|-------|-------|-------|
| Jan. | 37.85 | 34.40 | 41.76 | 31.60 | 37.38 |
| Feb. | 39.76 | 37.23 | 42.60 | 30.20 | 34.37 |
| Mch. | 38.10 | 48.76 | 50.50 | 33.10 | 33.12 |
| Apr. | 36.10 | 48.25 | 50.50 | 30.40 | 33.00 |
| May | 32.29 | 39.23 | 50.50 | 32.51 | 39.50 |
| June | 30.72 | 40.26 | 50.50 | 33.60 | 38.71 |

Tin is quiet at 49.50 cents.

Eastern Metal Market

New York, April 19.

The big buying of copper has subsided, leaving prices firm and producers pretty well sold-up for the next four months. Sales of fairly prompt metal have been made at 30c. It is estimated that 300,000,000 lb. is under contract. The zinc trade paused to digest the figures of the U. S. Geological Survey on the 1915 production and notes for 1916, but it is not thought that the increased production indicated will depress the market in the near future. What will happen after the War is another story. Lead has been dull on all sides; the crux of this metal situation lies in foreign demand. If it is renewed on a large scale prices will advance again, whereas domestic consumption alone is insufficient to hold them up. Tin is easier because of larger arrivals. Antimony is easier for the same reason. Aluminum is a trifle lower.

Exports of war munitions of all kinds—iron, steel, and metal products, are at their height, and likely to continue at full flood for some time. It is to be noted, however, that E. R. Stettinius, of the firm of J. P. Morgan & Co., fiscal and purchasing agent for Great Britain, on his recent return from London, brought no war orders with him and, when interviewed, stated that England and France were working at full capacity in making shells and he doubted that further orders for shells would be placed here. There is, however, heavy enquiry for steel rounds wherewith to complete orders in hand. The metal-working machinery line is quieter, although there is a good volume of scattered buying on the part of domestic manufacturers. Pig-iron is strong, but not especially active. Steel rails have been advanced \$5 per ton. Strike troubles are cropping up in many directions. To forestall trouble, apparently, the U. S. Steel Corporation has announced a general wage advance of 10%, effective May 1.

COPPER

For the present the large transactions are about over, not only because buyers are satisfied, but as producers have no metal to offer in quantities of important size this side of September. They are sold up for the next four months. It is estimated that during the big movement contracts were written for about 300,000,000 lb. Domestic consumers have continued in the market since the heavy purchasing subsided last week, and for prompt lots are paying premiums of 1½ to 2c. per lb. Electrolytic for September delivery is quoted at 28.50c., cash, New York. Lake for the same delivery is nominal at 28.75c., cash. May, June, and July electrolytic are quoted at 29 to 30c. A large quantity for June and July was taken on April 18 at 29.50c., and some May, June, and July at 30c. In fact 30c. copper is closer than it has been since the War started. Nearby positions are scarce. Lake is practically unobtainable this side of September, its nominal price for later deliveries being about 28.75c. Sales of high-grade Lake for nearby delivery are reported at 31c. The London market is strong at £138 for spot electrolytic. Cabled statistics show that stocks in Great Britain and France made a gain in the first half of April. On the 15th in the two countries stocks totaled 6807 tons, against 5528 tons on March 31, and 7988 tons on March 15. Exports in 18 days of April amounted to 14,273 tons. The domestic market continues remarkably firm despite the lessened activity.

ZINC

Last week there was some heavy buying, but it has tapered off, leaving quotations firm at higher levels. The New York quotation for prompt or April spelter yesterday (the 18th) was 19.25c., and that at St. Louis 19c. May delivery was quoted at 18.50c., St. Louis, and June at 17.75 to 18c. St. Louis. Third quarter can be done at about 16.50c. St. Louis. A moderate

business is now being done. The trade is intensely interested in the report on 1915 production made by C. E. Siebenthal of the U. S. Geological Survey, particularly in the figures bearing on the number of retorts to go into operation this year. At the beginning of 1916 there was under construction or contemplated 26,992 new retorts, whereas the number now is 49,612, making a total in operation, building, or contemplated no less than 206,270, capable of producing about 825,000 tons per annum. To this quantity must be added about 60,000 tons which, it is expected, will be produced in electrolytic plants. There are rumors of other zinc smelters. These figures, in the eyes of the trade, constitute a bear argument when the distant future is considered, but it is not thought that they will have any considerable effect on nearby prices. For one thing, the producers are well sold-up for this quarter, and a big demand is expected to develop for the third and fourth quarters. As for the future it is not expected that the market will hold to its present levels, although supporting influences will be consumption by the galvanizers whose buying has for months been far under normal. Until the War ends it cannot be forgotten that the United States is supplying the bulk of the spelter used in the world. The German and Belgian supply is confined to those countries. Great Britain is encouraging smelting in the United Kingdom, but a plentiful supply of ore, which must come from Australia and Mexico, cannot be had. The upset shipping conditions, and the troubles in Mexico are practically prohibitive. Exports in 18 days of this month totaled 1279 tons. The London quotation for spot on the 18th was £103. Sheet zinc is unchanged at 25c., f.o.b. mill, 8% off for cash.

LEAD

The market has continued dull, and the prices of independent producers show an easier tendency. The situation in lead may be summed up briefly as follows: All depends on export demand; if it is heavy it would not be surprising to see prices advance, if it does not materialize, prices certainly will recede. The domestic demand alone will not maintain present levels, let alone send them higher. In the past few days the export demand seems to have disappeared, and domestic consumers have shown themselves to be unwilling to pay the prices asked by independent producers, all of which has brought about a dull market. The A. S. & R. Co. continues to quote 7.50c., New York, and 7.42½c., St. Louis, but these quotations merely serve as a basis for averages. Independents ask 7.75c., New York, a price which probably could be shaded, and 7.62½c., St. Louis. The leading interest has booked some business, but not much has been done elsewhere. Exports in 18 days of this month were light, amounting to only 747 tons. The London quotation for spot on the 18th was £35 2s. 6d.

TIN

The quotation for spot tin yesterday (the 18th) was down to 51c., in a quiet market. In fact the market has been dull almost continuously, the only business of importance being last Friday (the 14th) when 300 tons changed hands. Consumers are well supplied for their current needs, and fairly large arrivals in the past few days have cleared-up apprehension on that score. Up to April 18, 1345 tons had arrived this month, and 5164 tons was afloat. A good part of the tin afloat is coming direct from the Straits Settlements, and will not be held-up at London or Liverpool.

ANTIMONY

Some fair-sized arrivals from Japan are offered and these, with the absence of buyers, have created an easier market. Spot Chinese and Japanese is offered at 41 to 42c. New American producers continue to be reported.

COMPANY REPORTS

EL PASO CONSOLIDATED GOLD MINING CO.

During 1913 and 1914 this Cripple Creek company made no profit, but last year that from 24,118 tons of company ore and royalty from 2994 tons of lessees' ore was \$37,433. Debts were reduced from \$79,000 to \$17,500. On April 1, 1916, the treasury contained \$1973. Sixteen leases are in force to the 700-ft. level. The company did 1230 ft. of development, and has 7000 tons of ore broken and 12,000 tons ready for breaking. Low grade ore in the mine and on dumps may be treated by flotation, either on a royalty basis or by the company. Joseph J. Darnell is superintendent.

TONOPAH MIDWAY MINING CO.

During 1915 lessees worked from No. 1 shaft, there being 40 men at work at present. The company sank No. 2 to 1330 ft. depth. At 1265 ft. a vein 15 ft. wide of \$3 to \$15 ore was cut. When opened from the 1300-ft. level this vein was flat in faulted country. At 137 ft. north from the shaft at 1330 ft. a vein 70 ft. wide was passed through, worth from \$2 to \$6 per ton. A winze opened \$10 to \$12 ore, but water was found, and work temporarily suspended. A total of 1057 ft. of work was done at \$7.60 per foot. Shaft-sinking cost \$42.79 and winzing \$26.94 per foot. Total expenditure was \$25,789. Revenue, including \$33,491 from assessments, and \$11,089 from royalties, totaled \$54,126. A balance of \$12,970 remains for 1916. W. J. Douglass is superintendent.

YUKON GOLD CO.

This company operates in Alaska, California, and Yukon territory. Results may be tabulated as follows:

| | Cubic yards | Gold recovered |
|--|-------------|----------------|
| Alaska (Iditarod) | 926,956 | \$815,598 |
| California (American, Butte, and Feather rivers) | 3,818,126 | 437,852 |
| Yukon (dredges at Dawson) | 5,941,975 | 2,456,597 |
| Yukon (hydraulicizing at Dawson) | 3,031,647 | 412,535 |
| Total | 12,817,804 | \$4,152,982 |

Expenditure in each district was \$358,407, \$172,118, \$1,333,908, and \$243,247, respectively. The profit was \$2,121,031, about \$200,000 less than in 1914. Dividends totaled \$1,050,000. Additional ground was purchased in Alaska and California, in the Ruby and Trinity regions.

Recoveries and costs were as follows:

| | Gold saved Cents per yd. | Cost Cents per yd. |
|------------------------------|-----------------------------|-----------------------|
| Dredging in Alaska | 91.30 | 38.70 |
| Dredging in Yukon | 48.73 | 26.46 |
| Dredging in California | 11.46 | 4.51 |
| Hydraulicizing | 13.60 | 7.00 |

INSPIRATION CONSOLIDATED COPPER CO.

During one day early in April this company's mine at Miami, Arizona, produced 18,000 tons of ore without any effort; a year ago the experimental mill was receiving 600 tons a day. This comparison should indicate the progress made during 1915. The report of the general manager, C. E. Mills, includes the following for the past year:

No attempt was made to develop additional ore, so reserves remain as before, namely, 97,143,000 tons averaging 1.63% copper. Underground work preparatory to mining totaled 109,546 ft., and 337,130 ft. to date. With the caving system of ore extraction it will be possible to make a large output with relatively small labor force and at a low cost.

The first unit of the new mill started work on June 29, 1915, the last in February 1916. Twelve were operating at the end of December. There was treated 778,851 tons of 1.702% ore, yielding 20,967,310 lb. copper, with 79.95% recovery. Oxide ore sent to the smelter added 378,360 lb. to the mill total. The cost was 8.136c. per pound of copper for all departments. Of the 20,445,610 lb. produced, 6,134,355 lb. was delivered, realizing \$1,138,878. Including the metal on hand the profit was \$600,062. An initial quarterly dividend of \$1.25 per share was paid on May 1, 1916.

PLYMOUTH CONSOLIDATED GOLD MINES

Companies operating on the Mother Lode of California would profit by reading the report of this company for 1915, as it shows how a report should be published for shareholders and the public. Although signed by the general managers Bewick, Moreing & Co., the superintendent at the mine is James F. Parks.

Development covered a total of 4517 ft. The main shaft was sunk 296 ft. on the incline to a vertical depth of 2360 ft. Ore-bins were cut-out at 950, 1065, 1200, and 2300 ft. A new level has since been opened at 2450 ft. At 1200 ft. depth an east cross-cut was driven 77 ft., and from 40 ft. to that point 73 in. of ore averaged \$9.60 per ton. On the 1400-ft. level a north drift off the raise advanced 191 ft. in \$9.60 ore for a width of 113 in. A raise south, extended 158 ft. in ore, averaged \$11.04 over 85 in. A south drift opened 70 in. of \$6.72 ore over a length of 86 ft. At 1500 ft. is 123 in. of \$1.32 ore; at 2000 ft. 60 in. of \$4.08 ore between 37 and 202 ft. north. At 2150 ft. the main north and south drifts opened 65 and 90 ft. of \$10.56 and \$12.48 ore over a width of 62 and 138 in., respectively. At 2300 ft. there is 90 ft. of \$5.94 ore across 67 in. in the north drift. The south opening is in ore of irregular value. There was mined from 8 levels a total of 129,500 tons.

The mill recovered 22,098 oz. gold and 5925 oz. silver by amalgamation, while concentration saved 9095 oz. and 2727 oz. respectively. The average yield was \$4.95 per ton.

The cost was as follows: Development, 46c.; mining, \$1.59c.; milling, 38c.; bullion and concentrate, 25c.; maintenance and general, 32c.; a total of \$3 per ton. The net profit was \$188,000, of which \$173,000 was paid in dividends. The balance for 1916 is \$12,000, against \$1060 brought forward to 1915.

FEDERAL MINING CO.

This is a subsidiary of the American Smelting & Refining Co., and operates mines and mills in the Coeur d'Alene, Idaho.

A comparative report for the past two years is as follows:

| | 1915 | 1911 |
|---|-------------|-------------|
| Operating earnings | \$2,782,658 | \$2,209,777 |
| Total deductions | 2,226,719 | 2,011,684 |
| Operating profits | \$ 455,939 | \$ 189,093 |
| Other income | 352,662 | 702,463 |
| Total income | \$ 808,601 | \$ 891,556 |
| Charges | 498,234 | 339,160 |
| Balance | \$ 310,367 | \$ 552,396 |
| Preferred dividend | 479,443 | 539,304 |
| Deficit | \$ 169,076 | \$ 46,908 |
| Previous surplus | 1,388,614 | 1,435,522 |
| Total surplus | \$1,219,538 | \$1,388,614 |
| Cash on hand December 31 amounted to \$548,703. | | |

There was mined at all properties 461,252 wet tons of ore, of which 29,371 tons was first class. There was milled 408,315 dry tons, an average of 34,926 per month. Reserve milling ore on January 1, 1916, amounted to 1,107,600 tons; 131,379 tons of concentrate, and 68,108 tons of first-class ore. There was

produced 66,610 tons of lead concentrate, and shipping ore averaging 40.20% lead and 14.77 oz. silver per ton; 8839 tons of zinc shipping ore and concentrate containing 42.46% zinc; of this amount 29,338 tons was first-class shipping lead ore which carried from 22.95 to 52.25% lead and averaged 30.43%.

GOLDFIELD CONSOLIDATED MINES CO.
AURORA CONSOLIDATED MINES CO.

As the first named controls the other, the report of these two Nevada companies may be considered together. J. W. Hutchinson is general manager for both, and the following notes are from his report for 1915. At Goldfield the mine and mill superintendents are J. B. Kendall and J. B. Lain, respectively, while at Aurora, R. A. Hardy is the general superintendent.

Development amounted to 34,603 ft. at a cost of \$5.73 per foot. No discoveries of unknown orebodies were made during the year, but exploration was directed toward ground in which there are chances of finding extensions of known shoots. Reserves of measurable ore amount to 105,000 tons, but it is safe to say that 250,000 tons can be counted in addition. Some ore was extracted by lessees. There was one fatal accident in the mine due to carelessness of the miner. The copper-gold ore is to be treated by flotation. This ore occurs below the 750-ft. level, and little development has been done there of late pending final results of testing. There was extracted 335,553 tons of milling ore by the company, and 11,162 tons by lessees; also 4154 tons of copper-gold ore for the smelters. The Mohawk mine contributed 193,802 tons of ore. Stopping cost \$2.67 per ton. Square-set stopes produced \$1.19% of the total.

The mill treated an average of 1057 tons per day, a total of 385,900 tons, averaging \$10.37 per ton. Of this, 43,339 tons of \$5.99 ore was from dumps. The recovery was 90.45%, at a cost of \$1.414 per ton, a reduction of 22 cents. The net cost in all departments was \$5.02 per ton, a decrease of \$1.03. The total bullion saved was \$3,621,269. Smelter settlements, etc., brought the net revenue to \$3,515,834. The operating profit was \$1,558,308. One dividend of 15c. and three of 10c. each were paid, a total of \$1,601,617. Cash at the beginning of the year was \$655,703; at the end \$573,370.

Total production to date is 2,506,139 tons of ore for \$67,322,101, an average of \$27.06 per ton, and \$28,999,832 in dividends, or \$8.15 per share.

Owing to treatment troubles the Aurora Consolidated mill was idle in February and March of 1915, when new filters were installed. There was treated 138,399 tons of ore, averaging \$4 per ton. The operating profit was \$32,984, but new construction turned this into a loss of \$22,377. Costs totaled \$3.216 per ton, excluding new plant. The company's debt is \$400,000.

Development amounted to 4900 ft., at a cost of \$8.10 per foot. Ore reserves are estimated at 414,000 tons, 365,000 of which are in the Humboldt vein. Neither the quantity of ore nor the grade thereof has checked the original estimate, so it is probable that the investment of the Goldfield Consolidated company in the Aurora may not be profitable. However, there is much unexplored ground with possibilities.

ALASKA GOLD MINES CO.
ALASKA GASTINEAU MINING CO.

Accompanied by plans and photographs the report of this company for 1915 is of special interest, in view of the scope of operations and criticism that has been leveled at the undertaking generally. The managing director, D. C. Jackling, reported that the year was one of particular interest. In July 1912 it was estimated that the general program would admit of part of the plant being operated by the first of 1915; this actually commenced on February 12. By November the mill was treating 6000 tons per day. To supply power for 12,000

tons daily, the Annex scheme of 4000 hp. was partly finished. Operations have shown that the mill is capable of dealing with 10,000 tons in March 1916. At the mine another 3000-cu. ft. compressor was installed, a concrete dry-room erected, machine-shop re-arranged, the Sheep Creek railway improved, snow-sheds built, the whole being able to handle 12,000 tons per day.

Development totaled 17,346 ft. of openings, and 5943 ft. of diamond-drilling. Aetnal operation and stoping divulged new and important facts relative to the distribution of gold. The highest grade ore occurs in the schist body opened in No. 2 east stope on No. 5 level, and No. 6 east on No. 9 and 10 levels, this schist having a strong 'rake' to the east, appearing farther away from the central shaft and workings on deeper levels, until at No. 10 it is first encountered east of No. 2 shaft. The ore from this section averaged \$2 per ton by sampling and mill runs. The slate orebody is the lowest grade so far de-

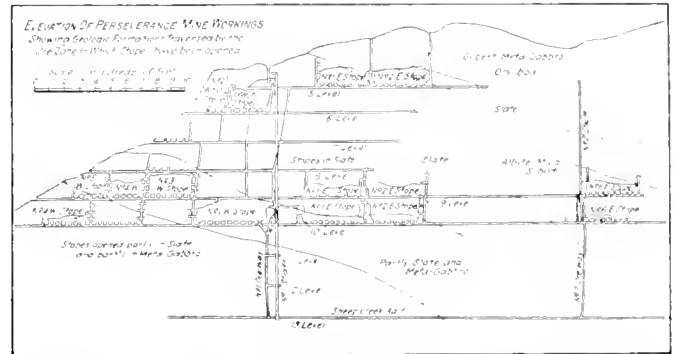

veloped, particularly west of No. 1 shaft, where the vein widens to 140 and 210 ft. East of the shaft below No. 5 level the slate orebody is narrower and higher grade. West of the shaft below No. 9 and down to the Sheep Creek level the deposit is of meta-gabbro and slate. Sampling has shown better ore than in the slate body. It had been decided from sampling, etc., that if a mixture of ore of 25% of schist, 25% of one slate, and 50% of another slate, the mill could be supplied with ore of average grade. This was proved true, but as mining progressed, it was found, due to the rake of the schist orebody, that No. 6 stope east on No. 9 level rapidly passed out of the schist into lower grade slate; and No. 1 stope east on No. 5 level, lying under the schist, did not supply as high grade ore as was expected, because the underlying slate caved away and prevented any mining in the schist at all, thus giving poor ore, whereas high-grade ore had been counted on. Later on this schist orebody will contribute such ore when attacked from another direction. This resulted in less ore being sent to the mill and the grade dropping to nearly \$1 per ton, details of which have already been published. Ore broken in stopes at the end of 1915 totaled 1,400,984 tons, an increase of nearly a million tons compared with the quantity at the beginning. The cost of ore-breaking was 17.22c. per ton, plus 5.25c. for preparing new stopes. Underground tramming cost 4.997c.; and on surface, 3½ miles to the mill, 3.641c. During November, the month of maximum tonnage, ore was delivered to the plant for 28.499c. per ton.

The mill treated 1,115,294 tons of \$1.1569 ore, with 81.06% recovery. Tailing assayed 21.91c. The average cost of milling was 30.496c., but on 6000 tons a day it was down to 25.699c. Every cost made a total of 69.039c. per ton. The year's results in all departments were uniformly satisfactory, and more than confirmatory of estimates, except the grade of ore delivered.

Of the gold recovered worth \$1,016,104, the profit was \$251,848, plus \$26,923 miscellaneous.

Operating officials at the mine are B. L. Thane, manager; G. T. Jackson, assistant manager; B. B. Nieding, superintendent of mines; H. L. Wollenburg, chief engineer; and E. V. Daveler, superintendent of metallurgical department.

BOOK REVIEWS

SIX PLACE LOGARITHMS. By Horace Wilmer Marsh. P. 10. John Wiley & Sons, Inc., New York. For sale by the MINING AND SCIENTIFIC PRESS. Price, \$1.25.

This is a well-printed book of six place logarithms arranged in the usual way. The table of logarithms of numbers has the first three figures of the number in the margin. Columns across the page give the fourth figure. The tables of logarithmic sines and tangents are figured for ten-second intervals. Proportional parts for interpolation are given in the tables for both the numbers and the trigonometric functions. There is also a seven-place table of lengths of circular arcs and a few miscellaneous mathematical tables. There is a short chapter of instruction for the use of the tables, which is entirely correct as far as the tables themselves are concerned, but which might give the novice the impression that logarithms must necessarily be to the base 10. The book will be of value both in the class-room, drafting-room, and office, rather than in the field. Since four-place tables are usually sufficient in the field, this is not a matter of importance.

THE MINING WORLD INDEX OF CURRENT LITERATURE. Vol. VIII, last half year of 1915. By Geo. E. Sisley, Associate Editor of *Mining & Engineering World*. P. 288. Index. Published by the Mining World Co., Monadnock Bldg., Chicago. Can be obtained through the MINING AND SCIENTIFIC PRESS. Price \$2.

An index of engineering articles sounds attractive to a neophyte. He imagines that by consulting such an index it is possible to immediately find exactly what he wants. It must be admitted that occasionally this works out nicely, but most indexes are an introduction to a Chinese puzzle. As to the Mining World index it can be said that a good deal of credit is due to the compilers not only for the assiduous scanning of a tremendous array of publications in half a dozen languages, but for the policy of giving more importance to the author than to the title of the article indexed. Titles are delusions, authors are remembered. For the rest, the Mining World index is sufficiently well known to need no introduction. The chief criticism has been that an index published by a paper of the same class is likely to give unmerited attention to the articles appearing in its own columns.

U. S. Bureau of Mines, Washington, D. C., 1916:

HOW A MINER CAN AVOID SOME DANGEROUS DISEASES. By A. J. Lanza and Joseph H. White. Miners' circular 29. P. 26. Illustrated. Practical notes on an important subject.

ECONOMIC METHODS OF UTILIZING WESTERN LIGNITES. By E. J. Babcock. Bulletin 89. P. 73. Ill. index. The largest workable deposits of this kind of coal are in North Dakota, Montana, Wyoming, Colorado, and Texas, the first named being the greatest. Their importance has not been appreciated nor have they been adequately utilized.

GRAPHIC STUDIES OF ULTIMATE ANALYSES OF COALS. By Oliver C. Ralston, with a preface by Horace C. Porter. Technical paper 93. P. 14. Ill. charts.

ABSTRACTS OF CURRENT DECISIONS ON MINES AND MINING, MAY TO SEPTEMBER, 1915. By J. W. Thompson. Bulletin 113, law serial 6. P. 122.

MANUFACTURE OF GASOLINE AND BENZENE-TOLUENE FROM PETROLEUM AND OTHER HYDROCARBONS. By W. F. Rittman, C. B. Dutton, and E. W. Dean, with a bibliography (41 pages) by M. S. Howard. Bulletin 114, petroleum technology 29. P. 268. Ill. index. This important publication should be secured by all interested in oil and gasoline, especially at this time when so much is being said about gasoline.

INDUSTRIAL NOTES

In the April Leschen's Hercules, among other interesting matter is a brief description of the plant that manufactures Leschen's wire rope at St. Louis, Missouri.

'Roebbling Wire Rope' is the name of the bulletin of John A. Roebbling's Sons Co., Trenton, New Jersey, giving information of service to wire-rope users. Special articles are written by engineers of the company, citing examples of good wire-rope practice. Particular attention is given to the care and proper use of wire rope in service.

On and after April 17 the Los Angeles office of the PACIFIC TASK & PUMP Co. will be at rooms 910-912 Trust and Savings building, north-west corner of Sixth and Spring streets. The company has just erected a new and larger plant at East Wilmington, which is near the harbor of Los Angeles, and is equipped to complete business in better ways than before.

Bulletin No. 56 and others (18 pages) of the BYRON JACKSON Iron Works, Inc., of San Francisco, are all about the pumps that this firm manufactures, including the following: Belt-driven centrifugals for irrigation, direct-connected centrifugals, single-stage centrifugals, dredging gravel and slime pumps, improved deep-well turbine-pumps, and multiple turbine and series centrifugals. All kinds of mine pumps are described and illustrated. Useful data are also given.

'Waterproof Graphite Grease' is the title of a new 16 page booklet published by the JOSEPH DIXON CRUCIBLE Co., Jersey city, New Jersey. This useful little book explains concisely and clearly how many difficult lubricating problems have been overcome. It also deals with the care and up-keep of heavy, slow-moving machinery and parts that are exposed to unusual wear. Some of the subjects treated are lubrication of elevator plungers, the best way to handle wire rope, open gearing, dredge machinery, and rolling-mill lubrication, the lubrication of sugar-rolls, pulp, and paper machinery.

It is usually the case that a man interested in one line of goods does not care for anything except that particular line, and it means a saving to the firm which he purposes to patronize to send out the catalogs to a much larger list of consumers and give each one more complete data on the particular lines in which he is interested.

Such a catalog has just been published by the SMITH-BROOMFIELD Co. of Los Angeles. Instead of issuing one complete catalog containing all of its lines, there has been issued a catalog on the unit basis, namely, a separate catalog for each line of goods. For instance, one catalog covers pumps, engines, motors, and irrigation supplies; another contains garage machinery; while others contain pipe and fittings, valves, wood-working equipment, contractors' supplies, elevating, conveying, and power-transmission machinery, belting and pulleys, mining equipment, street contractors' supplies, etc. By furnishing separate catalogs in this way the firm is enabled to give much more complete data on each particular line than would be possible if all was combined in one book.

The MEES & GOTTFRED Co. has adopted the sectional form in issuing its new general catalog, and section No. 1 of 9th edition Catalog has just been received. This first section is one of the best publications of its kind. It treats of a portion only of the firm's line of conveying, elevating, screening, and mechanical power-transmitting machinery; that is, pulleys, couplings, shafting, etc., but is full of important data making it of permanent value to the engineer or plant superintendent. Of special interest is the descriptive matter it contains on 'short-centre' belt-drives, a departure from the usual methods of belt-driving, which makes it possible to install belt-drives under conditions where heretofore high-speed chains alone were considered practicable.



EDITORIAL



T. A. RICKARD, Editor

SILVER at 74½ cents is the highest since 1892; it compares with the low price of 46¼ on September 1, 1915. Gentlemen of Tonopah and Cobalt, shake!

UNDER 'special correspondence' we give our readers an interesting letter from Johannesburg. It is written by an engineer 'in the know' and contains some frank—and therefore useful—comment on Rand affairs.

TO Mr. Courtenay De Kalb we are indebted, in this issue, for a scholarly article on the origin of nitrate. The conditions under which this chemical deposit is produced in nature have been the subject of previous discussions in our pages; this time Mr. De Kalb finds an interesting analogy—incomplete as it may be—between New Mexico and Chile. If the Rodeo valley were five times more arid it might have compared with the Andean plateau as a place for the natural accretion of nitrate.

AMONG the resolutions passed by the Republicans of Boulder county, Colorado, was one demanding a tariff of \$50 per unit on tungsten, in order to kill competition from Australia and Portugal. This was unnecessary. The Australian government has placed an embargo on the shipment of tungsten anywhere except to England and her allies, and has fixed a price of \$11.50 per unit of 65% product at seaboard. As to Portugal, we think it unlikely that any tungsten ore will come from that country to the United States, all the output being commandeered for use in England and France, at least for the duration of the War.

STRAIGHT TALK on metallurgical practice is of the greatest value to smelter-men; it is rarely possible to obtain information that has not been censored by authority or bowdlerized by convention. The roasting of lead ores just now is a subject of timely interest by reason of the starting of new lead-smelting plants in the North-west. It is difficult to obtain an unvarnished record of experience in this branch of technology, therefore the description, analysis, and criticism of the practice at East Helena should prove useful. The author's name is not given, but it will be obvious from the reading of the article that he is 'on the spot' in more senses than one.

THAT old yarn about Carrie Everson and the discovery of flotation is being revamped, with a Californian setting. That erudite newspaper *The Evening Howl* publishes a cock-and-bull story about a Miss Har-

riet Everson who discovered the process while on a visit to her brother at Kennett, in Shasta county. The cleaning of some pans, the spilling of kerosene on a copper-gold ore, and laughter at the absurd floating of the valuable minerals furnish the chromatic details for another myth. The lady is said to have obtained a patent, but she was obstructed by the numerous other patents taken out by 'some Italians in California.' Shades of Froment! Finally, her case is said to illustrate 'how a fortune was missed by a hairbreadth.' No; it illustrates how wilfully ignorant the daily press is, and nothing more.

ONE good feature of the rise in metals is that it is enriching a number of small operators; for instance, in southern Missouri the rise in zinc has doubled the number of persons paying income-tax this year as compared with the year before; and in the same way the exploiting of tungsten deposits on lease, in Colorado, Arizona, and Idaho, for example, has given a lot of men without capital the chance to win a fortune. Similarly the demand for quicksilver, magnesite, and manganese in California and Nevada has enabled many small operators to make a handsome turn by aid of the simplest equipment. Honest digging of mineral from the ground is prospering so greatly just now that the stock-market game has lost much of its attractiveness. The uncertainty as to metal prices gives sufficient speculative zest.

CONSIDERING the lavish publicity given by the *Boston News Bureau* to the Kennecott agglomeration, we are surprised pleasantly to see that interesting and enterprising paper giving a warning in regard to the huge capitalizations of copper companies and suggesting that speculators should not neglect to make enquiry into the number of shares issued against a given property. The Chile Copper and the Kennecott have 4,400,000 and 2,754,625 shares, respectively. This affords a violent contrast, for example, with the 100,000 shares of the Calumet & Hecla company, which has paid \$131,000,000 in dividends. Indeed, at one time the State of Michigan forbade an issue exceeding 100,000 shares against any copper mine, indicating how archaic old ideas have become in this branch of industry.

OUTCROPS and their story will always interest the miner, for by them he is guided in his search for the hidden ore. We take pleasure in publishing the first of a series of articles on 'Surficial Indications of Copper,' prepared by Mr. Frank H. Probert, Professor-designate of Mining in the University of California. The author

has had an experience fitting him to treat the subject from the economic point of view, that is, from that of the mining engineer. The first photographic illustration is an example of the kind of evidence most desired by the prospector, namely, the presence of rich ore. The mass of nearly pure copper sulphide in the limestone forming the crest of a snow-clad range in south-eastern Alaska has proved to be the top of a great bonanza, now being exploited by the Kennecott Copper Company. The more subtle signs of mineralization that led to the uncovering of the immense masses of enriched porphyry and schist, constituting the disseminated chalcocite deposits of Utah, Nevada, and Arizona, will be described in the later articles of this series. The subject is much to the point: for, after all, the first act of mining is to find ore. We must confess that the finding is usually less scientific, more accidental, than the mining and metallurgical operations that follow the discovery. Hitherto the mining engineer has had to follow in the tracks of the unsophisticated prospector, exploiting what his nomadic friend first explored. Only in recent years has the science of ore deposits achieved its economic purpose in furnishing an intelligent explanation of the processes whereby ore concentrations, particularly of copper, are formed underground. Even now, the amount of confident knowledge on the subject is small; all the more reason for making the most of it and of testing it as we proceed.

WHERE the zinc has gone is shown in recent statistics published by the Geological Survey. From these it is seen how the export of domestic spelter was 987 tons in the first 7 months of 1914, as compared with an exportation of 63,820 tons in the last 5 months of that year, and 70,349 tons in the first 7 months of 1915. Then the rate slackened so that in the last 5 months of last year the total exported was 47,447 tons, making the total for the year, 117,796 tons, as compared with 64,807 in the whole of 1914. Production rose from 353,049 to 489,519 tons, or at the rate of 39%, while domestic consumption increased from 299,125 to 364,382 tons, equivalent to 22%. The difference between these two increases was more than compensated by the exportation, which increased 82%, as shown above. Meanwhile the smelter capacity has been increased from 115,114 retorts at the end of 1914 to 156,658 at the close of 1915, and it is estimated that a further addition of fully 50,000 retorts is assured during the current year, bringing the total capacity to over 200,000 retorts, equivalent to an output of 825,000 tons. Taking into account the output of secondary and re-melted spelter, the United States will be in a position, at the end of 1916, to produce 900,000 tons, or nearly three times the probable domestic demand. In 1913 the world output of zinc was 1,102,456 tons. Obviously, the ending of the War will puncture this inflation of American productivity. The Geological Survey bulletin suggests that the smelting of the Australian output in this country would obviate a collapse, but we know already that most of the Broken Hill com-

pains have arranged for the treatment of their product in Australia on the basis of long-time contracts; and that of the two companies not included, one has a smelter in England and the other will make similar arrangements as soon as it can. Therefore no help is to be expected from Australia. In short, the present price for spelter is linked with the duration of the War.

MEXICAN affairs continue in a state of flux. The conference at El Paso between General Alvaro Obregon and General Hugh L. Scott, representing the military establishments of the two countries, has not been definitely concluded at the time of this writing, but it is clear that President Wilson will not consent to a withdrawal of the American expedition under General Pershing. If that expedition can remain where it is without provoking war with the Carranza government, it will be a consummation as unexpected as it will be satisfactory; for, once established in Northern Mexico, the American troops will be able to restore order and set an example that may lead to the final pacification of the country. The position is ticklish and forecasts are dangerous, but there is a good chance of our being able to avoid war. If on the other hand, Obregon insists on the withdrawal of General Pershing and his command, there will be nothing for it but to stand pat. We refuse to imagine that Mr. Wilson will indulge in another veracrusade; a retreat would invite attack and create the idea among the Mexicans that the American troops had been repulsed, whether by Villa or Carranza will be immaterial—it will be quite enough to encourage sniping and cutting of lines of communication, to be followed, of course, by counter-attack on the part of our men, and so to organized warfare. In short, the conference at El Paso will decide whether the United States is to remain a friend or become an active enemy of the Mexican government.

RESUMPTION of work at the Bishop Creek mine, in Inyo county, is mentioned as a possibility, if Mr. Gaylord Wilshire, the promoter of the enterprise, can collect adequate funds for the purpose, which includes the enlargement of the mill, now one of 10 stamps only. This mine has been the subject of some curious finance, in which Mr. Wilshire, Socialists, and British Guiana have featured at various dates. It appears that the promoter has been backed by several thousand Socialists; we know of no reason why they should not make good stockholders, but we can see that theoretically it is all wrong for a Socialist to draw the unearned increment of a productive gold mine. However, that is a detail. We see better reason why stockholders in a Californian mine should not be dependent for dividends on a property in British Guiana, by exchange of shares and interlocking of interests. That also may be said to be an academic objection, because no dividends did accrue. Then followed 'Safety First' \$55 notes, and 'Convertible 10% bonds.' All this was spread over six years. Now, Mr. Wilshire proposes to consolidate the wreckage

of all these past promotions, forming a Consolidated Wilshire Mining Company to be launched on an assessment of 6 cents per share wherewith to double the size and capacity of the mill at Bishop Creek. Whether the mine will earn more money with 20 stamps than with 10, we do not know. Doubling a mill does not always turn a losing operation into a profitable; sometimes it increases the loss as well as the tonnage. Mr. Wilshire, we believe, has not had sufficient experience in gold mining to pass judgment on a technical question of such immediate importance to 6000 shareholders. We suggest, in his own interest no less than in that of his supporters, that good professional advice be taken before the financial position is further complicated.

Quicksilver

Quicksilver has dropped to a nominal price of \$100. Last week an auction sale of 192 flasks in this city ended in a fiasco, the two lots being 'bought in' by the seller at \$100 and \$105. In the middle of February the price was \$300 per flask. The sudden break was due to unexpected shipments from Europe. The British government, on behalf of the Allies, had placed an embargo on export, so that quicksilver on the London market has remained steadily at £16½, or \$80, per flask, but when the scarcity in this country caused the price to soar, a protest was made by the Du Pont works, the chief manufacturer of fulminate for the Allies. Whereupon the British government gave permission to the Rothschilds, controlling the European production of mercury, to make some shipments to the United States, most of it going to the Du Pont works, but some of it to the California Cap Company, which manufactures fulminate for industrial uses only, that is, for blasting caps. When therefore a shipment of 1900 flasks arrived at New York from Spain, followed by 1100 more from Italy, and altogether fully 5000 flasks were sent across the water in about two months, the market broke with a suddenness that astounded many who had begun to speculate in the metal, more particularly in San Francisco. Moreover, the boosting of the quotation to six or seven times the ante-bellum price did have the effect of attracting the metal from a variety of places, for example, the stock held in reserve by sundry gold-mining companies and the 'quick' stored at silver mines in Mexico that had substituted cyanidation for pan amalgamation. Again, at \$300 it paid to apply rough water-concentration to many old dumps and extract small amounts, which, cumulatively, had an immediate effect on the market. After all, the normal annual production in the United States is only 20,000 flasks, so that a small increase lowers the price, unless the War demand is more than enough to absorb the new supplies. Concerning that, it would appear that production can be stimulated greatly by high prices and the War demand would have to last for several years before the easily accessible sources of supply were exhausted. In short, quicksilver is not likely to rise above its present quotation.

A World View

In one of those periodical pamphlets of useful information issued by the National City Bank of New York we found the statement that "obviously, Americans in business life who will lead in the future will be men of broader outlook than in the past—men with the 'world view'." That means, presumably, that the American of the future will try to understand foreign peoples preparatory to engaging in trade with them; that he will study historical geography in order to obtain guidance in his commercial expansion; that he will learn languages instead of fencing himself in a Monroe doctrine of linguistic incapacity. There is a distinct movement in this country toward a better comprehension of the ideas of foreign customers and a more intelligent appreciation of the ways of alien markets. Classes in Spanish, for example, are symptomatic of the belief that opportunities for enterprise are likely to offer themselves in South America. The notion is spreading that the industries of the United States are outgrowing domestic needs and that expansion abroad will prove profitable at an early date. For much of this the Great War is responsible; it has shattered the provincial egoism of our people, making it clear that no pronouncement of our own—whether by President Monroe or President Wilson—can ensure that avoidance of entangling alliances which was the avowed aim of the founders of this republic nor the splendid isolation that was the dream of doctrinaire statesmen, say, two years ago. The logic of events is incontrovertible. A condition, not a theory, confronts us. Facts are stubborn teachers. The American of the future will recognize them, lest he become a thing of the past. He will get "the world view," says the energetic New Yorker. What is that? We have mentioned some of the things it means, but a deeper significance is to be found in the phrase: it means leaving the parish pump and climbing the hillside; it means abandoning the valley road and ascending the snowy range; it means that a parochial self-sufficiency is to be discarded in favor of a wider mental horizon and a broader human outlook. Can we, as a people, reach that nobler altitude without the discipline of a great experience? The preceding generation passed through the trial of the Civil War and emerged, sobered and strengthened, ready for the development of this continent. When Blieriot crossed the Channel seven years ago he destroyed the isolation of Britain without decreasing the insularity of the British; but two years ago the flame of a great sentiment consumed that insularity amid the smoke of battle and beckoned the peoples overseas with a light of enthusiasm that is one of the fine things in a pentecostal calamity. Can we learn the lesson without undergoing the experience? Then let us watch Europe in deep seriousness and with intense sympathy. The great belligerents on both sides are fighting for big ideas; it is for us at least to respect the sacrifice of industrial welfare and personal comfort, nay, life itself, ungrudgingly, for something that is not measured in dollars and cents. Let us not,

like the Pharisee give thanks that we are not as other men are. The self-complacency that congratulates the American people on being outside the dread conflict is not in the least admirable. When we feel grateful for having escaped the horror, so far, let us thank the Atlantic, not our superiority over the gallant men who are dying for a principle and a purpose, and if we are spared to get the wider outlook from the high peak of success without being overwhelmed by the storm gathering on the farther summits let us learn that "the world view" begins at home: in the house, in the office; in the State, and in the United States. "That man's the best cosmopolite who loves his native country best" not merely proud of it, or boastful concerning it, but willing to surrender his comfort, his property, even his life, for it. The young man who wants to "have the world view" had better begin by being a good American before he ventures to sigh for new worlds to conquer. The first is no inconsiderable achievement, particularly in these days when hyphens have provoked a political appendicitis that threatens to require a surgical operation.

Leaving than ice and proceeding on firm ground, it is a noteworthy fact that the War has stimulated enquiry in new directions and furnished information of an unexpected kind. The movement of Russian troops, for example, whether the mythical passage through Scotland or the recent landing at Marseilles, has made most of us better informed concerning the geography of a country that is 7000 miles in extent from east to west. We have learned that a people of 170 millions has no ice-free port, that Archangel in the White Sea, facing the Arctic, has been made open to navigation a few months longer by the use of a Canadian ice-breaker, and that recently a new port and railway terminal has been established at Alexandrovsk, or Katerina, on the estuary of the Luta river, on the coast of Lapland, just round the corner from the northern end of Norway, where a warm current from the Atlantic ensures open water throughout the year. Again, take the activities of the sea-raiders, from the *Emden* to the *Mowwy*; everybody has had to consult the atlas in order to follow their movements, learning incidentally what trade-routes were affected and how coaling-stations are distributed over the seven seas. Even more informing has been the interference with trade in various commodities, causing us to learn the sources of supply of many things in common use. More particularly, the War has been the means of causing the average man to become interested in mineral products, the supply of which has been stopped or rendered abnormally expensive. The man in the street has taken an interest in the production of the metals and the technical man has studied the statistics of production with keener insight than heretofore. All of this has enlarged the mental horizon of the ordinary citizen and given him a little of that world view that distinguishes the man of education. For real education, by drawing out the better faculties, tends always to a larger sympathy and a better understanding. The time will come when the thickness, not the color, of the human skin will be

deemed decisive; when the spread of a common language will enable men of diverse countries to discover that the barriers of prejudice are lowered by the ability to exchange ideas; when at last there will be developed a world citizen, as able to reconcile loyalty to his native land with goodwill to other countries as he is now able to combine civic duty with devotion to home.

Mining Geologist

Should a special degree be created for proficiency in geology? This question is now being ventilated in the pages of *Economic Geology*. In its current issue we find letters on the subject from nine engineers and geologists competent to express an opinion. Mr. Robert Peele thinks that a good training in mining engineering is essential to a man intending to specialize in mining geology. Mr. F. Leslie Ransome remarks that "academic degrees in this country have very little significance," because they do not indicate the institutions by which they have been conferred. Mr. Ralph Arnold is heartily in favor of granting a degree in mining geology, but not until the candidate has obtained a bachelor's degree in geology, plus one year of practical experience. Mr. E. G. Spilsbury points to the lack of uniformity in geological curricula and agrees with Professor Peele that the proposed degree should involve a post-graduate course after mining engineering. Dr. A. R. Ledoux suggests 'economic geologist' as a proper title, to be granted after post-graduate study. Mr. J. Parke Channing recognizes the need for specialization and is not unfavorable to the granting of a special diploma, but he realizes that the multiplicity of degrees in technology has become confusing. Finally, Mr. R. V. Norris considers that the description 'mining geologist' has been so often abused by incompetent men that it may prove dangerous to use it as a university degree. These opinions have their personal interest and taken together they are likely to be representative of professional attitude on the matter. It would seem essential that any such degree should be supplementary to training and experience in mining engineering. We have 'geologists' and 'mining engineers;' if we are to have 'mining geologists' as specialists endorsed academically, they must combine the training of both their predecessors in professional practice. No geologist is competent to advise upon the exploratory or development work of a mine unless he is familiar with the technique of mining. Lack of such familiarity has caused many geologists to make sad blunders. Mining geology is essentially economic, that is, it deals with the making of money by the exploitation of ore deposits; therefore a familiarity with the operations of mining and metallurgy, more particularly the cost of such operations, is a pre-requisite to advice that is worth having. The geologist studies rocks and minerals, their origin and relations; the mining geologist applies that study to the business of making money by extracting metals out of those rocks and minerals. To do that he must understand mining engineering.



DISCUSSION

Our readers are invited to use this department for the discussion of technical and other matters pertaining to mining and metallurgy. The Editor welcomes the expression of views contrary to his own, believing that careful criticism is more valuable than casual compliment.

Cyanidation of Flotation Concentrate

The Editor:

Sir—In your discussion department of the 11th inst., I note an answer by Mr. E. M. Hamilton to your question as to whether flotation concentrate could be successfully cyanided. While a refugee in the States two years ago, I did some work along that line, and am at present engaged in a similar investigation with the ores of the El Oro district.

Herewith is a brief summary of some tests made on a low-grade ore from Lower California. The ore in question carried only 0.16 oz. gold and 0.25 oz. silver; the silver content being so low, I took no account of it in the concentration tests. Quite a number of small half-kilo tests were run with an M. S. machine to obtain sufficient concentrate for the cyanide work. The first composite concentrate obtained carried exactly one ounce of gold. This sample, ground to 200-mesh, was then treated with a 0.11% cyanide solution containing 20 lb. lime and 200 grams lead acetate per ton of ore. The ratio of solid to liquid was 1:3. Time of treatment was 91 hours. After 24 hours the cyanide had dropped so low that it was necessary to make up to strength again. The total consumption of cyanide was 20 lb. per ton of ore. Total lime consumption, 40 lb. approximately. The final residue assayed 0.03 oz. gold. Extraction, 97%.

The excessive consumption of cyanide was undoubtedly due to the presence of flotation-oil, although the amount of oil used in any test did not exceed one pound per ton.

Another test was run with the idea of removing the oil before cyanidation by a preliminary treatment with caustic soda. The composite concentrate in this case carried 0.50 oz. gold and was ground to 200-mesh and then treated with caustic soda solution (0.49% NaOH Solid; Liquid, 1:3). After 20 hours contact the effluent liquor carried 0.34% NaOH which represented a consumption of 9 lb. per ton of ore. The pulp was then charged to a small filter-press, the liquor was filtered off and the cake given a wash with clean water. The pulp was then charged to an agitator-jar and cyanide solution added: 0.15% KCN, 20 lb. CaO per ton of ore. The total consumption of cyanide in terms of KCN was 3.6 lb. per ton of ore. The residue assayed 0.07 oz. gold. Extraction, 86.1%. The lower extraction was possibly due to the fact that no lead acetate was added and that the time of agitation was so short as 24 hours. Nevertheless, it proves that the oil can be removed economically if it is

found to act as a cyanicide, as in the first experiment. A table-concentrate of this same ore had about the same cyanide consumption as the flotation concentrate after preliminary treatment with caustic soda.

In some cases, I believe, a very light calcination of such a concentrate would be sufficient to drive off the excess of any volatile oils that might be cyanicides. This step would be quite inexpensive, and cyanidation could afterward proceed in the usual manner.

Although it may be found in some instances that the extraction is not affected by leaving the oil in the ore, still I believe it may cause other serious difficulties when the amount of oil has increased sufficiently by re-use of the cyanide solution. I have particular reference to the difficulties that may arise in the precipitation end of the plant. This opinion is based on an experience obtained here, when, due to accidental causes, we had a large excess of oil in our gold-precipitation circuit.

It seems that a combination of oil, alkali, cyanide, and zinc-dust bring about the precipitation of a gelatinous compound that clogs the zinc-press cloths, causing the pressure to rise to dangerous limits. This occurred whenever we used air for displacing solution in the slime-presses. We found that the air carried considerable oil—a lard oil in the one case investigated. On the surface of the gold-tanks an oily scum was always present and the solutions never appeared very clear when using the air as previously mentioned.

The oily compound that formed in the zinc-presses was removed with iron scrapers in order to make the cloths permeable again. The following is an analysis of this compound removed from the cloths when we were having considerable trouble.

| | |
|-----------------------------------|-------|
| Hydrocarbons, by ignition | 88.95 |
| Residue ash (by difference) | 11.05 |
| Fe | 0.16 |
| Zn | 4.82 |
| CaO | 5.00 |
| Insoluble | 0.70 |

Au, 72.5 grams; Ag, 377.5 grams.

A qualitative examination of a gummy substance similar to the above showed a small amount of oil, and it contained lime, zinc oxide, small amount of lead, amorphous slime, and precipitate.

These two substances appear to be crude soaps, made by the saponification of the oils by the caustic alkali. I called the compound a 'crude soap' for lack of a better word. Raising the strength of the cyanide solution tended to lessen the trouble, but did not wholly stop it.

The above case is cited to show what might be expected to happen if certain flotation oils are not removed before cyanidation takes place. The same reaction would take place in a zinc box, no doubt, for zinc is zinc whether thiofer or dust. A nasty oily precipitate might finally accumulate, causing a decrease in flow and a drop in the precipitative efficiency of the zinc.

PAUL W. AVERY

El Oro, Mexico, March 31

We invite further correspondence on this important subject. Editor:

The Metric System

The Editor:

Sir—In your editorial note on page 538 you ask your readers to consider a new unit of measurement, which is to be 60 inches long, to be called *mu* and to be adopted by the Pan-American countries. Nothing is said as to the size or names of the standards for either weight or volume.

In response to your request, I have considered the above suggestion and find it to be absurd and superfluous, and I wish to record my protest against such an erratic proposal. What the world needs at present is the universal adoption of the metric system, now used by all the so-called civilized nations with the exception of the English-speaking countries and Russia. The metric system has been legalized in the United States since 1866 but has never come into extensive use except in chemical laboratories and assay-offices. An effort is now being made to hasten the inevitable adoption of the system. This effort is the Dillon bill, now before the House Committee on Coinage, Weights, and Measures; this bill declares that in four years from its passage the metric system shall be the sole standard of weights and measures in the United States and Section 4 of the bill states:

"That any person, corporation, company, society, or association who shall use, or offer and attempt to use, in any industrial or commercial transaction in the sale or purchase of any commodity any other weights and measures than those of the metric system on or after July 1, 1924, shall be guilty of a misdemeanor, and upon conviction thereof in any court of competent jurisdiction shall be punished by a fine of not more than \$500 or by imprisonment for not more than three months, or by both such fine and imprisonment."

In the opinion of those engineers whom I have consulted the passage of the Dillon bill will prove of great benefit to our trade and industry and will relieve our children of the painful task of learning a confusion of tables. Dr. J. V. Collins, of Wisconsin estimates that the annual saving to the country by the introduction of the metric system will be \$315,000,000. Probably this is an excessive valuation of the saving, but it is certain that the saving will be very great and the need for the adoption of the metric system is only equaled by the need for the reform of our chaotic spelling.

Therefore all engineers should lend their support to the Dillon bill. The change from our present system to

the metric will cause some trouble, but that will be speedily forgotten as soon as the system is in force. This was the experience in Germany, where its compulsory adoption was strenuously combated and where the newspapers were filled with violent articles against it. But after a few months all were satisfied and the same result will be reached here.

And I hope that you and your readers will not be led astray by specious arguments as to the fancied superiority of the duodecimal system in practical life, but will work for the speedy adoption of the metric system and to that end will write to your congressmen and senators in favor of the Dillon bill.

W. H. SHOCKLEY

Palo Alto, April 16.

Treatment of Slime-Residue

The Editor:

Sir—In your issue of January 1, Mr. W. Motherwell refers to the tipping of slime-residue on the sand-dump at the Occidental mine, near Colar, New South Wales.

The dump was about 50 ft. high, and the prevailing wind drove the sand in the direction of the leaching plant, encroaching to such an extent that it was found necessary to remove it repeatedly.

With the erection of the Moore filter-plant in 1905, the slime-residue was tipped around the edge of the dump, and practically stopped further encroachment. At this time water was not available for discharging this residue, but when the mine had reached a greater depth sufficient water was supplied from this source to enable a pumping scheme to be adopted. The Moore filter discharged its load into a hopper, which fed the residue onto a screen, made of parallel $\frac{3}{4}$ -inch bars one inch apart. Below this screen was a cone-bottomed tank, to which the suction of a 3-inch Morris centrifugal pump was attached. The delivery-pipe, at a point three feet above the screen, had a T-piece fitted. Into this was screwed a short piece of pipe, with a 3-inch plug-cock and bend attached delivering onto the screen. To operate the mixer, the tank was half-filled with water, and the pump started with the 3-inch cock wide open. The slime-residue was allowed to slide onto the bars, where it was cut up, and forced through the screen. In a few minutes the whole charge was disintegrated successfully. The cock was then closed and the residue pumped to the dump.

A. J. CHAPPLE.

Canbelego, N. S. W., March 23.

RAILWAY LINES to the extent of 1000 miles are owned and operated by Phelps, Dodge & Co. The El Paso & Southwestern Ry. connecting the Bisbee district of Arizona with El Paso, and including a branch to the Mexican mines of Phelps, Dodge & Co., is stated to be one of the best constructed and operated railways in North America, with modern locomotives and cars. The El Paso & Southwestern Ry. has been but little affected by the recent border troubles.

Origin of Nitrate

By Courtenay De Kalb

THEORIES advanced by investigators to account for the origin of sodium nitrate in Chile were reviewed in the MINING AND SCIENTIFIC PRESS (June 13, 1914) by Lester W. Strauss, following discussions of this problem in a series of papers published some years earlier in the Boletín de la Sociedad de Minería de Chile. These theories include (a) the action of static electricity liberating oxides of nitrogen, forming nitric acid in contact with the moisture of the air; (b) accumulation of nitrates in soil through the action of certain micro-organisms; (c) decomposition of sea-weed during an earlier marine epoch of the inter-Andean valley; (d) oxidation of nitrogen in vegetal matter in the soil, a calcium nitrate being first formed that, reacting with sodium chloride, would produce sodium nitrate, setting calcium chloride free; (e) aeolian deposits of guano dust, reacting with the soil constituents; (f) nitrogen-bearing volcanic waters. The outcome of the discussion, as Mr. Strauss says, is to leave the ultimate source of the nitrogen an unsolved problem.

The physical conditions in Chile consist of a coastal range about 5000 ft. high, between which and the high wall of the Andes lies an elevated plateau, sloping from the Andes toward the Coast range. The region is practically free from rains. It is recognized that a season of heavy precipitation would leach and ruin a great part of the nitrate field. Mist and fog, however, are of nightly occurrence during the winter months, and it is observed that some connection exists between these mists and the nitrate deposits. Whether this is an accidental or a genetic relationship is still a moot point. It should be noted that enough rain falls to produce, in the course of centuries, a downward migration of any salts formed along the higher slopes, but not enough to leach the lower soils. The tendency would thus be gradually to enrich the deposits along the western or lower side of the plateau or pampa.

A well known occurrence of nitrates near Rodeo, in south-western New Mexico, offers a hint of another probable mode of origin for the Chilean deposits. If the rain-fall at Rodeo were less than one inch per annum, and were confined chiefly to precipitation upon the mountain ranges bounding the Rodeo valley, it is practically certain that commercial deposits of nitrate would exist in this region. The rain-fall is above five inches, however, and the result is a valley possessing soils of extraordinary nitrogen content, famous for the production of beans by dry-farming.

The Rodeo valley trends north and south, bounded on the west by the lofty Chiricahui mountains, a range of igneous and metamorphic rocks, while on the east it is flanked by the Peloncillo range, consisting of rhyolite

tuffs, overlaid by thick rhyolite effusives. Block-faulting on a splendid scale has lifted the tuffs, with their lava-caps, into great scarps which have been eroded into fantastic architectural shapes. In places later faulting has tilted the beds so that the flow-planes of the lava-capping stand in a nearly vertical position.

The nitrate occurs as an incrustation upon the faces of the cliffs of tuff. It is more abundant where the rock has been recessed by aeolian wear, or protected by overhanging cornices of the sculptured surface, but it is present in some degree wherever the tuff is exposed. It forms in the parting-seams of the rock, layer after layer being found to a depth of many inches. In places the enriched seams extend to a depth of several feet. The highest concentrations do not exceed 6% of sodium and potassium nitrate, and for the most part the outer shell will not yield over 1.5%.

In the 'washes' along the drainage-line leading from the Peloncillo range into the valley the detritus shows cemented zones gray with salt that generally carries from 1% to 2.5% of nitrate. Thus the migration of the salt toward the valley is conspicuous.

Very noticeable is the fact that where the tuff beds with their lava-caps have been faulted into a vertical position the amount of nitrate formed on the surface of the tuff is insignificant. The richer incrustations occur where the beds of tuff dip slightly toward the valley. It is also interesting to observe that the lava-capping possesses a rudely columnar structure, so that the precipitation to a large extent finds its way through the jointure into the underlying tuffs, which consequently are always moist at a depth of a few inches from the surface. Where the tuff forms the crest of the mountain no such phenomenon is seen, the rocks being peculiarly free from moisture.

The evidence is abundant that the nitrate is formed in the tuff, and is exuded toward the surface by seepage, which is mainly capillary.

The alteration of the tuff has been extreme, so that fresh specimens are difficult to obtain. Kaolinization has gone forward, with the formation of many hydrous aluminum silicates. Also the amount of magnetite in the altered tuff is most noteworthy, which may be connected with the series of reactions resulting in the generation of the nitrate.

Tuffs represent a product of volcanic outburst of explosive violence. At Mt. Peleé the inflammable gases in the *nuée ardente* were held in the ash-cloud, which as a whole possessed sufficient weight, despite its high temperature, to roll down to the sea, the gases lighter than air being held in this mantle of lapilli, and prevented by interference of particles from diffusing at once into the

atmosphere. It would seem not improbable that extraordinary outbursts of lapilli, producing widely extended deposits of tuffs, must carry down large quantities of gases, both 'entrained,' to borrow a term from the steam engineer, and perhaps also occluded in the particles themselves. The latter, as shown by M. Le Brun,* would be held tenaciously until liberated by alteration of the mineral constituents of the rock. In either case the gases would be evolved slowly, though long periods of time might be required for thick and deeply buried tuffs to part with their primary gas-content. Where hydrogen constituted part of the occluded gas the conditions would favor the direct formation of NH_3 in contact with the nitrogen of the air. Also nitrogen and hydrogen in the volcanic emanation might form ammonia within the tuff itself, which would oxidize to nitric acid either by contact with dissolved oxygen in later infiltrating waters, or on being brought by seepage into contact with the oxygen of the air.

Finally, to revert to a possible rôle of magnetite in the genesis of nitrates, attention may be called to the production of this compound from the ferrous iron in decomposing silicates, in accordance with the following reversible reaction:

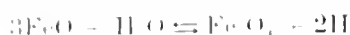

This reaction is uninfluenced by changes of pressure, the direction of the reaction being determined by variations of temperature. The production of Fe_3O_4 being strongly exothermic, the action would soon be halted. Lowering of the temperature favors the formation of the magnetite. Nascent hydrogen, evolved in this reaction, would unite directly with nitrogen, present from dissolved air in infiltrating water, or as primary gas-content:

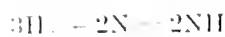

Oxygen, similarly present in solution, would yield:



Free alkali, present from processes of alteration in the rock, would then produce:

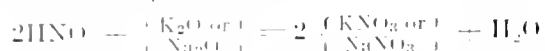

A well-known German process for the commercial fixation of nitrogen, developed within the last few years, depends upon the direct combination of nascent hydrogen with nitrogen to form ammonia.

LARGE numbers of English sovereigns (£1 or \$4.80) are being melted throughout India to make good the falling-off in imports of gold bullion. The effect of this has been to create a decrease in the circulating medium which may have to be made good by the end of the year by the increased coinage of rupees (2sc.). It is estimated that about 20,000 to 25,000 sovereigns are being melted in India every day for the last 18 months. This must have created a fairly large gap in the amount of money in circulation. This constant melting of sovereigns has told on the supply of this coin.

Rapid Assay of Lead

By Gregory Torossian

*The following method for the approximate quantitative determination of lead may be of value to metallurgists, mining engineers, prospectors, and others who have occasion to estimate quickly and with reasonable accuracy the lead content of certain lead compounds and minerals. The method is based on the reduction of lead compounds by nascent hydrogen.

An aluminum plate 2 in. wide, 5 in. long, and 0.03 in. thick is used. About $\frac{1}{4}$ in. from each end of the plate concave cups are formed by placing the plate over one of the thumb-holes of a crucible-tong, or over a suitable ring, and striking it with a pestle. The diameter of the cup need not be more than 1 in. and the depth $\frac{3}{16}$ in. Before using, the aluminum plate is rubbed with emery-paper or sand so as to clean the surface from the aluminum oxide coating that hinders the action of acids. Each cup will serve for 15 determinations.

From 0.15 to 0.2 gram of the finely powdered sample is placed in the cup on the aluminum plate (it may be weighed directly on the plate in the cup), and moistened with a drop or two of dilute (1:3) hydrochloric acid. More acid is added, drop by drop, until its action on the aluminum is well started. The sample is subjected to this treatment for several seconds, or until the original color of the sample almost disappears or is changed markedly. By this time the sample becomes spongy, may be turned over by a pointed glass rod or gently stirred and more acid is added drop by drop, if necessary. After a minute or two the contents of the cup are stirred with a pointed glass rod for 5 min., or until all indications point to the completion of the reaction. In the case of lead sulphide the fact that sulphuretted hydrogen is no longer evolved is a good indication for the end of reaction. With colored lead compounds the disappearance of the color is indicative that the reduction is over. In my experiments the reductions took 5 to 10 minutes.

When the reduction is complete, a little pure water is added to the cup and after gentle stirring the liquor from the cup is decanted; this operation is repeated 4 or 5 times, or until the wash water shows no acid reaction (litmus test or 'tongue touch'). Now the spongy metallic lead in the cup is pressed together with a glass rod so as to make it solid and compact, then a filter-paper is pressed over the lead to dry it as completely as possible. Finally, one drop of water is placed near the cup on the plate, which is now warmed above a small flame or a lighted match, or any convenient small source of heat until the water is evaporated; this also dries the lead metal in the cup. The dried lead is now detached from the plate by a pocket knife and weighed, and the percentage of lead is calculated on the original sample.

This method is simple and quick, and sufficiently accurate to be of value in many instances of rapid estimation of lead in minerals and compounds.

**Recherches sur l'Équilibre Volcanique.*

*Abstract from *Jour. of Ind. and Eng. Chem.*, April, 1916.

Surficial Indications of Copper—I

By Frank H. Probert

BIG OAKS from little acorns grow, so too all mines were at one time the merest prospects with nothing but the outcrop as Nature's advertisement of her hidden treasure. Inasmuch as the outcrop is the surface expression of an orebody, a correct understanding of the significance of surficial signs is of paramount importance in the search for the mines.

At the Washington meeting of the American Institute of Mining Engineers, in February, 1900, the absorbing topic of secondary enrichment of ore deposits was presented for discussion. It has been discussed ever since. The literature of the subject has assumed library proportions and still there is, and must be, a wide diversity of opinion among equally competent men as to the sequence of sulphides in particular. In the effort to fathom these deep problems, higher horizons have been overlooked. Are we not trying to look from the bottom up rather than from the top down? Is it not high time that the outcrops of the veins and the surface indications of the enormous disseminated deposits were carefully investigated and critically studied? Mineralized districts, productive mines and prospects in all stages of development have been severally described from time to time, either in the publications of governmental bureaus, the transactions of learned societies, or in the columns of technical journals, but few attempts have thus far been made to assemble the serappy and widely scattered information and from it develop, if possible, some helpful hints to guide the prospector's pick and enlighten the engineer in the examination of undeveloped properties.

The history of the past is the prophecy of the future; beautiful theories are often killed by ugly facts; analogy is a dangerous weapon in the hands of the incompetent; nevertheless, the application of knowledge acquired, not from textbooks, but from the school of experience, can alone be the guide to fresh discoveries.

I am prompted and emboldened to write on this subject of surface signs by the many requests I have received since lecturing to the mining students of the University of California, for a transcript of my notes. This implies a lack of systematized study of the subject, or rather, an awakening to the appreciation of the importance of the outcrop as the sign-post to direct the miner where to dig. I claim no originality or finality in the presentation of my notes; I have culled liberally from the technical literature on the subject and acknowledge indebtedness to many engineers and publications. Direct recognition of their work in foot-notes would make this series of articles needlessly cumbersome. I would however express my appreciation of the work of W. H. Emmons in piecing together pertinent infor-

mation on the subject of secondary enrichment and presenting it as Bulletin 529 of the United States Geological Survey. This is to be supplemented by Bull. 625 now in the press. I commend it to all those interested in the study of outcrops.

The results of the exhaustive work of the 'Secondary Enrichment Commission,' under the direction of L. C. Graton, will be awaited with keen interest, for in that

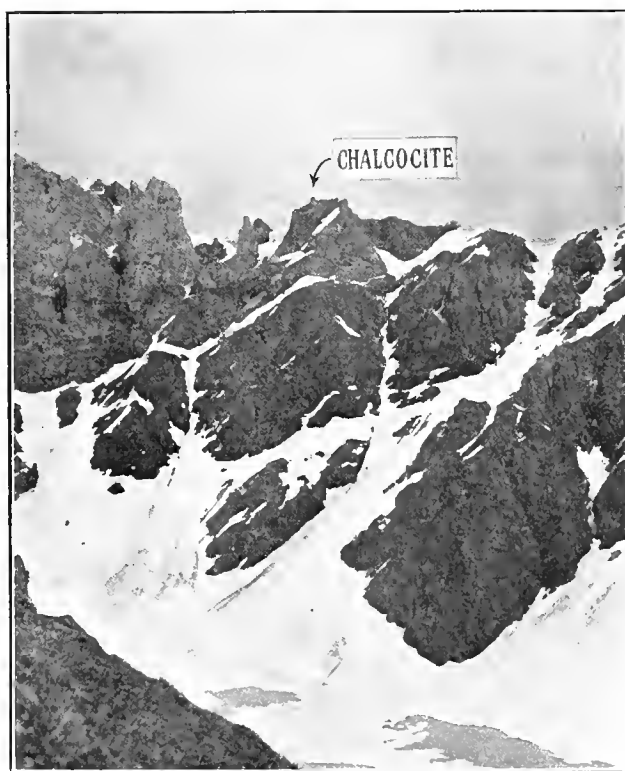

FIG. 8. OUTCROP OF THE BONANZA OREBODY OF THE KENNECOTT COPPER MINE, ALASKA.

monograph the physical and chemical forces combining to produce commercial orebodies will be competently discussed.

I submit the following data, not with any idea of anticipating the views of others, but in the hope that a lively discussion of the subject will ensue, so that the profession at large may be benefited. I maintain that the study of surface indications is of the greatest importance and that it is perhaps a greater accomplishment to be able to anticipate, by virtue of correct diagnosis, the birth of a mine than to dissect the tissues of the internal organs of a healthy productive mine and establish their relationships.

It is imperative that the examination of new districts must be approached with an open mind. Many a good

district has been turned down because of a 'hunch,' an involuntary preconception that this or that is N. G. or O. K. It is surprising what an effect a tiresome trip, poor accommodations, an unfriendly greeting, a sick stomach, or other unfavorable factor, has on the prospective value of an ore deposit. Again, many an attractive prospect has been hopelessly spoiled by a little digging. It is advisable to attack new problems with the hope that they will justify endorsement, equally necessary to be a Missourian. Theories must be tested by analytical observation and conclusions built by synthetic reasoning.

Before going into the discussion of the life history of the outcrop, it is advisable to outline the conditions under which mineral deposits are formed and the areas most favorable for their surface expression.

Prolonged and intermittent volcanism is most favorable to the formation of ore deposits. Igneous rocks are enormous reservoirs of energy and the vapors from intrusives are pre-eminently favorable to chemical reactions. The distribution of mining districts can only be explained by the distribution of igneous rocks intruded under circumstances favorable to vein formation. Successive intrusions of igneous rocks may cause cumulative mineralization, or bring about such changes in the original mineralized rock as tend toward concentration or enrichment. The emanations, gaseous or aqueous, from one cooling magma, may develop certain minerals, such as pyrite or some other metallic sulphide, which will act as a nucleus of crystallization or as a precipitant for the mineral vapors from later volcanics. In the Ray district, Arizona, the latest intrusive rock of economic importance is granite-porphry, cutting both the schist and diabase. Both intrusives are mineralized and in places so enriched by later processes as to constitute ore. S. E. Emmons attributed the Cananea deposits to the influence of three distinct eruptives.

Most of the copper deposits are genetically related, primarily, to either an acid-porphry or monzonite, or to a more basic diabase.

American geologists assert that the copper mines of North America occur in greatly decomposed altered acid-porphyrics, whereas, there is a marked tendency in Europe to affirm an intimate dependence on basic rocks. The presence of copper in small quantity in most ferro-magnesian rocks is definitely established, especially in diabase. This is instanced in the Lake Superior region, in New Jersey, Virginia, and in the Globe district of Arizona. In Chile the silver-copper veins occur in basic plagioclase-augite rocks. The large low-grade deposits of Bingham, Mescal, Burro Mountain, Ely, and Chino, show a persistent connection with monzonite rocks.

The original deposits formed directly from molten magmas are seldom of commercial value. Nearly all the workable ore-bodies are the result of concentration and enrichment brought about by the agency of meteoric water, often repeated.

Von Cotta stated that "ore deposits are in a general way formed in regions of older rocks." A few copper deposits are of pre-Cambrian age, but by far the larger number are post-Palaeozoic and were formed during early

Tertiary time. This was a period of great volcanic activity, of domal uplift, mountain building, adjustment of the earth's crust, with induced faulting, folding, shearing, and fracturing. It changed the topography and initiated new physiographic conditions.

There are several types of copper deposits: fissure-veins, contact metamorphic deposits, the so called 'porphyry coppers,' or low-grade masses of disseminated mineral, magmatic deposits, replacements, and others. Each has its peculiar characteristics of surface expression, of metal and rock associations. Fissure-veins occupy faults or fractures in the earth's crust caused by the adjustment to and equalization of internal forces. The nature of the enclosing rock frequently influences the outcrop. Faults wholly in limestone have a tendency to heal, like a wound, leaving a more or less inconspicuous scar on the surface. Quartzite faults show as ragged brecciated outcrops, weathering in sharp relief, while those in igneous rocks may or may not be prominent (Fig. 1). As a rule, the sedimentary are more resistant to erosion than the igneous rocks, except when the latter have been shattered and silicified. Veins are indicated at the surface either by ridges or depressions, according to the relative hardness, and consequent resistance to erosion of vein-filling and wall-rock. Few veins apex with the little end up, and inasmuch as the mineral content is frequently concentrated within the comparatively narrow confines of the fracture, the zone of oxidation, in its surface aspects, is likely to be quite conspicuous. Limonitic and hematitic outcrops are common (Fig. 2). We must not, however, attach too much significance to the attractive coloring; a little copper may stain a wide area, and a little iron a whole mountain. Many worthless veins show large gossans. The great veins of Australia, Butte, and Morenci have no iron-capping to speak of, but are indicated by silicified and disintegrated rock. The width of a gossan is apt to be greater than the vein itself on account of the permeation of oxidizing waters into the wall-rock.

Contact metamorphic deposits are generally found in stratified rocks, and were formed under the influence of invading masses of deep-seated volcanic eruptives. The most important criterion is their mineralogic composition, since they present a distinctive mineral grouping. Garnet, epidote, and wollastonite are indicative of contact metamorphism. There is generally a complete change of form and structure due to contact and chemical metamorphism; the rocks are re-crystallized and intensely resistant. Areas of limestone, altered by the fluids escaping from intruded igneous magmas, are particularly favorable to ore deposits of this type. At Morenci, Mescal, Bisbee, Silverbell, all in Arizona, at Cananea, Mexico, at Mackay, Idaho, and at Bingham, Utah, large contact metamorphic deposits have been successfully exploited. At Bisbee, the garnet area is but sparingly developed, and the characteristic outcrops of this type are not conspicuous, but in the other districts mentioned, the peculiar surface exposures cannot fail to attract attention. Acid porphyries were forced into the limestones and shales. The vapors from the cooling mass

changed the sediments to a compact, hard, relatively impervious rock mass of garnetiferous epidote, carrying metallic sulphides. Later the porphyry was subjected to contractional strains, which permitted of the release of further magmatic emanations. They mineralized both the intruded and intrusives with low-grade disseminated ore, accompanied by intense alteration of the



FIG. 1. FAULT SCARP, OLD DOMINION VEIN, GLOBE, ARIZONA.

porphyry. J. B. Umpleby is making an exhaustive study of the contact metamorphic deposits of the United States. I gather from conversational remarks that he recognizes two distinct periods of mineralization, the first of the nature of marmorization and re-crystallization of the intruded sediments with development of complex silicates, the second that of metallization due to the escape of metallic vapors from the cooling magmas. The garnetiferous limestones are peculiarly resistant to weathering and their outcrops appear as iron-stained rugged masses above the eroded and decomposed porphyry (Fig. 3). Secondary enrichment of sulphides is uncommon in orebodies of this type, although surface concentration of silicates, carbonates, and oxides of copper are found. The copper in the oxidized caps of this type of deposit seems to be locked up as chrysocolla, 'copper pitch,' or allied salts. It does not migrate to deeper zones. This may be due to the texture of the highly altered sediments. Such sulphides as do exist are nearly always primary, but most of the available ore is of the direct smelting oxidized class. The orebodies are not related to systems of faults or fissures; the rocks are tough and do not fracture readily; moreover, because of the calcite or lime content, oxygenated waters are robbed of the contained copper. Chalcopyrite or cupriferous pyrite are the primary minerals of greatest economic importance that by oxidizing processes have formed ore. While all these districts are notable because of these contact metamorphic deposits, the bulk

of the ore mined comes from the porphyry areas and is of the disseminated enriched type.

The 'porphyry coppers' constitute a type that came into public favor about ten years ago. The success of the Utah Copper Co. stimulated a search for other deposits of the same type the world over. Chino, Ray, Ajo, Miami, Inspiration, Ely, and the Siberian deposits have all been developed since that time and today contribute the bulk of the world's copper supply.

With the development of these enormous deposits, mining and milling methods have changed and the science of the mechanics of mining has taken a big step forward. Steam-shovel and caving methods have been elaborated successfully, and wet concentration is now followed by flotation.

The low-grade disseminated deposits are the result of secondary enrichment of lean sulphides scattered throughout highly-altered porphyritic or schistose rocks. Weathering, erosion, and oxidation have combined to concentrate the metal into definite horizons and the ore deposits may represent the net results of two or three generations of enriching processes (Fig. 4 and 5).

The deep-seated magmatic deposits seldom find expression on the surface, so that chances for oxidation and enrichment are remote. Blind veins have no outcrop; they may be blind because of faulting near the surface, or they may have been buried by later formations, but meteoric waters may have oxidized and enriched them before the time of the rupture or burial. At Jerome, Arizona, there is an overlying mantle of



FIG. 2. MASSIVE HEMATITE OUTCROP, BLACK HAWK VEIN, GLOBE, ARIZONA.

post-mineral sediments, several hundred feet thick, that effectually masks the presence of copper except where, by faulting and erosion, isolated exposures have resulted. Fully 90% of the surface located as mineral land is covered by rocks having no connection whatsoever with the ore deposits (Fig. 6).

Let us first consider briefly the Lake Superior lodes

and the copper deposits of the 'Red Beds' of the Trias and Permian. The Upper Peninsula has produced about 15% of the world's copper for many years, nor are the amygdaloid or conglomerate lodes exhausted. The average yield per ton of rock does not exceed 18 lb., but improved metallurgical practice is fast changing discarded waste from mine and mill into 'ore.' The Copper Range of Lake Superior has a north easterly trend; it is 70 miles long and from three to six miles wide, in crescent shape. The ore is associated with basic igneous rocks, between 60 and 70% coming from the amygdaloid lodes. Mineral laden waters have replaced certain beds in the uptilted conglomerates, forming orebodies persistent to great depths. The lodes are not characterized by conspicuous outcrops. The whole country has been base levelled by glaciation so that the present topography has no recognizable relation to the ore deposits. The surface is covered by drift or soil, so that an intimate knowledge of the local geology is essential to intelligent prospecting. Usually the amygdaloid weathers more rapidly than the trap-rock enclosing it; hence the infrequency of outcrop. The copper-bearing conglomerate beds are more resistant and occasionally show at surface. Such outcrops as have been found show slight carbonate and oxide stains, enveloping nuclei of native copper. The element of chance discovery has entered largely into the development of the Lake Superior copper mines.

The deposits of copper in certain sandstone beds of Triassic and Permian age have also added largely to the copper supply and, as developments both in the United States and South America show, are increasingly worthy of attention. They are widely distributed geographically; the most productive beds being at Mansfeld, in Germany, but similar deposits are found in the Ural region, Russia; in Alsace-Lorraine; at Corocoro in Bolivia; in the Appalachian system from Nova Scotia to New Jersey; in Texas, in New Mexico, and in many parts of the Colorado plateau from the Uncompahgre valley to the Grand Canyon. It is of importance to note that in no one of these deposits has any positive genetic connection been established between the copper beds and eruptive rocks.

Louis M. Richard, in describing the copper deposits in the 'Red Beds' of Texas, says: "The great linear extent of the exposures and natural outcrops, as compared with the narrow width, suggests that the arrangement of the deposits has been dependent upon the topography at the particular period in which the deposit was formed." The surface is conspicuously altered by oxidation. The clays are stained a bluish-green. The ability of kaolinitic material to absorb copper from pregnant solutions will be referred to later, as the outcrop not infrequently exemplifies this condition. Richard states that "the copper is associated with carbonaceous matter, especially carbonized and fossilized wood, plant stems, and grasses." This confirms the observations made in the Permian district of Russia by W. H. Twelvet-

rees and Thomas Rickard, 40 years ago.⁷ In the *Kupferschiefer* of Mansfeld, distorted skeletons of fish have been entirely replaced by both native copper and silver. The general principles that govern the surface expression of nearly all other types of copper deposits are not found here, and intimate knowledge of the stratigraphic geology, coupled with chance discovery, must be relied upon to add to the further development of this type.

Before we can understand the complexities of copper outcrops, we must be conversant with the general structure of the earth's upper crust. The crust of the earth is divided into two zones, a zone of fracture and a zone of flowage. The division is based upon changed conditions of temperature and pressure with depth. Chemical reactions, which take place in a certain way under ordinary conditions of temperature and pressure in the zone of fracture, are reversed in the lower zone where high temperatures and great pressures prevail.

We are concerned only with the zone of fracture. The rocks contain many openings, major and minor faults, slips, cleavages, joints, areas of sheering and brecciation, and a maze of microscopic channels. They are porous and admit of the free circulation of meteoric waters. The chemical reactions that take place in this zone are governed by chemical affinity. The zone of fracture is subdivided into the belt of weathering and the belt of cementation, or, to use the terms as first intended, the zone of oxidation and secondary enrichment.

The belt of weathering extends from the surface to the level of ground-water. Its thickness is therefore very variable. The reactions that take place in this belt are those of hydration, oxidation, absorption of silica, and losses of material by leaching. It is a region of low pressures, low temperatures, and great porosity. The complex silicates and metallic sulphides are broken down into simpler compounds, from which, within the belt, they are rarely regenerated. In the belt of cementation, or in the ground-water zone, re-deposition rules. There is a marked contrast in the rock-mass above and below ground-water level. Below, the rocks are less porous, temperature and pressure increases, dehydration takes place, oxidation gives way to reduction, carbonates are decomposed, and silicates regenerated. The belts or zones cannot be rigorously delimited. They shade into and inter-penetrate each other.

In the upper zone, chemical reactions are exothermic and are accompanied by increase of volume. Physical forces, by the accumulation of sediments, may, in periods of geologic time, so bury the surface that it is subject to the conditions of the deeper zone. Again, the erosive factor may bring to the surface deep-seated rocks.

Water is the chief agent of chemical metamorphism. It moves freely in the upper crust, less freely below.

⁷For this note I am indebted to T. A. Rickard, who also states that he recalls clearly the fact of seeing, as a boy, the replacement of plant remains by copper in the Permian sandstone of the Kargalinsky mines, east of the Ural mountains, while, on the other hand, animal fossils apparently had not precipitated the copper from the permeating solutions.

In the belt of weathering there is a generous transfer of material, both mechanically and chemically, from place to place.

In the anatomy of the zone of oxidation, we are con-

fronted with the work of physical and chemical forces, acting at times together, in many instances separately, but their effects are closely related, and the condition of the outcrop is dependent on the far-reaching influence of both. The present topography may be vastly different from that of the early days of a mineral deposit; the surface of the earth is always changing, and the forces that change the sky-line influence an orebody. Mineral

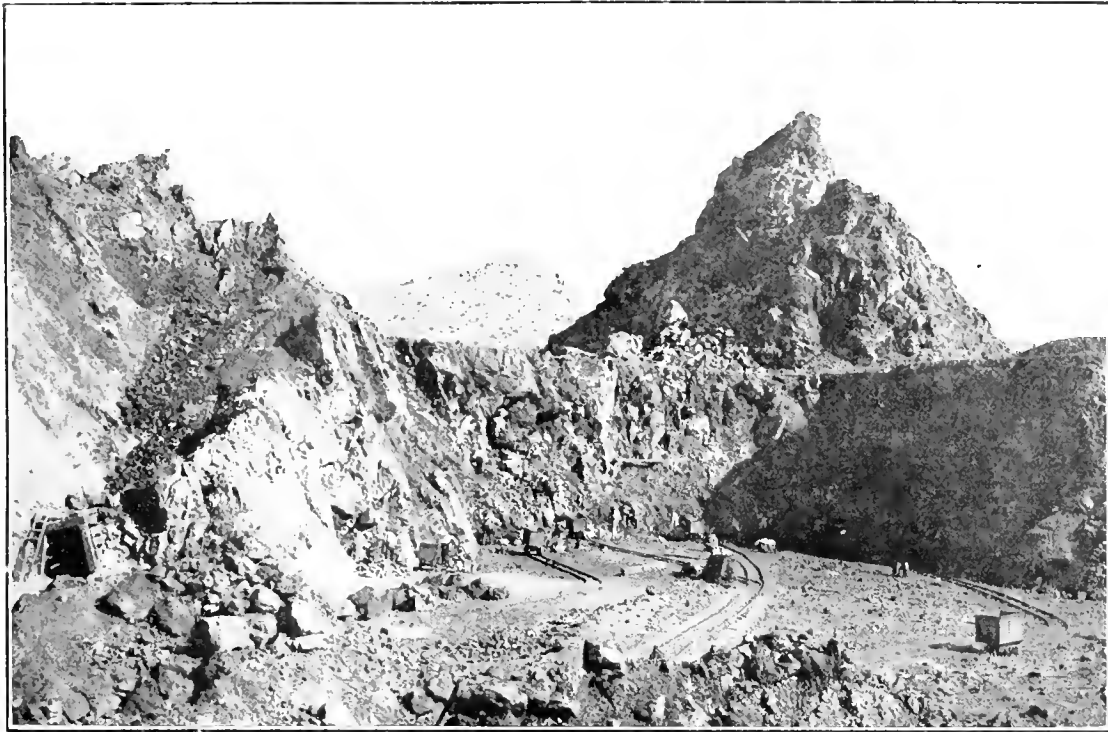

FIG. 3. TYPICAL OUTCROP OF CONTACT METAMORPHIC OREBODY, SHANNON MINE, METCALF, ARIZONA.

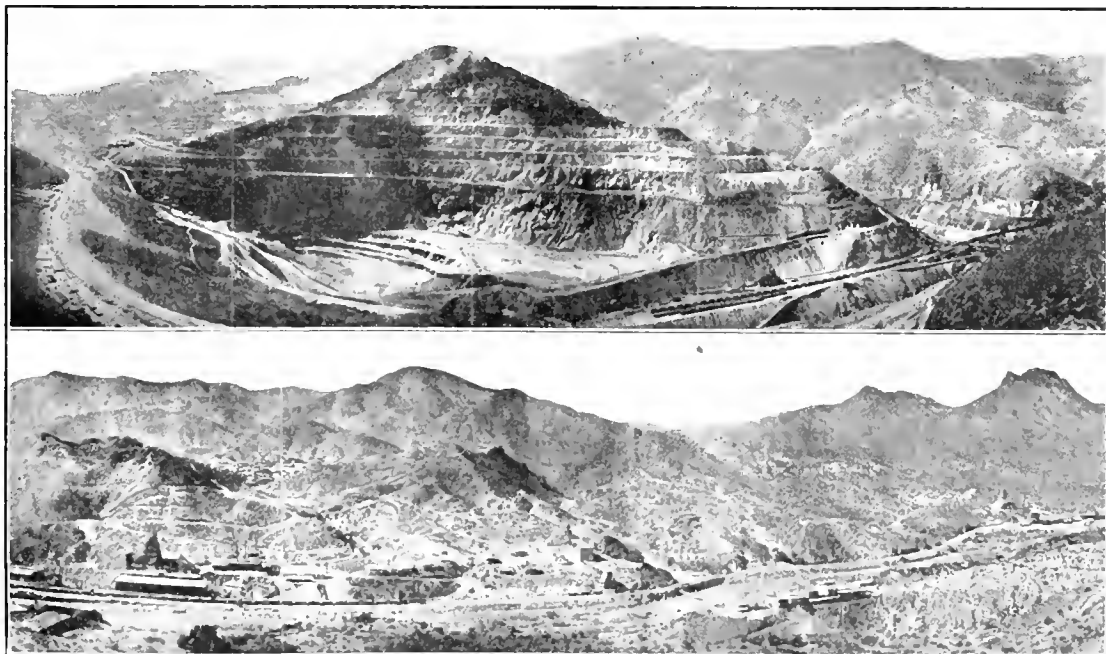

FIG. 4. UPPER PICTURE. THE DISSEMINATED OREBODY, UTAH COPPER CO., BINGHAM, UTAH.

FIG. 5. LOWER PICTURE. SURFACE EXPRESSION OF RAY CONSOLIDATED OREBODY.

fronted with the work of physical and chemical forces, acting at times together, in many instances separately, but their effects are closely related, and the condition of the outcrop is dependent on the far-reaching influence

deposits, particularly those of copper, generally find expression on the surface, either by striking coloring or topographic relief. Physical and chemical forces combine to denote, in some way or other, the presence of ore.

Copper deposits are characteristically confined to mountainous regions, either in the sections of marked relief today or in the remnants of former ridges, so that physiographic conditions and topographic details have a decided value as indicators of surface concentration.

H. Foster Ban has stated recently: "the physiographical history of a region in which an orebody is found frequently influences and often determines its character. This history must be read and interpreted if geology is to be of full service in the development of the deposits." Both the miner and the petrologist have at times lost sight of the fact that the study of ore deposits—their occurrence, form, and extent—is a complex problem requiring analysis from many viewpoints. Given a favorable receptacle, a likely structure, and the necessary minerals being present, the occurrence or non-occurrence of ore rich enough to ensure profit from working, is determined by the geological history. It is the recent geological history, which can be read in the surface of the land, that is usually a determining factor in economic exploitation of ore deposits. H. H. Knox and A. W. Stickney, at Kyshtim, and other careful observers elsewhere have called attention to the importance of a study of physiographic conditions to ore deposits. L. C. Graton, assisted by W. W. Atwood, is making elaborate investigations along these lines, whereas a number of observers have, perhaps, taken too much for granted in determining the true character of the chalcocite in the Bonanza mine of Alaska.

The climatic conditions, nature of the rocks, size of openings, and proximity to water determine the topography and influence erosion. Rapid changes of temperature cause uneven expansion and contraction of the upper part of the crust as a whole and of the individual constituents. Sealing, flaking, crumbling, and disintegration are the result. Extremes of heat and cold are potent factors. The expansion of water on freezing is a force sufficiently strong to split asunder the hardest rocks. A line of weakness once initiated may never heal, each succeeding frost makes it weaker, other planes of fracture develop, and soon boulder structure results. Fig. 7. Joints, cleavages, and bedding-planes will act in the same way, the rocks become porous and in consequence present larger surfaces for the more corrosive attacks of oxygenated or acid waters.

High temperature facilitates chemical change by heating the solutions, by increasing their solvent powers, by assisting vegetative growth, it hastens the decomposition of organic matter, it generates gases and furthers rock disintegration by the unequal expansion of component minerals. Heat promotes chemical action; freezing prevents solution. Horace V. Winchell has given⁴ some interesting data on the relation of climate and latitude to bonanza ore. In commenting on the possibilities of the great North-west, he says: "the region generally looks more attractive to the prospector than to the student of economic geology." There are a few principles based

upon chemical facts that have a universal application, and should be remembered in connection with the surface indications of mineral deposits, either now or formerly covered by great ice sheets. There is a vast difference in the surface appearance and mineralization in different isotherms. As Winchell says, "Where the rocks are exposed in Northern latitudes, they are fresh, hard, and unoxidized. There are no superficial areas of kaolinization, no gossan, nor even iron stained surface rocks. Even crevices or other minor structural details are rare. The accumulated debris left in the wake of glaciers and glacial streams will often show an abundance of unoxidized pyrite and associated sulphides. The surface of the country-rock is sometimes covered with a thin layer of iron and copper sulphides." This condition has many times warped the judgment of the prospector and extravagant stories of 'mountains of ore' have vanished into thin air almost before the first rowd of holes has been blasted. Even in favorable spots, where rocks are more permeable or filled with more readily oxidizable minerals, there is but a shallow envelope of enriched ore. For the most part, sulphide ore comes immediately to the surface and is seldom high-grade to any depth. These are broad generalizations, the result of observations made in British Columbia, Alaska, the ice-bound areas of Eastern and Central Canada, and the northern countries of Europe, particularly Norway and Sweden. Numerous exceptions, of course, exist. On passing from the Arctic regions of perpetual frost to the Equator, the zone of oxidation and enrichment seems to increase from zero thickness to one thousand feet or more. The destructive effect of the continental ice-sheet has not removed the dissipated oxidized ore deposits of the same magnitude as those occurring south of the ice plauation.

In the temperate zone, deep superficial alteration and complete oxidation of vein-matter are common; they indicate high-grade ore below. Ore deposits are more abundant in the warm and temperate zones. They are not so likely to terminate suddenly or change rapidly in depth. It might be said that these are self-evident facts, but they are frequently forgotten when the opportunity arises to apply them in practice.

The higher latitudes are not only the coldest parts of the earth today, but the rocks, when exposed, show the glacial grooving of former geologic periods. The important orebodies of the northern countries are mostly of primary origin, although the famous Bonanza mine of the Chitina copper belt, Alaska, is a mass of chalcocite and bornite carrying silver, in a fractured limestone. Moffit and Maddren are non-committal in their diagnosis of the genesis of this ore, but imply that meteoric agencies have been at work. C. F. Tolman, Jr., in a recent paper,⁵ describes the chalcocite as a replacement of original bornite, probably in part if not wholly due to meteoric agencies. This implies a long erosion interval, and possibly different climatic conditions than those which exist today (Fig. 8). In the Vermilion mine of Sudbury,

⁴*The Mining Magazine*, February, 1916, p. 72.

⁵*The Mining Magazine*, December, 1910, pp. 439-478.

⁶Bulletin A. I. M. E., February, 1916.

Ontario, native copper, a final oxidation product of original chalcopyrite in this case, is found 900 ft. below the surface. The St. Eugene mine, in British Columbia, has secondary chalcocite. On the other hand, secondary sulphides are not always present in tropical regions. In the Sable Antelope mine of the Kafue district, Rhodesia, only 13° south of the Equator, copper sulphides show at the surface and there is no superficial alteration.

It should, however, be remembered that great climatic changes have taken place in many regions and that temperatures have been by no means constant throughout geologic time. It does not follow that because processes of weathering are slow today that similar conditions existed always.

The effect of glaciation on outcrops of ore has been mechanical rather than chemical. Wholesale erosion of the rocks has ensued, mountains have been base-leveled, possibly a large part of the vein or deposit has been removed. A moving glacier, with its ammunition of entrained boulders, will destroy anything in its path. The base pressure is enormous on account of the weight of the superincumbent mass; hence, it is possible that in traveling over an orebody it will have a tendency to tear it apart, developing a series of fractures either in the mineral mass or in the encasing rock. Flowing water always escapes from the lip of a glacier; and it is probable that this water, charged with oxygen as it must be, seeps into these induced fissures and causes alteration to shallow depth.

R. W. Brock, when describing the copper deposits of

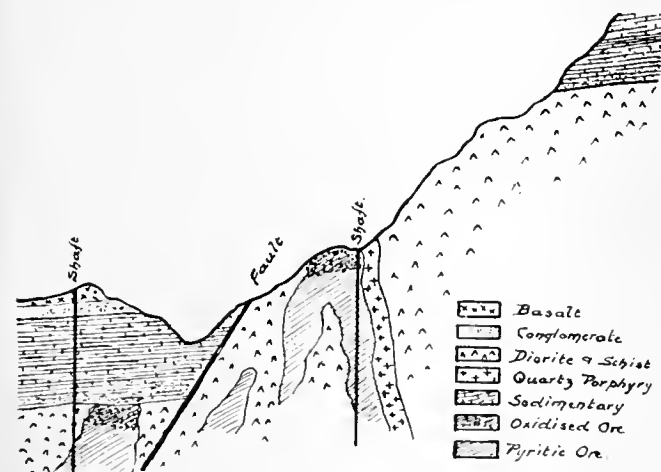

FIG. 6. CROSS-SECTION OF THE UNITED VERDE MINE.

the Boundary Creek district of British Columbia, comments on the lack of oxidized material in the upper zone, but notes an important exception: at the King Solomon mine all phases of oxidation and enrichment are presented in the orebody, which occurs at the contact of porphyry and limestone. He attributes this to the local topography. The contact was a natural watercourse in former times.

The more recent the deposit, the less chance there is for extensive or great enrichment. The effect of oxidizing water is directly proportional to the time the de-

posit is exposed to weathering. If the rain-fall is slight, erosion is slight. The dew may bring about surficial oxidation in the main fractures of the rock, and local concentration of oxidized products. Where the country is widely shattered and altered, with mineralization along the fractures, or pyritic casts appear, and where there is moderate rain-fall, the chances are good for concentration in a relatively shallow zone. If the outcrops



FIG. 7. TYPICAL BOULDER WEATHERING OF BUTTE GRANITE. PYRITISATION TAKES PLACE ALONG JOINTS.

are strong and the rainfall is moderate, there is every probability of extensive concentration. If the contour is uneven and rain-fall is heavy, erosion will be rapid, oxidation shallow, and the zone quickly removed.

In dry sections with steep hill-slopes, the changes may be incomplete. A zone of mixed oxides and sulphide will form near the surface, but incomplete oxidation may be deep owing to the low water-level. In areas of much weathering, the re-distribution of the minerals will depend upon their solubility.

THE LEASING SYSTEM as a means for working old mines has much to recommend it. There is a considerable difference between operating a mine by a corporation, including highly paid officials and overhead expense, and a leasing scheme where these functions are performed by one or two men. The mines of the Cobalt district, it is pointed out by the *Northern Miner*, are rapidly approaching the leasing stage. At Cripple Creek in Colorado, the 'split-check' leasing system, which has given such satisfactory results at large and small mines, provides that the company furnish the power and hoisting, while the lessee furnishes the labor, the net returns being divided equally.

ANTHRACITE production of the United States in 1914 was 79,459,876 tons, averaging \$2.32 per ton. Compared with 1914 this was a decrease of 2% and 1.9% respectively. Employment was given to 176,552 men, who produced 1.96 tons per man-day. These are final figures.

The Double Roasting Process at East Helena

By X

PRELIMINARY ROASTING ON SINTERING MACHINES

CONDITION OF THE FEED. The material to be roasted has been crushed and concentrated previously, so that the feed going to the Dwight-Lloyd machines ranges from $\frac{1}{4}$ -inch size to the finest flotation-slime. It was found at East Helena that a more effective roast could be obtained by crushing through a $\frac{1}{4}$ -inch screen, but this practice is not followed in the sampling-mills, because the decrease in size so hampered the mill-capacity that the management deemed it advisable to sacrifice better roasting conditions for larger output. After the screens are worn, the largest particle passing them is slightly greater than a quarter of an inch.

MIXING OF CHARGE. The bedding method is adopted for the mixing of the Dwight-Lloyd charge. This is done in a series of bins situated in front of, and in close proximity to, the roaster-building. After the bins have been filled, according to calculated charges, the mix is loaded by hand into small tram-cars (capacity about $1\frac{1}{2}$ tons of roast), which are pushed direct to the roasters. This system is costly and inefficient. In bedding the different constituents of the charge are not as thoroughly mixed as when handled by one of the several automatic mixing systems now in vogue. Of course, this bad feature is lessened to some extent by the dropping of the charge from one conveyor-belt to another, through the rolls and into the hoppers on its way to the roasting-machines. (At the present time the East Helena management is trying to secure an appropriation from the New York office for the installation of one of the mechanical-mixing systems.) Open or exposed bins, such as are necessary for bedding, are subject to weather conditions, making the present man-handling of the charge more cumbersome and expensive. The frozen chunks in the charge, composed mostly of yanmer and flotation slimes, ranging in size from fine to pieces a foot in diameter, give considerable trouble in the roasting-department. In the first place, they do not permit of an even distribution of the slime-products throughout the charge, so that in the course of feeding the Dwight-Lloyds pieces of slime up to $1\frac{1}{4}$ -inch in diameter fall on the grates, and when the slime becomes slightly plastic, owing to thawing, large flattened pieces are fed to the sintering machines. Both of these conditions lean toward poor roasting inasmuch as the sulphur elimination is then cut down. At East Helena these difficulties have been partly overcome by passing the feed through a $\frac{1}{4}$ -inch trommel, the oversize from which is crushed in a jaw-hammer crusher through a $\frac{1}{4}$ -inch screen. While this has proved most successful on frozen slime, I doubt if it will serve the purpose on wet, sticky, flotation-slime; and it is the general opinion around this plant that a dryer, preferably of the drum

type, will have to be employed; after drying the charge should be mechanically mixed and the moisture content brought up to the desired point.

MOISTURE IN CHARGE. This is not subject to close limitations; by some authorities 10% is said to give the best results, but at East Helena the moisture-content of the mixed charge rarely exceeds 8%. The upper limit should be when the material balls in the hand. Too little moisture leads to excessive dust in handling, leakage through the grates into the pit and wind-box, and too rapid combustion on the grates, producing a fused coating over the surface of the ore particles and an incomplete roast at the centre.

SULPHUR IN CHARGE. It is well established that the Dwight-Lloyd machines work most efficiently when the sulphur content is from 15 to 16%, but fairly good work can be obtained with sulphur as low as 11%. With rich lead mixtures the upper limits can only be reached by diluting with one or more of the lighter metallic sulphides, but this necessarily reduces the lead output of the machine. At East Helena it was found that the additional cost was no greater when roasting a charge carrying 15% sulphur down to $3\frac{1}{2}$ % than when reducing from 12% to $3\frac{1}{2}$ %. Where the percentage of sulphur is less than 12, a higher tonnage and smaller sulphur elimination is preferable, say from 11% to 5 or 6%. This is the fundamental working principle of the 'double roasting' process. At this smelter the first increase in capacity was from 110 tons per Dwight-Lloyd to 131 tons, and at the present writing to 230 tons. When the charge contains more than the maximum sulphur (16%) it should be diluted by adding non-roasting ores, preferably fine. The possibilities presented by the addition of slacked coal to the feed, to compensate for the lack of heat-units caused by too low a sulphur content, suggest an interesting experiment. The sulphur elimination and tonnage vary inversely, tonnage being heavily sacrificed to reach the lower sulphur proportion ($3\frac{1}{2}$ to 4%), especially if the original sulphur is less than 12%.

THE ADDITION OF LIME to the Dwight-Lloyd charge met with considerable opposition at first on the ground that on slaking it caused a disintegration of the sinter. In 'double roasting' this objection is of no importance, as the Dwight-Lloyd product is now crushed before treating in the Huntington & Heberlein pots and the breaking-up due to slaking only lessens the amount of crushing necessary. During former operations with these machines, when the tonnage was 110 to 131 tons per day, the average lime percentage was 2.6 on the feed, which was increased to 2.9% on the sinter. In the present-day practice the lime content of the feed has been raised to 8 or 9%, or 10 to 12% by bulk of limestone, with corre-

sponding increase of lime in the final sinter. This limestone is milled and crushed to $\frac{1}{4}$ -inch size and mixed with the charge by bedding. Formerly the limestone was used as grate-dressing, a half-inch layer being placed between the grates and the ore-charge. While this method allowed the sinter to break free and clean from the grates it has been supplanted by mixing the limestone equally throughout the charge, as it affords more desirable blast-furnace conditions.

LEAD IN CHARGE. The average lead in the East Helena Dwight-Lloyd feed is 39 or 40%, increasing in the sinter to 41 or 42%. This lead is mainly in the form of sulphide (galena) with smaller amounts of carbonate and sulphate. There is little effort made to form sulphate of lead in this preliminary roast, because capacity with a fair reduction of sulphur is the main aim at this step in 'double roasting.' The principal difficulty encountered in roasting a charge high in galena is the premature fusing on the surface of the ore particles, thus preventing the roasting reaction from penetrating to the centre. Tonnage is favored by a high lead charge. Where the proportion of lead is 40% or over, the Dwight-Lloyd gases can be turned safely into the bag-house without endangering the bags. Enough lead oxide, together with small amounts of zinc oxide, are sufficient to neutralize most of the SO_2 gas.

AVERAGE ANALYSIS OF FEED. The following is the average analysis for the feed and sinter on the Dwight-Lloyd machines at East Helena during 1914 and 1915:

| | SiO ₂ % | Fe % | S % | CaO | | Pb % | Cu % |
|-----------|-----------------------|---------|--------|---------|---------------------|---------|---------|
| | | | | Zn % | Former Present % | | |
| Feed ... | 15.9 | 15.2 | 11.6 | 4.1 | 2.6 8 to 9 | 39.0 | 0.1 |
| Sinter .. | 16.8 | 17.2 | 4.5 | 4.0 | 2.9 8.5-9.5 | 41.7 | 0.4 |

At the present writing the initial sulphur in the charge is from 9 to 10% (at times even less), and the final sulphur for the Dwight-Lloyd sinter is from 5 to 6% for 'double roasting.'

OPERATION OF SINTERING MACHINES. The charge as trammed from the mixing-bins is dumped into a small hopper feeding directly to a conveyor-belt, which discharges into a $\frac{1}{4}$ -inch trommel. The oversize from this trommel is passed through a crusher, of the jaw-hammer type, in order to reduce all oversize to $\frac{1}{4}$ inch (see statement under MIXING regarding handling of flotation-slime). The crushed feed is then conveyed, by a bucket-elevator discharging onto a conveyor-belt carrying a tripper, and the feed is thus distributed to the six storage-hoppers, as is required by the operating machines. Each Dwight-Lloyd receives its charge from individual hoppers, so constructed as to allow the coarser lumps in the mix to roll first on the grates, thus forming a bed for the fine and lessening the filling up and sticking of the charge to the grates.

The speed at which the grate moves is varied according to the tonnage and sulphur elimination desired. At 28 inches per minute the standard machine makes one revolution in 35 minutes. On Coeur d'Alene ores 16 inches per minute gives 131 tons, and 28 inches per min-

ute gives 230 tons of sinter. These capacities are volumetric and are based on a 40% lead charge.

Wyoming crude oil is used to ignite the charge, and is delivered at the burners at a pressure varying from 20 to 35 lb. per square inch, the pressure being controlled by rate of travel and character of feed. In 1912, an 80 lb. pressure was used on gasoline fuel with a vacuum under the blanket of about 4 ounces. The vacuum used at the present time, with crude oil, varies from 7 to 8 oz. The main objection to the crude oil is that it requires a burner that gives too wide a zone of ignition, thereby keeping the charge under the flame for too long a time, resulting in the fusing of the surface of the charge and thus not permitting of a free passage of air through the blanket. The life of the fire-box is short when using this fuel, being burnt through in about three weeks. The roaster foreman claims that better work was accomplished with the narrow ignition zone of gasoline and the low vacuum.

The wind-boxes are cleaned weekly. Recent design favors a bottom of such shape as permits a screw-conveyor to remove the leakage of fine into a closed hopper, which should be emptied about twice per shift.

Cast-iron grates were found not to last under the East Helena conditions; they have been replaced by malleable iron. This failure in grates was due, I think, not so much to the class of material used as to the spraying of water on the sinter just before dumping, thus chilling the iron and re-crystallizing it. The sinter is now wetted in the cars instead of on the grates. All break-holes in the grates should be filled with waste-paper before charging to prevent excess leakage into the pit and wind-box.

The East Helena plant is equipped with six (only three in use for two blast-furnaces) 42 by 264-in. straight-line Dwight-Lloyd sinterers. The herring-bone type of grate has been replaced by straight-slotted grates, as these are easier barred out and permit of a cleaner discharge of sinter from the machines.

For three roasters the following working force is employed:

| | Per shift |
|---|-----------|
| 1 foreman (also handles H. & H. department)..... | \$4.65 |
| 1 machine-man | \$3.75 |
| 6 grate-punchers, each | \$2.70 |
| 1 oiler | \$3.15 |
| 2 laborers in pit, each | \$2.50 |
| Charge and sinter wheeler, as necessary, each | \$2.70 |

CARE OF MACHINES. When one or more machines are driven in battery (as at East Helena) from a main shaft, they should be started consecutively and care should be taken to see that the grate-wheels, sprocket-wheels, and rails are well lubricated. Two men should be placed in the pit to bar the grates along in case they should stick at any point, and so avoid open spaces between grates. Dust and grit should be removed from movable parts at least twice per shift. Grates should be punched clean to allow free passage of air through the charge. As soon as the ignition-box is burned through it ought to be replaced in order to cut down the width of the ignition zone.

STATEMENT OF PERFORMANCES. The foreman claims that even under the most favorable conditions the sulphur reduction on the Dwight-Lloyd is rarely under 4% final, and in the 'double roast' often as high as 8%.

| Year | Tonnage | Sulphur | | Remarks |
|---------------|---------|------------|---------|---------------------------------|
| | | Initial % | Final % | |
| 1912 | 110 | 12 | 3½ to 5 | Gasoline at 80 lb. |
| 1913 | 110 | 11 | 5 | |
| 1915 (single) | 131 | 11 or less | 6 | Crude oil at 20 lb., little CaO |
| 1915 (double) | 230 | 11 or less | 6 to 7 | Crude oil at 20 lb., much CaO |

CHARACTER OF DWIGHT-LOYD SINTER. The management claims many advantages for the Dwight-Lloyd product over the H. & H., for example, its coke-like structure entails less fuel on the blast-furnace charge (2% less coke for the Dwight-Lloyd than for H. & H. sinter). Excess fuel means diminished furnace speed with a tendency to over-fire, causing poor reduction in the slag and matte. Hot tops mean hot gases for the bag-house, and the peculiar cellular structure of the Dwight-Lloyd sinter allows the reduction of the gases to be carried on over a maximum area of contact. To offset these advantages, the fact remains that even under the best operating conditions the Dwight-Lloyd product retains 4% and more of sulphur, and to reduce below this point requires a big sacrifice in tonnage. High sulphur on the blast-furnace charges at East Helena is objectionable on account of the high zinc-content of the feed.

HANDLING OF DWIGHT-LOYD PRODUCT. The sinter-cakes are jarred off the end of the machine into tram-cars (capacity about 1½ tons). These cars stand under hoods that carry off most of the gas and smoke coming from the roasted sinter. Any sinter sticking to the grates is barred loose by hand. The loaded push-cars are hand-trammed (2 men) for about 500 ft. to the railroad-track, where they are dumped into open 55 ton railroad-cars. During the course of loading these cars, the sinter is thoroughly wetted with a 2-inch hose. The loaded and moistened sinter is held for 24 hours, during which time it cools and partly disintegrates due to the slaking of the lime. The loads are then brought to the sampling-mill, where the sinter is re-crushed to ¼-inch and re-loaded into railroad-cars.

From this point the 'double roasting' process passes to the Huntington & Heberlein or 'H. & H.' department.

SECONDARY-ROASTING POTS

DESCRIPTION OF PLANT. The H. & H. pots are contained in a large corrugated iron building, open on three sides and ventilated throughout the entire length of the roof. Too much emphasis cannot be placed on the necessity for properly ventilating this department, as the men tending the pots are subjected to excessive amounts of fume and steam. At East Helena, the pots are situated at a considerable distance from the Dwight-Lloyd department, necessitating costly handling, in railroad-cars, of the 'single roast' before charging into the pots. see **CONCLUSIONS.** There are 12 cast-iron pots, the empty weight of each being 12,700 pounds. Six extra pots are

kept in reserve in case of a break down. These extras are also used in charging the operating pots. The roasted charge varies from 15,000 to 19,500 lb., depending upon the class of feed treated and also upon the

height to which the charge is piled up in the pot.

Two electric-driven traveling cranes are employed. One operates in the pit, loading and unloading the pots; the other carries, dumps, and assists in breaking the roasted sinter on the floor. The last is accomplished by dropping an iron weight on the larger pieces of sinter. After this preliminary crushing the sinter is conveyed, by means of a scraper, to a crusher breaking to 6-inch size. The crushed material is elevated in a skip and dumped into storage-bins, and from there taken direct to the blast-furnaces.

PRIMING POTS. The bottom of the empty pot is covered with several (3 or 4) inches of dead clinkers from the boiler-room. A good wheelbarrow-load, per pot, serves amply. Over this, with the blast slightly on, is charged two or so inches of small coal, ignited in a Godfrey fire-box. This coal is drawn, while incandescent, into a charge-car. The best plan is to draw one fire completely and to distribute its coal to several pots simultaneously, by aid of the crane. A level wheelbarrow-load is enough for each pot. The coals should be spread evenly over the layer of clinkers, and the blast turned on slightly to get a good heat.

CHARGING POTS. After the priming has been completed, the blast should be stopped almost entirely and the full charge of sinter dumped into the pot. The charge should be well heaped, as after blowing it shows a shrinkage of about one-third. The pot is now ready; the hood is put in place and the full blast is turned on. The charge is made up from the 'single roast' from the Dwight-Lloyd sinterers, rather rich in lime and carrying from 6 to 7% sulphur. Up to January 1, 1916, this product did not receive a second crushing before treatment in the H. & H. pots, breaking-down due to the slaking of the lime content being entirely relied upon to prepare the charge. With the present practice, crushing to ¼-inch, it is found that a more thorough roast can be obtained, owing to the even distribution of the blast throughout the charge.

MOISTURE. In preparing the sinter for the roast it should be saturated with water; the best way would be to wet it down in bins and allow it to drain. If there is an excess of water in the wetted sinter, so that it adheres, say, like soft concrete, the blow will be inferior. The burn will come to the top in large blow-holes and the agglomerated charge will keep the hole open. In this case the sides should be broken down and green sinter hoed into the opening until it is brought up to the level of the

charge in the pot. However, the main thing to avoid is having the charge too dry, in which case the roast goes on at too high a temperature, causing excessive volatilization losses, lowering the production of lead sulphate and endangering the life of the pot. When the charge packs tightly, not allowing a free passage of the blast, it should be barred through in several places. When the charge is too dry, wholly or in part, water should be added to reduce combustion (through a 1-inch pipe, sparingly).

OPERATION OF POTS. After the blast has been on for about an hour the pots should receive attention; this is essential when the sinter is fed to the pots uncrushed and when the wetting-down conditions are as crude as at this plant, since the charge is apt to burn unevenly. The proper burn, when conditions are reasonable, first indicates itself by the pots sinking in the centre. In this case the material around the edges should be pushed in and the surface made level. If the burn is uneven, elsewhere than in the centre, green sinter should be hoed over that portion burning fastest. All blow-holes ought to be treated as described above. When a pot smokes so badly that it cannot be dressed, the blast should be turned almost off until the dressing is completed; if turned off entirely, the fire is apt to flare back and burn up the tuyere-bags.

During the early part of the roast much steam rises; this condenses against the doors and hood-walls, leaving a reddish liquid deposit that is probably rich in lead sulphate. Then the charge is worried with a hoe in the course of blowing, the little particles that are sintered on the surface becoming covered with a similar coating. The larger pieces show it to some extent, but not nearly so much as the fine. This is one of the arguments given in favor of re-crushing the Dwight-Lloyd product before treating in the pots, as it shows that the fine crushed material serves as a filter for the fume given off during the blow. Care should be taken not to allow the fine to agglomerate too quickly.

When the pots are burned 'dead' the sinter is dumped by inverting the pots, using the crane, over the receiving-floor, and the large pieces of sinter are broken down as described above. The dumpings are quenched immediately with water. I think that if the spraying were put off for several hours after dumping, further reduction of sulphur would be obtained at no additional cost. The wetting-down assists in breaking and cooling the roasted sinter, owing to the slaking and exothermic reaction of the lime, respectively.

Incidentally, the air-chamber at the bottom of the pot should be raked out when tilted and before re-setting in the pocket.

TIME AND CAPACITY. The actual time consumed in running this secondary roast varies from 5 to 7 hours, and the 12 pots sinter about 460 tons of Dwight-Lloyd 'singles' per day, or about 38 tons per pot. There is no reason why the pots should not be charged every 7 hours, except the crude equipment and congested dumping-floor at East Helena. The loss in efficiency here is about 12½%.

SULPHUR ELIMINATION. This second roast brings down the sulphur from 6 or 7% in the Dwight-Lloyd sinter to 2% in the final product (the management claims as low as 1% at times). Personally, I think that 2½ to 3% would be a fair average for the final sulphur.

Scrap lead that leaks through the grates into the wind-box should not be thrown into the next charge, but fed direct to the blast-furnace.

BLAST-PRESSURE. The blast-pressure on the pots, at East Helena, is 16 oz. per square inch. The pit crew consists of

| | Per shift |
|---|-----------|
| 1 foreman (also in charge of Dwight-Lloyds) | \$4.65 |
| 1 pit foreman | \$3.30 |
| 3 pit laborers, each | \$2.65 |
| 1 crane-man (on pots) | \$3.40 |
| 3 laborers for outside work, each | \$2.85 |
| 1 sweeper (for three shifts) | \$2.50 |

COMPARISON OF SINGLE AND DOUBLE ROASTS. From the following table it will be seen that the double roast sinters 50% more charge in the same time, with an additional 3.1 to 4.1% sulphur elimination than does the single roast.

| | Number of pots | Tons roasted | Tons per pot | Sulphur Initial % | Final % |
|--------------------|-------------------|-----------------|-----------------|-------------------------|------------|
| Single roast | 12 | 300 | 25 | 10 | 5.1 |
| Double roast | 12 | 460 | 38.3 | 6 | 2 to 1 |

CONCLUSIONS

In a custom smelter, such as the one operating at East Helena, having an exceptionally high lead charge and where the zinc content runs near the maximum for good lead smelting, the 'double roast' process seems to be the only available and satisfactory method for the elimination of sulphur. Prior to the adoption of the process, at this plant, the matte-fall had reached a maximum of 22%, and rarely came below 18%. This condition has existed ever since the installation of the flotation system in the Coeur d'Alene region; this increased the zinc content in the product shipped to the smelter and was further aggravated by the high prices of the metals, causing the local shippers to mine ores high in zinc (zinc penalty varies from 5 to 11% according to the shipper and locality). The slag and matte losses were above what was permitted in good practice, and it was not until this new system of roasting was adopted that they returned to the normal. If the plant was in a position to select the ores to be treated, for example, rejecting such shipments as would tend to bring the zinc content of the blast-furnace charge above 4%, then I think the Dwight-Lloyd's would reduce the sulphur sufficiently (3½ to 4%) to hold the matte-fall within reasonable limits (10 to 12%). It should be borne in mind that this sulphur percentage would be further reduced, say to 2 or 2½, when the blast-furnace feed is diluted with non-roasting ores. If a further selection was allowed the smelting company, permitting them to secure definite amounts of auriferous or argentiferous pyritic ores or concentrates, the feed could be mixed into an ideal charge for the Dwight machines; the initial sulphur could be brought

up to from 14 to 16%. Of course, this would necessitate reducing the lead on the charge, but by operating one or two extra machines the lead output could be kept to the standard, and all the good resulting from the coke-like sinter produced from this machine could be taken advantage of, for example, less consumption of fuel on the blast-furnaces, better control of furnace heat, and an even distribution of iron flux in the charge. The line would have to be cut down on account of its slaking properties, but this could be remedied partly by mixing it with oxidized or non-roasting ores.

From the above considerations it will be seen that many of the advantages of this system are counter-acted by poor facilities for handling. The plant should be so designed that the charge from the mixing bins can be conveyed, either by gravity or mechanically, direct to the Dwight-Lloyds. The sinter from these machines should have a gravity drop to storage bins or coolers, and tapped from these into a crushing-department and then fall direct to the H. & H. feed-pots. The East Helena plant employs three men to do one man's work, and I consider this a low estimate.

Instead of wetting down the sinter, from both the Dwight-Lloyd and the H. & H. roaster, as soon as it leaves the machines, I think a further extraction of sulphur could be obtained, without additional cost, by allowing the roasted product to stand in the coolers, for 24 hours or longer, acted upon by a natural draft and protected by a hood to carry off the gas and fume.

The roasting costs, at East Helena, are as follows: the 'single roast' costs 50c. per ton of charge fed to the Dwight-Lloyd sinterers. The 'double roast' costs 30c. per ton on the Dwights, 10c. per ton for re-crushing, and 25c. per ton of feed on the H. & H. pots, making a total of 65c. per ton of charge roasted. With proper handling facilities no doubt this could be reduced at least 30%.

The method for preparing the Dwight sinter for the H. & H. pots has been revised. It is no longer run through the entire sampling-mill, but only through a gyratory crusher, which breaks about 75% of the product better than 1-inch size.

Since writing the above report, the management has created the position of assistant foreman to look after the H. & H. department. The general roaster foreman says this is hardly necessary as one man should have ample time to care for both branches of roasting.

Much of the Dwight-Lloyd difficulties could be overcome by installing an ignition system with a narrow flame zone, and also by designing some efficient form of mechanical grate-puncher.

The method for sampling and weighing the feed and products for the roasters are too inaccurate, at East Helena, affording the metallurgist but poor chance to check the work of the department.

Gold yield of the Rand in January was 787.467 fine oz. from 2,505,232 tons of ore. To reduce this there were 9977 stamps and 328 tube-mills operated for 26.98 and 27.37 days respectively. Of the \$6.16 average value of the ore the working profit was \$1.88 per ton.

Flotation at Inspiration

In February of this year the full complement of 18 units in the new mill of the Inspiration was in operation. One day early in April there was hoisted from the mine 18,000 tons of ore. During the second half of 1915 the mill treated 778,851 tons of ore. Results were as follows:

| | % |
|---------------------------------|-------|
| Copper content | 1.702 |
| Oxide copper in ore | 0.226 |
| Copper in tailing | 0.373 |
| Oxide copper in tailing | 0.18 |
| Table concentrate | 13.12 |
| Flotation concentrate | 37.63 |
| Average assay of concentrate | 32.67 |
| Recovery on sulphide copper ore | 88.56 |
| Recovery on all copper ore | 79.95 |

To produce 1 ton of concentrate 24.6 tons of ore was treated. The cost of coarse crushing was 0.113c. per pound; hauling ore to mill, 0.079c.; concentration and royalty, 1.889c.; hauling concentrate to smelter, 0.006c.; smelting, freight, refining, marketing, etc., 3.455c., a total of 5.492c. for treatment.

The following notes are from the report of the general manager, C. E. Mills.

"In the report of a year ago it was stated that the test-mill operations to that date showed a saving of copper present in the ore as a sulphide of 86.7%, and that we might count on doing as well in the new mill. Operation of the new mill for the last six months of 1915 showed a saving of 88.56% of copper present in the ore as a sulphide. During much of this period the flotation units were overloaded, because the grinding units came into service faster than the flotation sections were completed, and the loads on those in service were temporarily doubled-up in consequence. For February 1916, the saving of sulphide copper was 91.1%. The saving of 88.56% of sulphide copper in the new mill for the last six months of 1915 was on an ore that averaged 1.702% total copper, of which 0.226% was in oxide combination. We apparently saved 24% of this oxide copper, and the resulting average saving of total copper contents of the ore milled in the new mill was 79.95%.

"Since August 1914, in the test-mill, and later in the new mill, we have continued to use coal-tar as the chief component in the frothing-mixture. It has seemed the most efficient agent, also the cheapest. During this time we have not experienced the violent fluctuations in recoveries we feared, and which we previously had with some other frothing-agents.

"The test-mill worked from January 3, 1914, to June 30, 1915, and treated 257,272 tons of ore. From the latter date until February 8, 1916, it operated as a temporary unit in the general concentrating process, when it was closed down, having treated a total of 373,705 tons. Contrary to usual experience this test-mill paid the cost of its construction, its operating expense, the present average mining cost on ores treated and something besides, and has been written-off the books."

Operating costs at Inspiration for mining and milling will probably be from \$1 to \$1.15 per ton of ore.

Heard in the Bunk-House—I and II

By W. H. Storms

I

“DON'T you know there's a lot of luck in mining?” remarked the boss timber-man of the King Solomon mine, one night in the bunk-house.

“That's right,” exclaimed ‘Swede’ Murphy. “Luck's the word. I have knowed a lot of fellows who had plenty of savey, but they never could seem to hit it. Then, there's others that don't know nothin' that go out and strike it the first day.”

“That's so,” remarked the miner from Arizona. “It makes me think of the old Silver King, over in Pinal county.”

“And how was that?” inquired Murphy.

“There was four men at Florence,” explained the Arizona man. “There was Regan, Copeland, Mason, and Long. They had a pretty good copper claim 40 miles back of Florence in the mountains. They called it the Globe mine. Pinal county had just been formed and it was the day of the first county election, and Florence was the county seat. All hands was celebrating pretty free. These four men were making arrangements to go down with a pack-train over to their copper prospect, and bring down some ore to have it worked in the new smelter that had just been finished at Tucson. They had a parting jolt at one of the bars of the town and invited a soldier standing near to join them. They had more drinks, and this soldier got quite friendly. He said he knew where they could find a rich mine if they cared to look for it. They didn't take much stock in the soldier, but he was a chummy cuss, so they let him tell his yarn. He said he had a partner named Sullivan who had died, but that before he died he had told him about this rich place. He himself knew nothing of mining, so had never looked for it, but if they wanted it they could have it. ‘Now,’ says this soldier, ‘my pard tells me like this. You will go up the Stoneman grade and you will pass some tanks; then you'll pass old Pickett Post; about five miles beyond you will come to a little basin like, all surrounded by hills, and near the head of this valley you will see a lot of big boulders that have rolled down from the cliffs. They lie by the side of the road; just a bit beyond you will see a little brown hill all alone by itself. In that hill, if my dead pal was right, you will find the richest mine in the world, and,’ continued the soldier, ‘gents, you are welcome to it.’

“The party started next morning for their Globe mine. On their way they saw the several things described by the soldier—the tanks on the Stoneman grade; Pickett Post; the valley surrounded by high rough hills and the boulders, and, just beyond, was the little brown hill, just as described by the soldier.

‘There,’ said Regan, pointing to the knoll, ‘is our soldier's little brown hill and the richest mine in the world.’ Everybody laughed, and the party went on without even stopping to take a look at it. They reached the copper mine, loaded the pack-animals with rich ore and started back.

“When they again came in sight of the little valley, Regan, who was the leader of the outfit, gazed at the brown knoll, meditated a little, and, turning to Copeland, who had more experience than any of the others, said: ‘Copeland, I will lead the horse; you go over and just take a look at that little hill, and we will camp in the same place we did on the way up.’ Copeland went alone over to the hill, climbed to the top of it and at once saw an outcrop of high-grade silver ore—metal till you couldn't rest. Some of it was worth \$20,000 a ton. Selecting a few pieces Copeland went down to camp. Next morning the whole party went and staked all the ground they wanted. The rock was so rich they ran out a bar of silver in their portable forge, so they left the copper ore and took silver ore instead. They took 1500 pounds down to Tucson and sold it for \$800 cash. By April 15 they had the shaft started and went on down with it. The ore was rich to 700 ft., but there it gave out. Other shafts were sunk, some of them over 1000 ft., but none of them got much. The Silver King never levied an assessment. It paid its way from the surface to the bottom of the shoot, and produced several millions of dollars worth of silver. It was one of the richest mines ever found in Arizona, or anywhere else.”

“An' ye call that luck?” remarked Murphy, at the conclusion of the miner's story.

“Sure, I do,” replied the man from Arizona.

“So do I,” sententiously added Murphy, “pure, bull-headed luck.”

“Suppose they had not taken a look at it, even,” ventured one of the miners present.

“That,” responded the Arizona miner, “would have been damned bad luck for all of them.”

II

“Do you believe in ghosts?” asked the timber-man of the Arizona miner. “Some people do, you know.”

“No, I don't,” was the reply. “But I have known some people who do—at any rate they go to fortune-tellers and spiritualists, and that kind of people to get information and advice on mines. I don't go anything on them myself though.”

“I knew an outfit once, up in the Black Hills,” said ‘Swede’ Murphy, “an' it was a dandy. They was strong for ghosts. They called it the Golden Gravel Mining Company, or some such name. They was none

of them miners, but they had quite a bit of money, an' instead of hirm' somebody that knew somethin' about minin', these fellows paid a fine salary to a Madame somebody, who was a spiritualist, to steer 'em in the minin' game. Her first break is to advise 'em to buy a big bank of gravel on Castle creek because this gravel was rich in gold, which was news to the people who lived in that part of the country, but the Madame had a straight tip on it from the ghost of an old Sioux Indian chief. She went into a trance, an' this chief tells her the gravel is rich in gold, an' as the Indians had lived in the Black Hills for years before the white men came they ought to know better than anybody. The gravel lay up 50 to 60 ft. higher than the creek, an' the only way it could be worked was by hydraulic. To do this the company had to dig a ditch five miles long. This was done, but while they was diggin' it looked as if they might want more water than one ditch could bring in, so they dug a second one on the opposite side of the canyon. I expect you can see them old ditches yet, about 5 or 6 miles above the place where the South Fork comes into the main stream. When the ditches had been dug, pipelines laid, sluices built, and everything ready, they turned in the water and run the hydraulic night an' day for about a week and then they shut off the water to make a kind of clean-up to see how the thing was going. They found plenty of nice smooth iron-rock and other heavy stuff, but only about four-bits worth of gold. This gold was so fine you could almost blow it away. It took about a million colors to make a cent. The company shut down and ran for Madame. But she did another fit, and when she came to again she said the old Indian had not been quite clear in what he said the first time; that it was not in the gravel, but in the veins of upper Castle creek that big money lay in copper and silver. This satisfied these guys, and they went to work again as cheerful as chipmunks, diggin' open-cuts, sinkin' little shafts, and runnin' tunnels some of them in over 100 ft. This work was done wherever they could find a stain of copper, which was in quite a good many places. The rocks there is slate, an' quartzite, and this bright shinin' silver-lookin' rock the geologists call phyllite—a good name, I expect, though I don't know why. For all their work they only got a few stringers of poor copper ore an' no silver at all—didn't amount to nothin', so they give up an' went on the run for Madame once more.

"This time she near died in one of her spells, but she got back alive after a while, an' then she told them about a mine of very rich gold ore about two miles from Deadwood. The old lady had got this tip straight from the ghost of old Father DeSmet, himself, who knew the Hills better than anybody. She said the old Indian chief had been givin' her the double-cross, and she would have nothin' more to do with the likes o' him. The ground pointed out by the Madame was bought—I'm thinkin' she must have got a pretty good commission on all of these deals. So they went at it once more. The Madame wasn't only a minin' expert, she put up a bluff at bein'

a chemist too, as well as an assayer, an' she got some fine gold buttons from the bum rock they dug out of the hill near-by, though nobody else could get anything more than a few cents a ton out of the stuff. The rock couldn't be worked by any ordinary mill process, the Madame claimed, but this didn't stump her any. She just had another fit when some ghost friend of hers told her how to build a mill that would do the business all right, and the suckers fell for it again. I seed this mill once, when I was a young fellow. I ain't never seen another like it. It sure was a peach. It had a steam-stamp that worked in a round mortar with a screen all round like a drum. Below this stamp was six iron basins 5 ft. across and 8 in. deep. They was painted bright red and reminded me of six red-hot saucers. Besides these there was roasters and vats, and pulverizers, and I don't remember all else. When the mill was finished it had cost over \$25,000. Remember it was 250 miles or more to the nearest railroad them days and every bloomin' thing had to be brought into the country by bull-trains or mules. When she was finished they started up and treated 4 or 5 tons of the rock, got nothin' an' quit.

"This discouraged the company. They had spent over a hundred thousand. As they couldn't pay Madame her big salary any more, bein' broke, she quit 'em cold—wouldn't have nothin' more to do with 'em. The old mill stood there for years, at a place called Gayville, about two miles up the gulch from Deadwood, but I expect it is all gone now—for old iron, I suppose."

OPERATIONS of the United States Steel Corporation and its subsidiaries in the past two years resulted as follows:

| | 1915 Tons | 1914 Tons |
|--|--------------|--------------|
| Materials produced | | |
| Iron ore mined | 23,669,676 | 17,034,981 |
| Coal mined | 26,628,482 | 21,162,293 |
| Coke made | 14,500,818 | 11,173,914 |
| Limestone quarried | 5,795,925 | 4,676,479 |
| Pig-iron, ferro, and spiegel | 13,641,508 | 10,052,457 |
| Steel ingots (bessemer and open-hearth)..... | 16,376,492 | 11,826,476 |
| Rolled and other finished products..... | 11,762,639 | 9,014,512 |
| Universal portland cement, barrels..... | 7,648,658 | 9,116,000 |

The total value of business was \$486,352,054, compared with \$380,228,143 in 1914, an increase of 27.9%. Export business increased 122.4%, and domestic 15.9 per cent.

El Paso, Texas, is a well known mining and smelting centre, particularly for the American-owned mines in northern Mexico. An early Spanish explorer, it is stated, forded the Rio Grande in 1598 and named the place El Paso del Norte—the pass of the North. But not until the period of the Mexican war seventy years ago did El Paso change from a ranch to a border town. An old Spanish mission church was built at Juarez, just across the Rio Grande, about 1650.

COAL production of Michigan in 1915 was 1,156,138 tons, averaging \$2.05 per ton, a small decrease.

CONCENTRATES

Readers of the MINING and Scientific PRESS are invited to ask questions and give information dealing with technical and other matters pertaining to the practice of mining, milling, and smelting.

COST of the survey represented on maps sold for 10c. by the U. S. Geological Survey may be as much as \$5000.

COST OF HYDRO-ELECTRIC POWER at the Alaska Gastineau mine in 1915 was 0.268c. per kw.-hour, or 4.8c. per ton mined and milled.

MINERS applying for work at the Copper Queen, Arizona, are physically examined. This has reduced accidents and sickness, and increased efficiency.

SUPPLIES costing less per pound may cost more per year, because it is necessary to use so much more of an inferior material to accomplish the same result.

FATAL ACCIDENTS of the Copper Queen company in 1915 were only 1.05 per 1000 men employed, compared to 3.16 in 1914. This decided reduction was brought about by the work of the company's safety department.

HEATING PULP for flotation has the effect of minimizing the force of adhesion that tends to surround the mineral particles with water; that is, to wet them and thereby detach the air-bubbles which are instrumental in floating them to the surface.

SEARLES LAKE, in south-eastern California, contains the most valuable potash-bearing brine known in the United States. The exposed surface area is 11 or 12 sq. miles, and an average depth of 70 ft. The brine contains 2.1% potassium, equal to 4% potassium chloride.

RAISING OIL from wells by air-lifts may be more satisfactory than by using pumps. An air-lift is suited to raising liquid containing sand, mud, or slime. At Bakersfield, California, an air-lift in one oil-well raised oil 1200 ft. with compressed air at 182 lb., submergence 30%.

AUXILIARY PUMPS for emergencies when the regular equipment reaches its limit, at the Old Dominion mine, Globe, Arizona, were replaced by air-lifts, on account of the "much greater pumping capacity, freedom from shut-downs and more or less automatic operation" of the latter.

GRAPHITE GREASE is used for the lubrication of heavy machinery. It is said to adhere with exceptional tenacity, provided it is applied when the surface is dry. It is recommended for pump-plungers, steam-shovel chains, gears, hoisting, and transmission cables. It washes off with difficulty, so that it resists mine-water, sea-water, or drippings.

SCHEELITE concentrate containing bismuth is not keenly desired by ore-buyers. Bismuth gives as much

trouble as tin and molybdenum. The presence of gold and silver would not enhance the value of tungsten ore to any great extent, as it is difficult to extract the precious metals. Cyanidation of the concentrate before shipment might be suitable.

METALLIC MAGNESIUM, when added to aluminum castings in the proportion of 2% or less, has the excellent effect of making cleaner castings, doubling the tensile strength, and quadrupling the resistance to shock or jar. The cost of machining is reduced more than 50% and a more clean-cut machined surface results. Magnesium metal is recommended as a substitute for aluminum and copper in the making of alloys. It makes excellent castings, is a third lighter than aluminum, can be made two to four times as strong, is as resistant to corrosion when pure, and has an equal electrical conductivity.

HEATING a large building by electricity in a northern climate is exemplified by a new large concrete high-school at Burley, Idaho. Using two of the three stories of the building, the total cubical content of which is 780,000 cu. ft., the heating bill for the year is \$1800 with electricity at \$1 per kilowatt per month, based on the maximum service during the month. The current is reduced at the building from 2200 to 220 or 440 volts depending on the heat desired. The cost per year seems high, but the labor required is almost negligible, as are space, stack, and coal-smoke. The current is supplied by the Minidoka plant of the U. S. Reclamation Service.

WIRE ROPE wears from four principal causes, namely, abrasion, undue bending, over-strain, and corrosion. Abrasion is caused frequently by faulty grooves on sheaves or from dragging of the rope on the ground. To prevent corrosion, wire rope should be lubricated and kept as free from water as possible. The core of a wire rope is usually hemp saturated with a lubricant; it provides little additional strength, but acts as a cushion to preserve the shape of the rope and helps to lubricate the wires. Standard wire rope, such as for hoisting, is made of six wire strands over a hemp core, each strand containing 19 wires. Ropes with 12 or 7 wires per strand are stiffer, being more adapted for standing rope, guys, and rigging.

BELTS are expensive when improperly installed or cared-for, whether they be leather, camel-hair, canvas, cotton, or other material. The endless, jointless belt gives the best service, as joints are always weaker than the main part of the belt. To make an endless belt the joint should be similar to that made by the manufacturers—cemented, or cemented and riveted. If a laced joint is decided on, taking the efficiency of the endless belt at 100, wire-lacing is 95, and rawhide-lacing 80, according to W. F. Schaphorst in *The Iron Age*. Belts should be pliable in all ways, especially longitudinally, so as to wrap close about pulleys. Belts must not be allowed to slip; to prevent this they should be kept at the proper tension or dressed occasionally.

REVIEW OF MINING

As seen at the world's great mining centres by our own correspondents.

JOHANNESBURG, TRANSVAAL

COMPANIES AND THEIR STATES.—WEST RAND DEVELOPMENT.

The Rand goes on its even way. At the mines and in Johannesburg generally the immediate effects of the War are less felt than in any part of the Empire. Most of the financial groups have been most generous in giving their employees leave to join the forces in Flanders or East Africa. Half-pay for married men and quarter-pay for single is the general rule. I know of cases where men have given their services for a week or two on a mine, and then been allowed to join the forces on half or quarter pay. The groups known before the War as of German origin and control have been particularly liberal. Of course, on any one mine the management can only be allowed a limited number of men who are to receive half or quarter pay. This means that even with the liberal arrangements made, some men are bound to be disappointed, and feel they have a grievance. There is one group, however, where perfect harmony prevails, and no complaints are heard of any kind. That is because, from highest to lowest, all are treated absolutely impartially. Nothing in any shape is being given or promised to anybody, hence there is no discontent or grumbling. It has not, however, prevented a lot of men going to try and do their bit. More power to their elbow!

Well, about the mines, the Far East Rand is the fashion, and the excellent results of the Springs mines development has largely helped to boom this district. Things are going strong, and look like going stronger yet. It is quite certain, of course, that judging by the past, the thing will be overdone. A new formula is being preached, the 50% one. Only have an area big enough, and you are rich beyond the dreams of avarice. Still, prospects out here are brighter than looked at all likely at one time, and many more mines may be opened up to give work to the poor man. And may the plucky firm of Barnato Bros. and the Mines Selection Company have their legitimate reward! It is a pity, however, that the Union government does not follow the excellent example of the West Australian government and make all mine-plans, including assay-plans, free to the public. At present, one has to rely on a carefully edited monthly or quarterly report. Certainly the reports published by most of the groups give far more details than they used to. Still there is a lot to be done before we are anywhere near the West Australian standard. The idea that the shareholder is a young child, and should only be told what his parents would like him to believe, is by no means dead yet. Outside the developments on the Far East Rand, a most important fact, and one that may be news to some of you is that on the Western Rand extensive exploratory work and a lot of mining is being done on two, at least, of the lower-grade but wide reefs lying to the south of the Main Reef series. The Kimberley series is being mined on the West Rand Consolidated, and the Randfontein Estates is extensively mining on what is probably the Bird Reef series. Of course, both of these mines are continuing work on the Main Reef series proper. If these southern bankets continue profitable, there is no reason why they should not do so in the other mines. Little or no intelligent exploratory work has so far been done on these 'reefs,' except on the mines I have mentioned. Now is the time for you American financiers, not perhaps to buy shares, but to come over and see things for yourselves.

JOPLIN, MISSOURI

UNITED STATES ZINC SMELTING CORPORATION'S ACTIVITIES.—

FROM POOR PROSPECT TO RICH MINE.—CALAMINE AND LEAD POKKLE MINING.

The United States Zinc Smelting Corporation, which has acquired the holdings of William Kenefick in the Joplin district, reports three drill strikes, two exceptionally good, on a 26-acre lease of the Muskingum Mining Co.'s land, one mile west of Joplin. Construction of a 350-ton concentrating plant, entirely new, is to be started early in May. Properties operated by the U. S. Corporation are the Media Mining Co. and the Electrical Zinc & Lead Mining Co., north of Webb City; the Coyote Mining Co., and the Airedale Mining Co., west of Joplin; and the Milan Mining Co., at Prosperity. To this list will be added the new mine on the Muskingum land. This lease adjoins the Coyote mine on the north and practically the same run of ore is to be worked. Drilling on the Muskingum lease showed sheet-ore beginning at a depth of 181 ft., continuing to 195 ft. Assays of the drill clippings gave an average of 3½% blende and lead, from which a mill recovery of almost 3% can be expected. This is about the same saving being made by the company's Coyote and Airedale mines. Formation of the Corporation was perfected at Albany, N. Y., during the latter part of April; 600,000 shares, of no par value, are issued. Included with the Kenefick interests is the Pearlman company, operators of the Clarksburg, West Virginia, Zinc Smelting Co. The officers of the new company are William Kenefick, president; R. A. Cowles, vice-president; and Arthur Day, treasurer. The company claims to operate mines from which 25% of the high-grade zinc-blende of the Joplin district is produced.

Stories of get-rich-quick mining propositions in the Joplin district are frequently grossly exaggerated, especially during the past year or two of record-breaking ore prices; but an occasional instance sometimes arises which is so striking that it proves interesting. The development of a profitable mine, as a rule, covers a period of several years. The opening of the Emperor mine, on a 40-acre lease of the American Zinc, Lead & Smelting Co.'s land, two miles west of Joplin, occupied a period of only a few months, and is now rated as one of the heaviest temporary producers of the west Joplin field. Charles T. Rhodes and W. T. Crane found it a difficult matter to raise \$150 when they began prospecting on their lease on July 1, 1915. Their only equipment was an overworked hoist, housed in a fragile derrick. At the end of the first two weeks' work they found it necessary to divide their interests with others in order to provide operating expenses. Five partners were eventually taken in; but even with this co-operation of funds, the regular Saturday night assessments became so irksome that it looked much as though the Emperor lease was to be abandoned through sheer inability to raise enough money to continue the work. At a crucial moment, when prospecting was about to stop, a heading broke into a pocket of rich blende and lead. It became necessary to sink a new shaft because of the bar character of the ground, but with good prospects ahead, the partners borrowed enough money to carry on their work and the new shaft was put down a depth of 75 ft., and started driving. Four drifts were put into the orebody, and the 'dirt' was treated at a custom mill. The first few lots showed the ore to carry more than 20%

blende and some lead, and the cleaned blende concentrate contained over 59% metallic zinc. In a few weeks the partners had the cash in hand to construct a new 150-ton mill, which is now working steadily, producing as high as 14 tons of concentrate per day, and seldom less than 10 tons. While the ore is so rich that it is doubtful if the formation is extensive, still the drifts continue to show the same run of ore, and recent prospecting opened a good stope under the old workings. The five partners are now clearing from \$300 to \$1000 per week each.

South of Carthage, on the land of Henry Weymann of Joplin, several families are operating on shallow calamine deposits. The word 'families' is used correctly, as a visit to the land proves. Children, men, and women are at work in gouges that are not more than 6 ft. deep. Not only is calamine taken out, but an occasional pocket of free lead is found which places the owner of that particular mine in the 'bonanza' class until his riches have been exhausted. As a rule the ore-pockets are not extensive.

HANOVER, NEW MEXICO

OPERATIONS OF THE EMPIRE ZINC CO.

The Empire Zinc Co. of Denver, Colorado, has been operating its zinc mine here for several years, shipping zinc carbonate direct to the smelter. Now, however, as the mine is being developed below the 150-ft. level, and the orebody is found mainly to consist of zinc sulphide, associated with pyrite, chalcopryite, and other minerals, the company decided to construct a concentrating plant to make a product suitable for



NEW MILL, ETC., OF THE EMPIRE ZINC CO.

shipment to smelters. Building operations were commenced on November 1, 1915, and it is expected that the mill will be completed and in operation by June 15 of this year.

The scarcity of water in this district necessitates dry crushing throughout. The ore is first broken by a Blake type crusher. This product is conveyed to four rolls (manufactured by the Power & Mining Machinery Co.), then to incline screens, the final material obtained by Rowan-Wetherill magnetic type electro-static separators, eight of which are installed in the mill. The total capacity will be 150 tons per day.

Power is obtained from a 250-hp. Snow-Diesel type two-cylinder four-cycle engine, driving one 75-kw. a.c. and one 75-kw. d.c. generator, which supplies all the power required to operate the mill.

A number of comfortable dwellings have recently been built for the employees of the company; in all about 30 structures, including the mill and power-house. The latter two buildings, by the way, have been painted a brilliant vermilion, adding a touch of color to the otherwise dun-colored scenery, making a distinctive land-mark which can be seen for miles in almost every direction.

K. A. Strand is superintendent with C. J. Brown assistant, and C. A. Schmidt in general charge.

TORONTO, ONTARIO

REPORT ON KOWKASH.—FLOTATION AND GENERAL PROGRESS IN THE COBALT DISTRICT.

The Kowkash gold area is likely to attract many prospectors this season, especially the western section around Tashota, 22 miles west of Kowkash station. The Ontario Bureau of Mines has issued a report by P. E. Hopkins, who made an examination of the area last fall, descriptive of the geology of the locality and the principal discoveries so far made. The formation of the area is pre-Cambrian, the rocks being dominantly of Keewatin age, with some Temiskaming sediments and later intrusions of feldspar-porphry, granite, and diabase. This formation, similar in character to that of Porcupine, extends over a territory of 600 square miles. While gold is widely distributed, enough work has not been done to prove its occurrence in commercial quantities. Mr. Hopkins regards the district as worthy of thorough prospecting, not only for gold but for iron ore and pyrite. At the King Dodds claim, the original discovery, a 14-ft. pit was sunk, but the free gold disappeared a few feet down, and samples at the bottom of the shaft gave low assays only. What appears to be the most promising discovery was made on the Devanney claim, near Tashota, where a vein averaging 12 in. or more has been traced for 600 ft. It carries fine gold and a telluride in considerable amount, and high assays have been obtained. In all, over 1000 claims have been staked, mainly around Tashota, near the Dodds discovery, and in the vicinity of the railway between Kowkash and Tashota stations. The four Devanney claims have been purchased by Boston interests, and supplies are now being taken in. Work will be started in a few days.

Activity in silver mining has been considerably stimulated lately by the increased price of the metal. Flotation is making steady progress at Cobalt, and it is considered probable that old dumps of tailing can be profitably re-treated by this process, in addition to making available a large amount of low-grade ore now left underground. The Callow system is the one adopted. The Nipissing has treated several hundred tons of ore in its experimental plant. The installation of the 150-ton plant at the McKinley-Darragh has been retarded

by delays in the delivery of machinery, but it is expected to be in operation in May. The Buffalo plant will have a capacity of 600 tons per day, and its construction is well advanced. The Buffalo is now making a recovery of quicksilver by a new process and making shipments to the head office in Buffalo.

The new cyanide mill at the Coniagas is at full capacity, 180 tons per day. The mine has enough ore to keep the plant supplied for two years.—The Trethewey company has cut a new vein in the old Rochester property. It is 3 to 5 in. wide, and assays from 500 to 2000 oz. silver per ton.—The annual report of the Beaver Consolidated for the year ended February 28 shows gross earnings of \$351,124, and profits of \$128,929. Production was curtailed during the year owing to the low price of silver. The recovery was 746,310 oz. from the treatment of 30,093 tons of ore. There is 34,322 tons of broken ore ready for milling.—The Seneca-Superior has closed down, the vein being worked out.

There is much activity shown in the outlying parts of the Cobalt field.—In Gowganda the Reeves Dobie is mining high-grade ore, and rich ore is reported at the Bishop mine.—Several Elk Lake properties are being re-opened.—In South Lorrain the Comfort company is erecting a mill.

THE MINING SUMMARY

The news of the week as told by our special correspondents and compiled from the local press.

ALASKA

BETHEL

(Special Correspondence.) Miners are busy hauling provisions and lumber to Canyon and Windy creeks. On Bear creek several miles of placer ground has been taken up under option. It is probable that the gold output of the Kuskokwim region will be greater this season than in 1915, which was the best since 1907. The gasoline schooner *Abler* was lost some time ago with supplies for Bethel. The power schooner *Bender Brothers* was frozen in the Kuskokwim river just below Bethel. It is one of the pioneer vessels plying to this place with supplies for miners, the Government, traders, and missions. Its capacity is 250 tons. During this spring the *Ruby* of 150 tons, and *Hugh Hoven* of 1000 tons' capacity will run from Seattle to this place.

Bethel, February 19.

All construction work on the Government railway from Anchorage north has been stopped on account of labor troubles. The men demand 55c. per hour, in place of 35c. at present.

Later news states that the trouble has been settled.

COGOWA

(Special Correspondence.)—Twenty-two copper claims on Hidden creek, 7 miles north-west of Kennecott, have been purchased by the G. E. Rowe company of Seattle from the Tjosvig brothers. A tramway is to be constructed across the glacier.

McCarthy, April 14.

JUNEAU

At the 300' mill of the Alaska Treadwell, the 400-hp. motor that has been working on the 'A' side for over 6 years has been transferred to the 700' mill of 120 stamps, a 500-hp. machine replacing it in the 300-stamp mill.

March returns of the three companies operating on Douglas Island were as follows:

| | Mexican | Treadwell | United |
|--------------------|----------|-----------|----------|
| Stamps working | 120 | 540 | 300 |
| Ore crushed, tons | 18,925 | 80,871 | 46,895 |
| Gold production | \$23,522 | \$134,922 | \$78,493 |
| Operating expenses | 27,789 | 103,593 | 73,703 |
| Construction | 5,652 | 10,100 | 10,530 |
| Profit | | 18,689 | |
| Loss | 19,115 | | 6,539 |

ARIZONA

COCHISE COUNTY

Estimates of gold are heard from Johnson, a producer of gold, silver, copper, and iron ores. The population is over 1500, against 200 a year ago. The Arizona, Michigan, and Republic are the largest producers making regular shipments to smelters. The Cochise company employs 100 men, and mines 200 tons of copper ore daily. Several good prospects are in the development stage.

GRAY COUNTY

At the Inspiration mill, some additions are to be made to increase the recovery of copper, iron, and steel work being prepared for this. Oliver filters will dry the flotation concentrate. Two-stage centrifugal pumps made by the Byron Jackson company of San Francisco have been installed to return the overflow water from the tailing pond to the mill. These machines have a capacity of 3000 gal. per minute.

MOHAVE COUNTY

Flotation plants each of 50-ton capacity are to be erected at the Leviathan copper and American molybdenum mines in the Cedar Valley district.

The Schuykill mine at Chloride, which has an extension of the Tennessee veins, has started dewatering operations. This company shipped high-grade silver-lead ore to the Benson smelter in the early 80's, and large bodies of commercial ore were exposed on the 500-ft. level.

At 185 ft. in the Big Jim at Oatman the lode is 10 ft. wide, worth about \$12 per ton. Near the foot-wall the ore was of better grade.

Copper claims 40 miles north of Chloride have been sampled by the Copper Queen Consolidated company.

PIMA COUNTY

Much work is under way at the New Cornelia company's property at Ajo. Good progress is being made at the various shops and plant excavation. The company is also beautifying the town by planting trees in the plaza.

The A. S. & R. Co. has blown in its furnaces at the Sasco smelter, to treat ore from the Imperial Copper Co. Outside mines will also supply ore, it being hauled over the Arizona Southern line.

SANTA CRUZ COUNTY

The Three R copper mine in the Patagonia district has been sold by R. R. Richardson to the Harrison interests of Mexico for \$500,000, through the work of C. C. Sanders. A mill is to be erected to treat the low-grade ore. Under option the mine was profitably worked by N. L. Amster of Boston.

CALIFORNIA

The total oil production of California in 1915 has just been determined from the sworn statements made to the State Mineralogist by all of the 363 producers; it amounted to 88,249,620 bbl. This is doubtless the most accurate figure that has ever been obtained, and it is of interest to note that it is in close agreement with the figures given to the public at a much earlier date by two private concerns, namely, the Standard Oil Co. and the Independent Oil Producers Agency. Private parties publishing such information perform a distinct public service, the value of which should be more generally recognized, and encouragement given to enlarge its usefulness by touching on the quality of oil produced. Of the total amount of oil, 33%, or 29,587,163 bbl., was produced by the five large refining and marketing companies, and 16%, or 13,704,982 bbl. by the several large concerns, such as the railroad companies, who use the oil in their own service. The remaining 51%, or 41,948,475 bbl. is credited to the smaller producers who usually sell the crude oil at the well. The natural gas which was marketed has also been accounted for, giving a total of 11,992,000,000 cu. ft., over 90% of which was from Kern county. On the enlargement of its engineering force, in the near future, the State Mining Bureau intends to conduct a more detailed investigation of natural gas production with the idea of being able to point out means of more economical use of this splendid natural resource which is too frequently wasted.

The present extent of proved oil land in California has just been determined by the State Mining Bureau in the most accurate and detailed study ever given to the subject. The total

is 126 square miles, or 80,702 acres, of which 55,842 acres is in Kern county. Fresno county is second on the list with 12,218 acres, and Santa Barbara county third with 6030 acres. The other counties in their regular rank are Orange, 3305; Los Angeles, 2326; Ventura, 749; San Luis Obispo, 202; and Santa Clara, 30 acres. It is worthy of note that the total area of proved oil land is most insignificant in comparison with the

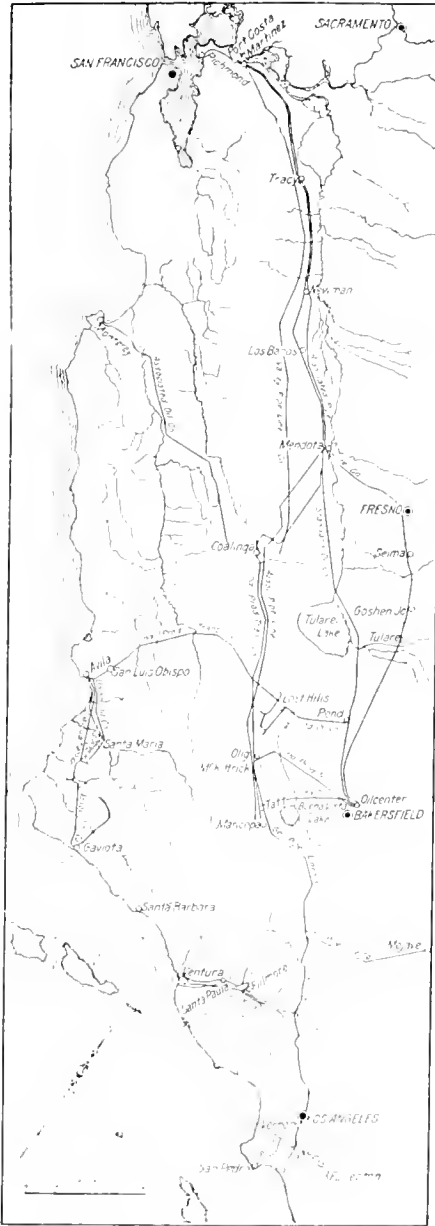

MAP SHOWING OIL PIPE-LINES IN CALIFORNIA.

area of the entire State, being less than 1/1000 part; yet the oil business is one of the State's most important industries. Estimates of the total amount of oil which can be recovered from the land are little better than pure guesses, but it seems most probable that the average acre will ultimately yield much less than 50,000 barrels.

It is said that the Shell Oil Co. will lay another pipe from Coalinga to Martinez, a distance of 180 miles. In the April number of *Western Engineering* the oil pipe-line systems of California are described by C. P. Bowie. Seven companies transport oil by pipe, having a total length of 2000 miles, with an estimated daily capacity of 370,000 bbl. The accompanying map shows the lines.

Final returns on the following minerals have been received by the State Mining Bureau for 1915:

| Mineral | Tons | Value |
|-----------------------|-----------|-----------|
| Barytes | 410 | \$620 |
| Bituminous rock | 17,789 | 61,468 |
| Borax | 67,004 | 1,663,520 |
| Cement, barrels..... | 1,846,313 | 5,972,988 |
| Chrome | 6,337 | 49,842 |
| Dolomite | 3,492 | 11,354 |
| Feldspar | 1,800 | 9,000 |
| Iron ore | 646 | 2,584 |
| Lithia mica | 91 | 1,365 |
| Mineral paint | 311 | 1,756 |

Under barytes is included a certain tonnage of witherite, the carbonate of barium. This is the first commercial deposit of witherite in the United States of which the Bureau has any record. The production of chrome is the largest in tonnage, though not in value, of any year since 1881. Dolomite is a new item in the commercial mineral list of California, at least this is the first year that it has been segregated as such. It was formerly included under limestone. The major portion of it was used for a basic lining in steel furnaces. Some nickel ore was taken out at the Friday copper mine in San Diego county; but as yet the owners have been unable to get any smelter to treat it for them. A discovery of tin ore has been noted from San Diego county, but no production has resulted yet. Molybdenite was mined in one or two localities in the latter part of 1915, but not marketed.

ALAMEDA COUNTY

Near Tesla, south-east of Livermore, the Manganese Co. of California, in charge of E. A. Wiltsee, is dispatching 5 cars of ore each week to the East.

CALAVERAS COUNTY

Another dredge, No. 3, is to be constructed for the American Gold Dredging Co. (late Oro company) near Comanche on the Mokelumne river. Some of the machinery from its Victor dredge at Oroville will be used.

ELDORADO COUNTY

After being idle since 1864 the Bunker Hill copper mine near Penobscot is being re-opened in charge of D. L. Shepherd.

NEVADA COUNTY

The well-known, equipped, and developed Union Hill mine at Grass Valley, producing gold and tungsten, has been acquired by San Francisco people headed by F. W. McNear and E. L. Oliver. Errol McBoyle is general manager.

PLUMAS COUNTY

Eastern capital has purchased the White Lily gold mine near Seneca, and proposes to erect a large stamp-mill and cyanide-plant.

SAN BERNARDINO COUNTY

Three veins, 6, 8, and 12 ft. wide, containing high value in gold, have been opened by the Lietzow Consolidated, operating at Crucero, on the way to Barstow and Goldstone, the new district. The shoots are in limestone formation, near the porphyry contact. A complete equipment is to be bought. At the Desert Queen mine, 7 miles away, high-grade copper ore is being extracted.

The Owl Head manganese mine near Silver Lake is producing 970 tons of ore per month. Two more Holt 75-hp. caterpillar tractors have been acquired. Thirty-five men are employed. A railroad is being surveyed. The Mollett Development Co. of Massillon, Ohio, is owner. R. L. Mann is consulting engineer.

SHASTA COUNTY

At the Friday-Lowden property of the Mammoth company the adit is in 1100 ft., with a daily advance of 15 ft. The final length is to be 4000 ft. The company has enlarged its social hall for employees at the Mammoth mine.

On April 29 fire at Harrison Gulch destroyed most of the town and mining property worth \$100,000. The Victor company's Midas mine equipment suffered considerably. The cyanide-plant is again in operation.

TULARE COUNTY

(Special Correspondence) The Tarantula mine, near Shawmut, has been taken over by Henry T. Kluge, who, it is said, will operate the property in connection with the claim on the Jones ranch which he has held for some time. The Tanya mine, near Sonora, is being reopened for the resumption of work after an idleness of several years. Local men are supplying the capital and Fred Lauer, an experienced miner in these parts, will direct operations. The Pine Log Mining Co., which will work a bar on the south fork of the Stanislaus river, near the mouth of Five Mile creek, has been hauling machinery to the property, and expects to begin work soon.

Marble of high quality has been discovered on the Bell property, near Columbia, and exploration work has commenced. The property is in the hands of E. Hill and J. Warren. An electric hoist is to be installed at the Faxon mine, north of Sonora, operated by F. A. Burgson and F. R. Restano. The old shaft on the property has been abandoned and a new one started. Now 80 ft. deep, it will be sunk an additional 50 ft., when a cross cut will be started toward the old workings. The Stanislaus Gravel Mining Co. has suspended operations at the H. I. Can mine, situated on Table mountain. It is understood that one of the principal owners will resume mining activities in the near future.

Sonora, April 21

At a point 1044 ft. from the portal of its adit the Springfield Tunnel & Development Co., near Columbia, has opened rich gravel.

Commencing May 1, the Hutch-Sweeney Mining Co., W. J. Loring general manager, will raise miners and certain surface men's wages 25c. per shift. This was voluntary.

COLORADO

BOULDER COUNTY

The U. S. Tungsten Co. has acquired the properties of the Colorado Tungsten Co., near Nederland, for several hundred thousand dollars. The former concern is a new corporation, organized by T. E. Foley, J. B. Ross, and others of Denver, and W. M. Long of Boulder, with a capital of \$1,250,000. High-grading tungsten ore is rampant in the district and arrests are reported.

GILPIN COUNTY

This county is being searched for tungsten ore, and good ore is reported from Apex and Hughesville mines.

LAKE COUNTY (LEADVILLE)

Wolframite and scheelite is the subject of a paper by R. S. Fitch and G. F. Loughin in *Economic Geology* for January. The latest of the many types of orebodies to be identified here is that of gold-bearing quartz-pyrite veins containing these tungsten minerals. The ore mined is from some leases on the Bex and adjoining properties to the south, on Breese Hill. The daily output of ore, assaying 0.8 oz. gold and 0.5 oz. silver, is 200 tons. The country-rock near the shoots includes Weber grit and gray porphyry, and the veins may cut both. Tungsten minerals are distributed throughout the zone of higher-grade ore, persisting downward with the shoot, their quantity increasing with depth. Scheelite is more abundant on the upper levels, wolframite on the lower. It is probable that the tungsten veins at Leadville represent a transition stage between contact-metamorphic deposits and the gold-silver sulphide veins.

SAN JUAN COUNTY

A wide vein of high-grade libnerite has been found in the Ruby and Cascade mines in Maggie gulch near Silverton.

After several years' idleness the Kittimac mill is again in operation. Treatment includes the Huff electrostatic process and flotation.

TELLER COUNTY (CRIPPLE CREEK)

Forty tons of ore, worth \$1 per pound, was recently shipped

from the Cresson mine to the Golden Cycle mill at Colorado City.

In March the Vindicator produced 12,621 tons of ore, lessees contributing 6302 tons. Electric pumps are being installed at 2150 ft. in the Golden Cycle mine. The Vindicator has paid its last note for the purchase of the Golden Cycle mine, \$1,250,000.

There were no bidders at Colorado Springs on April 25 for the properties and plants of the U. S. R. & R. Co. in this State. The minimum price has been reduced to \$200,000, and another sale was to be held on May 2.

'The Lure of Cripple Creek Gold' is the title of a 48 page booklet published by Wm. Y. Seaman. "Hundreds of millions" (\$351,761,653), is the output to the end of 1915, of which shareholders received \$51,888,681. The first dividend-payer was the Pharmacist, located by a drug-clerk. Mary McKinney stock was once traded for groceries and supplies around the town. It has produced nearly \$9,000,000 since. To 'Bob' Womack should be given credit for the first discovery in the district, in 1890. The name "Cripple Creek" is believed to have sprung from the fact that many of the grazing cattle had their legs broken in Womack's prospect holes. The split-check leasing system, now used in many States, originated at Cripple Creek. Three Irish-Americans discovered the Portland. Straiton's Independence was the first great mine of the district. The Cresson was a despised prospect, but disproved that term by its fabulous vug in 1915. Gigantic strides have been made in mining and metallurgical work. What of the future?

These are some of the interesting points discussed in this little work.

IDAHO

SHOSHONE COUNTY (COEUR D'ALENE)

An order, returnable April 29, has been issued by Judge W. W. Woods of the district court of this county, at Wallace, summoning the officials of the Success Mining Co., operating in the Nine-Mile district, to show cause why they have refused to permit shareholders to examine the contract they are alleged to have entered into with the Grasselli Chemical Co. of Cleveland, Ohio, for smelting the output of the Success property, effective from May 1. Settlement rates are alleged to be unfavorable.

The Board of Trade of Wallace is considering appealing to the Northern Pacific Railway company to extend its line up Nine-Mile creek into the Beaver Creek region through a tunnel to be driven at Dobson pass. This, it is thought, will divert the business and traffic of the rapidly developing Beaver Creek district to Wallace, which now stands a good chance of losing this trade. The Ray-Jefferson, Interstate-Callahan, Idora, and Tusconmbia companies' operations suggest that this work be done.

The Coeur d'Alene Antimony Co., operating near the mouth of Pine creek, is under new management. Electricity is to supersede steam, a flotation plant is to increase the present 65% recovery of the antimony.

The first unit of the Empire Copper Co.'s new mill on the little north fork of the Coeur d'Alene river will be ready in three weeks. It will be of 300-ton capacity. In the mine is 100,000 tons of 3.2% copper ore.—A Spokane syndicate, headed by F. J. Finucane, president of the Holly-Mason Hardware Co., has purchased control of the Alameda Mining Co., which has a group of claims adjoining the Success holdings in the Nine-Mile district. The ore contains lead, silver, and zinc.—F. C. Bailey of Spokane has taken a year's option on the treasury stock of the Placer Creek Mining & Milling Co., about 100,000 shares, and 50% of the issued stock. The contract specifies that Mr. Bailey is to keep the property under continuous development during the life of the option, the Placer Creek company to furnish the equipment. The property consists of five claims, six miles up Placer creek from Wallace.

MICHIGAN

THE COPPER COUNTY (HOUGHTON, ETC.)

(Special Correspondence.)—No event of recent copper mining interest in the Lake Superior region has attracted more attention than the announcement of the purchase of control of the Seneca by Thomas F. Cole and associates. It means immediate development work on a large scale, as Mr. Cole has announced that \$1,000,000 is to be spent to make Seneca a commercial copper producer on the Kearsarge lode. The Seneca is admirably situated, being near the Ahmeek and Mohawk. The area is 1800 acres. No work has been done for six years. The Calumet & Hecla company owned 11,270 shares in the Seneca, and holders approve of the transaction.

Houghton, April 18.

It seems likely that the Tamarack will be sold to the Calumet & Hecla for \$59 per share, as so far holders of over 25,000 shares have assented to the proposal.

Later news states that the voting was 48,870 shares in favor, against 479 in opposition to selling the mine.

MISSOURI

JASPER COUNTY

Ore prices were easier at Joplin last week. The Missouri-Kansas-Oklahoma region produced 9148 tons blende, 672 tons calamine, and 1267 tons lead, averaging \$105, \$76, and \$99 per ton, respectively. The total value was \$1,138,020.

Better recovery of metals is the slogan in the district, and slime plants are being added to many mills. The Dorr thickener is used by the Picher Lead, Commerce, American Zinc, Granby, and other well-known companies.

MONTANA

SILVERBOW COUNTY (BUTTE)

At 2500 ft. in the Davis-Daly there is 400 ft. of 6% copper ore, over a width of 8 feet.

During March the Butte & Superior produced 12,199 tons of zinc concentrate from 52,089 tons of ore. The concentrate was valued at \$93.62 per ton. In the suit of the Elm Orlu v. the Butte & Superior, Judge Bourquin has awarded the former 31,805 tons of ore assaying 20.5% zinc and 6 oz. silver per ton.

The Bertha mine has been unwatered by the Boston-Corbin company. The workings are 1200 ft. deep. Ore will soon be extracted.

By order of the Court at Butte one of the creditors of the Butte-Duluth company has permission to sell part of the equipment through the receiver.

NEVADA

The report of the Nevada-California Power Co., which has hydro-electric plants near Bishop, Inyo county, California, and supplies Goldfield, Tonopah, and other mining centres of Nevada, as well as southern California, shows that the operating revenue in 1915 was \$899,562. The operating profit was \$367,553, plus \$80,695 from sundry sources. Interest absorbed \$197,324, and dividends \$200,000.

ESMERALDA COUNTY (GOLDFIELD)

Final figures of the Goldfield Consolidated for March show a net realization of \$54,128 from 30,000 tons of ore. Costs totaled \$5.48 per ton. Development covered 3041 ft., at a cost of \$5.58 per foot, but revealed little of importance. The 500-ton flotation plant is to be increased to 1000 tons, for which plant has been ordered.

In the Silver Pick Consolidated, the Calyx core-drill working from the 700-ft. level, has cut the shale at a depth of 1000 ft. At the latite-shale contact assays as high as \$50 per ton are reported. This is of importance, and the shaft will be sunk 300 ft. to reach the contact.

The annual report of the Atlanta Mines Co. states that the output was 1832 tons of ore worth \$30,115, yielding \$13,022 net, from the shoot above the 1750-ft. level; also 1212 tons of ore worth \$6214 net from the Grizzly Bear claim. The ore-shoots are irregular, and not enough has been developed to warrant erecting a mill, yet ore might be sent to the Goldfield Consolidated or Nevada Metal Extraction plants for treatment. Mine development cost \$97,590. The debt is \$85,343.

HUMBOLDT COUNTY

The advance in price of silver makes an increase of \$5000 in the monthly output of the Rochester Mines Company.

The old Humboldt Queen silver mine, 7 miles north-east of Orcana, has been re-opened and is producing ore. It was closed in 1873.

LINCOLN COUNTY

According to the report of the Prince Consolidated Mining & Smelting Co. of Pioche for 1915 the output was 119,003 tons of ore, etc., giving a revenue of \$313,019. Ore reserves, partly opened, are estimated at 6,156,000 tons, occurring in four 'beds,' the 90, 20, 5, and 12 ft., an average aggregate thickness of 120 ft. The ore is a manganese-iron, containing silver, lead, and gold. The operating profit was \$158,554. Dividends absorbed \$124,924. Assets amount to \$106,637. To treat 120,000 tons of gold-silver-lead tailing at Bullionville, a \$40,000 flotation plant is to be erected.

MINERAL COUNTY

It is said that tin in commercial quantities has been found in the tungsten deposits near Sodaville. This was detected during concentration.

NYE COUNTY

In the week ended April 22, Tonopah mines produced 8334 tons of ore valued at \$175,272. Some March returns were as follows:

Belmont: 272,077 oz. bullion from 13,120 tons, with \$105,478 profit. Extension: 184,420 oz. from 7521 tons, and \$78,246 profit. Jim Butler: profit of \$24,678 from 3166 tons.

WHITE PINE COUNTY

(Special Correspondence.)—The Nevada Scheelite Co., a Utah incorporation, has been recently formed with directors and officers as follows: A. W. Gates, president and secretary; E. R. Pembroke, general manager; George R. Sheldon and W. J. Stewart, completing the directorate. One of the objects of this company is to take over 20 claims in the Minerva district and develop the large tungsten veins thereon. On a recent visit to the property, the manager saw the completion of the company's first camp, and outlined the establishment of a second which is now well under way. About 15 men are at work at the property at this time, and this company expects soon to enter the active list of producers of tungsten ore.

Salt Lake City, April 22.

On April 21 four tons of tungsten concentrate worth \$25,000 was shipped by express from Ely by the U. S. Tungsten Corporation, operating at Tungsten, 45 miles east of Ely. The buyer was the Midvale Steel Co. of Pittsburg, Pennsylvania. The company is in the market for tungsten ore containing over 3% delivered at Tungsten. In a published schedule of wages this company's lowest is \$4 per day for surface labor and shovelers.

Discoveries of tungsten ore are reported from many districts, a recent one being 15 miles east of Ely, the mineral being ferberite. Another was scheelite in the Cherry Creek district.

The property of D. Simonson and H. Ashley in the Tungstania district has been purchased by C. Osterlund of Ely for \$20,000.

Good reports come from Weaver Creek, six miles east and south of Osceola.

Ely is optimistic as to its future, depending on the adjacent copper and tungsten regions.

UTAH

BOXLEDER COUNTY

In Bulletin 649A of the U. S. Geological Survey, H. S. Butler and V. C. Hetkes give notes on the Promontory district, where operations of the Lake View Mining Co. attracted considerable attention in 1915. Present activity is confined to the zinc-lead deposits, which are found in the middle limestone bed. This bed is 50 to 75 ft. thick, included in members composed prevalently of shale. Shipments of ore

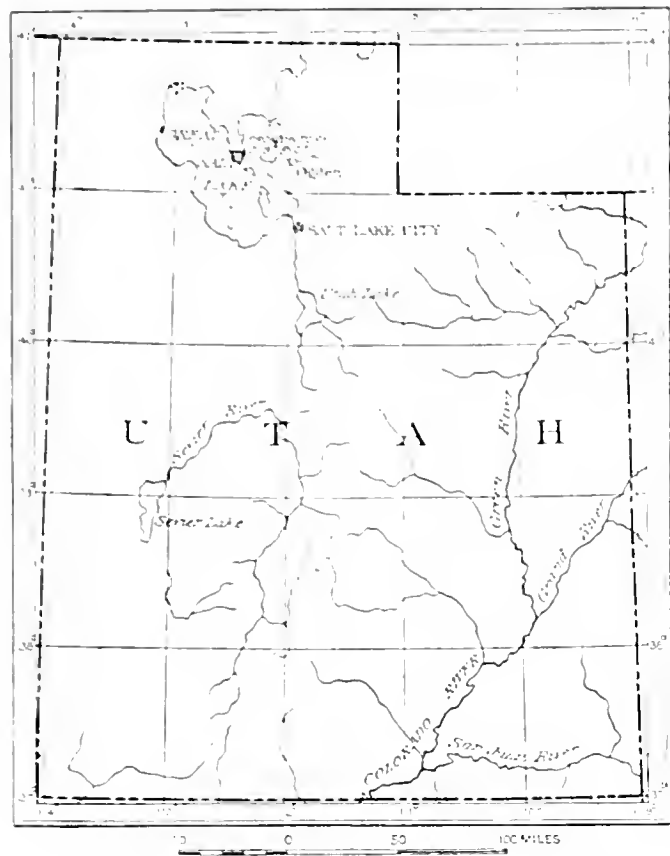

MAP OF UTAH, SHOWING THE PROMONTORY ZINC DISTRICT.

average 32.75% zinc and 7.7% lead. Some copper occurs in the district, near Great Salt Lake. The ore is disseminated in quartzite.

SUMMIT COUNTY

To lease the American Flag mine below 1000 ft., the Park City Mines Co. has been organized. The Mines Development Co. has the mine from 1900 ft. to the surface.

WASHINGTON

SIEMENS COUNTY

The United Copper Co. at Chewelah is making regular shipments of copper ore and concentrate to Trail, B. C. The crude ore assays 4.38% copper and 11.4 oz. silver, while the concentrate contains up to 12.24% copper and 31.9 oz. silver. The profit in April is estimated at \$25,000, while May should give nearly \$40,000. The debt has been reduced to \$71,954.

CANADA

BRITISH COLUMBIA

The first unit of the Consolidated Mining & Smelting Co. of Canada electrolytic zinc refining plant at Trail, is in commission, and the remaining eight units are being installed as rapidly as possible. They probably will be in service in the next fortnight. The complete plant cost about \$1,000,000. An

electrolytic copper refinery to cost as much will be erected soon.

G. H. Short and W. B. Montgomery of the Grasselli Chemical Co. have been touring the province in search of zinc mines.

Four blast-furnaces at the Anyox plant of the Granby Consolidated are treating at the rate of 80,000 tons of ore monthly. The town of Anyox has a population of 1600 people. The Alice Arm district, at the head of a branch of Observatory Inlet, is attracting attention, there being 300 people, according to W. A. Williams of the Granby company. Goldfield Consolidated people have found high-grade silver-lead ore in the Dolly Varden mine by diamond-drilling. The town at the end of Alice Arm has a good hotel, stores, etc.

At its Hidden Creek property the Granby Consolidated is to construct an auxiliary hydroelectric plant of over 7000 horse-power.

Mining is being revived in the region tributary to Nelson, and several important deals have been closed recently according to a letter received by the Northwestern Mining News Service of Spokane from Fred A. Starkey of Nelson. A Victoria syndicate has taken a \$75,000 bond on the Eureka group of copper-gold-silver claims on Eagle creek, a few miles west of Nelson, and a company is being organized to equip the holdings and operate them.

New interests have acquired the Vancouver gold claims, adjoining the Queen holdings in the Sheep Creek district, and extensive development already is under way. The bond is for \$15,000, and the first payment of \$5000 has been made. The Golden Fawn group, another Sheep Creek gold property, has been taken under bond by a Spokane syndicate for a reported price of \$100,000. The California group of free-milling gold properties on the mountain overlooking Nelson has been secured by a local syndicate.

The Hudson Bay zinc mine near Salmo has been taken under control from M. W. Bacon and W. E. Cullen by Hayden, Stone & Co. of New York, for \$2.50 a share. Lead ore was mined from the upper workings, while zinc carbonate has been developed to a large extent. Reserves are said to be 200,000 tons.

To haul ore from the Hudson Bay zinc mine near Salmo, a distance of 7 miles, caterpillar-tractors are to be used. The daily output is 100 tons. A lower adit is in 385 ft., to cut the vein at a depth of 1750 ft. This will be completed in August.

ONTARIO

During the first quarter of 1916 the McIntyre company at Porcupine treated 27,248 tons of \$7.74 ore, at a cost of \$3.85 per ton. The recovery was 95.4%.

At Cobalt the Beaver and Temiskaming shafts, being sunk to the contact with the Keewatin formation, are down 1500 and 1100 ft. respectively.

KOREA

The March clean-up of the Oriental Consolidated was worth \$136,255.

On April 6 the Oriental Consolidated company paid a dividend of 50c. a share. The January output was \$144,932 from 26,806 tons of ore. Recovery in the Taracol cyanide plant was 90%, at the Mailhong tube-mill 96%; both are giving excellent results.

MEXICO

At the annual meeting of the Exploration Company in London, the chairman, R. T. Bayliss, made the following statement concerning that well-known British company's operations in Mexico:

"As the disturbed condition of Mexico is the fundamental cause of all our trouble, I should like to give a short account of the conditions which have prevailed, and still prevail, in that unhappy country. Internecine strife has raged throughout the country for the past three years, and if it is not today so violent as it has been, it is not because the spirit of the

people is unwilling, but in consequence of the physical and economic exhaustion of the country. Throughout this period all our operations and those of our subsidiary companies have been hampered and hindered to a point which rendered anything in the nature of regular or profitable work impossible. The Santa Rosa company was compelled to shut-down three years ago, and nothing has been done upon the property since. The El Oro mine had to suspend operations for several months during 1914. It re-started, under compulsion, in September of that year, but had again to cease work in February, 1915, and has remained closed ever since. The Buena Tierra mine, although able to work intermittently during a portion of 1915, was unable to do so at a profit, and was compelled to suspend entirely in September last and is still idle. The Exploration Company of England and Mexico, which at the commencement of hostilities was developing into a prosperous undertaking, has not been able to do any business at all, and, in fact, practically one-third of our capital has been unproductive and in jeopardy during this period. This is a sorry tale to tell but I put the facts so in order that shareholders may realize that our present position is due to circumstances which we could not foresee and were powerless to control. For some weeks past fighting, except in a detached and undisciplined form, has for the moment practically come to an end. To this extent the position may now be said to be a little more definite, but it can hardly be described as improved. The economic and financial position of the Republic remains as bad as it can be. The treasury is bankrupt; gold and silver coinage has disappeared; the country is flooded with a fiat paper money which is not current in all parts of the Republic, and not at all beyond its borders. There is not any quotable international exchange, the rate on London having fallen nominally to 1½d (3c.) on the peso, compared with the parity of 2s 1d (50c.) and in consequence the business and industrial position in Mexico generally is in a state of chaos and disorder. In addition to all this, pestilence and famine have prevailed in Mexico City and outlying districts for some time. Even on the assumption, therefore, that no further revolutions interfere with the reorganization of industrial conditions, a long time must necessarily elapse before we return to conditions similar to those which prevailed during the effective administration of the late president Diaz, and at the moment I feel quite unable to make any forecast as to when our properties will be able to resume operations or the conditions that will be imposed upon us when they do."

SONORA

Every idle mine in this State must be re-opened by May 1 or pay a heavy tax to the Government, is the decree of the governor, P. Elias Calles. The rich silver mine near Arizpe, Las Chispas, would be fined \$10,000 a month for two months if it remained closed, then the State would operate it for the benefit of employees. No property is to be confiscated. The case of Las Chispas is considered to be particularly flagrant, as the governor considers that large shareholders are trying to squeeze out smaller holders.

The recent addition of a thoroughly equipped microscopical laboratory for metallurgical research at the Salt Lake City station of the U. S. Bureau of Mines in connection with the co-operative work that is now being carried on between the Department of Metallurgical Research of the University of Utah and the Federal Bureau of Mines, gives Salt Lake City the best equipped microscopical laboratory for metallurgical research in the United States.

The U. S. Civil Service Commission at Washington, D. C., announces an open competitive examination for physical metallurgist on June 7. From the register of eligibles resulting from this examination certification will be made to fill a vacancy in this position in the Navy Yard, Boston, at a salary ranging from \$6 to \$8 per day.

PERSONAL

Note: The Editor invites members of the profession to send him particulars of their work and appointments. This information is of unquestioned interest to our readers.

L. D. RICKETTS was married on April 26.

D'ARCY WEATHERS has returned to London.

R. S. BORSFORD is in the Bodaibo district of Siberia.

A. E. BRUCKER has returned to New York from Panama and Jamaica.

ALEXANDER McLEOD has been examining prospects in western Nova Scotia.

G. L. SHELTON of Ely, Nevada, has been in Washington county, Idaho.

ERNEST A. HAGGOTT has returned to San Francisco from Central America.

R. G. WAYLAND, superintendent of the Alaska Treadwell, is here from Treadwell.

C. E. KENNEY passed through San Francisco last week on his way to Los Angeles.

ARTHUR PECKHAM is assayer at the Dutch-Sweeney mine, in Tuolumne county, California.

C. T. DURELL passed through San Francisco on his return from Montana to Los Angeles.

FREDERICK HELLMAN, general manager of the Chuquicamata mine, of the Chile Copper Co., is here.

S. S. JONES has resigned as superintendent for the Tom Reed Gold Mines Company, at Oatman, Arizona.

C. T. GRISWOLD of the Associated Geological Engineers has returned to Pittsburg from south-western Montana.

BURKELEY WELLS and WILLIAM J. COX have been delegated to represent Colorado mining men in a protest against mining-law reform now before Congress.

W. H. McKENNA is assisting his brother, J. A. McKENNA, manager of the Vasco Mining Co. at Boulder, Colorado, in the purchasing and sales departments.

As we go to press, we are informed that R. T. BAYLISS, chairman and managing director of the Exploration Company, and of other important mining companies, such as the El Oro Mining & Railway Co., was struck by a bomb from a zeppelin on Friday, the 28th ult., in England. An arm had to be amputated and he is in a serious condition. Mr. Bayliss has many friends in this country, for he lived in Montana for several years and his honorable connection with American mining extends over thirty years, therefore this is bad news to many of our readers, as it is to us. We hope still, however, that his life may be saved by skillful nursing.

Schools and Societies

The School of Mines and Metallurgy, UNIVERSITY OF MISSOURI, at Rolla, has issued its Catalogue for 1915-'16. In the 149 pages are details of all pertaining to this institution.

The MASSACHUSETTS INSTITUTE OF TECHNOLOGY will dedicate its new buildings, and commemorate the 50th anniversary of its foundation, on June 12, 13, and 14. The colleges are on the Cambridge bank of the Charles River basin, near Boston. Many festivities are planned, and 11,000 old students and undergraduates are expected.

Thirty students and instructors from the College of Mines, UNIVERSITY OF WASHINGTON, took part in the annual spring excursion early in April. Studies were made of the new reverberatory and casting furnaces at the Tacoma smelter, the Du Pont powder works on Puget Sound, and the Britannia Mining & Smelting Co.'s mine and mills on Howe sound, near Vancouver, British Columbia. The Britannia mills are using Hancock jigs, Butchart tables and Minerals Separation flotation cells to get a high recovery on low-grade chalcopyrite ore.

THE METAL MARKET

METAL PRICES

San Francisco, May 2

| | |
|--|-----------|
| Antimony, cents per pound | 42 |
| Electrolytic copper, cents per pound | 51 |
| Pig lead, cents per pound | 8.00-8.80 |
| Platinum, soft metal, per ounce | \$85 |
| Platinum, hard metal, 10% iridium, per ounce | \$89 |
| Quick silver, per flask of 75 lb. | \$115 |
| Spelter, cents per pound | 22 |
| Tin, cents per pound | 50 |
| Zinc-dust, cents per pound | 30 |

ORE PRICES

San Francisco, May 2

| | |
|--|-------------|
| Antimony, 50% product, per unit, of 17, or 20 lb. | \$2.25 |
| Chrome, 40% and over, for bars California, per ton | 12.50 |
| Manganese, 50% metal, 8% silica, per ton | 12.00 |
| Pig iron, 60% W.C., per unit of 20 lb. | 60.00-65.00 |

Those interested in manganese should secure a copy of 'Manganese Ores of Brazil, Chile, India, and Russia,' a paper prepared by F. C. Harder for the Arizona meeting of the A. I. M. E. In these pages is much valuable information.

New York, April 26.

Antimony continues in demand, and for ore about \$2.75 per unit has been paid. It continues difficult to obtain account of great scarcity for shipments from South America.

EASTERN METAL MARKET

(By wire from New York.)

May 2 - Copper is quieter but strong, lead is dull with an eastern tone, spelter is quiet though staidier.

SILVER

Below are given the average New York quotations, in cents per ounce, of fine silver.

| Date | Average week ending | | |
|-------------|---------------------|--------|-------|
| Apr. 26 | 67.12 | Me. 21 | 67.10 |
| " 27 | 66.00 | " 28 | 66.66 |
| " 28 | 71.37 | Apr. 4 | 61.04 |
| " 29 | 70.20 | " 11 | 61.91 |
| " 30 Sunday | 70.20 | " 18 | 63.42 |
| May 1 | 72.87 | " 25 | 65.52 |
| " 2 | 74.87 | May 2 | 71.45 |

Monthly averages.

| | 1914. | 1915. | 1916. | | 1914. | 1915. | 1916. |
|------|-------|-------|-------|-------|-------|-------|-------|
| Jan. | 57.58 | 48.85 | 56.76 | July | 54.90 | 47.52 | |
| Feb. | 57.52 | 48.45 | 56.74 | Aug. | 54.35 | 47.11 | |
| Me. | 58.91 | 50.51 | 57.89 | Sept. | 52.75 | 48.77 | |
| Apr. | 57.2 | 50.2 | 61.37 | Oct. | 51.12 | 49.40 | |
| May | 58.21 | 49.87 | | Nov. | 49.12 | 51.88 | |
| June | 56.43 | 45.03 | | Dec. | 49.27 | 55.34 | |

Silver is advancing with great strides. London quotes 26 1/2 for the highest since December 1892. Stocks in London, April 27 were 1,750,000 oz., since when 1,300,000 oz. arrived from New York. This metal is earmarked for definite purposes and is not available for resale. Supplies arrive slowly and when they do they are cleared off the market at each upward movement in price. Europe is a considerable buyer. Exports to India, April 27, were £478,000, against £1,644,500 in that period of 1915, a decrease of over 70 per cent.

COPPER

Prices of electrolytic in New York, in cents per pound.

| Date | Average week ending | | |
|-------------|---------------------|--------|-------|
| Apr. 26 | 27 | Me. 21 | 26.45 |
| " 27 | 27.5 | " 28 | 26.79 |
| " 28 | 27.5 | Apr. 4 | 26.57 |
| " 29 | 27 | " 11 | 27.50 |
| " 30 Sunday | 27 | " 18 | 28.25 |
| May 1 | 28 | " 25 | 28.50 |
| " 2 | 29 | May 2 | 28.75 |

Monthly averages.

| | 1914. | 1915. | 1916. | | 1914. | 1915. | 1916. |
|------|-------|-------|-------|-------|-------|-------|-------|
| Jan. | 14.21 | 12.89 | 24.20 | July | 13.26 | 19.09 | |
| Feb. | 14.48 | 14.78 | 28.82 | Aug. | 12.34 | 17.27 | |
| Me. | 14.11 | 14.89 | 26.67 | Sept. | 12.62 | 17.89 | |
| Apr. | 14.39 | 16.84 | 18.02 | Oct. | 11.10 | 17.90 | |
| May | 13.87 | 18.71 | | Nov. | 11.75 | 18.88 | |
| June | 13.60 | 19.75 | | Dec. | 12.75 | 20.67 | |

Butte copper companies have raised miners' and smeltermen's wages to \$4.50 per day, an increase of 25%. This will be

effective while copper is 25c per pound or over. The monthly pay rolls of the district now total \$2,160,000 for 20,000 men.

Greene Consolidated is paying \$1 per share, an increase of 50 cents.

Kenecott (Alaska property only) produced 63,000,000 lb. of copper in 7 months ended December 31, 1915. The cost was 4.54c per pound. The ore averaged 60.11%. On March 31, \$1 per share was paid, equal to \$2,780,583. After this was distributed, cash, cash assets, and copper were worth \$17,000,000.

LEAD

Lead is quoted in cents per pound, New York delivery

| Date | | Average week ending | |
|-------------|------|---------------------|------|
| Apr. 26 | 7.50 | Me. 21 | 7.12 |
| " 27 | 7.50 | " 28 | 7.96 |
| " 28 | 7.50 | Apr. 4 | 7.91 |
| " 29 | 7.50 | " 11 | 7.79 |
| " 30 Sunday | 7.50 | " 18 | 7.75 |
| May 1 | 7.50 | " 25 | 7.56 |
| " 2 | 7.50 | May 2 | 7.50 |

Monthly averages.

| | 1914. | 1915. | 1916. | | 1914. | 1915. | 1916. |
|------|-------|-------|-------|-------|-------|-------|-------|
| Jan. | 4.11 | 3.73 | 5.95 | July | 3.80 | 5.59 | |
| Feb. | 4.62 | 3.83 | 6.23 | Aug. | 3.86 | 4.67 | |
| Me. | 3.94 | 4.01 | 7.26 | Sept. | 3.82 | 4.62 | |
| Apr. | 3.86 | 4.21 | 7.76 | Oct. | 3.60 | 4.62 | |
| May | 3.90 | 4.24 | | Nov. | 3.68 | 5.15 | |
| June | 3.90 | 5.75 | | Dec. | 3.80 | 5.34 | |

The Bunker Hill & Sullivan company distributed two dividends of \$81,750 each on May 4.

QUICKSILVER

The primary market for quicksilver is San Francisco, California being the largest producer. The price is fixed in the open market, according to quantity. Prices, in dollars per flask of 75 pounds:

| Date | Week ending | | |
|--------|-------------|---------|-----|
| Apr. 4 | 180 | Apr. 18 | 136 |
| " 11 | 152 | " 25 | 125 |
| | | May 2 | 115 |

Monthly averages.

| | 1914. | 1915. | 1916. | | 1914. | 1915. | 1916. |
|------|-------|-------|--------|-------|-------|--------|-------|
| Jan. | 39.25 | 51.90 | 222.00 | July | 37.50 | 95.00 | |
| Feb. | 39.00 | 60.00 | 295.00 | Aug. | 80.00 | 93.75 | |
| Me. | 39.00 | 78.00 | 219.00 | Sept. | 76.25 | 91.00 | |
| Apr. | 38.90 | 77.50 | 111.60 | Oct. | 53.00 | 92.90 | |
| May | 39.00 | 75.00 | | Nov. | 55.00 | 101.50 | |
| June | 38.60 | 90.00 | | Dec. | 53.10 | 123.00 | |

In San Francisco, on April 28, a public sale was held to dispose of 192 flasks of quicksilver. Among the 25 persons present, well-known dealers were represented, but the metal was bought-in by the owner, John McNear, at \$105 each for 85 flasks, and \$100 for the remainder, he being the only bidder. The proceedings had an appearance of unreality. The market is mysterious and the obvious victim of manipulation.

ZINC

Zinc is quoted as spelter, standard Western brands, New York delivery, in cents per pound.

| Date | Average week ending | | |
|-------------|---------------------|--------|-------|
| Apr. 26 | 18.25 | Me. 21 | 17.83 |
| " 27 | 18.25 | " 28 | 17.79 |
| " 28 | 18.00 | Apr. 4 | 17.75 |
| " 29 | 17.75 | " 11 | 18.48 |
| " 30 Sunday | 17.75 | " 18 | 19.21 |
| May 1 | 17.75 | " 25 | 18.83 |
| " 2 | 17.50 | May 2 | 17.92 |

Monthly averages.

| | 1914. | 1915. | 1916. | | 1914. | 1915. | 1916. |
|------|-------|-------|-------|-------|-------|-------|-------|
| Jan. | 5.14 | 6.20 | 18.21 | July | 4.75 | 20.54 | |
| Feb. | 5.22 | 9.05 | 19.99 | Aug. | 4.75 | 14.17 | |
| Me. | 5.12 | 8.40 | 18.40 | Sept. | 5.16 | 14.14 | |
| Apr. | 4.98 | 9.78 | 18.62 | Oct. | 4.75 | 14.05 | |
| May | 4.91 | 17.03 | | Nov. | 5.01 | 17.20 | |
| June | 4.84 | 22.20 | | Dec. | 5.40 | 16.75 | |

TIN

Prices in New York, in cents per pound.

| Monthly averages. | | | | | | | |
|-------------------|-------|-------|-------|-------|-------|-------|-------|
| | 1914. | 1915. | 1916. | | 1914. | 1915. | 1916. |
| Jan. | 37.85 | 34.40 | 41.76 | July | 31.60 | 37.33 | |
| Feb. | 39.76 | 37.23 | 42.60 | Aug. | 50.20 | 34.37 | |
| Me. | 38.10 | 48.76 | 50.50 | Sept. | 33.10 | 33.12 | |
| Apr. | 36.10 | 18.25 | 51.15 | Oct. | 30.40 | 33.00 | |
| May | 32.29 | 39.38 | | Nov. | 33.51 | 39.50 | |
| June | 30.72 | 40.26 | | Dec. | 32.60 | 38.71 | |

Eastern Metal Market

New York, April 26.

In marked contrast with recent weeks, the market is now quiet. Copper is the most active of the metals, but the big buyers are no longer eager to buy. Lead and zinc are positively dull. Copper prices have been maintained, but those of every other metal have declined. In seeking an explanation of the sudden dullness, the trade is pointing to the German-American complications, saying that business is not likely to revive until the proposals of the Administration seem clear again. But the best explanation is that there has been heavy buying of all the metals, and consumers cannot be expected to go on buying full tilt continuously. They must have an opportunity to digest their purchases. So far as the week is concerned, the Easter holiday—from Thursday to the following Tuesday—which was observed more particularly in London, made the market quiet on those days. In spelter an adverse influence has been exerted by the report of the U. S. Geological Survey, futures being most affected.

General trade conditions in the metal-working lines continue good, with the exception of an increasing number of strikes which are to be found in half a dozen States. The National Conduit & Cable Co., Hastings-on-Hudson, N. Y., which is a large user of copper, is grappling with a bitter strike, to handle which four companies of militia have been called out. It is feared that with the approach of May 1 strikes will become more general.

COPPER

Quotations continue strong, but the market has turned quiet to the point of dullness. In the past few days there have been offerings of spot electrolytic at 30.50c., full terms, but no acceptances. Re-sale metal has appeared in considerable quantity, and the story goes that some of it was bought on speculation by German interests. This, however, lacks confirmation. April and May deliveries of electrolytic have been offered at 30c., also without results. August and later deliveries of electrolytic are held at about 28.50c. cash, New York, but buyers are not interested. Lake for forward delivery is nominal at 28.75c., while up to 31c., is quoted for nearby positions. The dullness may be temporary, but on the whole it looks as if the market is in for a rest and eventually for lower prices. It is not to be expected that the heavy buying of a week or ten days ago could be long maintained. Exports from April 1 to 25 totaled 18,780 tons, but there are also to be considered the vast quantities which are going abroad in the form of munitions. The London market continues strong, the quotation yesterday being £140. Since the heavy buying subsided, reports have continued to appear in the daily press of the great business which, they assert, is still being done; but the trade figures that these stories originate in Wall Street and are founded on a desire to boom the stocks of the copper-producing companies. As a matter of fact these stocks have lagged far behind in proportion to the advanced prices of copper metal—just why is not clear.

ZINC

Though the spelter interests have held that the recent report of the U. S. Geological Survey did not constitute a bear argument, the report has nevertheless had the effect of making the market very dull. Futures in particular are very near unsalable, in view of the great prospective production which is predicted. Prompt zinc has dropped to 18.25c., New York, and 18c., St. Louis. The St. Louis minimum for May delivery is about 17.37½c.; for June, 16.75c., and for third quarter, 15.50c. Exports from April 1 to 25 totaled 2111 tons. The London market is unchanged at £103. The domestic situation can be summed up with the statement that it is

weak and interesting. It has not been helped by efforts which a few consumers and speculators have made to sell. Sheet-zinc is quoted at 25.50c., carload lots, f.o.b. mill, 25% off for cash.

LEAD

The bottom appears to have dropped out of the lead market. Both foreign and domestic buyers are conspicuous only by their absence, and prices have declined. The New York quotation of the A. S. & R. Co., and those of the Independents are now on the same level, 7.50c. At St. Louis the Independents are quoting 7.37½c., although the leading producer adheres to 7.42½c. There is some pressure to sell. Some sellers are looking for business, but they are meeting with little success. The foreign demand is especially slow. It has been predicted that prices would decline if the foreign demand did not hold up. Last week a fairly round lot of Mexican lead that recently came over the border was offered in this market, but the best bid received for some time was 6c., in bond, New York. Later a better price was offered, and a part of the lead was disposed of. Consumers are well supplied and under the circumstances ask why they should bid any price. Exports from April 1 to 25 totaled 1270 tons. The London quotation yesterday was £34.

TIN

The week has been a quiet one. On no day was there any business of consequence until yesterday when two consumers came in the market, each wanting 100 tons. As a result, at least 200 tons was taken, all for future delivery. The obtaining of licenses to ship from London continues an uncertain matter. At the same time arrivals have been fairly large of late, and this fact, together with the lack of demand has caused quotations to decline. The quotation for spot yesterday was 49.75c. The consumption of tin in this country is great. Sales of tin-plate have been made at \$5 per base box, at mill. Some good-sized foreign contracts have been hooked at that figure. The specifications against contracts for tin-plate received by the American Sheet & Tin Plate Co. last week were the heaviest in its history. The arrivals of tin from April 1 to 25 totaled 2635 tons, and there was afloat on the latter date, 5014 tons.

ANTIMONY

The market has been quiet, and under the influence of pressure to sell, quotations have declined until 39.50c., duty paid, can be done for spot Chinese and Japanese grades.

ALUMINUM

No. 1 virgin aluminum, 98 to 99% pure, is quiet and slightly easier at 58 to 60c. per pound.

TUNGSTEN

A New York broker (Charles Hardy, 50 Church street) reported on April 25 as follows: Quotations for tungsten have experienced a heavy break during the past week. Most of the consumers have contracted for their immediate requirements and are holding off for future deliveries. The increased activity in this country and South America stimulated by the high prices, begins to show now in heavy arrivals from all quarters; and though Portugal is practically eliminated for the time being as an exporter, still enough is reaching this port. Holders of spot tungsten were most affected by the decline. Actual sales have been made for immediate delivery at \$70 per unit, with buyers now below that figure. Forward tungsten is almost unsalable except at a huge discount. The break in tungsten, however, has had the effect of eliminating a good many speculators. Sellers will probably have to take a lower price in the future.

COMPANY REPORTS

CHINO COPPER CO.

The area of this company's property at Santa Rita, New Mexico was increased by 6 mining claims in 1915, making 153, equal to 2731 acres. Millsites, water-rights, etc., cover 18,568 acres more. Churn-drilling totaled 6909 ft., making 214,142 to date. This work will be continued when deemed desirable. Reserves remain at 90,000,000 tons of 1.55% ore. Overburden removed amounted to 3,133,916 cu. yd. The cost of steam shovel mining this material and ore, 2,600,271 tons, was 35.28c. per ton. Mining the ore was 19.47c. The mill was at full capacity in April, and treated a total of 2,379,800 tons,

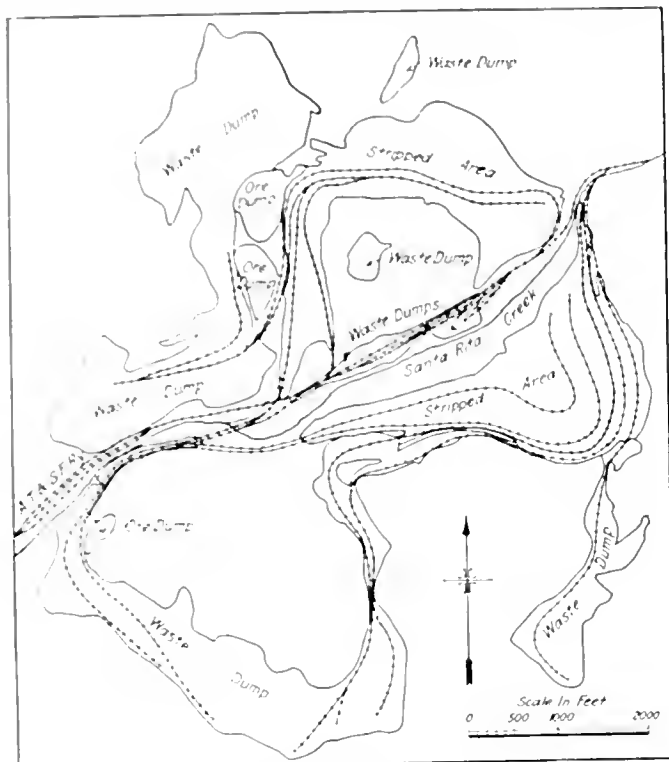

OREBODIES AND DUMPS AT THE CHINO MINE.

equal to 1394 tons per mill-unit (5) per day. The ore averaged 2.155% copper; 158,444 tons of 21.551% concentrate was produced; the recovery was 66.588%; and the cost was 54.19c. per ton. The yield of metal was 68,293,893 lb., produced at a cost of 7.12c. per pound, against an average of 17.42c. received. The year's revenue was \$11,383,777; net profit, \$6,913,984; dividends paid, \$2,609,860; net surplus, \$4,046,859; and total surplus, \$8,613,261. The general manager is John M. Sully; superintendent of mines, Horace Moses; consulting engineer of mines, R. G. Gemmill; superintendent of mills, W. H. Janney; manager of mills, F. G. Janney; and cashier, George L. Webster.

MIAMI COPPER CO.

Accompanied by large photographs of its property the report of this Arizona company for 1915 is of value. The general manager, R. Britton Gotsberger, made the following remarks, in part:

Operations were curtailed in the first quarter, but by June the monthly output was 4,000,000 lb. of metal. Mine development covered 21,746 ft., 10,787 ft. being preparatory work in the Captain orebody, which is now supplying ore, over 2,000,000 tons being available so far. Shrinkage stoping is in vogue there. In the eastern part of the mine, which is of higher

grade, top-slicing is the system practised, and this is to be done at the 570-ft. level. Mining 1,353,122 tons cost \$1.01 per ton, a reduction of 17c. Reserves are 35,140,000 tons averaging 1.82% copper, also 6,000,000 tons of 2% ore.

The mill treated 1,348,122 tons of 2.17% ore, with 75.17% extraction (an increase of 5.24%), at a cost of 57.94c. per ton. There was 52,539 tons of 41.91% concentrate produced. Several improvements were made to the mill, and experiments are being continued.

The refined copper produced was 41,822,059 lb., at a total cost of 8.76c. per pound, against 17.33c. received. The operating cost was \$1.8785 per ton of ore. The revenue was \$7,262,884, of which \$3,589,680 was profit. Dividends absorbed \$1,681,004. The year commenced with a balance of \$1,117,788 and ended with \$3,175,346.

The assistant manager (in charge of mining) is F. W. MacLennan; mill superintendent, P. W. Solomon; and assistant at the mill, Ralph B. Yerxa.

NEVADA CONSOLIDATED COPPER CO.

Recoverable developed ore in this company's property was estimated at 50,525,289 tons, averaging 1.652% copper, at the end of 1915, an increase of 9,504,993 tons, although the previous total contained 0.028% more metal. Churn-drill prospecting amounted to 17,779 ft., in the Ruth, Eureka, Liberty, and Hecla mines. The total to date is 124,316 ft. Stripping removed 2,758,350 cu. yd. of capping, at a cost of 28.87c. per yard, a reduction of 2.84c. The charge for steam-shovel mining was 15.24c. per ton.

The mill treated 3,081,520 tons of ore, averaging 1.54% metal, with 70.18% extraction. At the smelter there was reduced 573,873 tons of material in the reverberatories, 318,377 tons coming from the roasting plant. The converters yielded 62,520,855 lb. of company metal, and 1,785,011 lb. from custom ore, at much lower cost. The price received for copper was 17.647c. per pound, and the cost was 8.67 cents.

Revenue from metals (gold and silver, \$615,606) was \$11,685,277. The operating profit was \$5,140,683, plus \$764,918 from miscellaneous sources, a total of \$5,905,602. Dividends (4) amounted to \$2,999,185. The year ended with a balance of \$1,849,556, against \$2,290,626 in 1914.

The staff is as follows: general manager, C. B. Lakenan; general mine superintendent, Robert Marsh, Jr.; shovel-pit superintendent, E. E. Vanderhoef; underground mine superintendent, W. S. Larsh; smelter superintendent, R. E. H. Pomeroy; concentrator superintendent, George C. Riser; business manager, C. V. Jenkins, and consulting engineer, Pope Yeatman.

RAY CONSOLIDATED COPPER CO.

The 1915 report of this Arizona company is brief and concise. No development was done to prove additional ore, but underground work necessary for mining amounted to 45,292 ft., a decrease of 15,323 ft. Reserves are estimated at 71,911,475 tons of 2.235% ore. Other ore beside this will be opened later on. There was extracted 2,854,314 tons, 96% of which was from reserve drawing, 6% from stoping, and 4% from development, at a cost of 58.97c. per ton. Broken ore amounts to 3,000,000 tons. Coarse crushing cost 3.71c. per ton.

The mill treated 2,848,969 tons of 1.673% ore with 64.11% recovery, at a cost of 50.86c. per ton. From concentrate and some ore smelted direct the yield was 61,114,514 lb., against 58,020,955 lb. in 1914. The cost of producing metal was 9.423c. per pound, and the average received was 17.352 cents.

Income from metals totaled \$10,498,962, of which \$4,373,371 was profit. Adding sundry revenue and deducting interest, the net profit was \$4,589,143. Dividends paid were \$1,872,319. The surplus is \$6,434,704, against \$3,776,368 at the beginning of the period.

Operating officials are L. S. Cates, general manager, W. S. Boyd at the mine, D. D. Moffat at the mill, and R. I. Ezell cashier. The consulting engineer is R. C. Gemmell, and manager of mill F. G. Janney.

UTAH COPPER CO.

During 1915 this company treated 8,494,300 tons of 1.434% ore at a cost of \$6.24c. per ton for steam-shovel mining, railroad transport (26 miles), and milling. The metal yield was 156,207,376 lb. In 1914 the tonnage was 6,470,166, costing 95.5c. per ton, producing 121,779,401 lb. of copper. The revenue from 148,397,006 lb. copper at 17.679c. per lb., 36,760 oz. gold, and 371,712 oz. silver amounted to \$27,155,944. The operating profit was \$15,023,834, plus \$2,896,609 from investments, etc. Dividends amounted to \$6,904,083. The balance from 1914 was \$13,035,409, while that carried forward to 1916 was \$23,498,074. Metals on hand and in transit are valued at \$8,675,199, supplies on hand \$736,022, and cash \$3,160,245. Current liabilities total \$2,115,443. The cost of producing copper was 7.48c. per pound.

Development at the mine consisted of 1365 ft. of churn-drilling. The average calculated thickness of the orebody was increased from 465 to 480 ft. Reserves are 346,315,300 tons of 1.446% ore. This is an increase of 3,815,300 tons above the quantity mined, namely, 8,494,300 tons. Overburden removed was 5,961,367 cu. yd. All ore was extracted by steam-shovel, and the cost of mining was 24.41c. per ton, including 7.5c. for stripping, and 0.3c. for development, a good decrease compared with the charge in 1914.

The Arthur and Magna mills treated 3,261,000 and 5,233,300 tons respectively of 1.434% ore, with 64.13% extraction, and a cost of 34.02c. per ton, a small decrease. Low recovery was due to crowding the capacity and the copper carbonate interfering.

The Bingham & Garfield railway, between the mine and smelter at Garfield, carried 19,382 tons of freight daily also 97,304 passengers during the year.

Operating officials are as follows: general manager, Robert C. Gemmell; superintendent of mines, J. D. Shilling; chief engineer of mines, H. C. Goodrich; general superintendent of mills, F. G. Janney, Jr.; in charge of Arthur and Magna mills, T. A. Janney and H. C. Smith; assistant secretary, John M. Hayes; and assistant purchasing agent, C. F. Jennings.

AMERICAN ZINC, LEAD & SMELTING CO.

At the beginning of 1915 this company, with its mines and mills in Missouri, Tennessee, and Wisconsin, and smelters in Kansas, had notes payable of \$1,130,000 and a bonded debt of \$549,000. The notes were paid off, the bonds converted into stock, and a net deficit in quick assets of \$643,452 changed to a net surplus of quick assets of \$3,668,707. This is the result of the higher prices for zinc. The total profit was \$5,293,878. The balance carried to surplus was \$2,651,501. It is found necessary to use this in the business, so that cash dividends cannot be paid just yet, but it is proposed to issue one-third of the authorized capital as preferred shares, to be entitled to a cumulative dividend of \$6 per share per annum, etc.

During the year the Mascot mine's capacity was increased from 1200 to 2200 tons per day. A 700-ton mill was erected at the Roseberry near by. New kilns and zinc furnaces were built at Caney, Dearing, and Hillsboro. At Joplin all the properties were worked. A large roasting and magnetic plant was constructed in Wisconsin. Nearly 8000 tons of Butte & Superior concentrate is reduced each month.

BUTTE & SUPERIOR COPPER CO.

If the shareholders of this zinc-producing company approve, the word 'copper' is to be deleted and 'mining' inserted in the name. The past year's operations were interesting from the great profits made, and the litigation with the Elm Orlu Min-

ing Co. over certain orebodies. Zinc concentrate is treated by the American Zinc, Lead & Smelting Co., the American Metal Co., the U. S. Steel Corporation, and the U. S. Smelting Co. In the case of the A. Z. L. & S. Co. and the U. S. S. Co., the spelter produced is returned to the Butte & Superior, which sells its own metal. Spelter averaged 13.054c. per pound at East St. Louis, against 5.08c. in 1914. June 1915 averaged 21c.

The past two years' results compare as follows:

| | | |
|---|--------------|-------------|
| Income from zinc and lead concentrate | | |
| and residues | \$13,244,133 | \$4,037,674 |
| Less freight | 1,157,016 | 799,260 |
| | \$12,087,117 | \$3,238,414 |
| Operating charges | 3,012,965 | 1,845,502 |
| Net profit (with sundries)..... | \$ 9,125,947 | \$1,417,128 |
| Balance from 1914 | 2,020,133 | |
| Total available | \$11,146,080 | |
| Dividends paid (four of 75c. each and \$14 extras) | 4,908,115 | |
| Balance for 1916 | \$ 6,237,965 | |

Shipments in transit are valued at \$2,908,802 and cash on hand \$2,128,187. Current liabilities total \$606,317.

During 1915 the main shaft was sunk to 1900 ft., preparatory to opening the Black Rock orebodies at 1700 and 1800 ft., and opening the 1600-ft. level for ore extraction. The last mentioned is opened for 700 ft., with excellent results. Reserves are practically the same as in 1914, namely, 1,000,000 tons. There was mined 522,949 tons of ore at a cost of \$3.36 per ton.

The mill treated 522,300 tons of ore, averaging 17.02% zinc and 7.63 oz. silver at a cost of \$1.75 per ton, details of which were given in this journal of April 29.

The staff at Butte consists of J. L. Bruce, manager; F. G. Janney, manager of mill; J. T. Shimmin, mill superintendent; Angus McLeod, mine superintendent; and Charles Bocking, cashier.

CALUMET & ARIZONA MINING CO.

During 1915, this company, which owns 2000 acres in Co-chise county, Arizona, absorbed entirely the Superior & Pittsburg Copper Co., which it controlled, resulting in no duplication of work and less taxes. The C. & A. also controls the New Cornelia Copper Co., which is developing and erecting a mill at the great mine at Ajo, Pima county; also the Tucson, Cornelia & Gila Bend Railroad Co., whose new line commenced service to the new mine on February 20, 1916. The year 1915 commenced at 50% capacity for the C. & A., but prospects for 1916 are the best reported. Four dividends amounted to \$2,006,557. Total income was \$11,683,724, and net \$5,453,882. Assets at December 31, 1915, included accounts receivable, \$577,749; supplies, \$334,274; cash, \$2,561,931; and metals in process, \$3,688,841. Liabilities included accounts payable, \$224,548.

The general manager, J. C. Greenway, reported that development totaled 93,788 ft., an increase of 20,995 ft. Diamond-drilling amounted to 8975 ft. Water pumped was 1,927,516,900 gal., or 3667 gal. per minute, of which 1860 gal. came from the 1800-ft. level. Air made totaled 2,528,590,800 cu. ft. Results at the Junction and Briggs shafts were encouraging, especially at 1300 ft. in the former. A safety department was organized in April.

The smelter reduced 664,152 tons of company and 159,250 tons of custom ore. Two blast-furnaces treated 461,383 tons, and three reverberatories 333,541 tons. Ten roasting furnaces treated 283,349 tons of ore averaging 28.9% sulphur, reducing this to 9.5%. The converters produced 38,027 tons of blister copper. The metal production from company ore was 63,126,931 lb. copper, 947,129 oz. silver, and 26,213 oz. gold.

RECENT PUBLICATIONS

ZINC AND LEAD HANDBOOK, 1916. By L. L. Wittich. P. 90. May. *Joplin News Herald*, Joplin, Missouri. For sale by the MINING AND SCIENTIFIC PRESS. Price, 25 cents.

The author of this useful booklet is mining editor of a live paper in the largest zinc centre of the country, and correspondent of the Press, and is also conversant with events in the Missouri-Kansas-Oklahoma region, the output of which in 1915 was \$26,938,650. The book contains in tabulated form spelter and lead production, prices, consumption, smelters, etc., of the United States and foreign countries; output, costs and other statistics of the Joplin district, as it is known. Generally a handy little reference.

U. S. Geological Survey, Washington, D. C., 1916. Water-supply papers.

COLORADO RIVER BASIN. No. 359. Prepared in co-operation with the states of Arizona, Utah, and New Mexico. P. 269. Ill. index.

A WATER-POWER RECONNAISSANCE IN SOUTH-CENTRAL ALASKA. By C. E. Ellsworth and R. W. Davenport, with a section on south-eastern Alaska by J. C. Hoyt. No. 372. P. 173. Ill. index.

GROUND-WATER IN LASALLE AND McMULLEN COUNTIES, TEXAS. By Alexander Deussen and R. B. Dole. No. 375-G. P. 41. Ill. index.

METAL-MINE ACCIDENTS IN THE UNITED STATES IN 1914. Compiled by Albert H. Fay. Technical paper 129. P. 96. Ill. tables.

NOTES ON THE PROMONTORY DISTRICT, UTAH. By B. S. Butler, and V. C. Heikes. Bulletin 649-A. P. 10. Maps. An abstract of this appeared in this journal of April —

EVAPORATION OF BRINE FROM SEARLES LAKE, CALIFORNIA. By W. B. Hicks. Professional paper 98-A. P. 8. Charts. A useful contribution to an important subject, namely, potash.

INVESTIGATION OF A REPORTED DISCOVERY OF PHOSPHATE IN ALBERTA. By Hugh S. de Schmid. Bulletin No. 12. P. 38. Illustrated. Department of Mines, Ottawa, Canada, 1916. Abstracts from this publication have already appeared in the Press.

GLIMPSSES OF OUR NATIONAL PARKS. By Robert Sterling Yard. P. 38. Map. Government Printing Office, Washington, D. C., 1916. Some interesting notes on the great reserves of scenic beauty, which, curiously enough, are all west of Denver, Colorado.

PETROLEUM IN GRANITE, AND THE EFFECT OF STRUCTURE UPON MIGRATION AND SEPARATION OF HYDROCARBONS. By L. W. Trumbull. Bulletin No. 1. scientific series. P. 27. Illustrated. State Geologist's office, Cheyenne, Wyoming, 1916.

STATISTICS OF THE MINERAL PRODUCTION OF ALABAMA FOR 1914. By Eugene A. Smith. Bulletin No. 16. P. 64. Geological Survey of Alabama University, 1915. The total value was nearly \$31,000,000.

DATA OF GEO-CHEMISTRY. Third edition. By Frank Wigglesworth Clarke. Bulletin 616. P. 821. Index. A review of this work will appear in another issue of this journal.

REPORT OF THE DEPARTMENT OF HEALTH OF THE PANAMA CANAL FOR 1915. By Chas. F. Mason. P. 67. Chart. Washington, D. C., 1916.

MINERAL PRODUCTION OF QUEBEC IN 1915. Preliminary statement. By Theo. C. Denis. P. 7. Department of Mines, Quebec, 1916.

INDUSTRIAL NOTES

The Brown Hoisting Machinery Co. announces the appointment of its vice-president, Alexander C. Brown, to the position of general manager, succeeding Richard B. Sheridan, who has resigned to accept another position.

The Sullivan Machinery Co. announces the resignation of Robert J. Raley as district sales manager at Duluth for the Lake Superior iron and copper ranges. John F. Berteling, hitherto associated with Mr. Raley, succeeds him as district sales manager, with headquarters at Ishpeming, Michigan.

The Dyming Co., Salem, Ohio, has recently published a general catalog which is above the average. In addition to listing various types of pumps for mine and mill work, together with their specifications, a quantity of technical data and engineering data and engineering tables are published showing capacities, air-compression, loads, friction of water, measurements, etc.

The Pratt-Gilbert Co., Phoenix, Arizona, has recently secured the representation of many Eastern manufacturers of mining machinery and supplies. Their lines include pumps, compressors, drills, hoists, packing, belting, drill-steel, etc. The stock is said to be sufficiently comprehensive to supply any of the probable demands of the mining districts of Arizona and New Mexico.

An express shipment weighing 12,000 lb., consisting of one 'Chicago pneumatic' air-compressor and four 'Hummer' hammer-drills, was recently made to New York by the Chicago Pneumatic Tool Co., 1010 Fisher building, Chicago, consigned to the International Trading Co., New York, which will re-ship these machines to South America, where they are to be used in the construction of sewerage systems and water-works in the cities of Paysanda, Mercedes, and Salto in the republic of Uruguay.

After a considerable amount of experimenting, Still & Still of Los Angeles, who purchased the Parks Electro-Cyanide Co., have been successful in making almost complete precipitation from solutions. The process is said to eliminate filtering devices and zinc precipitation, by amalgamating gold directly from cyanide solution and regenerating the cyanide. Highly mineralized ores are reported to be amenable to the system of treatment, which briefly consists of agitating pulp in a pan with cyanide solution in the presence of an electric current. The precious metals dissolved are then deposited on an amalgamated copper plate by the current.

The Justrite Manufacturing Co. of Chicago has completed its new factory building at Southport avenue and Kingsbury street, which will be the new home of the company. This building is four stories high and contains 50,000 sq. ft. of floor-space. It is of modern construction, with doors, stairs, and window-framing all of steel. Automatic sprinkling apparatus has been installed throughout the new plant. The principal business of this company is the manufacture of acetylene miners' lamps, of which they make a large variety. The acetylene lamp is rapidly taking the place of oil lamps and candles. It is estimated that at least 75% of all mining industries in this country use the carbide lamp for lighting purposes. The Justrite lamp is used extensively in this country, and the company is also enjoying a large export business. They also make fire-prevention devices and automatic sanitary-waste receptacles.



EDITORIAL



T. A. RICKARD, Editor

SAPONIFICATION, at one time, was suggested as an essential to successful operation of the flotation process. More than one patent was secured for the purpose. We publish an article by Mr. M. H. Thornberry, of the School of Mines in the University of Missouri, describing a series of experiments, designed to try the substitution of soap for oil as a frothing agent.

ANACONDA'S production in April is announced as 33,300,000 pounds of copper, an increase of 6,700,000 pounds above the output in March. In 1915 the production of the company at Anaconda and Great Falls was 254,311,574 pounds, as against 223,720,292 the previous year. Out of these totals, 19,235,285 and 18,421,761 pounds, respectively, represented copper extracted from custom ores. Out of the total production of silver in 1915, namely, 9,005,617 ounces, the company's mines contributed 8,064,986 ounces, together with 106,702 ounces of gold. In the annual report we find the significant statement that "the resumption of peace in Europe will, with perhaps a brief intervening period of re-adjustment, be accompanied by an enormous demand for copper, when industrial activity is resumed and the work of rehabilitation is undertaken."

IN statistics just issued by the Geological Survey, the total output of American copper in 1915 is given as 1388 million pounds, as compared with 1150 million pounds in 1914. Arizona was easily the biggest producer, contributing 432,467,690 pounds, Montana and Michigan ranking next with 268,263,040 and 238,956,410 pounds respectively. Last year Michigan regained the third place, passing Utah, which produced 175,177,695 pounds, increasing only 15 million pounds, while Michigan increased 81 million pounds during the year. Alaska made a big jump, from 24,985,000 to 70,695,000 pounds, passing both California and Nevada, this quadrupling of the output from the North being due chiefly to the relatively small tonnage of very rich ore from the Bonanza orebody of the Kennecott Copper Company. The most significant figure in the statistics is the increase of new refined copper, this being about 100 million pounds in excess of 1914, in which year the total was 1,533,781,394. It is probable that the refinery production will reach 2000 million pounds for the current year. This would be an increase of 27% over 1915, as compared with the 7.4% increase during the preceding twelve months. That 7.4% increase is only a little above normal, while the anticipated 27% for 1916 will be nearly four times the normal. And it will be produced on an average price 10 cents higher than in 1915 and nearly

double the normal quotation for the last 30 years. The foreign copper refined in this country totaled 246 million pounds, including that from two American-owned Chilean producers, the Braden and Chile companies, the latter owning the Chuquicamata mine; also the Cananea output, from Mexico. Elsewhere we quote a forecast, appearing in the Anaconda annual report, in regard to the demand for copper after the War. It is to be noted that the German consumption of copper imported from America more than doubled between 1909 and 1913; how much of that was accumulated in preparation for *Der Tag* we do not know; nor where Germany is now obtaining her supply of copper; nor to what extent it has proved possible to substitute other metals for copper in the manufacture of both munitions and industrial products. These unknown factors may prove of small consequence in shaping the course of the market at the close of the War, but they must not be ignored by the student of economics.

DISCUSSION this week is enriched by the letter from Mr. Albert Burch on the training of the young American miner. We discuss the subject at length on another page. Mr. A. G. Harbaugh, an experienced mill-man, gives an account of the saving of the precious metals by amalgamation with the mercury precipitated from solution in cyanide. The relation of mining engineers to business, and particularly the advantage to the former of understanding the latter, is emphasized by Mr. P. B. McDonald, of our staff. The statistics of gold production are discussed by Mr. Edward Walker, of *The Mining Magazine*, with particular reference to our recent criticism of the figures published by two of our contemporaries. In a letter from Burma, Mr. William Kitto, of the Burma Mines Co., records his experience in the use of the light water-hammer drill and takes exception to sundry generalizations made by Mr. E. M. Weston, a South African engineer. The effects of flotation-oil in cyanidation have been tested by Mr. J. E. Clemmell, of the Butters laboratory, and he writes giving the results of his research. This shows that the decomposition of cyanide, by such oil, is negligible.

MERCURY is a metal of particular interest at this time. We publish a useful article by Mr. Herbert Lang, who to long metallurgical experience adds the happy faculty of writing clearly and pleasantly. His treatment of the subject will please both those who know a great deal and those who know next to nothing in regard to this particular technical process, for he discusses the fundamental principles that are of equally vital im-

portance to the student and the specialist. On one minor matter we may venture to comment, namely, the presence of mercury in gold and silver ores. At Kalgoorlie, in Western Australia, an impure telluride of mercury called kalgoorlite is associated with free gold and various gold-silver tellurides, such as calaverite, sylvanite, and petzite. This kalgoorlite contains 11% mercury, while the true mercuric telluride, coloradoite, which was first found in Boulder county, Colorado, contains when pure 61.5%. In roasting gold precipitate from the cyanide plants at Kalgoorlie, some of the mercury used to be collected, notably in the Oroya-Brownhill mill. Mercury also occurs in association with silver at Cobalt, Ontario, as was pointed out recently by Mr. G. H. Clevenger, in *Economic Geology*. At the Nipissing the ore contains from 0.26 to 4.74% mercury, the maximum being found in mass silver or 'metallies.' In this ore the mercury exists as a silver amalgam, not so much with the purer forms of silver as with dyserasite, the antimonide of silver. Mr. Lang refers to several other unusual mercuric associations, all of which are of minor importance as compared with cinnabar, the principal ore, which in its purest form is the vermilion of the artist and the ancients.

FINE GRINDING, and the choice therefor between the stamp-battery and the ball-mill, is the subject of a suggestive article by Mr. Henry Hanson. 'The Passing of the Stamp' has been the title of technical ruminations for the time of a generation, yet the old machine, continually modified and improved, still lingers. Its place in the reduction plant has become more nearly fixed and the part it is called upon to play in the reduction process has been more nearly defined; nevertheless, the simplicity of the stamp-battery has caused it to survive amid the great diversity of apparatus devised during the last two decades. Undoubtedly the experience in the concentration of copper ores is exerting a big influence upon the vogue of the stamp in the metallurgy of the precious metals. It has long been recognized that the work done by the stamp in pulverizing ore to anything finer than, say, 30-mesh, is uneconomical; not only is the consumption of power excessive, but the product contains a disproportionate amount of slime. That is why the copper mills substituted rolls and stage-crushing. Concurrently, experience in the treatment of the hard gold-bearing blanket of the Rand has shown that the finer grinding could be done best in other machines, so that there the stamp is now used only in reducing to 8 or 10-mesh, the final reduction being relegated to tube-mills. Now that slime has ceased to be such a bugbear and the adoption of flotation calls for intense comminution, we must revise our notions on the subject. Other factors, such as space occupied, power consumed, and water wasted, have come into play against the stamp-mill, and in favor of the ball-mill, as a secondary crusher immediately following rock-breakers in series. We commend Mr. Hanson's article to our readers. He is an independent engineer and writes without prejudice. We

shall be glad to see the subject discussed in our pages and invite metallurgists or mill men to state their opinions, as based upon their experience.

METAL prices in relation to the New York Metal Exchange were discussed in our issue of April 29. Apparently the subject is exercising the minds of the trade, for the *Journal of Commerce* and the *Daily Metal Reporter* are advocating the desirability of restoring the Metal Exchange to a position of usefulness, which means rehabilitating public confidence in that institution. By a happy coincidence, a letter was sent on April 29 also to Mr. W. C. Redfield, the Secretary of Commerce, appealing for assistance in overcoming the opposition to recognition of the Exchange. In that letter it is acknowledged that the latter has not served "the true purpose of an exchange, that of ascertaining by bids, offers, and sales the true value of the commodities traded in." [Incidentally, prepositions are poor things to end up a sentence *with*.] The gentleman on the *Metal Reporter* also acknowledges that "for the past eight years, the New York Metal Exchange has been an exchange in name only, due to influences which will be more fully alluded to [prepositions are awkward things] in the following paragraphs." We shall not quote those paragraphs; suffice it to say that our contemporary suggests the sinister enmity of "interests which unfortunately control 75% of the output of American copper mines." We are frank to confess that for once we find ourselves in agreement with those 'interests,' in so far as they refused to recognize a simulacrum. They had one reason for ignoring the so-called Metal Exchange and we have another. But we do agree heartily with the *Metal Reporter*, and the metal producers, brokers, and consumers for whom it speaks, in laying stress on the urgent need for a real exchange where dealings in the metals can be recorded with a view to ascertaining the market-value of them from day to day. It is quite certain that those operating mines—individuals, syndicates, and companies—are suspicious, and rightly so, concerning the devious methods by which prices are now fixed and would welcome the establishment of a clearing-house of quotations. Whether it is worth while to rehabilitate the New York Metal Exchange is another question. It has a habitation and a name; if it can be spring-cleaned and fumigated, it may serve the purpose.

The Rise in Silver

All the metals have risen in price, in most cases rapidly, in consequence of conditions created by the War. Silver was depressed at first. During 1915 the market for the junior precious metal was weak, the bottom being reached on September 4, when the price was 46.25 cents per ounce, the lowest on record. After that it recovered slowly to 56 early in December. Suddenly, toward the end of April the price jumped successively as follows: 64.50, 65.37, 67.00, 67.12, 69.00, 71.37, 73.50,

74.87, reaching the top at 77.25 on May 3. This remarkable change has come as a pleasant surprise to the mining public, despite the intimations made from time to time, in the financial press, that conditions were becoming increasingly favorable to an expansion of demand.

The decline since 1833 is summarized, in decades, as follows:

| | | | |
|------|--------------|------|--------------|
| 1833 |\$1.297 | 1893 |\$0.782 |
| 1853 |1.348 | 1903 |0.534 |
| 1873 |1.298 | 1913 |0.578 |
| 1883 |1.110 | | |

The vicissitudes of the market since the beginning of 1914 are outlined thus:

| | —High— | | —Low— | | Average, |
|-----------|--------|----------|-------|--------------|----------|
| | Price | Date | Price | Date | cents |
| 1914..... | 59.25 | April 28 | 47.62 | Nov. 13..... | 54.8 |
| 1915..... | 56.50 | Nov. 27 | 46.25 | Sept. 4..... | 49.7 |
| 1916..... | 77.25 | May 3 | 55.87 | Jan. 3..... | 58.9 |

The story of silver is interwoven with international economics, changes of money standards, politics, and sentiment ever since 1871. Up to that time, and for two centuries previous, the value-ratio of silver to gold had been maintained at about 16:1, despite the fact that the production-ratio had fluctuated between 4:1 and 50:1. Steadiness of price was due to the free coinage of silver in the chief countries of the world. Until 1871 all the silver that was offered by the miner was taken freely at the average coinage-ratio with gold. In 1871 Germany adopted the gold standard and two years later, in July 1873, commenced to sell its accumulation of silver, thereby forcing France and the rest of the Latin Union to limit their coinage of that metal. Finally, in February 1873, the United States demonetized silver, by reducing the right of legal tender to payments not exceeding five dollars. In 1874, the remaining countries of Europe suspended the mintage of the subsidiary metal except for government account. In 1872 silver was worth \$1.322; in 1876 the average price was \$1.164. Heavy purchases of silver by the United States Treasury under the Bland Act of 1878 and under the Sherman Act of 1890 delayed a final collapse. That came in 1893 when the Indian mints were closed for the private coinage of rupees. In June of that year the price fell from 81¼ to 62 in one week. A recovery ensued to 76 cents. The repeal of the Sherman Act in October of the same year had less effect than had been expected, but it put a quietus on silver from which it has never quite recovered. On October 31, 1893, the price was 68c. Many of our readers will remember those days: the financial panic; the closing of mines; the reduction of wages; and the hot controversy that brought Mr. William Jennings Bryan into political prominence and caused the late Richard P. Rothwell, editor of the *Engineering & Mining Journal*, to bring forward his clearing-house scheme for regulating the ratio of gold to silver.

The uncovering of enormous bodies of silver ore in the mines on the Comstock lode undoubtedly intimidated the Treasury experts of Europe and the United States in 1873 and 1874, hastening the demonetization of the metal, although it is a fact that the Comstock produced

nearly as much gold as silver, in value. In later years, the discoveries at Cobalt and the increasing proportion of silver recovered as a by-product in copper mining had their effect in keeping the price down. The Anaconda Copper Mining Co., for example, produced 9,005,617 ounces of silver last year, while the Butte & Superior obtained 3,563,382 ounces from its zinc and lead concentrates, chiefly the former. Cobalt began to produce in 1905; last year the output was 23,568,147 ounces. During the last three years, however, the troubles in Mexico have crippled production in that important mining region to such an extent that the output of silver has fallen from about 80,000,000 ounces in 1911 to about 35,000,000 last year—no exact figures are available.

Silver has continued to be the basis of international finance between the Far East and London, the latter being the place where the price of silver is fixed. India and China have absorbed an enormous proportion of the silver produced, India alone taking 55% of the world's annual production.

Since the War several new developments have come into operation. China sold silver to Russia and made a big deposit of the metal in London as security for drafts. India made fresh demands, due largely to the requirements of the native troops drawn into the European arena and to Egypt. Indeed, the enhanced use of subsidiary coinage by the troops of the belligerent nations created an effective demand for silver, which was further appreciated by the steady withdrawal of gold when the governments at war began to issue paper money. The uncertainties of warfare caused hoarding of gold, while also creating a demand for hard money in the form of silver coins. Thus silver has, in large part, replaced gold in Europe. The process of substitution continues. It is due to temporary causes, but the effect may continue after the causes have ceased to operate. The outlook for silver is good.

Preparedness for Engineers

Preparation for war has become a real issue among the engineers of San Francisco, if one may judge from the steps being taken to organize the resources of the profession in California for possible war. The officers of the local sections of the five engineering societies—including the American Chemical Society—met recently, on the initiative of a committee of the Civil Engineers, to decide what was to be done. At that meeting, on April 26, it was agreed to call a joint meeting of the five societies for May 2, to receive a presentation of the subject by Army officers invited for the purpose. This general meeting, under the capable chairmanship of Mr. J. D. Galloway, was well attended. Capt. Richard Park explained the methods by which the civilian engineers can prepare themselves to assist the engineer corps of the U. S. Army, in case of war, and Capt. John B. Murphy described the work of the military training camps. These addresses, which were heard with keen interest, were supplemented by a statement from Mr. Allen

H. Babcock on the work of organization for industrial preparedness being done by the Naval Consulting Board. Mr. Babcock, as our readers are aware, is one of the five Californian engineers selected to serve on that Board. At the close of the meeting a short discussion ensued, the consensus of opinion being crystallized in a resolution authorizing the formation of a permanent Conference Committee, to consist of three representatives from each society. It is probable that the first work to be done will be a card index mobilization of engineers, resulting in a record of age, capacity, and experience that will be kept up to date, for use whenever required. Those who are possible military units will endeavor to spend at least one month annually at a military training camp. They will supplement such instruction by systematic study of textbooks on military science. Thus they can acquire some measure of fitness to act as officers of volunteer regiments when the call comes. There are only 4829 officers in the Regular Army, and even after adding all those possessed of some degree of training, at college and otherwise, there are not more than 20,000 men available for duty as officers. A defensive army of only 1,000,000 would require 50,000 officers. The more nearly the youth of the country is prepared by training to do soldierly duty, the less will there be need for a large standing army. More particularly, is it true that the larger the reserve of men capable of acting as officers, the more surely will the country be prepared to prevent invasion. After that, or concomitant with it, comes the mobilization of the industrial resources that supply the munitions and other necessities of an army in the field. Moreover, even if war be avoided now and in the future, it is quite clear that a systematic inventory of American industries should prove of great help in guiding tariff legislation and in giving information that will be needed nationally in the acute commercial competition that will follow the restoration of peace.

American Youth and Mining

On another page we publish a deeply interesting letter from a mining engineer peculiarly fitted to discuss the subject on which he writes, namely, the rendering of work in mines attractive to the young American. Mr. Albert Burch is a Western man, one who owes his honorable position in the profession of mining engineering to hard work, rare good sense, and that sort of sagacity that is second cousin to genius. When he undertakes to make a suggestion intended to prove helpful to the workers underground, he writes as one having experience and not as a doctrinaire on a platform many feet above his audience. We invite our readers to study carefully what he has written. His plea is presented with the force of sincerity. Starting with a retrospect of conditions in our Western mining centres, he lays emphasis on the fact—to which our own observation over the same period enables us to give intelligent concurrence—that the common labor of the mine, particularly underground, is now done by emigrants from south-eastern Europe instead as

formerly by the native sons of the indigenous population—in short, Americans. To give further point to the discussion of this subject, Mr. Burch expresses the belief that during the War, and for some time afterward, there will be a diminution in the volume of immigration to this country from Europe, so that the sentimental phase of the problem will be supplemented by an economic aspect, namely, the lack of the kind of labor that seeks employment underground. Those who operate mines want a steady supply of labor and they want it of suitable quality. To this we would add that unless the signs fail, there is destined to be an intensified exploitation of mineral resources owing to a continually increasing demand for metals, so that the shortage of efficient labor is likely to become more acute during the next decade. What is the remedy for this? Mr. Burch suggests the furnishing of instruction to the American boy while he is working in the mine, so that he may have a chance to perform his work more intelligently and have the further opportunity of equipping himself for promotion. The idea is to aid him in emerging from the dead level of run-of-mine labor and differentiating himself as a skilled worker, serving an apprenticeship for something better—'better' because it affords an avenue of evolution to the use of brain rather than muscle—to the faculties above, rather than below, the chin. Hence the proposal to establish a mining school for the benefit of employees, at the expense of the mining company or of a number of companies operating in the same locality. Now that the 8-hour shift is established, it will be practicable for young workers to devote two or three hours when off-shift to the learning of the elementary principles of science governing the operations in which they take a daily part, such as the breaking of ground, ore-sorting, and timbering. The establishment of such opportunities for instruction should prove no mere philanthropic scheme, but a means of increasing efficiency. While that may not be the primary purpose, it would be a consequence of the basic idea, of rendering mine employment attractive to the sons of the farmer, the store-keeper, and the lesser crafts. Mr. Burch states the case so well that we need not paraphrase his argument. We invite the managers of mines to give serious consideration to the proposal and discuss it in our columns. It appeals to us as eminently reasonable and practicable. We know already what good, both mental and moral—if they may be separated—has been done by the establishment of reading-rooms and places of wholesome recreation for the workers in mines. To put it bluntly, it has repaid the companies handsomely because it has added greatly to the well-being of their employees. This scheme is a little different; it has a separate purpose; but it is only a logical development in a special direction. And apart from the purely industrial point of view, there is that broader phase of a more generous economics that aims to make men happier and more useful to themselves and the community; the enlightened patriotism that aims to develop the American youth into a man of greater capacity and efficiency.



DISCUSSION

Our readers are invited to use this department for the discussion of technical and other matters pertaining to mining and metallurgy. The Editor welcomes the expression of views contrary to his own, believing that careful criticism is more valuable than casual compliment.

The American Boy and the Mine

The Editor:

Sir—When I was beginning my mining career, the Irish and Cornish, with a fair percentage of Americans, swung the hammers and placed the timbers in the mines west of the Rocky Mountains; while American boys, recruited from near-by ranches and country towns, shoveled the 'muck,' pushed the cars, and did much of the surface work about the mines. Even at that time a few miners (and good ones, too) were beginning to arrive from Austria, and timber-men from Finland and Sweden; but the great influx of mine laborers from Southern Europe had not yet reached the Western States.

Today, especially in California, all this is changed. In such old mining centres as Butte, Park City, Tintic, and Grass Valley we find the sons and grandsons of the old-time Irish and Cornish hammersmen running machine-drills in the mines; but, even in these districts, most of the common labor is performed by newly-arrived immigrants from Southern Europe; and in many other Western mines, nearly all underground employees are from the same region. In other words, the American boy as a prospective miner has practically disappeared.

Much has been written since the beginning of the European war regarding its present and future effect upon European emigration; and although all are agreed that while the War lasts emigration will be practically nil, the views of writers as to what will be the condition prevailing after the War are quite divergent. Without taking space in this letter to give the reasons for my belief, I include myself with those who think that for many years American immigration from all parts of Europe will be of much smaller volume than for the years preceeding the War. Where then are we to look for the 'mucker' of today who must become the miner of tomorrow, unless American boys can be induced to take up the work, as they did thirty years ago? Furthermore, is it not within the range of possibility that a general improvement in the intelligence of the miners of the future may be brought about by training American boys, instead of European peasants, for the work? I am not among those who subscribe unreservedly to the sentiment that the best qualifications for a 'mucker' are "a strong back and a weak intellect"; and, while not wishing to belittle in any way the hard grinding work performed by immigrants from foreign lands, I believe that most mine foremen will agree that it is easier, on

the ground of a better understanding of the language alone, to train a willing and industrious American boy than a raw immigrant. And on the same ground, of the better understanding of spoken orders and printed rules, greater aid is given to safety of operation and the prevention of accidents.

The writer recently visited a mine where underground sorting of ore is necessarily practised, and where, after months of training, the work of the 'muckers' was still unsatisfactory. In part, their failure to do good work was due to lack of knowledge of the language; and in part, I fear, to lack of native intelligence; but, whatever the cause, the mine is losing hundreds of dollars per month because of inefficient sorting.

It has been said that the American boy, as found in the country districts and small towns of California, will not work, and certainly not at such common labor as soils his hands and makes his back ache; and, I fear that, as conditions now exist, this is all too true. But American boys have, in the past, worked as common laborers, and the writer was one of them. But, they will not begin work of that character if they see that it is hopeless for them ever to expect anything better; therefore many such boys and young men are idle, or comparatively idle, today; largely because of lack of opportunity to make a start in some employment that promises future advancement. In the mechanical trades the labor-unions, largely controlled by the foreign element, have so curtailed opportunities for apprenticeship, that it is difficult for a boy to get a start in those lines; and we are today confronted by the spectacle of many American-born boys and young men idling their time away or crowding into poorly paid clerical or mercantile positions, while the more lucrative, if, also more exacting, occupations afford employment to others.

In seeking for a remedy for this situation as applied to the mining industry, we must take into consideration the character and traits of the average American boy who might be made available for mine-work. Such a boy will probably be found more ambitious, though less industrious and more independent, and yet, under proper influences, more tractable than the foreign laborer now employed. He will be more frank in his resentment of unjust treatment, and less suspicious; and therefore will respond more readily to the influence of proper treatment. He will have the ground-work of a common-school education, based upon greater natural intelligence. In physique, he may not equal the imported laborer, though this is a debatable question, but, even

if weaker physically, the difference should be made up in a short time by greater skill. But the chief consideration is, as stated above, that because of his greater ambition, the American boy will not begin work as a common laborer unless he sees the promise of something better in the future, and it is to put before him this promise that the following plan is proposed. I suggest that in each important mining centre the mining company or companies set aside or construct a suitable room or building to be used as a mining school for the instruction of employees in the theory and practice of mining. The instructor should be a recent graduate from the mining department of the University of California or some similar institution, and in selecting him, care should be exercised to obtain one who has had the maximum of practical experience. The school hours should not be so long as to be burdensome, but should be so arranged as to afford instruction to men from both the day and night shifts. The instruction should be entirely free to all employees of the interested companies between specified limits of age, and above a specified standard of preliminary education. Just how high this standard should be, need not be discussed here, but no doubt with the aid of the faculty of the State University a two years' course could be devised that would give a man a good insight into the theory of mining, even though at the start he had nothing better than a grammar-school education. The object would be not to give a man a training as a mining engineer, but to fit him in both theory and practice to become a first-class miner, timber-man, shift-boss, or foreman. Having provided the plant and instructor for the school, the next step suggested is for the interested companies to send out an agent, whose duty it would be to select from among applicants in the mining district itself, and from the country adjacent, a few boys ranging in age from 18 to 21 years, who were qualified by physique, intelligence, ambition, and preliminary education to undertake the work of mine-laborers coupled with instruction such as the school could give. They should be given distinctly to understand that their pay would be the same as for other laborers in the same class of employment, and that their jobs could only be held by both doing their work properly in the mine and regular attendance at the school. It is my belief that hundreds of such boys can be found in California, and their proper training will, in a few years, materially raise the standard of the miners employed in the State. The schools would serve the double purpose of supplying instruction and of filling the time of the young men so occupied as to prevent their falling victims to the demoralizing influences that have in the past ruined many American boys in the Western mining camps. Naturally, the majority of those boys taking this training would never advance beyond the grade of expert miner and timber-men, but even this would be a distinct gain both to themselves and to the industry, which would be still further benefited by the better training of the few who might become shift-bosses, foremen, and superintendents. The expense of

maintaining such trade schools, if they may be so called, would not be a great burden upon any mining company, and it is my opinion that it would be much more than off set within a very few years by the greater efficiency of the employees. Progressive railroad and industrial corporations, for many years, have found it profitable to maintain schools for the better training of certain classes of their employees, and intelligence and skill are quite as valuable to the conduct of mining operations as to most other lines of work. This being true, why not try to devise some plan that will give us more of intelligence and skill? The scheme outlined may not seem entirely practical to those of your readers who control mines; but it is hoped that this letter may lead to a discussion which will result in the general adoption of some plan that will prove practical.

ALBERT BUREN

San Francisco, April 25.

Precipitation of Gold and Silver in Steel Launder

The Editor:

Sir—The following notes relate to leaching with cyanide solutions in the usual way, followed by the roasting of the tailing from a silver ore containing mercury.

The output of the once famous camp of Candelaria used to be milled chiefly at Belleville, Nevada, nine miles distant from the mines. The mills were placed at Belleville on account of water, the supply being piped by a gravity line nine miles long from Marietta Springs. The ore was hauled by wagons. Each wagon with a trailer was loaded with 27 tons. In the later days of Candelaria, a branch of the narrow-gauge railway from Mina (Nevada) to Keeler (California) was extended into the district to bring supplies of wood and mining materials, and to carry ore to the two 20-stamp mills at Belleville. Roasting and pan amalgamation, according to the prevailing method at that time, was the treatment given the Candelaria silver ores. The residue after milling contained 8 oz. silver and from 60c. to \$1 in gold per ton.

During the spring of 1914 a leaching plant was erected in the open by a company formed and managed by F. C. Beedle, known as The Belleville Tailing Association. Up to this time the piles of tailing had been sampled by scores of parties, the result being a unanimous decision that they were not workable by cyanidation. The plant was erected despite this opinion; it consists of sixteen 100-ton vats, giving a capacity of 120 tons per day, when the water for sluicing does not have to be used for other purposes. A limited supply is all that is now available.

The low price of silver and the high cost of zinc for precipitation made necessary some change during the season of 1915. Necessity and experience do many new things for ore treatment. It was found that a concentration took place in a small wooden launder that carried the solution from the vats to the storage-tanks at the head of the zinc-boxes. A deposit was made around nail-heads where the mercury formed amalgam and collected

silver and gold. To make real use of this precipitation a launder was constructed out of No. 10 steel sheets, 4 ft. wide by 1 ft. high. A flare of two inches was given to each side, making the top measurement across the launder 4 ft. 4 in. The quantity of solution to pass over this area of precipitation was calculated at from 120 to 150 tons per 24 hours. To give ample scope for the operation a launder 80 ft. long was employed, with a grade of $\frac{1}{8}$ -in. per foot. Before using, the launder was given two good coats of carbon paint to protect the steel from the action of the solution. The results for several weeks showed an extraction of 74% of the gold and silver in solution. The remaining metal contents were removed by the zinc-boxes that received the discharge from the wide launder. The zinc 'shorts' from the boxes served to start the precipitation, with some scraps of iron and tin-cans. The mercury forms amalgam on these and continues to gather more, building upon itself. By this system the zinc consumption for this plant was reduced 60%. The advantage in melting the product is also worthy of notice, since a better grade of precipitate is obtained in this way. The mercury dissolved by the cyanide solution is removed by this device. The precipitation of the gold and silver is excellent at all times.

The precipitate is dried with a gentle heat and retorted to recover the quicksilver, and then melted in the regular manner. The cyanide loss per ton of ore leached is $\frac{1}{2}$ pound. The strength of the strong contact is four pounds per ton of solution. The protective alkalinity is carried at $\frac{3}{10}$ pound per ton. A small quantity of lead acetate is all that is needed.

A. G. HARBAUGH.

Belleville, Nevada, April 2.

Engineers and Business

The Editor:

Sir—The discussion of the training and status of the engineer has tended to overlook the relation of the engineer to the large organization. The big corporation has undoubtedly come to stay. The tendency of these aggregations of capital and men appears to be continued expansion. Almost all of the great mining and business houses are continually taking over smaller operations and establishing new connections—some of them in foreign countries. In mining, for instance, the Anaconda company, besides constant growth in Montana, is looking for mines in the Andes. In finance, the National City Bank of New York is rapidly securing branches throughout South America and the Orient. Expansion, ramification, and diversity are making American corporations bigger and broader. These new departures and growths are taken care of by the creation of additional departments and by the enhancement of specialization. A need is arising in such departments for technically trained men whose work requires as much knowledge of business and human nature as of engineering. Many of the positions to be filled by these companies can be called semi-technical.

A friend of mine has advanced the interesting idea that the best thing a young engineer can do in order to get on, is to learn something more commercial. What he means is that an engineer who has received the broad foundation of a technical training, which brings clear thinking and the ability to reason from fundamental principles, should pick out a specialty or hobby that will enable him to apply his engineering ideas and his enthusiasm to some lucrative branch of industry. An engineer who remains merely an engineer is likely to become a narrow drudge. More money is to be made and more chance for expression can be found, as a rule, by being half an engineer and half a business-man. One result of the multiplication of departments in the large organizations, and of the present high degree of specialization in industry is a lack of co-operation between departments. This entails much working at cross-purposes, and a good deal of duplicated and wasted effort.

The large businesses, built up so rapidly by combining the abilities of highly specialized workers, do a lot of useless routine because no one has had time to introduce a sense of proportion into their affairs. It has been difficult to get men who could understand two phases of the work at the same time. Many professions and lines of endeavor, we are told, are over-crowded; but the combinations of different abilities necessary for the understanding of particularly complex industries are still rare. One reason for the presence of men of narrow outlook has been the training of technical men who did not have a previous foundation of general education. The future should develop men who are well-balanced combinations of engineers and business-men.

P. B. McDONALD.

Berkeley, April 19.

Gold Output for 1915

The Editor:

Sir—In an editorial note in your issue of March 11 you express surprise "that *The Mining Magazine* reproduces the so-called statistics of the world's gold production published at the beginning of the year by the *Engineering and Mining Journal*, the editor in London stating that his own efforts to collect the necessary statistics had proved unsatisfactory to himself." In particular, you instance an error in the *Engineering and Mining Journal's* statistics in connection with the Canadian output, with the inference that we used our contemporary's incorrect figures. As the writer of the editorial in our February issue on the 'Gold Output of the World for 1915,' to which you refer in your paragraph, permit me to say that your remarks give an entirely wrong impression of the nature of the *Magazine's* statistical work, for we used the *Engineering and Mining Journal's* figures only for Mexico, Central and South America, Hungary, and the Dutch East Indies. Our figures for Canada were given correctly, as we used the official returns of the Mines Branch. We had good reason for making estimates that differed substantially

from those of the *Journal* in the case of Madagascar, Congo, Russia, China, and Japan, and naturally, as our article was published six weeks after the *Journal's*, we were able to employ the actual figures of production throughout most of the British Empire. Our editorial fully explained the method of collection of the statistics and analyzed our sources of information, and all should be clear to the careful reader.

I patter myself that since writing that editorial I have had no reason to regret any individual estimate, and furthermore that the *Magazine's* total agrees remarkably—besides with the later figures of the United States Mint. After taking so much trouble in this matter, it is mortifying to have people interpret your paragraph to mean that we had bodily lifted somebody else's incorrect statistics.

EDWARD WALKER,

Assistant Editor of *The Mining Magazine*.

London, April 13.

[Mr. Walker is quite correct in what he says concerning the Canadian figures. The point we raised was that it was absurd for *The Mining Magazine* to quote the New York paper's statistics when it had itself in London all the real figures available, namely, those covering gold mining in the British dominions and the United States. In the first week of January no other statistics were obtainable; we objected to the sham statistics that are now so common at the beginning of each year. To guess three times and to divide by three for accuracy's sake simply gives the similitude of precision to gross inexactitude.—Error.]

Water-Hammer Drills

The Editor:

Sir—Referring to the article on 'Rock-Drilling Practice on the Rand' in your issue of December 11, 1915, it is stated: "Using light water-hammer drills that theoretically can be worked by one native, the predicted drilling speed could not be realized, so that more natives were required than with piston drills."

Where does Mr. Weston get the idea of the piston-machine being simpler to handle than Leyner-Ungersoll water-hammer drills? We are driving a tunnel (8 by 9 ft. for the Burma Mines Co., in Burma, 8770 ft. long, with a 2 by 3-ft. drain, using Chinese Shan labor, and our experience, using both piston and hammer type of machines, has been that the hammer drills discount the piston-drills in every way, in speed of drilling and speed of changing steel. They are far superior on holes looking up or flat holes and equally as fast on angle-holes. We also found that hollow steel of the same grade stands better than solid, the water helping it to retain an edge.

The Chinese employed here are large and strong, but even at that they were not nearly as fast or efficient on piston as on hammer-drills. We use two coolies on a machine, but often the crank-man will run a hole or more down while his partner is rustling steel or something

that will be needed. Three machines are worked on one cross bar. We use a blow pipe to clear the cuttings on all angle holes. Our best month was January, 1916, when the ground was hard and solid; we made 502 ft. in 29 working days; 27 ft. was the best day's work. One European per shift. We work on four shifts. Let me repeat, in closing, that in comparing piston with hammer-water type drills with native labor, it is all in favor of the hammer drills.

WILLIAM KITTO,

Nam Tu, Burma, March 2.

[The statement to which Mr. Kitto takes exception is quoted from the brief abstract of an article by Mr. E. M. Weston, of Johannesburg, appearing in *The Mining Magazine* last August.—Error.]

Influence of Flotation Oils on Cyanide

The Editor:

Sir—The following tests were made to determine whether any decomposition of cyanide would be caused by any ingredients of the oils used in flotation remaining in the products to be cyanided.

The solution used in all tests contained 0.201% KCN, without alkali. Oils used:

| | |
|-------|-----------------------|
| No. 1 | Barrett tar |
| " 2 | Barrett tar-oil |
| " 3 | Crude carbolic |
| " 4 | Crude pine-oil, G. L. |
| " 5 | 40-40-20 mixture |
| " 6 | Iowa Tiger mixture |

| | |
|-------------------|-----------------------------|
| No. 5 consists of | { 10% El Paso tar |
| | { 40% Barrett tar-oil |
| | { 20% Carbolic |
| No. 6 consists of | { 1 part Barrett tar |
| | { 3 parts carbolic creosote |
| | { 3 parts pine-oil |

The following mixtures were agitated in the proportions shown below, and filtered. The titration of the filtrate shows practically no consumption of cyanide in any case.

| Test No. | Solution used, cc. | Oil used, gm. | Final solution after flotation KCN% | CaO |
|----------|--------------------|---------------|-------------------------------------|-------|
| 1 | 400 | 4 | 0.198 | trace |
| 2 | 400 | 5 | 0.198 | trace |
| 3 | 400 | 5 | 0.202 | trace |
| 4 | 200 | 2 | 0.202 | nil |
| 5 | 200 | 2 | 0.204 | nil |
| 6 | 200 | 2 | 0.202 | nil |

Solution from No. 1 had a slight yellow tinge; from No. 2 and 3, somewhat red. No indications of sulphocyanide were found in these solutions.

No. 4 gave a milky emulsion.

No. 5 and 6 were brownish and somewhat turbid, so that the exact end-point of the titration was doubtful. A portion of No. 5 shaken with excess of lime and re-filtered showed KCN 0.196% and CaO 0.098%.

The proportion of oil used in these tests was much in excess of any that would be likely to occur in practice.

J. E. CLENNELL,

Berkeley, March 16.

Fine Grinding: Stamps and Ball-Mills

By Henry Hanson

THE past few years have witnessed many changes in the machinery employed in reducing ore. The stamp, so long dominant in the reduction of precious-metal ores, has gradually been relegated to the position of a primary crusher by reason of the success of the tube-mill; and more recently the use of the stamp as a primary crusher has become questionable, now that the ball-mill, the rolls, and the disc-crusher vie with one another for economic supremacy in reducing a crusher-product to a suitable tube-mill feed.

The tube-mill was first utilized for gold-milling in Australia; the circumstances leading to its success there as a fine grinder may be summarized as follows:

A telluride-sulphide ore did not yield its gold by the ordinary methods of treatment. Experiments with a view to treating the bulk of the lower-grade ores of the Kalgoorlie mines were made, first, by roasting the whole product after crushing, secondly, by wet crushing and concentration, roasting of the concentrate, leaching the sand, and filter-pressing the slime. The results were in no way satisfactory. It was at this time (about 1900) that Dr. Ludwig Diehl, who had modified the Haman's Brown Hill plant, treating oxidized ore in the district, was induced to turn his attention to the treatment of the sulpho-telluride ores. After a series of experiments he found that by grinding to a fineness not previously attained, the gold could be satisfactorily recovered from the raw ore, using bromo-cyanide as a solvent. The problem then was to find or develop a machine that would economically and satisfactorily reduce the ore to the fineness required. The tube-mill, even at that time extensively used by cement manufacturers, was adopted as a secondary grinder. Other factors that also served to push the stamp aside were the demand for finer grinding that came with the wider application of cyanidation and the introduction of machines for the filtration of slime.

It is now generally conceded that the stamp, if employed at all, should only be used as a primary or intermediate crusher in reducing an ore to a suitable tube-mill feed. This naturally raises the question whether it would not be good economy in some of the large mills, where single-stage reduction is employed, to scrap at least half of the stamps and increase the duty of the remaining stamps by crushing to a size suitable for secondary grinders, that is, follow the stamps by tube-mills. It might be still better to scrap all the stamps and put up a central plant using ball-mills or tube-mills and such primary crushing equipment as would most cheaply reduce the ore from a crusher-product to a tube-mill feed.

A great deal of stress has been laid on the flexible use of stamps, but stamps and tube-mills working together

would certainly afford a more elastic arrangement than stamps when working alone, for it is well known that the cost where stamps are employed to crush finer than 6 to 8 mesh is out of all proportion to the work done, and when a product finer than 35-mesh is required the single-stage stamp reduction is no longer considered except where abnormal conditions obtain. In most of the low-grade gold deposits, such as the Homestake, Treadwell, and Mother Lode mines, the single-stage stamp reduction is still in vogue. The reason, apparently, is that a good recovery is made, when crushing to a fineness from 20 to 35 mesh by amalgamation in the mortars and on the plates, the plate-tailing being classified into sand and slime for cyanide treatment or the plate-tailing may go to concentration tables, when cyaniding of the tailing as a whole is economically unprofitable. On the Mother Lode the graphitic nature of the ore has interfered with cyanidation. This fact and the high recovery by amalgamation have checked mill operators in California from going into the problem of fine grinding. On the other hand, much work has been done on the Rand to determine the economic fineness to which an ore can be reduced. The stamps on the Rand are used largely as primary crushers, reducing the ore from a crusher product to a suitable feed for tube-mills, and the tendency of late has been to throw more work on the re-grinding machines. No doubt the practice on the Rand has had considerable influence on the design and practice of some of the latest mills in this country and Canada, for in nearly all new mills of note started within the last few years the stamp has been employed as a primary crusher preparing a suitable feed for a secondary grinder. Amalgamation, if any, has been relegated to the tube-mill circuit. Of the several mills lately started in the Porcupine district none has adopted single-stage stamp-reduction. At the Hollinger the stamps are followed by tube-mills; the crushing is done in cyanide solution and no attempt is made to amalgamate, although early experiments showed that fully 75% of the gold was freed during grinding and was amenable to amalgamation. The Dome mill, in the same district, closely follows Rand practice, stamps followed by tube-mills, and the amalgamation is part of the tube-mill circuit. Two or three of the smaller mills in the Porcupine district use rolls or Hardinge ball-mills, getting away from stamps altogether; but with the exception of the Dome, the aim at all these plants is to make an all-slime product. Just why the stamp should be used so extensively when employed as a primary crusher only is hard to explain. Among the arguments advanced in its favor, are the following: It can be installed in small units; it is flexible; it will operate on any kind of ore; it is fool-proof; and

it is an excellent amalgamating device. In units larger than five stamps, the ball mill can replace the stamp; and a mill of this type is certainly much more elastic than a stamp-battery as regards the range of grinding. I have never been able to see wherein a stamp is flexible except when working jointly with a re-grinding machine. When a stamp is working alone a certain size of product is required; if you have an over-capacity, it is true, the stamp can be hung up, but this procedure can hardly be called flexibility. The ball-mill should have an equally wide range as to the character of feed that can be taken. As to the argument of fool-proofness, I know of no machine where the personal equation enters more strongly, and where constant vigilance is more necessary than in the operation of stamps; the water and feed adjustments, the height of discharge, the condition of tappets and screens are important details in obtaining the best results. The most legitimate argument in favor of the stamp is its advantage over other machines as an amalgamating device, and it is rather doubtful if this alleged advantage is of great importance today when the plate-tailing goes to concentrating tables or is sent to a cyanide plant for further recovery. If once it can be established that amalgamation does not suffer by being placed in the re-grinding circuit or, at least, that the final tailing-loss is not increased thereby, then the continuance of the stamp to reduce ore from a crusher-product to a suitable fineness for amalgamation (20 to 35 mesh) is, to say the least, doubtful economy.

The arguments against the stamp are higher initial cost, more space, more power, and more water for the work it accomplishes than some of the other machines. The noise is also a feature that places the stamp in a class by itself. These disadvantages may not mean much in small mills, but in large plants they will mean a great deal in the end. The mill-men of California, nevertheless, have been loath to introduce any innovation that tended to lessen the vogue of the stamp and as a result single-stage stamp reduction is the practice, the stamp taking a crusher product and reducing it to 20-35 mesh. It required some courage, therefore on the part of the engineers who are responsible for the Plymouth mill. Here the stamps were pushed back to the position of a primary crusher and the grinding was finished by pebble-mills. The normal capacity of the stamp when reducing a crusher-product to 20-35 mesh is from 3 to 5 tons per day, but when reducing to a size suitable for a tube-mill feed the duty is increased approximately three times.

At the mill of the Alaska Gold, at Juneau, a much more radical departure was made from what was considered standard practice in precious-metal ore-reduction. Here rolls and tube-mills, instead of stamps, were installed and this within hearing distance of the roar of the falling stamps at Treadwell. The rolls, therefore, have supplanted the stamp as a primary grinder in what is, I believe, the largest gold-reduction plant in operation under one roof. This departure from conventional practice has probably done more toward sounding the

death knell to any future stamp installation on a large scale than any previous attempt to break away from standard method. Experience at the Utah Copper on the reduction of copper ores had shown that not only would rolls do cheaper work than stamps, but also that only about one-tenth the space was required.

That this method of reduction is more economical both as to initial and operating cost than stamps alone, or than stamps when working jointly with tube-mills and grinding to a like fineness, can no longer be questioned; the only way to explain the presence of stamps in some of the more recent mills is that it is only lately that the merit of some of these newer machines has been established and the tendency among conservative operators has been "to hear the ills we have rather than fly to those we know not of." It is, however, on the base-metal ores that the best work has been done in the development of grinding machinery especially fitted to give the product desired. It is only a short time ago when the practice at Miami was considered the last word in mechanical concentration. The desideratum sought in grinding copper ore precedent to water-concentration was to liberate as much of the mineral from the gangue in as coarse a state as possible. The aim was to avoid slime. Nothing was sent to the grinding circuit that had already been reduced to a suitable fineness. This necessitates stage-crushing and constant removal of the fine; also an elaborate system of classification and subsequent concentration of the different products on suitable tables. The losses were largely in slime, but with the successful application of flotation to chalcocite and other copper sulphide ores the necessity for maintaining the elaborate scheme of classification and concentration, entailing large initial outlays and heavy expense in attendance, was "knocked into a cocked hat." It is therefore quite natural that a great deal of work has been done of late in re-modeling or changing the operating methods of old machines to meet the requirements of new conditions. The aim now is to reduce the ore to the economic fineness, irrespective of the slime made in the operation, at the smallest cost. When fine grinding is necessary the machine that apparently meets this requirement best seems to be of the short tube or ball-mill type. It is generally known that the Marcy mill was chosen to do the work at the Inspiration. This mill takes a crusher-product about 2-inch ring and reduces the ore to 48-mesh, working in closed circuit with a Dorr classifier. A comparison between the work of the Marcy mill when charged with steel balls and the work of the conical or other short cylindrical mills when loaded with pebbles, would be of no particular value. Seven months ago I saw the Marcy mills in service at the Inspiration, and was much impressed by their efficiency. Much more recently I have seen the conical Hardinge mills in operation at Anaconda, both when using pebbles and when using steel balls. Unfortunately, owing to the widely different character of the ore, the feed going to the Hardinge conical mills at Anaconda is so different from that given to the Marcy mills at the

Inspiration that no comparison can be made as to their relative merit when using balls. At Anaconda the copper sulphides only make up a small portion of the total sulphide contained in the ore. Much of the sulphide is removed in as coarse a state as possible; this necessitates stage-crushing, making "the one easy step" reduction out of the question, as the different-size product from each stage of the grinding is sent over suitable jigs or tables for that particular product. The feed to the conical mills is therefore $\frac{1}{2}$ inch or finer, practically a normal tube-mill feed, but even on this feed it is believed that the capacity of the mills can be greatly increased by using steel balls instead of pebbles. The size of the balls in the various mills used will depend upon the size of the feed and perhaps also upon the hardness of the ore. At Anaconda it was found that 3-inch or smaller balls gave the best efficiency, while on mills taking a crusher product a 5-inch ball is usually employed. The success of the Marcy mills on a crusher-product in single-stage grinding has given a great impetus to other manufacturers of mining machinery to build a mill that will meet the requirements. Owing to the wide difference in the character of the ore in different districts, in many instances necessitating stage-crushing, there is hardly a likelihood of any one machine occupying the field to the exclusion of all other machines. There are, however, strong indications that the scope for mills of the cylindrical type will become much broader than at present and it would not be surprising to see mills of this type in the near future supplant the stamp not only on the American continent but also on the Rand. At any rate our profession will watch the work of the ball-mill with the keenest interest. Only recently an 8-ft. Hardinge mill was put in operation at the Dome. The mill was given 2-inch feed and its work will be practically parallel with that of the Marcy mill. When data are available, a comparison will be of especial interest. Much work has already been done in developing the ball-mill and much more work remains to be done.

Whether single-stage grinding in ball-mills will prove most economical when an all-slime product is desired or even whether the single-stage reduction is economically applicable to any kind of ore will bear further investigation. At any rate it would be hazardous at present to lay down arbitrary rules as to their best application to different ores. It is also quite possible that short tube-mills designed to carry heavy loads of small balls and using liners especially designed for this work will make inroads into the work of the pebble-mills. Ball-mills may be placed in tandem, one mill taking a crusher-product and discharging into a classifier in closed circuit with the second mill, where the fine is removed and the oversize delivered to a mill of proper design, charged with balls suitable for re-grinding.

As regards the question of length and diameter of tube-mills, I might say that in the early experiments at the Inspiration when an 8 by 5-ft. ball-mill was working in open circuit it was found that one of these mills would take an initial feed of 800 tons and reduce 51% of this

tonnage to 48-mesh. To reduce the remaining 49% of this tonnage to the required fineness was the problem. Two pebble-mills would do this without materially increasing the power, but the space required for one ball-mill and two pebble-mills was considerably greater than that occupied by two ball-mills alone. At any rate the ball-mill unit was chosen, and it is quite likely that economy in space and simplicity in operation played a more important part in reaching that decision than any advantages in the operating cost.

It will be of especial interest to know what can be done with steel balls in tube-mills. While this has been tried, I do not believe that the trials have been made under the most favorable conditions. It would be necessary to load the mills much heavier with steel balls than with pebbles and as a rule the motors used on tube-mills have no great excess of power. Furthermore, to obtain the best results in tube-mills when using balls, a liner similar to that used to advantage in the different ball-mills would be of decided advantage. The principle involved in grinding in any of the cylindrical mills is the same by impact and by trituration, and any advantage of one mill over another will, I believe, become a question of the liner used and the point of discharge. The speed of mills, the consistence of the feed, and the size of balls used will, of course, also play a part in the efficiency; but these adjustments can be made equally well on all types of cylindrical mills. If a tube-mill of large capacity should be developed using steel balls, it is then quite possible that the preliminary crushing in preparing a tube-mill feed can be done most economically in rolls or in Symons horizontal disc-crushers. It is claimed that these machines will take an ore of 2 to 2½-inch ring and reduce to ¼-in. ring at a cost not to exceed 4 cents per ton when employed in large-scale operations. But unless there is some decided advantage in cost, the single-stage grinding-unit should be preferred on account of its simplicity.

In fine grinding, one of the greatest difficulties is to keep from circulating a large proportion of material already sufficiently fine through the grinding apparatus. The various types of drag-classifiers, when working in closed circuit with cylindrical mills, will carry back to the mill for further grinding from 30 to 40% of material already fine enough. Just how much the grinding efficiency of a mill is reduced by circulating this fine stuff through it, I cannot say. Apparently the only way to make a clean separation is by screening.

Just how far fine grinding may be carried economically is a question to be determined by each mill-engineer for each ore. It would, however, seem that in some cases where very fine grinding is required to liberate the mineral, the fineness of the grinding might be greatly reduced by employing roughing tables of large capacity, returning the roughing product, containing included mineral, from these tables to the re-grinding equipment. This should be especially applicable to gold or silver-bearing sand preceding cyanidation.

Vistas Del Peru

By H. E. West

PERU presents an unprepossessing appearance from the sea. Roadsteads for harbors; sand everywhere; no green thing. A high fog obscures the sky and tempers the tropical sun. That mighty wall, the Cordilleras, parallels the coast. Toward noon the fog lifts and the sharp serrated combs and peaks stand revealed. We dropped anchor off Callao, the seaport of Lima.

Peru produces 64% of the silver of South America. As a producer it ranks sixth among the countries of the world, with 42%. The copper production in 1913 was 27,776 metric tons. The city of Lima, population 120,000, was founded by Pizarro, on the banks of the Rimac river in 1535; his remains lie within the cathedral he built, placed there in 1881. Pure Castellano is spoken in Peru. Lima, with its narrow streets and pavements, its overhanging latticed balconies, its many churches with deep-throated bells, breathes an air of sunny languorous Andalusia that still survives and charms. Those familiar with Mexico City instinctively feel a sense of affection for this southern capital. We ascended by the Ferrocarril Central de Peru, the highest railroad in the world, into the heart of the Cordilleras. This railroad was built in the days when Peru was rich and reckless, by that soldier of fortune, Henry Meiggs, of early Californian fame. At Tambaraque is the old smelter, now idle, that in its day made a fortune for its owner, a laborer who subsequently went bankrupt. At Rio Blanco is another smelter, apparently new, but never operated. The mines at Morococha, leased to Backus & Johnston, have been successful, paying off the receivership. These idle smelters at the gate-way of the Cordilleras are eloquent for caution in smelting, if not in mining in this Andean region. At Casapalea, at 13,600 ft. altitude, is an active smelter, whose curdling yellow and white fumes besmirch the clear mountain air. At 15,600 ft. the train has climbed to the roof of the world. From the summit through the *Tauel del paso de Galera* it is 32 miles to Oroya at 3500 ft. lower altitude. From Oroya it is 87 miles across the Junin pampa, where Bolivar whipped the Spaniards in 1824, to Cerro de Paseo, the largest copper-mining centre in Peru, at 14,300 ft. altitude. The Morococha mines, reached by a short branch-line from the summit are mostly controlled by the Cerro de Paseo company, though Backus & Johnston also operate mines in the district. At Casapalea, where are large deposits of copper, the Casapalea smelter produced 79,264 metric tons in 1913, mostly from ores of the vicinity and Morococha. At Huancayo are promising copper deposits and near-by at Antapongo, are lead veins, carrying almost pure galena but low in silver. Railroads are wanting to make this an important mining

and smelting centre. The average content of the Cerro de Paseo ore is said to be 4.7% copper; at Morococha the content is higher, averaging 8%; probably a smelter average would be 5%, with silver an ounce per unit. It is generally understood that \$20,000,000 was expended by the Cerro de Paseo company before any production was made. The first car of ore was shipped in August 1906. The mines had then been developed for five years. Additional capital has been expended in the development of other mines, as at Morococha. The present output is 800 tons per day. It is claimed that a 400-ton smelter at this high altitude has a capacity of only 250 tons, but by increasing the air-pressure at the blast-furnaces, smelting is improved. Cerro de Paseo is reputed to have the worst climate of any mining-camp on earth. Snow, hail, sleet, or rain is possible on any day in the year, and all may come during the same day. Thunder-storms resemble a combination of shrapnel and high-explosive shells.

Lack of transportation prohibits the development of many promising districts, not quite rich enough to stand the present excessive freight-charges. Mamas are serviceable for light service, but for any considerable tonnage rail-transport is essential. At 16,000 ft. near Arequipa are the celebrated silver mines of Calloma, from which the ancients extracted more silver, it is said, than from the famous hill of Potosi. The company has been reconstructed now for the third time, and several million dollars has been expended. A report by an English engineer states that the San Cristobal vein averages from 6 to 10 metres wide. The matrix is quartz and rhodonite. The silver in the ore, of which 150,000 tons is in reserve, occurs principally as polybasite. The ore is said to average 22 oz. per ton, raised by sorting to 30 oz. The deposits are stated to equal, if not surpass, those of Pachuca. The treatment proposed is to smelt the rich ore to a lead matte, and to concentrate and cyanide the remainder, extracting 85% of the silver and 90% of the gold at a cost of \$2.50 per ton on a basis of 3000 tons per month. The anticipated profit is \$5 per ton. Former treatment was by pan-amalgamation, roasting, and lixiviation with hyposulphite. The Carahuacra mine has a vein said to be 60 metres wide, containing zinc 25 to 30%, silver 20 oz., gold 0.02 oz. per ton. The mine is situated at Yauli near the railroad. It is under option to Beer, Sondheimer & Company.

The Salpo vein near Trujillo is noted for its rich gold and silver ores, several fortunes having been extracted from near its surface. The vein can be traced for 40 miles, and has been extensively worked. Small shipments are made on north-bound steamers. From reliable authority it is stated that 6 oz. of gold is necessary to

pay freight and treatment charges. The property is 42 miles from Trujillo, with rail part way and 30 miles by mules. By local treatment \$30 is required to pay expense. Surface ore only is adapted for local treatment,

pertenencia per annum cause many claims to be whittled down to small proportions, even one pertenencia. No monuments are erected nor any plat of such denouncements entered at the Recorder's office, so that confusion must result. A survey costs \$250. A semi-annual Government publication, '*Padron General de las Minas,*' gives the record of all denouncements, with the registered owners, and the standing of each claim. To the visiting engineer this information being authentic, is valuable.

From Huancayo, one fine morning, with mules and pack-horses carrying tent, army cots, blankets, and grub, we started for the hills. All went well until the last quarter-mile, which lay straight up a precipitous cliff, without the semblance of a trail. Traveling 18 miles, on a steep grade at 14,000 ft. altitude was all that man or beast could accomplish. That night we lay on the ground and looked at the



SWINGING BRIDGE OF CERCA DE JAUJA, PERU.

the sulphides having to be shipped outside. The main ore-shoot is 1000 ft. long and 20 ft. wide, averaging \$26 per ton. Unfortunately the lower adit has not yet disclosed the continuation of such a profitable ore-shoot; although sulphide ore equal to 7 oz. of gold has been encountered in small shoots, but these, it is claimed, will not pay to extract under the present high charges. Examples of shipping ores may be instanced: ore from the Calloma mine averages 300 oz. silver and 30 to 40 dwt. gold; the high-grade proustite ore 50% silver with 30 to 40 oz. gold; the silver-lead ore contains from 500 to 700 oz. silver, 24 to 29% lead, with \$3 gold. Precipitates from the hyposulphite process contain 16,000 oz. silver and \$170 in gold per ton, with 5 to 7% copper.

Extensive molybdenum deposits exist near Jauja, consisting of a ramification of small veins in quartz. The average content is stated to be 3 to 4%. The mining laws of Peru are well framed. Claims up to 60 pertenencias, or 240 acres, can be denounced. Taxes of \$15 per

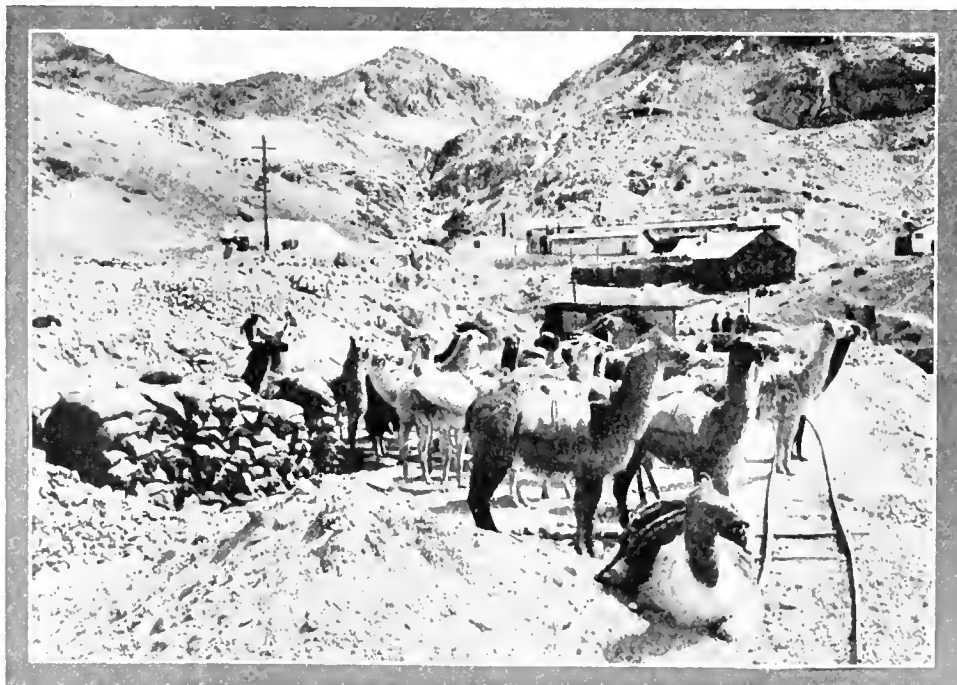

LLAMAS AT THE COPPER MINES OF MOROCUCHA.

stars. To sleep was impossible; to breathe almost as impossible; never did either of us put in such a night. There were minutes when my oxygen supply seemed cut off, and prospects of morning's light grew visionary. The *siroche*, or mountain-sickness, was upon us good and strong. All suffered, even the hardened pros-

pectors, and sometime during the night the camp dog started yelping with the pain and misery. The *siroco* is a malignant sickness, accompanied with fever and general debility, it lasts usually eight days, during which time the sufferer is quite incapacitated.

On the opposite side of the *quebrada* more trials awaited us steep mountain sides with dry slippery grass. My mule persisted in navigating the outside edge of such delectable trails, but never once did the faithful little animal stumble or trip. In places, however, I preferred to dismount and walk. Once, while descending a wicked trail, one of our pack-horses slipped and started to roll down the steep mountain side, heading for the *quebrada* below. Soon there was another object rolling after the first, which turned out to be the faithful Leonidas. It

with sleet and wind made the going unpleasant. The deposits visited were irregular bodies in limestone. The ancients had worked them, extracting oxidized ore of 20 to 40 oz. silver per ton. On returning to Huancayo we found a week of *fiesta*, for which time not a soul would leave the town for love or money. Peru was celebrating the 91th anniversary of its freedom. Bunting gaily decorated the one street. The flags of many nations assisted in commemorating July 28, the day of Independence. There were British flags, the Stars and Stripes, Japanese, Italian, Spanish, Turkish, German, Chilean, and Peruvian, not forgetting the five bars of the Republic of China. Truly a respectable showing for a *Cholo* town, high in the Andes. The streets were full of parades. A solemn *misa* was celebrated in the adobe cathedral. Spanish ladies in black mantillas, *schörilas* in white, civic authorities in frock-coats and silk hats, with the brilliant uniforms of the military, formed a charming picture. The last day of the feast was celebrated by a bull-fight. There were six bulls, all from local haciendas. The feast over and our guide reasonably sober, we set forth on what promised to be a hard trip. After examining several properties and passing a chilly night in our tent, we prepared an early start. At mid-day we had lunch at a sheep-herder's shack. After examining another prospect we returned to Lima.

On August 18 Doctor don José Pardo was inaugurated President of the Republic on the resignation of the provisional president. I was an interested spectator from the window of the Phoenix club. A dense crowd packed the plaza and massed against the palace. The trouble began when stones, supplementing former hisses and jeers, were hurled at the deposed president. Soldiers with bare swords ran amid the crowd and laid about them lustily. A group of officers surrounding the ex-president started shooting. A body of marines fronting the palace joined in and pandemonium broke loose. The crowd fled hotly pursued by the troops with sword and bayonet. Motor-cars and coaches were abandoned. When the shooting started the effect on the occupants of the club was electrical. With united consent all save one or two fell promptly to the floor, face-downward on the carpet. Being, on all occasions, strong on *la costumbre del país*, I lost no time in following such a lead, expecting the hail of bullets and the shattering glass to start *prontissimo*. Nothing happened. When next I looked forth the ex-president was walking past the corner of the club, in evening dress, attended by a few friends, perturbed but uninjured. A battery lined the street to his home, and soldiers closed all approach. As from the ground sprang Red Cross ambulances for the wounded. The most unfortunate incident was that of Doctor —, who sallying forth from the palace with the ex-president precisely as the marines joined in the fray, received a bullet in his *cabeza*, putting him out of business.

Next day we sailed from Callao, bearing kindly memories of Peru and the generous hospitality of which we were invariably the recipients, irrespective of creed or race.



PART OF SOUTH AMERICA.

was a funny sight, despite its seriousness, since all our grub was in the pack. Eventually, after several efforts, the animal stayed its tumbling flight in some short scrub, and, strange to say, appeared little the worse for the adventure. It is considered a most discreditable performance to lose a beast on the trail, so all were happy in escaping this indignity, not to mention the financial consequences involved. No fish live in these chilly waters. No beasts roam these grass-covered wastes. No birds float in the thin air, save the *gallinazos*, and, rarely, the great Condor of the Andes. Flowers, stemless with their faces close to the ground, charm the eye. The small star-shaped purple aster, the Shasta daisy, the blue gentian, the yellow dandelion, and the common white daisy—all crouching for protection in the mossy grass. Storms

Quicksilver Reduction

By Herbert Lang

INTRODUCTION. The metallurgy of quicksilver is simple, consisting in the reduction of a single ore, cinnabar, by means of a single and simple operation, distillation, yielding the metal in a state of almost absolute purity, ready to go into commerce at once. In this respect it can be compared with the means by which metallic—but not pure—gold is recovered from gravel deposits by washing, giving bars that are ready for the market, but are not yet ready for commercial uses; or with those by which the native copper of Lake Superior is won, namely, by crushing and then washing, getting a concentrate which, after a single fusion, produces excellent and salable metal. But mercury is even more simply extracted, and by a process for which seemingly there can never be a substitute. We may also compare its metallurgy with that of the industrial metals, lead, iron, copper, which involves a long series of laborious operations, and the application of concentration, roasting, smelting, refining, and perhaps flotation, before the metal reaches the necessary condition of purity fitting it for use in the arts. Most of the quicksilver of commerce is gained from the sulphide; most of the lead of commerce is gained also from the sulphide; and the same may be said of copper. The metallurgy of all three is practically the metallurgy of their sulphides, and the difference of their metallurgical treatment arises from the different behavior of their respective ores. It is my purpose to trace with some particularity these differences, and observe to what variations in practice they have led. In the opinion of most technical persons, the metallurgy of mercury is in a backward state as compared with that of the others cited; and this is in a certain measure true. They cite as evidence of this presumed condition the dearth of careful and thorough descriptions of processes, the lack of published analyses of quicksilver ores and products, the time-worn nomenclature used by the trade, wherein the output of the furnace is estimated in 'flasks' (a flask contains 75, 76, or 76½ lb., according to the place of production) and especially the want of those accurate accounts of mining geology and operation to which we have become accustomed in connection with the mining and treatment of the other metals. To these we may add the lack of such statistical information, in regard to cost and loss during treatment, as is indispensable when we would go about the task of devising improvements in the art, or suggesting methods borrowed from the later practice in the other branches of metallurgy. The reasons for this backward state lie, I presume, mainly in the simplicity of the reactions upon which the treatment depends, and largely, perhaps, in the economic condition of the trade, which shows little progress during these

years in comparison with that of the other metals. The quicksilver market has been held in comparatively few but strong hands of late years, and has suffered much from the lack of such stimulation as enlarged demands produce. A quicksilver 'trust' has been mentioned, and upon it we may lay a good part of the blame for these adverse conditions, since, as we know, the tendency of large producing and trading combinations is inimical to scientific progress.

As before remarked, the extraction of mercury from its ores is effected by a single operation, namely, distillation, by which it is transformed into the elementary condition, converted into vapor, and then, by the abstraction of heat, brought down in the liquid form in which we know it. How this is done and why this particular mode is adopted for the purpose will best appear if we consider briefly the properties of the prevailing mercurial compound, of the materials with which it is most commonly associated, and of the metal itself. The substances with which it is associated in the mine have some bearing on the matter of reduction, but they are not often of a character to interfere, except by adding to the cost of the operation. In no case does the mercury combine with any of the constituents of the ore at the moment of sublimation. The matrix of the ore (cinnabar) consists usually of altered country-rock, such as sandstone, schist, serpentine, with occasionally some minerals of clearly secondary origin, such as vein-quartz, or chalcedony; calcite, dolomite, etc. It is common also to find in the ore some sulphides other than that of mercury; of these the most common is ordinary iron pyrite, a substance somewhat prejudicial to the sublimation process, since its sulphur is expelled by heat and oxygen, and accompanies that of the cinnabar. Calcite and dolomite, both decomposable by the heat at which the ore is worked, are resolved into caustic bases of lime and magnesia, and are detrimental in the sense that much heat is unavoidably expended in their decomposition. I gather from an old print that it was the practice at certain European works, where the ore treated consisted of an evidently pure limestone or calcite containing a little quicksilver, to collect the latter as a by-product in lime-burning—that is, the mercury industry was subsidiary to lime production. This might very well be, as quicksilver furnaces in many cases are purely lime-kilns in form, and work as well on the one substance as on the other. The only essential difference between a kiln devoted to lime-burning and one built for the production of quicksilver consists in the apparatus of condensation necessary for the latter.

It would be perfectly feasible to combine the extraction of mercury with that of many other metals with

which it might be associated, and this is done in several instances. Zinc blende, for example, being found to contain in certain localities a small amount of mercury, this has been recovered from the fume set free in roasting the blende preparatory to its distillation for zinc. In a broader way one might conceive of mercurial calcite and dolomite as the proper flux for silicious smelting ores, as of copper and lead. Further, as a silicious mercurial ore would flux basic lead and copper compounds, the question broadens itself to include almost any ore of either metal that is found in convenient relation to some other. At one locality in Hungary tetrahedrite containing mercury up to 17% is mined, and the mercury saved, as is the copper. It does not appear, however, that the saving of the former is contingent upon smelting, since the practice is to roast the ore first, oxidizing the metallic compounds, and expelling the quicksilver at once. The interesting question of condensing quicksilver from smelter-fume does not, therefore, receive illustration from this source.

CHARACTER OF MERCURY. Metallic mercury, so striking as being the only metal that is liquid at ordinary temperatures, is in its everyday aspect sufficiently well known, but possesses properties that may escape ordinary observation. Everyone has noted its great weight; it is 13.59 times as heavy as water, and consequently far surpasses silver and even lead in specific gravity. Thus, roughly speaking, a pint of water will weigh a pound, a pint of lead $11\frac{1}{2}$ lb., and a pint of quicksilver $13\frac{1}{2}$ lb. The great density of the latter, taken in connection with its extraordinary mobility, has an important bearing on its metallurgy, as we shall see. The means that have to be employed to prevent its escape through minute cracks and crevices during reduction, and to hold it in transport, render it an exceedingly troublesome material indeed. Mercury freezes into a solid body at 40° below zero, becoming even more dense than before. It boils at about 670° F. above zero, becoming a vapor. In those respects it is similar to water, but possesses a greater range of fluidity; for, whereas water remains liquid through but 180° , mercury remains so for rather more than 700° , another fact of importance in its metallurgy. Its vapor is about seven times as heavy as air, but nevertheless diffuses itself in air and the products of combustion, from which it is difficult wholly to separate it. Mercury loses weight at all times when exposed to the air, and it has been found to give off a little vapor even in great cold. It is said that the frozen metal does so. This propensity renders it impossible to save quite all of the metal by any practicable method of condensation, although the loss from this cause is but small. These considerations must be kept constantly in view, as they have an immediate bearing on the designing of new or the improving of old plants. As an increasing amount of mercurial vapor is given off with increase of temperature, it follows that the metal might all be distilled without raising it to the boiling point of 670° F. This, however, would be a slow process indeed, and applicable only to the liquid metal itself, for where it is held in combination, as cinnabar, which is usual, a considerably higher heat

is needed to break up the compound. The absolute amount of heat needed to effect both objects, the decomposition and distillation, is not great. The specific heat of mercury is only 0.033, that is, 1/30 that of water, so that even if it all has to be raised to the boiling point or above, the heat required to do this is comparatively small. While the caloric energy developed by the fuel is great, that taken up in doing actual work on the quicksilver itself forms but a minute part of the whole output of energy. I have computed that in the case of a certain ore with which I am familiar, there is 400 times as much heat required to drive off the water as is needed to decompose and volatilize the mercury it contains. If to this we add the quantity necessary to raise the solid parts of the ore to the temperature of the outgoing gases and vapors, as well as that lost from the furnace by radiation, it will be seen that the useful work of expelling the mercury forms but a very small part of that consumed, probably not more than the thousandth part in this case, which is not far from the ordinary.

The great density of quicksilver vapor, which cuts down the space demanded for condensation, and the small amount of heat stored up by the vapor would seem to make the problem of condensation a relatively easy one, except for the fact that a small amount of the vapor remains in the products of combustion even after they are cooled down, not only below the liquifying point, but even to ordinary outside temperatures. For this reason we find mercury still present in the gases that have passed through many hundred feet of flues and have lost their initial heat almost totally. From this it will be seen that the complete recovery of the metal is practically impossible, and the aim in constructing a plant for this purpose is to save it without undue outlay for extensive collecting apparatus. By extending the flues and chambers and by applying water to their exteriors, so as to reduce the temperature, the recovery is made more and more perfect, but it is not practicable to preserve the final traces by any means now practised.

ORES. It was remarked above that mercury comes from the distillation of a single mineral, cinnabar, the sulphide. This is practically correct, although other mineral substances contain mercury, and from one or two of them it has been won in small quantities. As a general rule these secondary substances are of small economic interest, existing for the most part as cabinet specimens. Some native quicksilver is found, especially in the outcrops of mines, and shares the same treatment as cinnabar, from which it was derived by surface oxidation. The mercurial tetrahedrite, previously mentioned, exists in some few localities and has yielded a small amount of metal. Mercurial zinc-blende may be cited as of economic value, and occasional occurrences of mercury-bearing galena have been noted. One or two comparatively rare compounds of mercury with selenium are known to mineralogists, and there are such varieties of cinnabar as the hepatic kind, which occurs at Idria, Austria, and is said to furnish a considerable part of the output of that district. Meta-cinnabarite is the black amorphous variety of cinnabar, having the same composition, but requiring

no variation in the method of treatment. Native amalgam is rare; it is a compound of silver with mercury. Altogether we are justified in repeating that cinnabar is practically the sole source of quicksilver.

Cinnabar is distinguished among metallic sulphides by its high specific gravity (8.9 according to Dana) and by its volatilizing without chemical change at comparatively low temperatures, whereas the sulphides of the commoner metals such as lead, copper, zinc, require so high a temperature for their volatilization that that operation cannot be adopted in their metallurgy. Cinnabar is decomposable in either of two ways: by heating with some strong base, as lime or iron oxide, by which the sulphur is taken up, or by heating in air, by which the sulphur is oxidized to the form of di-oxide, while the mercury, not attacked by the air, is left in the metallic state. By either method the sulphur is removed and the 'quick' left in the elemental form; or, if the heat be sufficient, it becomes volatilized and may be condensed by itself. Both methods are employed in metallurgy, the air process predominating as being cheaper and lending itself to larger operations.

ASSAYING. The assay of mercurial ores and products is performed in a variety of ways, all of them simple and easy. Some operators make use of iron retorts, usually quite small, holding from 1 to 10 pounds of the ore, and provided with a long exit-tube cooled by water and dipping into a small receiver. The ore is mixed with lime, and is subjected to a red heat, by which the mineral is decomposed and the metal volatilized, to be collected in the water. This method is precisely that adopted for reduction in iron pipes or retorts as worked on a commercial scale. It is satisfactory, and is employed regularly by most companies that wish to keep track of their mining and reduction, but it is not so accurate as the more minute and probably better conducted operations of the skilled assayer, who works with smaller quantities but with more care and better facilities. The preferred method is known as the gold-plate method; it depends upon the fact that when gold is placed in an atmosphere of vaporized mercury it instantly becomes amalgamated, gaining weight in proportion to the amount of quicksilver absorbed. A small amount of the ore, usually one gram, is placed in an iron or clay cup, mixed with the proper quantity of lime or other base; a small plate or sheet of gold foil is laid upon the top of the vessel, making a tight fit, and a small capsule containing water is placed upon the sheet of gold. Heated to redness, the charge gives off mercurial vapor that immediately attaches itself to the under surface of the sheet. By weighing the sheet before and after the operation the amount of quicksilver contained in the ore may be determined. By heating the plate in the Bunsen flame the mercury may be driven off, leaving the sheet in condition for another assay. Nothing can be neater than this operation. Silver may be used instead of gold, and is said to answer quite as well. In good hands this assay will detect and weigh quantities as small as one pound of mercury per ton of ore. A favorite assay with some operators is performed in a glass tube, the charge being identical with that de-

scribed. One end of the tube, which is 8 inches long by $\frac{3}{8}$ inch diameter, is closed. The charge is placed in this end and the tube heated to redness, when the mercury is condensed in the cooler part. By breaking the tube and washing the condensed metal out with a jet of water it may be got into a porcelain capsule, collected into a globule by rubbing, dried with blotting paper, put upon the scale pan, and weighed. This also is accurate, yielding results comparable with the process just described. It is found that litharge, a strongly oxidizing substance, is more suitable than lime for the assay. Wet methods of analysis are far too laborious and complicated for use in the quicksilver industry and are rarely employed in America. By such means an absolutely pure specimen of cinnabar would be found to contain 86.2% of mercury, together with 13.8% of sulphur; but cinnabar, like all other economic minerals, is never quite pure, the usual content in metal running from 70 to 85%. In the assay, should the flux be left out of the charge, the cinnabar will volatilize unchanged in the absence of air and be deposited as a black sublimate, which turns red when rubbed. This is the so-called vermilion, much esteemed as a paint. This substance is produced also when the draft of the quicksilver furnace is suddenly turned off, while working in the large way.

CONCENTRATION. Several schemes for the wet concentration of cinnabar have been built upon the difference of the specific gravities of the mineral and those with which it is so commonly associated. Its specific gravity is 8.9, while that of chalcedony, calcite, serpentine, and almost all of the associated minerals, is less than 3, whence there is ample room for the application of familiar processes. The concentration does not appear to be especially difficult, but as the proportion of valuable mineral to waste is small it has been assumed by many that a close saving cannot be made, in spite of the fact that several such attempts have met with success. Cinnabar may be quite friable and soft, a mere stain upon the rock, or in solid masses of large size. Furthermore, the concentrate may be contaminated with pyrite. As this concentrate is inevitably fine-grained, its reduction must be continued in apparatus adapted thereto, whence the operation is debarred from the use of furnaces of the type that deal only with coarse material. It is found, as a general thing, that the costs and losses incurred in the combined processes of concentration and retorting exceed those incurred when the crude ore, no matter how low-grade, is treated in furnaces of the usual type, which work at extremely small cost per ton and volatilize the quicksilver almost completely. Very good furnace work is done at a cost as small as 50 cents per ton of crude ore, nor is the expense of handling crushed material in the so-called fine-ore furnaces appreciably greater. Now, as water concentration cannot be expected to save nearly as high a proportion of the metal as does the furnace, it would not appear that there is much opportunity for the profitable practice of wet methods.

FURNACES. The ancients were acquainted with mercury, but not, apparently, with the use of it. We read in the classics of cinnabar, and of the means by which it

was made to yield the metal, and we may surmise that quicksilver was first found native, but that during later centuries its extraction from the ores developed into an art, insignificant, of course, but following the lines, no doubt, along which we now work. It seems likely that the first efforts took the form, practised in later centuries, of pile roasting, so much followed in copper metallurgy, but now becoming obsolete. The pile or heap roasting of mercurial ores, though necessarily a crude and wasteful process, is not a difficult one, and requires little apparatus of any kind. In it the metal is both volatilized and then condensed in the same body of ore, the latter in the cooler parts near the surface. In carrying this out a layer of firewood is placed on the ground, upon which the ore, broken to the proper size, is placed, and the whole covered with fine stuff to control the rate of burning. The fuel being set on fire, continues to burn slowly, the heat rising gradually for some days, according to the size of the heap. The mercurial compounds being broken up by the action of air and heat, the mercury is volatilized, a portion escaping into the atmosphere, while another part condenses into liquid in the surrounding interstices of the pile. The heap is then suffered to cool, and the remains taken to be washed in tubs or sluices, the mercury being obtained in a state of purity. Out of this process, so primitive and wasteful, must have grown the present methods, which, so far as their chemistry is concerned, are identical with what I have described. The improvements consist in two principal things, the avoidance of the highly deleterious fume, and the transference of the condensation feature to fixed apparatus outside the heap. These alterations involve the enclosing of the roasting mass within walls impervious to the air and gases—in short, the provision of a furnace. We can easily imagine the earlier steps in the evolution of a modern quicksilver works, and for the later ones we have the evidence of writings composed within the last century, although these are for the most part mere repetitions, one author copying more or less faithfully what preceding ones had said. From these we gather that the course of invention has taken two directions, first toward the use of the cupola form of furnace for the reduction of coarse ore, second to the use of closed receptacles (retorts, muffles) for the treatment of finer material. The cupola has undergone many modifications, and the figures in textbooks betray a good many fanciful forms, arising from the whim of the inventor, or from local conditions. Two divisions of cupola practice are to be noted: first, the discontinuous method, in which the charges are introduced into the furnace, then heated, cooled, and discharged; second, where the process goes on continuously, fresh ore being introduced at the top while an equivalent quantity is withdrawn, spent, from below. The latter method has supplanted the former almost entirely. The commonest example of the discontinuous cupola is the Bustamente furnace, which consists of a vertical shaft, 25 ft. high by 6 ft. diameter, with a fire-place at the bottom, and provided with arches of brickwork above, on which rests the ore. This may consist largely of fine material, but in it there must be enough of comparatively

large fragments to afford interstices large enough to admit the passage of the flames from below. The use of these arches is a not uncommon expedient in such furnaces, since the slight draught, always what is called 'natural' draught in contra-distinction to that made by mechanical blowers, is insufficient to propel the gases through a body of fine ore, so that the process is checked. The expedient of applying blowing apparatus has made much headway of late years, and the best works are usually thus equipped, although the blast is light in comparison with that employed for copper, lead, and, above all, iron smelting. Among the numerous disadvantages of this type of cupola are the necessity for allowing the charge to cool before it can be discharged; the amount of labor necessary both for charging and discharging; and the time required for an operation, namely, a week, the quantity of ore treated reaching 50 tons. Another arrangement, once popular, consisted of a prismatic cupola, 20 ft. high by 4 ft. wide and 15 ft. long, which contained the charge of ore, held firmly between stout brick walls. A fire-place of the same height and length, but of only half the width, was built against one side, while a condensing-chamber of a size equal or greater stood against the other. Small holes in the brickwork allowed the flames to pass through the ore sidewise, while corresponding holes in the other wall led the fume, of which the volatilized mercury formed a part, into the condenser. The furnace-compartment being filled with suitably placed ore, the fire was lighted and the whole mass of ore and brickwork raised to a red heat and kept so until the process was adjudged complete. The structure and its contents were then allowed to cool and the spent ore removed. This method is open to the same objections as the other, and all contrivances of the sort have given way to continuously-acting furnaces, usually of the round cupola type, without interior shelves, except those for the treatment of fine ore, for which the internal shelves have been retained, but far more advantageously arranged. It has been found best to give up the idea of treating fine or mixed ores in the cupola shaft, and to make a decided division of processes, using the plain cupola for the coarser fragments and the shelf-furnace for finer stuff. In general practice those fragments that are above, say, two inches in diameter, are considered fine; while stuff larger than that is denominated coarse. It is true that some fine ore can be handled in the cupola, but only by admixture with enough of the coarser kind to prevent packing down and impeding the draught. Where there is too great a proportion of fine, as happens in many mines, especially where the ore-matrix is friable, it is considered good practice to crush the whole output and treat it in shelf-furnaces, of which several excellent forms have been invented and used in California and elsewhere. By the expedient of making the shelves sloping instead of horizontal, a continuous downward feed of the ore is assured, saving much hand-work, and rendering the process of roasting extremely economical and regular. With these improvements, in which the metallurgists of California have led the way, the roasting of fine mercurial ores has become almost as easy and cheap as the treat-

ment of coarse material. There is an alternative in that we can briquette the fine material, thus converting it virtually into coarse, in which case the upright cupola may be used exclusively. The preparation of briquettes, however, involves considerable expense, estimated generally at a dollar per ton, since a binding material, usually clay or clayey ore, must be employed, say, to the extent of one-tenth the weight of the ore, added to which considerable labor is required. When properly prepared the briquettes will withstand the abrasion of handling and that caused by the impact and descent of the materials in the shaft.

METALLURGICAL CONSIDERATIONS. As in the manufacture of lime, the cupolas may be heated either by an outside fire, the flames from which enter the furnace from the side, or by feeding the fuel with the ore, both burning in their descent. This matter is governed by the character of the fuel to be employed. When charcoal or coke can be had at reasonable cost, it is fed with the ore, but when wood or bituminous coal is to be used, the structure must be fitted with fire-places in which the fuel can be burned before the smoke and flames are allowed to pass into the charge. This is on account of the soot produced so copiously by the natural fuels, wood and coal, and which, as we shall see, tend to prevent the sublimed quicksilver from coalescing in the condensers. Charcoal and coke give off but little soot, tending to become burned wholly into the oxides of carbon, devoid of anything that would interfere with the aggregation of the mercury. This is an important feature. The ordinary plain cupola is operated with less fuel than any other type of quicksilver furnace, especially when internally fired. In this case little heat is lost by radiation, nor is there any mass of brickwork to be heated and kept hot. The minimum percentage of charcoal or coke consumed by it is stated to have been 5% of charcoal, by weight; while with outside-fired cupolas 12% of dried wood has been found sufficient. At this rate a cord of dry hardwood should calcine 13 tons of ordinary ore. Much, however, depends upon the composition of the ores, those containing a high proportion of volatile constituents requiring the most fuel. Water especially takes up a great deal of heat while being converted into steam, and the decomposition of calcite and dolomite is also wasteful. These carbonates are readily decomposable at the temperature of the quicksilver furnace (say 1500 F.) and a good deal of quicklime is found in residues. About 300 units of heat is required for the expulsion of the carbon dioxide from a pound of calcite, which would require the complete combustion of one-twentieth as much carbon, or say one-tenth as much dry wood. Water requires also a large amount of heat for its expulsion, including that absorbed, first by raising it from the ordinary temperature to the boiling-point, with that which becomes latent in the steam, and that taken up in raising the steam to the temperature of the upper part of the charge, which should not fall below the boiling-point of mercury, lest a part, at least, of that metal be condensed within the fresh charge, or, still worse, within the surrounding brickwork. The sum of these requirements on the part of water is no

less than 1330 heat units, equaling the amount of heat which would be set free by the complete combustion of carbon to the extent of nearly 9% of the weight of water contained in the ore.

The principal losses of heat from the cupola may be grouped under the following heads: First, through the decomposition of components of the charge; second, by radiation from the structure; third, by the sensible heat of the escaping gases and vapors; and finally the losses from the heat contained in the spent ore withdrawn from the bottom. It is impossible to estimate the extent of these losses in any known case, owing to the lack of reliable data. The first source of loss might be estimated, were the composition of the charge accurately known; but it is one of the chief drawbacks to a proper study of the whole subject that such data have never been published, and probably never compiled. The late Professor Christy thought that one-quarter of the weight of certain charges treated at New Almaden went off in the form of gases and vapors, and as two-fifths of the escaping matter consisted of steam, the average might have had a specific heat of about 0.35, whence we can compute that the total loss of heat from this source, the assumption being that their sensible heat reached 600°F., amounted to 94,500 heat-units per ton of charge. It would be even easier to calculate the loss occurring through the discharge of the spent ore, provided we knew its weight and temperature. Again, assuming the factors 0.22 for specific heat, and 300°F. for temperature, we find the loss of heat, due to the 1500 lb. remaining from each ton fed, to be 79,200 heat-units. It is, of course, impossible to estimate the loss by furnace radiation, a thing that depends upon too many factors to admit of computation; but I may state that in the smelting of copper in brick cupolas there is reason to believe that 6 or 7% of the heat generated internally, or supplied by the heated blast, is lost through the walls.

The presence of pyrite in quicksilver ores is not wholly detrimental, since it supplies a portion of the heat for distillation. Other sulphide minerals partake of this quality, though in a less degree. In places mercurial ores contain enough pyrite to enable the distillation process to proceed without the addition of any coal or other fuel, and whenever pyrite is present at all, it serves to contribute at least a portion of the heat. The sulphur is burned to di-oxide chiefly, a smaller portion perhaps to tri-oxide, which develops itself into sulphuric acid in contact with water. The iron would, in all probability, be converted into the magnetic oxide. Pyrite, when burned to sulphur di-oxide and to ferric oxide, has a calorific power one-third as great as that of coal, pound for pound. Such being the case, it would seem that a charge containing as much as 15% of pyrite should roast without the use of other fuel. Of all the forms of quicksilver furnaces, the simple cupola is the most economical of fuel, notwithstanding the loss of heat; it is especially more economical than those constructions known as discontinuous furnaces, of which the retort-furnace is the most wasteful of fuel.

In the retort-furnace the flames from the fire-place do

not come in direct contact with the ore, but heat it by conduction through the walls of a receptacle (retort) in which it is placed. It follows from this that the gases of combustion do not intermix with those driven from the ore, a fact having an important bearing upon the condensation of the quicksilver in the latter. Heating in this way is wasteful of fuel, and only permits of small quantities being acted upon at once; whence the capacity of such furnace is very limited. The retorts in common use do not hold more than two or three hundred pounds of ore at the most, nor can the work be hurried, since the transfer of heat through the walls is slow. All ores being bad conductors of heat, it has been found inexpedient to make the retorts of a greater diameter than 15 to 20 inches, and they are generally smaller, their small size adding greatly to the cost of charging and discharging. They are only adapted to comparatively fine and rich material, since the expense of working is too great to permit the treatment of low-grade ore. Retorts are ordinarily made of cast-iron and are of cylindrical or semi-cylindrical form, the latter closely resembling the vessels used in the preparation of illuminating gas from coal. A number of retorts, usually two to ten, arranged in parallel are set in or over a single fire-place, the structure being termed a 'bank' or 'bench.' An operation that includes charging the vessels, heating, and discharging them, consumes fully 10 hours; so that even the largest plants of this kind can scarcely treat more than two or three tons in a day of 24 hours, and at an expenditure of labor and fuel incomparably greater than when cupolas are employed. The extraction of mercury is less perfect than in cupolas, and they are usually run only as a makeshift until better apparatus can be installed. In spite of an improvement, taking the form of an inclined muffle (Fitzgerald's furnace) which permits of continuous feed and discharge, furnaces of this general type seem doomed to extinction. Those of the reverberatory type have been used for quicksilver, especially in foreign countries, in spite of manifest disadvantages, among which the excessive consumption of fuel and the production of a great volume of smoke are the most conspicuous. The principle of the reverberatory is the heating of the charge by reflection of heat downward upon the ore in a layer beneath. The ore is fed into the end farthest from the flames and is drawn forward by hand-tools, getting progressively hotter and hotter until it arrives at a point beyond the space of maximum heat, to be discharged finally. Only comparatively fine material is adapted to this treatment, and the quantity handled is not large. A modification of the flat-bedded reverberatory—the Livermore furnace—had some vogue in this State in former years, and possessed points of interest, especially in the inclined arrangement of its bed. The inclination was such that the ore, introduced at the upper end, followed down a series of parallel grooves in the bed and was discharged by gravity at the bottom. The flames playing over the surface heated the ore to the required temperature. Since this involves less labor than the ordinary form of reverberatory it is more likely to have imitators in a country where wages are high.

The fuels proper for reverberatory and retort furnaces alike are the long-flaming sorts, such as wood, bituminous coal, and petroleum. In the reverberatory there is ample opportunity for the complete combustion of the fuel, without the production of soot and tar, which are unavoidably formed when wood and bituminous coal are burned in a confined space, as in a cupola.

CONDENSATION. The smoke of quicksilver furnaces in which the products of combustion of the fuel are intermixed with those derived from the ore itself contains sundry constituents that affect the subsequent process of condensation. The principal are nitrogen, derived from the air; carbon dioxide, derived from the fuel and sometimes in part from decomposed carbonates; carbon monoxide; water-vapor, derived from both ore and fuel; tar and soot, derived from the fuel generally, but sometimes in part from hydrocarbons contained in the ore; the vapor of mercury; and solid particles (flue-dust). The mercurial vapor usually constitutes but a small part of the whole, but its condensation and preservation render necessary the cooling of the whole, whereby not only the mercury but the tar and water also are condensed, adding much to the cost and complexity of the process, the incidental condensation of the sulphur gases increasing the difficulty.

When mercury is stirred with such materials as grease, sugar, sulphur, oil, etc., the liquid metal is converted into a gray powder, called 'floured' mercury or 'deadened' mercury. It may be brought again into the liquid form by rubbing. The mercury exists in this powder in globules said to measure only one twelve-thousandth of an inch. The same effect is produced by the soot given off in burning the fuel in a furnace; this accompanies the mercury into the condensers, flours it, and renders it more difficult to save. The mercurial soot in such a case is treated in a variety of ways, as by working with a tool, mixing with ash, or lime, and by pressing; after which the remaining sooty mixture, still containing some mercury, is sent back to the furnace to be re-sublimed. The treatment of mercurial soot is an important part of the technique of quicksilver reduction.

Some means of condensing the quicksilver vapor has to be employed in connection with every quicksilver furnace, whatever its type. Various means of getting the mercury into the liquid form are practised, all based upon the abstraction of heat from the funne (smoke, gas, vapor) whereby some of the various constituents are brought below their dew-points and settle in drops. Among those that condense is mercury itself, which is very easily brought down: so easily, in fact, that it begins to condense within the furnace, at points that do not reach a temperature above the boiling-point of the metal. But since the vapor of mercury on cooling forms small globules—a mist—which to some extent remain suspended in the air, and since also a portion remains quite uncondensed in air at all temperatures, the problem of condensation becomes intricate. Furthermore, other smoke constituents become condensed at the same time, intermingling with the mercury and adding to the cost of its recovery. It is apparent that the whole volume of

smoke requires cooling, so that the problem becomes one of no small moment in the case of all furnaces and especially open ones, where the products of combustion are allowed to mingle with the mercurial vapors. The apparatus of cooling is diverse in character, but all systems are capable of being classified either into (1) cooling by atmospheric air; (2) cooling by water; or (3) cooling by means of ore. The last has been used in a limited way, and consists merely in placing the cold ore in a layer on the iron top of the hottest condensing chamber, whereby it becomes dried and warmed, while at the same time the temperature of the chamber beneath is reduced in like degree. Or, boxes for the temporary reception of the ore are sunk within the chamber, producing the same result. This method is scientific in that the heat abstracted from the smoke is returned to the furnace. It would not be practicable to carry it so far as to cool the smoke of open furnaces to the condensing point, as will be seen.

Cooling by atmospheric air involves the conduction of the heat of the escaping gases and condensing matters through the walls of the flue or its enlargements (chambers) and its dissipation in the surrounding air. This would not be difficult were it practicable to employ materials of good heat-conducting powers for the construction. Sheet-iron would be the obvious choice, but owing to the character of the smoke, it is impracticable to employ iron or indeed any other metal. All mercurial ores contain at least a little sulphur, namely, that combined with the quicksilver, and most of them contain a larger quantity held in the pyritic minerals, all of which give it off in the furnace, forming, as before said, the di-oxide and tri-oxide of sulphur, the latter of which, on meeting water-vapor unites therewith, forming sulphuric acid, which is most corrosive, acting readily upon wrought-iron and steel, and more slowly on cast-iron. As these effects are accentuated by the presence of moisture, an ever-present concomitant, it cannot be expected that chambers composed wholly or partly of rolled metal in sheets or plates will endure; and experience shows them to be practically worthless. However, cast-iron, which may be had in thick plates, has found some use in the bottom of such chambers, for which it is well fitted, owing to the ease with which mercury-tight floors may be made. In such places plates two inches thick and upward have been found to last for two years or more, even when the acid solutions settled directly upon them. When kept dry, as happens when the temperature is so high as to preclude the condensation of the vapors on their surfaces, even wrought-iron and steel sheets are unaffected, as is also shown in the good preservation of boiler-tubes heated by the exhaust-gases of copper and other furnaces that contain oxides of sulphur. These facts suggest some modifications of the present construction of mercury condensers.

Lead, while unaffected or but slightly affected by the sulphur gases, is quickly amalgamated by the mercury itself; hence is inapplicable. Either from one cause or another, and from their too great cost, all other metals have been found inapplicable, and the main reliance

has been masonry work for the condensing apparatus, supplemented by earthenware tubes, and in California the use of wooden or wood and glass constructions, of which the best examples are found at New Almaden. Masonry and brickwork are objectionable in that they are poor conductors of heat; the gases, after passing through successive chambers of great size, still remaining hot, and requiring further cooling by means of long

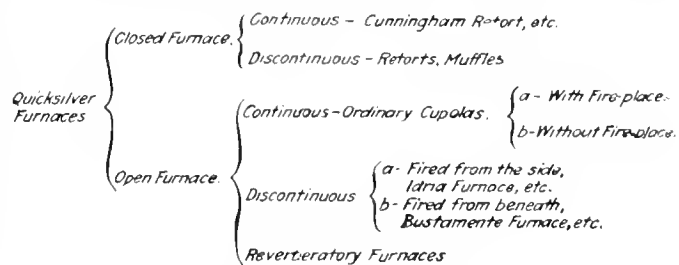

CLASSIFICATION OF FURNACES.

flues, tubes, etc., before being discharged into the atmosphere. It often happens that the first chamber is so hot as to collect no quicksilver at all. Again, they tend to absorb the metal in the interstices, and furnaces have been run for days and weeks before the pores were so filled as to allow any mercury to appear on the floor, where it should be found. Nevertheless, they are the mainstay of the process as generally conducted. Wooden constructions possess the merits of being cheap and of being resistant to acids. Thin boards are used, which, although poor conductors of heat, lend themselves to

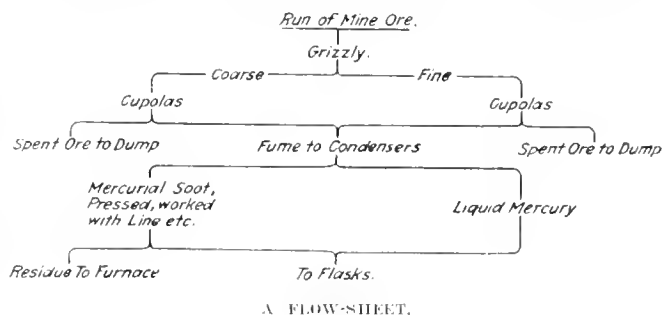

A FLOW-SHEET.

fairly efficient uses. When combined with glass they are unsurpassed in efficiency. The glass is ordinary window-glass, set in panes in the wooden framework. It is superior to any other material, since the internal heat is not only conducted but is radiated from the interior outward. Experiments have shown that 80% of the heat rays striking normally on glass panes pass through. Chambers of this kind, therefore, cool the gases far more readily than any other construction that depends upon atmospheric cooling.

In retort-furnaces, where, as before said, the mercurial vapors are unmixed with combustion gases and are therefore far less bulky, they are condensed by simple means. It is only necessary to provide a fairly long pipe, which may be cooled by the flow of water. At times even this water-cooling is discarded and the pipe so arranged as to dip slightly into water at its extremity, the condensed mercury flowing down the tube and collecting in a trough just below.

The use of water in this way to cool the mercurial fume has been practised in many localities, as supplementary to air-cooling. In some cases water-boxes of cast-iron have been built into the roofs and walls of the condensing-chambers, while in others sprays have been used, playing upon iron surfaces, particularly the roofs, with great effect. It is rarely, however, that the water has been introduced directly into the stream of gas, where it would be most effective, chiefly, no doubt, because of the soot and minute globules of metal that it would be supposed to carry off. There is no question, however, that with suitable means for filtering the liquid, this source of loss could be obviated, when builders would be free to utilize water-cooling to its full extent. Water-cooling has undeniable advantages over air-cooling, especially in the lessened extent of surface necessary, and the consequently cheaper and smaller constructions. It would seem possible in this way to reduce the cost and size of the condensing arrangements, probably to one-fourth of that now considered necessary, and at the same time reduce to almost nothing the absorption of mercurial metal into the walls. This would involve the use of a liberal amount of water, with provision for its filtration to remove suspended matter, the cooling of it, and its return to the chambers. The liquid would no doubt become contaminated with sulphur oxides, which, after a time, would render it acid and compel disuse; but it would be feasible to neutralize the acid, by means of limestone, or in some cases by the burned lime or dolomite so often found in the spent ore. Considering the great capacity for heat that water has, there should be no difficulty in devising apparatus to carry out this purpose in far less space than is now considered essential.

Perhaps the most rational way to employ air-cooling consists in passing air through a series of tubes contained in the hottest part of the first chamber, and then leading it to the furnace, by which a supply of pre-heated air is obtained to aid combustion, and at the same time the smoke is cooled to some extent. Tubes containing water act still more effectively, and it would seem practicable to heat the boiler feed-water in tubes so placed, thereby intercepting heat that would otherwise be lost, and so conserving fuel that would otherwise have to be burned to produce power. We can proceed thus far with economy and actual benefit to the process. Beyond this the heat abstracted from the gases would have to be wasted, for whether it be taken up by the outside air or by the cooling water it would ultimately be for the sole purpose of cooling the smoke, and would then be bestowed upon the surrounding atmosphere, as indicated.

Strong inducements exist for the wholesale application of water to cool and condense the gases of quicksilver furnaces, the chief of which lies in the possibility, even the ease, of condensing the mercury in apparatus occupying small space as compared with that in common use. Such apparatus would not differ in form from that used in a variety of arts, where it is necessary to purify the smoke of other metallurgical works, particularly where sulphur fume is evolved. Towers filled with coke, quartz, or acid-resisting bricks or tiles are

common in such industries, and their capabilities are well understood. The spraying of fume much more corrosive than that evolved from mercurial ore is done successfully, and even the application of caustic lime, zinc oxide, and other absorbents for neutralizing deleterious gases is becoming common. With all this wealth of invention and experience at the disposal of the quicksilver metallurgist, it would seem strange if the cumbersome methods of the past do not soon become in a manner obsolete. In this connection I may remark that metallurgists will do well to ponder the advantages of such new inventions as Cottrell's device for precipitating certain constituents of smelter smoke, such as fine solid particles, sulphur tri-oxide, etc., with much success. Apparently this invention should succeed admirably when applied to quicksilver condensation. Evidently it would take the place of constructions that involve the principle of sedimentation, found important in this art. This implies the use of extended surfaces of contact, the object of which is to throw the mercurial globules by the influence of contact alone.

DISEASES CAUSED BY MERCURY. The important matter of the effects of mercury upon the animal system, and especially upon the health of humans, demands strict attention. The breathing of mercurial fumes, and even the prolonged contact of those ores and compounds with the human body, whereby small amounts are absorbed into the system, produces consequences so grave that the utmost care must be observed both by the workmen and those in charge of the operations to lessen the danger of contamination. Mercury acts prejudicially upon the nervous system, it impairs the digestion, it injures the motor functions, it impoverishes the blood, and produces, or at least predisposes to, scurvy and scrofula. These and other ill effects are so common among workers that for a long time they were supposed to be unavoidable and were taken as a matter of course; and it is only of late years that, the cause having become understood, they have been prevented. Perfect cleanliness is enjoined as the best preventive, but such additional safeguards as acid foods and avoidance of alcoholic drinks are also insisted upon. Since it is supposed that the mercury taken into the system exists there in the soluble form, it has been suggested that the use as medicine of such chemicals as would naturally tend to render it insoluble would be indicated; and for this purpose potassium iodide is recommended. Other physico-chemists have maintained that the potassium chlorate might act as beneficially. Probably the most effective means of preventing mercurial disease consists in adding suction apparatus to the plant, by which the draught is inward at all points throughout the chain of furnaces, condensers, and flues, thus preventing the escape of vapors until the exit-chimney is reached. A further great improvement tending to the same happy result consists in so designing the works that the handling of the spent, but frequently hot and smoking, ore shall be reduced to a minimum. Little attention has been bestowed upon this feature, and in works now running we see men engaged in raking the dangerous stuff from the furnaces.

Soap as a Frothing Agent in Flotation

By M. H. Thronberry

MANY attempts have been made to use soap as a frothing agent in flotation. These attempts have been on the whole unsuccessful; and oil has come to be considered pre-eminent among substances that can produce frothing. At the present time the price of frothing-oil is increasing; and, in consequence, some of us decided to see if soap could not successfully replace oil as a frothing agent.

In solving this problem I am indebted to H. T. Mann, Associate Professor of Metallurgy in charge of the department in the Missouri School of Mines, for his many helpful suggestions. Carl Stifel, a student in the same institution, also helped by doing a great deal of the preliminary work.

In order to be able to calculate the exact quantity of the frothing agent used in each charge, a solution was made by dissolving five grams of a given soap in water and adding water until the final volume of the solution was 500 cc. The ore used was galena in a dolomite gangue, assaying 5.03% lead. A screen analysis of the ore gave the following results:

| Mesh | Average size | | Lead % |
|-------------------|--------------|-------|--------|
| | Mm. | % | |
| On 65 | 0.251 | 0.75 | 10.03 |
| " 100 | 0.177 | 7.50 | 7.96 |
| " 150 | 0.125 | 18.25 | 4.93 |
| " 200 | 0.091 | 20.75 | 3.55 |
| Through 200 | | 52.75 | 4.87 |

Before running any charges in a machine, a series of preliminary tests was made of all the oils in stock in

order to classify them as 'frothing' and 'non-frothing.' After this classification was made, a number of experiments were performed with the selective oil that was best suited for this ore as a collector of the lead and that at the same time did not interfere with the frothing agent.

A Minerals Separation machine built in the School shops, after the model described in the *Engineering & Mining Journal* of September 4, 1915, was used in this work. The machine differed from the model in the following particulars: The agitation-box was made three inches higher to prevent splashing. The impeller has two agitators, one placed about two inches above the other. A glass plate two inches wide by six inches long was placed in each side of the spitzkasten for the purpose of judging the height and nature of the froth.

The charge for each experiment consisted of 800 grams of the ore in 3200 cc. of deep-well water. This water carries a large percentage of lime and magnesia. After the charge of ore and water was put into the machine, it was agitated for a few minutes, then 0.5 cc. of oil from crude water-gas tar was added, and the agitation continued for five minutes, after which just enough soap solution was added to form a good froth. The froth that formed during the first 30 minutes was removed and called the 'concentrate.' The charge was then re-oiled and, if necessary, more soap solution was added. During the remainder of the run the froth collected was called a 'middling' product. The results of these tests are shown in the following table:

TABLE I

ORE. Dolomite and galena; assay = 5.03% Pb.
 OIL. Kind, oil from crude water-gas tar; amount used, 0.9 cc.; pounds per ton, 2½.
 OPERATING DATA. Time = 45 minutes; amount of water = 3200 cc.; amount of ore = 800 grams; speed of machine = 1700 r.p.m.

| Test No. | Soap | | | Concentrate | | Middling | | Tailing | | Extraction | |
|----------|----------|-----------|-----------------|-------------|--------|------------|--------|------------|--------|------------|----------|
| | Lab. No. | Am't. Cc. | Oz. Av. per ton | Weight Lb. | Lead % | Weight Lb. | Lead % | Weight Lb. | Lead % | Apparent % | Actual % |
| 1 | 1 | 10.0 | 4.0 | 18.65 | 79.40 | 18.85 | 58.50 | 720 | 1.03 | 80 | 64 |
| 2 | 2 | 12.0 | 4.8 | 16.67 | 78.20 | 20.14 | 49.50 | 737 | 1.28 | 76 | 57 |
| 3 | 3 | 3.7 | 1.5 | 18.60 | 79.00 | 22.52 | 51.00 | 732 | 0.86 | 84 | 68 |
| 4 | 4 | 1.5 | 0.6 | 16.40 | 75.50 | 13.30 | 72.30 | 730 | 1.43 | 73 | 55 |
| 5 | 5 | 9.0 | 3.3 | 16.45 | 78.30 | 10.85 | 69.50 | 732 | 1.48 | 72 | 50 |
| 6 | 6 | 5.0 | 2.0 | 10.60 | 78.20 | 10.95 | 69.60 | 761 | 2.37 | 55 | 49 |
| 7 | 7 | 5.0 | 2.0 | 16.50 | 77.40 | 12.50 | 63.72 | 747 | 1.48 | 62 | 51 |
| 8 | 8 | 1.0 | 0.4 | 13.70 | 78.80 | 16.65 | 70.93 | 745 | 1.43 | 74 | 56 |
| 9 | 9 | 9.0 | 3.3 | 14.70 | 79.90 | 11.20 | 76.20 | 750 | 1.66 | 68 | 54 |
| 10 | 10 | 3.0 | 1.1 | 13.20 | 80.00 | 14.60 | 71.00 | 745 | 1.58 | 70 | 52 |
| 11 | 11 | 3.0 | 1.1 | 16.00 | 79.50 | 10.80 | 72.10 | 750 | 1.86 | 65 | 51 |
| 12 | 12 | 9.0 | 3.3 | 16.30 | 78.80 | 14.10 | 72.20 | 745 | 1.52 | 71 | 57 |
| 13 | 13 | 2.0 | 0.8 | 18.70 | 79.00 | 14.30 | 75.40 | 742 | 1.58 | 70 | 61 |
| 14 | 14 | 3.0 | 1.1 | 21.00 | 83.40 | 14.30 | 73.10 | 750 | 1.43 | 75 | 69 |
| 15 | 15 | 8.0 | 3.2 | 15.20 | 79.50 | 9.00 | 73.50 | 755 | 2.12 | 60 | 45 |
| 16 | 16 | 10.0 | 4.0 | 19.60 | 79.80 | 9.80 | 76.40 | 750 | 1.16 | 80 | 57 |
| 17 | 17 | 4.0 | 1.6 | 15.40 | 78.50 | 8.00 | 71.80 | 750 | 2.04 | 61 | 45 |
| 18 | 18 | 8.0 | 3.2 | 17.40 | 82.90 | 11.40 | 72.00 | 760 | 1.68 | 68 | 54 |

TABLE II

| ORE | | Same as Table I | | OPERATING DATA | | Same as Table I | | OIL—Kind, oil from crude water-gas tar; amount, 0.9 cc.; pounds per ton, 21. | | | | | | | |
|----------|----------|-----------------|-----------------|----------------|--------|-----------------|--------|--|--------|------------|--------|------------|----------|--|--|
| Test No. | Lab. No. | Soap | | Concentrate | | Middling | | Washing | | Tailing | | Extraction | | | |
| | | Am't. Ce. | Oz. Av. per ton | Weight Lb. | Lead % | Weight Lb. | Lead % | Weight Lb. | Lead % | Weight Lb. | Lead % | Apparent % | Actual % | | |
| 1 | 1 | 10 | 1.0 | 17.60 | 78.2 | 19.5 | 57.6 | 31 | 12.32 | 715 | 0.61 | 88 | 62 | | |
| 2 | 3 | 3 | 1.2 | 18.65 | 79.3 | 23.5 | 52.0 | 37 | 11.50 | 697 | Trace | 99 | 68 | | |
| 3 | 10 | 3 | 1.2 | 14.35 | 80.5 | 15.7 | 71.0 | 28 | 17.50 | 731 | 0.72 | 86 | 57 | | |
| 4 | 14 | 3 | 1.2 | 23.00 | 82.7 | 16.1 | 72.2 | 32 | 12.70 | 616 | 0.32 | 89 | 76 | | |

The apparent extraction was calculated as follows:

- H = percentage of lead in heading.
 C = percentage of lead in concentrate.
 T = percentage of lead in tailing.

$$\frac{C(H - T)}{H(C - T)}$$
 Apparent extraction.

The actual extraction was calculated by finding the grams of metallic lead in the concentrates and middlings; adding these results and finding what proportion this was of the metallic lead in the feed.

The recovery in all cases is lower than it should be, owing to the fact that the machine is constructed of wood, so that oiled sulphides cling to the sides. When the tailing is withdrawn and the machine washed out these sulphides go into the tailing, thereby increasing the percentage of lead in this product. Table II shows to what extent this factor influences the final results.

A composite sample of the tailings from runs No. 1 to 18 was taken and a screen analysis made of this product to determine where the losses were, as follows:

| Mesh | Average size | | Lead | |
|-------------|--------------|-------|----------|--------|
| | Mm. | % | Weight % | Lead % |
| On 65 | 0.251 | 1.04 | 10.20 | 6.00 |
| 100 | 0.177 | 7.40 | 2.68 | 1.54 |
| 150 | 0.125 | 14.32 | 1.18 | 0.68 |
| 200 | 0.091 | 18.32 | 0.68 | 0.41 |
| Through 200 | | 58.92 | 0.41 | 0.25 |

Comparing this analysis with that of the original ore, it is very evident that practically none of the material on plus 100-mesh floated. Hence, the conclusion is that

the concentrates were made up of minus 100-mesh material, and that this high tailing is due to the coarse lead remaining.

In order to check the above statement, a portion of the ore was re-ground and passed through a 150-mesh screen of 0.104 mm. opening. Four tests were run on this material. The results are shown in Table III.

The following points are noticeable:

1. The amount of oil and soap required is less than for treating the coarser material.
2. The weight of the concentrate is greater but it contains more gangue.
3. Less lead was left in the tailings.
4. The percentage of recovery is higher.

A few experiments were made to determine the effect of an excess of soap. Table IV shows these results.

The following conclusions are drawn:

1. That soap can be used as a frothing agent in the flotation of galena, when used in combination with a suitable selective oil.
2. A small amount of soap must be used in a frothing agent, for when used in large quantities the gangue floats with the concentrate.
3. The lead in the tailings is due to two things:
 - (a) The oiled sulphides stick to the sides of the machine and are washed into the tailings. This would not occur in continuous operation, but is of interest in tests.
 - (b) The material floated is principally of minus 100-mesh, the coarse material going into the tailing.

TABLE III

| ORE | | Same as Table I. All through 150 mesh; 0.104 mm. opening. | | OPERATING DATA. Time = 1 hour; amount of water = 3200 cc.; amount of ore = 800 grams; speed of machine = 1700 r.p.m. | | | | | | | |
|----------|----------|---|-----------------|--|--------|------------|--------|------------|--------|------------|----------|
| Test No. | Lab. No. | Soap | | Concentrate | | Middling | | Tailing | | Extraction | |
| | | Am't. Ce. | Oz. Av. per ton | Weight Lb. | Lead % | Weight Lb. | Lead % | Weight Lb. | Lead % | Apparent % | Actual % |
| 1 | 1 | 2.0 | 0.8 | 24.9 | 72.6 | 19.9 | 58.5 | 728 | 0.17 | 96 | 74 |
| 2 | 2 | 3.5 | 1.3 | 25.4 | 70.4 | 19.9 | 57.5 | 732 | 0.66 | 88 | 65 |
| 3 | 3 | 1.5 | 0.6 | 23.6 | 71.2 | 20.5 | 65.2 | 730 | 0.71 | 87 | 75 |
| 4 | 4 | 1.0 | 0.4 | 28.4 | 74.4 | 14.2 | 57.7 | 734 | 0.49 | 91 | 67 |

TABLE IV

| ORE | | Same as Table I. | | OPERATING DATA. Same as Table I. | | OIL—Kind, oil from crude water-gas tar; amount used, 0.9 cc.; pounds per ton, 21. | | | | | |
|----------|----------|------------------|----------------|----------------------------------|--------|---|--------|------------|--------|------------|----------|
| Test No. | Lab. No. | Soap | | Concentrate | | Middling | | Tailing | | Extraction | |
| | | Am't. Ce. | Pounds per ton | Weight Lb. | Lead % | Weight Lb. | Lead % | Weight Lb. | Lead % | Apparent % | Actual % |
| 1 | 1 | 20 | 0.5 | 35.0 | 31.50 | 37.5 | 18.26 | 705 | 2.87 | 47 | 45 |
| 2 | 3 | 25 | 0.5 | 40.5 | 22.30 | 45.6 | 6.71 | 683 | 3.12 | 44 | 30 |
| 3 | 9 | 40 | 1.0 | 52.0 | 7.62 | 47.3 | 4.28 | 687 | 4.21 | 36 | 15 |
| 4 | 12 | 40 | 1.0 | 56.0 | 7.81 | 42.5 | 4.12 | 675 | 4.37 | 30 | 15 |
| 5 | 14 | 60 | 1.5 | 73.0 | 6.25 | 52.5 | 4.07 | 653 | 4.52 | 37 | 16 |

Mining in Utah

By L. O. Howard

The mining industry has never been more prosperous. Regular producers are increasing shipments steadily and the smelters are operating to capacity. High metal prices have enabled many old producers to resume. The coming of spring has stimulated state-wide activity, and no one district has a monopoly of interest. With the product of the Utah Copper Co. sold months ahead, the increasing demand and price for lead ores, the long-delayed rise in silver, operators are well content. There have been some shipments of tungsten ore. A few cars of manganese ore have been shipped from Emery county, and in the Tintie district the Chief Consolidated has started production of manganese from its property in Homansville, and expects to make some large shipments in the near future. There is a slight increase, even, in the activity in the radium districts, some of the producers having sold a little ore to the Government, and a few independent buyers taking small lots at prices 25 to 33% less than before the War. Developments in potash follow one another rapidly. Two strong companies are at work at Marysvale, two others are at work on the brine of Great Salt lake, and the Pennsylvania Salt Co. is reported to be backing an enterprise looking to the extraction of aluminum from the alunite of Marysvale, but no authentic data can be obtained as to how this is proposed to be done. Ozokerite production has been begun by one plant in eastern Utah. There is even a mild interest in drilling for oil in southern Utah. The seasonal dullness in coal mining has arrived. The principal development of interest to coal operators was the final decision of the Secretary of the Interior awarding title to 4160 acres of coal land in Emery county to the Freed estate. Six years ago patent to this land was denied on the ground of fraud and indictments were secured against some prominent coal-men and mining attorneys. Final vindication of these men has been well received.

Dividends for the first quarter surpass all past records. They total \$4,795,475, of which Bingham mines contributed \$4,286,225, Park City, \$326,250, and Tintie, \$146,000. One mine in Beaver county paid \$25,000, and the Lakeview distributed the balance of \$30,000. It is expected that others will appear on the list soon, and the present rate will be exceeded. A record of over \$20,000,000 is confidently expected for 1916.

At Park City the old producers are shipping heavily. Among the improvements in immediate prospect are the electrolytic zinc plant of the Daly Judge, increased capacity for the Broadwater mills, completion of the Daly Judge surface improvements, electric hoist and compressor, electrification of the Daly mine, and a new 50-ton mill and 2-mile aerial tramway for the Silver King Consolidated. All of these improvements are of a permanent nature and reflect the increasing prosperity of an old district. Operations have been resumed at the American Flag mine, and at the Daly West mill. Ship-

ments in March were 6110 tons of ore and concentrate, contributed by 11 shippers.

At Bingham production is being rushed by both copper and lead mining companies. The Utah Apex is shipping 600 tons of lead ore daily. Utah Consolidated has paid a dividend of \$225,000. The lease on the Ohio Copper property is treating daily 2400 tons of ore, which is said to contain a little less than 1% copper, of which about 50% is saved. There is renewed talk of a reorganization of the company.

The latest addition to the shipping list at Tintie is the Tintie Standard, which has commenced production from a large body of galena ore on its 1500-ft. level. This is tangible reward for the persistent efforts of its management in the face of discouraging and even disparaging opinion of many of the 'experts' on Tintie ore-deposition. Properties on which work has been resumed or announced are the Zuma in East Tintie, the Utah Consolidated, Carisa, and Tintie Lily, which will sink to 1000 ft. Another shift has been added at the Gold Chain and Grand Central. The territory of the Beck Tunnel and the Plutus is to be explored in the hope of restoring these properties to active production. The Eagle & Blue Bell has resumed shipments after completing the installation of a new electric hoist and compressor. The Iron Blossom has announced a dividend of \$100,000 to be paid in May. The Sioux Con. has been stimulated by developments in the Iron Blossom to seek the extension of the great copper orebody in its own territory.

From Beaver county comes the announcement of new work by the Beaver Copper and the Beaver Lake Metals in the Beaver Lake district; Los Angeles capital for the Goldzone of Fortuna, the discovery of a new silver-lead orebody on the vigorous young Moscow, the commencement of development on the Nellie group, resumption of work by the Knights on the King David and Indian Queen at Frisco, rumors of resumption at the famous old Cactus. The Mammoth Copper Co. has been incorporated to operate a new property 14 miles north-east of Milford. Development has proceeded to the point where it is planned to ship four cars of copper ore per week. The Horn Silver has been enabled to pay another dividend of \$25,000 from the proceeds from the bond and lease on its dump, which the Caldo company is treating by flotation.

Many more companies are planning work in Big and Little Cottonwood. Among them are the Howell, adjoining the Cardiff on the west, and now under control of Cardiff officials; the Canton, an old-timer; the Cottonwood-Atlantis, controlling the old Moltke mine near the South Heela; and the Secret. The Sells, Alta Con., and Michigan-Utah are shipping. The Cottonwood Metal has taken over the Walrous ground and will equip it. An agreement has been reached by the City and County of Salt Lake and the Maxfield and Cardiff mines providing for the expenditure of \$30,000 in widening and straightening the Big Cottonwood road, in order that tractors may be substituted for horses, and one source of contamination for the city's water-supply be eliminated.

Geological Conditions at the Panama Canal

Some engineering problems of the Panama Canal in their relation to geology and topography are discussed by Donald F. McDonald in Bulletin 56 of the United States Bureau of Mines. Mr. McDonald was detailed as geologist to the Panama Canal, while it was under construction, and is now with the Bureau of Mines. The paper aims to discuss, from the viewpoint of the mining geologist, the bearing of topographic and geologic conditions on certain problems that arose in the construction of the Canal.

In all, there is a clear record of four oscillations in the region of the Canal and the beginning of another elevation. The average rate of uplift for, say, the last 1000 years has been less than 3 ft. in 100 years. It is believed that the sinking of the ocean bottom outside the relatively shallow depths of the isthmian shorewaters has been the chief cause of the earthquake periods that have, so far as the records go, visited the isthmus every 30 to 35 years and that each of these seismic disturbances has resulted in some increased elevation of the land mass. From the various oscillations of the land above and below sea-level, one would expect that the rocks constituting the isthmian land mass would have become broken and dislocated in these upward and downward movements, and this is the case. Great fracture planes cut the rock and trend mostly north-east and south-west, or approximately parallel with the axis of the land mass, with some minor fractures leading in other directions. Along these fracture planes differential movements, some of which measure hundreds of feet, have taken place. The frictional drag of these movements has crushed and broken the softer rocks for several feet on each side of the plane of motion.

This faulting has had an important bearing on engineering, because the faulted zones, especially where the rocks are extensively crushed and broken, have tended to promote slides. Culebra Cut is a vast ditch that passes through many varieties of rock in the nine miles of its length. Some of these are weak and unstable, and where the slopes of the cut were steep and from 100 to 300 ft. high, the weaker rocks were crushed down to flatter slopes. The flatness depended on the material involved, but, whatever the material, whenever the slope got flat enough the sliding stopped. The slides have made necessary the excavation of about 30,000,000 cu. yd. more than was included in the first estimates for Culebra Cut, but they have not in the past and will not in the future endanger the ultimate success of the Canal. The largest and most important slides developed from structural breaks and deformations. Fortunately, they occurred only near Culebra in a section of the cut not much over a mile long. These deformations first manifested themselves by the appearance of either one or of a set of cracks or fissures parallel or somewhat oblique to the edge of the cut,

and from a few to hundreds of yards back from it and from each other. Some of them were traceable on the surface for several hundred yards and gradually developed into perpendicular crevices as much as one-third of a yard wide and many yards deep.

Though it is not impossible that a destructive earthquake might visit the Canal, still it is extremely improbable for the following reasons:

1. The large number of tremors detected every month by the recording instruments is evidence that slow adjustments are constantly taking place and thus that no great accumulations of stress that might later culminate in a big shock are probable.

2. The absence from the Isthmus region of high mountains and of geologically recent volcanic activity is evidence in favor of the probable absence of earthquakes, especially as such high mountains are a striking geologic feature of the whole Central American earthquake belt.

3. The presence of numerous small faults and of the faulted conditions of such volcanic cores as Gold hill and Contractors hill is evidence that adjustment here has progressed well on toward normal conditions of equilibrium.

4. The tensile strength of the majority of the rocks within the Canal Zone is rather low, and they would shear with comparative ease, thus preventing any relatively great accumulation of stress that might result in a comparatively intense shock. However, experience teaches that where earthquakes happen, the buildings suffering the maximum destructive effects are those built on loose and friable material. This consideration might therefore subtract a little from the saving benefits of the yielding and preventive qualities of the Canal Zone rocks.

5. Over 300 years of earthquake observation shows only two shocks of considerable magnitude, and there is every reason to believe that the severest of these would not have seriously damaged even the most delicate parts of the Canal.

That many small and harmless shocks will traverse the Canal Zone is certain but that the Canal is in any real danger from earthquakes is contrary to all the evidence.

IMPROVED CONDITIONS in the mining industry are indicated by the prosperity of the houses that manufacture and sell mining machinery, as compared with the lean year just preceding. For example, Ingersoll-Rand Co. earned \$5,459,884 in 1915, as against \$1,967,723 in 1914, and had a surplus on hand January 1 last of \$5,333,323. Sullivan Machinery Co. had net earnings in 1915 equivalent to about 14% on the capital stock.

EFFICIENCY ENGINEERS are disturbed over a bill introduced in Congress to make it unlawful for any officer, manager, superintendent, or foreman, having charge of work for the U. S. government to make "with a stopwatch a time-study of any job of any employee of the government."

CONCENTRATES

Readers of the MINING and Scientific PRESS are invited to ask questions and give information dealing with technical and other matters pertaining to the practice of mining, milling, and smelting.

CORROSION is an electrolytic phenomenon.

VEINS containing tungsten minerals are as a rule found near intrusive igneous bodies, mostly granites and quartz-monzonites, from whose magmas the vein-minerals are believed to have been derived.

ISINGLASS is a term frequently used for mica. This is wrong. The former is a gelatine obtained from the sturgeon, a Russian fish; while mica is a silicate of alumina and potash, usually associated with gneiss and schists.

TO SLAKE LIME is to assuage or quench it with water, forming the anhydrous calcium oxide, called quicklime or slaked lime, not slaek-lime. The process is called 'slaking,' not 'slaeking.' The latter is a common corruption which should be avoided.

MINING METHODS at the Copper Queen, Arizona, were as follows in 1915: square-set, 65.9%; top-slice, 18.79%; cut-and-fill, 15.2%; and shrinkage, 0.2%. The second and third systems increased 4.8% and 7%, respectively; square-set decreased 10.2%; these changes reduced the cost of ore extraction.

CEMENT produces a peculiar skin eruption, resembling the itch. It is caused by the alkaline content of the concrete acting on the skin of the hands and face, especially where already softened by water. Cloth gloves, the covering of the skin with a fat or grease, and careful washing will prevent the inconvenience.

STORING FUEL-OIL under water for the use of submarines is accomplished by employing submersible barges in the form of a tank 150 ft. long and 30 ft. diameter with hemispherical ends. This tank will hold 2400 tons of oil, and can be submerged by admitting water to the compartments at the ends. Compressed air may be used to bring the vessel to the surface.

COSTS in the zinc-lead region of Missouri-Kansas-Oklahoma are remarkably low. At Webb City one sheet-ground operator reports from \$1 to \$1.25 per ton for mining and milling; another in similar ground at South Carterville, \$1.40, 35c. being treatment charge; and in the Miami district, all expenses, including insurance, etc., was \$1.07 per ton over a period of 2½ years.

EMERALDS at Muzo, Colombia, are found in a formation of thin beds ($\frac{2}{3}$ in. thick) of shale and limestone alternating, the former predominating. The shale is a dense, black rock, soiling the hands with excess carbonaceous matter. The beds are gently to severely folded, in places contorted. Fractures are prominent, mostly

'healed' by calcite. The stones are seldom found in the shale or limestone alone, but usually in the calcite veins. Open-cut is the method of mining. The emerald-bearing calcite is removed by hand and sorted.

CHAINS are designated by the diameter of the rod from which the links are made, as $\frac{1}{2}$ -in., $\frac{3}{4}$ -in., etc. Also they are distinguished by the form of the link, as close-link, in which one link is just large enough to enclose the two adjacent ones; open-link, in which the link is larger; bar-link, which consists of open links with a bar across the middle of each; twisted-link, applied usually when the twist is 90°; and straight or flat-link, when the twist is less.

THE 8-HOUR shift as introduced at a number of mines has proved successful. In most regions, white men will do as much drilling, tramming, or other hard labor requiring sustained energy, in eight hours as in ten. On the other hand in some out-of-the-way or Southern districts, where a leisurely mode of working still prevails, it would be impossible to spur the men to do as much in eight hours as in ten, and for the most part such workmen probably prefer the longer day in which they can take things more deliberately.

THE BRITTLINESS of copper, developed during the smelting and frequently ascribed to 'burning,' is in reality a de-oxidation. This brittleness in commercial copper is said to be caused by the too-great reduction of the cuprous oxide around the copper grains, leaving a spongy mass of little mechanical strength. Therefore in the process of smelting, it has been found advisable to leave a small amount of oxygen in the copper, in order that it may retain the desirable properties of ductility and strength.

POWER PRODUCTION is changing from reciprocating types of machinery to rotary types. This change has been a marked feature of the machinery field during recent years. The steam turbine is replacing the reciprocating engine for many purposes. The centrifugal pump often is substituted for the reciprocating pump; rotary condensers, rotary air-blowers and compressors are finding favor. The advantages urged for the rotary units are simplicity of design, small space, balance, low cost, and maintenance. The steam turbine, too, uses steam that otherwise would be wasted.

UNWATERING a shaft of the Catskill aqueduct in Morningside Park, New York, for the purpose of inspection or repairs, is accomplished by four-stage centrifugal pumps. The peculiar point is, however, that the pumps are floated on the surface of the water in a hollow steel cylinder partly submerged. The water enters the pumps by passages in the bottom of the float, and, as the submergence of the float is constant no matter how much the water in the shaft may be lowered, no change occurs in the pump intake. This device is not new and has been used for unwatering mines, but is simple and interesting.

REVIEW OF MINING

As seen at the world's great mining centres by our own correspondents.

FLAT RIVER, MISSOURI

REVIVAL IN OLD DISTRICTS.—IMPROVEMENTS AT FLAT RIVER

The Madison County district in south-eastern Missouri is the scene of great mining activity this spring. Eastern capital is interested, and several neglected properties are being re-opened. The Catherine mines are being worked after having been closed for several years. A great deal of land is being purchased by outside people for future development.

Other old mines to be re-opened are the Silver properties on the St. Francis river, about 10 miles west of Fredericktown. These mines were operated about 10 years ago for lead and silver, and later closed. The old shafts are being cleaned out, and a hoist erected. Tungsten is searched for, and a test shipment of 1250 lb. has just been made.

In the Flat River district the Federal Lead Co. is building its new mill day and night, and expects to complete it this summer. In its other plant the company has installed a Marathon mill for testing purposes, and is at present grinding the jig middlings for table treatment. These mills are still in the experimental stage.

The St. Joseph Lead Co. is working on plans and specifications for a new power-plant to cost \$250,000, to be constructed at Rivermines this summer and fall. The building will be of steel and brick, and should be one of the best in the State. The engine will be a steam turbine of 3500 kw., single unit, and is so arranged that a duplicate can be installed later. The new plant will run in parallel with the present system. The company has a steam-turbine plant at Leadwood, and a gas power-plant at Bonne Terre.

The Desloge Lead Co. has installed a Hardinge mill, to grind the oversize of the jig middlings. The discharge is sent to a Dorr drag-classifier, the overflow going to flotation, and the drag discharge returning to the mill circuit.

LEADVILLE, COLORADO

FURTHER DRAINAGE SCHEMES.

A contract has been closed between the Western Mining Co. and the Empire Zinc Co. for lowering the water in the Wolfstone shaft from its present level at 800 ft., 150 ft. to what is known as the 1000-ft. level. The draining of the Wolfstone to this depth will give access to immense bodies of sulphide ores now under water, and will completely drain the Robert Emmet shaft, 850 ft. deep, which, with surrounding territory was recently purchased from the Small Hopes-Boreel Mining Co. by the Empire Zinc people for \$500,000. J. H. Bowler, with W. C. Jones, of the Layne & Bowler Corporation, manufacturers of the Layne centrifugal pumps with headquarters at Los Angeles, California, is here installing the sinking-pump in the Wolfstone shaft. The pump is a vertical turbine with a capacity of 2000 gal. per minute. It is being placed in the shaft at the 500-ft. level and connected with the large steam plant now operating at that point. The steam plant has a capacity of 2000 gal., and at the present time is throwing only 650 gal. per minute. The sinker will force the station equipment to its limit, and will drain the shaft at the rate of 1350 gal. per minute. The unwatering is estimated to require from two to three weeks. The selection of the Layne type of pump is largely due to the decision of the manager of the Western Mining Co., S. D. Nicholson, who made a personal inspection

of the Wolfstone shaft prior to the completion of the drainage contract. There is another large plant of pumping machinery on the 980-ft. level in the Wolfstone that has been under water for a number of years. When the water has been lowered to this point, it is proposed to repair the 'drowned' machinery and pump the flow by it directly to the surface. The draining of the Wolfstone is regarded as one of the most important enterprises that have been undertaken at Leadville this year. The strong market now prevailing for zinc and lead sulphide ores, and the sharp advances being made in the price of silver have created an unprecedented demand for the huge deposits of ore that have been under water in the Wolfstone shaft for years. It is known that the sulphide zone in the Wolfstone and other holdings of the Western Mining Co. is equally as rich and extensive as the carbonate. Many millions of dollars have been taken from the Wolfstone as carbonate of zinc, and an equal quantity should be extracted. The influence of the Wolfstone drainage will not only affect the property itself but will also unwater the richest section of the district. The holdings of the Empire company are authoritatively stated to be the richest lead and zinc mines here. Immense bodies of this kind of ore are now being mined above the 600-ft. level. Last month \$50,000 worth of lead and zinc sulphide was shipped from the property. These upper stopes are small in comparison to those known to exist throughout the lower workings. Output from these mines will be more than doubled as soon as the unwatering is complete.

VICTORIA, BRITISH COLUMBIA

NEW MINING REGULATIONS.—PRODUCTION OF EAST AND WEST KOOTENAY, ROSSLAND, AINSWORTH, NELSON, BOUNDARY, REVELSTOCK, AND COAST DISTRICTS.—ZINC.

Recent important occurrences here include two that are of more than ordinary interest to mining men: One is the change made in the law relating to the method of dealing with Crown-granted (patented) mineral claims forfeited for non-payment of taxes, so as to facilitate acquirement of such claims by prospectors who shall do development work on them and find it to their interest to secure title to the property; the other is a decision by the Mining Committee of the Provincial Legislature that John Hopp, of Seattle, Washington, and his associates are fully entitled under the Placer Mining Act to leases granted to them of certain placer-gold ground at Bullion, Cariboo, which was for years the scene of the chief activities of the late John B. Hobson, who prior to 1906 established and operated for a Canadian company the largest hydraulic gold-mining enterprise in British Columbia, possession of which passed to the Guggenheim interests of New York and was afterward abandoned by them. At the end of 1913 the company that had been organized by the Guggenheims to acquire and operate the Bullion property sold to Robert T. Ward for \$20,000 its assets which, however, did not include title to the ground, since failure to renew its free miner's certificate in 1912 had resulted automatically by law in forfeiture of the leases. Mr. Hopp and associates re-located the ground after it had been open to location nearly 18 months, and now they are confirmed in their title to it.

As to mining in East Kootenay, the only important producer among the metalliferous mines is the Consolidated Min-

ing & Smelting Co.'s Sullivan mine which, during the quarter ended March 31, shipped to the company's smelter at Trail 16,497 tons of ore, a small proportion of which was zinc ore, and by far the greater part lead ore.

In West Kootenay, Rosslund mines continue to maintain their long lead in ore production over those of other parts of this extensive district. The total quantity of gold-copper ore shipped to Trail during the first quarter of the year from Rosslund mines was 84,994 tons, of which 45,822 tons was from the Consolidated Co.'s Centre Star group, 35,308 tons from the same company's Le Roi mine, and practically all the remainder from the Josie group of the Le Roi No. 2, Ltd. Production of silver-lead ore in the Slocan mining division amounted to 3195 tons during the quarter; about one-half of that quantity was from the Standard mine near Silverton, with the Galena Farm, Hewitt and Lucky Thought, in the same part of district, and the Noonday, Reco, Rambler-Cariboo, Ruth, and Slocan Star, in central Slocan, and half-a-dozen smaller shippers in various parts of the district, also contributing to the above-mentioned total, which was the amount of silver-lead ore and concentrate received at Trail. Shippers of zinc concentrate to United States reduction works were the Galena Farm, Hewitt, Lucky Jim, Rambler-Cariboo, Ruth, and Slocan Star. Additions of machinery and plant are being made to the Slocan Star concentrating mill, and enlargement of the custom concentrator at Rosebery, Slocan lake, is being arranged for.

Ainsworth, with a total of 5212 tons shipped to Trail, and Nelson with 708 tons, are other West Kootenay divisions. In the former, the No. 1 with 2381 tons of silver-lead ore and the Bluebell 1968 tons of lead concentrate, were the larger shippers; the list also includes the Florence, Highland, Utica, and several others. In Nelson division, the chief production was by the Hudson Bay mine, which shipped oxidized zinc ore to the United States, while the Emerald sent 436 tons of lead ore to Trail. The Queen and Granite both milled gold ore; the Eureka shipped copper ore to Trail after having been off the list of producers for a number of years.

Of the several zinc-reduction projects that have had newspaper notice only one—that of the Consolidated Mining & Smelting Co. at Trail—has made actual practical progress in Kootenay district. The production of electrolytically refined zinc on a commercial scale is an accomplished fact at Trail, where the newly-erected and equipped refinery is now in regular operation. It has been announced that preparations for making sulphuric acid are being advanced by the Consolidated company, and that its plans for the electrolytic refining of copper will shortly be carried out.

In Boundary district, the Granby Consolidated company now has all of its eight blast-furnaces at Grand Forks in full operation, after having had two out of commission through the winter season. At Greenwood, the British Columbia Copper Co. recently blew in a second furnace, having arranged for a sufficient supply of ore to admit of this extension of smelting operations. Milling gold ore at the Jewel mill, by the lessees of that company's property, was to be undertaken in April. Hauling ore from the Union mine, in Franklin camp, will be resumed as soon as the wagon road will stand the heavy traffic. In Camp Hedley, Similkameen, the customary progress is being made at the Nickel Plate gold mine and 40-stamp mill.

In the Coast district, the Britannia Mining & Smelting Co. continues to carry out an extensive plan of development of its Howe Sound copper mines, and is mining and concentrating about 1500 tons of ore a day. The Tonopah-Belmont Development Co. has acquired and is further developing the Surf Inlet gold mine, Princess Royal island. The Granby Consolidated Co. is operating to present full capacity its copper property at Hidden creek and smelting works at Anyox, Observatory inlet. The Rocher Deboule company, which in the second half of last year shipped to Anyox about 17,000 tons of 8% copper ore, is now shipping to Tacoma, Washington, and the Silver Standard,

also near Hazelton, Omineca division, is sending some silver-lead ore to Trail.

'The Solution of Some Hydraulic Mining Problems on Ruby Creek, British Columbia,' is the title of a paper written for the Arizona meeting of the A. I. M. E. by Chester F. Lee and T. M. Daulton of Seattle. This district is 17 miles east of

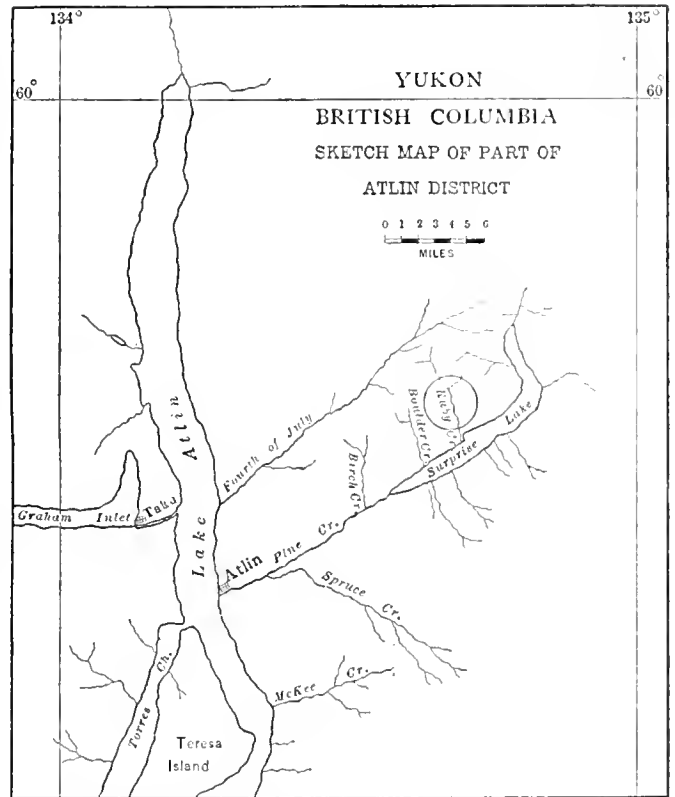

Atlin. Gold was found there in 1898, and the output to date from placer mines is \$4,518,000. The great width of the deposit, (250 ft.), flood-waters, poor pumping facilities, and large boulders were the difficulties. These were overcome by dividing the ground up the creek into two series of pits. First one was sluiced for 400 ft., then the other was started, working alternately. The boulders are blasted when the pits become too full of them. In the flood season only one pit is

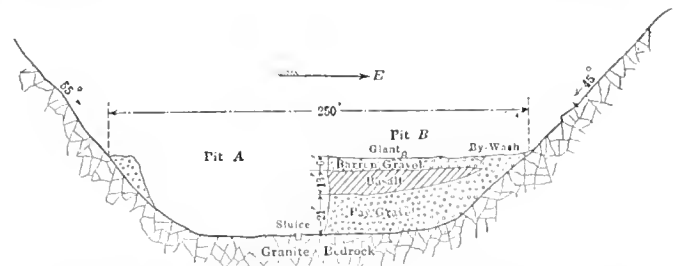

CROSS-SECTION OF RUBY CREEK SHOWING POSITION OF GRAVELS BEING WORKED BY HYDRAULIC MINING.

worked, an arrangement of sluices allowing the excess water to go to waste. The gold-saving sluice-boxes, 42 in. wide, are lined with carbon-steel (0.9% carbon) plates, in place of spruce blocks used previously. After a season's wear (150 days), when 67,940 cu. yd. of gravel flowed over them, the plates showed an abrasion of 1/32 in. In 1915 6380 boulders were drilled and blasted and 21,955 'bulldozed' without drilling. In two years the average was one boulder for 2.5 yd. of gravel moved. Sullivan DA-19 40-lb. hammer-drills are used. All costs in 1915 totaled 47.6c. per cu. yd. The property is owned by the Placer Gold Mines Co. of Seattle, in charge of T. M. Daulton.

THE MINING SUMMARY

The news of the week as told by our special correspondents and compiled from the local press.

ALASKA

Wireless Service in Alaska is the title of an article in the April issue of *The Wireless World*, of London, England. A brief though good description is given of the Territory, noting that progress is impossible without rapid means of communication. The cable and telegraph service is frequently interrupted on account of storms and volcanic disturbances. The Government, as well as mining and fishing companies have erected several wireless stations. The Marconi company has semi high-power installations at Juneau and Ketchikan, 250 miles apart. These have regular service with Astoria and Portland. The towers for the aeriels in Alaska are 300 ft. high. The wireless conditions in Alaska are peculiar, due possibly to the geographical shape of the country and the continuous daylight during the summer months.

JUNEAU

On the west side of Funtler bay the Alaska Gold Mining Co. has 17 men at work, this number to be augmented to 200 during the summer. A bunk-house of this capacity is to be built. Proposed work is a 5 by 18-ft. shaft to 600 ft. depth, and a 9 by 12-ft. adit 1500 ft. long. W. S. Pekovich is superintendent.

ARIZONA

COCHISE COUNTY

During the quarter ended March 31 the Shatruck-Arizona produced 4,682,691 lb. copper, 1538 oz. gold, and 8965 oz. silver, with a net profit of \$781,389.

GILA COUNTY

(Special Correspondence.)—Pending the delivery of the electrical equipment for the power-plant at the Eureka shaft, and of additional electric pumps, the Arizona Commercial Copper Co. is limiting operations mainly to stoping ore on the 13th and 14th levels of the Copper Hill mine. Daily shipments to the Old Dominion smelter average 150 tons of sulphide, most of which is smelting ore. The most important development under way is a raise to connect the 1200 and 1600-ft. levels at Copper Hill. This raise has been carried up 130 ft. in ore, the quality of which is steadily improving. It is apparently a continuation of the sulphide orebody below. At the Eureka shaft the 8th level is being opened, and the superintendent, Robert Boyd, states that the indications there are good. Some silicious ore from the Eureka is being shipped to the Carter Queen smelter at Douglas. It is expected that about \$75,000 worth of new equipment, including electric pumps, turbines, hoists, compressors, etc., will be installed by June 1. At present about 800,000 gal. of water must be carried for daily. The company's best ore is on the 1400-ft. level. The shoot, an extension of the Old Dominion vein, is widening as development continues east, the last store showing a width of 40 ft. of ore.

Globe, May 2.

Silicious ore is again being sent from the Live Oak mine at Miami to the International smelter.

MOHAVE COUNTY

According to S. S. Jones, who recently resigned as superintendent of the Tom Reed mine at Outman, the deepest workings are at 1400 ft., the total openings are 29,097 ft., and gold output to date approximately \$6,000,000.

The Gold Ore mine is sending from 20 to 30 tons of \$34 ore to the Gold Road mill daily. This comes from the 530-ft. level.

Extensive development is under way at the Outman Amalgamated, Outman Combination, Ivanhoe, Lucky Sam, Big Jim, Gold Dust, Arizona Tom Reed, Tom Reed Junior, Sunnyside, and United Western, and from which encouraging results are reported.

PINAL COUNTY

While sinking its main shaft the Ray Hercules company opened rich copper carbonate ore.

YAVAPAI COUNTY

Although the United Verde smelter at Clarkdale is treating 2500 tons of ore daily, it is not at full capacity. The monthly copper output is over 5,000,000 lb.

ARKANSAS

SEBASTIAN COUNTY

At Fort Smith the Fort Smith Smelter Co. is making good progress in building its new smelter, hoping to complete it by July. In the four blocks will be 610 retorts each, a total of 2560. The cost is \$250,000.

Across the river from Fort Smith at Van Buren, Crawford county, a smelter with four blocks of 800 retorts each is to be constructed by a New York metal house.

CALIFORNIA

AMADOR COUNTY

The club-house erected by the Plymouth Consolidated company for its employees was opened last week. Suitable addresses were made by Albert Burch and James F. Parks of the company.

CALAVERAS COUNTY

(Special Correspondence.)—On Carson Hill W. J. Loring is making a large amalgamation of claims. He has an option on the Calaveras Consolidated, which was worked by an English company on a small scale many years ago. Systematic trenching and sampling of the property, which covers 8000 ft. on the strike of the lode, has given good results. An orebody 1700 ft. long and 15 ft. wide, averaging \$3.50 per ton, has been disclosed. This will give a healthy margin of profit, as the neighboring mine, the Melones, is operating on \$2.40 per ton. The latter has an adit from the Stanislaus river that reaches a depth of 1300 ft. below the outcrop, and has workings extending to a maximum vertical depth of 2650 ft. from the surface. It is obvious, therefore, that a consolidation of properties should be advantageous to all concerned.

Carson Hill, May 4.

ELBORADO COUNTY

Between Placerville and Plymouth in Amador county, a distance of 23 miles, there is a good deal of mining activity along the Mother Lode, according to Burr Evans. Operations at Plymouth are so well known as to need no further comment. Nine miles north is the Laus Padre mine, a former rich producer. At Nashville the Montezuma shaft is being sunk to 1200 ft. Three miles south of this is the Amador Star, being developed by English capital. At the shaft, down 150 ft., a complete equipment has been erected. Sinking proceeds at the rate of 100 ft. a month to the 700-ft. point. Seattle and San

Francisco people have acquired the Teddy Bear and Union mines, respectively, near the Laus Padre.

MARIPOSA COUNTY

Los Angeles and Chicago capital has acquired the Mt. Gaines gold mine, 4½ miles east of Hornitos, with Samuel J. Paul in charge. The Mt. Gaines Gold Mining Co. took control on May 10. The mine is opened to a depth of 1300 ft., with stopes to 900 ft. It is full of water. A 5 ft. vein worth \$7 per ton is said to have been left. An electric hoist and 20-stamp mill are part of the equipment.

After liquidating a debt of \$73,700 and making many improvements to its power and treatment plants, the Mountain King company had a balance of \$36,229 on March 31, 1916. An initial dividend of 3c. per share is to be paid on May 15. An assessment realized \$60,000. Ore treated (28,145 tons) yielded \$6.39 per ton, the recovery being 93.16%. The net earnings were \$87,303. Ore reserves are sufficient to supply the 20-stamp mill for two years. Development amounted to 3765 ft. Standard Oil officials are interested in this concern.

SHASTA COUNTY

The new dredge of L. Gardella has started digging three miles south-west of Redding, on Clear creek. A good deal of the machinery came from Oroville.

TUOLUMNE COUNTY

(Special Correspondence.)—Operations on the App, and Dutch Sweeney mines are proceeding most satisfactorily. Options for 10 months on these two group of properties were taken by W. J. Loring on behalf of Boston capitalists on November 1, 1915. It was agreed to do 3000 ft. of development work on the two properties. To date 1600 ft. has been done in the App mine and 800 ft. in the Dutch-Sweeney group. The 1500, 1650, and 1800-ft. levels from the Dutch mine have been extended into the App, with cross-cuts and raises. Likewise, the North drift on the 1650-ft. level has been extended into the Sweeney claim. The result of this work has been to open up fully 200,000 tons of ore, averaging \$4 or better. A 20-stamp mill has been at work since February 14 for the purpose of sampling the properties on a working scale. This mill treats 200 tons of ore per day: the average stoping width is 20 ft.; the maximum width of lode is 38 ft. These mines were worked heretofore for \$1.75 per ton, with a small overhead expense. It is estimated that they can be worked to include all expenses for \$2.50 per ton. It is likely, therefore, that the option will be exercised when it expires, at the end of August.

Sonora, May 4.

(Special Correspondence.)—The Nyman Consolidated Mines Co. held its annual meeting in San Francisco on April 17. When the company was incorporated in March, 1915, the question of finance was the first problem. Since then 119,785 shares of the 200,000 to be issued have been sold at \$1 each. When the property at Jamestown was acquired underground work done amounted to 12,000 ft., the previous owners extracting 100,000 tons yielding \$2,000,000. In July last year the mine was unwatered. Eventually the Mascot orebody was leased, this proving the most profitable system of working. The recovery was \$17.20 per ton. During the last 9 months the Mascot, Knox & Boyle, and Nyman orebodies produced \$31,092 from 5525 tons. The total cost was \$2.50 per ton. The financial statement shows that on March 31, 1916, there was \$19,146 cash in banks.

COLORADO

BOULDER COUNTY

The Crise Bracken tungsten mines above Boulder Falls have been acquired by A. H. Carlisle of New York for \$100,000. The first payment of \$25,000 was made last week. The Catastrophe mine is also under option for \$60,000.

CLEAR CREEK COUNTY

(Special Correspondence.)—The boilers at the Doric adit on

Saxon mountain, were fired this week. The bore, which has a length of 3009 ft., is to be driven to the Ruler vein. Driving will then follow to make connection with the east drift from the Capital adit.—Shipments of ore were started this week from the Josephine mine in West Argentine. Stephens brothers, the lessees, have 200 tons of lead and zinc concentrate and 100 tons of smelting ore ready for delivery to the Georgetown sampler.—Heavy shipments are going out from the Smuggler mine on Brown mountain. The ore is high grade, and gives a mill settlement of nearly \$100 a ton in silver and lead. A. E. Simpson is manager.—The Wide West mine on Leavenworth mountain, recently taken under lease by A. L. Stephens,

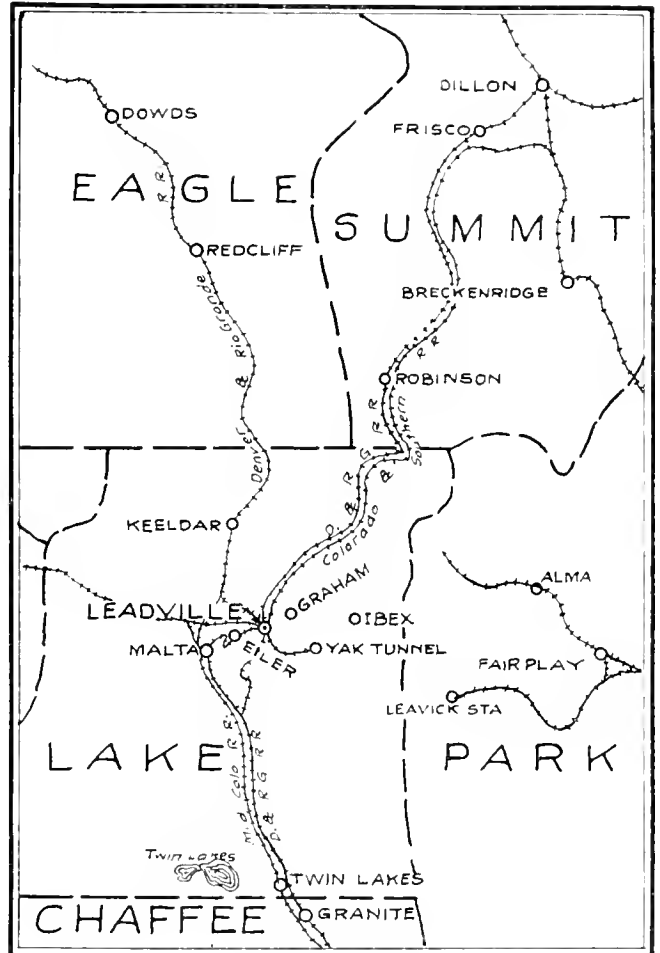

PART OF COLORADO.

will be on the list of shippers during the present month. The many old workings have been cleaned out and re-timbered, and a 4-ft. body of galena is exposed that is worth \$45 a ton in silver and lead.—Work was resumed this week on the Tobin mine in East Argentine. A new adit is to be driven to intersect the Wheeling vein with a view of determining the source of tungsten float that has been found in that vicinity.—The Kitty Ousley property has been leased to S. E. Herber, work having been started a few days ago. The adit is being repaired and shipments of a lead-zinc ore will be started within a short time.—Development is under way at the Santo property situated on Saxon mountain. The adit now 1000 ft. long, is to be advanced.—A total of 12 sets of lessees are at work in the Capital mine, and regular shipments are being maintained by 10 of them. The ore is generally of a smelting grade, and mills from \$20 to \$70 a ton in gold, silver, lead and copper.—R. F. Staley of the Combination mill at Idaho Springs, has just installed two Empire tables. Ore is being treated from the Comstock and Specie Payment mines.—A. Freedman has disposed of his one-half interest in his lease on

the Edgar mine to the Boston Leasing Co. The ground is producing at the rate of 25 tons of \$40 ore daily.

Idaho Springs, May 2.

(Special Correspondence.)—The general manager of the Imperial mines, F. J. Wilcox, reports the finding of a large body of rich tellurium and gray copper ore in its property in East Argentine, in an adit that had not been operated since 1907. The portal of this adit is near where the discovery of 60% tungsten ore was made last fall, but which has not yet been followed up on account of the deep snow.

Georgetown, April 30.

LAKE COUNTY (LEADVILLE)

Only 10 ft. of water remains in the Penrose shaft of the Down Town mines. A large station-pump is to be installed on the bottom level when the water is out. — Owing to the drainage work by the Down Town company, and the higher price of metals, the old Cloud City and Home Extension mines, long idle, will be re-opened in charge of Clarence Jarbeau.

Preparations continue for the unwatering of the east Carbonate Hill territory through the Mikado shaft. G. O. Argall is in charge.

The Western Mining and Empire Zinc companies have agreed on lowering the water in the Wolfstone shaft 180 ft., thereby draining the Robert Emmet mine of the Empire.

TRIFLER COUNTY (CRIPPLE CREEK)

The district's gold output in April is estimated at \$1,199,585 from 87,475 tons of ore. The Roosevelt drainage-tunnel has entered another water-course, 300 ft. east of the Elkton shaft. The additional flow was 2000 gal. per minute.

At certain seasons gas is troublesome in Cripple Creek mines, interfering with operations. For the Arizona meeting of the A. I. M. E. George A. Burrell and Alfred Gauger have prepared a 21-page article on the composition of the rock-gas of the district. Over 30 miners have been killed by this gas in the past 25 years, while many others have been incapacitated for some time through it. No gas occurs in the oxidized zone, but is found at depth. The outside atmospheric pressure materially affects the outflow of gas into the mines. The gas is confined to the rock under low pressure. Detailed discussions are given of samples of gas collected in the Anaconda, Cresson, Mary McKinney, and Midget mines. The gas averages 14% carbon dioxide and 86% nitrogen. The acetylene lamps should not be used as the only warning against the presence of gas in these mines.

IDAHO

BOUNDARY COUNTY

(Special Correspondence.)—The hills are full of prospectors now, some good men being among them. As the spring is well on all the small properties are resuming operations. The Deer Creek Mining Co. has purchased a cyanide-plant, and expects to start work on May 15.

Bonnors Ferry, May 1.

SIOSHONE COUNTY (COEUR D'ALENE)

During 1915 the Marsh Mining Co. at Burke made a loss of \$63,791. Large expenditure was made at the mine and mill. The revenue for the first quarter of 1916 reduced the debt to \$22,000. The mill feed averaged 5.5% lead in March, when 400 tons of ore and concentrate was shipped. Zinc concentrate has also been produced.

For three years miners and homesteaders in the Pine Creek district have been arguing over the rights of mineral claims. The Land Office ruled that certain ground was agricultural. In the Heim (homesteader) v. Boyle (prospector) suit, the Secretary of the Interior has decided in favor of the latter. A re-classification of land is wanted.

The Caledonia company made a profit of \$263,933 in the first quarter from 11,646 tons of ore.

MISSOURI

JASPER COUNTY

There was a decline in ore prices in the Missouri-Kansas-Oklahoma region on April 30. The output was 7231 tons blende, 162 tons chalcamine, and 1114 tons lead, averaging \$98, \$74, and \$100 per ton respectively. The total value was \$859,179; and for 11 weeks \$44,830,916.

One thousand acres of land west of Webb City has been acquired for 15 years by J. Briegel and F. M. Hurch of Joplin. This is the largest lease ever reported in the south-west. The property will be thoroughly prospected.

A flotation plant is being constructed by the American Zinc, Lead & Smelting Co. at its Vogey mine. The process supplements the sludge and slime tables. The mine produces 7000 tons of ore a week.

Good progress is reported in the erection of a 400-ton mill at the Milton mine, north of Cartersville. G. W. Field of the National Zinc & Lead Co. is interested.

In *The Mining Magazine* of London for April, H. Foster Bain, until recently with the Platts, discusses the Joplin ore-deposits, including the views of other geologists. Mr. Bain's opening sentence is as follows: "Joplin is 'the town that Jack built,' 'jack' being the Missouri miners' name for sphalerite or zinc-blende."

MONTANA

BEAVERHEAD COUNTY

Cyanidation of the Hannack Gold Mining Co.'s ore at Bannack will recover 97% of the gold and 70% of the silver, according to tests. The process includes all-sliming. The 150-ton mill should be complete by July 15. In the mine is 200,000 tons of ore developed.

FERGUS COUNTY

(Special Correspondence.)—Prospecting is active this spring in the Judith and Moccasin mountains, the high price of metals having stimulated development.

At the Gold Acres claims at New Year in the Judiths, three bodies of low-grade ore have been disclosed, one of which is reported to be 18 ft. thick. Further work is being done in order to ascertain the extent of the orebodies.—At the Copper King property development now being done shows an orebody 65 ft. wide, which is said to have been traced over 1500 ft. on the surface.—At Maiden the Spotted Horse mine and mill employs 25 men. Ore as low as \$3 a ton can be treated in the new cyanide mill, while before it was built no ore worth less than \$20 would pay to ship to the smelter.—The Cumberland, McGinnes, and Whiskey Gulch mines near Maiden have been leased. Development is now being done at the Cumberland and will soon start at the others.—The gold ores of the Judiths occur in replacement deposits in limestone, near the contact with laccolithic intrusions or under sheets of porphyry. Mining is usually cheap and profitable. The lead-silver ores on the other hand, occur in small pockets or narrow veinlets, and while high-grade ores can sometimes be found, yet the quantity of such is usually too small for profitable mining. The increase in the price of metals, however, has permitted these ores to be mined at a profit, and several men are now sacking and shipping lead ore. Most of it comes from small prospects on the north and east sides of the mountains.

The Barnes-King Development Co. will spend \$10,000 this summer on improvements on its power-plant on Warm Spring creek.—The adit on the North Kendall property is in over 500 ft., and according to W. C. Kruse a body 35 ft. thick has been cut that assays well in gold for cyanidation.

No mine has ever been developed in the south Moccasin mountains, although much prospecting has been done. Recent work on a group of claims, however, has disclosed a body of gold ore of grade suitable for cyanidation. Further work is being done in order to disclose the extent of the orebody.—The foundations for the 700-ton gypsum mill of the Hanover

Gypsum Co. are completed, and the mill itself will be completed in about six weeks. Several carloads of gypsum have just been shipped to Seattle.

The Tenderfoot Mining Co. expects to erect a concentrator at its property in Meagher county this summer.

Lewiston, April 27.

Another, the second, dividend of 7½c. per share, equal to \$30,000, is to be paid by the Barnes-King company on June 1. The quarterly report issued briefly discusses the mines and finances.

SILVERBOW COUNTY

The Butte & Superior Copper Co. is now known as the Butte & Superior Mining Co. The April output was 16,500,000 lb. zinc, 270,000 lb. lead, and 325,000 oz. silver. The recovery was 93% in treating 54,000 tons of ore.

During the first quarter of 1916 the North Butte produced 5,740,193 lb. copper, 366 oz. gold, and 244,976 oz. silver. The surplus increased by \$262,389.

The 22 operating shafts of the Anaconda company are producing 14,000 tons of ore daily, to be increased to 15,000 tons within a month.

NEVADA

CLARK COUNTY

Large profits are being made by the Yellow Pine company at Goodsprings, and the dividend has been increased from 10 to 15c. a share, equal to \$150,000.

ESMERALDA COUNTY (GOLDFIELD)

Agreements between the Jumbo Junior Mining Co. and the reorganized Booth and Jumbo Extension companies, allow the first-named to have vertical side-lines and deep exploration through the Velvet shaft respectively. Work will start at a depth of 800 ft. J. K. Turner is superintendent of the Junior property.

The April output of the Goldfield Consolidated is estimated as \$222,000 from 30,400 tons, with a profit of \$60,000.

HUMBOLDT COUNTY

The Rochester Mines Co. expects to extract as much ore from the Codd block in its Crown Point claim as did the lessees, namely 19,300 tons yielding \$344,585.

Thirty-five miles north-east of Lovelock, near Antelope Springs, D. Dawson and F. Summers have opened a cinnabar deposit.

LINCOLN COUNTY

Since April 15 the Consolidated Nevada-Utah new mill has been working satisfactorily. The daily output of zinc concentrate is 70 tons. Flotation is being tried.

LYON COUNTY

The Nevada-Douglas is sending copper ore to Utah smelters regularly, making a profit of \$20,000 a month. The leaching plant of 250-ton capacity was expected to be in full operation on May 10. There are 175 men employed.

NYE COUNTY (TONOPAH)

During the last week of April Tonopah mines yielded 8569 tons of ore worth \$179,502.

STOREY COUNTY (COMSTOCK)

The old Union shaft has been overhauled to the 2400-ft. level, and an air passage is open to 2700 ft., improving ventilation. This shaft was sunk by James G. Fair, and abandoned in 1885. Its reconstruction is of importance to the workings in the Union, Sierra Nevada, and Ophir mines at the north end. Bullion extracted from ore mined since December 15, 1915, in abandoned territory was worth \$191,412. Last week's ore included 87 tons of \$57.15 ore from No. 4 stope above the 2400-ft. level. This was from the area not considered valuable years ago.

WHITE PINE COUNTY

During the first quarter of 1916 the Giroux Consolidated's income was \$101,961 from 18,537 tons of ore. The profit was \$49,026, on which the bullion-tax was \$613.

In the PRESS of April 1 it was stated that Millick brothers and J. Fox had jumped Hudson's location in the Minerva district. Hudson states that the former have treated him fairly, and of the \$10,000 to be paid him they have made one payment.

OREGON

JACKSON COUNTY

An election is to be held at Medford on May 23 to decide whether the town will issue bonds for \$300,000 to help in constructing a railway to the Blue Ledge mines, 30 miles from the present terminal of the Bullis electric line. If carried, the road will eventually head toward the Pacific coast north of Trinidad in Humboldt county.

TENNESSEE

POLK COUNTY

Diamond-drilling from No. 8 level in the Tennessee Copper mine has passed through 400 ft. of a solid orebody. The acid plant at the smelter is again in full operation, after a two months' shut-down due to a strike.

TEXAS

LLANO COUNTY

(Special Correspondence.)—Attention of late has been directed to the mineral resources of the Llano region. Several promising mines are being opened, and preparations made for extensive exploration. Twelve miles from Llano is a large deposit of manganese ore, from which 2800 tons was shipped recently. Auto-trucks haul the ore to the railroad here. Some tungsten ore is to be developed. Extensive deposits of iron ore occur. The Iron Mountain property has been explored by drilling and underground work. Near Llano, in Burnet county, is a good deal of fluorite. Molybdenite is being mined near Llano. The Heath, the only producing gold mine in the State, is 5 miles east of Llano. A large plant was erected, but it is closed at present. McCarty Moore of Dallas and others are owners. There are possibilities in asbestos and copper. A graphite deposit in the Burnet area is being developed.

Llano, April 29.

UTAH

PIUTE COUNTY

A revival is reported from the Marysvale district, many old claims being re-located. Minerals produced are antimony, copper, gold, and manganese.

SALT LAKE COUNTY

Utah Copper miners are to receive an advance of 25c. per shift, while at the mills the increase is from 15 to 25c. per shift, while copper is 25c. per lb. or over.

At the South Hecla Extension mine in the Little Cottonwood the progress in driving for three fissures is 125 ft. per month on one shift per day, using machines.

SUMMIT COUNTY

On account of the rise in silver the Silver King Coalition company at Park City has raised wages from 25 to 50c. per shift.

WYOMING

ALBANY COUNTY

The Rambler lode platinum mine at Holmes is to be actively worked by the Platinum Mining & Milling Co., which has a lease on the property from the Rambler Copper & Platinum Co.

Francis W. Rosco is consulting engineer. Last October 49 tons of ore sent to Irvington, N. J., yielded 6.28 oz. gold, 71.67 oz. silver, 36.2 oz. platinum, 267.2 oz. palladium, and 3916 lb. copper, worth a total of \$2686, when all metals were low.

CANADA

BRITISH COLUMBIA

Rich gold ore has been opened in the Fawn mine in the Sheep Creek district. A 4-stamp mill on the adjoining nugget claim is to be used to crush the ore.

At 700 ft. depth in the Queen mine near Salmo a lode of free milling gold ore 30 ft. wide has been opened.

The Princeton district is to be more active than in years.

To develop a property near New Hazelton the Spokane Roehrer De Goule Mining Co. has been formed. A 1000-ft. adit is to be driven. Ore being extracted assays 7% copper, \$2 gold, and 15 oz. silver per ton.

A New York syndicate, headed by Hayden Stone & Co. and D. C. Jackling, has acquired control of the Hudson Bay zinc mines, seven miles from Salmo, for approximately \$1,125,000, according to H. T. Irvine of Spokane. Without waiting for completion of the negotiations the Hayden-Stone syndicate took possession of the Hudson Bay company's property through J. L. Bruce, general manager of the Butte & Superior company. Plans for its development and equipment will be put into execution at once. They include the construction of a railroad 9 miles long from the Nelson and Fort Sheppard branch of the Great Northern line at Salmo, to a point on Sheep Creek, near the mine, where a large concentrator will be built. From this point they will immediately start to drive an adit which will cut the vein 1700 ft. below its outcrop, or approximately 1000 ft. below the cross-cut adit which Cullen and Bacon started, and which also will be pushed to completion. To expedite all this work a complete equipment of machinery will be provided forthwith. With a view to putting the property on a large producing basis an aerial tramway will be immediately constructed from the mine to the terminus of the proposed railway, and a line of motor vehicles put on to handle the ore from that point to Salmo until the railroad can be got into operation. R. K. Neill will remain in charge of the mine under the direction of Mr. Bruce.

ONTARIO

The last yield of the Hollinger was 41,493 tons of \$9.04 ore, with a profit of \$151,393. The Hollinger, Aeme, and Millerton companies and claim 13,147 of the Canadian Mining & Finance Co. are to be amalgamated with a capital of \$25,000,000, under the name of the Hollinger Consolidated Mines, Limited.

At Porcupine the Dome continues to increase its production, which for the first quarter of 1916 amounts to \$513,151. The output for March was \$176,596. With the increase of milling capacity expected from the installation of three Hardinge ball-mills and other improvements, it is anticipated that this year's production will be nearly \$2,500,000.—The annual report of the Dome Lake showed receipts of \$80,797, and expenditure \$74,330. The 10-stamp mill treated 11,827 tons of ore, averaging \$9.12 per ton, with an extraction of 79.98%. The cyanide plant is now ready for operation. Underground development gave encouraging results, ore assaying as high as \$30 per ton having been opened on the third level.—At the Schumacher four quartz veins have been cut on the 600-ft. level, which will yield good milling ore. The mill is treating about 135 tons daily.—During the three months ended March 31, the Porcupine Vipond produced \$53,348 from 11,816 tons of ore, of the average value of \$5.24 per ton. Working costs were \$4.53 per ton. Ore reserves are estimated at 91,000 tons, containing gold valued at \$888,791.—The La Rose of Cobalt, has sunk a shaft on the Maidens-McDonald properties 50 ft. deep, at which point the vein divides into two parts, one 10 ft. and the other 5 ft. wide. Another shaft will be sunk and trenching done.—The shaft being sunk by the Triumph

Mining Co. on the Success, just south of the Schumacher, is down 200 ft., where a level will be driven and the shaft sunk farther. The shaft at the Jamieson claims, now being worked by Chisholm Corporation, is down 10 ft. with visible gold all the way.

At the McVane property, Kirkland Lake, which is under option to the Beaver Consolidated, the shaft is down over 200 ft., with a station cut at 175 ft. The vein dipped out of the shaft at 110 ft.—The Melver Gold Mines is sinking at the



TRAIL TO THE ST. MAURICE MOLYBDENUM MINE. W. E. SIMPSON
COOKING ON SNOW 7 FT. DEEP.

Oakes claims in the Beatrice Lake section, where there is some free gold showing.—Active exploration is under way at the Swastika, which has been pumped out and sampled.—The Lucky Cross in the Swastika district is being worked under option by the Trethewey of Cobalt.

The properties of the Porcupine Independence, consisting of nine 40-acre claims in Jamieson township, have been taken over by a Boston syndicate represented by Albert Sutcliffe & Company.

During March the Kerr Lake mine produced 214,920 oz. silver.

The general manager of the Crown-Reserve Mining Co., Samuel W. Cohen, reports as follows on the results of this Cobalt property during 1915:

Low prices for silver affected profits and costs. The Provincial government removed the necessity of paying royalty. Development totaled 3287 ft. Kerr lake was drained completely, the total water and mud being 700,000,000 gal. The new area opened by the work was not as prolific in veins as had been hoped, but results were satisfactory on the whole, and made it possible to extract known ore containing over 2,500,000 oz. silver. The job paid for itself. Work has been started on the north vein at 500 ft. under the diabase sill. Mining cost 25.15c. per ounce.

The output of high-grade and mill ore was 657,395 oz., making 19,986,536 oz. to date. Smelting and milling cost 16.58c. per ounce.

Total costs were 45.01c. The profit was \$48,611. Dividends, from company's profit, that of the Silver Leaf and Drummond Fraction mines, and dividends from the Porcupine-Crown company, were \$106,129, making \$6,982,721 to date. The surplus is \$269,997.

The company acquired under lease the Globe mine at Dedrick, Trinity county, California. The property is fully equipped and is a regular gold producer.

The Porcupine-Crown Mines, a subsidiary of the Crown Reserve at Cobalt, operates at Porcupine, and the manager, M. W. Summerhayes, reports as follows:

To a depth of 700 ft. development totaled 4569 ft. Diamond-

drilling in flat holes amounted to 2616 ft. So far as opened the ore-shoot is 465 ft. long on the 100-ft. level, 1062 ft. at 200 ft., 1189 ft. at 300 ft., 1097 ft. at 400 ft., 500 ft. at 500 ft., 20 ft. at 600 ft., and 30 ft. at 700 ft. Reserves are estimated at 150,000 tons worth \$1,250,000. Quartz-porphyry probably limits the ore-shoot in the south. Faulting is somewhat troublesome. Underground work cost \$2.93 per ton.

The mill treated 41,326 tons of ore and 5093 tons of old tailing, yielding \$615,538, at a cost of \$1.09, and with 97.7% recovery on the ore and 85.77% on the tailing. All costs were \$6.09 per ton. The net profit was \$330,649, of which \$240,000 was paid in dividends. The surplus is \$269,977.

MEXICO

The new mining law, mentioned in the last issue of this journal, went into effect on May 1.

Bullion, concentrate, and ore shipments from Mexico to Arizona in April totaled 10,185 tons worth \$2,763,900. Of this Nacozari contributed 9396 tons, and El Tigre 234 tons.

JALISCO

(Special Correspondence.)—The Amparo Mining Co. and the Cinco Minas Co. of Etzatlán and Magdalena, respectively, are the largest operators in this State, and the only mines that have been able to keep running through the various difficult periods of changing governments, bandits, and lack of transportation. The smaller properties are unable to work under existing conditions. The richer ore from idle mines is being extracted and treated on a small scale by *buscones*. Nearly all of the former miners and miner-revolutionists are anxious to work, but unless the operations are large enough to maintain a guard at the mine, there is a continuous risk of robbery or worse at the hands of small bands of bandits that travel in the guise of Villistas, or without pretense of being anything else but bandits. The Amparo company has sent 125 lb. of slime to the United States for making flotation tests.

Guadalajara, April 24.

Schools and Societies

The seventy-eighth ordinary meeting of the FARADAY SOCIETY was held on March 15 at the Institution of Electrical Engineers, London. The meeting was devoted to an informal discussion on 'Methods and Appliances for the Attainment of High Temperatures in the Laboratory.'

The TEXAS STATE SCHOOL OF MINES at El Paso has commenced publishing a quarterly called 'The Crucible.' We hope it will improve on the first number, as most of the material is to be found in the principal technical journals, but the editor says the booklet is to be a "melting-pot."

Its fifty-third annual commencement exercises are to be celebrated by the UNIVERSITY OF CALIFORNIA in the Greek Theatre at Berkeley on May 17. The alumni entertain the 1250 who are to receive degrees and the guests of honor at a commencement luncheon in Strawberry canyon immediately afterward. The six weeks' summer session opens on June 26.

During the past month the senior miners and geologists in charge of B. L. Miller of the Department of Geology, and Howard Eckfeldt of the Mining Engineering Department of LEHIGH UNIVERSITY made inspection trips to various mining districts in Pennsylvania and New Jersey. At Cornwall, Pa., the mine and mill of the Cornwall Ore Banks Co. were visited, and opportunity afforded to study the fine example of contact metasomatism found at this place. Mt. Hope, N. J., was visited, and the mine and mill of the Empire Steel & Iron Co. were seen. At Franklin Furnace, N. J., two days were spent studying the mining methods, milling, and geology of the district. One afternoon was spent at the new workings at Stirling Hill.

PERSONAL

Note: The Editor invites members of the profession to send him particulars of their work and appointments. This information is of unquestioned interest to our readers.

W. J. LORING is at Boston.

WALTER STRACHIE sailed for Europe on May 3.

JOHN SEWARD of New York is in Nova Scotia.

R. M. GEPPERT has returned to London from El Oro.

DONALD F. FOSTER has returned from Egypt to London.

BEN. B. LAWRENCE is expected shortly in San Francisco.

R. GILMAN BROWN left London for Petrograd on April 22.

J. PARKE CHANNING has been examining copper mines in Cuba.

WILLIAM E. FENWICK of Detroit is mining copper in western Cuba.

C. B. LAKENAN has been visiting the Utah Copper mine at Bingham.

E. F. GORDON, of the Primos M. & M. Co., is at Globe, Arizona, for a week.

R. B. LAMB is in the Oatman district. He will be there several weeks.

W. C. MADGE and ALFRED TELLAM are at the Ridder mine, in the Altai, Siberia.

HENRY W. HAYDEN has obtained an appointment with the Seoul Mining Co., Korea.

BERNARD H. LASKY of Kennett, California, is examining properties on the Mother Lode.

W. W. MEIN will sail from Cape Town on May 13, returning to New York by way of London.

JOHN ADAM has been appointed manager of the Great Fingall Consolidated in Western Australia.

MAX. J. WELCH sailed from New York to South America on May 6, to be away for several months.

MALCOLM J. MACLAREN is making a geological study of the Oriental Consolidated mines, in Korea.

GEORGE DES ROCHERS of Michigan is on the engineering staff of the Nevada Consolidated Copper Co., at Ruth, Nevada.

R. W. BROCK, formerly director of the Canadian Geological Survey, is major in the Seaforth Highlanders of Canada.

ROBERT A. KINZIE, accompanied by F. R. BURNHAM and H. J. MACOMBER, is examining tungsten and vanadium properties near Globe, Arizona.

COREY C. BRAYTON, C. E. GRUNSKY, JR., and E. L. OLIVER have been selected to represent mining engineers on the Conference Committee of Californian Engineers for Preparedness.

ALLAN J. CLARK, W. J. SHARWOOD, and B. C. YATES of the Homestake Mining Co. have been selected as representatives for South Dakota on the Naval Advisory Board.

FRANCIS CHURCH LINCOLN, Director of the Mackay School of Mines, University of Nevada, Reno, Nevada, will sail from New York on May 27, bound for Peru and Bolivia on mining business.

Obituary

PERCY E. O. CARR died at Saltillo, Mexico, on April 14 after a short illness, having contracted typhus while on a visit to Mexico City. He was manager for the Mazapil Copper Company, to the interests of which he had devoted himself with unwavering loyalty and courage during the protracted period of Mexican brigandage. A graduate of the Royal School of Mines (London), an engineer of unusual ability, a trusty friend, a devoted husband and father, Percy Carr will be mourned deeply by all who knew him.

THE METAL MARKET

METAL PRICES

San Francisco, May 9

| | |
|--|-------------|
| Antimony, cents per pound | 39.50 |
| Electrolytic copper, cents per pound | 31 |
| Pig lead, cents per pound | \$ 00—\$ 80 |
| Platinum, soft metal, per ounce | \$85 |
| Platinum, hard metal, 10% iridium, per ounce | \$89 |
| Quick-silver, per flask of 75 lb. | \$100 |
| Spelter, cents per pound | 22 |
| Tin, cents per pound | 50 |
| Zinc-dust, cents per pound | 30 |

ORE PRICES

San Francisco, May 9.

| | |
|---|-------------|
| Antimony 50% product per unit (1. or 20 lb.) | \$2.25 |
| Chrome, 40% and over, f.o.b. cars California, per ton | 12.50 |
| Manganese 50% metal, 8% silica, per ton | 12.00 |
| Tungsten 60% WO ₃ per unit | 15.00—55.00 |

The U. S. Geological Survey bulletin on chrome-iron ore, by J. S. Diller, has been published.

EASTERN METAL MARKET

(By wire from New York.)

May 9.—Copper is strong and moderately active, lead is dull and easy, spelter is also dull and soft.

SILVER

Below are given the average New York quotations, in cents per ounce, of fine silver.

| Date | Average week ending |
|------------|---------------------|
| May 3 | 77.25 |
| " 4 | 76.87 |
| " 5 | 76.87 |
| " 6 | 76.75 |
| " 7 Sunday | 76.52 |
| " 8 | 74.12 |
| " 9 | 73.50 |

Monthly averages.

| 1914 | 1915 | 1916 | 1914 | 1915 | 1916 |
|------|-------|-------|-------|-------|-------|
| Jan. | 57.53 | 48.85 | 56.76 | July | 44.90 |
| Feb. | 57.53 | 48.45 | 56.74 | Aug. | 54.35 |
| Mch. | 58.01 | 50.61 | 57.89 | Sept. | 53.75 |
| Apr. | 58.12 | 50.25 | 64.37 | Oct. | 51.12 |
| May | 58.21 | 49.87 | 64.37 | Nov. | 49.12 |
| June | 56.43 | 49.03 | 64.37 | Dec. | 49.27 |

The upward bounds of the silver market have been checked by a considerable drop in two days. Imports of metal into England during the first quarter of 1916, 1915, and 1914 were 22,442,591, 26,195,164, and 22,449,016 oz.; while exports were 12,214,273, 20,795,907, and 23,267,969 oz., respectively. For the period of 1916 exports to India were 11,543,597 oz. less than in the same time of 1915.

COPPER

Prices of electrolytic in New York, in cents per pound.

| Date | Average week ending |
|------------|---------------------|
| May 3 | 29.00 |
| " 4 | 29.25 |
| " 5 | 29.25 |
| " 6 | 29.25 |
| " 7 Sunday | 29.50 |
| " 8 | 29.50 |
| " 9 | 29.29 |

Monthly averages.

| 1914 | 1915 | 1916 | 1914 | 1915 | 1916 |
|------|-------|-------|-------|-------|-------|
| Jan. | 14.21 | 13.69 | 24.29 | July | 12.25 |
| Feb. | 14.46 | 14.28 | 26.62 | Aug. | 12.34 |
| Mch. | 14.11 | 14.89 | 26.65 | Sept. | 12.02 |
| Apr. | 14.12 | 16.04 | 28.02 | Oct. | 11.10 |
| May | 13.97 | 18.71 | 28.02 | Nov. | 11.75 |
| June | 13.69 | 19.75 | 28.02 | Dec. | 12.75 |

Copper production of the United States in 1915 totaled 1,388,009,527 lb., compared with 1,170,137,192 lb. in 1914, according to the Geological Survey. Arizona was first, Montana second, Michigan third, Utah fourth, and Alaska fifth. Stocks at the end of the year were 8,429,666 lb., about half of those a year ago.

March yields were as follows: Chino, 6,333,255 lb.; Nevada Con., 6,565,559 lb.; Ray, 6,379,581 lb.; Utah, 12,714,651 lb. April outputs were: Anaconda, 33,200,000 lb.; Inspiration, 9,500,000 lb.; Old Dominion, 3,290,000 pounds.

The A. S. & R. Co. has declared its quarterly dividend of 1%

and extra of 1/2% on common, and 1 1/4% on preferred shares. Copper Range pays \$2.50 per share on June 15.

LEAD

Lead is quoted in cents per pound, New York delivery.

| Date | Average week ending |
|------------|---------------------|
| May 3 | 7.50 |
| " 4 | 7.50 |
| " 5 | 7.50 |
| " 6 | 7.50 |
| " 7 Sunday | 7.37 |
| " 8 | 7.37 |
| " 9 | 7.37 |

Monthly averages.

| 1914 | 1915 | 1916 | 1914 | 1915 | 1916 |
|------|------|------|------|-------|------|
| Jan. | 4.11 | 3.73 | 5.95 | July | 3.80 |
| Feb. | 4.02 | 3.83 | 6.23 | Aug. | 3.86 |
| Mch. | 3.91 | 4.04 | 7.26 | Sept. | 3.82 |
| Apr. | 3.86 | 4.21 | 7.79 | Oct. | 3.60 |
| May | 3.90 | 4.24 | 7.50 | Nov. | 3.63 |
| June | 3.90 | 5.75 | 7.37 | Dec. | 3.80 |

On June 20 the St. Joe Lead Co. pays 25c. per share.

QUICKSILVER

The primary market for quicksilver is San Francisco, California being the largest producer. The price is fixed in the open market, according to quantity. Prices, in dollars per flask of 75 pounds:

Week ending

| Date | Average week ending |
|---------|---------------------|
| Apr. 11 | 152 |
| " 18 | 136 |

Monthly averages.

| 1914 | 1915 | 1916 | 1914 | 1915 | 1916 |
|------|-------|-------|--------|-------|-------|
| Jan. | 39.25 | 51.90 | 222.00 | July | 37.50 |
| Feb. | 39.00 | 60.00 | 295.00 | Aug. | 80.00 |
| Mch. | 39.00 | 78.00 | 219.00 | Sept. | 76.25 |
| Apr. | 38.90 | 77.50 | 141.60 | Oct. | 53.00 |
| May | 39.00 | 75.00 | 141.60 | Nov. | 55.00 |
| June | 38.60 | 99.00 | 141.60 | Dec. | 53.10 |

ZINC

Zinc is quoted as spelter, standard Western brands, New York delivery, in cents per pound.

| Date | Average week ending |
|------------|---------------------|
| May 3 | 17.50 |
| " 4 | 17.50 |
| " 5 | 17.50 |
| " 6 | 17.37 |
| " 7 Sunday | 17.25 |
| " 8 | 17.25 |
| " 9 | 17.12 |

Monthly averages.

| 1914 | 1915 | 1916 | 1914 | 1915 | 1916 |
|------|------|-------|-------|-------|------|
| Jan. | 5.14 | 6.30 | 18.21 | July | 4.75 |
| Feb. | 5.22 | 9.05 | 19.99 | Aug. | 4.75 |
| Mch. | 5.12 | 8.40 | 18.40 | Sept. | 5.16 |
| Apr. | 4.98 | 9.78 | 18.62 | Oct. | 4.75 |
| May | 4.91 | 17.03 | 18.62 | Nov. | 5.01 |
| June | 4.84 | 22.20 | 18.62 | Dec. | 5.40 |

The American Zinc, Lead & Smelting Co. is paying \$12.50 per share on the new preferred stock at par as follows: one-half of a preferred share, of \$25 par value each, to each share of common stock now issued and outstanding, payable on June 15 to common stockholders of record on May 15.

The New Jersey Zinc Co. on May 5 paid its quarterly of 4%, with an extra of 5%, making 33%, or \$11,550,000 in five months. One shareholder, August Heckscher, received \$1,063,062; a dozen others received from \$221,000 to \$994,092.

TIN

Prices in New York, in cents per pound.

| 1914 | 1915 | 1916 | 1914 | 1915 | 1916 |
|------|-------|-------|-------|-------|-------|
| Jan. | 37.85 | 34.49 | 41.76 | July | 31.69 |
| Feb. | 39.76 | 37.23 | 42.60 | Aug. | 50.20 |
| Mch. | 38.10 | 48.76 | 50.50 | Sept. | 35.10 |
| Apr. | 36.10 | 48.25 | 51.49 | Oct. | 30.40 |
| May | 33.29 | 39.28 | 51.49 | Nov. | 33.51 |
| June | 30.72 | 49.26 | 51.49 | Dec. | 33.69 |

Tin is quiet at 50 to 51 cents.

The new smelter of the A. S. & R. Co. is producing 4 tons of tin daily. Within 60 days this quantity will be increased to 15 tons. Bolivian 'barilla' (concentrate) is arriving regularly.

The International Nickel Co. pays \$2 (80¢) a share on June 1, for the quarter ended March 31.

Eastern Metal Market

New York, May 3.

Copper has continued dull, but prices are strong and promise to remain so in view of the sold-up condition of the producers. Some re-sale metal has appeared, but not enough to weaken the market.

Zinc has declined, but the limit of concessions appears to have been reached. Inquiry by the galvanizers has been good since the last report.

Lead has ceased to decline, the leading interest and independents now quoting the same level at New York. The market has been exceedingly dull.

Tin is higher. Difficulty in obtaining licenses to ship from London continues the dominating feature of the market.

Antimony is lower. All efforts to arouse interest on the part of consumers have failed. The supply is abundant.

Aluminum is unchanged at 58 to 60c. per pound.

The steel and metal-working trades are hampered by new strikes which were declared May 1. Hardly a city in the East is not affected by labor troubles, despite general advances in wages, and the condition may not yet have reached its height. The total of pig-iron production in April was 3,227,768 tons, or 107,592 tons a day, against 3,337,691 tons in March, or 107,667 tons a day. New buying of steel products is lighter. There is a halt in the renewal of munitions' contracts, but the plants are working at full pressure on orders in hand. The machine-tool industry is in a healthy condition, except for the many strikes with which it is contending. Everywhere there is an acute shortage of labor and the unions are taking advantage of the fact.

COPPER

The market has continued very dull, and there is not much to report, except that the strength of quotations is unimpaired. Electrolytic for delivery in July and August is quoted at 29c., full terms, and September or later, about 28.50c. Prompt electrolytic has sold at 30.30c., full terms. Lake is unavailable in large quantity this side of September. The nominal quotation is 29 to 29.50c. Some re-sale metal is appearing on the market, offers to sell having been made by a few consumers who have more copper than their immediate needs call for. They would sell, then buy futures, and take the profit thus to be realized. Rumors are current to the effect that France is contemplating some large buying. Prior to the recent extensive sales there were similar rumors. The refineries are behind in their shipments. They have no strikes on their hands at the present time, but labor is scarce, and the freight situation has made it difficult for them to get materials. The London market for electrolytic has continued to gain in strength, the quotation yesterday (May 2) being £145. In April exports aggregated 19,980 tons. European statistics show that stocks in Great Britain and France have further increased. The stocks April 30 totaled 7223 tons, against 6807 tons on the 15th, and 5528 tons on March 31.

ZINC

Students of the zinc market firmly believe that while fluctuations are inevitable, prices generally will be fairly well sustained throughout the second and third quarters of the year. Of the last quarter they will not venture to predict. They do maintain, however, that when the war ends there will be a better margin of profit in spelter than there was prior to the outbreak of hostilities. On the whole the past few days have been quiet, although there was an excellent flurry of inquiry in the latter part of last week, a good deal coming from the galvanizers; but actual business was not as heavy as the inquiry would seem to justify. The market has turned firmer,

and recessions in price are believed to be over for the present. Prompt was quoted yesterday at 17.50c., New York, and about 17.25c., St. Louis. May delivery was 17 to 17.25c., New York, June about 16.50c., and July about 16c. Futures are inactive, the faith of consumers having been spoiled by the report of the U. S. Geological Survey indicating a great increase in production. The Government's figures are considered excessive by the trade, although it is admitted the additional capacity will mean greatly increased production. It is conceded that Great Britain will make herculean efforts to establish on a large scale the smelting of Australian ores in England, with the hope of supplanting Germany in that industry. On May 1 the London market declined £6, but the drop is not regarded seriously here as it is recognized that the London market has been too high in comparison with that which has prevailed at New York. The quotation for spot in London May 2 was £98. April exports totaled 2211 tons.

LEAD

The decline in prices has been checked, with the New York quotation at 7.50c., and that at St. Louis 7.37½c. The A. S. & R. Co. is asking 7.50c., New York, and 7.42½c., St. Louis. The tone of the market has changed from easiness to firmness, a change which the holders of lead brought about very easily. Their efforts to sell brought them nothing, and they ceased to press sales, whereon the market at once took on a better aspect. There has been no business worthy of comment in the past week so far as can be learned. April exports totaled 1372 tons. The London quotation May 2 was £34 10s.

TIN

Not much has been done in tin during the past few days, but in the deals completed the buyers have been those who usually are sellers. They were buying to cover their commitments to consumers, and in view of the higher prices now quoted their plight is a serious one. Their situation is the result of having sold futures at a time when licenses to ship from London were only obtained with the greatest difficulty. In fact the matter of these licenses has been the feature of the tin market for several months, and is the dominating feature of today. In the past week there has been good demand for April, May, and June positions, but sellers have been few. The New York quotation for spot on May 2 was 52.50c. Deliveries into consumption in April aggregated 4202 tons, of which 602 tons came to the East *via* Pacific ports. There was afloat on the 2nd, 3829 tons.

ANTIMONY

The market is plentifully supplied, but consumers cannot be interested, despite the fact that there have been substantial concessions in price. Chinese and Japanese grades are quoted at 37.50 to 38.50c., the American priced down to 36c., yet buyers hold aloof from the market. Needle antimony is offered at 20c. but is equally stagnant. The entire market is weak.

ORES

Antimony: Despite the weakness in antimony, antimony ore continues strong. Its price is supported by the fact that but little is being offered. The quotation is \$2.70 per unit for 50% product.

Tungsten: The market is a nominal one with no prices obtainable. The notions of buyers and sellers as to the market are wide apart, and little or no business has been done. Ideas of what constitute the market differ several dollars a ton. The buyers are under the impression that the many offerings which have been brought out by high prices will eventually bring the market down.

COMPANY REPORTS

INTERNATIONAL NICKEL CO.

Nickel is used in armor-plate and other steels, munitions, German silver, plating, and for many other purposes. The International Nickel Co. secures most of its ore from the Creighton mine at Sudbury, Ontario, and refines the matte from its smelters in Canada at Bayonne, New Jersey. The matte is sent by rail, and contains 55% nickel and 25% copper. During 1915 the company's income was \$7,230,760, against \$6,566,787 in 1914. Holders of preferred shares received \$531,756, and of common shares \$1,753,937. The year's surplus was \$399,778.

SEVEN TROUGHS COALITION MINING CO.

A financial statement of this Nevada company for 1915 shows the following:

| | |
|--------------------------|------------------|
| Gold sold | \$397,070 |
| Other revenue | 11,457 |
| Total | \$411,527 |
| Operating expenses | 215,066 |
| General | 23,587 |
| Total | \$238,653 |
| Profit | 172,871 |
| Dividends (5) | 180,381 |

The year commenced with a balance of \$76,856, and ended with \$69,024. Assets, including cash, bullion, etc., total \$112,681. There are no liabilities.

HEDLEY GOLD MINING CO.

This company operates the Nickel Plate and Sunnyside mines, a 40-stamp mill, and an 1800-hp. hydro-electric power-plant near Hedley, British Columbia. The general superintendent, Gomer P. Jones, reported as follows:

Development amounted to 2784 ft. The Dickson incline in the Nickel Plate, was extended to 825 ft. At the 600-ft. level the orebody is 25 ft. wide, averaging \$12 per ton. \$13 ore is being mined in stopes at 700 ft. Below this, separated by an andesite sheet, is another valuable shoot. It is larger than that above, and worth \$15 per ton. Diamond-drilling gave useful prospecting information. Ore reserves total 423,522 tons, assaying \$16.39 per ton. In the upper part of the mine 12 cu. ft. equaled one ton, but at depth this is only 10 cu. ft. due to more arseno-pyrite. This resulted in a large increase of concentrate, so a system of total cyanidation is being adopted. General improvements in 1916 will cost \$60,000.

The output was \$796,592 from 74,265 tons of ore, or \$11.65 per ton. Of the \$274,716 profit dividends absorbed \$300,000. The surplus is \$425,070.

UNITED STATES SMELTING, REFINING & MINING CO.

This controls the U. S. Smelting Co., U. S. Metals Refining Co., U. S. Smelting, Refining & Mining Exploration Co., the Centennial-Eureka and Richmond-Eureka mining companies in Utah, the Mammoth Copper and Needles Mining & Smelting companies in California, the Gold Road Mines Co., in Arizona, and the Compania de Real del Monte y Pachuca in Mexico.

The output of metals in the past three years was as follows:

| Metal | 1915 | 1914 | 1913 |
|----------------------|------------|------------|------------|
| Copper, pounds | 26,923,674 | 17,946,659 | 26,239,973 |
| Gold, ounces | 196,481 | 124,719 | 148,372 |
| Lead, pounds | 87,102,179 | 64,443,260 | 58,116,594 |
| Silver, ounces | 12,071,863 | 9,936,237 | 13,089,768 |
| Zinc, pounds | 34,195,471 | | |

To total amount of ore from the Centennial-Eureka, Mam-

moth, Gold Road, Tennessee, and Itingham mines, also mines in Mexico was 1,066,025 tons, of which the values of the metal contents were in the proportion of 30% copper, 5% lead, 21% zinc, 2% silver, and 19% gold. The Real del Monte mills were operated at 50 to 80% of their capacity, in spite of great handicaps.

The year's net profit was \$6,592,321, plus \$1,515,592 from 1914, a total of \$11,107,916. Dividends absorbed \$1,965,561, and reserves for depreciation \$880,960, leaving \$8,253,455 for 1916. Assets include \$2,482,831 cash, and metals, ore, supplies, etc., \$9,023,575; liabilities include accounts payable and pay-rolls, \$935,727; drafts in transit, \$712,394, and reserves for refining, etc., \$1,283,225.

The past year was one of great and increasing prosperity for the company, the earnings being the largest in its history. Three zinc smelters were acquired in Kansas, and a mine in Missouri, at a total cost of \$953,598. There were 786 properties offered for consideration; 655 were turned down, 118 had preliminary field examinations, and 13 were completely investigated.

BUNKER HILL & SULLIVAN MINING & CONCENTRATING CO.

This well-known Idaho company has been frequently discussed of late on account of its extra dividends and the great lead smelter to be erected at Kellogg. The report of Stanley A. Easton, the manager, is brief, but the statistical data is interesting and is best tabulated as below. Of the net available surplus of \$1,819,888 dividends absorbed \$1,062,750. The Caledonia and Sierra Nevada companies adjoining, and under Bunker Hill management, paid the latter \$532,558 in dividends. On account of an unsatisfactory smelting contract with the A. S. & R. Co. the Sierra Nevada has not sold any ore since April 29, 1915. Both mines contain considerable quantities of ore. Reserves in the Bunker Hill mines total 3,573,930 tons. The Stewart company paid \$15,000 in full settlement of ore removed from the Saxon claim. Exploration on No. 14 level of the Bunker Hill, 1000 ft. below the Kellogg tunnel, was generally satisfactory. Mr. Easton discusses the smelting company's charges, and the reason for the proposed smelter. While the cost of producing lead was 1.5c. per lb. at Kellogg in 1915, the same as in 1914, the smelting company's charge increased from 1.91c. in 1914 to 2.7c. per lb. in 1915. This was due to a modification of the contract expiring in June, 1915, which the smelting company refused to renew. Taking everything into consideration the new smelter at Kellogg is justified.

Some details of last year's work are as follows:

| | |
|--|----------------|
| Exploration, feet | 4,783 |
| Average cost per foot | \$7.317 |
| Cost per ton: | |
| Stoping 455,205 tons | 1.351 |
| Tramming 455,205 tons | 0.056 |
| Hoisting 385,985 tons | 0.047 |
| Pumping | 0.034 |
| Underground improvements | 0.024 |
| General mine expense | 0.433 |
| Total mine charge, per ton | \$1.999 |
| Mills in operation, days | 356 |
| Ore concentrated, tons | 441,854 |
| Cost per ton: | |
| Crushing and conveying | \$0.061 |
| Screening and jigging | 0.081 |
| Grinding | 0.050 |
| Concentrating | 0.076 |
| Improvements and general | 0.157 |
| Total treatment charge, per ton | \$0.425 |
| Concentrate shipped, tons | 59,424 |

Details of concentration will be given in another issue of

this journal. The revenue from silver and lead was \$4,139,393; dividends and other income made a total of \$4,802,033. The net profit was \$1,725,442, of which \$1,062,750 was distributed. The balance from 1914 was \$3,245,475, and that carried forward to 1916 \$3,691,166.

ALASKA JUNEAU GOLD MINING CO.

According to the president of this company, F. W. Bradley, by the end of 1916 the mine will be prepared to supply for treatment 8000 tons of ore daily. Practically all ore and waste removed during development in 1915 was sent to the 50-stamp 'pilot' mill, recovering \$201,036 from 179,892 tons. Different machines were tested and a flow-sheet for the new mill devised. Practice at the Gastineau mill near-by, and the Inspiration in Arizona was studied, resulting in ball-mills being decided on for the main reduction and the Deister rougher and slime-tables for concentration. Contracts for machinery have been let, but on account of delays in winter the first unit will not be ready until March, 1917.

The secretary, G. D. Abbott, states that the cash on hand on January 1, 1916, was \$2,232,123, sufficient to pay all obligations and bring the property to the point of treating 8000 tons a day. The revenue in 1915 was \$253,483, and net loss \$544,700, which is accounted for by the treasury stock sales expense of \$544,760, interest, etc. In the treatment of 239,918 tons to date, producing 11,193 oz. gold bullion, 333 oz. base bullion, 151 tons of galena concentrate, and 1492 tons of iron concentrate, worth \$270,426, the yield was \$1.1272 per ton, from ore averaging \$1.4483 per ton.

The general superintendent, P. R. Bradley, reported as follows:

An average of 301 men were employed at \$3.52 per day. There was plenty of labor available. Co-operation in departments was commendable. Development amounted to 16,775 ft., against 5495 ft. in 1914. The most important work was done on the north orebody on No. 4 level, preparing it for an output of 8000 tons daily. The system of mining includes the undercutting of a section of the orebody about 700 ft. long by 250 ft. wide, driving intermediate levels, placing ore-chute raises and bulldozing chambers at regular intervals, and the driving of 18 raises from the back of the cut area to the level above. From these raises numerous powder drifts are to be driven for blasting and forcing the rock to cave as required. The chutes are 6 ft. wide with 3½ ft. clearance below the head-blocks, and are fitted with arc-type gates. The drifts and

Gold Creek tunnel were trimmed to allow of the passage of 10-ton cars to be used when milling commences. Work to be completed by September 1, 1916, totals 21,936 ft., of which 40.61% was done by December 31 last. Other work was done on No. 4 level, also some stoping above it to supply the mill and prepare for future work. Development proceeded on No. 2 level. In the first five months of 1915 all ore was sorted in the stopes. Machine-drill duty in stoping was 50.2 tons a

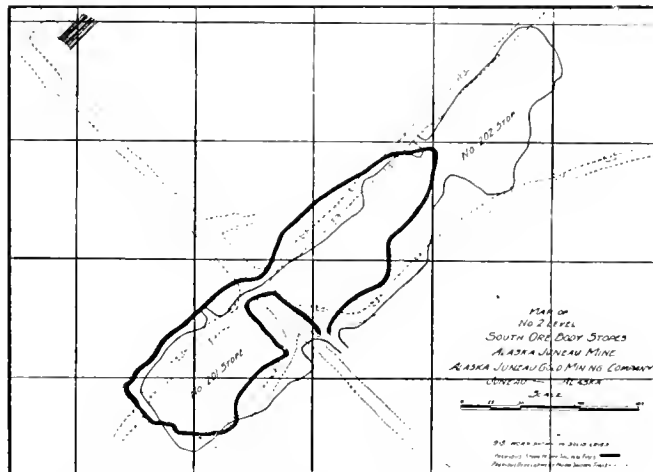

shift; in cutting out, 19.7 tons. Samples numbering 1329 from development averaged \$1.04 per ton; the Aurora orebody on No. 2 level \$2.09, and the north orebody on No. 4 \$1.01 per ton.

The 50-stamp mill operated 318.33 days. With a ¼-in. screen the duty ranged from 11.2 to 19.7 tons per stamp-day, an average of 14.45 tons; through 8-mesh, 8.88 tons; and through 24-mesh, 5.77 tons. The average daily capacity was 565.09 tons. With all ¼-in. screens and Chilean mills the capacity would have been 900 tons. Lead concentrate was sent to the Selby smelter. The recovery from the iron concentrate, assaying \$19.52 per ton, was 77.51% at the mill. This product was re-ground in a Hardinge mill.

For the new 8000-ton mill the following was done: grading for coarse-crushing plant 30% done; grading for power-plant and 50,000-gal. oil-tank commenced; grading done on the tram-line to the mine; and No. 2 dock and warehouse constructed. A considerable amount of other construction was accomplished at various points.

The Disseminated Copper Mines in 1915

The following table is a summary of results at the so-called porphyry mines during the past year, as compiled from the reports for 1915:

| | Ore treated, tons | Copper produced, pounds |
|-------------------|-------------------|-------------------------|
| Chino | 2,379,800 | 64,887,788 |
| Inspiration | 778,851 | 20,445,670 |
| Miami | 1,348,122 | 41,832,059 |
| Nevada | 3,081,520 | 62,726,651 |
| Ray | 2,848,969 | 60,338,936 |
| Utah | 8,494,300 | 148,397,006 |
| Total | 18,931,562 | 398,628,110 |

*Only 6,134,355 lb. delivered. †\$1.25 per share, May 1, 1916.

The percentages of recoveries were as follows:

| Mine | 1915 | 1914 |
|-------------------|-------|-------|
| Chino | 66.59 | 67.86 |
| Inspiration | 79.95 | |
| Miami | 75.17 | 69.93 |
| Nevada | 70.18 | 68.48 |
| Ray | 64.11 | 67.88 |
| Utah | 64.13 | 66.04 |

| Value of copper sold | Net profits | Dividends paid | Cost, cents per pound |
|----------------------|--------------|----------------|-----------------------|
| \$11,303,956 | \$6,913,983 | \$2,609,860 | 7.12 |
| *1,138,878 | 600,962 | †1,875,000 | 8.13 |
| 7,262,884 | 3,589,681 | 1,681,004 | 8.76 |
| 11,069,670 | 5,905,602 | 2,999,185 | 8.23 |
| 10,470,274 | 4,589,142 | 1,872,319 | 9.42 |
| 26,235,331 | 17,913,481 | 6,904,082 | 7.48 |
| \$67,480,993 | \$39,511,951 | \$17,941,450 | |

With the Inspiration now yielding nearly 10,000,000 lb. per month, the present rate of production for these properties is over 550,000,000 lb. per annum.

At the Inspiration the recovery on sulphide ore was 88.56%, now 91%, the oxide copper reducing the general average.

INDUSTRIAL NOTES

An Improved Oil-Engine

In a 14-page publication the Bessemer Gas Engine Co. of Grove City, Pennsylvania, describes the manufacture and operation of its well-known engines in detail. The company is constructing a heavy-duty type of hot-bull or semi-Diesel engine which merits consideration. Its general design (two-cycle principle) has much in common with that of the modern automatic steam-engine. The reciprocating parts are fully enclosed and run in an oil-bath. The connecting-rod thrust is borne by a cross head fitted with adjustable bronze shoes. The design of the crank shaft bearings is novel, combining, as

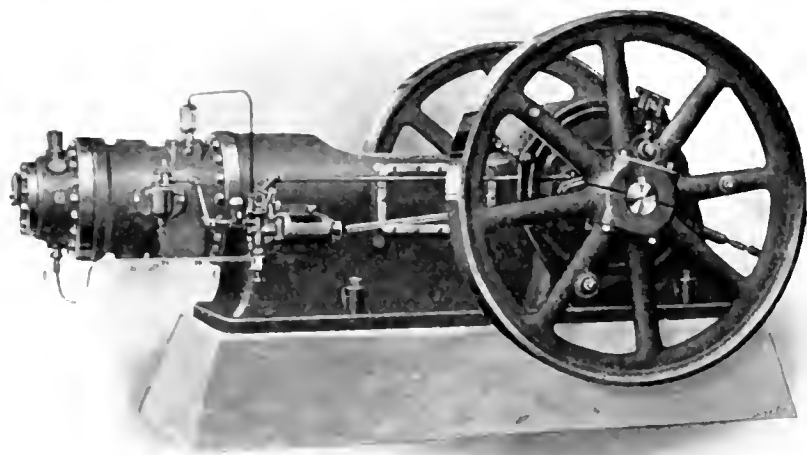

A NEW SEMI-DIESEL TYPE ENGINE.

it does, the virtues of the four-part box with the simplicity and the rigidity of the two-piece bearing-shell. The connecting rod is of the marine type, fitted with babhitt-lined bronze shell in the crank-pin end and a solid bush at the cross-head pin.

The scavenging air does not pass through the crank-case, but is compressed in the crank-end of the cylinder instead, the latter being isolated from the crank-case by a stuffing-box, fitted with bronze-metallic packing. The inlet-valve which admits the scavenging air to the crank-end of the cylinder is of the Corliss type and double-ported. It is silent in operation and efficient, the pressure-drop through the valve-ports being less than one-half pound.

The fuel-pump is operated by an eccentric carried by a shaft-governor of the inertia type.

Water feed to the combustion-chamber is handled by a small pump also under governor control. This pump is mounted in the fuel-pump housing and driven from the fuel-pump cross head to a short reversing lever.

The governor itself is of rather peculiar design, having been devised to meet the conditions imposed upon it by this particular class of service.

The engine will operate satisfactorily on a broad range of fuels without change of adjustment. This range includes the oils put on the market recently by many of the larger refineries and known as Diesel engine fuel-oils.

This design is conspicuous for its ruggedness and weight. Bearing dimensions are unusually large and hardened, and ground-work is used throughout on all small steel wearing-parts, opposed to phosphor-bronze bushings, which are renewable.

Commercial Paragraphs

The INGERSOLL-RAND Co., of New York, has recently issued three new bulletins as follows:

Form 3036 on turbo-blowers: These are suitable for any air service where the capacity requirements range from 3000 to 35,000 cu. ft. of free air per minute, at pressures of 1 to 2½ lb. They are particularly adapted to such work as foundry-cupola blowing; atomizing oil for oil-burners; supplying blast to various kinds of heating and annealing furnaces; blowing air for water-gas generators; pneumatic conveying systems, and for ventilating purposes. Form 3029 describes the Ingersoll-Rogier Class 'ORC' Corliss steam-driven air-compressors of the familiar duplex-type, with the steam cylinders next to the frames and separated from the air-cylinders by open distance-pieces. This type of machine is offered in four different combinations of cylinders. The catalog gives sizes and capacities. Form 4120 describes the Leyner-Ingersoll water-drills, both the No. 18 and 26 types. The catalog explains the construction in detail and illustrates the different types, including numerous installation views. Copies of these bulletins are free on request to the nearest branch office.

A recent article in the trade press called attention to the fact that all the electric furnaces in Germany, operating under war conditions, were turning out 129,646 metric tons of steel every 12 months. If the SNYDER electric-steel furnaces recently sold, and those in operation today were suddenly mobilized for war service, on 24-hour basis, they would make 77,975 tons of steel a year, or within 40% as much steel as all the electric furnaces operating in Germany. These figures do not take into consideration the 12 furnaces sold in foreign countries, as well as several sold in this country which cannot be used for the smelting of steel. Europe is the originator of the electric furnace, and the steel foundry-men on the continent are considered progressive. Judging, however, from the above facts, manufacturers in this country are keenly alive to the value of the electric furnace.

Marked activity is shown in the placer mining districts of Alaska and northern California. The UNION CONSTRUCTION Co., of San Francisco, is keeping its shops working at capacity filling orders received since the first of the year. The company recently experienced the novelty of receiving a telegraphic order for a completely equipped 2½-ft. gold-dredge for George Roley, Iditarod, Alaska. Another dredge of 2½-ft. capacity and one of 3½ ft. are already under construction for the new district of Kuskokwim on Candle creek, Alaska. Four placer prospecting drills have been sent to this district, Alaska, as well as the western United States, has placed orders for fifty Neill jigs since January 1.

Seventy Lilly hoisting-engine controllers are being made for the Anaconda company at Butte. This machine is the invention of W. J. LILLY of Butte, Montana, who also manufactures it, and a booklet has been published describing the device. Briefly the controller is a governor attached to a hoist whereby it will prevent the engine 'running away' and give various warnings of danger, of importance in these times of fast haulage.

A 10-cu. ft. dredge is to be constructed for the Chicksan concession, Korea, by the NEW YORK ENGINEERING Co.



EDITORIAL



T. A. RICKARD, *Editor*

THE AUTHOR of the article on 'Double Roasting at East Helena' appearing in our issue of May 6 desires to apologize to the East Helena management. We are glad to assume all the responsibility ourselves, without apology. The information was given to us for publication, but not by the author. There is every reason to believe that it will do good, rather than harm, to the development of smelting practice at East Helena. Our aim is to help many and to injure none.

AS showing which way the wind of public opinion is blowing, it is worthy of note that the Northwest Mining Convention passed resolutions (1) opposing legislation calculated to disturb the good work being done by the Bureau of Mines, (2) thanking the Secretary of the Interior for expediting the issue of patents, (3) recommending changes in the Mining Law and also the appointment of a commission to revise the existing regulations, (4) asking for the establishment of an experiment station, under the Bureau of Mines, at Spokane.

TAXES in Mexico have lost their immediate interest, because nobody knows a month ahead who will collect them. The Carranza government has declared a 10% export and import tax on gold in any form and a 5% tax on silver. Another decree imposes a tax of \$3, payable in Mexican gold coin, on claims covering less than 10 hectares, \$6 for areas between 10 and 50 hectares, \$9 for those less than 100 hectares, and \$12 for over 100 hectares. These imposts went into effect on May 1, despite a protest from the American government. However, the biggest tax paid by those mining in Mexico is the uncertainty as to which moment will be their next.

AMERICAN participation in the exploitation of Africa includes the concessions in the Congo region secured nearly ten years ago by the Guggenheims from the late King Leopold of Belgium. Among the larger stockholders are Messrs. Thomas F. Ryan, B. M. Baruch, and A. C. Beatty, the last having conducted the negotiations that preceded the business. About \$2,000,000 has been spent on these African concessions and various mineral deposits have been uncovered, the most productive so far being diamonds, although gold, rubber, and ivory are mentioned as sources of future revenue.

TUNGSTEN is a metal much in demand, and the prospecting and mining of it are attracting attention in various parts of the West. In this issue, under the Review of Mining, we publish letters from Ely, Nevada, and Fairbanks, Alaska, both recording the beginning of new tungsten mines. At the former place,

quartz veins that were prospected in earlier days for gold and silver have been found to contain scheelite and hübnerite. In the Alaskan region, prospectors traced scheelite 'float' to the veins that were its source, and have found this tungstate of lime in gold-bearing quartz, in a manner resembling the veins at Grass Valley described in our issue of January 8.

METHODS of stoping by branched raises are discussed in this issue by Mr. F. W. Sperr, Professor of Mining in the Michigan College of Mines. This relatively new system of underground excavation is interesting because of its simplicity and because of its recent adoption in modified forms at several important Western mines. The Nevada Consolidated Copper Co. is using a system of branched raises at its new Ruth mine near Ely, in conjunction with the well-known Ray method of caving. We shall have more to say of the underground conditions at the Ruth mine in a later issue. Professor Sperr's article will be found of interest because he writes from the point of view of a Lake Superior engineer that has visited many of the Western districts. Several of the present methods of stoping, more particularly in wide orebodies, were worked out in the Lake Superior region, and were then adapted and modified in the West.

DISCUSSION this week covers six pages. We are glad to extend this department of the paper, for the subjects discussed are those of immediate interest to our readers and we like them to have their say on matters that concern them most. The first letter furnishes some short-cuts to the estimation of tonnage in a flotation mill; it is contributed by Mr. C. Eustace Dwyer, foreman of one of the Federal Mining Co.'s mills in the Coeur d'Alene. The next contribution discusses sundry peculiar features of the Republic ore deposits, arguing that these are the end-products of magmatic differentiation. Mr. A. M. Balfour is a mining engineer resident in the district and thoroughly familiar with local geologic conditions. The Foster bill for amending the mining law was criticized recently by us, and we are glad now to print an expression of opinion from one of the men most directly affected by the proposed alteration. Mr. George E. McClelland speaks for the prospector. Another subject of general interest just now is the Patent Law, concerning which we have published several communications. Mr. William E. Greenawalt, who gives us his views this week, is a metallurgical engineer who can write feelingly on the subject, for he is many times an inventor himself. His opinions are at variance with

those previously published by us and that makes them all the more welcome. Most miners are familiar with the tellurides of the precious metals, but their sister compounds the selenides are more rare. Mr. Walter W. Bradley, of the California Mining Bureau, gives some valuable notes concerning the detection of silver and gold in combination with selenium. Finally, we publish a most useful criticism of Arizonan practice in drill sharpening contributed by Mr. Lucien Eaton, superintendent of an important group of iron mines belonging to the Cleveland Cliffs Iron Company in the 'hard ore' district of Michigan.

HIGH FINANCE has found an interesting exponent in Mr. Otto H. Kahn, of the banking firm of Kahn, Loeb & Co., New York. He insists that "finance does not mean speculation" nor "fleecing the public, nor fattening parasitically off industry." He also gives us a new definition of a 'financier,' who is one that "has some recognized relation and responsibility toward the larger monetary affairs of the public." That is well; and on those rare occasions when that relation becomes not only parasitic but piratic, let us call him not a financier but a grand larcenist. Mr. Kahn confesses grudgingly that "high finance has in some instances strayed from the highest standard" and "there have been some occurrences which every right-thinking man must deplore." Deplores is not enough; let the "right-thinking man," such as Mr. Kahn, refuse to do business with predatory speculators. The brutal fact is that business makes strange bed-fellows; the man who can make money, and keep out of jail, can find partners in the highest circles of finance.

WE have received a copy of a pamphlet on the 'Origin and Distribution of Ore in the Coeur d'Alene' by Mr. Oscar H. Hershey. To tell the truth, we had a chance to publish this essay in our columns and would have been happy to do so but for the fact that it was too long and could not be abbreviated without being spoiled. To those who are interested in the geology of that important mining region of Idaho, this pamphlet will appeal as a careful and lucid presentation of the evidence bearing upon the origin and distribution of the silver, lead, copper, and zinc ores, now the subject of successful mining on a large scale. Mr. Hershey marshals his own observations and gives courteous attention to those collected by others, notably the gentlemen of the U. S. Geological Survey. He divides the veins into systems based on geologic age; he notes the mineral combinations characteristic of these vein-systems; and then he tests the theory of a zonal arrangement with relation to the intruded granite. This hypothesis he attacks vigorously, and in lieu of it he suggests a diffused mineralization in one particular terrain as the source of nearly all the lead and zinc in the ore deposits of the Coeur d'Alene. In short, he challenges the magmatic theory advocated by Mr. F. L. Ransome and other gentlemen of the Survey. In this tilt, he has our hearty sympathy, for we have the best of goodwill for the work of the energetic

mining engineers who have pioneered the geologic study of so many of our Western mining regions, making investigations and collecting observations that have been more useful to actual mining and more helpful even to the Survey than the ungracious acknowledgment of some of its officers would permit one to infer. Mr. Hershey has devoted a great deal of conscientious study to the Coeur d'Alene. In behalf of the mining public, especially on the Pacific Coast, we tender our friendly appreciation.

GASOLINE is a product in such general use that the price of it is a matter of concern to the major part of the community. Hence a discussion of the conditions contributory to the high cost now prevailing is timely. We are indebted to a contributor, as modest as he is well informed, for an article on the subject. His argument is summarized by two graphic diagrams, one contrasting production with the number of automobiles in use and the other exhibiting the relation between the yield from the Cushing well and the price of crude oil in the state of Oklahoma. He emphasizes the expansion in the use of the internal-combustion engine as the chief factor in the rise of gasoline and suggests that relief for the consumer will come through such processes of fractional distillation as have been developed already by Messrs. Burton and Rittman, whereby an increased yield of gasoline is obtained from crude oil. It is noteworthy that the ratio of gasoline production to crude-oil production increased from 6.9% in January 1915 to 9.2% in December of that year. It is estimated that the number of automobiles in use in this country will increase during the current year from 2,000,000 at the beginning of the year to 3,000,000 at the end. It is also noteworthy that the Federal Trades Commission has ascertained that the Standard Oil Company's price for gasoline was 4% below that charged by 47 other refineries, so that the idea of a monopolistic conspiracy does not seem warranted. A good deal of loose talk is prevalent on the subject of oil production. Prominent people at Washington are calculating that if the present rate of output is maintained we shall find our reserves of oil exhausted in 23, 27, or some other specific term of years. A Californian authority, in a Senate document, closes a valuable summary of statistical information with the threat of a speedy exhaustion of our oil-supply and indulges in a rhetorical climax in which we are given a vision of the day when "our battleships will swing helplessly at anchor, and our country will resound to the martial tread of a triumphant foe." This we consider without sufficient warrant of fact. Substitutes for gasoline are bound to be found as the 'cracking' process is developed; indeed, the making of benzol from coal is already furnishing an alternative fuel for the motor-engine. Our resources in oil-shale—in Wyoming, Colorado, and Utah—have hardly been touched. But in deprecating exaggeration concerning the exhaustion of our oil supplies, we do not minimize the stupidity of burning crude oil as fuel, and thereby wasting so many of the more valuable by-products, as is done at the wells themselves.

Aids to Success

In recent issues our readers have joined with us in discussing the essentials of mining education and the qualifications of a successful mining engineer. An honored contributor, himself formerly professor in a well-known School of Mines, writes to say: "Somehow or other the successful engineer lacks in many instances the qualifications that recent writers consider so essential. You know a lot of these men; why not study them and give us some cold-blooded deductions—not what you would like to find, but what you actually do find." That is a challenge to which we respond herewith. So we start by saying that apparently the first requisite is good health. Undoubtedly a man's physical strength and activity, as ordinarily understood, are factors in his exacting work as a mining engineer, not only in youth when he is a junior member of the staff in mine or mill but in the riper years when he has to travel to the waste places of the earth and expose himself to the rigors of inclement climates or the miasmas of the jungle. That is why we tell our young friends not to go to malarial countries, risking an infection that is so hard to eradicate. Sell not your birth-right for a mess of pottage. Physical unhealthiness is a cause of mental unfitness. A man's temper, even his temperament, in large measure, is the reflex of his bodily condition. Joyous good health not only promotes clear thinking but makes men attractive to their fellows. It is true, poor health did not deter some great men, like Darwin and Huxley, from splendid intellectual achievement, but the average man succumbs under conditions so unkind. Lacking the stamina for sustained effort, he is unable to apply himself with assiduity to his work, so that his contemporaries pass him in the great competition. Therefore we choose good health as the first gift to the fortunate. Next, we reckon a good start: the favors of kindly circumstance, such as a father able to pay for the necessary education, a kind uncle to give the graduate a job, and friends glad to give a push when most needed. Of course, there are a few—a very few—who have succeeded despite the lack of all such aids; they picked up their education as best they could, from books, at night-school, from chance acquaintances; they started by doing manual labor; they won grudging promotion by their merit, and owed little to patronage until they had placed a firm foot on the ladder of success. Such men are the finer and stronger for the struggle from which they emerged victorious, but even as regards some of these we think the world has lost by not giving them the best of education and training, at the start, and thereby developing to their highest the exceptional powers and peculiar aptitudes now manifest. So, next to good health, we put 'push' and 'pull.' Those are the words, as we have said before, written on the opposite sides of the door that opens the way to a successful career. Next in importance we put the knowledge of men, the ability to diagnose human motives, the instinct to say and do the right thing, the psychologic intuition that enables a man to guess which way the cat is going

to jump. This quality is one that may become cultivated in the course of experience; it will make a man helpful, sympathetic, and loyal, or, by the perversity of nature, it may be used by him to humor, thwart, and deceive his fellows. Looking around us, we see men who have become successful and honored by the proof of good faith and loyalty to their associates and employers, but we also see men who have become rich and powerful by lack of scruple and a selfishness that disregarded honorable obligation. In life, as in poker, the bluff sometimes succeeds; even the four-flush may take the pot from a moderately good hand. Self-assurance may cover many defects of training and knowledge. You can fool most of the people for a considerable period of time. Given equal ability, the confident man is likely to out-distance the modest one. Confidence is strength.

Next, we mention perseverance. Here we are in close agreement with the Sunday-school teacher. Persistence of effort and tenacity of purpose are forces that accomplish wonders. To 'make up your mind' to master a given branch of technology and so become a leading specialist is not, however, the same thing as dreaming of getting there or ruminating on the pleasure of having got there. Many men we know owe a great deal to an innate obstinacy that enabled them, through thick and thin, through smooth and rough, to "keep their eye on the ball." This fixity of purpose or stability of mind is what constitutes character, as distinguished from the want of it. "Weak as water" and "a cake not turned" are the type of Ethelred the Unready. Such are not born to success. Tenacity of will, even in men not greatly gifted, will suffice to take them far on the road to achievement. So we put the chief factors of success in the following order: good health, the favor of circumstance, knowledge of men, perseverance. To these we might add, as a factor peculiarly conducive to pre-eminence under the conditions of modern industrial effort, the power of organization and the executive ability that usually goes with it, so tremendously in demand wherever complex and far-reaching technical operations are being conducted with the aid of much capital and more men. Of course, in all of this we have assumed some measure of mental endowment: in other words, a moderately clever young man. There always will be inequalities of brain-power, despite the declarations of perfervid rhetoricians; some men scarcely know their right hand from their left; others can orient themselves at a moment's notice; witless will serve his master to the crack of doom; but in estimating the factors of success we must assume—and we have assumed—at least an average proportion of ability. And we conclude that the handicap of differences of ability at the start is more than overcome in the long race that begins in youth and ends in old age. There remains only the definition of "success." We have had to give the word its conventional significance, which is that of a prosperous conclusion or an advantageous result. Some men not deemed "successful" in the common meaning of the word are happy in having got what they wanted; others lab-

ded "successful" have found that the cool waters beckoning them were only a sandy waste. 'Success' may be a rainbow or a mirage. To most men the chase is better than the kill, the striving is finer than the achievement; in any event, it is certain that no man can be happy who is not his own philosopher.

United States Smelting

We referred the other day to the fine showing made by the American Smelting & Refining Company in its annual report. It appears that its chief competitor, the United States Smelting, Refining & Mining Company also did well last year. Some details concerning this important enterprise will interest our readers. The company was organized in 1906—just ten years ago—as a holding corporation for enterprises of the character indicated by its name. It owed its origin to that energetic individual, the late Albert F. Holden, backed by a group of capable Boston men, notably Messrs. William G. Sharp, W. H. Coolidge, and B. Preston Clark, also the late Robert D. Evans. The technical staff includes Messrs. Frederick Lyon, Sidney J. Jennings, A. P. Anderson, George W. Heintz, and Carlos W. Van Law. The operations in which the company engages, through its subsidiary organizations, are of a most diversified character, industrially and geographically. Among the mining properties the most interesting just now is the Real del Monte at Pachuca, where, despite Mexican misrule, the work of underground exploration was rewarded a few months ago by the discovery of a large tonnage of rich silver ore on the 1400-foot level. This property includes 180 mining claims, covering 4270 acres, besides 26,000 acres of agricultural land—evidently a magnificent estate. During 1915 an output of 390,000 tons was made, the average content being 13.9 ounces of silver and \$1.48 in gold per ton, exploited at an average total cost of \$4.16 per ton. The output of silver, namely, 5,321,000 ounces, is being exceeded this year, being at the rate of 700,000 ounces monthly. The deepest workings are at 2050 feet and one of the difficulties of operation is the expense of pumping. However, this Mexican venture gives promise of being an increasingly productive enterprise. In Utah the company controls the Centennial-Eureka and Bullion-Beech mines in the Tintic district, and the Telegraph, Niagara, and other mines in the Bingham district. In Nevada it controls the old Richmond and Eureka properties, now consolidated, but awaiting the rebuilding of the branch railway before resuming operations on an adequate scale. In Arizona the company owns the Gold Road mine, at Oatman; this has proved a poor purchase, the ore decreasing in richness on the lower levels, but the mine is yielding a small profit pending further exploration in depth. The Tennessee mine, at Chloride, in the same region, is being operated productively under lease and bond. In Shasta county, California, the company controls the important Mammoth mines, besides several promising groups of claims in the vicinity. Last year the production was

251,907 tons of ore averaging 4% copper and \$2 per ton in the precious metals. In addition 41,766 tons of zinc ore was produced.

Among the company's metallurgical operations are the Mammoth copper smelter, with a capacity of 450,000 tons of charge per annum. This establishment also treats custom ores from mines in California, Nevada, and Oregon. At Needles, on the Colorado river, the company has a concentrating mill that treats the output of the Tennessee mine and custom ore from other mines across the river in Arizona. In Utah the important lead smelter at Midvale belongs to the United States Smelting Company, which also operates a lead-zinc concentrator in the same locality. The smelter has a capacity of 481,800 tons of charge per annum, while the concentrator has about half that capacity. Both are designed on the most modern lines. The company also owns zinc smelters at Altoona, Iola, and La Harpe, all in Kansas. These have had the advantage of the increased production of zinc ores and the rising price of spelter. The three zinc plants have an aggregate capacity of 91,000 tons of ore per annum; they use gas for fuel and are equipped for extracting the precious metals. Recently the company has taken a lease on the Ravenswood mine in Missouri and has erected a mill of 218,000 tons yearly capacity to treat the zinc ore produced. The company controls a copper smelter and an electrolytic copper refinery at Chrome, New Jersey. The latter has a capacity of 180 million pounds of copper, while the smelter can treat 200,000 tons of charge per annum. Ores, mattes, and other products are received from Canada, Spain, Cuba, and South America, besides the company's own mines in this country. Finally, at East Chicago, the company owns the Grasselli lead-refining plant, which has an annual capacity of 72 million pounds of lead. In these two refineries the company holds only an equal interest with Aron Hirsch & Sohn of Halberstadt, Germany.

On turning to the annual report we find that these multifarious energies made a turn-over, last year, of

| | Total | Value | Average price |
|--------------|----------------|-------------|---------------|
| Copper | 26,923,674 lb. | \$4,894,723 | 18.18c. |
| Lead | 87,102,179 " | 3,954,438 | 4.54 |
| Zinc | 34,105,471 " | 5,102,178 | 14.96 |
| Silver | 12,971,963 oz. | 6,031,017 | 49.96 |
| Gold | 196,481 " | 4,061,262 | \$20.67 |

The total earnings were \$7,579,184, out of which a profit of \$6,592,324 is declared. From this a 7% dividend was paid on 486,350 preferred shares of \$50 each and 75 cents per share on 351,115 common shares of \$50 each. The total capitalization is \$75,000,000, half in preferred and half in common stock. At the beginning of this year the company organized a metal-selling agency of its own, emphasizing its status in the business of mining and smelting. The past year was one of expanding prosperity, the gross and net earnings alike being the highest in the company's history. As far as the miner is concerned, it is a good thing to have competition in the smelting business and we are glad therefore to see this company prosper.



DISCUSSION

Our readers are invited to use this department for the discussion of technical and other matters pertaining to mining and metallurgy. The Editor welcomes the expression of views contrary to his own, believing that careful criticism is more valuable than casual compliment.

Tonnage Formulas

The Editor:

Sir—Having noticed Mr. John Allingham's formula for estimating slime tonnage, I am submitting a chart that flotation men may be glad to use in estimating the consumption of oils and acids in their plants per ton of feed.

For my copy of the chart I am indebted to Mr. O. B. Hofstrand, who prepared it for his own use and in a fitting size for the Lefax books.*

per ton at 100 cc. per min. and 100 tons of feed per 24 hours.

Inasmuch as the consumption of oil is greater than 100 cc. per min. and the tonnage treated is greater than 100 tons per 24 hours, we must use the third formula to arrive at our final figure.

Thus: $\frac{2.95 \times 160}{450}$ or $2.95 \times \frac{160}{100} \times \frac{100}{450} = 1.05$ lb. per ton.

Doubtless many mill-foremen and superintendents

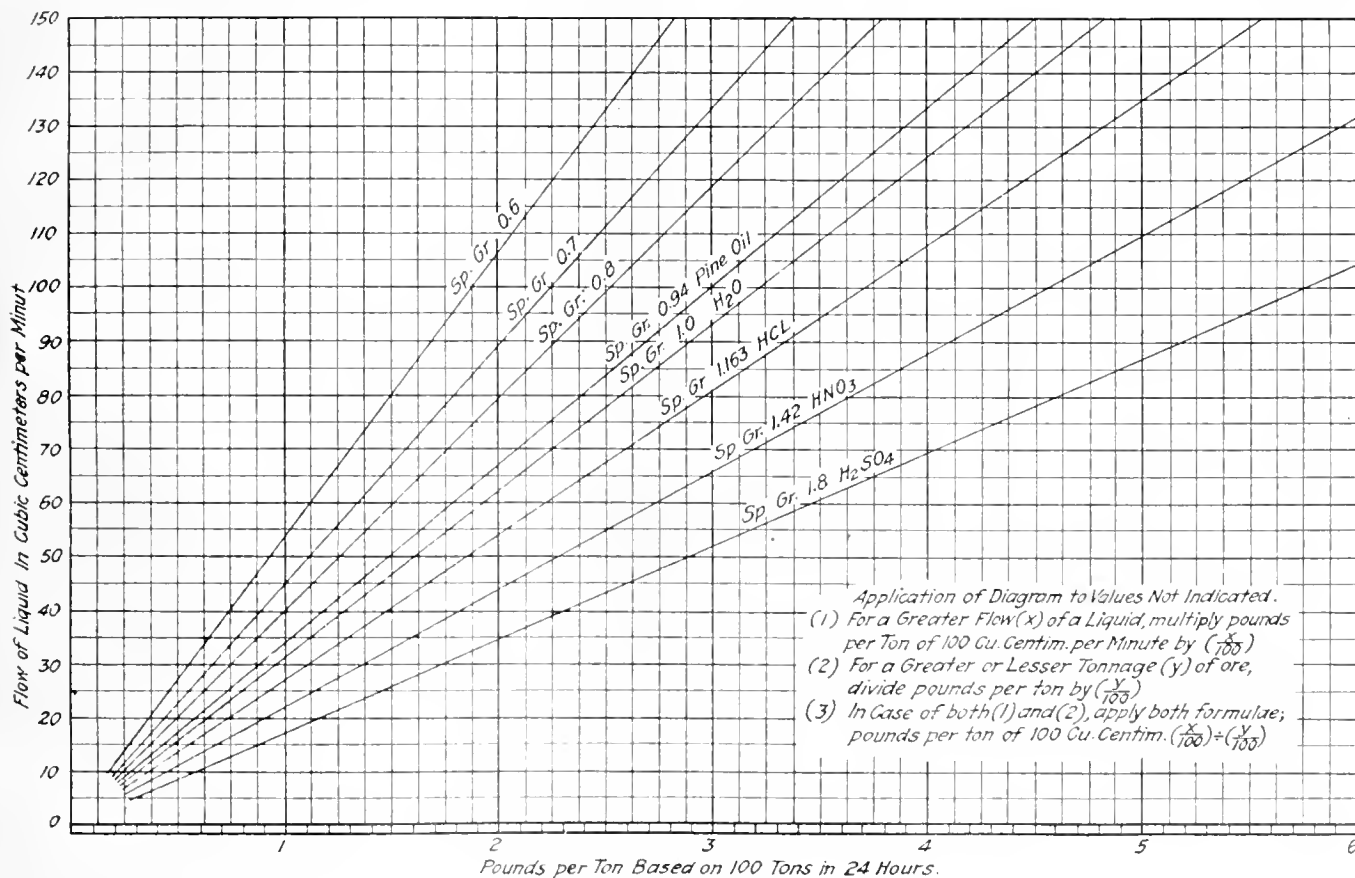

A concrete example showing how to use the table may not be amiss: Assume that a plant treats 450 tons per 24 hours and that the consumption of pine-oil is 160 cc. per min., it is desired to find the consumption of pine-oil in pounds per ton of feed.

From the point of intersection of the 100 cc. per min. line and the pine-oil line, follow down and read the figure 2.95, which would be the consumption in pounds

desire to estimate the tonnage of feed to some particular unit in their mill without going to the trouble of much sampling. I will give a method of calculation used extensively in the Coeur d'Alene, but which I have never seen printed.

For the application of this method the tonnage of either the concentrate or the tailing produced must be known and also the assay of all three—heads, tailing, and concentrate. The basis of the method is the efficiency by assay of the plant.

*[We have combined the two charts in one.—EDITOR.]

A concrete example, used in figuring the tonnage to a certain flotation plant, in which both a lead and a zinc concentrate were made, will be clearer than the use of formulae and 'unknowns.'

The concentrate tonnage is known and also the assay (in zinc) of the heads, tailing, and concentrate

| Products | Assay Zn% | Symbol |
|-------------|-----------|--------|
| Feed | 5.7 | H |
| Tailing | 2.6 | T |
| Concentrate | 40.4 | C |

Then:

$$\begin{aligned} \text{Ratio of concentration} &= \frac{C-T}{H-T} = \frac{40.4-2.6}{5.7-2.6} = 12.1 \\ \text{Efficiency of concentration} &= \frac{C}{H} \times \frac{100}{R} = \frac{40.4}{5.7} \times \frac{100}{12.1} \\ &= 58.7\% \end{aligned}$$

Made 211 tons concentrate of 40.4% Zn, which equals 85.2 tons of metallic zinc.

85.2 tons equals 58.7% of the zinc in the original feed.
 $100\% - 58.7\% = 41.3\%$ zinc lost in the lead concentrate and tailing, or 59.9 tons metallic zinc.

$85.2 \div 59.9 = 145.1$ tons of metallic zinc in the original feed.

$$\frac{145.1}{0.057} = 2545.5 \text{ tons of feed to the plant.}$$

The tonnage of concentrate or tailing could, by knowing the feed tonnage, be equally well calculated by this method.

C. EUSTACE DWYER.

Superior, Mont., April 14.

Some Peculiar Ore Deposits

The Editor:

Sir—Two years ago, in a paper read before a local meeting of the A. I. M. E., I ventured the opinion that the ore deposits of Republic (Washington) were themselves magmatic injections, the magma being the residuum, or mother-liquor, resulting from the differentiation processes of long-continued vulcanism.

At that time I was operating a lease on the upper levels of the Lone Pine mine. Not long after commencing work it became evident that something was wrong with the sampling method. Close inspection of the working-faces, coupled with occasional visits to neighboring properties, revealed a curious condition, and one that I had never before encountered. The 'black sulphides'—to use the local term—resemble the color of fountain-pen ink on clean white blotting-paper, appeared to have been distributed through the quartz by means of an atomizer, and again as if a passage for their reception had been prepared by a huge corkserew. In casting about for an explanation, it seemed perfectly natural to associate the curvilinear habit of the sulphide distribution with the phenomena accompanying convection currents in a liquid. In this connection it may be well to state that the above remarks apply to ore of medium grade. The rich ore, carrying native gold, selenide of silver, and telluride of these metals, was usually found close to the hanging wall, and occasionally filling small

fissures and fractures running away from the main deposit. These high-grade streaks were of a peculiar striped appearance, resembling nothing so much as a series of closely crinkled lines drawn parallel to one another, with a fine pen, on a sheet of white blotting-paper, the dispersion of the ink through the fabric of the paper being in faithful accord with the actual appearance of the sulphides in the rock. Under a strong lens, a slab of pure white quartz taken from the Republic mine looked for all the world as if some vandal had blown a minute quantity of lampblack over the surface of a bowl of milk. Competent authority has declared the black sulphides to have a composition approaching that of tetrahedrite.

It is when one comes to speculate upon the cause of the fissuring in the andesite that trouble and doubt sit at his elbow. That the fissures were open when occupied by the invading magma there seems no reason to doubt; that the magma itself supplied the force needed to rupture the rocks is open to question. In more than one of the mines open to inspection there are small side veins and pockets filled with a cloudy compact quartz, the presence of which it is hard indeed to explain except by the invasion of a mud-filled receptacle by a viscous magma. The quartz of these occurrences is generally barren. In appearance it is of a muddy tint, with distinct wavy lines of all shades of gray and black, of a pattern that is reminiscent of the ropy material sometimes observable on the selvage of a lava flow.

Nor is the Republic district the only locality where the magmatic injection theory seems to offer the most rational explanation of the origin of quartz veins. In the Cabinet mountains of Montana, among the flat-lying quartzites and slates, there are quartz veins that appear to have invaded these rocks under pressure sufficient to produce marked doming of the overburden. These are veritable laccoliths in miniature, and so far as I am aware, there are no eruptives within many miles of the locality. These deposits are barren and of small size, if surface indications are to be relied upon.

An interesting feature of that region, and one that may lend an odd twist to the problem with which the already overworked mental capacity of the prospector is beset, is that several of the veins in the slate contain gold, zinc, and in one instance, hübnerite, and in another scheelite; the tungsten minerals, so I am informed, being closely associated with the blende and galena.

From the Missoula River side of the district, eight years ago, a prospector found some material in his gold pan that refused to separate from the gold. He preserved the pannings in a bottle, and the following winter he came to me at Great Falls with the request that I 'put him wise.' I was unable to enlighten him, but suggested that he send his 'damfunnystuff' to a qualified analyst. He did. Four years ago I met one of his partners, who told me that the contents of the bottle contained 'some dam thing or another that was used in making some new-fangled light.' I tried him with thorium and all the 'ites and 'iums I had with me, but

in vain; he had forgotten. It may have been monazite.

What of the thermal conditions required to deposit those minerals? Is the lead and zinc content of these veins to be explained by stating that these minerals are themselves the end product of some mysterious differentiation process? For instance: a series of transformations resulting from the decomposition—or molecular decay—through loss by emanation of radio-active minerals of higher atomic weight.

We prospectors are having a hard time indeed; there's that other beast of prey, the plumbojarosinoceros, but Nevada will go dry some day.

A. M. BALFOUR.

Republic, Washington, April 25.

Mining Law Revision

The Editor:

Sir—I have read the text of the bill introduced before Congress by Representative Foster of Illinois. As one of those whose interests would be directly affected by the passage of this bill, I beg to offer some comment:

The new law is not to apply to locations already made at the time the proposed changes go into effect. The old right of apex in simple form and fact remains. The questions of faulting and junctions will be still with us. The fact of being the discoverer is no longer pertinent.

The writer of the proposed law probably was never five miles from the nearest scrub pine about to mark a claim with no rocks in sight within a half-mile or more. This is a condition that arises occasionally in a porphyritic country of flat nature. Why not a mound of brush and dirt and a rock or two on top to hold a tobacco tin with the mark inside away from grasshoppers, lizards, rats, chipmunks, and weather? In marking lines, why not specify the manner of marking to be such as can be most easily done with consideration to the greatest effect. Nobody wants to be over-lapped. The Oriental claim south of Goldfield was plowed around fully 25 years ago and is still very easily traced. That is dry country. On the Mother Lode such a method would be no good.

Proof of failure to find a probably remunerative vein or lode must be given by anyone trying to dislodge the locator and holder. It is the same old story with a new chance to do some hazy proving. A locator finds a vein. He looks at it and says it is fine. He doesn't have to test it to see. He has obtained enough pannings in some spot out of line of the strike of his vein and decides to make the vein of ore hit both places. He lays off his claim and maybe gets nearly 3000 ft. of the best outcrop within his lines. What about it? How is a prospector to make a claim with straight lines follow a crooked vein? I exposed a vein by work done that had been patented and mapped as running from the location post at one end to the centre end at the other. It really took a turn and went across the side-line at an angle of 60° and hadn't even been faulted till it was well outside the claim. Too much supposition in this case, too.

Rarely can a man keep from being bothered by other locators if he thinks he has anything good. He will probably have to mark it before he knows what he wants. This section will be abused. It will be unsatisfactory. Too much evidence has to be dug up against a locator for it to be worth much. If used rightly it is valuable and an improvement. It presumes that a locator has no other interest on earth save digging on his claim. It is a little tight in its specifications; it will promote fraud.

Extra-lateral work cannot be carried on under a claim alongside a lot of low-grade veins because it takes too long to get that far along. There is the time limit. What if the alongside claim should be kept up only long enough to bring the time limit into operation against the locator of the valuable vein and then should get into the hands of a grafter by new location or transfer?

Can a locator or possessor of locations abandon any location in case he wants to change to his advantage—to allow him to take up something that later looks better?

The tunnel-site claim is a clean-cut improvement, but it doesn't allow for immunity of trespass at the mouth of the tunnel or mode of approach across surface. Nowhere have I seen provision for enforcing permission to pass across other property to reach a property beyond. I know of no legal way to enforce permission of access by a practicable route. What about prospectors and owners of locations being called upon through the County Clerk's office to furnish direct statement of the time or times when assessment work was done on claims?

GEORGE E. McCLELLAND.

San Francisco, May 2.

Patents and the Patent Office

The Editor:

Sir—There seems to be a great deal of misconception as to the nature of patents and the operation of patent laws. A patent, *per se*, has no value, unless the subject-matter patented has value. The Patent Office cannot inject value into a patent.

Complaint is frequently made of the great number of worthless patents issued by the Patent Office. If a patent is worthless, and the patentee is satisfied to pay the fee, the patent attorney satisfied to receive it, and the Patent Office is enriched thereby, why should there be any cause for complaint? If the patent is contested, that of itself is evidence that it has some merit, and that the patentee is entitled to consideration. Inventions are no different from other efforts, and patents should not be different from other forms of property. Only a small fraction of all human effort results in phenomenal success, a larger portion in mediocrity, and almost all in failure or indifference. Patents are no exception to this general rule.

A patent granted on a trivial improvement is quite harmless. Any patent, based on an improvement evident to any mechanic, as frequently charged, can easily be surmounted by a mechanic of equal ability; if it cannot,

that indicates that the improvement is not trivial, but forms the basis of a valuable patent. Because a patent does not represent a basic idea or a great advance in the art, is no reason why it should not be granted. A small improvement is entitled to as much consideration as a great improvement, for precisely the same reason that a peanut vendor is entitled to the same protection in his business as the business corporations usually classified as 'trusts'. Similarly, an applicant for patent who may be ignorant in the art he is working is entitled to the same consideration as the most highly educated applicant. The fact that Carrie Everson was not a specialist in metallurgy cannot, of itself, detract from the value of her invention.

Much of the criticism of the Patent Office is unfounded. The cause for the criticism lies deeper than incompetency in the Patent Office staff. The granting of a patent is not so much a matter of research as opinion based on that research. In all cases of reasonable doubt there is less harm done by granting a patent than in refusing it. Let it be remembered that the Patent Office staff has the same difficulties to contend with as a court, and there is no unanimity in court decisions, even based on exhaustive evidence.

No action of the Patent Office, under any system, can, or should be final, until the highest court of jurisdiction has passed upon it. There is absolutely no practicable way in which an unassailable patent can, with justice be granted. The present patent law, on the whole is excellent. What is most urgently needed is a technical court to preside over patent cases, and the method of procedure should be greatly simplified and expedited. In any event, there should not be more than one appeal.

Much has been said in commendation of the German patent laws. Quite as much, if not more, injustice results from the German patent laws as under the American laws. Under the German system, any applicant can be forced into litigation before the patent is granted, and this is frequently done by strong financial interests to eliminate weaker competitors. A foreigner, under German laws, has not got the same fair chance as he has under the American patent laws.

Every patent looks simple after its simplicity has been pointed out; it is usually self-evident after it is made so. On the whole, the present examinations are strict enough—stricter a thousand times than the conditions governing the acquisition of material property from the Government. When an application is filed for a patent, all the records of the U. S., British, and German patent-offices are ransacked to see that the applicant does not get anything that does not belong to him; even if a U. S. patent, taken in connection with a British or German patent, shows anticipation, the patent is not granted. If a patent is granted, the applicant can enjoy a questionable right for 17 years. If a man files a claim on mineral land, even though it has been discovered a thousand times and abandoned, and even though the U. S. Geological Survey has mapped it out as mineral land, he is still entitled to 'discovery' and valid location, and can

obtain title forever. Why then quibble about the unjust rights of inventors?

The trouble in the patent law is not so much a matter of the system of granting patents, or in the Patent Office staff, as in the proper adjustment of what each respective inventor is entitled to, under the conditions. There is nothing so new but that it contains something that is old, and there is nothing so old but that it may contain something new. No inventor yet ever produced anything out of a clear sky. On the other hand, it is safe to say that there are few patents indeed, that do not contain some element of novelty, small though it be. In the last analysis the worth and validity of a patent can only be interpreted in the light of the prior state of the art, and in this interpretation pioneer patents, whether expired or unexpired, should be given the benefit of every doubt. No prior patent can or should be limited by a later patent on the basis of specific use or definite proportions. If this were done every pioneer patent could be invalidated by numerous later patents claiming enough specific uses and a great variety of proportions, and if one such patent is valid, all should be valid, and the pioneer patent would be hedged in on all sides.

No fault should be found with unworked or unexploited patents. After an applicant gets a patent it should be his to do with as he pleases, just the same as a patentee of a mining claim can, according to the present laws, let it lie dormant forever. It may be all wrong that this should be so, but it would be an outrage on patentees to require a patent to be worked, so long as other forms of property are not subjected to the same restrictions.

Patents are usually regarded as monopolistic. Clearly this is a misconception and a misnomer. Nothing could be further from the truth. Patents may be made the basis of a monopoly, but there is not a single monopolistic element in the patent laws. A patent indicates ownership, the same as that of a railroad or a mining claim. Neither of these constitutes what may be regarded as a monopoly. Because a man has a mining claim which belongs to him and his heirs forever, does not prevent anyone from locating an adjoining claim, neither does a patent prevent anyone else from accomplishing the same results in another way. It is only when enough mining claims are acquired or controlled to manipulate prices and output of the material mined, either by an actual or implied agreement, that it becomes a monopoly. The only way patents can become monopolistic is by a similar procedure. Morse transmitted intelligence by telegraph, but that did not prevent Bell from doing the same thing by telephone, nor Marconi from doing it by wireless. Neither of these, taken by itself, can be regarded as a monopoly, but if the important patents were controlled by one interest, either actual or implied, it might be regarded as a monopoly, differing in no way from other monopolies or so-called trusts, and would have nothing to do with the patent laws.

Then, too, all patents expire at the end of 17 years. Is

this socialistic or monopolistic? What a wail would be heard if mining claims, for example—which, to say the least, have no better rights to perpetual ownership than a patent right—were to be placed under the same laws as the patent laws, which so many delight in calling monopolistic? The fact is that all intellectual property is governed by extremely socialistic laws, while material property is governed by extremely monopolistic laws. A patent, which is one form of intellectual property, should be given every fair consideration, interpreted in the light of the prior state of the art and claims of respective patentees in that art.

W. E. GREENAWALT.

Denver, April 15.

Selenide of Silver

The Editor:

Sir—In a recent search through available literature on the subject of selenides, I was unable to find any mention of such at the De Lamar mine in Owyhee county, Idaho. Hence, it may be of interest to know that the writer identified a silver selenide in one of the veins in that mine about five years ago. During the latter part of 1910, we had a disagreement over bullion settlement with the American Smelting & Refining Co.'s Omaha plant. In the course of the correspondence resulting, E. V. Orford, manager of the De Lamar Co., was informed that the smelter's chemist had noted the presence of selenium in the bullion, from the reddish fume arising when the bars were re-melted for sampling. (Incidentally it may be remarked that subsequent investigation finally proved that the cause of the disagreement was not the selenium, as at first thought, but an impure 'proof' gold, which we were using in our bullion-assays.) I made numerous tests, from that time forward for several months, before I was able finally and definitely to ascertain the particular part of the mine from which at least a portion of the selenium was coming. The cyanide precipitate always gave a strong test for selenium, and once or twice I obtained a good reaction for tellurium also.

In April 1911, in a sample from the '77' vein, on the 9th level, west stope, in a white "lamellar"¹ quartz (pseudomorphic after calcite), I noted small streaks of a dull-black mineral which before the blowpipe gave the strong red fume and radish odor of selenium, and an easily reduced silver bead. As it was closely associated with the silver sulphide, argentite (Ag_2S), the mineral² may be aguilarite, $\text{Ag}_2\text{S} + \text{Ag}_2(\text{S}, \text{Se})$, though I have not yet made other than qualitative tests on it. Pressure of other work has prevented my making any quantitative determinations on the material, samples of which I still retain, hoping that some day I may find opportunity to investigate it further.

The occurrence of selenium recorded by Lindgren and Bancroft³ in the Republic district, Washington, is in-

timately associated with tetrahedrite, but I do not recall obtaining a reaction for copper in the De Lamar material. J. E. Clemmell⁴ mentions "a small quantity of copper" in the bullion of the Redjang Lebong mine in Sumatra, in connection with the occurrence of silver selenide there. Spurr,⁵ describing the presence of selenium at Tonopah, Nevada, says it is found "in part, at least as a silver selenide." He⁶ likens the Tonopah ore deposits to those of the Silver City-De Lamar district; also⁷ likens the De Lamar deposits to those of Waihi, New Zealand, as does Lindgren,⁸ but neither of them mentions selenium or tellurium at De Lamar. Lindgren, in listing the vein-minerals of the Silver City-De Lamar district, does not speak of any selenide in that area nor of any copper mineral in the De Lamar mine. Pyrargyrite and miargyrite are recorded, but no tetrahedrite. Gold is described as also being associated with the selenium of the Republic veins.⁹ The De Lamar bullion was low in gold, assaying 40 to 90 fine in that metal, and up to 900 fine in silver.

WALTER W. BRADLEY.

Berkeley, Cal., April 24.

Drill-Steel Sharpening

The Editor:

Sir—I have read with interest Mr. P. G. Beckett's article on 'Drill-Steel Sharpening at the Old Dominion Mine' in your issue of April 22. With a few exceptions the practice at the Old Dominion follows closely the standard Lake Superior practice of two or three years ago. The greatest variations from present practice are in the large difference in gauge for successive lengths of steel and the welding of 'Rocky-mountain' steel on round shanks. It is evident that the ground at the Old Dominion mine is not hard on the gauge, otherwise it would be impossible to standardize on two-foot changes; and it is probable that more careful forming of the bits would make it possible to reduce the changes in gauge to $\frac{1}{8}$ in. and possibly $\frac{1}{16}$ instead of $\frac{1}{4}$ inch. The advantage to be gained by such a change is obvious. Assuming that the gauge of the longest length of Leyner steel remains at $1\frac{3}{4}$, changes of $\frac{1}{8}$ would make the starter $2\frac{1}{2}$ diameter, instead of $2\frac{1}{2}$, with a cutting-area only 70% that of the starter at present used. If $\frac{1}{16}$ changes are used the starter would be $1\frac{15}{16}$ diameter, and the cutting-area would be little over 50% of that of the $2\frac{1}{2}$ -in. starter. As a matter of fact the reduction in cutting-area, with its consequent increase in drilling-speed, would be greater than I have indicated, for the gauge of the long drill could be reduced to $1\frac{5}{8}$ and still give plenty of room for $1\frac{1}{2}$ -in. powder.

I do not wish Mr. Beckett to consider my remarks as

⁴*Eng. & Min. Jour.*, Dec. 8, 1906, p. 1057; and June 8, 1907, p. 1099.

⁵U. S. G. S., Prof. Paper, No. 42, p. 92.

⁶*Loc. cit.*, p. 271.

⁷*Loc. cit.*, p. 285.

⁸U. S. G. S., Ann. Rep. XX, pt. 3, pp. 107-188.

⁹Lindgren and Bancroft, *loc. cit.*

¹Lindgren, U. S. G. S., Ann. Rep. XX, pt. 3, p. 170.

²Dana, 'Text Book of Mineralogy,' 1899, p. 289.

³U. S. G. S., Bull. 550, pp. 148-150.

adverse criticism of the practice at the Old Dominion mine, as I am not thoroughly enough acquainted with conditions there to pass judgment. I feel confident however, that as much can be done in reducing gauge intervals there as has been done already in the iron and copper districts of Lake Superior. In the Copper Country, Mr. C. D. Lawton, of the Quinby Mining Co., and Messrs. M. M. Morrison and Ocha Potter, of the Calumet & Hecla Mining Co., have perfected their drill design and drill sharpening practice to such a degree that they standardize on $\frac{1}{16}$ changes in gauge for 2 ft. changes in length.

At the Cliffs Shaft mine at Ishpeming, the largest hard ore mine operating on the Marquette range, I have made it standard practice to use a $\frac{1}{16}$ change in gauge for foot changes in length, the gauge of an 8-ft. drill being 1 in. Six years ago standard practice was to use $\frac{1}{8}$ changes in gauge for 6-in. changes in length of steel. The steel now used is $1\frac{1}{2}$ hexagon hollow F. A. B. No. 10, without lugs. There are 55 Leyner machines in use, of which 35 are using steel with $\frac{1}{16}$ gauge changes. The other 20 have not yet been changed over from $\frac{1}{8}$ intervals.

The rapid strides made in improving drill-bits and drill-sharpening methods have followed the introduction of the Carr bit and are the result of the study of its peculiarities. The Carr bit now used is essentially different from the bit originally designed by Mr. Carr. The original Carr bit had a single cutting-edge, finished at an angle of 120° , with an enlarged hole in the middle. The wings of the bit were formed on a true cone with a taper-angle of 5° , and the flat sides tapered toward the cutting-edge at 4° . In many instances all of these angles have been changed, and the bits are not made on a true cone. It is essential that the two ends of the cutting-edge and the four corners, where the faces of the bit meet the flattened sides, should cut the same circle. This necessarily means that the circle on which the wings are formed shall be larger in diameter than the gauge of the bit, the diameter being determined by three factors, namely, the angle of the cutting-edge, the taper of the wings, and the thickness of the bit at the corners. A change in any one of these factors changes the diameter of the wing-circle. In some kinds of ground Carr bits are not a success, but the principles of their design are equally applicable to cross-bits, and there is no reason to believe that with them results will not be as gratifying.

Following is a brief description of the drill-sharpening methods in use at the Cliffs Shaft mine: Three kinds of steel are used, $1\frac{1}{2}$ hexagon hollow steel for Leyner drills; $1\frac{1}{2}$ round solid steel for $3\frac{1}{2}$ piston-drills, and 1-inch round solid steel for raising-drills. Two styles of bit are used on the Leyner steel; cross-bits and Carr bits. The cross-bits are sharpened in a No. 3 Leyner sharpener, and are gauged in the dies. The gauge-changes are $\frac{1}{16}$ inch, and the changes in length one foot. The Carr bits are sharpened in a No. 5 Leyner sharpener, but are not sharpened in the dies. The steel is held by the dies, and the bit is 'upset' in the open air, one dolly and one pair of dies serving for all sizes of bit.

The steel is flattened between special dies, and is 'swaged' for the wings during the sharpening process in a pair of formers with 15° taper. It is upset to $\frac{1}{4}$ -in. greater diameter than the gauge, and is then brought back to gauge by being squeezed in a pair of formers with 6° taper. This method of forging facilitates drawing out the corners. All cross-bits are sharpened in one heat, but Carr bits often require two. On the cross-bits the angle of the cutting-edge is 90° and the taper 15° . On the Carr bits the angle of the cutting-edge is 120° and the taper 6° . All Leyner steel is made without lugs, the shanks being bored out to $\frac{3}{4}$ in., counter-sunk, chamfered, and squared, and then tempered in oil. Breakage is very low.

The solid steel for the raising-drills is sharpened in the No. 3 Leyner sharpener in the same manner as the cross-bits for the Leyner drills, the gauge changes being $\frac{1}{8}$ in. per foot. The solid steel for the piston-drills is sharpened in a Word sharpener. Cross-bits are used with the angle of the cutting edge 90° and the taper 12° . The changes in gauge are the same as for the other cross-bits. The practice of welding 'Rocky-mountain' steel onto the round steel was discontinued about four years ago.

All steel is given a forging-heat from 2 to $2\frac{1}{2}$ in. long in a No. 9 Bradley coke forge, and is allowed to cool thoroughly before being heated for tempering. The tempering heat is made as short as possible, and the bits are quenched by plunging into a tank. The tempering heat is given in a No. 11 Bradley coke forge.

Steel for the piston and Leyner machines is marked on the shank with the number of the contract to which it belongs, and after tempering is sorted and placed in a large rack, in which each contract has a pigeon-hole. The steel for each contract is made into a bundle and held together by an iron ring and wooden wedges. The contract number is then written on one of the wedges with a blue crayon.

LUCIEN EATON.

Ishpeming, Mich., May 2.

VALUE of the gold, silver, copper, lead, and zinc produced at mines in the Eastern or Appalachian States in 1915 was \$29,968,369, against \$11,437,707 in 1914, according to the statement just made public by the U. S. Geological Survey. The figures for 1915, compiled by James M. Hill, represent the production of 104 mines, of which 59 were gold placer mines (many of them small), 24 deep gold mines, 14 lead and zinc mines, and 7 copper mines. The metal yield was as follows: gold, 10,848 oz.; silver, 102,545 oz.; copper, 18,772,735 lb.; lead, 697,329 lb.; and zinc, 312,498,575 pounds.

Gold received by the San Francisco mint in April totaled 180,387 fine oz., also 126,990 oz. silver. The coinage executed was \$1,385,000 in eagles, \$3000 in one-cent pieces, \$118,000 in 20-centavos, and \$9000 in one-centavos for the Philippines. The vaults contain \$374,018,535.41.

Effect of Black Slate on Cyanidation

By H. Fischer

THE article on the precipitating action of carbonaceous shale in cyanide solution, by Paul W. Avery, in the MINING AND SCIENTIFIC PRESS of April 8 calls to my mind some observations made in the summer of 1915 while cyaniding some Mother Lode concentrate. These are all the more remarkable by the fact that they so closely parallel the results obtained by him. It will, perhaps, be interesting to your readers to compare the two.

The ore consists of pyrite and arsenopyrite occurring in quartz and carbonaceous slate in about equal proportions and is treated in the manner usual in this district. The gold occurs native, combined with pyrite and arsenopyrite, the latter carrying the most gold. Considerable mineral is found in the slate. As at the Esperanza,¹ crushing liberates a large part of the carbonaceous matter in the slate, and this carbon forms a film on the surface of the pulp, visible at the turn-boxes, classifiers, and mill-discharges. It assays from \$2 to \$12 per ton. No attempt has been made recently to cyanide this ore direct, earlier efforts having proved futile. However, an idea of the effectiveness of cyanidation may be gained from the following:

| | |
|---|-------|
| Concentrator tailing, + 60, sand, ounces..... | 0.06 |
| KCN strength, per cent..... | 0.25 |
| Time of leaching, days | 9 |
| Final tailing, ounces | 0.025 |

| | | |
|--|-------|-------|
| | No. 1 | No. 2 |
| Concentrator tailing, - 200, slime, ounces.... | 0.04 | 0.04 |
| KCN strength, per cent | 0.30 | 0.15 |
| Time of agitation, hours | 72 | 72 |
| Final tailing, ounces..... | 0.04 | 0.04 |

On the other hand, the concentrate is amenable to treatment by cyanide under the conditions noted below.

Preliminary experiments showed a possible extraction of 92.5%, but when the plant was put in operation the maximum extraction obtained was about 85%. The method of treatment followed in the plant closely approximated that shown to be necessary by the tests. The concentrate, after being removed from the vanners, was ground to 200-mesh in a tube-mill with water, run over amalgamating plates into a dewatering cone, thence washed into Pachuca agitators with cyanide solution sufficiently strong to raise the resultant solution to the proper strength. After six hours' agitation, the finely-ground concentrate was washed three times with barren solution and finally with water, and discharged. The tabulated results clearly show premature precipitation.

It will be noted that the figure 0.60 oz. recurs frequently as the final tailing-assay; innumerable instances similar to those tabulated indicate this to be the point at

| Assay of concentrate discharged from | | | | | Final |
|--------------------------------------|----------|----------|----------|----------|---------|
| Vanners | Pachucas | 1st wash | 2nd wash | 3rd wash | tailing |
| Oz. | Oz. | Oz. | Oz. | Oz. | Oz. |
| 3.78 | 1.74 | 0.35 | 0.99 | 0.60 | 0.60 |
| 4.42 | 1.10 | 0.66 | 0.56 | 0.72 | 0.72 |
| 3.38 | 0.52 | 0.78 | 0.70 | 0.65 | 0.60 |
| 3.60 | 0.82 | 0.26 | 0.38 | 0.66 | 0.60 |
| 3.50 | 0.76 | 0.50 | 0.40 | 0.50 | 0.50 |
| 3.70 | 0.58 | 0.40 | 0.54 | 0.38 | 0.40 |
| 3.90 | 0.74 | 0.62 | 0.60 | 0.60 | 0.56 |
| 4.00 | ... | 0.62 | ... | ... | 0.60 |

which the precipitating agent in the concentrate begins to make its action apparent. A test was then made to determine at what period of the treatment this point was reached. Samples were taken from the Pachuca tanks after every hour of agitation.

| | Gold, Oz. | | Gold, Oz. |
|-----------------------|--------------|---------------------|--------------|
| Pachuca heading | 4.26 | After 6th hour..... | 0.72 |
| After 1st hour..... | 0.92 | " 9th " | 0.58 |
| " 2nd " | 0.84 | " 12th " | 0.60 |
| " 3rd " | 0.84 | " 18th " | 0.58 |
| " 4th " | 0.72 | " 24th " | 0.66 |
| " 5th " | 0.92 | | |

It will be seen that most of the dissolution takes place in the first hour, and it might be assumed that a change of solution at that time would be beneficial. A test along this line showed that upon changing the solution every two hours, the residue fell more rapidly in value:

| | Gold, Oz. | | Gold, Oz. |
|--------------------------|--------------|-------------------------|--------------|
| Pachuca heading | 4.26 | After 2nd agitation.... | 0.61 |
| After 1st agitation..... | 0.84 | " 3rd " | 0.56 |

This shows a residue after 6 hours' agitation of 0.56 oz. by frequent changes of solution as contrasted with 0.72 oz. without changing.

At this point it became desirable to investigate, by analysis or otherwise, the cause of the high tailing and premature precipitation. Facilities were not available for analysis and it was postponed to make a search for remedies. This was made along three lines: roasting, fine grinding, and some form of wet desulphurization or oxidation.

Roasting followed by cyaniding gave variable results, depending on the quality of the roast. The best extraction was obtained from concentrate in which the iron had been most nearly completely oxidized.

| Raw concentrate, | Cyanide tailing, | Roasted concentrate head, | Final cyanide tailing |
|------------------|------------------|---------------------------|-----------------------|
| Oz. | Oz. | Oz. | Oz. |
| 5.10 | 2.10 | 2.70 | 0.44 |
| 3.60 | 0.60 | 0.77 | 0.155 |
| 3.60 | 0.60 | 0.77 | 0.125 |
| 5.10 | 2.10 | 2.70 | 0.20 |
| 5.10 | 2.10 | 2.70 | 0.14 |

¹Referring to Mr. Avery's article.

The low tailing from roasting and cyaniding confirms the results obtained at other plants having to deal with graphate or carbonaceous ore,² but this method increases the cost of plant and necessitates much handling of the ore, thus raising also the cost of operation.³ Besides, the loss in roasting concentrate lowers the apparently high extraction of 97% to a recovery of only 90 to 93%,⁴ and this may be obtained by other and cheaper means.

Prolonged grinding of a portion of the concentrate with weak cyanide solution produced a marked improvement. This was done in consequence of a classification test that showed more gold in the heavier—not coarser or finer—portion of the concentrate.

| No. | Classifier product | 0.60 oz., first to come off classifier |
|-----|--------------------|--|
| 1 | " | 0.68 |
| 2 | " | 0.49 |
| 4 | " | 0.89 |
| 5 | " | 1.44 last or spigot product |

It was so arranged that No. 4 and 5 products were constantly returned to the mill for longer treatment. At the same time strong solution was employed in the agitators. An increase of 5% in the extraction was noted:

| Mill heading | Mill discharge | Pachuca discharge | Final tailing |
|--------------|----------------|-------------------|---------------|
| 3.76 | 1.92 | 0.48 | 0.42 |
| 4.80 | 1.40 | 0.48 | 0.40 |
| 3.62 | 1.38 | 0.40 | 0.32 |
| 4.82 | 0.96 | 0.44 | 0.38 |
| 4.52 | 0.78 | 0.40 | 0.40 |

Preliminary washes before agitation in the Pachuca tanks employing chemical reagents such as solvents for gold, arsenic, and pyrite, and various oxidizing agents, followed by treatment with cyanide solution, gave indifferent results. Lead oxide and acetate, acid and alkaline washes, alkaline sulphides, cyanogen halides, permanganate, hypochlorite, and many other reagents were tried. Attempts were made to duplicate the results obtained in roasting: to break down the iron and arsenopyrite in the wet way. There follows a list of the most active substances, together with the final tailing-assay, in ounces of gold per ton, obtained using them.

| NaOH | H ₂ SO ₄ | Na ₂ CO ₃ | KBr | (NH ₄) ₂ S | NaOH+Al |
|------|--------------------------------|---------------------------------|------|-----------------------------------|---------|
| 0.56 | 0.52 | 0.40 | 0.50 | 0.48 | ... |
| ... | 0.45 | 0.52 | ... | ... | ... |
| ... | 0.66 | 0.64 | 0.50 | ... | ... |
| ... | ... | 0.20 | 0.34 | ... | 0.30 |
| ... | ... | 0.22 | ... | ... | ... |
| ... | ... | 0.28 | ... | ... | ... |
| ... | ... | 0.37 | ... | ... | ... |

The best results in the wet way were due to the use of Na₂CO₃ which had been employed with the idea of dissolving the arsenious sulphide. Its action was explained in the same manner as that of prolonged grinding of the heavier concentrate particles: it prepared the auriferous material for better contact with the cyanide solution. However, the premature precipitation continued, but to a less degree.

| Mill heading | Mill discharge | Residue | | | | | Tailing |
|--------------|----------------|---------|------|------|------|------|---------|
| | | 1st | 2nd | 3rd | 4th | 5th | |
| 5.01 | 0.90 | 0.56 | 0.44 | 0.50 | 0.48 | 0.40 | 0.35 |
| 4.82 | 0.96 | 0.50 | 0.42 | 0.44 | 0.40 | 0.44 | 0.38 |

A grading analysis of the concentrate was made to discover if the presence or absence of slate in the sulphide would affect the residue-assays or the extraction of the gold.

| Mesh | % | Assay |
|--------|------|----------------------------------|
| + 40 | 2.5 | \$6 mostly slate |
| + 60 | 3.5 | 76 " " |
| + 80 | 3.0 | 127 a little slate |
| + 100 | 6.0 | 127 " " " |
| -- 200 | 20.0 | 57 imperceptible amount of slate |
| -- 200 | 61.0 | 101 " " " " |

The above immediately suggested a means of getting rid of the carbonaceous matter, for the peculiar cleavage of the slate persists through the different stages of crushing and the large diameter opposed by the slate particle to a screen-opening as compared with that of a particle of sulphide of the same classifier-grade makes this method of separation possible.

A lot of concentrate was then screened through 60-mesh, the over-size returning for re-concentration, the under-size again classified to separate out more gangue, and the enriched spigot-product treated by prolonged grinding in weak cyanide solution with the following results, in ounces of gold per ton.

| Mill heading | Mill discharge | 1st residue | Tailing |
|--------------|----------------|-------------|---------|
| 3.44 | 0.48 | 0.42 | 0.36 |
| 3.44 | 0.48 | 0.42 | 0.31 |

To check the action of the slate on the gold-bearing solution, a piece was ground as fine as the concentrate and placed over-night in gold solution, the flask being shaken three times during the first hour, and the contents allowed to settle till next day.

| Ground slate, Gm. | Amount Sol., Cc. | Before treatment, Oz. | After treatment, Oz. |
|-------------------|------------------|-----------------------|----------------------|
| 150 | 1000 | 0.304 | 0.207 |
| 100 | 1000 | 0.304 | 0.236 |

27% of the gold in solution precipitated in 16 hours.

The case seems to have been clearly stated by M. W. von Bernewitz⁵ in his article on the Mother Lode. The cause of the premature precipitation doubtless lies in the slate. His mention of the use of caustic soda is significant. However, the success attained by the use of sodium carbonate made further tests in this direction advisable. Moreover, this salt offers a great many advantages: primarily its cheapness, also its susceptibility to control, and lastly, the important fact that it produces the lowest tailing of all the agents tried. A combination of fine-grinding and carbonate wash seemed better practice than interposing a carbonate wash between two series of cyanide treatments. Therefore, a lot of concentrate screened through 60-mesh was ground in the tube-mill with a 5% Na₂CO₃ solution followed by dewatering, and agitation in cyanide solution. The results justified the method:

⁵M. W. von Bernewitz. M. & S. P., Jan. 3, 1914.

²Donald Foster. M. & S. P., Feb. 5, 1910.

³W. R. Feldtmann. M. & S. P., May 22, 1915.

⁴Chas. Butters. M. & S. P., Nov. 20, 1915.

| Mill heading | Mill discharge Na ₂ O ₃ solution | Pachuca agitator | | Final tailing |
|--------------|---|------------------|-----------|------------------|
| | | Heading | Discharge | |
| | | KCN solution | | |
| Oz. | Oz. | Oz. | Oz. | Oz. |
| 3.36 | 1.88 | 1.58 | 0.22 | 0.22 |
| 3.36 | 1.42 | 1.58 | 0.24 | 0.24 |
| 3.36 | 2.22 | 1.58 | 0.22 | 0.22 |

Consumption of the Na₂CO₃ in the mill was 0.65%. The Na₂CO₃ raised the KCN consumption somewhat, but did not affect the precipitation. Decantation, water, and lime washes were used to get rid of the Na₂CO₃.

| Zinc-box No. | Head solution. | Tail solution. |
|-----------------|----------------|----------------|
| | Oz. | Oz. |
| 1 | 0.65 | 0.01 |
| 2 | 0.64 | 0.03 |

The extraction obtained by these means remains at about a minimum of 93-94%, increasing with the value of the concentrate. This agrees very well with the preliminary tests for cyanidation. The object of the tests having been attained, the matter was dropped. The function of the Na₂CO₃ and the action of the slate was outside the scope of these experiments, so no explanation based on research can be given. However, it would be interesting to speculate on just how the Na₂CO₃ and slate accomplished their effects.

A lot of ore from a mine lying outside the slate belt and not known to contain arsenic was treated both with fine-grinding and straight cyanidation, and also with a Na₂CO₃ wash. The results were the same. Concentrate from this ore likewise failed to give higher extraction with the Na₂CO₃.

| ORE | | | |
|------------------------|-------|------------------------|-------|
| Slime tailing, oz..... | 0.055 | Sand tailing, oz..... | 0.05 |
| Time agitation hours.. | 6 | Time treatment, days.. | 3 |
| KCN strength, %..... | 0.17 | KCN strength, %..... | 0.17 |
| Tailing, oz..... | 0.01 | Tailing, oz..... | 0.015 |

| CONCENTRATE | | |
|--------------------------------------|----------|-------------|
| Heading, | Tailing, | Extraction, |
| Oz. | Oz. | % |
| 1.52 | 0.12 | 92 |
| 1.62 | 0.14 | 92½ |
| 1.52 | 0.11 | 92 |
| With Na ₂ CO ₃ | | |
| 1.62 | 0.12 | 92½ |

In this ore the tailing is amenable to cyanide, whereas the graphitic ore is not. In this concentrate the Na₂CO₃ affords no improved extraction as in the case of the graphitic concentrate. The Na₂CO₃ appears to be active only in the presence of such reducing agents as the carbonaceous slate and the arsenious sulphide: what action it can have on so inert a substance as graphite is inexplicable unless the CO₂ liberated by hydrolysis and the action of arsenious sulphide becomes adsorbed by the slate; and as it is rather an oxidizing substance, it neutralizes the precipitating action of the slate merely by its presence. That is to say, neither the graphitic slate nor the carbonate do of themselves enter into either a reducing or oxidizing action, but they would, if either were alone, cause one to be brought about. The carbonate, therefore, makes impossible the conditions necessary for precipitation by carbonaceous material. But the action of the Na₂CO₃ on the arsenic is known. An

authority gives it as NaAsO₂ + NaAsS₂.⁹ This is soluble and is removed by decantation and washing with water, or, if a higher oxidized form is presumed, lime solution could be used as suggested by Andrew F. Crosse.⁷ This latter action also removes traces of the original Na₂CO₃ not otherwise eliminated. What becomes of the acid radical of the carbonate is ascertained in the subsequent cyanide treatment, for the cyanide consumption immediately indicates whether or not CO₂ has been carried over by the concentrate, and it usually has been.

Another fact worth noting is the great difference in the value of the mill-heading and the discharge when grinding in Na₂CO₃ solution. An assay of the solution shows the presence of gold in quantity sufficient to compensate for the difference mentioned. The assumption is that the carbonate solution dissolves the gold, which becomes NaAuO₂ in the same manner as the arsenic. Whatever the action of the alkali may be, whether as a solvent for gold and arsenic or merely as a guardian over the conduct of the graphite, Mr. Avery's idea of the oxidizing effect is a very plausible one.

Summing up, it may be said that concentration, classification, and screening play important parts in the elimination of the graphite. Mechanical methods will remove the slate while the Na₂CO₃ is expected to take care of the arsenic. As for the original ore, which was shown at the beginning to be not amenable to cyanide, it responds readily to flotation. The communication promised by Mr. Avery on this subject is awaited with interest. The ore here, as concentrator tailing, offers to flotation the head assay of 0.025 oz. gold, yielding 1.11 oz. concentrate and a tailing assay of 0.004, but the action of the slate persists. It obtrudes itself upon the flotation concentrate as it does upon the table product and even to a greater degree, but it is expected to overcome this difficulty similarly.

SHEET-STEEL and iron, containing copper, show greatly increased corrosion resistance when exposed to atmospheric conditions. The most effective amount of copper to be used for this purpose is approximately 0.25%. Smaller quantities of copper, down to as little as 0.04%, have a considerable influence in lessening corrosion, but the results are not so good as with the higher amount. Previous investigation has indicated that 0.15% copper is in nearly all cases as efficient as 0.25%. Copper up to 2% gives little or no added benefit. Copper is as necessary in the so-called pure irons to insure corrosion resistance as it is in normal open-hearth and Bessemer steels.—D. M. Buck and J. O. Handy in *Jour. of Ind. and Eng. Chem.*

ASBESTOS PRODUCTION of the United States in 1915 was 1731 tons worth \$76,952, an increase of 39% in quantity and 306% in value.

⁹Prescott & Johnson. 'Qualitative Chemical Analysis.'

⁷'Sulphates and Arsenates as Cyanicides.' *Min. & Eng. World*, June 1, 1912.

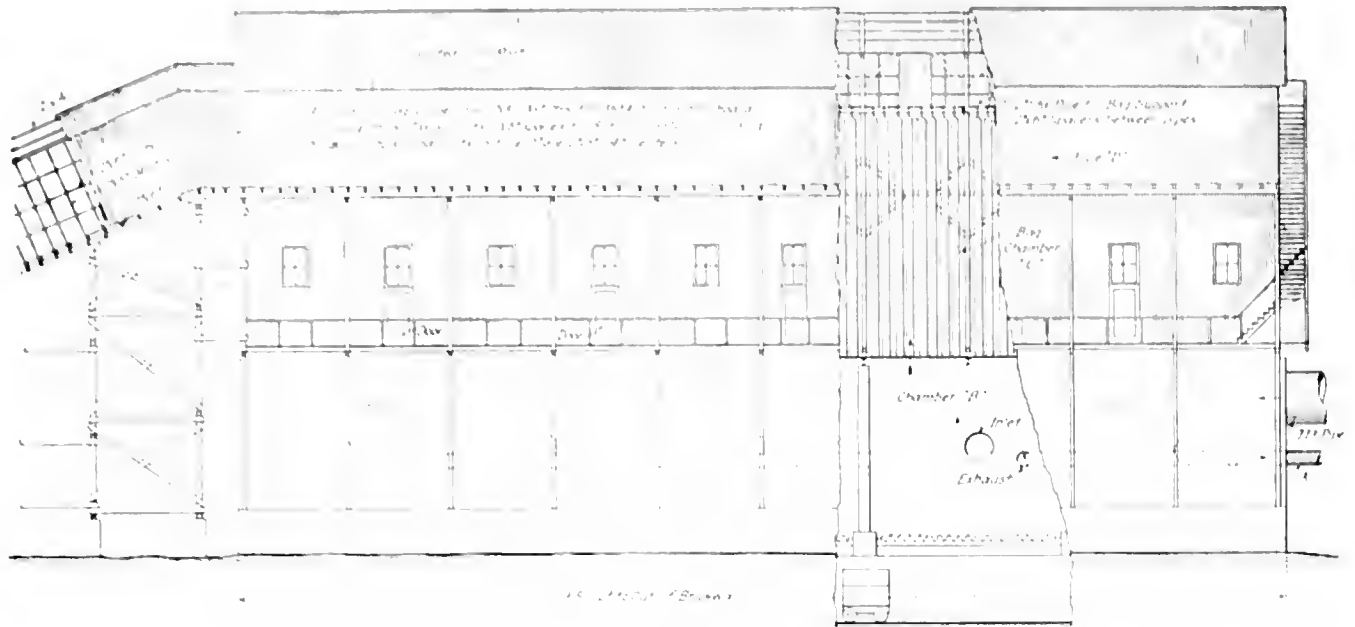

FIG. 1. LONGITUDINAL ELEVATION OF THE BAG-HOUSE.

The New Bag-House at the Midvale Smelter

By L. S. Austin

THE filtering of flue-dust from escaping furnace-gases through a woven fabric was successful practice as early as 1876 at the Lone Elm works, in Missouri, using the Lewis & Bartlett bag process.* The notable instances of its earlier use are at Canon City, Colorado, and at the Globe smelter, near Denver, where the details of practice were gradually developed. In the silver-lead smelting works of the West generally this method has been preferred to settling by gravity in flues or to the electro-static settling now coming into vogue.

From the time that the United States S. R. & M. Co. entered the silver-lead smelting field they have made use of the bag-house, at first after the blast-furnace, later for roaster-fume. They were driven to this, both by the saving in metal-bearing flue-dust, and by the pressure brought to bear by the agricultural community, which conceived that crops and live-stock were injured by the escape of fume into the air. The complaint was that particles of flue-dust, settling upon the vegetation, burned holes in the leaves; and that the fume contained free sulphuric acid. Filtration through bags so well removed the flue-dust that today it is difficult to detect by looking at the top of the stack that gases are escaping. The Sprague system of neutralizing the free sulphuric acid has overcome the second objection. While by order

of the court a maximum of 0.75% of SO₂ is allowed in the escaping gases, this limit is not nearly approached.

Last spring, in the MINING AND SCIENTIFIC PRESS † I

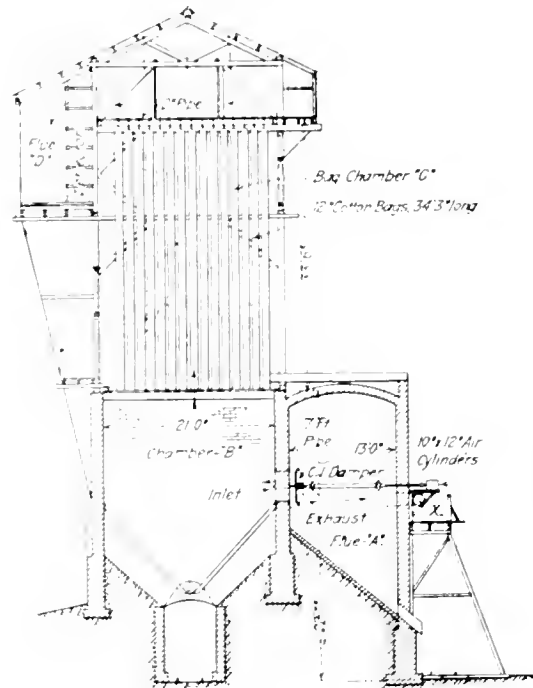

FIG. 3. SHOWING POSITION OF INLET-DAMPER AND AIR-FEEDER.

*Why a cylinder of cotton or woolen cloth 1½ ft. diam. by 30 ft. long should be called a 'bag' must be due to the shortness and convenience of the word. The gases entering and distending it escape outwardly through the meshes of the fabric.

described the method of discharging the bag-house gases through a high stack, tending to dilution by the air; I

†'Smoke Dilution at Midvale.' M. & S. P., April 10, 1915.

propose now to give the details of further improvements in disposing of the gases from the six blast-furnaces.

In calculating the capacity of the new bag-house it had to be considered that five out of the six furnaces would be running, these five taking the air from a blower of 175 cu. ft. per revolution at 160 r.p.m., or, allowing for 5% of slip, equal to 26,600 cu. ft. per min. The temper-

From the main brick flue, back of the blast-furnace, a 12-ft. elbow leads to a 12-ft. balloon-flue 127 ft. long, forming the 'trail' leading to the No. 14 Sirocco fan. Just before entering the fan at the top of the flue, there is fed a regular supply of finely ground quicklime. This, mingling with the gases, neutralizes any H_2SO_4 . Naturally the fan-blades ensure a thorough mixing; in addi-

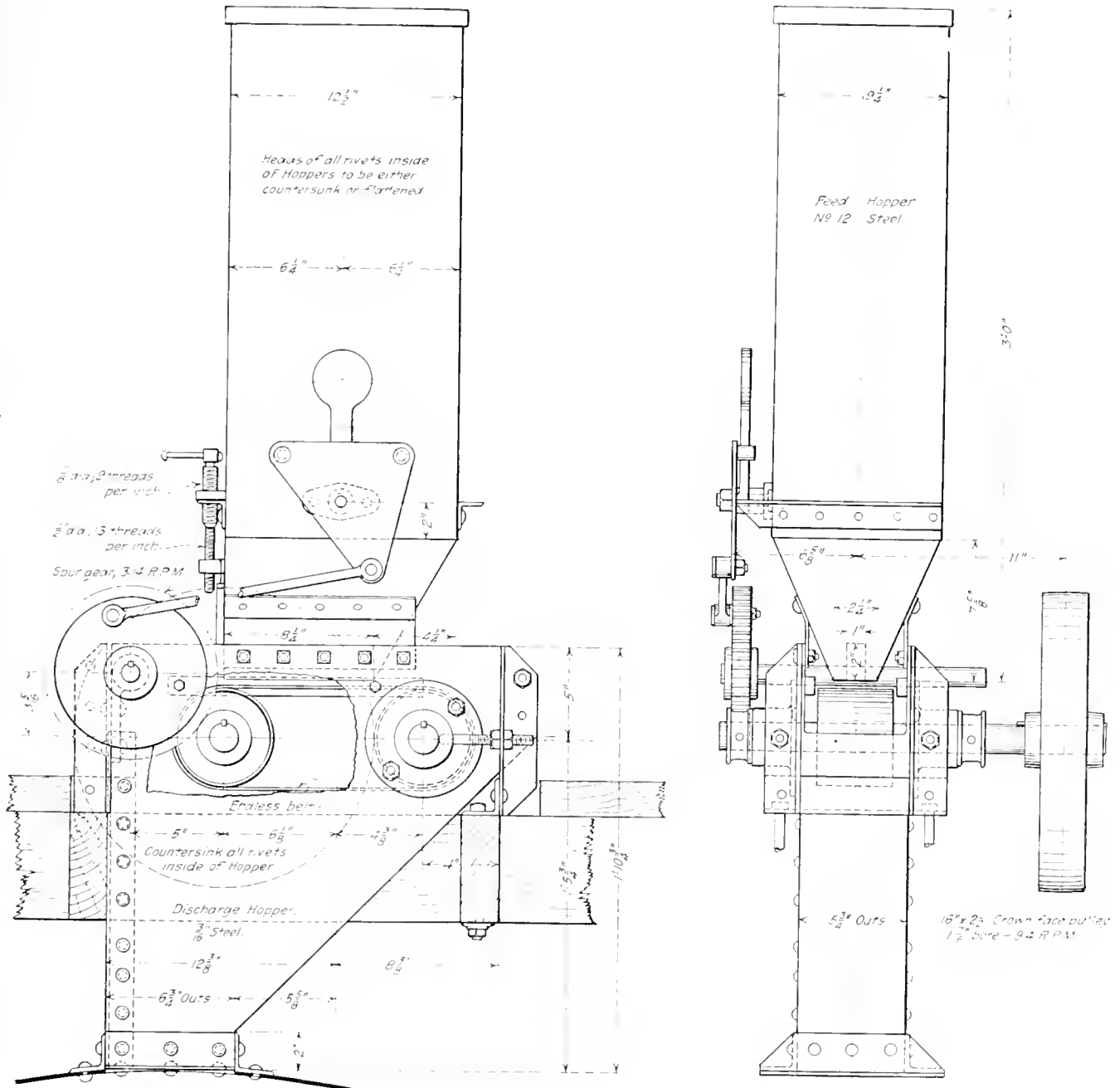

FIG. 2. THE LIME-FEEDER.

ature of this air, entering the blower at 40° F., would be 200° F. at the top of the charge, expanding by one-third, to 35,470 cu. ft. Allowing for the other furnace, and for a considerable leakage through the furnace-top covers, as well as for additional air admitted to lower the temperature at the bag-house to 150° F., a fan capacity of 60,000 cu. ft. was needed. For this a No. 14 Sirocco fan is used.

tion, the quicklime particles adhering to the bags also assist in the neutralization. Since the total bag-surface is 324,000 sq. ft., this is equivalent to a diffusion of gas through the cloth meshes at the rate of a foot per five minutes. As in any filtering operation, the more open texture tightens, since the faster flowing gases at that point more quickly deposit their load, thus averaging the flow.

Referring now to Fig. 1, showing a longitudinal elevation of the bag house, it is seen that the lower brick construction is double. This was an old double flue upon which a framed superstructure has been set. From the fan the gases enter the flue *A* (see also Fig. 3) by a 7-ft. pipe. The adjoining main chamber, which consists of the dust-chamber *B* and the bag-chamber *C*, is divided transversely into five compartments or bays. Each bay has an admission or inlet-pipe and an exhaust-pipe, both controlled by disc-valves. By adjusting these valves, any bay may be shut off and an exhaust connection opened, thus collapsing the bags, and so loosening the flue-dust that has accumulated on them. The exhaust-pipe is branched into the exhaust-main *X*, this leading back to the 'trail' on the exhaust side of the fan. Once during a shift the valves are operated, and after each shake a 5-minute interval is allowed in order to give the dust an opportunity to fall into the lower chamber. Once in several days the bags are given a 'hand-shake' to clean them more thoroughly.

The bottom of the dust-chamber is inclined at 50°. When the bag-house was started, these grades were much flatter, and the dust was expected to form its own slope, but it tended to arch over the feed-screw and harden there, so that the steeper slope of sheet-steel had to be used. Besides this, access is obtained beneath the sheets, and by jarring them with a hammer or bar the descent of the flue-dust is ensured, the dust working down to a helical screw (one for each bay) by which it is brought to a discharge-opening under each division-wall, and thence falls into a ear. The screw is started or stopped at will, being driven by a clutch taking-off from a motor-driven counter-shaft.

As the gases seep through the bags, they flow along the flue *D*, which continues at a grade of nearly 5 in. per ft. to the base of a self-sustaining brick-lined stack, 210 ft. high by 16½ ft. inside diam. This stack, which had not been used for several years, as the copper-smelting plant had been abandoned, effected an important saving in expense. For all that, the new bag-house cost \$200,000.

In the flue *D*, deflectors are placed to turn the gases leaving the dust-chamber into the direction of the flow. The velocity of the gases here is 9 ft. per sec.; at the stack the flow is nearly 5 ft. per sec., certainly a low figure.

In the older types of bag-houses, the sides and roof were of corrugated iron, and a free escape was permitted from the bag-chamber through shutters, sometimes by stacks surmounting the house. But the cooling of the fume resulted in a condensation of moisture, the dripping of which soon contributed to the destruction of the bags. In this plant it will be seen that, besides the outer covering, there is an inside one of asbestos, in sheets 36 in. wide, nailed to the studding. The outlet-flue *D* is lined on three sides with 1-in. tongue-and-grooved stuff, and all round with No. 22 copperized sheet steel.

The thimble floor above the lower chamber is $\frac{3}{16}$ -in.

sheet-steel carried by 12-in. I-beams. The thimbles themselves are 10 in. high by 11 in. diam., there being 240 to each bay, or 1200 in all. The bags, 34 ft. long, are made from 12-in. canvas, double-sewed with inch lap. These are wired at the bottom to the thimbles and suspended above from 2-in. pipes.

Fig. 2 is the lime-feeder driven by a counter-shaft from the fan-shaft. The hopper is tall and narrow. The finely ground quicklime falls upon an endless belt, passing thence to the top of the 'trail.' To prevent lodging in the hopper, a triangular plate is hinged and vibrated by means of a link from the drive-shaft. A loosely-swinging hammer is actuated by stops on the upper corners of the plate. It falls with a jar upon each stop and shakes the hopper.

Fig. 3 shows the general arrangement of the inlet-damper and the air-cylinder that actuates it, as well as the walk-way and the flue. The smaller damper of the exhaust is moved by a simple stem and handle, central in the branch exhaust-pipe, but not shown in this drawing.

NICKEL OUTPUT. The International Nickel Company, which operates nickel-copper mines in the Sudbury district of Ontario, under the name of the Canadian Copper Co., is said to control 80% of the world's nickel production. The Creighton mine at Sudbury is the principal source of supply, but the company also owns mines in New Caledonia, the French island half-way between Australia and the Fiji Islands, which is the only serious competitor of Ontario as a nickel-producer. The New Caledonian deposits consist of a large number of small veins richer than at Sudbury; they are capable of yielding a much greater output than at present. The world's production of nickel is 60,000,000 to 70,000,000 lb. per year, and the price is usually 40 to 50c. per pound. Nickel is used extensively in the manufacture of armor-plate, which contains 3 to 4% of nickel, and in structural steel; the automobile industry is requiring an increasing amount of nickel both for toughening steel and to plate attractive surfaces; miscellaneous uses, such as for making German silver, consume a good deal of nickel. As regards the recent request made by the Canadian government upon the International Nickel Co. to refine its matte in Canada rather than in the United States, the objection made by the company to refining at Sudbury is the high price of fuel at that place. Nova Scotia is favored as a site on account of its coal supply and ocean transport, but the American import tax of 10% on refined nickel would be a disadvantage for refining in Canada, nickel for use in the United States. Dividends of International Nickel Co. on its common stock have varied from 10 to 20% during the past five years; the common stock amounts to \$41,834,600 while preferred stock, bringing 6%, amounts to \$8,912,600. Occurrences of nickel ore in the United States, while unimportant, have been noted in Lancaster county, Pennsylvania, at Mina La Motte, Missouri, in Douglas county, Oregon, near Webster, North Carolina, at Lovelock, Nevada, and at San Diego, California.

A Quick Method of Locating Geologic Features

By Charles A. Porter

In the examination of prospects, an approximate method of determining the position of landmarks is often desired. The method here outlined is of value in avoiding gross errors in the location of geologic features. As there are no measurements after the base-line has been determined, the aid of an assistant is not required.

The system is a method of triangulation using the Brunton pocket-compass, or any other good compass, making notes and plotting them at leisure. The system involves no calculation, the course and distance of the points on the map being determined by plating to

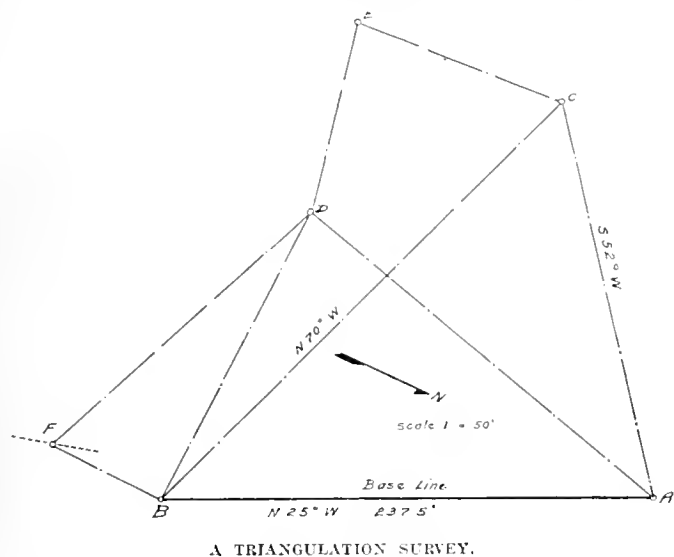

scale. The principle involved is that used in the operation of the plane-table.

In the sketch we will suppose the base-line AB to have been measured and its bearing determined by the needle. In this case we will assume that the course and distance is $N 25^{\circ} W$, 237.5 ft., odd figures being no inconvenience owing to there being no calculations.

To determine the location of point C , first sight with the compass on C from A on the base-line, noting the bearing. Then from the other end of the line at B , sight again on C , entering the courses in the note-book. This completes the field work necessary to determine the location of C with reference to the base-line.

The base-line is platted, giving it the course and distance determined in the field. A line is then drawn from A , having the same course shown from A to C in the field notes. The course from B to C is then platted, the line being prolonged until it intersects the line drawn from point A , the intersection determining C . Point D , or any other point visible from A and B , may be located in the same manner, showing the relation between C and D as well as with the base-line.

The bearings of as many points as convenient may be taken. Reflection will show that the process can be

carried on indefinitely and is not limited to points visible from both ends of the base-line. Once the points C and D are located, the deduced course and distance between them can be used as a basis for further survey, such as to determine E , which is invisible from either end of the original base-line.

In locating the point F the course and distance BD should be used as a base instead of the original AB . It is obvious that slight errors in reading the needle would become exaggerated and would tend to throw the point F a considerable distance along the direction shown by the dotted line.

NEVADA'S population has fluctuated with the prosperity of its mines, and 'ghost cities of Nevada' is the term used to designate abandoned settlements where mining booms dwindled to nothing. In 1870 the population of the State was 42,491; in 1880 it had increased to 62,266. Of this number, it was estimated that 42,019 were males and 20,247 females. Fully 25,000 of the population was foreign-born, and probably 5000 were Chinese. The two centres of population at that time were the Comstock lode in the extreme western part, and Eureka in east-central Nevada. In 1890 the State had 47,355; and in 1900 only 42,335—a decline due to the fall in the demand for silver. In 1910, the population had increased to 81,875; while today it is about 100,000.

SAN FRANCISCO'S population of 500,000, with the 250,000 of Oakland and the 60,000 of Berkeley, is the nucleus of the million people who live around San Francisco bay. As regards mining, San Francisco has, of course, been a famous distributing centre for mines since the boom days of '49. The great valley of California, 500 miles long, extending between the Coast ranges and the Sierra Nevada, has its natural outlet to the ocean at San Francisco, and the excellence of the harbor gives the city an advantage for shipping, not only to Pacific ports but to others. San Francisco is the largest city in the western two-thirds of the United States, and with the exception of St. Louis the largest west of the Mississippi river.

DENVER has a population of over a quarter of a million, which is as much as the entire State of Arizona, and more than Nevada or Wyoming. The city has long been recognized as a centre for Rocky Mountain mining, particularly for those districts along the eastern fringe of the Great Basin. Its altitude is about a mile. With the increase of agriculture in Colorado, Denver will become a ranching and farming centre. While gold and silver mining in Colorado is declining somewhat, a variety of important minor minerals are being discovered and worked.

THE PORCUPINE DISTRICT will produce during 1916, it is estimated, about \$15,000,000 in gold. The silver output of the province of Ontario in 1915, mostly from the Cobalt district, was \$11,742,463. Ontario's importance as a gold producer is increasing.

Stoping by Branched Raises

By F. W. Sperr

LET us assume an irregular lenticular orebody. Fig. 1 represents the horizontal outlines of such an orebody at 25 ft. intervals. The wall-rock and capping are strong, and the ore is of medium hardness and texture. Therefore large chambers of ore may be extracted without caving or in any way disturbing the enclosing rock. The main considerations in applying a stoping method are: safety to the workmen, the elimination of timber, and the reduction of shoveling and tramping. It appears that the ore may be extracted from the top downward, leaving the opening self-supporting, thus eliminating the use of timber. The reduction of shoveling and tramping may be accomplished by a suitable arrangement of 'mills' into which the ore falls as broken, and from which it may flow directly into tram-cars on the main-haulage levels, under control by suitable chutes.

The first haulage-way will be on the foot-wall 100 ft. below the top of the ore. Four vertical raises will be driven on the foot-wall side, 45 ft. apart and designed to be near the hanging wall at the top sub-level, which in this case is 75 ft. above the haulage level. If no other raises were used, a great deal of shoveling and tramping would be necessary in the stopes; therefore, branched raises are started from the main vertical raise in such a way as to cut up the block of ore most advantageously for reducing the shoveling and tramping. For maximum efficiency the raises should be 25 ft. apart on every sub-level, should reach close to the foot-wall, and should approach the hanging wall according to its dip; the steeper the dip the closer the approach.

Beginning at the top sub and working downward, drifts and cross-cuts are made 5 or 6 ft. wide and 6 or 7 ft. high on the different sub-levels to connect the raises with each other. Then the ore is blasted into the raises from around the sides, and by means of down-holes the tops of the raises are made funnel-shaped and widened, until their rims become contiguous. This leaves 15 to 17 ft. of ore in place above the cut. By means of upper holes, about 8 ft. of the overhanging ore is brought down and left lying for a foundation upon which the drills are rigged for another series of upper holes. If, in places, the ore goes up more than 25 ft. above the sub, as it often does in irregular fingers, it is mined by successive series of upper holes, or by the ordinary back-stoping-on-broken-ore method.

The sub-levels are 25 ft. apart vertically. Each sub is mined in substantially the same way as the top sub, except that the 'mills' will be better distributed on some sub-levels than on others. There will always be the balancing between the cost of extra raises and the cost of extra shoveling and tramping.

Fig. 2 illustrates any one of the different vertical sections on the lines *AA*, *BB*, and *CC*, of Fig. 1. The section on the line *DD* would show the bottom of the raise in the foot-wall rock.

Fig. 3 represents the vertical sections through the raises *B* and *C*, on the lines *BF* and *CF*, at right angles to the lines *AA*, *BB*, etc. The branches are driven in four directions from these main raises, in two sets one above the other, and at vertical angles of about 55°. The branches from *A* and *D* are driven in three directions, the fourth direction being against nearly vertical walls. By this arrangement mills are provided on the 75-ft. sub-level, and distributed in such a manner that little shoveling and tramping will be necessary. Fig. 4 shows the positions of the raises on this sub and the connecting drifts and cross-cuts. The raise *D2* to the right is extended on the pitch of the formation.

Fig. 5 shows the positions of the raises on the 50-ft. sub, connected by drifts and cross-cuts. The arrangement of the mills at this level is nearly ideal, as illustrated by Fig. 6, which shows the approximate positions of the rims of the mills after being funneled out. Hog-backs of ore will be left lying on the spaces standing between the mills. All this goes down with the next lower sub. But along the foot-wall, all broken ore has to be cleaned off to the sub-floor. Otherwise it is liable to 'hang-up' instead of coming down with the next lower sub; therefore it is desirable to have the raises along the foot-wall close enough together and close enough to the wall to prevent any considerable quantity of ore from finding lodgment.

The branched raises are available for mills on the higher subs, but not on the first sub above the main level. Fig. 7 shows all that remains of the raises on the 25-ft. sub-level. Only the main vertical raises are left; but these are well distributed along the foot-wall, making the amount of shoveling and tramping the least possible under the circumstances. If the ore does not extend below the main level, immediately under this sub, it will probably be more economical to do the shoveling and tramping, than to provide more mills together with the necessary chutes. But, if the ore extends downward so that another main level becomes necessary, some of the ore from the 25-ft. sub may best go down to this next lower level through some of the mills, which may be extended upward as required. Ordinarily the ore from each main-level slice is milled to the chutes of the next lower level.

Various names have been given to this method of mining. It is variously known as 'subbing,' 'underground milling,' 'slicing without timber' and 'sub-slicing without timber.' The last term seems the most distinctive.

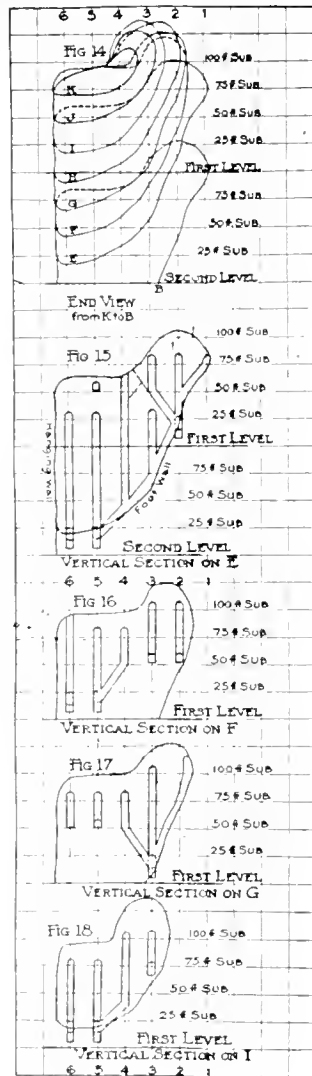
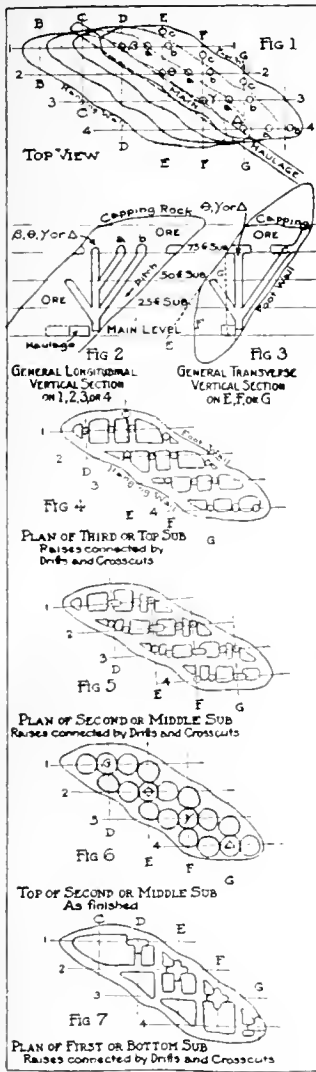

also to designate methods that are much different in detail.

Fig. 8 to 18 illustrate the case of an orebody beginning somewhat irregularly under the capping and extending downward with a nearly vertical hanging wall, and with the 'back' pitching down at an angle of 45°. The physical conditions are similar to those in the preceding case, and the same method of mining will be applied with little difference in detail.

Branched raises from six chutes on the first level and from the same number on the second level, provide mills 25 ft. apart on every sub-level. The foot-wall sides are properly provided, and nearly all shoveling and tramping in the stopes is eliminated.

The ore is of such a character that it gives little trouble by packing in vertical raises; therefore the branches are made vertical in places for convenience of arrangement. Accessibility to the vertical mills for the purpose of relieving the tendency to pack, can be more readily provided where the branches are inclined throughout their entire length, than in the case where they are partly vertical. Softer ore has a greater tendency to pack in the mills at a high angle, as well as to hang up in the mills at lower angles. The best angle for the worst ores, in this regard, is 65° above horizontal, but some ores run freely at an angle of 45°.

The developments from the second level are as yet only prospective; but it is reasonable to suppose that the ore will go down another 100 ft. judging from the developments of the first level. The second level should be developed no earlier than necessary for continuous production to follow the exhaustion of the first level; for by long standing the chutes decay and the openings cave, and the whole foundation may be weakened to such an extent as to destroy the system of mining. Fig. 8 is a top view of the outlines of the horizontal sections of the orebody at the prospective second level and at vertical intervals of 25 ft. from the first level to the top of the

DETAILS OF STOPING BY BRANCHED RAISES.

It suggests the method of operating and does not apply to other methods, while all of the other terms are used

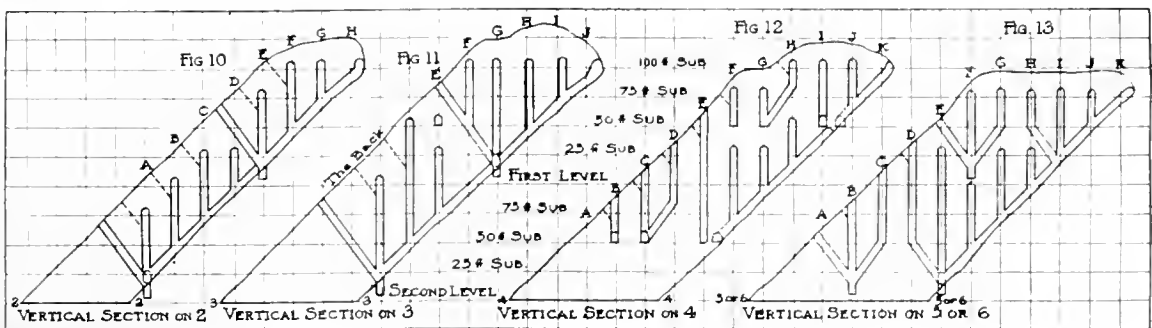
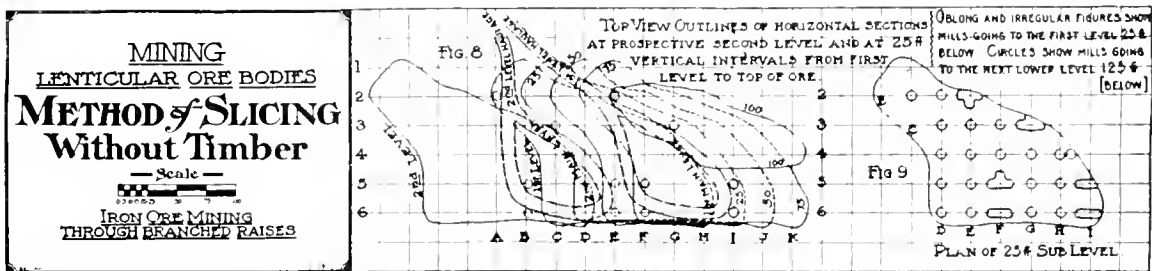

MINING
LENTICULAR ORE BODIES
METHOD OF SLICING
Without Timber
 Scale
 IRON ORE MINING
 THROUGH BRANCHED RAISES

ore. The full circles show the positions of the chutes on the first level. The dotted circles show the positions that the chutes will occupy on the second level, if there is no material change in the formation in the next 100 ft. downward. Fig. 10, 11, 12, and 13 represent vertical sections on the lines 2, 3, 4, and 5 respectively. The vertical section on the line 6 is substantially the same as the one on the line 5. These sections, together with the transverse vertical sections on the lines *E*, *F*, *G*, and *I*, as shown in Fig. 15, 16, 17, and 18, show the complete system of development of the raises for the first and second levels.

The plan of any one of the sub-levels below the irregular top, as developed by raises from two successive main levels, will be typical of all. Such a plan is represented by Fig. 9. The circles are the tops of the mills going to the second level. The oblong and irregular figures are the tops of the mills going to the first level. Plans of different sub-levels will differ from each other in little except the relative positions of the two different classes of mills.

From the method of slicing into mills without timber, it is an easy transition to a variety of different methods of mining that have been devised and adapted to ores of divers physical qualities in bodies of various shapes and sizes. When the ore is so hard that the long raises and numerous sub-levels become too expensive, the obvious thing to do is to make the raises shorter and reduce the number of sub-levels. Practically the same number of mills, similarly distributed, will be required as before; but let the raises terminate at the 25-ft. sub-level as shown in plan by Fig. 9, and let them all be started from the first level. This will make a modified plan of the level necessary, in order to give the tram-ears access to the chutes. The sub now has a back of 75 ft., instead of 25 ft.; it will be mined by upward slices the same as before, except that nine or ten slices will be required instead of two. Sufficient broken ore will be left overlying the mills to make it convenient to reach the back for the successive slices. After the stope is finished, the remaining broken ore is drawn off through the chutes. This is the full-stope method of stoping on arches.

But, whenever the capping or hanging wall, or both, begin to break or cave, another modification of the method becomes necessary. The breaking and caving can be prevented, or at least retarded, by reducing the size of the chamber. Instead of making one continuous stope, pillars may be left standing in a variety of ways to divide the stope into self-supporting rooms. In the design of such a method, provision should be made for the ultimate recovery of the ore in the pillars, either by crushing or caving, not only for the salvage of the ore, but more for the safety of the mine. This is the method of back-stoping by rooms.

COPPER production of Michigan in 1915 was 238,956,410 lb. (a record), compared with 158,009,748 lb. in 1914, and 231,112,228 lb. in 1912. Ore mined and treated totaled 12,334,699 tons, yielding slightly over 1% metal. The silver recovered was 585,933 ounces.

Rifled Cores in Diamond-Drilling

Phenomena of rifled cores are due to torsional vibration of the drill-rods, which in turn is produced by the rotation of the rods. The cutting medium attached to the rods engages with the core, penetrating to a certain depth, and thereby temporarily checking the rotation of the rods. When the energy stored up in the rods by the torsional strain exceeds the frictional resistance between the cutting medium and the core, it forces the cutting-point out and the rod springs around until the strain is relieved, the action being repeated uniformly and indefinitely. The depth to which the cutting-point enters the core depends on its size, shape, and hardness, and on the hardness of the core, also on the intensity of the vibration. The distance through which the cutter rotates between points of contact with the core determines the number of threads to the turn, but it is probable that the number once established pre-disposes its regularity and symmetry. With lower speeds of rotation the vibration is less intense, and the cutting-point remains in contact with the core for a longer period; the number of threads to the turn as well as the pitch of the threads may be changed in this manner.

The conclusions reached by investigations may be summarized as follows:

1. Riflings of cores are produced by torsional vibration of the rods.
2. The formation of multiple threads, or a number to the turn, is determined by the intensity of vibration, character of the cutting medium and the core.
3. The pitch of the threads is determined by speed of rotation of the rods.
4. The size and length of rods probably act only indirectly to modify the size, shape, and pitch of threads.

As rifling of core is produced by rotation and varies in prominence with the intensity of vibration, it is possible to prevent or materially reduce the vibratory action of the drilling mechanism by reducing the speed of rotation of the rods. This method of procedure would undoubtedly be much less difficult and troublesome and far more efficacious than the practice of greasing the line of rods.

It is possible that aside from the desirability of knowing how rifled cores are formed, the knowledge may be of little or no importance, yet who can say when a purely scientific fact may not become of considerable economic value. Many engineers and diamond-drill companies considered that vibration was responsible for rifled cores.—Walter R. Crane in paper prepared for the Arizona meeting of the A. I. M. E.

ZINC IN MONTANA increased in value of output from less than \$6,000,000 in 1914 to \$26,000,000 in 1915. The increase in spelter output was 60%. Montana produces less than \$5,000,000 annually in gold. The State's production of copper was 268,000,000 lb., being less than that of 1913, despite the better price.

The Gasoline Question

By an Occasional Contributor

MUCH has been written lately in a hysterical way, and much ranting has been done in legislatures and in the halls of Congress on the subject of gasoline and its sudden rise to what seems to be considered by the consuming public an iniquitous price. Succinctly, the public wants to know if the rise is warranted; is it due to that industrial Maehiavelli, Standard Oil. Parenthetically it may be asked, is the present level of prices, in view of conditions, at all abnormal?

Be the answer what it may, the public's interest lies largely in what can reasonably be expected in the future in regard to both supply and price for what has become

factors in the oil business—the producers and refiners themselves.

In the ordinary course we look for guidance to general principles. The law of supply and demand is one of these, and has been generally accepted as ruling in everyday affairs. There is no reason why it should not apply in this case, barring special conditions that obtain in every particular industry.

The graphic exhibit, Fig. 1, gives the relation for the past five years between the production of the raw product, crude oil, and the various elements that enter into an intelligent comprehension of the problem. There

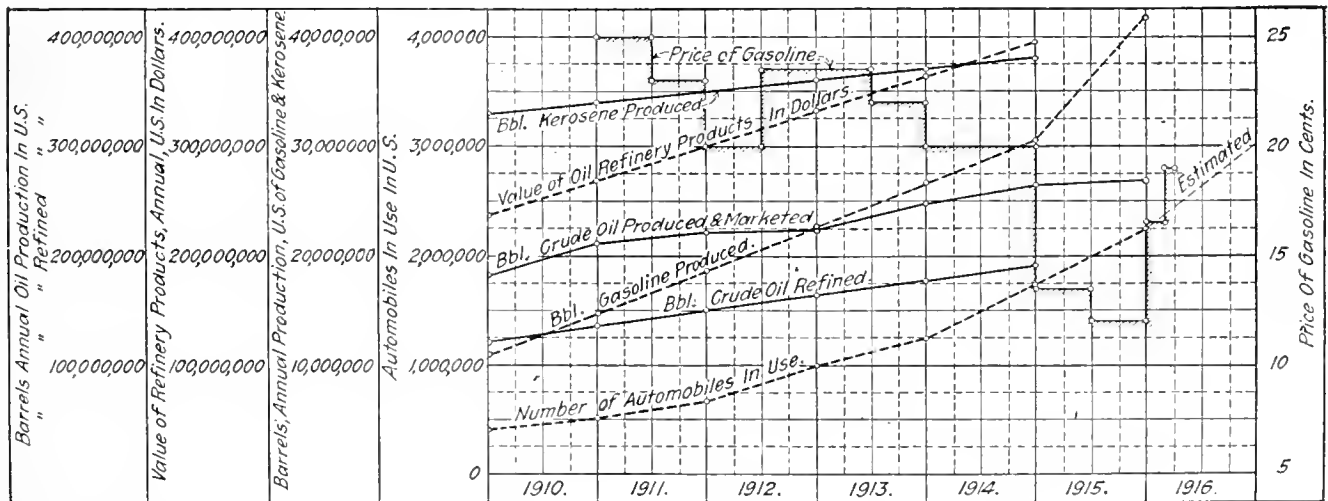

Graphic Diagram showing relation for past Five Years, between production and consumption, of various elements of the Petroleum Industry, in the United States, as compared with the increase in number of Automobiles in use.

FIG. 1.

a most important staple of commerce. The public asks the professional man on the one hand, what avenue of relief is there for this new situation, and on the other hand requests the Attorney-General to state what, if the cards are stacked by the aforeascribed maehiavellian trust, is he going to do about it?

The question has had the dignity of a resolution passed by the U. S. Senate, where, unfortunately, political fences are sometimes built in anticipation of coming elections, and has for months occupied the attention of the Federal Trades Commission. In reply to the Senate resolution our well-informed Secretary of the Interior reported to Congress clearly, at length, and to the point that it is only a natural situation, while the newly-created Trades Commission has rendered thereon a preliminary though somewhat non-committal report. The following data, observations and impressions are taken mainly from these reports, and from the U. S. Census, as well as from published interviews with prominent

are, of course, other factors, but these are the leading ones (referring only to the production of the United states), to wit:

Group 1. (a) The amount of crude oil produced annually; (b) the amount of crude oil refined annually (the difference being consumed as fuel?); (c) the amount of kerosene produced annually, and considered as consumed (which it is not, of late).

The curves for these three elements are substantially parallel and indicate what might be considered a normal situation in the oil business.

Group 2. (d) The amount of gasoline produced annually, and considered as consumed; (e) the number of automobiles in use in the United States; (f) the total value of the refinery products.

The elements of Group 2, it will be seen, are also roughly parallel, and the sharp rise of these curves over those of Group 1 carries its own meaning. Unfortunately for the public, the raw product, crude oil, is in

Group 1, and it is more likely than not to remain in that position if those who are best qualified to speak are to be trusted. The report of the Secretary of the Interior to Congress presents data showing that the known oil reserves of the country have been drawn upon or depleted to the extent of 50%, ranging from 34% in California to 75% for the Eastern oilfields. The amount remaining, about 7,500,000,000 bbl., is not all commercially extractable. Untested areas, of course, surround the proved oilfields; these may be assumed to be probably productive, but their value is problematic. It is the general belief that 300,000,000 bbl. is our maximum annual productive capacity, and since our oilfields have for years produced two-thirds of the world's output, and have therefore supplied two-thirds of the world's consumption (since the European War about four-fifths, because of the practical exclusion of the Rumanian and Russian oilfields) there must be a re-adjustment soon somewhere.

Superimposed upon the curves of Fig. 1 is the course of the average retail price of gasoline on the seaboard of California in recent years; the authority therefor is the *Oil Age* of Los Angeles, in its April issue. The exhibit speaks for itself; the purport of it is that the average price per gallon for the period has been 20c., and that for relatively short intervals only has it been below the average. The price today is 10% lower than it was the day the European War broke out. Prices in different parts of the United States vary both as to time and amount, being higher on one coast than the other at a given date; at present the differential in favor of this coast is 6c. per gallon, hence gasoline is now flowing eastward from San Francisco.

The obvious disturbing factor in prices at the end of 1914 was the 'bringing-in' (in March) of the famous Cushing oil-pool in Oklahoma, with its phenomenal yield of high-gravity refining oil, rich in gasoline. Its history and the attendant disturbance to crude-oil values are shown by Fig. 2. The price of gasoline has followed, and has been more influenced, by the story of Cushing than by either the European war or our domestic business disturbances or by the volume of gasoline exports. The effect was psychological as well as real; to which I may add that when the press-agents of the auto-makers at Detroit spread abroad the report that for the first quarter of the year 1916 the purveyors of this item of luxury as well as business necessity shipped just twice as many carloads of finished cars as they did for the corresponding quarter of 1915, more psychology as well as more business acumen gets the scent of what is coming; a further threatened shortage of gasoline, and if not yet real, certainly threatened. If 650,000 new cars were added last year to the sum total running, it is no idle guess to state that a million will be added to the number in the current year of American prosperity; a single Detroit firm announces that it alone expects an output of 500,000 cars in 1916!

The most potent and obvious fact in the situation is that the consumption of gasoline will continue to expand in direct ratio with the expansion of the uses of the

internal combustion engine, particularly the automobile, the auto-truck and tractor, and the motor-boat. There is some hope of finding limited substitutes for gasoline as fuel for internal-combustion engines, but these substitutes will most likely also be petroleum derivatives rather than of non-petroleum origin, such as alcohol. If the demand for gasoline or its equivalent continues to expand at its present rate, and if the supply of the raw product, its parent, is fixed within certain limits, there can be but one solution of the problem of how to meet the coming demand, and that is to increase the yield of the desired product from the crude-oil stock, or to increase the amount of oil that is consumed for refining by reducing the quantity consumed directly as fuel, which would be only a qualified relief under present conditions.

The expression "present conditions" is used advisedly, for but 15% of the crude-oil yield last year was made into gasoline, representing probably the maximum obtainable under current refinery methods, or the present state of the art. In other words, if there is to be an increase in the supply of gasoline it must come through improved methods of refining. With the above outline of the problem there are offered the following thoughts upon some of its possible solutions.

It was vaguely known in the chemistry of petroleum for more than fifty years that under certain conditions crude oil could be 'cracked' and made to yield a higher percentage of the more volatile products. To apply a process therefor and make available commercially a principle—if such could be done—was the mark set by many inventors and some few actual experimenters. 'Cracking,' in its simple analysis, means breaking up or disassociating by heat and pressure the molecules of the heavier hydrocarbons of crude oil and re-forming them into molecules of the lighter elements. The first important commercial advancement in this direction was gained in 1913 in a process brought out by W. M. Burton (U. S. Patent 1,049,667), wherein the distillates, or the secondary light products of the ordinary refinery, could be re-run in a still having the form of the common still, but working under about 75-lb. pressure. By this method the increase in yield of gasoline is pronounced. The process was at once taken up by the Standard Oil Co. of Indiana, and it is reported that 3,000,000 bbl. of gasoline was made with it last year; truly an encouraging advancement. But it was reserved for the year 1915 to produce what promises to be a greater achievement—that of Rittman. The eyes of five million users of internal-combustion engines are fixed upon it, asking whether this is a real star to which they can hitch their wagon, the allied petroleum products industries are scanning its possibilities, and the scientific world awaits confirmation of an indicated revolutionary discovery, proved by the commercial application of the new principle.

Briefly, what Rittman has done is to devise a practical method of applying the 'cracking' principle to its logical purpose; his method indicates the ability to convert any crude oil of whatever base (asphalt or paraffine, or mixed) or any product or any residue from such oils

from present refineries, into but three products:

1. Fixed gases, which can be used in the reduction process itself.

2. Fixed carbon in the form of coke, lampblack, etc., which always have a good market-value and a market not easily surfeited.

3. An oil, all of which can be made by repeated distillations into gasoline of any desired gravity, or by a different manipulation of the pressures and temperatures used, can be converted into the aromatic hydrocarbons, benzene, and toluene.

This discovery, preceded by years of elaborate experi-

proved results. This is proved by the fact that from the same apparatus there can be obtained, by different manipulation and by varying the conditions of heat and pressure, either the aromatic hydrocarbons, benzene, and toluene, used respectively in the dye and the explosives industries, or the sweet hydrocarbons such as gasoline. It is too early to predict the ultimate effect a wide adoption of the process will have upon the ramified markets of crude oil and its products. If it proves a commercial success—in all that the term implies—the volume of production possible from new Rittman plants can hardly influence the gasoline market for two years to come, for

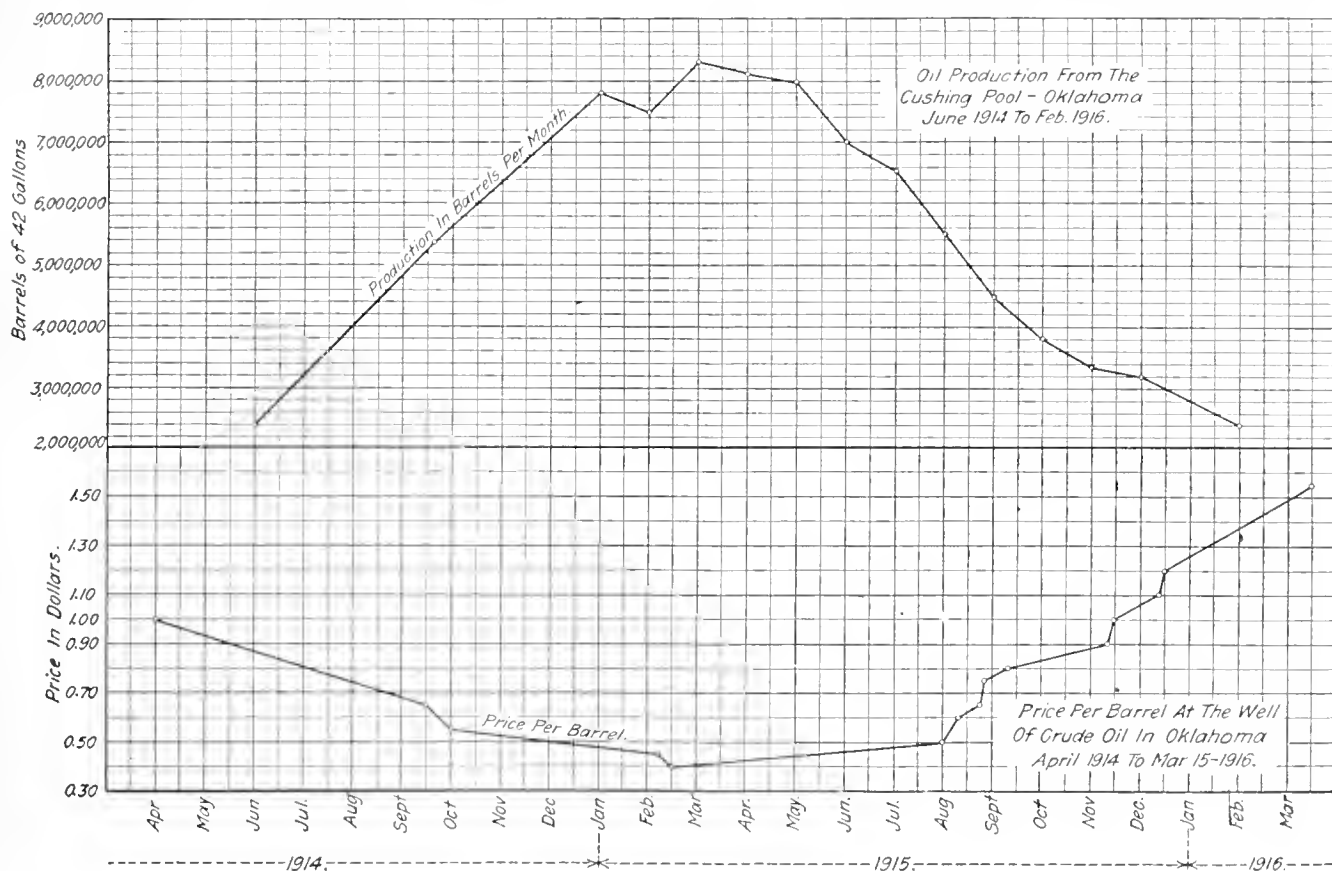

FIG. 2.

ments in the laboratory at Columbia University, in which the groundwork of the chemical principles involved was thoroughly worked out, has been demonstrated on a commercial scale with full-sized plants. What Rittman apparently has done is to go a step in advance of Burton, who had already achieved success, but upon radically different lines. Burton dealt with distillates, or intermediate products only, and with moderate pressures (75 lb.) with combined liquids and vapors. Working on the knowledge that chemical control was more easily obtained when dealing with vapors than with liquids, Rittman at once converted all his oil into vapor, and by adopting a vertical tube of relatively small diameter for the working appliance to permit of using high pressures and better heat-control, in place of the large horizontal still of ordinary form, there was thus given him, *ipso facto*, the medium for some radically different and im-

it takes time to build plants and to do the necessary experimentation with individual oils. If the Rittman process does not prove successful on large-scale operations, there does not appear in sight much other relief in the way of improved processes to extract a higher yield of gasoline from crude oil. Considering the fact that economists place so high a value on our reserves of crude oil as to maintain that their primary use should be limited for purposes and uses for which there are no substitutes in nature—as for instance, lubricants and refined derivatives—there must be a profound readjustment of the bases of things pertaining to oil in the next five years, if not sooner. For one thing, the burning of it under boilers in unrefined state to generate steam must stop.

If the agitation over the price of gasoline yields no greater practical result than to call attention to the effect

of supply and demand upon the raw product—crude oil—and to the status of the refining art, it will have served a good purpose. If it will also bring out some fundamental facts about the oil business, as for instance (a) that its pursuit should occupy only those equipped with experience and highly efficient organization, (b) that the business is one requiring enormous amounts of capital, especially liquid capital that must be available on a moment's notice to throw into any new situation such as is created by the 'bringing-in' of a new oilfield, like Cushing, or the discovery of a new process that overnight will scrap the machinery of a plant covering 100 acres, (c) that the risks involved are more hazardous than any other form of mining operation (of which it can be considered a part), and mining is looked upon by the business world as involving the superlative of all business risks—if some of these fundamentals are brought out by the gasoline discussion, important light for guidance will be thrown upon many related questions. To substantiate or illustrate the point that enormous capital is required to engage in the oil business in a particular region we have only to turn to two particular ventures here in California in the past five years. One is the history of the General Petroleum Company and the other that of the Shell Company. It has been regarded as axiomatic that it required \$25,000 worth of capital to 'turn over' one barrel of oil per day, that is, to buy or produce one barrel per day, and transport, refine, market, and distribute the products therefrom. The records of these two enterprises are much to the point: one is of domestic origin and primarily represents the consolidation of prior local interests, having only local capital to finance its operations, and whose affairs are now in process of re-organization, while the other is a branch of the Royal Dutch-Shell combination operating in most of the world's oilfields and having unlimited capital on which to draw. Data are not available to fix the sum of the first company's investment, but the latter is reputed to have expended thus far \$30,000,000 to handle 10,000 bbl. per day production of the 250,000 bbl. currently produced each day in California, and has not yet concluded the capital expenditures necessary to put itself in the position to compete at all points in the Pacific Coast markets with the markets previously established.

In view of the above it would seem beside the question to rail against the undeniably large profits, as such, that lie in the oil business for those whom the public expects shall provide a gallon of gasoline at any hour of the day and every day in the year and at any consuming point on any continent. Acquired necessities impose obligations and for these obligations and facilities we must pay a good price whether or not we want to do so, so long as enormous sums, which the public does not provide, are required first to find at its own risk a commercial oil deposit, and then to produce, transport, refine and distribute the product. The point where artificially controlled conditions show nearest the surface is in the monopoly that goes with the pipe-lines that trans-

port the crude oil from the well to the refinery, yet, as these are but one link in a longer chain, a breach at that point can hardly affect the problem in its larger aspect. If a conspiracy does exist to boost and maintain prices of gasoline, which statement the exhibit in Fig. 1 fails to substantiate, then the Standard Oil, which, as reported, refines 60% of our gasoline, emerges in the preliminary report of the Federal Trades Commission with the record of supplying the same, considering large averages over the whole of the country, at from $\frac{1}{4}$ to $\frac{1}{2}$ cent under what the consumer pays the independent. Counting the experience, capital, and organization of the Standard, this is surprising mainly to those who lack familiarity with the subject. In saying this we hold no brief for Standard Oil, for the term is used to represent a type of operations rather than a specific business organization.

Canadian Mineral Products at the Panama-California Exposition

In installing the mineral and metallurgical exhibit in the Canadian building at the Exposition, at San Diego, several interesting additions have been made to the excellent collection that was displayed at the Panama-Pacific International Exposition, and which was described in our issue of March 6, 1915. Noteworthy among these is a new set of anodes, cathodes, and starting-sheets from the Consolidated Mining & Smelting Company's smelter, at Trail, B. C., which shows the latest developments in the refining of lead by electrolysis: a number of automobile and bicycle parts plated with cobalt, instead of the usual nickel, which is attracting a good deal of attention; samples of sheet, bar, and wire monel metal, and a 1 $\frac{3}{8}$ -inch bar of this metal, one end of which has been used for a tensile strength test—breaking at 93,100 lb. per square inch—the other sharpened like a soldering iron and heated to redness, without showing appreciable oxidation, and the bar bent double in the middle while cold, without showing the slightest injury; several specimens of gold ore from the new discoveries at Kowkash and Boston Creek, Ontario; and some ore, concentrate, part of a cathode showing deposited zinc, and a pig of electrolytic zinc, made by the Watts process at the works of the Electro Zinc Co., at Welland, Ontario. The Watts process differs from other electrolytic processes in that the dissolution of the concentrate and deposition of the zinc is carried on in the same vat at the same time.

Of the old material, the marbles and building and ornamental stones are in a better light and show to much better advantage than they did at San Francisco, and make a wonderfully imposing display. The rest of the material is arranged in much the same way as at San Francisco.

MINERAL PRODUCTION of Alaska in 1915 totaled \$32,854,229, an increase of \$13,788,563. Gold contributed \$16,702,144 and copper \$15,139,129.

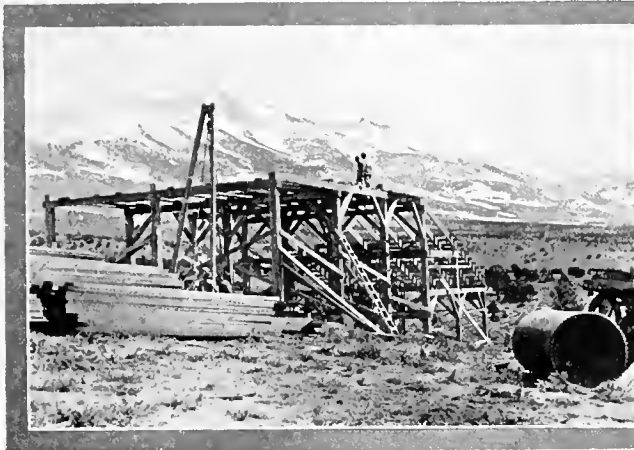

THE BEGINNING OF A TUNGSTEN-MILL NEAR ELY.



A HAND-JIG WORKING ON TUNGSTEN ORE.

Tungsten Mining in the West

By P. B. McDonald

A TUNGSTEN boom has taken hold of the West. In Colorado, Arizona, Nevada, California, and Idaho, the hills are being prospected, not for the old favorites, gold, silver, or copper, but for those unfamiliar minerals, scheelite, hübnerite, ferberite, and wolframite. These minerals, which were scarcely heard about until recently, are being found in numerous districts where their presence had never been suspected. In quartz veins mixed with gold ore, in old dumps of abandoned silver mines, on claims that were staked years ago for other metallic products, the presence of tungsten is causing a rejuvenation of prospecting and small-scale mining. In some instances, people who had paid high prices for worthless claims years ago, in the expectation of winning the precious metals, are now finding that their claims are valuable for tungsten. In Colorado, where the principal tungsten-bearing mineral of Boulder county is ferberite, every dark-colored vein is staked eagerly in hope of its containing tungsten, often it is only an iron oxide. At many of the stores in the mining settlements of the West, testing-kits for tungsten prospectors and even 'tungsten-prospecting helmets,' or hats to be worn in the blistering deserts of these States, are being advertised in the show-windows. A great number of small shipments of tungsten concentrate are being made, many of them by express, to the steel-making firms and ore-buyers who are paying such high prices for the mineral. When required as a constituent of tool-steel, the high-grade concentrate is charged directly into the furnace with the molten iron, to emerge later in a proportion as high as 15% of the steel. Scheelite, the tungstate of lime, is said to be less desirable than ferberite, because it makes a pasty slag in the furnace, but this fact has seemed to make little practical difference in the marketing of the ore.

One reason for the great number of men who have

taken up the search for tungsten is the comparatively simple nature of its geologic occurrence. The minerals are found, for the most part, in quartz veins in granite. Such a formation is one for which the prospector has always had a particular respect, and that is why many of the tungsten mines of today were once worked for silver or gold, on which occasions the 'heavy spar' of tungsten minerals probably interfered with concentration. The white or gray scheelite, it is true, is in places difficult to distinguish from the quartz that contains it. Tests for the presence of tungsten are not difficult to make; the simple kits sold to prospectors contain only hydrochloric acid (with perhaps 25% of nitric acid), a small stick of chemically pure tin, and several test-tubes. The mineral to be tested is dissolved in the acid and boiled for 20 minutes over a candle or lamp. A shaving of tin is added, and the solution turns blue if tungsten is present.

In the review of mining on another page is a letter written from Ely by Mr. Fred L. Miner of a tungsten excitement in eastern Nevada. This is typical of what is taking place at various places in the West. In the case of Ely, this old mining settlement is well able to supply all the materials for a genuine mining boom. The Snake range, near the Utah line, where the discoveries have been made over a large area, is the second range east of Ely. An automobile ride of three hours over moderately good roads across the sage-brush flats leads to the scene of activity. In the centre of things is the snow-covered summit of Mount Wheeler, the highest peak in Nevada, 13,058 ft. high. Along the western side of the range in particular—the side toward Ely—a number of camps have been established, several mills are being built, and many claims have been staked. Most of the showings are scheelite, in small seams and patches, contained in quartz veins that strike across the north-

south trend of the range. The scheelite varies from pearly gray or white of almost the same shade as the quartz to yellow or salmon pink. Hübnerite is found at several of the principal prospects, in some instances in association with scheelite; in fact, crystals of the two have been found intertwined. The quartz veins vary up to several feet wide and carry from $\frac{1}{4}$ to 3% of tungsten, with high grade patches of 15 or 20%.

The United States Tungsten Co., which is controlled by officials of the Tonopah Mining Co. of Philadelphia, is operating the oldest tungsten mill in the region, a mile south of Mt. Wheeler. This mine was staked by Charles Gaby, a well-known prospector of Ely, 17 years ago. He concentrated the hübnerite in a small mill. But the cost of freight was so high and the demand for tungsten at that time so uncertain, that he became discouraged. Since then the mine has been operated at intervals, but people were inclined to laugh at this attempt to mine such an unheard-of mineral as the black coal-like hübnerite. Today a number of companies are operating in the Snake range and other mills are being built.

Another factor that contributes to the attraction of preparing tungsten for the market is the ease of concentrating it; in many cases this is done in hand-jigs of the Joplin type, but where water is plentiful power is employed. The heaviness of the tungsten minerals makes them easy to separate, so that no complicated chemical process is necessary. Care must be taken, particularly with scheelite, not to reduce it to slime, as this friable mineral makes a very floury mess. Grinding to 30-mesh is about as fine as is done.

A notable feature of such modern prospecting is the extensive use made of automobiles. The 50 or 100 miles that it is necessary to traverse in order to reach a new discovery is covered with ease and speed by a succession of motor-cars. Auto-trucks and traction-engines are employed to take supplies, machinery, and equipment to the mines. Gasoline engines are used to run mills, to hoist, and to compress air.

It is probable, of course, that the diligent efforts being made in many parts of the West to produce tungsten concentrate, and the consequent flood of small shipments to the consumers and buyers of it, will tend to depress the price somewhat. But the widening demand for high-speed tool-steel is bound to call for a much greater amount of tungsten than was the case formerly. While the price for the concentrate may drop to more moderate figures than have ruled recently, the margin of profit will still be sufficient to benefit many of the operations lately started.

LEAD production in the United States during 1915 was 615,253 tons, compared with 568,329 tons in 1914. It is estimated that of the 1915 output, the American Smelting & Refining Co. produced 48%, compared with 56% in 1914. The action of the Bunker Hill & Sullivan Co., in building its own smelter in the Coeur d'Alene, will further reduce the proportion of lead smelted by the A. S. & R. Co.

Concentration of Lead-Silver Ore at Kellogg

The following data are from the annual report of the Bunker Hill & Sullivan company for 1915, Stanley A. Easton in charge:

| | |
|---|-------------|
| Mill worked, days | 356 |
| Ore milled, tons | 454,636 |
| Assay of feed, per cent of lead | 9.9106 |
| Assay of feed, ounces of silver | 3.8277 |
| Contents of feed, tons of lead | 45,199 |
| Tons of concentrate | 59,901 |
| Average assay of concentrate, % of lead | 62.2565 |
| Average assay concentrate, oz. of silver | 21.6738 |
| Contents of concentrate, tons of lead | 37,292 |
| Extraction, % of lead | 82.52 |
| Contents of feed, oz. of silver | 1,740,217 |
| Contents of concentrate, oz. of silver | 1,298,284 |
| Extraction, % of silver | 74.61 |
| Value of feed | \$5,144,653 |
| Value of concentrate | \$2,384,543 |
| Economic extraction, % | 46.35 |
| Tons milled per 24 hours | 1,277 |
| Tons of concentrate produced per 24 hours | 168 |
| Tons of lead produced per 24 hours | 104.75 |
| Cost per ton milled | \$0.421 |
| Cost per ton of concentrate | \$3.103 |

There was lost in tailing 17.48% of the lead and 25.39% of the silver, a total of 18.79%.

The approximate cost and selling value of the year's production was as follows:

| | Cost | | |
|--------------------------------|---------------|----------|----------------|
| | Tons | Cost | Amount |
| Concentrate | 59,901.14 | \$18.40 | \$1,102,245.89 |
| Shipping | 59,901.14 | 0.289 | 17,328.35 |
| Cost on cars at Kellogg | | | \$1,119,584.24 |
| Loss by fire-assay | | | 56,752.62 |
| 10% lead-content | | | 296,569.77 |
| 10% base-price | | | 263,237.74 |
| 50% advance over base-price | | | 243,189.08 |
| Freight and treatment | | | 901,081.61 |
| Total lead charges | | | \$1,760,830.82 |
| 5% silver discount | | | 32,445.10 |
| Total smelter charges | | | \$1,793,275.92 |
| Total cost | | | \$2,912,860.16 |
| | Selling value | | |
| | Production | Quantity | Average price |
| Lead in pounds | 74,584,741 | | \$0.04733 |
| Silver in ounces | 1,298,284.22 | | 0.49983 |
| Total value | | | \$4,177,819.29 |
| Less cost | | | 2,912,860.16 |
| Profit | | | \$1,264,959.04 |
| Kellogg cost per pound of lead | | | \$ 0.0150 |
| Smelter cost per pound of lead | | | 0.0240 |
| Total cost per pound of lead | | | \$ 0.0390 |

SLATE output of the United States in 1915 was valued at \$4,958,515.

CONCENTRATES

Readers of the MINING and Scientific PRESS are invited to ask questions and give information dealing with technical and other matters pertaining to the practice of mining, milling, and smelting.

PURE POTASH amounting to 25 lb. is contained in 2000 lb. of dried banana stalks, a ratio of 1:80.

BLUE-PRINT paper is likely to advance materially in price. The prussiate of potash that has been used to make this product was obtained exclusively in Germany. The price of the paper itself is advancing also.

FOR EMERGENCY PUMPS in mines, when sand in the water is likely to be troublesome, centrifugal pumps are preferred to electric plunger types. The ability to pump mud or grit is more valuable in such cases than added efficiency.

METAL MINES of the United States in 1914 employed 158,115 men, of which number 559 were killed, or 3.54 per 1000. All mines, including coal and quarries, employed 1,009,236, of whom 3193 were killed, equal to 3.16 per 1000.

TUNGSTEN, as an element in high-speed tool-steel, is used in proportions as high as 27%, but the usual range is from 6 to 15%. When 5 or 6% of chromium is also used, an effective combination is secured. Tungsten-steel is employed also to some extent for saws, valves, and automobile parts.

AIR in mines should not contain above 1.25% carbon dioxide. Miners show symptoms of distress when 3 to 4% is present, violent symptoms at 7 to 8%, great distress at 10%, cerebral symptoms and unconsciousness at 12 to 15%, and death after exposure for several hours to 25% of the gas.

WATER diverted from Niagara Falls for power purposes totals 575,000 hp., of which 390,000 hp. is used in the United States. Some of the electric-furnace products are ferro-silicon, ferro-chromium, tungsten-vanadium-molybdenum alloys, ferro-titanium, silicon-metal, aluminum, abrasives, calcium carbide, and artificial graphite. The electro-chemical industry is another consumer, including the generation of nitrogen.

RAILROADS in South America are as follows in kilometres ($\frac{3}{8}$ mile):

| Republic | Kilometres | Republic | Kilometres |
|-----------|------------|-----------|------------|
| Argentina | 33,500 | Colombia | 1,200 |
| Brazil | 26,000 | Venezuela | 950 |
| Chile | 9,000 | Ecuador | 750 |
| Peru | 2,800 | Paraguay | 600 |
| Uruguay | 3,500 | Guianas | 300 |
| Bolivia | 1,900 | | |

METALLIC MAGNESIUM is now being made in the United States. Previous to the War, it was imported chiefly from Germany. It is used as an alloy with aluminum, and for 'scavenging' other alloys by reason of its avidity

for oxygen and nitrogen. Its easy inflammability and high degree of combustion make it valuable for flash-lights and military purposes. High prices and secrecy, resulting in sales under other names, have marked the trade in this as in other minor metals.

PUMPING COSTS at the Old Dominion mine, Globe, Arizona, during the first six months of 1915 were abnormally high, by reason of unusual rushes of water from the porous formations around the mine. Water to the amount of 6,750,000 tons was lifted an average of 1200 ft. The tons of ore raised in that period was 99,000 or 68 tons of water per ton of ore, certainly a high figure. In fact, the pumping expense was 29% of the total mining cost, although all conditions at that time were abnormal.

OIL in some form distributed over pools of water effectively controls mosquito nuisance. Kerosene spreads well, but is easily driven by wind; crude oil lasts better, but breaks-up into patches; stove distillates are better than the former two, but are not thoroughly satisfactory. About the best oil is a fuel-oil of 27° B., which spreads well, has good lasting qualities, and is amenable to the ordinary knapsack spray-pump. Another good oil is a mixture of crude, 12 to 18°, and kerosene about 40°; equal parts, or one of kerosene to three of crude, approximating 28° B.

COMPRESSED-AIR introduced in the bottom of a pipe under water, for the purpose of an air-lift, should be distributed through the water of the discharge-pipe in bubbles as small as possible, instead of in unbroken masses. These bubbles rise and spread through the water, with the result that the column of mixed air and water in the discharge-pipe becomes specifically lighter than the solid water outside. This produces the discharge to surface. The point is that after compressed air is discharged into the water of an air-lift, it has no more effect as to lifting the water by pressure or 'blowing,' and the subsequent movement of the column is due entirely to gravity. The reason, of course, for requiring the air to be compressed to a high pressure is to enable it to discharge at the required depth of water.

MINING METHODS should be safe as well as effective. The room-and-pillar method has the highest rate of men killed per 1000 employed, namely, 5.75. Over-hand stoping in wide veins is next most dangerous, with 5.25, while the rate of the caving system is about 5, and that of over-hand stoping in narrow veins 4.75. Open-cut mining with steam-shovel has but 2.5 men killed per 1000 employed. The caving system, it is interesting to note, has an insignificant number killed by accidents from explosives, and has a less number killed by falls of rock than other wide-vein methods. Minor injuries are in about the relative proportions, with the caving method showing to even better advantage, having a total less than any of the other systems except the open-cut methods.

REVIEW OF MINING

As seen at the world's great mining centres by our own correspondents.

PLATTEVILLE, WISCONSIN

CONDITIONS IN THE ZINC REGION DURING APRIL.

Production and sales of all classes of ore, including zinc, lead, and iron pyrite in the Wisconsin field during April broke all records for any month, and prior to 1904 is as great as the output covering the entire production for a year. The various districts show ample illustration of expansion from every point of view. Bad weather in the first two weeks of the month, and resulting bad roads, handicapped outlying producers considerably. Sporadic strikes at scattered points disconcerted producers for short periods, but whenever possible an amicable agreement was quickly made. There is a shortage of miners and laborers in every centre, and 1000 men can be placed in well-paid positions on short notice. One reason for this is found in the fact that throughout the region are excellent farm and dairy lands, and many farmers who take positions in the mines during the winter months turn their attention to their fields as soon as fair weather permits. Steam and gasoline plants have been superseded here by electrically-driven machinery. The current is supplied by two concerns, one at Mineral Point, Wisconsin, known as the Mineral Point Public Service Corporation, and the other at Galena, Illinois, known as the Inter-State Power Co., both operating under exclusive franchises prescribing the areas in which each shall be entitled to legal control. The north half of the field is dependent for power on the former, while the latter supplies all the centres of the southern half. The Inter-State Power Co. is now giving much better service. The completion of a number of new modern power and milling plants during the month brought to light properties destined to compare favorably in output with many of the regulars famous as zinc-ore producers. Prospecting was greatly stimulated in the southern areas, where scores of leases have been languishing for want of ready service by drilling outfits. More than a score of new Keystone drills were brought into the field for custom service. Encouragement was afforded producers in the leading centres by the closing of contracts for the construction of additional railway facilities, while a hard macadam road between Benton and New Diggings will give miners at all seasons of the year ready communication with markets. The introduction of electric-power shovels investigated by leading operators during the month and approved of for service in the zinc mines here should contribute considerably to an increase in ore recovery, as shovelers of all classes employed in Wisconsin mines have been scarce, and nearly all strikes occurring in the past three months find shovelers the first to walk-out. One type of machine found suitable can do the work of 20 shovelers, with only two attendants.

April opened with top-grade blends at \$115 per ton, from which it advanced to \$120 and \$125 during the weeks of April 9 and 16. During the next two weeks the market eased off \$5 per ton each week, and the month closed with the market steady at the same price which prevailed at the beginning. At several places milling companies were organized for the purpose of re-treating tailing-piles with fair zinc-content. Increased dividends were paid.

Deliveries of ore in April were 46,396,000 lb. of zinc, 1,411,660 lb. of lead, and 6,772,300 lb. of pyrite. Sales to works amounted to 23,128 tons.

CRIPPLE CREEK, COLORADO

DRAINAGE PROGRESS—GOLD OUTPUT—NOTES.

During April the Cripple Creek drainage tunnel was advanced a distance of 235 ft. The heading is now 500 ft. east of the main Elkton shaft, and is still within Elkton territory. Last week a new water-course was cut by the tunnel, and for a few days the flow of water from the portal was increased. At the present time there is reported to be more than 15,000 gal. per minute flowing from the portal. The connection has been made between the bottom of the Elkton shaft and the drainage-tunnel. The work of timbering the intervening space is about finished, and soon the rock broken in the adit heading will be hoisted to the surface through the Elkton shaft.

Production from the Cripple Creek district for April as reported by the mills and smelters is as follows:

| | | | |
|---|--------|---------|-------------|
| Golden Cycle, Colorado City..... | 40,000 | \$17.00 | \$680,000 |
| Portland, Colorado Springs..... | 11,500 | 20.00 | 230,000 |
| Portland, Victor mill, Cripple Creek..... | 17,500 | 2.72 | 47,600 |
| Portland, Independence mill, Cripple Creek..... | 12,400 | 2.60 | 32,240 |
| Isabella, Cripple Creek..... | 1,000 | 2.50 | 2,500 |
| Caley-Jerry Johnson, Cripple Creek..... | 825 | 4.60 | 3,795 |
| Worcester..... | 200 | 3.50 | 700 |
| Smelters, Denver and Pueblo..... | 4,050 | 55.00 | 222,750 |
| | | 87.475 | \$13.94 |
| | | | \$1,219,585 |

The Worcester mill appears in the table for the first time as a treatment plant. It is situated on the south-western slope of Bull hill, on the estate of the Ruby company. The mill will treat mine and dump ores from the Ruby mine.

Frank Vetter, alderman of Cripple Creek, with his associates, is forming a new company to be known as the Albert-Beacon Gold Mining Co., with a capital of \$250,000. The new company will operate the Prince Albert Beacon and Eureka claims under lease, with bond to purchase.

It is reported that the El Paso company contemplates the erection in the near future of a mill using a flotation process.

TUCSON, ARIZONA

SMELTING, TUNGSTEN, AND MEXICAN CAPITAL.

The Sasco smelter, owned by the American Smelting & Refining Co. is beginning work on a fairly large scale. Last week the second furnace was blown-in. Converting matte and pouring blister copper is in regular operation. About 600 tons of ore per day is being received from several properties, among which are the Christmas with 250 tons, Silver Bell, 150 tons; Bush-Baxter, 80 tons; and Imperial, 50 tons. E. G. Bush's mine at Twin Buttes is also to be a heavy shipper, and the Silver Bell it is hoped will soon double its output. This speaks well for the local plant, and shows how development is shaping in this Pima county district.

A great deal of excitement continues in the tungsten areas of this State, notably the Dragoon and Las Guijas mountains. Both of these centres look like tent cities. Nearly all prospectors have left the search for gold for tungsten veins and placers. Work by the American & National Tungsten Co. at Las Guijas goes on. The writer thinks that the low and un-

attractive wages are conducive to inefficient work. It is estimated that during the past few months no less than \$60,000 of tungsten float has been picked up on the surface in the Las Guijas vicinity.

The Southern Belle group of claims, situated at Campo Bonito, Pinal county, which was owned by the Fellows estate of New York, has recently been taken over on an option by a brother and two uncles of the late Francisco Madero, once president of Mexico. They are Emilio, Jose G., and Benj. Madero. The price paid for the property is understood to be \$100,000. The ground was formerly considered a gold mine with tungsten as a by-product, but since tungsten has become so valuable it is now to be worked for the tungsten content. The principal ore is scheelite. The Maderos, who are reputed to be wealthy, expect to enter the mining field extensively, and in addition to the investment of their own funds, which at present are somewhat tied up in Mexico, owing to the revolution, they have strong backing in New York. As the Southern Belle property is more fully developed and conditions warrant, a new concentrating mill will be erected and work continued on a large scale. Emilio Madero will have the management. He is a graduate of the Boston Institute of Technology. An office is expected to be established soon in Tucson; although at present El Paso is headquarters for the Maderos.

SANTA RITA, NEW MEXICO

OLD MINING METHODS AT CHINO.

Evolution of mining methods from the old antiquated operations of Spanish days to the modern economical systems employed at mines today, is well illustrated by the recent discovery by the Chino Copper Co. in its mine at Santa Rita, of the old apparatus or a portion of the old appliances used by the miners in the early part of the 18th and 19th centuries. The majority of the old workings are in what is locally known as the 'south workings' of the Chino company. Here the

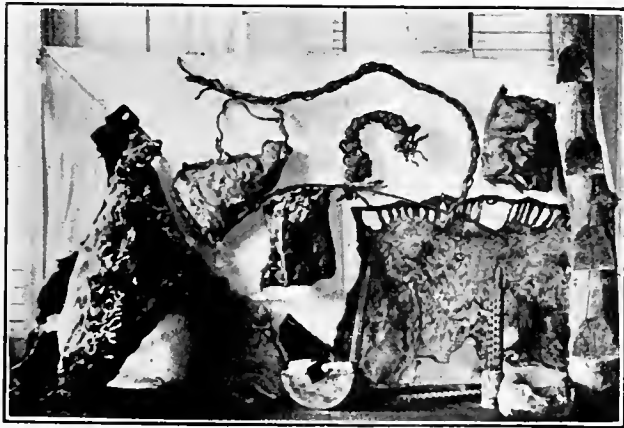

OLD LADDER AND ORE-BAGS AT THE CHINO MINE.

Spaniards had mined for over a hundred years, going to a depth of 150 to 200 ft. It has been possible for the present company to recover among other relics several sets of mine timbers still in a good state of preservation. The timber was chiefly juniper, cut to lengths of about 4 ft.; this, for their main adit, while bear grass was used for packing.

In the accompanying photograph may be seen the style of 'chicken' ladders made of juniper logs 6 to 8 in. diam. and 10 ft. long, with notches spaced 8 in. apart for foot-rests. These poles or ladders were set upright or at a slight angle held in place by thongs of deer hide, binding them securely to platforms just large enough to permit a man landing, and to give support to another ladder of similar dimensions, thus making a very hazardous means of communication from one

level to another. These ladders were used principally in the underground workings. The main shaft was supplied with a wooden pulley and windlass. A portion of the former, still intact, is on exhibit among the other relics in the company's offices at Santa Rita. Here also may be seen numerous buffalo or deer-hide bags; in many instances the hair still adhering to the outside. They were used in carrying ore from one level to another, and the larger ones for hoisting ore in the main shaft. All were laced with thongs of hide, and are still remarkably well preserved. The poor equipment of those days



NATIVE COPPER FROM THE CHINO MINE.

naturally limited mining operations, and only high-grade ore or native copper itself could be profitably mined. This was shipped by burros to Old Mexico and the sea-coast, several hundred miles distant. However, a good deal of native copper was obtained at that time, and is still found by the present company, as is evidenced by the picture showing a slab of native copper recently taken from these workings.

The vicissitudes and trials of modern mine operators in the United States, great and annoying as they undoubtedly are, still have some compensation in the fact that they are not molested by the warring red-men who overran New Mexico during the Spanish régime, making mining in this region a still more hazardous undertaking. In order to safeguard their property the Spaniards accordingly built an adobe fort, triangular in shape, covering several acres in extent, with round towers at each corner. Built of adobe bricks, the walls of the last remaining fort are 4 ft. thick, with loop-holes every 6 ft. or so in its face. It stands as the last memorial above ground of the original miners of Santa Rita, New Mexico.

At the present time the Chino Copper Co. is operating 10 steam-shovels, employing 1000 men and handling 8000 cu. yd. of material per day, a tremendous advancement in mine operations as compared with the original efforts of the early miners.

ELY, NEVADA

TUNGSTEN MINING IN WHITE PINE COUNTY.

The Snake range, in the eastern part of White Pine county, for a length of 70 miles, is rapidly developing into one of the greatest tungsten-producing belts in the United States. Many companies are operating on an extensive scale, with several mills in operation and others under construction. Prospectors are in plenty from one end to the other of the proved tungsten zone, practically all of them having found good deposits of hübnerite or scheelite. Each discovery increases the excitement and interest around Ely, and causes a new rush of people eager to get in on 'ground-floor' locations.

The Snake range is not alone as a tungsten field, further ex-

citement being reported recently by reason of discoveries of Gruberite in the Shell range, 18 miles from Ely. The ensuing exodus to the new district took practically every automobile out of town, and many people went by wagon and other horse conveyances. This discovery was made by R. F. Vevla, with whom D. F. Payne is equally interested. The former found the vein by tracing float ore, which led him to an old shaft that had been sunk years ago in a search for silver. Specimens that he brought to Ely return from 20 to 40% tungstic acid. Vevla thinks that there is at least \$5000 worth of ore on the old dump. The vein is 20 in. wide, and yields mineral wherever prospected. The importance of the discovery is the fact that it demonstrates that tungsten ores exist in the Shell Creek range, which will now receive thorough prospecting.

While the most important discoveries have been made on the west slope of the Snake range, good deposits are also found on the east side. A number of old properties that were formerly worked for silver are now found to contain tungsten ores, which will result in their re-opening. Because of its more extensive development, the west side of the Snake range is naturally the centre of interest, and a good production is being made by a number of properties. New mills are in course of construction by several companies, and the great activity prevails all along the range.

The United States Tungsten Corporation is the largest operator at the present time, but others are coming along at a rapid pace.

The Independent Tungsten company, organized by A. D. Meyers, Charles Gaby, William Stewart, K. C. Davis, and Duncan MacVichie, is employing about 50 men on development and construction on a 30-ton mill. A large compressor-plant is being installed at No. 1 adit for machine-drills. The mine has a strong shoot of scheelite in a number of places. The company will become one of the most important producers along the range. Numerous smaller operators are also working in this district, which is known as Scheelite.

Farther south, 1½ miles from the U. S. Tungsten Corporation is the Consolidated Tungsten Co., which was organized by McGill people, and has 20 lode claims and 10 placers. They are now constructing a 20-ton mill, part of the machinery having been shipped to the property. The Big Four vein is opening especially well, ore being traced on the surface for 400 ft. Some of the workings show so much hübnerite that they resemble a coal mine, with the black ore. The streak of high-grade is 3 ft. wide in a vein that is from 7 to 11 ft. wide. Large bodies of good ore have also been opened in the Gem and Gem Extension claims. The Doseocaris vein is in another promising area. These claims are in Williams creek, and an ample supply of water is available. In this neighborhood, as elsewhere along the range, are a number of other excellent properties that are still in the prospect stage, but giving promise as future producers. The formation here is granite and quartzite, the veins occurring in both formations.

The Minerva district, 14 miles south of Williams creek, is apparently one of the best that has yet been opened. The veins are intrusions in limestone, and the ore a pearl-gray scheelite.

The Nevada Scheelite Co., composed of Salt Lake City people, and managed by William Stewart of Ely, has 20 claims under bond and lease from Jasper M. Fox, C. T. Millick, and A. G. Millick, for \$300,000. They also have 5 other claims held by location. The Scheelite Chief claim, just above the newly established camp, has one of the best developments along the range, and is of bonanza quality. Many years ago it was worked for silver, but was finally abandoned without the presence of tungsten ore being detected. The vein shows a continuous outcrop of 1200 ft. At the main workings the ore-shoot has been proved for 80 ft., averaging 9 ft. in width, from which four cross-section samplings showed an average at surface of 2.85% tungstic acid. The owners are mining and sacking ore from a high-grade streak 2½ to 3 ft. wide, that will

yield 15% some of the selected ore contains 50 per cent.

The Ortole vein, paralleling the Scheelite Chief about 1500 ft. to the north, can be traced for 3500 ft., and is producing some fine ore. The vein varies from 1 to 9 ft. in width, and samples along 70 ft., for an average width of 7 ft., show an average of 1.94% tungstic acid. Some high-grade shoots have been cut and a large quantity of ore is being sacked.

One of the other strong veins of the group is the Everett, at the north end of the property. It outcrops prominently, and can be traced for 4500 ft. Samples in a 65 ft. shaft, across 5½ ft. of ore, give 1.12%, and a 12-ft. sample, 50 ft. west of the shaft, gave 3.60%. A small shoot paralleling the main vein is practically all high-grade ore, and five sacks that were taken from here and hand panned yielded 200 lb. of 64% concentrate.

Arnold Millick, W. S. Elliott, J. Briggane, and others have a good group of claims north of Minerva, on which development is now under way, on veins from 4 to 10 ft. wide, that show fair quantities of scheelite.

Clyde Tilford, Sheriff Crain, T. Barton, and D. Millick also have some promising claims in this neighborhood, on which development is in progress with good results.

There are numerous other properties being prospected and developed along this portion of the range, as well as elsewhere, and many of them will soon gain prominence as producers of tungsten ore, which is making fortunes for many. This is undoubtedly the greatest poor man's opportunity that has ever come to light in Nevada, for the ores, by a little sorting, will easily average \$100 or better per ton at surface. It is unusually easy mining, and if it was gold ore of equal value it would be spectacular, and the excitement would be many times greater than that which now exists. Men who are unable to secure locations can find desirable opportunity for leasing, and present indications are that several hundred lessees will be at work along the range during the coming summer. The roads which were blocked with snow for several months during the winter are now in first-class condition, and are lined with teams and auto-trucks hauling in supplies, and autos loaded with prospectors, operators, and investors.

FAIRBANKS, ALASKA

PROGRESS IN MINING AND TREATING THE TUNGSTEN ORE, SCHEELITE.

While tungsten mining in this district is in its infancy, the little that has been accomplished and possibilities are of interest. Naturally there has been no metallurgical skill tried, the main idea being to produce concentrate as soon as possible. However, what has been done is creditable to those concerned, and one mill is to be altered to give a better extraction.

There are but two properties producing tungsten ore at present, in both cases the product being scheelite. These are the Johnson and Ewers property at the extreme head of Gilmore creek, and the Ott Mining Co. of upper Fairbanks creek.

The former ground was prospected for and located by Albert Johnson in the summer of 1915, scheelite being found in the placer sands of Gilmore creek, and traced to its source. The property was worked through the winter as far as weather permitted, and 50 ft. of shaft and 30 ft. of drift supplied the 50 to 60 tons of ore that has been concentrated so far. The inclement weather prevailing during the past winter, combined with the fact that the property is on a high ridge, rendered operations most difficult. For days it was impossible to leave the cabin, and the partners deserve much credit for accomplishing as much as they did, handling all rock hoisted with a windlass. The vein is in a well-defined fissure in limestone, and the ore is sometimes 4 ft. wide. It occurs in narrow, sharply-dipping shoots or lenses from a few feet to 20 ft. long. Surface prospecting has shown the ore to outcrop for a fair distance, so that owners seem justified in their

belief that considerable ore can be mined this summer. The ore is sacked and hauled by team to Gilmore station, thence it is shipped to Chena by the Tanana Valley railroad. The Chena custom mill has lain idle for several years, but Johnson and Ewers made arrangements to put in a boiler and get the mill in order again. Besides this expense, it is understood that a milling charge of \$8 per ton is paid. The owners calculate that it costs them between \$20 and \$25 per ton to haul and concentrate the ore. The mill is a 10-stamp Joshua Hendy type, but only one battery is in use. After going through the crusher and into the bin, the ore is stamped and passed over plates to the classifying cone. It is not known to what size the ore is crushed. The sand goes to a Deister sand-table, and the overflow to two Deister slime-tables. This completes the treatment, the same arrangement being used as that originally installed to deal with the gold ores of the district. There is practically no gold in the ore. So far, the extraction is uncertain, as the final drying and weighing of concentrate has not been completed. The tailing shows a content of 0.5% tungstic oxide, while the owners think from the preliminary recovery that the ore will average between 5 and 6%. This would indicate a rather high recovery, although it is not known if the tailing sample was properly taken and settled. At present the concentrate assays 63%, and is shipped in 20-lb. sacks by parcel post. After navigation opens, it will go by express by the water route. It is probable that every effort will be made this summer to erect a mill on the property and save the high transportation charges.

The discovery of scheelite on the lease worked by the Ott Mining Co. was rather a surprise to lessees and owners alike, the property being hitherto worked for gold alone. The tungsten ore did not show in the surface workings, and was found by driving. It has persisted so far for 60 ft. in the drift, and is still in the face and floor, but only for 5 ft. above the drift, where the gold ore alone is found. Further prospecting at depth will immediately be done to determine the extent of the deposit. The vein is in a well-defined fissure in a blocky schist, probably of igneous origin. The vein varies from 8 to 24 in. in width, the best value in tungsten being found in a layer comprising about half the vein on the foot-wall. The other half carries the gold, which is rather high in some parts of the vein so far opened. No attempt was made to keep the gold ore separate in the first mill-run of 55 tons. It was considered that of this, from 15 to 20 tons contained most of the tungsten, the rest having the bulk of the gold. The property has a small steam hoist, and is situated about 400 yards up the hillside from the Heilig custom mill, where the ore is now treated. The ground is leased from Hess, Geis and Thompson. The vein is a parallel one to the Mispah, which is worked by the owners and has produced close to \$10,000 in gold during the last 12 months with 2 to 3 men working. When the tungsten ore was opened, neither the Gilmore and Stevens stamp-mill nor the Heilig custom mill had machines for concentrating it. Immediate plans were made by C. E. Heilig of the latter mill to handle same, and by the time the 55 tons was mined, the mill was ready. A small addition was put on the mill, and a Monarch concentrator built by the Seattle Construction & Drydock Co. was installed. The table had been in use a short time at the Furstenau mill at the head of the creek, and had been idle for several years. As the inclement weather made it impossible to grade for the table, so the pulp could be put on the table by gravity, a bucket-elevator was constructed to lift the pulp below the plates. A small independent engine was put in to drive the table, but this failing at the last moment, it was necessary to belt to the main mill engine. Better results could have been obtained with the independent engine, a constant speed being possible. The large Jones gyratory breaker in the mill causes at times a variation in the speed of the mill engine that is not conducive to best results with the table. The ore is crushed in a Huntington mill, working at 100 r.p.m.,

with a 40-mesh slot-screen. From 15 to 20 tons is milled per day. The work of the table was entirely satisfactory and produced a clean high-grade concentrate. At times the entire space between the carrying riffles was covered by a pure white concentrate. The middlings were saved separately, and put over the table again, with different grade and stroke. Re-grinding with classification to sand and slime-tables would have resulted undoubtedly in a better extraction, but the means were not at hand. For unit concentration with classification, probably no other table could have done any better under the circumstances. The Huntington mill, comparing the products of the tables at Chena and at the Heilig mill, undoubtedly produces less slime. At that, the tailing has been banked at the latter mill, and will be tested on a canvas plant during the summer. If the ore developed warrants the outlay, rolls, jigs, and a slime-table will be put in later. From the 15 to 20 tons of tungsten ore, 1200 lb. of 62.5% concentrate was extracted. This has been sent by parcel post in 20-lb. sacks to the Crucible Steel Co. It is understood that the price paid on a basis of 60% was \$60 per unit f.o.b. Fairbanks. Besides the concentrate, the mill run netted \$418 in gold. The next shipment will go by water.

The Johnson-Ewers property is the only one found so far by prospecting a tungsten trace, although in several other places (four, to be exact) that the writer, L. M. Drury, knows of, strong tungsten traces are known. As soon as the snow goes and the ground thaws enough to make rapid work possible, many prospectors will start to find the source of the placer scheelite. The head of Cleary creek shows a placer sand of about half scheelite, while on another placer claim on another creek, a placer sand is found that is about half scheelite and half magnetite. At the present price, probably several thousand dollars worth of scheelite has been wasted, with only a volume of curses to speed it on its way for clogging riffles and making clean-ups difficult for the placer miner. While no notable deposits may be found, it is more than a sporting chance that the Fairbanks district will make a name for itself as a tungsten producer.

TORONTO, ONTARIO

HUGE CONSOLIDATION AT PORCUPINE.

A merger has been arranged including the Hollinger, Acme, and Millerton mining companies and claim 13,147 of the Canadian Mining & Finance Co., under the title of the Hollinger Consolidated Mines, Limited, with a nominal capital of \$25,000,000 in \$5 shares. Of this number, 200,000 shares will remain in the treasury and the balance will be distributed as follows: Hollinger shareholders, 2,400,000; Acme, 2,100,000; Millerton, 200,000, and Canadian Mining & Finance Co., 100,000 shares. A detailed report has been issued by P. A. Robbins, general manager of the Hollinger, giving the reasons for the consolidation, which has been contemplated for five years. The centralization of the plant and the development of underground workings have been carried on with a view to an ultimate merger, and as a point has been reached where comparative valuations of the properties can be made, and the interests of all benefited by amalgamation, the project has become feasible. Mr. Robbins estimates the assets of the Hollinger as approximately equal in value to the combined assets of the other companies embraced in the merger, and anticipates that with the extension of the Hollinger mill and the completion of the central shaft, the dividend rate will probably be increased even with a reduction in the value of ore treated. Dealing with the allowance for ore at depths below those already reached by development in the Hollinger and Acme properties, he estimates that on the basis of a depth of 800 ft., there are 5,594,570 tons of ore with a gross value of \$18,196,390. On the assumption that the veins persist to a depth of 1400 ft., as some of them have been proved to do, there is 10,430,000 tons worth \$81,492,000.

THE MINING SUMMARY

The news of the week as told by our special correspondents and compiled from the local press.

ALASKA

COMBOWA

Movement of copper from Alaska to 'The States' in the eight months ended February 29 was 69,962,394 lb., valued at

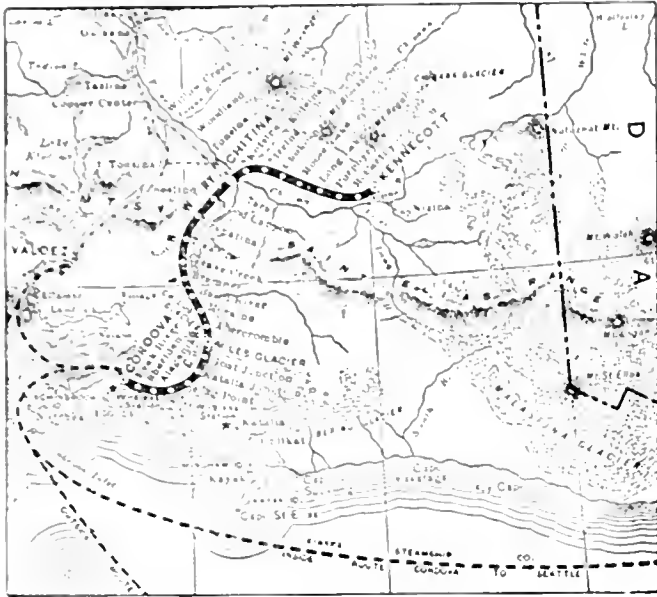

MAP SHOWING ROUTE TO KENNECOTT, ALASKA

\$13,597,148, compared with 21,240,265 lb., worth \$2,609,659 in the same period of 1914-15. The Bonanza and Beatson mines of the Kennecott company supplied most of this metal.

JENSEAU

The April output of the Alaska Gastineau mine was 165,930 tons of 94-cent ore, against 192,796 tons worth \$1.03 in March. The tailing loss was 19.8c. per ton, and recovery 78.71%, a slight decrease and increase respectively. The following telegram was sent by the general manager, B. L. Thane, to New York:

"Expect overrun will bring heads up equal to last month. During first 23 days ore came from low-grade slate zone west of the shaft. Last seven days we began to add some tonnage of ore east of the shaft. During this period 40,000 tons was milled, averaging \$1.40. Condition of stopes east of the shaft shows great improvement, and I shall be able to resume delivery of ore from No. 2 east No. 5 level, and from new stopes opened east on Nos. 6 and 7 levels. Grade of ore should improve during the entire month of May, and show marked improvement throughout June. Tonnage maintained. Expect will be about 9000 tons per day until about the middle of June, when new stopes east of the shaft should be in good condition to deliver their proper proportion of ore so that tonnage can be thereafter increased."

VALDEZ

New York capitalists bonded the Pandora copper property on Knights' island, six hours by boat, from Burns, Jordan, and Welch, for \$650,000. The ground is said to be of considerable promise and will be thoroughly exploited.

ARIZONA

COCHISE COUNTY

Bisbee mines continue to produce an enormous quantity of copper. The smelters at Douglas cannot treat all the ore offered from their own and outside mines. This is hard on small producers and lessees, of whom there are so many. Additions to the Calumet & Arizona plant will relieve the situation later on. The Copper Queen smelter produced 18,000,000 in April. During the first quarter of the current year the Shattuck shipped 37,381 tons of copper ore and 3544 tons of lead ore, yielding 4,682,691 lb. copper, 1,481,387 lb. lead, 1538 oz. gold, and 89,695 oz. silver. The net cost of copper was 6.44c. per pound. The profit was \$781,380. Dividends absorbed \$350,000.

GILA COUNTY

The Inspiration mill has been treating up to 15,900 tons per day, much in excess of the rated capacity. A telephone system with 200 instruments is being installed at the mine engineering office to be in touch with all parts of the property.

MOHAVE COUNTY

The next 90 days promise to be the most important in the history of the Oatman district. Depth seems to be necessary at this centre. It has been found that depths ranging between 300 and 600 ft. must be attained before persistent bodies of commercial ore may be expected. This condition is due to variations in geological and topographical elevations caused by the rapid and extensive erosion which has taken place in the very rugged and precipitous territory embraced within the district. To sink shafts to these depths and to do the requisite cross-cutting and driving to encounter orebodies requires much time and expense. Practically all of the operators have the 500 or 600 ft. point as their objective. Most of these properties were not able to begin development with machinery until late in 1915. In this district it usually requires three or four months to sink and complete a shaft 500 ft. deep. At this time a number of properties have reached their objective point in depth, and are now engaged in lateral work which may bring them into commercial ore in from 1 to 90 days. The properties to which this principally applies are the Oatman Gold Mining & Milling, Fessenden, Ivanhoe Consolidated, Boundary Cone, United Western, Black Range, Arizona Tom Reed, Lucky Boy, and Gold Range companies. The two last named are still sinking, but are nearing the 400-ft. point, and indications are such as to lead the operators to think that they will be justified in cross-cutting on their 400-ft. levels.

At the Golconda zinc mine the main shaft is down 1050 ft. in high-grade ore. Monthly development totals 1000 ft., and smelter shipments 1500 tons.

YAVAPAI COUNTY

The Tip Top Consolidated Mining Co. has been formed to operate the Tip Top mine which contains silver and tungsten ores, the latter of good grade. The property has an interesting history. Reserves are 20,000 tons of \$23.50 ore in stopes, 1000 tons of \$66.69 in place, and 20,000 tons of \$21.50 on dumps, a total value of \$966,600. Extensive development and a larger plant are contemplated. The president is C. W. Davis.

PINAL COUNTY

Ray Consolidated Copper Co. reports as follows for the first quarter of 1916:

| | |
|---|-------------|
| Development, feet | 14,202 |
| Ore treated, tons | 745,940 |
| Average content, per cent | 1.631 |
| Copper from all sources, pounds | 15,801,568 |
| Cost, cents per pound | 10.579 |
| Average price received, cents per pound | 24.598 |
| Profit | \$2,205,578 |
| Dividend paid | 789,302 |
| Net surplus | \$1,416,246 |

CALIFORNIA

AMADOR COUNTY

(Special Correspondence.)—An important mining deal, so far as this county is concerned, has just been closed here, the McIntire, Boyson, North Star, and South Keystone properties having been taken over by a strong company headed by W. Virges and A. Huth of Tacoma, Washington. With the exception of a 1000-ft. shaft on the North Star claim almost no development has been done on these mines, but the ground has favorable indications. The area adjoins the Keystone mine on the south, and is on what is known as the 'Amador Trail' between Sutter Creek and Amador City. As soon as the North Star shaft can be unwatered and put into proper condition, the intention is to start driving from the 600-ft. level to cut the South Keystone orebodies. The necessary machinery is to be installed without delay. The North Star shaft is well situated for quickly exploring the value of the combined properties. Charles H. Colpe is manager. The strenuous efforts of John A. McIntire of Sacramento for many years are chiefly responsible for the consolidation of these claims and interesting capital in their development. He was the owner of the McIntire claim, and is well versed in Mother Lode conditions. The opening of this ground may mean as much for the county as does the work contemplated at the old Eureka. Sutter Creek, May 15.

At the Eureka mine at Sutter Creek a quantity of machinery and supplies are arriving. A small hoisting plant, to handle the sinking-pumps, is being erected. The superintendent, Walter Beam, is now living at the mine.

SAN DIEGO COUNTY

As the Panama-California Exposition is to remain open until the end of 1916, and as a number of exhibits have been

transferred from the late Exposition at San Francisco, the Palace of Mines at San Diego is filling up and attracting more attention. The Nevada Mine Operators' Association is to arrange a display of minerals, also several California counties, and a good collection from Oatman, Arizona. The building is in charge of J. E. Babcock and A. E. Smith.

INYO COUNTY

According to the *Owens Valley Herald* of Bishop, that place "is the centre of the biggest tungsten field in the United States." Six miles west of Bishop a new townsite is being laid out. Near-by the Tungsten Mines Co. and the Standard Tungsten Co., managed by L. L. Stevens and A. J. Clark, respectively, have developed extensive deposits of scheelite. The Tungsten is erecting a 75-ton and the Standard a 300-ton mill, the latter the largest in the country for tungsten ore. Other discoveries of tungsten are reported.

SACRAMENTO COUNTY

The Natomas Company of California has sold in reclamation district 1000, three miles north of Sacramento, 1114 acres of land at \$300 per acre to M. J. and A. J. Machado, E. A. and A. R. Meister, and E. J. O'Brien of Sacramento, and D. H. Moulton of Chico.

SHASTA COUNTY

The electric smelter of the Noble company at Heroult is producing 12 tons of ferro-manganese per day from one furnace. Another furnace will soon be charged. About 125 men are employed at the property.

Guggenheim interests have bonded two tracts of land near Redding, about 1000 acres, and is prospecting it by drilling in charge of E. A. Wiltsee. The El Oro Dredging Co. has bonded 160 acres on Clear creek.

TRINITY COUNTY

On account of water troubles in its mine, the Globe Consolidated has temporarily closed its mine and mill. Hydraulic mining continues in full force at Lagrange and Union Hill.

TUOLUMNE COUNTY

(Special Correspondence.)—The long adit being driven by the Springfield Tunnel & Development Co. to open the gravel-channels near Columbia, has reached what is known as the Buchanan channel, where rich gravel has been found. It will be several days before the centre of the channel is exposed. On the rim the gravel is about 4 ft. thick. Other ancient channels whose richness was proved by sinking

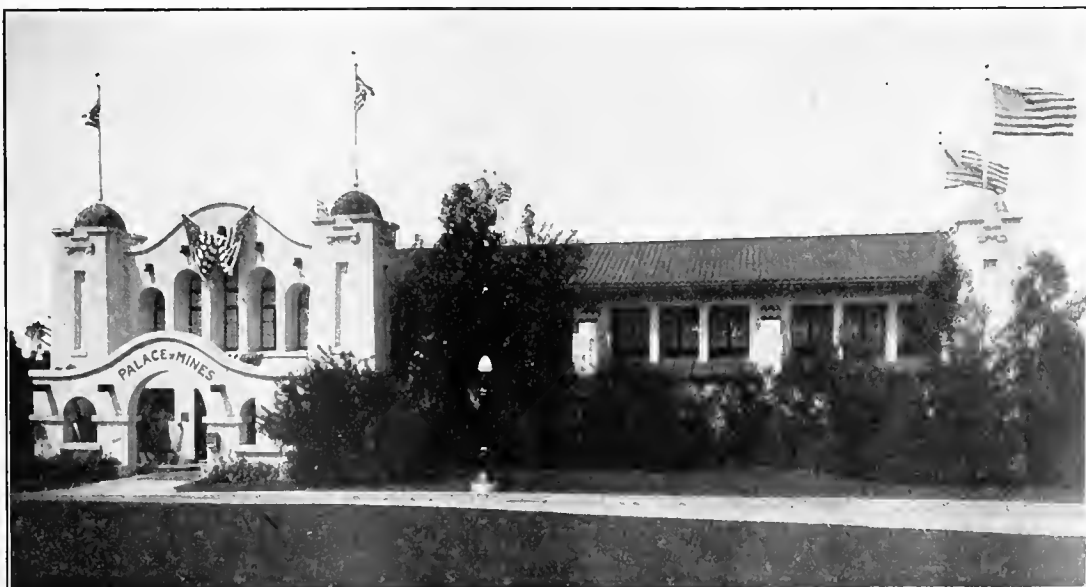

MINES BUILDING AT SAN DIEGO.

plants will be opened from time to time as the work of divining the adit progresses. The position of general superintendent made vacant a few days ago by the death of A. J. Horner has passed to George Cadenatore, for several years in the company's employ.

Although the Dutch-Sweeney plant is one of the best and most complete in the county, improvements are still being made. The two Hardacre central mills recently installed are giving satisfaction. Of the discoveries made in the mine since the present company acquired the property, probably the most promising is on the 1890-ft. level, where a large body of fine ore is being opened.

Senora, May 6.

YUBA COUNTY

Title to 1619 acres of dredging ground in the Hammondon district is in dispute between the Yuba Investment Co. and the Yuba Consolidated Goldfields Co. in the Superior Court at Marysville. A large array of legal and mining talent is represented. Drill-holes yield from 4 to 30c. gold per cubic yard. For dredging purposes, J. K. O'Brien, the original owner of the land, considers it worth \$15,000 per acre, but for agriculture only \$30,000 for the lot.

COLORADO

CLEAR CREEK COUNTY

(Special Correspondence) — With silver rising resumption of work is promised at an early date on a number of old properties that have been dormant for years. Georgetown and Silver Plume are experiencing greater prosperity than since 1893. Every habitable house in both towns is at present occupied and sleeping accommodations are scarce. Several buildings at Georgetown are being remodeled and made into rooming-houses. It is estimated that no less than 100 miners have been brought here during the last month to assist in mine development.

Idaho Springs, May 8.

GILPIN COUNTY

There is a scarcity of machine-men and single men at the mines of this county.

OURAY COUNTY

During March the Camp Bird mine made a profit of \$13,700 from 1947 tons of ore.

TETTER COUNTY (CRIPPLE CREEK)

The prostrated sale of the properties of the U. S. R. & R. Co. failed to receive a bid, with a minimum of \$200,000. The Court has ordered at the next sale that the cash deposit of \$7,000 remain as before, but withdraws any minimum.

Senator Pentose, of Colorado Springs, a bondholder of the U. S. R. & R. Co. since bought the properties for \$100,000.

THE SAN JUAN REGION

Mining men are getting ready for a prosperous season in the San Juan mining centers. Prospecting, developing of producing mines, building mills, and constructing roads and trails will soon be on in full operation. The Durango smelter is already receiving a greatly increased quantity of ore from Silverton, Rico, Telluride, and other producing districts. Twenty-one empty freight cars were taken to Silverton one day last week to bring down ore and concentrate, where for several years past hardly that many were taken in several days. The snow is beginning to go off more rapidly, and prospectors are eagerly waiting to begin the season's campaign. Shipments from Silverton in April totaled 142 carloads, an increase of 10 over March. At the Sunnyside mine wages have been raised from 25 to 50c. per shift, the highest being \$4.50.

GEORGIA

In Lumpkin and adjoining counties are extensive deposits of feldspar, said to be sufficient to yield enough potash to

fertilize all the crops this State can raise for several years. Plenty of water power is available for grinding. Capital is necessary for exploitation.

MICHIGAN

THE COPPER COUNTY

(Special Correspondence) — Continued improvement is reported from the White Pine ore, the average in April being 27 lb. refined copper per ton. The tailing loss is 11 lb., but this is being reduced. Costs are under 10c. per lb.

At the White Pine Extension the shaft is to be sunk 250 ft. before opening out. Shale found in the shaft confirms drill cores.

Houghton, May 5.

MISSOURI

JASPER COUNTY

A 100-ton mill is proposed for the Barrett land in the Porto Rico district by a new company, in which A. Gibson of Joplin is largely interested.

The ore market at Joplin was a trifle stronger last week, when average prices for blende, calamine, and lead were \$97, \$71, and \$96 per ton respectively. The output of the Missouri-Kansas-Oklahoma region was 8054 tons blende, 763 tons calamine, and 1033 tons lead, with a total value of \$942,400.

ST. FRANCIS COUNTY

Wages in the lead region have been advanced 10%, making a total increase of 30% in 15 months. Over 7000 men benefit.

On May 9 about 2000 underground shovelers at the Federal and Doe Run mines downed tools, demanding \$3.50 a shift and that only 20 mine-cars be filled in 8 hours.

MONTANA

FERTIS COUNTY

During April the Barnes-King company produced 3592 tons of \$6.27 and 2933 tons of \$4.09 ore, a total yield of \$31,900.

GRAND COUNTY

In the Dunkelberg district, Makeever Bros. of New York have been doing considerable diamond-drilling with interesting results at their Wasa, Hollander, and Dunkelberg properties.

LEWIS AND CLARK COUNTY

Rich copper-silver ore has been discovered in the Wolf Creek district, 25 miles north of Helena. The lode is in limestone near a diorite contact. A little south of this Hudson Brothers and Bissoinette have opened similar ore.

At the Porphyry Dyke mine in the Rimini district the Anaconda company is employing between 40 and 50 men. W. A. Clark, Jr., and the Barnes-King company are interested in other properties.

SILVERBOW COUNTY

With W. L. Creden in charge the old Ophir mine, in the south-west part of Butte, is being re-opened. The mine and mill equipment only require a little overhauling. The shaft is 1665 ft. deep, and when unwatered will be sunk to 2500 ft.

On April 26 the Boston & Corbin mill started working two shifts, producing 6.7% concentrate. Some good ore is extracted from the 900-ft. level.

NEVADA

HUMBOLDT COUNTY

In the north drift at 1600 ft. in the Seven Troughs Coalition 39 in. of \$1481 ore has been opened. Work on the south is also encouraging.

LINCOLN COUNTY

In April the Prince Consolidated at Pioche shipped 14,072 tons of ore. The 200-ton flotation plant for the tailing at Bullionville has been ordered.

WHITE PINE COUNTY

(Special Correspondence.)—A shipment of crude ore, which contains 78% tungstic acid, has just been brought in from the camp of Big Wash, on the east side of the Snake range, by W. F. Chapman, connected with Atkins, Kroil & Co. This property is owned by Mr. Chapman and W. Taylor, and this shipment is one of a series of the highest grade ever made from crude ore without concentration. The ore is crystallized scheelite, and contains some rare and beautiful specimens, the crystals being translucent and having the general appearance of calcite crystals. Work has been in progress on the property throughout the winter, and a number of other shipments of the same grade have been made, all of them averaging over 78%. The ore occurs as irregular deposits in a belt of metamorphosed limestone 200 ft. wide, and operations might be classed as pocket-mining. From one of these pockets a single chunk of this high-grade ore was taken, weighing 320 lb. Among the specimens Mr. Chapman brought with him on this trip to Ely was a large geode, 8 to 10 in. diam., the interior of which is lined with pure crystals of scheelite. He considers that the east side of the Snake range will prove to be as important a producer of tungsten ores as the west side, on which are the camps of Tungstania, Scheelite, Tungsten, and Minerva. On the east side the districts that are now gaining prominence include Big Wash, Beaver creek, Snake creek, Lexington, Baker, Fowler, and Garrison.

Ely, May 10.

The Nevada Consolidated Copper Co. reports as follows for the first quarter of 1916:

| | |
|---|-------------|
| Ore treated, tons | \$27,880 |
| Average content, per cent | 1.66 |
| Metal output, pounds | 19,160,274 |
| Average price received, cents per pound | 23.478 |
| Cost, cents per pound | 9.65 |
| Profits | \$2,781,811 |
| Dividends (2) | 999,728 |
| Net balance to surplus | \$1,556,225 |

IDAHO

SHOSHONE COUNTY (COEUR D'ALENE)

Owing to the high wages in the Coeur d'Alene the banks at Kellogg and Wardner have greater deposits than ever before. On account of the new smelter a land boom has hit Kellogg.

To improve the Y. M. C. A. play-grounds at Kellogg the Bunker Hill & Sullivan company has donated \$1500.

The coming season promises to record unusual activity among the mines of the Mullan district, many of which have been dormant for several years.

The following figures are from statements made to the county assessor regarding results in 1915:

| Company | Ore mined tons | Gross value | Cost of extraction | Freight and treatment | Improvements and repairs | Net profits |
|------------------------|----------------|---------------------|--------------------|-----------------------|--------------------------|--------------------|
| Bunker Hill & Sullivan | 454,205 | \$1,177,819 | \$1,119,584 | \$1,793,275 | \$136,746 | \$1,145,855 |
| Hecla | 146,675 | 1,422,579 | 388,340 | 393,588 | 46,970 | 593,680 |
| Success | *21,867 | 1,255,802 | †356,866 | | | 898,936 |
| Caledonia | 42,628 | 1,246,859 | 107,575 | 378,960 | | 761,797 |
| Tamarack & Custer | *26,147 | 1,238,755 | 449,041 | 439,157 | 3,760 | 346,796 |
| Sierra Nevada | 15,159 | 110,328 | 63,974 | | | 40,354 |
| Green Hill-Cleveland | 28,126 | 1,643,799 | 658,941 | 415,228 | 8,592 | 197,864 |
| Ontario | 81,298 | 689,392 | 265,728 | 199,910 | | 223,725 |
| Interstate-Callahan | *113,795 | 4,540,672 | 849,241 | 643,863 | 126,080 | 2,921,488 |
| Federal (Wardner) | 136,180 | 620,682 | 369,083 | 204,229 | | 17,370 |
| Federal (Mullan) | 250,260 | 1,947,607 | 588,899 | 741,996 | 35,151 | 571,560 |
| Federal (Mace) | 52,958 | 332,791 | 205,296 | 88,206 | | 39,295 |
| Hunter | 118,764 | 614,590 | 368,613 | 77,992 | 136,323 | 31,662 |
| Hercules | *49,441 | 3,090,175 | 950,852 | 986,219 | 57,081 | 1,096,019 |
| Total | | \$22,931,853 | \$6,752,033 | \$6,362,654 | \$550,707 | \$9,222,100 |

*Shipping product. †Includes freight, treatment, and betterments. ‡Includes \$17,642 royalties.

NEW MEXICO

GRANT COUNTY

The Chino Copper Co. reports as follows for the first quarter of 1916:

| | |
|---|-------------|
| Overburden removed, cubic yards | 746,209 |
| Ore treated, tons | 714,400 |
| Average copper-content, per cent | 1.8719 |
| Recovery, per cent | 60.82 |
| Metal output, pounds | 16,267,450 |
| Price received, cents per pound | 26.566 |
| Cost, cents per pound | 8.95 |
| Profit | \$2,746,987 |
| Dividends paid (\$1.25 per share) | 1,987,475 |
| Surplus remaining | 1,659,512 |

The copper yield was less than in the preceding term.

TEXAS

EL PASO COUNTY

At the El Paso smelter of the A. S. & R. Co. there are 328 cars of ore on the tracks awaiting discharge, therefore a temporary embargo has been placed on the quantity to be sent by ore producers. Two more converters are being installed, but delivery of parts is slow. There has been trouble in securing the proper magnesite brick for lining the converters.

UTAH

IRON COUNTY

Advice from Cedar City states that east of Parowan and Paragonia extensive deposits of high-grade potash have been discovered, occurring like those in Germany.

JUAB COUNTY

Tintic mines shipped a total of 222 cars of ore during the week ended May 13, the largest for many years. The principal producers were the Chief Consolidated, Dragon, Iron Blossom, Centennial Eureka, Mammoth, Eagle & Blue Bell, and Gemini. All employees in the district have received another raise of 25c. per shift. Miners now get \$4 per day.

SALT LAKE COUNTY

The Alta Tunnel & Transportation Co.'s adit in the Big Cottonwood is in over 2000 ft. in black limestone formation. A heavy flow of water is reported. The adit is to be 4900 ft. long to connect the two Cottonwoods. The general manager, F. V. Bodfish, said the following about this project:

"The Little Cottonwood district has heretofore been a high-grade area, that is, nothing but this class of ore could be shipped at a profit. This has been due to the cost of transportation. There are enormous tonnages of \$10 ore in the dis-

district. The Alta tunnel will open these properties at from 800 to 1100 ft. from the surface. The ore can then be dropped into the cars and a transportation company has been organized to haul it to Murray. I am informed that caterpillar tractors will be used and the engineers assure me that the ore can be laid down at Murray at a cost far below the present charge of taking the ore from the district by way of the Little Cottonwood district. The tunnel will also afford better drainage facilities for the various properties, as it will cut during its course all of the principal fissures that traverse the district."

Ten inches of high grade lead-silver ore has been cut in a raise 28 ft. above the adit, and 800 ft. from the portal.

The Cardiff company is paying 25c. per share on June 1. In the mine the rich shoot has been opened for 200 ft. Three shutts are employed. Small shipments are made at present.

At the Baker mine, near the Maxfield, the adit is in over 800 ft., and recently cut two promising fissures.

The suit of H. J. Wheeler and other land-owners in the vicinity of Tooele v. the A. S. & R. Co., for alleged damage to their properties by smelter-fume, is being heard at Salt Lake City.

The Utah Copper Co. reports as follows for the first quarter of 1916:

| | |
|---------------------------------|-------------|
| Overburden removed, cubic yards | 1,379,295 |
| Ore treated, tons | 1,984,600 |
| Average content, per cent | 1.1333 |
| Recovery, per cent | 64.27 |
| Metal output, pounds | 36,561,533 |
| Price received, cents per pound | 26.131 |
| Cost, cents per pound | 7.19 |
| Profit | \$6,186,414 |
| Dividends paid | 4,061,225 |
| Surplus, including other income | \$3,018,605 |

Winter affected the metal output considerably.

SUMMIT COUNTY

The output of the Park City district in April was 6910 tons of ore and concentrate. The Silver King Coalition contributed 2714 tons; Silver King Consolidated, 107 tons; Judge Mining & Smelting Co. (late Daly-Judge), 2252 tons; and Ontario, 483 tons.

MEXICO

The mining outlook in Mexico, according to F. M. Estes, with the A. S. & R. Co. at Spokane, Washington, and who was five years in Mexico, especially in the northern part, is dismal. After five years of continuous revolutions, Americans long resident there have given up even guessing about the outcome. When he left Sonora intervention seemed inevitable, but it now looks as if there might be co-operation with the Constitutional government. The Americans in Mexico would have preferred intervention at the start of the trouble, and they feel that the situation brought about by the border bandits should have been cleaned up four years ago.

HIDALGO

The profit in treating 25,904 tons of ore at Santa Gertrudis in March was \$106,000.

JALISCO

(Special Correspondence.)—The mining companies shipping bullion from the port of Manzanillo on the west coast, to San Francisco, California, have been notified by telegraph by the Agente Aduanal of Manzanillo, that no bullion can be exported without special permission from the Secretary of Hacienda. This advice was received April 29, and so far no reply has been received to telegrams asking for that special permission. English speaking people in Guadalajara are united in their praise of the article on Mexico that appears on the first page of *The Saturday Evening Post* of April 29. Every bit of it is correct and to the point.

Guadalajara, May 1.

PERSONAL

Note: The Editor invites members of the profession to send him particulars of their local appointments. This information is of unquestioned interest to our readers.

H. J. SHAW has gone to Siskiyou county.

H. P. GORDON is now at Atolla, California.

FRED S. RICHARD is again at Lovelock, Nevada.

CONY C. BRAYTON has gone to Salt Lake City and Butte.

MAURICE D. LAHAY, of Seattle, was here during the week.

P. D. BIRLI is at the Old York mine near Congress, Arizona.

A. W. NEWBURY sails from New York for South America on May 27.

GEORGE RANDOLPH is manager of the Adanae silver mine at Cobalt.

S. F. SHAW is visiting mines in the districts adjacent to Salt Lake City.

WILLARD MALLEBY has returned from British Columbia to San Francisco.

GEORGE O. BRADLEY, of Bradley, Bruff & Labarthe, was at Miami last week.

A. E. DRUCKER sailed for London from New York on the *Noordam* on May 11.

FRANK ODDFIELD has returned to Los Angeles from Cinco Minas, Jalisco, Mexico.

FRANK M. ESTES, late of Sonora, Mexico, is resident engineer for the A. S. & R. Co. at Spokane.

JOHN E. S. CLARK, of Riverside, California, was married recently to Miss Ellen J. V. Preterre.

E. W. MILLS and J. F. MANNING will be arriving in San Francisco from Korea late in August.

BERT E. CARSWRIGHT, formerly president of the Temiskaming Mining Co., is president of the Adanae Silver Mines, Limited.

GUY C. RIBBELL, until recently at the East Helena smelter, has received an appointment with the Associated Smelters in Australia.

T. R. HUNT has resigned the management of the Syndicate Mining Co., Arroyo, P. I., to be succeeded by JOSEPH J. SHAW. Mr. Hunt's present address is 2941 Denver Place, Denver.

JAMES T. KEMP, son of Professor Kemp of Columbia, is one of the three graduates from the Columbia School of Mines to receive the Illig medal for exceptional proficiency; the other two are JOHN P. HUBBELL and JOSEPH KUCIAR.

Obituary

JOHN WINTHROP CHANDLER, superintendent of the West End and other mining properties at Tonopah, died on May 7 in San Francisco.

FRANK G. JANNEY, well known through his connection with the Utah Copper Co., advisory metallurgist to the group of copper and zinc companies controlled by D. C. Jackling, and one of the leading specialists in flotation, died at Los Angeles on May 12, after an operation for appendicitis, at the age of 50 years. He leaves a wife and family, two sons being already honorably prominent in Western metallurgy.

The CHEMISTS' CLUB of New York announces the establishment of a scholarship fund, the income from which, approximately \$500 a year, is to be devoted to assisting financially deserving young men to obtain education in the field of industrial chemistry or chemical engineering. This scholarship has been endowed by Victor G. Bloede, a prominent manufacturing chemist of Baltimore. Its benefits will be open to properly qualified applicants without restriction as to residence, and may be effective at any institution in the United States, which may be designated or approved by the Club.

THE METAL MARKET

METAL PRICES

San Francisco, May 16.

| | |
|--|-----------|
| Antimony, cents per pound | 39.50 |
| Electrolytic copper, cents per pound | 31 |
| Pig lead, cents per pound | 7.75-8.75 |
| Platinum: soft metal, per ounce | \$80 |
| Platinum: hard metal, 10% iridium, per ounce | \$84 |
| Quicksilver: per flask of 75 lb. | \$90 |
| Spelter, cents per pound | 22 |
| Tin, cents per pound | 50 |
| Zinc-dust, cents per pound | 30 |

ORE PRICES

San Francisco, May 16.

| | |
|---|--------|
| Antimony: 50% product per unit (1% or 20 lb.) | \$2.25 |
| Chrome: 40% and over, f.o.b. cars California, per ton | 12.50 |
| Manganese: 50% metal, 8% silica, per ton | 12.00 |
| Tungsten: 60% WO ₃ , per unit | 50.00 |

At Boulder, Colorado, tungsten producers expect the price to remain steady at \$60.

EASTERN METAL MARKET

(By wire from New York.)

May 16.—Copper futures continue strong; lead is stronger but uncertain; spelter is dull and weak.

COPPER

Prices of electrolytic in New York, in cents per pound.

| Date | Average week ending |
|-------------|---------------------|
| May 10 | 29.50 |
| " 11 | 29.50 |
| " 12 | 29.50 |
| " 13 | 29.50 |
| " 14 Sunday | 29.50 |
| " 15 | 29.50 |
| " 16 | 29.50 |

Monthly averages.

| 1914. | 1915. | 1916. | 1914. | 1915. | 1916. |
|-------|-------|-------|-------|-------|-------|
| Jan. | 14.21 | 13.60 | 24.30 | July | 13.26 |
| Feb. | 14.46 | 14.38 | 26.62 | Aug. | 12.34 |
| Mch. | 14.11 | 14.80 | 26.65 | Sept. | 12.02 |
| Apr. | 14.19 | 16.64 | 28.02 | Oct. | 11.10 |
| May | 13.97 | 18.71 | 28.75 | Nov. | 11.75 |
| June | 13.60 | 19.75 | 29.50 | Dec. | 12.75 |

On May 9 the steamer 'F. D. Underwood' left Houghton, Michigan, with 3500 tons of copper, valued at \$2,100,000, the most valuable ever sent down the Lakes. Copper Range Co. is paying \$6.40 per share. Cerro de Pasco is paying \$1 on June 1. Braden produced 4,166,000 lb. in April, a decrease of 1,240,000 lb. Chile Copper is treating 1.75% ore, the monthly output being 5,000,000 pounds.

SILVER

Below are given the average New York quotations, in cents per ounce, of fine silver.

| Date | Average week ending |
|-------------|---------------------|
| May 10 | 76.25 |
| " 11 | 76.50 |
| " 12 | 77.25 |
| " 13 | 77.12 |
| " 14 Sunday | 77.12 |
| " 15 | 75.50 |
| " 16 | 75.75 |

Monthly averages.

| 1914. | 1915. | 1916. | 1914. | 1915. | 1916. |
|-------|-------|-------|-------|-------|-------|
| Jan. | 57.58 | 48.85 | 56.76 | July | 54.90 |
| Feb. | 57.53 | 48.45 | 56.74 | Aug. | 54.35 |
| Mch. | 58.01 | 50.61 | 57.89 | Sept. | 53.75 |
| Apr. | 58.52 | 50.25 | 64.37 | Oct. | 51.12 |
| May | 58.21 | 49.87 | 64.37 | Nov. | 49.12 |
| June | 56.43 | 49.03 | 64.37 | Dec. | 49.27 |

Profit taking probably caused the recent set-back in silver. If the large stocks of metal held by producers are judiciously sold the market should not be flooded, and so affect prices. Heavy buying for Russia is a recent stimulating factor.

The absence of sales from Mexico, the paucity of supplies from the United States, the ready absorption by the Indian Bazaars of sales of silver direct from China, and the almost complete realization of China holdings in London, accounts for the difficulty of feeding the present demand, even though buyers act with discretion, recognizing that pressure must inevitably force up the price, according to Samuel Montagu & Co. of London. The demand of Indian Bazaars has been met direct from China, and they have therefore not figured much as buyers in the London market. The bulk of enquiry recently has been for coinage for the British Empire and elsewhere, as it has

been during preceding weeks. The reserve of silver coin in India fell 139 lacs (over 5,000,000 oz.) between the 7th and the 15th of April. Apparently this does not take into account certain purchases, believed to be on account of the Indian government. It was rumored in the Indian Bazaars that the two large shipments of silver from China to India (6,000,000 oz.) were to be coined into Egyptian 'piastres' at the mints of the Indian Government. The 'Temps' states that the French mint, which in ordinary times coined annually 8,000,000 to 10,000,000 francs in silver, will, this year, coin more than 80,000,000 francs, and that purchases of silver are probable to an extent of 400,000 kg. (12,800,000 oz.) at a cost of more than 40,000,000 francs. The issue of silver coin in England in 1914, £6,092,569, greatly exceeded the issue of any previous year, and was more than 6½ times the average of the previous 10 years. Stocks in London at the end of April were only worth £500,000, say 3,750,000 ounces.

LEAD

Lead is quoted in cents per pound, New York delivery.

| Date | Average week ending |
|-------------|---------------------|
| May 10 | 7.37 |
| " 11 | 7.37 |
| " 12 | 7.37 |
| " 13 | 7.50 |
| " 14 Sunday | 7.50 |
| " 15 | 7.50 |
| " 16 | 7.50 |

Monthly averages.

| 1914. | 1915. | 1916. | 1914. | 1915. | 1916. |
|-------|-------|-------|-------|-------|-------|
| Jan. | 4.11 | 3.73 | 5.95 | July | 3.80 |
| Feb. | 4.02 | 3.83 | 6.23 | Aug. | 3.86 |
| Mch. | 3.94 | 4.04 | 7.26 | Sept. | 3.82 |
| Apr. | 3.86 | 4.21 | 7.70 | Oct. | 3.60 |
| May | 3.90 | 4.24 | 7.70 | Nov. | 3.68 |
| June | 3.90 | 5.75 | 7.70 | Dec. | 3.80 |

QUICKSILVER

The primary market for quicksilver is San Francisco, California being the largest producer. The price is fixed in the open market, according to quantity. Prices, in dollars per flask of 75 pounds:

| Date | Week ending |
|---------|-------------|
| Apr. 18 | 115 |
| " 25 | 125 |
| May 2 | 115 |
| " 9 | 100 |
| " 16 | 90 |

Monthly averages.

| 1914. | 1915. | 1916. | 1914. | 1915. | 1916. |
|-------|-------|-------|--------|-------|-------|
| Jan. | 39.25 | 51.90 | 222.00 | July | 37.50 |
| Feb. | 39.00 | 60.00 | 295.00 | Aug. | 30.00 |
| Mch. | 39.00 | 78.00 | 219.00 | Sept. | 76.25 |
| Apr. | 38.90 | 77.50 | 141.60 | Oct. | 53.00 |
| May | 39.00 | 75.00 | 141.60 | Nov. | 55.00 |
| June | 38.60 | 90.00 | 141.60 | Dec. | 53.10 |

Every transaction in quicksilver is subject to bargaining at present, there being nothing definite.

New Idria has increased its capacity to 800 flasks per month.

ZINC

Zinc is quoted as spelter, standard Western brands, New York delivery, in cents per pound.

| Date | Average week ending |
|-------------|---------------------|
| May 10 | 17.00 |
| " 11 | 16.75 |
| " 12 | 16.50 |
| " 13 | 16.25 |
| " 14 Sunday | 16.25 |
| " 15 | 16.00 |
| " 16 | 15.62 |

Monthly averages.

| 1914. | 1915. | 1916. | 1914. | 1915. | 1916. |
|-------|-------|-------|-------|-------|-------|
| Jan. | 5.14 | 6.30 | 18.21 | July | 4.75 |
| Feb. | 5.22 | 9.05 | 19.99 | Aug. | 4.75 |
| Mch. | 5.12 | 8.40 | 18.40 | Sept. | 5.16 |
| Apr. | 4.98 | 9.78 | 18.62 | Oct. | 4.75 |
| May | 4.91 | 17.03 | 18.62 | Nov. | 5.01 |
| June | 4.84 | 22.20 | 18.62 | Dec. | 5.40 |

The American Zinc, Lead & Smelting Co. is to absorb the Granby Mining & Smelting Co.'s extensive mines, mills, and smelters in Missouri, Kansas, and Illinois.

TIN

Prices in New York, in cents per pound.

| 1914. | 1915. | 1916. | 1914. | 1915. | 1916. |
|-------|-------|-------|-------|-------|-------|
| Jan. | 37.85 | 34.40 | 41.76 | July | 31.60 |
| Feb. | 39.76 | 37.23 | 42.60 | Aug. | 50.20 |
| Mch. | 38.10 | 48.76 | 50.50 | Sept. | 33.10 |
| Apr. | 36.10 | 48.25 | 51.19 | Oct. | 30.40 |
| May | 33.29 | 39.28 | 51.19 | Nov. | 33.51 |
| June | 30.72 | 40.26 | 51.19 | Dec. | 33.60 |

Eastern Metal Market

New York, May 10

Dullness characterizes the entire non-ferrous metal market. So uninteresting has it become that it is almost dead in all departments, except perhaps in copper. This metal is stronger and firmer than the others and prices have been maintained unchanged. Probably the general stagnation is due as much as anything to uncertainty in European and Mexican affairs. Stocks of most metals in the hands of consumers are probably plentiful, with scattered exceptions. In all metals but lead and copper, weakness has developed to an extent sufficient to depress prices. In no market do any features of significance stand out. A brief summary would be about as follows: Copper is dull but firm, lead, very dull and unchanged; tin, quiet and lower, zinc, inactive with lower prices; antimony, plentiful and cheaper, and aluminum stationary.

The strike situation, which was menacing even to the steel trade last week, is now much better, especially in the Pittsburgh district. The feature of the week in the steel circles has been the reported placing of about 150,000 tons of shell-steel in the shape of blooms and rounds. Negotiations for as much more, with 50,000 tons for Russia and Italy, are also conspicuous. As high as \$80 to \$85 per ton is reported paid for blooms, and 3.50 to 3.75c. per lb. for rounds.

COPPER

Rumors of large orders from foreign sources about to be placed have again come to the surface, but so far are not confirmed. In some quarters they are regarded as only talk or efforts to cause activity. Prices have remained stationary and electrolytic copper for May delivery can be secured at 39.50c., though this quotation is nominal. For far future it is quoted at 28.75c. from September on. Lake copper for the same future delivery is about 29 to 29.50c. In general, however, dullness prevails, though the underlying tone is strong. Contradictory reports prevail, rendering a clear view of the actual conditions difficult, because some sellers claim that there is a good demand for prompt metal, while others affirm the opposite. It is reported, however, that such offers in some quarters have been unavailing. The only business actually done has been a fair movement in arsenical lake copper. The fact that brass rods and disks are easier, and that the inquiries for rods are fewer, might indicate a slackening in the demand for munitions. The rather extended advance in the London market for electrolytic copper from £145 a week ago to £153 19s. yesterday shows emphatically how futile have been the efforts of the Government to keep the price at £100 or less.

ZINC

Dullness and weakness are prevailing factors, and as a consequence quotations have declined to 17c., New York, for prompt delivery, and to 16.75c., St. Louis. June zinc can probably be obtained at about 16.25 to 16.50c., with July at about 15.75c. and last quarter at around 13.25c., all St. Louis. There has been a slight revival in demand in the last day or two and the tendency is toward a firmer tone. There seems to be a noticeable lack of demand from the brass interests, which is more noteworthy because they are understood to have contracted for copper for the remainder of the year. Galvanizers come into the market only now and then, but they buy but little or only what is absolutely necessary. Sheet zinc is quoted at 25.50c. base. Exports to May 10 were 1937 tons.

LEAD

The decline, strongly in evidence recently, has been checked, but the market is lifeless though fairly steady. The quotations of both the A. S. & R. Co. and the independents are the same,

7.50c. New York, and 7.37½c., St. Louis. In the St. Louis market a tendency to weakness has been suspected, but nothing has developed beyond the sale of 100 tons at 7.32½c. last week. As low a bid as 7.25c. is not considered safe unless the buyer is ready to make good. Some consumers are evidently reduced to a minimum as to stocks, while others are well supplied and ready to dispose of some. Any buying of consequence would immediately strengthen the situation. Sellers in general are restive, but unwilling to enter any competitive price reduction. Lead exports to date were 397 tons.

TIN

The week has been devoid of interest or much activity. Except on Friday of last week dullness has controlled the market. On that day there appeared a strong demand for futures, and 200 to 300 tons was reported sold. Consumers are supposed to be fairly well covered in their supplies, and are consequently disinclined to make any purchases. Spot tin was 49.75c., New York, yesterday, a decline from 51.50c. a week ago. Lack of demand is the controlling feature, with arrivals at 1020 tons to date and 4000 tons reported afloat.

ANTIMONY

A distinct weakness has appeared because of large arrivals and a decided falling-off in demand. Chinese and Japanese grades, spot deliveries, can now be obtained for 35c., duty paid.

ALUMINUM

Heavy buying by Russia is reported, but prices are unchanged at 58 to 60c. for virgin aluminum, No. 1.

ORES

Antimony: The ore is easier, with prompt business done at \$2.50 per unit, and forward sales at \$2.50.

Tungsten: The present situation is rather extraordinary. About a month ago price was a minor consideration. Lately, however, arrivals from South America, together with a combined effort by buyers, have depressed the market and the purchasers will not make a price, every offer being met with the reply, "No interest." No business except in small lots is reported the past week. The nominal quotation therefore is \$60 for spot and \$50 for forward concentrates, with no sellers at the figures.

Copper Refining in the United States

The 19 copper refineries of the United States will have a combined annual capacity of 2,461,000,000 lb. upon the completion, within a few months, of additional equipment.

The capacities will be as follows, in pounds, according to the *Boston News Bureau*:

| A. S. & R. Co. | Refinery | Monthly | Annual |
|-------------------|------------------------|-------------|--------------------------|
| } | Baltimore | 40,000,000 | 81,000,000 1,008,000,000 |
| | Perth Amboy | 28,000,000 | |
| | Tacoma | 16,000,000 | |
| } | Anaconda: | | |
| | Raritan | 40,000,000 | 60,000,000 720,000,000 |
| | Great Falls (new) | 15,000,000 | |
| Great Falls (old) | 5,000,000 | | |
| | Nichols Copper Co. | 35,000,000 | 420,000,000 |
| | United States Smelting | 17,000,000 | 200,000,000 |
| | Balbach | 4,000,000 | 48,000,000 |
| | Calumet & Hecla | 5,400,000 | 65,000,000 |
| | Total | 205,400,000 | 2,461,000,000 |

COMPANY REPORTS

ANACONDA COPPER MINING CO.

During 1915 the capital of this great company was altered from 6,000,000 shares of \$25 each to 3,000,000 of \$50. For the sum of \$6,624,583 all the capital stock of the United Metals Selling Co. of Delaware was acquired. There was also bought from the Amalgamated Copper Co. 150,000 Inspiration and 30,800 Greene-Cananea shares, etc., costing \$4,769,900.

At the beginning of the past year operations at Butte, Montana, were on a reduced basis, but a great deal of overhauling was done in the meantime. By May work was at normal, and at the end of 1915 on a larger scale than ever.

Development in the mines totaled 35.31 miles, against 33.15 miles in 1914. Shaft-sinking aggregated 4980 ft. Results generally at depth were highly satisfactory. There was extracted 4,376,557 tons of ore, and 6783 tons of copper precipitate from mine-water.

The Washoe works at Anaconda treated 4,421,629 tons, and those at Great Falls 384,066 tons. Of this, 535,223 tons was from other companies. Metal production in the past three years was as follows:

| Metal | 1915 | 1914 | 1913 |
|----------------|-------------|-------------|-------------|
| Copper, pounds | 254,311,574 | 223,720,292 | 270,301,644 |
| Gold, ounces | 106,703 | 99,651 | 64,898 |
| Silver, ounces | 9,005,618 | 8,314,116 | 10,321,296 |

On the 1915 total, the Anaconda mines yielded 235,076,289 lb. copper, 106,703 oz. gold, and 8,064,986 oz. silver.

The coal mines in Montana and Wyoming produced a total of 678,731 tons, a good deal of which was sold. The lumber departments cut 86,645,962 ft. of timber, and purchased 29,110,829 ft. The balance on hand on January 1, 1916, was 94,495,273 ft. Other subsidiary departments did a good business, all showing a profit of \$687,454. The company did extensive exploration at the Potrerillos mines in Chile, and acquired further property at Butte and near Helena.

Financial results were as under:

| | 1915 | 1914 | 1913 |
|------------------------------------|--------------|--------------|--------------|
| Sales of metals | \$61,473,677 | \$36,745,559 | \$44,003,473 |
| Gross revenue, with metals on hand | 87,273,886 | 51,533,659 | 61,258,755 |
| Disbursements | 67,806,191 | 42,335,241 | 49,995,529 |
| Balance | \$19,467,695 | \$9,198,419 | \$11,283,226 |
| Income from investments | 112,922 | | |
| Interest | 984,233 | 408,831 | 40,271 |
| Depreciation | 1,900,578 | | |
| Profit | \$16,695,806 | \$8,789,587 | \$11,323,497 |
| Dividends | 9,325,000 | 9,077,500 | 12,997,500 |
| Surplus | 7,370,806 | *287,913 | *1,674,003 |

Profit and loss surplus..\$15,051,865 \$7,681,059 \$7,021,170
*Deficit.

Subsidiary corporations:

INTERNATIONAL SMELTING CO.

The plant at Tooele, Utah, treated 270,374 tons of copper ore, and 395,574 tons of lead ore, yielding 14,271,174 lb. copper, 113,002,657 lb. lead, 48,020 oz. gold, and 5,090,157 oz. silver. The plant at Miami, Arizona, reduced 70,304 tons of concentrates and 17,105 tons of ore, producing 51,769,669 lb. copper, 822 oz. gold, and 70,000 oz. silver. The works only commenced on May 21, 1915.

INTERNATIONAL LEAD REFINING CO.

This company treats lead bullion from Tooele at East Chicago. There was refined 55,376 tons of lead and 2266 tons of foreign ore, yielding 103,121,355 lb. of common and corroding

lead, 9,164,073 lb. antimonial lead, 18,136 oz. gold, and 4,031,610 oz. silver.

RARITAN COPPER WORKS

This company's refinery is at Perth Amboy, New Jersey, and treated for all companies 162,282 tons of copper bullion and 719,343 oz. of silver, giving 323,850,718 lb. copper, 174,408 oz. gold, and 16,025,993 oz. silver.

BUTTE, ANACONDA & PACIFIC RAILWAY Co.

This company's electric roads transported 6,506,525 tons of ore and freight and 230,684 passengers, for a gross revenue of \$1,627,476. The profit was \$480,029. The dividend of 6% amounted to \$150,000.

NIPISSING MINES CO.

The 1915 report of this great silver producer is of interest. The general manager, R. B. Watson, states that the period was one of uncertainty, both as to the price of silver and the cost of supplies; therefore production was not pushed beyond the tonnage necessary for dividends. The average price received in London for 4,097,391 oz. was 50.06c. per ounce. The

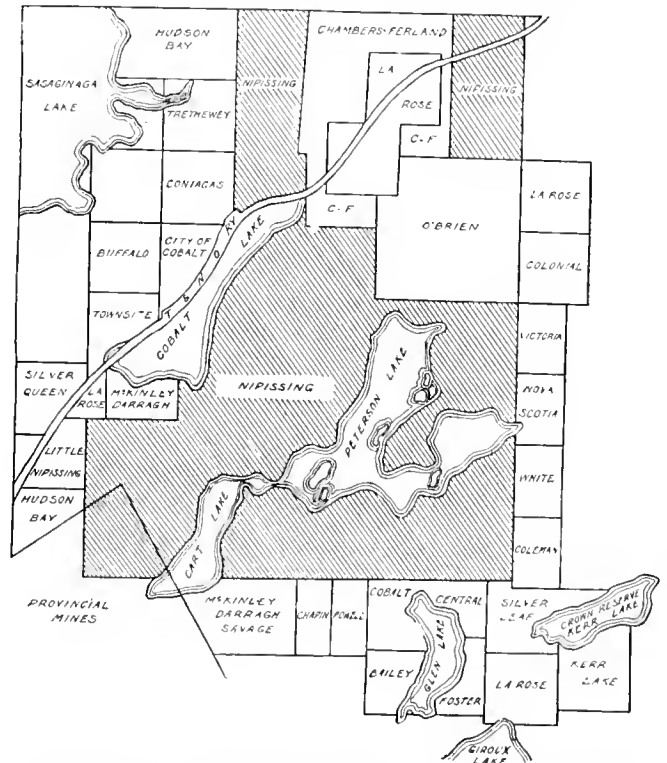

COBALT MINING DISTRICT, SHOWING PROPERTIES OF NIPISSING MINING CO., LTD.

cost of production was 19.06c. per ounce, a decrease of 0.74c. The mine has never shown ore reserves commensurate with its annual output, but its history during 12 years shows that development of new ore has kept pace with current production. Reserves are estimated as 2512 tons, assaying 1814 oz. per ton, and 180,236 tons of 24.2 oz. ore, making total contents 8,921,718 oz. Exploration of the Cobalt Lake fault revealed several rich shoots, the last one below 450 ft. A shaft, No. S1, is now being sunk to further prove the fault.

Surface prospecting by hydraulicicking did not disclose any veins of importance. Underground development totaled 10,496 ft., and 503 ft. of diamond-drilling.

The high-grade mill treated 921 tons of 2474-oz. ore from the Nipissing, and 553 tons of 2917-oz. ore from other mines. The low-grade plant treated 77,183 tons of 31.49-oz. ore with 87.52% recovery. Forty stamps averaged 6.57 tons per day each. The mill was closed three months through lack of power. The refinery produced 6,164,239 oz. silver. Cost of treating low-grade ore was \$3.913 per ton.

Total costs were reduced from \$11.60 to \$10.02 per ton of ore. The net revenue was \$1,141,128. Dividends amounted to \$1,200,000. The surplus is \$1,789,294, an increase of \$183,000. The output to date is 41,209,238 oz. silver.

TENNESSEE COPPER CO.

On ore yielding 26.83 lb. of copper per ton the operating cost of production at this property was reduced to 8.768c. per pound. The average price received for the year was 16.274c. per lb. on an output of 12,750,418 lb. of copper. Early in the year the War affected the manufacture of sulphuric acid, but after improvements were made to the plant, it was operated at full capacity. The output of acid was 210,666 tons, a slight increase over that of 1914. A large addition is being made to the plant. These notes are from the report of the president, Utley Wedge.

The manager, J. B. Risque, states that at the Burra Burra mine underground stoping has been discontinued, the output of ore coming from back stopes. Electric haulage is in use on No. 3 and 6 levels with satisfaction. Broken ore in stopes amounts to 250,000 tons, double that of a year ago. Diamond-drilling from No. 8 level showed continuity of the orebody in size and value for 400 ft. New machinery at the McPherson shaft is about complete. Some work is being done at the London and Polk County mines. M. A. Caine, superintendent of mines, reported that development totaled 1901 ft., and drilling 1042 ft. Ore reserves are estimated at 3,707,121 tons, a decrease of 303,240 tons. This is on account of the small amount of development, but does not include the reserve disclosed by the drill. There was extracted 511,940 tons of ore, at a cost of 93.633c. per ton.

The smelter reduced 635,630 tons of mixed material, using 28,472 tons of coke. Two Great Falls type basic converters are to replace the small ones now in use. The total cost per ton of ore in all departments was \$2.352.

The revenue from acid, copper, gold, and silver was \$3,862,159, of which \$1,298,037 was profit. Dividends absorbed \$600,000. The surplus at the end of the year was \$458,158, compared with \$50,767 at the beginning.

CONSOLIDATED ARIZONA SMELTING CO.

In his report for the past year, the general manager, G. M. Colvocoresses, covers operation of the smelter at Humboldt and the Blue Bell and De Soto mines:

In the Blue Bell development amounted to 2743 ft., opening 165,000 tons of new ore. The shaft was sunk 150 ft. to 1000 ft. depth. Reserves are estimated at 235,000 tons, averaging 3.5% copper and \$1.50 gold and silver. Prospects for a large increase in tonnage are good. A new hoist of 2000 ft. capacity was erected. The output was 82,171 tons, assaying 2.97% copper and \$1.40 in precious metals. This was an increase of 26,171 tons over that of 1914. The current year will also be greater. All mining charges were \$2.629 per ton. The De Soto mine was re-opened and fully equipped, producing 8360 tons of ore, containing 3.5% copper and \$1.50 gold and silver. The present output is at the rate of 40,000 tons per year. Reserves are 65,000 tons. Eight ore-shoots, none very large, are being mined. The future of this mine is also good.

The mill treated 81,544 tons of ore and tailing, averaging 2.83% copper, with 88.6% recovery of this metal, 62.5% of the gold, and 70.5% of the silver. There was produced 19,877 tons of 10.27% copper concentrate. Results were far in advance of those for 1914. The cost, including flotation royalty, was \$1.29 per ton, against \$1.82 in 1914, and \$2.09 in 1913. Only gravity concentration was employed in the latter year. The plant's capacity is to be increased from 240 to 500 tons daily.

The smelter reduced 61,034 tons material, yielding 5,762,974 lb. copper, 3092 oz. gold, and 81,647 oz. silver. Of the copper, 1,370,974 lb. was custom metal. The cost of reducing to matte was \$3.34 per ton, a reduction of \$2.21 per ton, and the cost of

converting matte to blister copper was \$0.0046 per pound of copper. A new 19 by 100-ft reverberatory was built, now working with the 19 by 60-ft. furnace. The enlarged smelter enables custom work to be profitably done. The total cost of producing copper was 13.327c. per pound, against 13.32c.

New construction amounted to \$155,272, at the mines and plants. The manager recommends that \$15,000 be spent each month on similar work as deemed expedient, eventually reducing the cost of production. The year's profit was \$194,943.

EAST BUTTE COPPER MINING CO.

A comparison of the last three years of this Montana company shows the following results:

| | 1915 | 1914 | 1913 |
|---------------------------------|--------------|-------------|-------------|
| Ore mined, tons. | 150,911 | 72,853 | 105,074 |
| Copper content, per cent. | 4.28 | 4.72 | 5.16 |
| Ore smelted (inc. custom), tons | 181,063 | 110,992 | 186,815 |
| Copper produced, pounds. | 12,542,058 | 9,175,579 | 14,401,108 |
| Gold produced, ounces. | 2,696 | 2,219 | 8,803 |
| Silver produced, ounces. | 318,124 | 242,347 | 506,897 |
| Gross income. | \$ 2,753,588 | \$1,455,454 | \$2,645,568 |
| Cost, cents per pound. | 11.85 | 11.11 | 11.04 |
| Price received, cents per pound | 19.31 | 13.57 | 15.08 |
| Profit | \$ 782,988 | \$222,253 | \$531,772 |

Development in the Pittsmtont mine amounted to 6226 ft., over 1 on the 1500-ft. level. The main shaft was sunk from 1770 to 1828 ft., a heavy clay gouge at this depth stopping sinking. As the water is drained from the fault-plane, resumption of sinking can be proceeded with. Work on the upper levels opened a good deal of new ore.

An 800-ton flotation plant was erected to treat tailing and slime from the concentrator and old dumps. Re-modeling of the blast-furnaces was completed early in 1915. These two improvements cost \$136,000. In March, 1916, the plant produced 1,300,000 lb. of copper.

UTAH CONSOLIDATED MINING CO.

According to the manager, Fred. Cowans, ore reserves of this Utah company are 266,700 tons assaying 1.9% copper, 0.05 oz. gold, and 0.69 oz. silver; also 43,500 tons containing 16.21% lead, 0.7% copper, 0.04 oz. gold, and 4.96 oz. silver. There is also over 100,000 tons of low-grade ore, profitable with high metal prices. Development and exploration totaled 19,890 feet.

There was shipped to the International smelter 207,119 tons of copper, and 65,129 tons of lead ore, yielding 8,836,091 lb. copper, 17,777,604 lb. lead, 370,985 oz. silver, and 19,387 oz. gold. Smelting cost \$705,957.

Revenue from metals was \$2,298,657. The profit was \$1,128,122. Dividends amounted to \$600,000. Copper bullion on hand is valued at \$1,075,304.

RIO TINTO COPPER CO.

The past three years of this company operating in Spain show the following results:

| | 1915 | 1914 | 1913 |
|---------------------------------|---------------|------------|------------|
| Copper production, tons. | not published | 21,515 | 36,320 |
| Average price received per ton. | £72 12s.6d. | £59 9s.4d. | £68 5s.9d. |
| Profit | £1,129,821 | £737,379 | £1,557,877 |
| Preferred dividends | \$1,250 | \$1,250 | \$1,250 |
| Common dividends | 1,031,250 | 656,250 | 1,406,250 |
| Surplus | 159,267 | 162,439 | 185,872 |

The reports are each year giving less data, that for 1915 being the first to omit the quantity of metal produced. In 1912 the profit was £2,090,792.

In the first quarter of 1916 the Nevada Hills profit was \$16,424 from 12,366 tons treated.



EDITORIAL



T. A. RICKARD, Editor

FROM a copy of the decree issued by the Mexican government, we note that the tax on the exportation of ores is at the rate 10% *ad valorem* on the silver as well as the gold contained therein. On other metals the rate is 5%. On claims from 1 to 10 pertenencias an annual tax of ₧6 Mexican or \$3 American is levied, the rate rising to ₧24 Mexican or \$12 American on gold and silver mining property covering over 100 pertenencias. However, these taxes are likely to be modified in consequence of protest from Washington. Taxation without government is not in accord with democratic ideas.

DISAPPOINTING results from the big consolidations on the Rand, notably the East Rand Proprietary, Randfontein Central, and Crown Mines, have put a quietus on the old notion that the blanket continued uniformly rich to an indefinite depth. In a recent issue *The Financial Times*, in London, says: "The truth is that the hard logic of events is compelling those in control of most of the leading Rand properties to a tardy, if tacit, admission of the theory to which we were among the first to give publicity years ago, that the value of the reefs in this wonderfully productive goldfield is slowly but surely deteriorating in depth." Many years ago the present writer mentioned the fact, not the theory, that even Methuselah died.

UNDER 'Discussion' we publish a letter from Mr. W. J. Sharwood, metallurgist at the Homestake, on the occurrence of nitrogen gas in metal mines. Mr. John M. Nicol, who wrote the articles on the saving of fine gold published by us last year, discourses on patents, and argues that the present system is so cumbersome as to cause many valuable ideas to remain buried. He insists that the originator of a basic idea is rewarded too little, while those who develop and copy it are enriched disproportionately. Our Mr. P. B. McDonald comments on a recent editorial on the way to success in mining engineering and himself advises deliberateness of purpose. A letter from Mr. J. D. Hubbard, who is engaged in drift-mining, contains a number of useful data concerning the cost of this kind of alluvial operation.

CCOURSES in foreign trade are announced. The Bureau of Foreign and Domestic Commerce, in the United States Department of Commerce, has organized an educational course in foreign trade with a view to training men for intelligent participation in the expansion of business believed to be assured in the near future. Dr. Edward E. Pratt, chief of the bureau mentioned, is

directing the instruction, and he is assisted by Messrs. O. P. Austin, E. N. Vose, E. A. De Lima, Emory R. Johnson, and G. G. Huebner, all of whom are specially qualified for the work. The course covers a treatment of the various factors entering into export trade and is supplied to corporations or firms at a moderate cost, for study by their employees.

NEVADA has a local section of the American Institute of Mining Engineers, as is recorded in detail on another page. This new departure, organized at Reno on May 18, was signaled by the presence of Mr. W. L. Saunders, ex-president of the Institute, who delivered one of his characteristically happy speeches. A propitious start was made, the co-operation of the Governor of the State being conspicuous, as well as that of the local School of Mines, led by two professors, Messrs. F. C. Lincoln and J. C. Jones. The profession was further represented by such distinguished practitioners as Messrs. Charles Butters and Whitman Symmes. It was high time that our friends on the other side of the range had their own local organization and rallying point. We wish the Nevada section every success.

SPEAKING of patents, we note that the British government is taxing royalties on patents at the unearned income-tax rate, whereupon a controversy has arisen with the Chancellor of the Exchequer. It is claimed that "the case of the inventor is different from that of the author, for invention can hardly be regarded as a profession. It is usually accidental in its manifestation, and when it leads to patent rights with a marketable value the sale of them has little of the character of annual income." To this most of us in this country will demur. An inventor's occupation is likely to be quite as regular as an author's. Consider Mr. Edison. As to the regularity of returns, simulating an income, ask Minerals Separation Ltd.; or if they are secretive, ask their licensees. No, the British view of the subject is not commendable.

FALLACIES die hard. One of the most pernicious is the notion that fire-assays fail to discover the real value of many ores of gold or silver. Of course, if the assayer is an ignoramus, he will miss his object, and in some rare complex ores the ordinary methods may break down, but to assert that there is more gold and silver in most ores than the average assayer can detect is not true. The statement is used to deceive the ignorant and to promote bogus schemes of treatment. We have before

us a booklet now being circulated in Alaska in which a company claims to extract \$20 to \$90 in gold from ores that yielded from \$2.40 to \$16 by the "old fire assay." It is explained in this prospectus that "the same flux was used and all charges carefully weighed. The heat of the furnace was kept as nearly uniform as possible." From our own personal experience of assaying we are able to state that this is rot. We warn our readers against the imposition.

CHLORINE is one of the most valuable of chemical agents. It has played an important part in the metallurgy of gold and silver, but efforts to extend the use of it to the extraction of the base metals have met with incomplete success as yet. Of the various methods, the most promising is the one identified with the name of Mr. John E. Malm, and, it may be added, Mr. S. A. Ionides, for these two metallurgists have collaborated in the development of the process. In this issue we publish a detailed and authoritative article on the theory and practice of dry chlorination as applied to ores of the base metals, written by Mr. Ionides. This article will serve as a timely corrective for an anonymous description of the process appearing in a recent issue of our New York contemporary. Whatever the immediate future of this phase of chlorination, it is obvious that the publication of details concerning the actual working of the Malm process and an explanation of its chemical rationale should clear the ground for further advance in this department of metallurgy.

WAIVER, by mutual consent, of apex rights between contiguous mining properties is a sensible way of preventing litigation. The four principal companies operating in the Miami district waived their extra-lateral rights in order to avoid trouble. It is now announced that the Detroit Copper Company and the Lazinskys have made a similar arrangement in the Morenci district. An earlier instance, which proved an example worthy of imitation, was the agreement between the Copper Queen and the Calumet & Arizona companies, in the Warren district. Mr. James Douglas, speaking for the Copper Queen, says of the agreement: "In spite of our close contiguity, and the many causes for friction that would inevitably have paralyzed the whole district under the working of the apex law, we have not only maintained friendly relations, but the terms upon which we agreed, when deciding to make our side and end lines carried down vertically the dividing limits of our properties, have immensely helped in the development of the Warren district, for when one company has made a discovery, the inspection of this discovery has been open to the officers of its friendly neighbor." This needs no further comment.

SILVER has been subject to further fluctuations, recorded elsewhere. The Mexican dollar, as *The Economist* says, "is now worth more dead than alive." Legally it is worth half the Mexican 50-cent gold dollar,

namely 2½ cents, on May 3 it was worth 27 cents as unrefined bullion. If silver were to rise to 90 cents it would pay to ship rupees from India to London, and a lot of silver plate might go to the melting pot. However, in India a shortage of silver has been developed and the recent prosperity of the country is likely to cause a further strain on the available currency. In China, it is true, the Ministry of Finance is talking of a gold standard, but the political conditions render governmental action most unlikely. The *Temps* states that the French government will coin 80,000,000 francs in silver this year as against a normal coinage of 8,000,000 to 10,000,000 francs. Apart from minor causes, or even the decrease in production due to Mexican misrule, it is clear that the huge structure of credit now being created in Europe must have an ampler metallic base than is afforded by the output of gold.

LAST October we made mention of the American Association of Engineers, which was started at Chicago on September 14, and in our issue of October 16 we published part of a stirring address delivered by Mr. F. H. Newell. Since then the organization has been perfected and at the end of March a membership of 512 had been recorded, as we are informed by *The Monad*, a monthly publication issued by the new society. One of the first undertakings of the Association is to assist its members in obtaining employment by means of a service clearing-house. Another function is to give advice on patent and legal matters. The main purpose, as appears in the constitution, is "to raise the standard of ethics" and "to promote the economic and social welfare" of the engineering profession. Evidently there is an idea of awakening the profession to a sort of class consciousness and of winning the recognition of the community at large to the work done by engineers as members of the social organism. We are not without sympathy for this propaganda and look forward with interest to the growth of the Association.

WHAT is the richest stope you ever saw? This was the question put to a group of mining engineers in San Francisco a few days ago. A veteran instanced the face of ore at the boundary between the California and Virginia claims on the Comstock in 1876 at a depth of 1500 feet, where there was a width of 112 feet of \$100 silver-gold ore. Another quoted the Lake View Consols, at Kalgoorlie, in 1890 when the end of the 300-ft. level showed 10 to 12 feet of 50-oz. gold ore, worth therefore about \$1000 per ton. A third remembered the south end of the third level of the Broken Hill Proprietary in 1891 when 204 feet of ore averaged 50 ounces silver and 35% lead. Again there was the fifth level on the west vein in the Esperanza at El Oro in 1905 when a 4-ft. stope averaged \$500 per ton. An engineer from Nevada mentioned the Hampton stope on the 235-ft. level of the Contention mine in 1909; this was 25 feet wide and averaged \$200 per ton in gold. As to copper, the best any of us could recall was the 150-ft. level in the United Verde in

1884 when 85 feet of 35% ore was exposed. Thus the stope-faces mentioned had an assay-value in dollar-feet of 11,200; 11,000; 13,800; 2000; 5000; and 7600. Can our readers recall anything richer than these, omitting pocket-mining, of course?

FLOTATION was neglected at the last summer meeting of the American Institute of Mining Engineers, but full amends for such neglect is to be made at the meeting next September in Arizona. Among other methods of eliciting useful information on the subject, Mr. Dorsey A. Lyon, of the Bureau of Mines, at Salt Lake City, has issued a circular containing a questionnaire on flotation. We note that the queries include reference to the doubtful necessity for using agitation in all froth flotation, the question whether oil is a requisite, and the effect of an excess of it upon the operation. Another fundamental enquiry is that which asks whether the bubbles or the mineral particles are coated with oil, or whether the sole function of the oil is to modify the properties of the water. The electric theory is made the subject of a searching question and 'colloids' receive proper attention. An effort made in January, at a flotation conference in Kansas, to start a discussion on these same questions did not succeed as well as had been hoped, it being acknowledged frankly that much experimental work would have to be done before the basic uncertainties of the process could be removed. However, in any scientific investigation half the battle is to state the problem. We do not doubt but that the circulation of this questionnaire will stimulate thought and research to useful result.

WE have received a copy of the "agreement in regard to industrial conditions in the Clifton-Morenci-Metcalf district," the result of a conference between the managers of the Arizona Copper, Detroit Copper Mining, and Shannon Copper companies and a committee of 17 men, representing their employees in that district. Of the 17 men, 10 have Mexican names. The most important clause is the one providing that "all operations shall be conducted upon the open-shop principle." No discrimination shall be shown against union men, "the Western Federation of Miners always excepted." This covers the chief cause of the strike, which was started mainly because the management refused to deal with that anti-social organization. We note with pleasure that employees henceforth will not be obliged to trade at the company stores and that the intermediation of grievance committees elected by the men is authorized. Provision is made for the discharge of any foreman or shift-boss receiving 'tips' from his men as a factor favoring the holding of a job. The minimum wage for common Mexican labor is put at \$2 per shift when copper is at 13 cents or over. Increases of wages are granted ranging from 5 to 15% over the wages paid previous to the conference, on a sliding-scale based upon the price of copper, from 13 to 17 cents, although it is a curious fact that copper was selling at 27 cents at the

time when this agreement was made. To the mechanical crafts, mostly American labor, an increase of wages is granted on a sliding-scale ranging from copper at 13 cents to copper at 26 cents. The agreement is printed both in English and Spanish. It constitutes an interesting and instructive comment on the disturbances during the latter half of 1915.

Peace Rumors

Persistent talk of peace in Europe, together with the rapid enlargement of production, is having a growing effect on the metal markets. To what extent the general prosperity of the United States is dependent on war business is a question that cannot be answered definitely until an armistice is declared between the great belligerents. The Secretary of Commerce, Mr. William C. Redfield, has stated that there will be no industrial depression in this country when the War ends, and he supports his opinion by asserting that the country's war business constitutes not more than 5% of its total industrial and commercial activities. He estimates 25% of our exports as due to the abnormal conditions and points to the doubling of our shipments to South America as something independent of the War. We confess that the opinion of such an authority ought to impress us more than it does; the South American increase is a result of the War and it must represent in part, at least, a transfer of commerce that will return to its former channels, toward Europe. Even a 5% increase in any trade may be enough to exert a powerful influence on the price of a commodity. Although not nearly so well informed as the Secretary of Commerce, we believe a depression inevitable as soon as hostilities cease, if for no other reason than the disarrangement that will ensue. On the other hand, it appears to us most likely that the depression will be temporary, and will be followed by a steady increase of industrial prosperity, for reasons that have been sufficiently discussed in these pages in preceding issues. The wise man will be wary in times like these and recognize the essentially speculative features of the position. Zinc is not so high as it was for good reasons: rapid increase of production and severe curtailment of consumption in the galvanizing of iron. The increased demand for brass-making is due to the War and the decreased use by galvanizers is due to the excessive price. With a decline in one trade there will ensue a drop in the price that may, and probably will, be met to an appreciable degree by a larger consumption for peaceful purposes; but spelter stands at a figure that cannot be maintained for the simple reason that the cost of production is about one-third of the present price. As regards copper it is noteworthy that the average exports in the form of ingots, pigs, and bars during 1915 and the first four months of 1916 have been at the rate of 55 million pounds per month while in 1913 the average shipment of the same crude products was at the rate of 76 million pounds monthly. This difference is explained mainly by the cessation of trade with Germany, and

would appear to give promise of a big exportation to that country as soon as the War is ended, but we suspect that a considerable portion of the copper imported by Germany in 1913 was intended for warlike purposes, so that importation may not be resumed in anything like the same volume unless peace be regarded by Germany and her opponents as a temporary truce, affording an interval of recuperation for another contest. Of course, every sane human being will be glad to see a cessation of organized murder, and the hope is that peace will not be a mere interlude between recurrent contests on a world wide scale. If the growing weariness of the horror induces a temporary armistice, leaving the contestants in the mood to resume as soon as they have recuperated, then peace will wear a sardonic smile and an armed truce will be followed in a few years by another Armageddon. That would mean a piling of munitions and a steady accumulation of armaments, all requiring enormous quantities of the metals produced by the miner.

Mucking as an Educator

This is the season for giving counsel to students about to commence a career in mining. Most of them will have had advice *ad nauseam* and may be pardoned if they ask to be excused from more of it. There are two reasons for giving advice, one because the other fellow wants it, the other because you feel impelled to give it to him. The impulsion may arise from hearing somebody else giving directions that appear to be quite wrong. An injunction against which we would like to enter a caveat is that concerning manual labor. More than once we have seen a scholarly gentleman waving his lily-white hands while he urged his young friends to get down to realities, to become practical, to serve the apprenticeship of toil, by working as a shoveler, driller, trammer, or timberman, preparatory to promotion as a shift-boss, superintendent, or manager. We remember discussing this subject—the advisability of mining graduates starting as manual laborers in the mine or mill—many years ago in the office of the Calumet & Hecla with four other men equally anxious to find the answer to a basic question. What the present writer thought then he still thinks and it is this, that for such graduated mining students as are sufficiently muscular and hardy to perform the work of manual labor underground it is an excellent experience if not unduly prolonged. By working side by side with the toilers on day's pay the young man can gain an understanding and sympathy with the run-of-mine workers that may prove invaluable later when he becomes a superintendent or manager. But not many young fellows can do such work as drilling, tramping, or shoveling without being so fatigued as to care only for sleep and food. When working under such a strain, their mental faculties are in abeyance, they cease to observe, and they learn next to nothing. It is a mere treadmill. We speak for the average man. Not long ago one of our friends, now a distinguished engineer,

told us how he used to work with the timber-gang and when the shift was over he had enough energy left to enable him to dance till the small hours; he was so strong that his work did not begin to exhaust him. For him, and a few others like him, the experience of a working miner was excellent; for it was not prolonged; he was promoted. But to the average young fellow such an experience means utter physical exhaustion and the loss of valuable time, for he learns comparatively little while at work, owing to the intense absorption in the physical performance. In some cases, the effort induces permanent loss of health. Fathers who themselves were able to serve this severe apprenticeship are prone to forget that their sons have been reared under less Spartan conditions and are not so fitted to stand the strain. Moreover, rough labor does have a coarsening effect, which may be temporary, but in some cases endures. This may seem a negligible matter, if it involves only loose speech and vulgar terms of expression, but, after all, what is the purpose of a university training if not to give refinement of mind. Much of the belief that manual labor, or a training that begins at the bottom of the ladder, is good for the young fellows is based on the fallacy that a man must do a thing himself in order to know how it should be done and whether it is done properly. That is wrong. Keen observation and logical reasoning will enable a quick-witted person to pass correct judgment on a performance that he himself could not duplicate. A familiar example of the application of intelligent observation is afforded by the golf-caddy who himself has never played the game and yet can criticize a player's method, and even suggest the right remedy, simply because he has watched scores of other players, noticing cause and effect subconsciously so as to know that certain poses or movements produce certain results in the flight of the little innocent white ball. It is not necessary for an engineer to have thumped a drill or shoved a car in order to detect whether the one kind of work or the other is being done properly. What is the purpose of a student's training in the laboratory but to develop his powers of observation and what is all his scientific teaching intended to do for him but to enable him to reason correctly from facts carefully noted? Of course, every kind of experience is useful. If the span of human life were that of an oak, we should advise the young engineer to submit himself to a course of training and development that would include every phase of mining and metallurgical activity. But time is of the essence in this matter, as in most human affairs. *Ars longa, vita brevis est.* We go so far as to say that for the average young engineer, healthy and athletic without being as tough or hardy as the sons of the soil, it would prove more useful if he devoted a year to a study of book-keeping and accounting rather than spend it as a 'mucker,' and that six months given to learning Spanish might help him more than twelve months drudgery with the shovel. Not on his biceps but on his brain does the engineer depend for effectiveness; engineering is the conquest of mind over matter.



DISCUSSION

Our readers are invited to use this department for the discussion of technical and other matters pertaining to mining and metallurgy. The Editor welcomes the expression of views contrary to his own, believing that careful criticism is more valuable than casual compliment.

Nitrogen Gas in a Mine

The Editor:

Sir—The occurrence at Tonopah, cited by Mr. Steidle in a recent issue of your paper, of nearly pure nitrogen as a metal-mine gas, is of great interest, but I would suggest that it may be merely an extreme case of the removal of oxygen from atmospheric air by the oxidation of pyrite, etc., as noted by J. S. Haldane in coal mines, and of which several instances have been recorded as occurring in metal mines of the Western States.

When blue clay, or slate, containing finely-divided pyritic minerals is freely exposed to air, especially in a moist and warm atmosphere, oxygen may be quite rapidly absorbed. This effect may be accompanied by a considerable rise in temperature, due to formation of ferrous sulphate, with more or less free sulphur, ferric sulphate, or sulphuric acid. In view of the large amounts of sulphates found in some mine-waters, and of the fact that a pound of pyrite would suffice to completely deoxidize 30, and even up to 60, cubic feet of air, it is easy to account for the presence of large volumes of free nitrogen in a mine containing old stopes filled with pyritic waste or broken ore. Concentration of nitrogen in this manner probably accounts for the 'pockets' of gas occasionally observed in the backs of irregular levels and stopes, as, unlike carbonic acid, this gas is evidently lighter than air, though resembling it in extinguishing a candle-flame.

A case was reported from Colorado ten or twelve years ago, where nearly pure nitrogen appeared when the barometer fell, apparently on account of the expansion of stagnant air in stopes exposing pyritic material. A continuous stream of nitrogen might result from the slow passage of air through a similar mass of broken pyritic rock, and the cases mentioned by Mr. Steidle may possibly be explained in the same way.

I was once warned against entering an old untimbered shaft that had been recently uncovered, the air being reputed poisonous, and was surprised to find that a candle was extinguished when lowered a very short distance below the surface. A day or two later the air would support a candle-flame, and it was then noticed that ferrous carbonate was a prominent vein-mineral, and that much of this had become oxidized to a soft brown mass of limonite. At another mine a candle refused to burn through a stretch of over 50 ft. in a long drift, matches could not be lit, and even a carbide lamp required great care to keep the flame burning, although compressed air was escaping near the face of the drift.

The dump of soft ore from this drift was found to be steaming from the heat due to rapid oxidation of pyritic shale, and was intensely hot a foot or two beneath the surface.

Hoover's 'Agricola' contains a reference (page 210) to Pliny's observation of the fatal effects of the vapor arising from "sulphuretted" or "aluminous" rock in deep wells, and details of several cases are given in Pryce's 'Mineralogia Cornubiensis.' Probably these, as well as many of the reported occurrences of alleged poisonous gases in old cellars, etc., are attributable to shortage or oxygen from absorption by pyrite, etc., rather than to any actual evolution of noxious gas. Even when carbon dioxide is found in the air of metal mines, apparently as a natural product, it is no doubt often due to the reaction between calcium carbonate and sulphuric acid or iron sulphates resulting from oxidation, as has also been pointed out by Haldane.

With regard to the occurrence of nitrates in mine-waters, I would like to ask Mr. Steidle if it is quite certain that these may not have been derived from explosives. In one case, reported in *Science* some months ago, the water of a deep well was condemned on account of the alarming proportion of nitrate it contained, until it was found to have been 'shot' on the completion of drilling, with a large charge of dynamite. On the other hand, large percentages of nitrates have been found in the residues from various natural waters, and several analyses of such residues are given in F. W. Clarke's 'Data of Geo-Chemistry.'

W. J. SHARWOOD.

Lead, South Dakota, May 1.

Inventors and Their Reward

The Editor:

Sir—In a recent editorial on the subject of patents, you state that "the end in view is the rewarding of the inventor, without creating an incubus on industry." If we were only certain that this was the end in view, half our troubles would be over. Unfortunately that group of the public interested in patents, does not have only that end in view, namely, "the rewarding of the inventor," and in many cases it is the last thing thought of. The variously interested groups have different objectives, which might be roughly designated as follows:

The inventors are almost as much absorbed in the joy of the creative as in the possible perspective of the rewards that they seldom get. The attorneys, as a rule,

look upon the inventor as a fit subject for fees, and stimulate any kind of invention, however worthless, so long as it is patentable and subject to fees. The Patent Office looks upon the inventor as a kind of spool, upon which to wind unlimited red tape. The capitalist looks upon him as a sometime creator of useful monopolies. The average manufacturer looks upon the inventor's brains as a species of unprotected public store-house to be looted whenever possible. And the rest of the public considers the inventor a poor crazy fool, a crank to be pitied and derided.

In view, as you express it, of this 'low state of public morality,' far-reaching reforms should be demanded. The inventor is rarely considered in his true relationship to our complex civilization: he is the fountainhead of all material progress in the arts, sciences, and industries.

Our Patent Law and the Patent Office should be society's embodied expression of approval and encouragement for the inventor. Means should be found to give him useful criticism and suggestion, as well as technical and financial support.

The present law is supposed to supply a man with title to a thing that is essentially his. In the case of a homestead or any other form of property, the Government does protect him, and is particularly careful to avoid giving title to the same piece of land to two or more men. In the case of a patent, the Patent Office appears to be in the habit of issuing (of course quite unintentionally) titles to several different parties for that which the courts afterward declare to be identically the same invention.

Mr. Prost claims that monopoly is prevented, because price, supply, and demand are always automatically self-regulating, on a just basis by natural law. Let us see if this is true; an example taken to the extremes of absurdity is often the best way of analyzing fundamental principles. Allow me to assume that I invent successful processes and machines, with the special object of mining and treating very low-grade copper ore, and that I am fortunate enough to obtain unquestioned basic patents; and that with these inventions I am able to produce 5¢ copper from deposits previously unworkable; and further suppose that I had great capital at my command, and I bought up a number of these deposits, to a sufficient extent to supply the world's immediate demand, and then started to produce an unlimited amount of 5¢ copper, and at the same time refused to give a license for my patents to other copper producers. Would I have a monopoly, and without interfering with the prior art, and would my low-priced supply of practically all the demand unjustly affect the other producers or not? Furthermore how long would it be before almost every producer would be on his knees, willing to enter into almost any kind of contract, control, or combine that I liked to stipulate; and if the spirit of John D. was in the ascendancy, how long would it be before I made the general public pay 30¢, of which to give the producer 10¢, and keep 20¢, for my well-earned recompense, perhaps reserving a cent or two for educational foundations. Some of our monopolies have developed

into veritable incubuses, a burden to the American nation and a menace to the stability of our present state of society, because they have produced by reflex a dangerous discontent among the exploited class.

In the matter of stimulus, the present system is too difficult to admit of many meritorious inventors registering their ideas. While doubtless many worthless ideas are put forward, conversely, many valuable ideas remain buried, and in some cases are lost. There is also no method by which good ideas, once patented, can be brought into the limelight. It is assumed erroneously that the inventor will be able to place his ideas on the market once a patent has been granted. This is not the case, and the inventor is not the only loser. The public has a great interest at stake. If the flotation process had been developed when the first idea was sent to the Patent Office, the world would be richer by many millions of dollars worth of lead, zinc, and copper that in the form of sulphide slime have gone irrevocably beyond the tailing-pile.

The patent as granted is only a temporary monopoly given as a possible reward if the inventor is fortunate enough to know how to protect his rights, and can make use of his patent commercially. His invention may be the inspiration for a whole series of others, which owe their existence to the original, and are merely developed and improved copies, but which surpass it from a practical and commercial point of view. If, as commonly happens, the original patent was defective from a technical-legal standpoint, the pioneer generally gets no reward, but others and the public reap the harvest. This is such a well recognized fact that it often acts as an actual deterrent to many inventors; which goes to show that the present system does not provide the proper stimulus or reward for endeavor.

With regard to monopoly, we must note a curious fact: land when required for public utility can be condemned and sold, but a patent, however much it influences a public utility, cannot be condemned, at least so far as I know. Conversely, we find an anomalous condition in comparing property and patent rights. A man does not create a piece of land, but once he obtains title by purchase or otherwise, it is his or his heirs in perpetuity. A basic patent is dependent upon the creative genius of an inventor, he produced it, it is more his than a child belongs to its mother, the sense of possession and personal ownership is far stronger than in the case of land, and yet we begrudgingly give the inventor an uncertain and temporary title to the right to make, use, or sell. Real ownership in perpetuity is never granted; why should land rights be forever sacred and an inventor's creation excepted?

Some of your correspondents evidently think that the present patent system is perfect; in fact, they want no change. You, sir, can see that "the excessive demands, not of the inventors themselves, but of patent-owning corporations, have awakened a keen feeling of protest against the whole system, causing a set of conditions detrimental to metallurgical initiative for example," and you state: "thus it is claimed, a proper reward rarely

comes to the inventor himself, but to a patent-owning corporation, which waxes rich on royalties." You add: "the conclusion is that no other method is available, and no other is needed as yet." Then you contradict yourself by saying "America is a nation of inventors; we must have a liberal patent law." Here I do not agree with you, and, in another letter I propose to outline a scheme for a reform in patent law, but let us have some discussion first. Before proposing reforms, we must have a clear conception of the fundamental principles of law and of the desideratum that we wish to obtain by means of the said law. For my part I would postulate that the fundamental principle of all law is, that there shall be a definitely understood relationship between man and man regarding the objective under consideration, and that this relationship shall be clear and definite, and upheld by some social force. Secondly, that the question of clarity not only as to the relationship *per se*, but as to its reciprocal quality, must be defined: that is, are advantages or preferential conditions always to be assured to one side as against the other, and are the said conditions to be voluntary, or are they enforced by one and passively accepted by the other; in plain language are advantages to be given to the few at the expense of the many? Is the greatest good of the greatest number to be the desideratum?

It is the clarity and the certainty of law, and the assurance of its enforcement by overwhelming strength, that gives it its great social value, and makes the mass of the human race willing to submit to much that otherwise is merely onerous. The present status of the Patent Law fails entirely in clarity, in certainty, and in the enforcement of protection. Hence our demand for reforms. In suggesting reforms, it is also well to remember that we are dealing with human qualities as well as machines, and I therefore wish to draw attention to the psychological aspects by postulating:

(1) That the human mind is constantly striving to be creative, and that it requires not only knowledge of the prior art, but a certain individual faculty, and — above all—propitious times, circumstances, and surroundings, to produce the best from creative minds in whatever line, whether art, literature, abstract scientific research, or mechanical invention.

(2) That the creative faculty is different from the constructive, although they overlap and are inter-dependent. The former is the attribute of the inventor, the latter of the engineer.

(3) That men and women equipped with these faculties are rarely commercial or aggressive, and can only be stimulated to their best endeavor by suitable environment, freedom from financial care, and that supreme comfort that comes with the knowledge of successful and appreciated achievement. Owing to the inadequate supply of these requisites, the public is not gaining the effective results that might be obtained from the inventive and constructive class in society.

(4) That, as the facilities and comforts of modern civilization are due to the creative mind, it is to the immediate interest of the public, although they do not ap-

preciate the fact, to see to it that opportunity is provided for those of creative mind to exercise their faculties; and that during the exercise they shall be protected. Means must be found to provide the best environment for those that prove their merit, and with it a just apportionment of reward.

We must endeavor to formulate a new law without an "unnecessary interference with industrial initiative," and without waiting for the "millenium" or for "paternalism to the *n*th degree," and to accord with "unanimous public sentiment" as expressed by the general trend of our customs and laws. In formulating this new law we have to find a common meeting point for the artist of creative instinct, the man of constructive ability, the financier, the manufacturer, the consumer, and the general public.

We may postulate the desirability of an objective relationship between the nation and the inventor, and assume that if the general public had the law-making power in their hands, and if they understood the problem, and the direct importance to their own interests of a reform in the Patent Law, they would demand at least the following basic points:

A. To assure the greatest good to the greatest number.

B. That creative endeavor shall be duly stimulated and protected, and justly rewarded.

C. That the product of invention shall be promptly tested, and brought to use when meritorious, for the benefit of the public as soon as possible.

D. That suitable institutions shall be provided to assist the inventor in his research.

E. That unrestricted monopoly shall not be allowed, especially when it is detrimental to further endeavor, research, and discovery; for as the editor says, "we recognize the advantage of having ingenious men on the alert to discover improvements."

F. That the registration of new ideas shall be free.

JOHN M. NICOL.

San Francisco, April 19.

Aids to Success

The Editor:

Sir—It is interesting to consider the points that you discuss editorially on this subject in the issue of May 20. As you say, 'success' is interpreted in various ways, according to individual philosophies. With some men, success in mining means the accumulation of enough money to enable a retirement from all contact with mines, on a quiet farm in the hills; to others, success means a pyramiding of wealth beyond their capacity to enjoy it intelligently; still others strive for an honorable prominence in their profession, accompanied with a comfortable financial recompense.

A recipe for success was contained in the columns of *Life* not long ago. It gave a dozen rules how to get there. Each alternate rule contradicted its predecessor. No. 1, said: "Get a college education and fit yourself properly." No. 2 said: "By no means go to college;

suet an education isn't practical." I think this article was correct, for it is only necessary to look around to see every kind of success achieved in ways that contradict all the so-called practical advice that is meted out to young men.

One general principle of advice to young men has been a favorite for years. The gist of these guidances, variously expressed, has been to "do it now," and the result has been to make a nervous strain for seeming to do something, rather than to really do anything. When I was graduated from college, some six years ago, I had the opportunity to call on a prominent master of finance in New York. I had expected that all captains of industry, such as he, were nervous hurried individuals whose business hours were one tremendous excitement. To my surprise I found a quiet deliberate man, who was as unflurried, unhurried, and human as though he never had heard of "do it now." He had no great stack of papers on his desk, and he took his time about things in a way that indicated he believed in the value of cool thinking, not bluster and bluff. While the philosophy of the strenuous life, as advocated by Col. Roosevelt and others, has done wonders for this country, I know personally several capable young men whose work has deteriorated in quality because they allowed the desire for shallow and showy results—in other words, an overdoing of the do-it-now principle—to crowd out the real merit that they could have achieved. When immediate results are demanded, superficial results can be expected. A glib man of the "grand-stand" variety rarely thinks deeply enough to produce anything worth while. Exhibitions of energy of the sort that are minus all sense of proportion and brains, have fooled a great many people in the past, but I think the market for this coarse work is going out of style.

President Wilson in his little book, "When a Man Comes to Himself," suggests that a man will accomplish most in the end by following his enthusiasm, rather than being guided by necessity. Perhaps there is something to this simple bit of advice, for not always does "the four-flush take the pot from a moderately good hand."

P. B. McDONALD.

Berkeley, May 25.

Cost of Drift-Mining

The Editor:

Sir—Drift-mining for some reason has taken a back seat and it is not often that we are able to make any comparisons as to costs, so these figures are given with the hope that they will prove useful to others. They represent practically 1000 shifts underground and have been carefully compiled from daily records kept at the Nugget mine in Butte county, California during operation. The average width of the heading was 10 ft. by 6 ft. high, this size being carried for the purpose of extracting the best of the gravel. As the gravel was about 3 ft. thick some bedrock and a little capping was taken in order to give working-room. As the bedrock carried some gold it was recorded as "gravel."

The work was done under favorable conditions, as an incline had to be sunk, entailing hoisting and pumping of water. All the work was done by hand, drilling in bedrock and moiling in gravel. The total cost per ton mined, \$2.85, is high, in fact, about as high as this class of mining runs. The cost per foot was more favorable, as many think this work cannot be done under \$10. The cost, \$6.35, shows what may be done.

The details are as follows:

| | |
|--|------------|
| Length of tunnel (10 by 6), 1151 ft. (inclined). | |
| Labor, 990 shifts at \$3..... | \$2,970.00 |
| Dynamite (40%), 2319 lb. at 16c..... | 371.04 |
| Detonators (6X), 3157 at 1c..... | 31.57 |
| Fuse, 9096 ft. at 65c. per 100 ft..... | 59.15 |
| Candles, 1989 at 10c. per 6..... | 33.15 |

Total \$3464.91

Feet of holes drilled, 6270.

Cars hoisted, 3416 at 1500 lb. = 2562 tons.

Mining cost per ton = \$1.35.

Mining cost per foot = \$3.91.

Timbering:

| | |
|---------------|-------|
| Labor | \$ 80 |
| Timber | 21 |
| Lagging | 16 |
| Wedges | 6 |

Total \$123

Cost per ton = \$0.918. Cost per foot = \$0.1068.

It will be noted that little timbering was necessary, boulders being used for filling.

Other costs were:

| | |
|-------------------------------------|--------|
| All equipment | \$1960 |
| Power | 168 |
| Top labor and superintendence | 1600 |

Total \$3728

Cost per foot, \$3.23.

Cost per ton, \$1.45.

Total cost per foot = \$6.35.

Total cost per ton = \$2.85.

Tons per shift = 2.58.

Feet advanced per shift = 1.16.

Two men on each shift.

The total cost of the equipment in this case was charged to mining, as the equipment all reverted to the owners of the mine when the operating company ceased operating. As all the equipment was well taken care of, it would only be fair to allow it a cash-value of 60% of its cost, which would reduce the total cost of mining to \$2.3965 per ton, and footage to \$5.3257.

Where a total gravity system can be used the cost of drift-mining should be cut to approximately \$1 per ton for gravel, and from \$5 per foot upward, according to size and hardness of headings.

J. D. HUBBARD.

Magalia, Cal., April 15.

ARIZONA had only 49 men killed around mines in 1915, as compared to 62 in 1914, yet the number employed was much larger in 1915, being 13,598 as compared with 9422. The fatality rate for 1915 was 3.6 per 1000, which is not a high proportion.

The Dry Chlorination of Complex Ores

By S. A. Ionides

THE PURPOSE of this process is the extraction of all the metals in an ore, their purification, and reduction to metallic form. It was devised primarily for the handling of complex sulphide ores containing zinc, such as could not be treated profitably by any other means. The main development took place in Montana some seven or eight years ago, the experiments carried on by John L. Mahn for the late F. Augustus Heinze reaching a stage where the latter was preparing for the erection of a \$2,000,000 plant, when the crisis in his affairs caused the project to be dropped. The work languished until 1914, when the Bunker Hill & Sullivan Mining & Concentrating Co. nearly completed a plant at Kellogg, Idaho, and it is unfortunate that their lack of perseverance robbed them of the success they deserved.

THE FLOW-SHEET. Prior to treatment with chlorine gas, the ore must have been dried and crushed to a point where at least one facet of each particle of mineral is exposed. How far the crushing must be carried

to meet this condition depends on the nature of the ore, but in no case need it be as fine as for concentration, where each mineral particle must be isolated.

The treatment with chlorine gas can be effected best in a tube-mill as illustrated in Fig. 2 and Fig. 3. The chlorine enters at the ore-discharge end and promptly attacks the sulphides of the metals, converting them in part into chlorides. The extent of the conversion depends both on the ore and the temperature. With some ores the reaction will start at ordinary atmospheric temperatures, but if left uncontrolled the temperature will rise to an undesirable extent and the sulphur set free by the reaction in its native form will melt and, if present in sufficient proportion, agglomerate the whole charge.

With other ores, especially those low in sulphur, it may be necessary to heat the charge to 100°C., or even to 150°C., to start the reaction and carry it forward.

It is usually advantageous to carry the chloridization

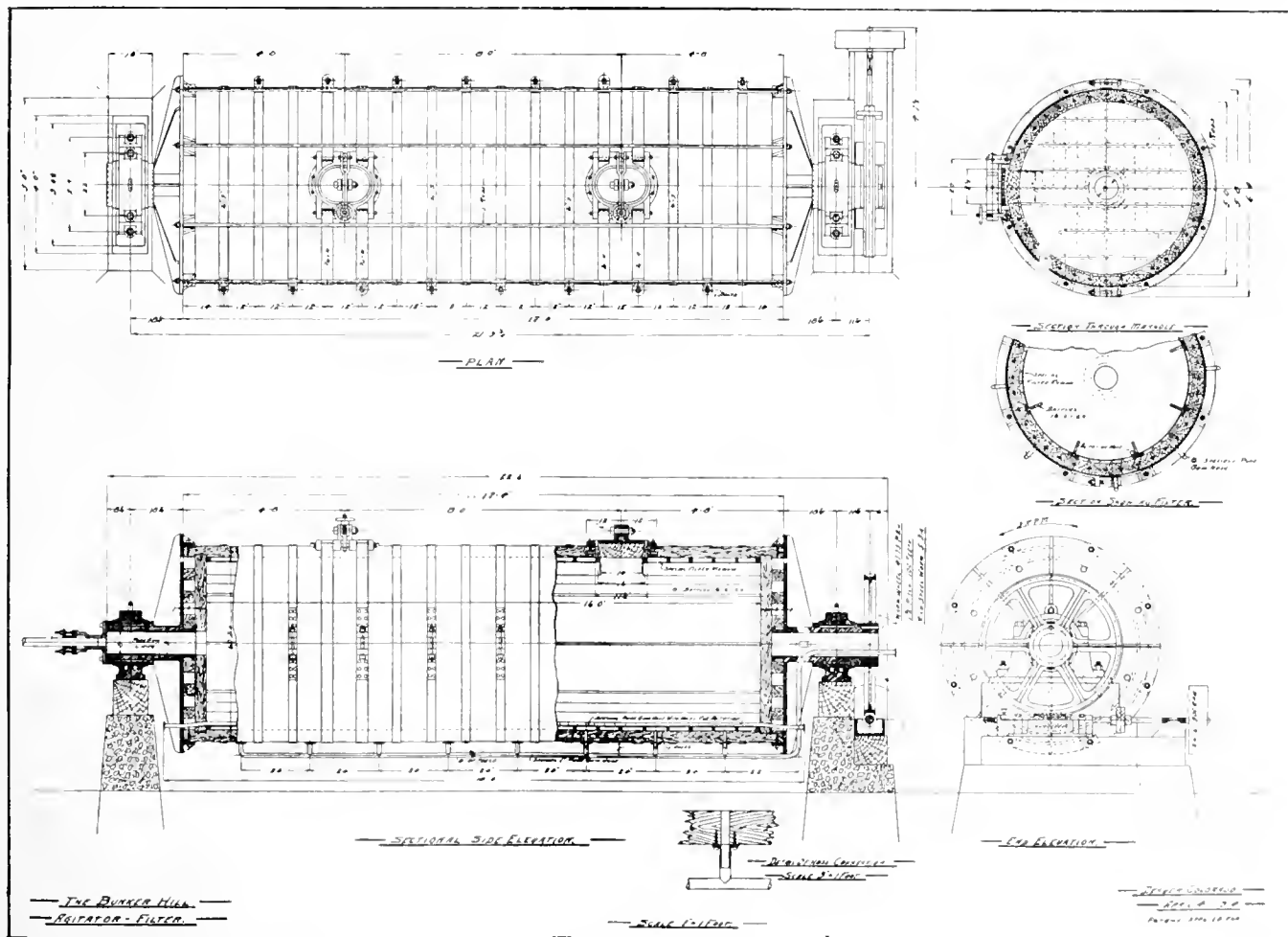

FIG. 1. THE BUNKER HILL AGITATOR-FILTER.

to a point where from 40 to 70% of the metals is in chloride form. The reason for this is that in every ore there is more or less iron, which becomes converted into chloride and in the subsequent treatment the iron can be made to yield its chlorine to other more valuable metals.

The second step consists of subjecting the ore to a mild chlorinating roast, the salt in this case being the ferric chloride already formed, which in the presence of air and metallic sulphides is decomposed with the formation of ferric oxide and metallic chlorides, thus completing the reaction that was started in the tubemill. This reaction can be carried out effectively in a multiple-hearth roasting-furnace by feeding the partly chloridized ore onto the third hearth and dropping it through the lower hearths, using the two upper hearths to catch the excess of chlorine given off either as such or as hydrochloric acid gas from the decomposition of the ferric chloride and which may have escaped contact with the sulphides in the lower hearths. For this purpose fresh sulphide ore is kept circulating through the two upper hearths.

The third step is the dissolution of the chlorides and their separation from the gangue. This obviously suggests agitation and filter-pressing. The Bunker Hill agitator-filter (Fig. 1) was specially designed for this purpose. It is fully described later.

The solution leaving the filter contains practically all the metals in the ore in the form of chlorides with the exception of iron, most of which has been converted into ferric oxide and so rendered insoluble, and the precious metals, which may have remained insoluble or have been precipitated if any reducing agents are present.

The gangue, which has been thoroughly washed by steam following the discharge of the solutions, is then run over amalgamated plates to catch any precious metals, and thence to the dump.

The fourth step is the separation of the metals in solution. As there is far more room for variation at this stage of the process than at any other, a definite ore will be considered, say, one containing the following metals: Cu 0.5%, Zn 2.5%, Pb 9.0%, Ag 3.0 oz., and Au 0.05 oz. This ore has been chosen as being of more general occurrence than the slime treated at the Bunker Hill, which contained Zn 2.5%, Pb 11.0%, and Ag 4.5 oz., and was practically free from copper and gold.

In this case a fractional system of dissolution would be employed. The first wash would consist of a charge of two tons of hot mill-solution to each ton of ore, as little wash being used as allows the agitation to be effective. The mill-solution built up from previous runs would contain the chlorides of iron, copper, and zinc, some silver chloride and its burden of lead chloride. It would dissolve practically all the iron, copper, and zinc chlorides, all of which are freely soluble in water, the silver chloride, which is soluble to a moderate extent in hot solutions of the chlorides of other metals, but only a little lead chloride, owing to the burden that it carries already and to the fact that lead chloride is less soluble in solutions of other chlorides, except salt, than it is in

water. The gold will be dissolved only if all the iron in solution is ferric chloride.

The second wash would be similar to, but weaker than the first. Its purpose is to build up a new first solution to replace the latter when it becomes burdened and is passed for further refining, at the same time removing the last of the iron, copper, and zinc chlorides from the ore.

The third wash would consist of a boiling hot concentrated solution of common salt, which is a good solvent for lead chloride. This wash, instead of being pumped back to its own storage-tank, as with the other two washes, is run into a shallow cooling-tank, where the lead chloride rapidly crystallizes. From there the crystals are passed to the lead-chloride collector, where they are washed with cold water, collected, dried, and charged into the lead-chloride melting-furnace, where they are fused and run into the lead electrolytic cells.

The first wash with repeated cycles becomes stronger till it reaches its saturation point of silver chloride or the zinc chloride reaches a concentration of 50% or more, when it is ready for further refining. This consists of precipitating the iron as oxide with zinc oxide or carbonate and replacing the various metals by one another, silver and gold by copper, copper by lead, and lead by zinc, so that the final solution contains only zinc chloride, which is then ready for evaporation, fusion, electrolysis, producing zinc of the highest quality and regenerating the chlorine for use in the tube-mill.

If other metals were present they would be removed in the same way, as any metal will precipitate from solution all metals, with few exceptions, the salts of which have a lower heat of formation. A separation of almost any combination of metals in solution can be effected in the same way by replacing them consecutively one by the other in the order of the heat of formation of their salts. An exception is manganese; but it can be precipitated at the same time as iron by zinc oxide if a current of chlorine gas be passed into the solution. The metals after precipitation are washed, dried, melted, and cast into bars.

The most vital step in the whole process is the electrolysis of fused zinc chloride. A great deal of thought and attention was given to its development by the electrical staff of the Bunker Hill company.

The type of cell used was that developed in the early work in Montana and the experiments were concentrated on finding the most satisfactory form for the electrodes. The result of these experiments was the cell illustrated in Fig. 4, the design of which was due to Malm.

MODEL ARRANGEMENT. This sketch, Fig. 3, was made on the basis of the plant installed at the Bunker Hill, but the arrangement shown here is on a one-floor plan, while the Bunker Hill mill was on two floors. The purpose is to show the straight-line arrangement of the tubemill, evaporators, and electrolytic cells, thus allowing easily for additional capacity as needed and more particularly to illustrate the course of the chlorine gas. The mention of a chlorination treatment is apt to suggest the idea of large volumes of a very undesirable gas and the

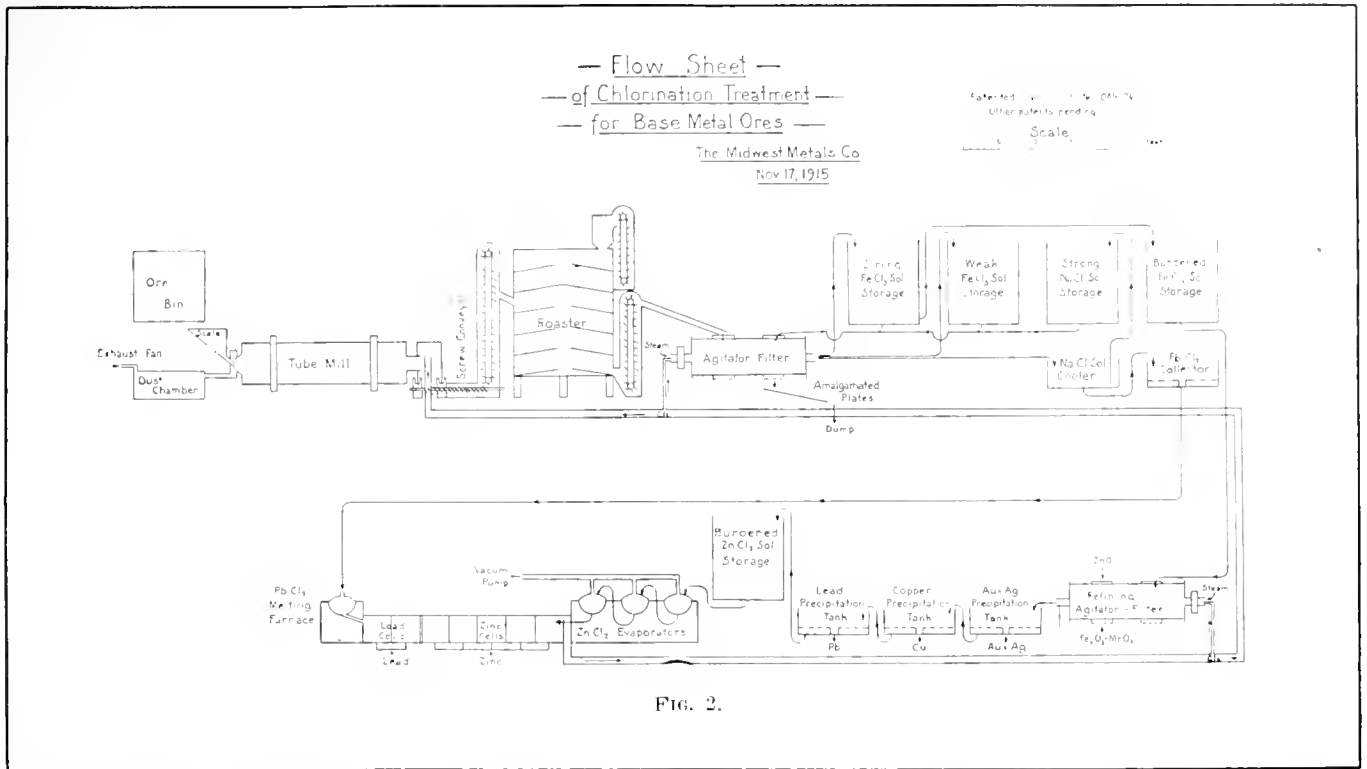

FIG. 2.

question is naturally raised as to what is done with all the gas and how it is controlled.

The following figures and the model plan answer these obvious questions. With 4000 amperes the capacity of each cell is, in round figures, 250 pounds of chlorine (and 250 lb. zinc or 750 lb. lead) per day. From each battery of 20 cells the output will then be 5000 lb. chlorine per day. At 0° C. and 760 mm. pressure 5.05 cu. ft. of chlorine weighs 1 pound, hence there would be generated, in round numbers, 25,000 cu. ft. of chlorine per

day, or 23.3 cu. ft. per min., if the gas were at 0° C. and 760 mm. pressure. With the gas at 450° C. this volume would become 61 cu. ft. per minute, or, say 1 cubic foot per second. The pipe leading from the cells to the tube-mill is about 40 ft. long and 1 ft. diam. The cross-sectional area of this is 0.78 square foot, which would give the gas a velocity of 1½ ft. per second, a very modest velocity.

The pipe at the Bunker Hill proved perfectly satisfactory; it was made from vitribestos board (an asbestos

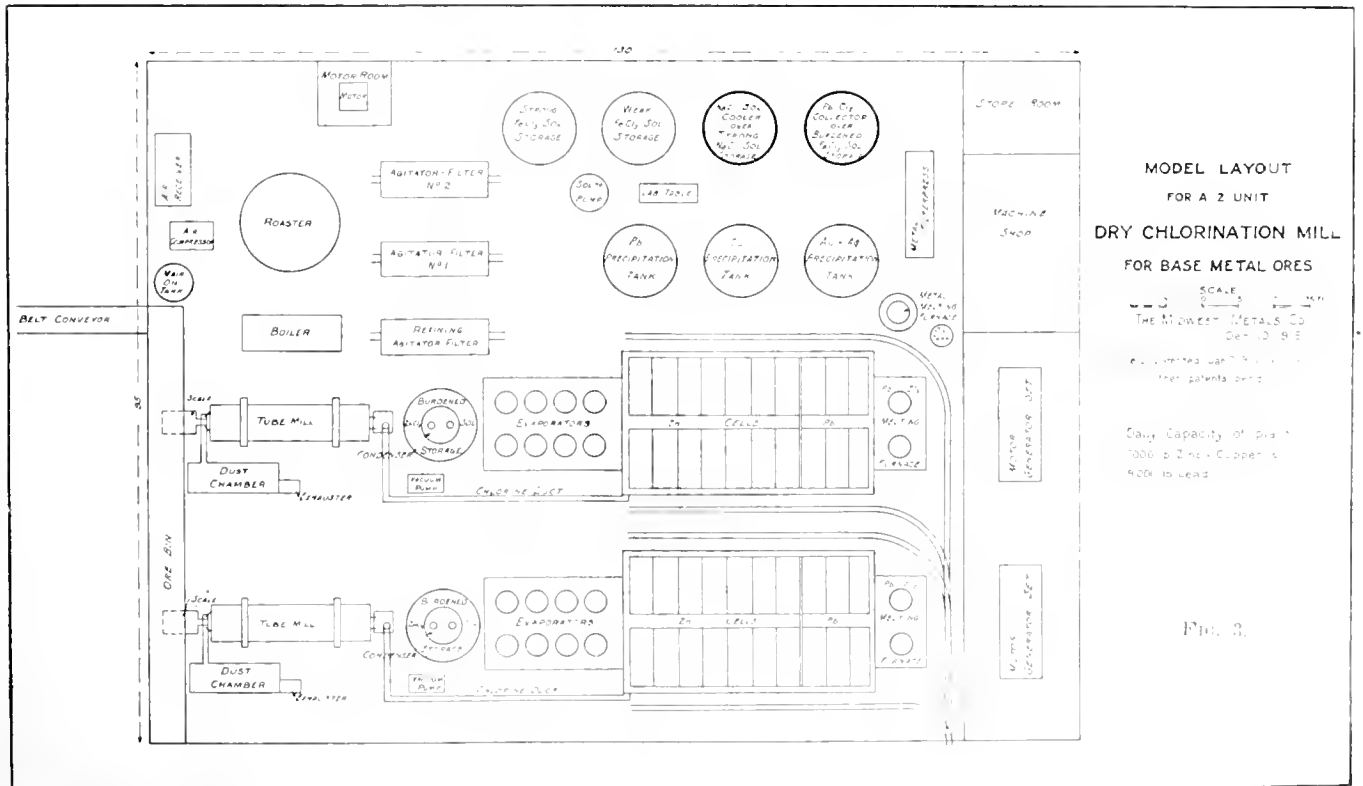

FIG. 3.

product, and to insure that there be no leak of gas the water pipe was kept under suction by setting an exhaustor on the far side of the tube mill, as shown in the flow sheet. This was an advantageous position for two reasons: the exhaustor was kept out of contact with the chlorine gas, which was completely absorbed in the tube mill and by reason of this absorption, its duty was reduced.

CONSTRUCTION OF CELLS. These cells for fused zinc chloride were cast in a battery of 20, ten on each side of a central duct. The frame was of concrete and lined throughout with fire clay tile. The main features of the cell were the electrodes. The anode measured 30 by 62 in. and was built up solid to the required size from graphite blocks. Numerous small holes were drilled through it to allow for the ready passage of chlorine gas. The dimensions were designed for a current density of 500 amperes per square foot and the length was extended sufficiently to allow it to project through the front of the cell, enabling proper electrical connections to be formed. The anode was supported $1\frac{1}{2}$ in. above the bottom of the cell by porcelain insulators and was packed tight into its recess in the wall.

The cathode consisted of molten zinc covering the bottom of the cell to a depth of $\frac{1}{4}$ to $1\frac{1}{4}$ in. Across the centre of the cell was a well 6 by 6 in., which also extended through the wall to allow an electrical connection to be formed outside the cell.

The tapping system was ingenious. The tap-holes were half-inch holes drilled lengthways through $1\frac{1}{2}$ -in. round graphite rods that projected through the front of the cell. They were filled with zinc, which solidified in place and formed an effective seal. When ready to tap, the projecting end of the graphite rod was connected to the anode by a short length of copper wire, terminated by a plug that fitted into a corresponding hole in the anode. This short-circuited the whole of the current through the graphite tap, which developed sufficient heat to melt the zinc seal promptly. When the proper amount of metal had been drawn off, the connection was broken and an asbestos plug inserted in the end of the tap-hole until the zinc within had solidified and so re-made the seal.

In operation, the cells were thoroughly heated and molten zinc poured in, a temporary form being set outside to make the connection. The anode was then packed into place and the electrical connections completed.

The cell was again heated thoroughly so that the zinc cathode was molten and there was no chance of chilling the fused zinc chloride. This point is of great importance, because while the fused salt is a conductor, the solid salt is a powerful insulator and if a skin chilled round the anode, it would be impossible to force any current through.

As soon as the cell was heated sufficiently, the fused electrolyte was run in and the current turned on. If the heating had been sufficient, electrolysis would start at once with a high voltage, which in the course of a few hours would drop to normal.

If the zinc were not molten at the start, the result

would not necessarily be serious, as with running, the temperature of the cell could be forced up to melt it. However, it is not good practice to start with the zinc solid, as splashes may have formed on the walls while it was being poured in, and these points being nearest to the anode would build fastest and might form a short circuit.

For continuous operation, of course, it is essential that the zinc be kept molten, so that it can be tapped. If the temperature is kept too low, the zinc is deposited in pellets, which accumulate and in time short-circuit the cell. If this happens, the only remedy is to shut off the current, open the cell, and apply heat from outside.

A good working temperature is 480° to 550° C., which is comfortably between the melting point of zinc (420°) and the boiling-point of zinc chloride (730°).

The chlorine gas is drawn off through the ducts shown in each cell into the central duct and thence through a pipe under the floor to the tube-mill, where it is promptly absorbed.

THE CHART (Fig. 5) shows the readings taken on three days' run of a 1000-ampere cell and illustrates the control that can be maintained. The run was made for this purpose, various experiments being tried, such as charging the cell rapidly with barely fused zinc chloride, which naturally reduced the temperature in the cell. The sudden drop in the ampere record can be seen following each fill; and the quicker the fill, the greater the drop. Under these conditions high efficiency could not be maintained, but the metal deposited during this run of 110 hours was found to be 85% of the theoretical deposit calculated from the average amperes used.

With steady working conditions, which consist of a steady current, continuous feed of fused electrolyte at the cell temperature, and tapping at regular intervals, a regular curve would be obtained as shown at (D), on September 14, from 6 a.m. to 12:40 p.m. During that time the voltage was kept constant and as the zinc was deposited, the space between the electrodes was reduced, the resistance being diminished accordingly and the amperes increased. The temperature dropped a little and then remained constant around 480° C. for the last two hours of the period.

On changing conditions, the following normal course may be expected: On change of voltage, the amperes will follow in the same direction and with more of a lag the temperature will follow suit. This is shown on various occasions, as at (B), on September 13, from 5 to 7 p.m. and on the last 12 hours of the chart.

The effect of the addition of cool electrolyte is shown clearly at (E), on September 14, at 2 p.m., when the sudden addition of electrolyte produced a marked dip in the ampere curve; at (C), on September 14, at 1 a.m., when the feed being hotter produced less dip; and at (A), on September 12, at 11 p.m., when its gradual addition produced considerably less disturbance.

The effect of tapping is in the same direction as the addition of cool electrolyte, but it is not nearly as marked. It is sufficient, however, to warrant the effort to keep the space between electrodes as short as possible.

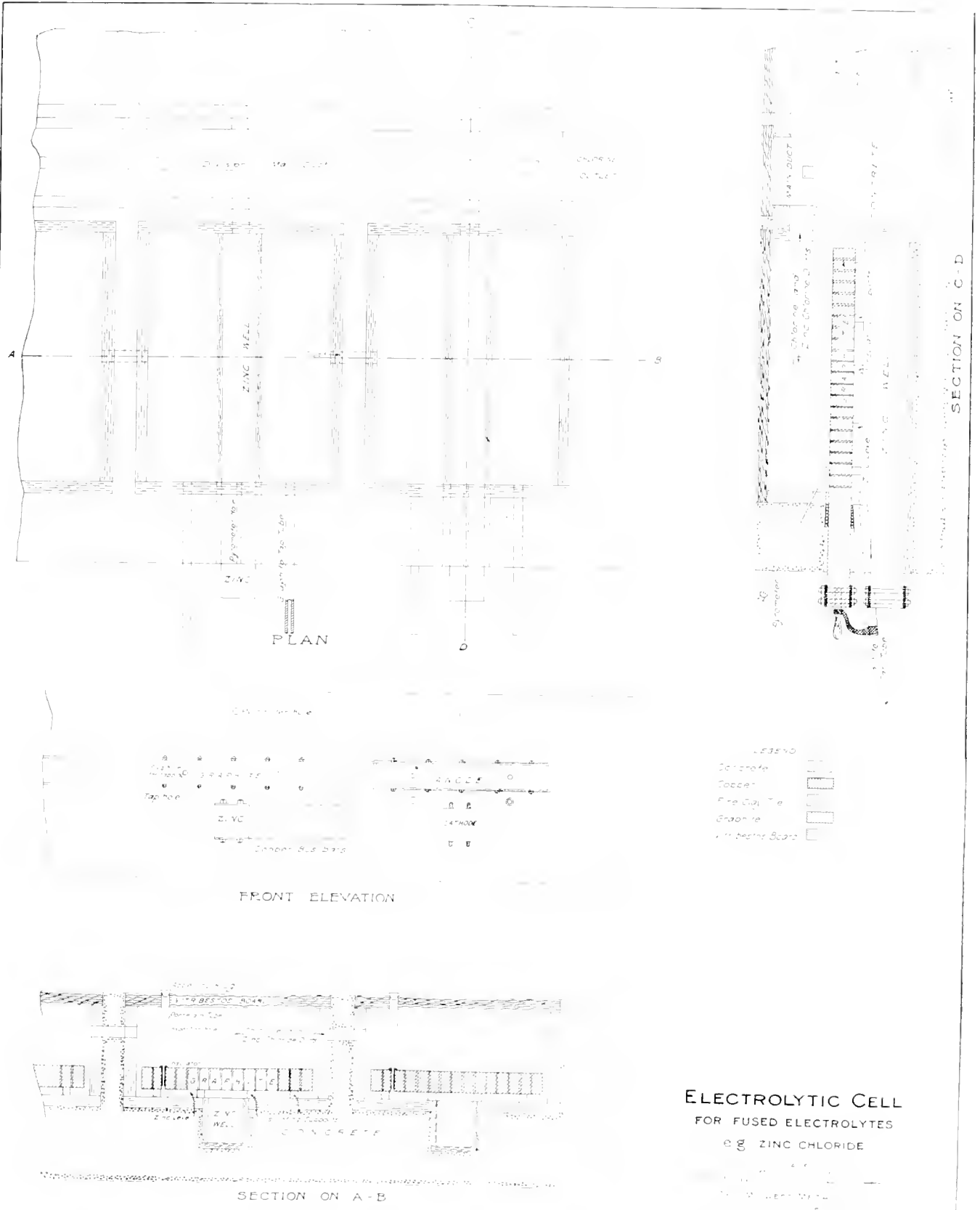

ELECTROLYTIC CELL
 FOR FUSED ELECTROLYTES
 e.g. ZINC CHLORIDE

Fig. 4.

The chart is unfortunately incomplete in that the temperature of the electrolyte when used was not recorded, nor are the figures for the voltage absolutely reliable. This is owing to external resistances, which were not accurately measured. These resistances would, of course, have no effect on the form of the chart, but would affect energy efficiency.

Charts were made on other runs, one of which extended over three weeks, the results confirming those illustrated here. Two shut-downs are shown by breaks in the lines of the ampere and volt curves. On each of these occasions the cell was started again with a high voltage and low amperage but quickly came back to normal conditions. Later a shut-down lasted for six hours after which the cell was re-started without trouble.

BUNKER TUBE AGITATOR-FILTER. This combined agitator filter consists of a cylindrical barrel 16 ft. long by 5 ft. diameter. It was constructed of wooden staves set lengthways against cast-iron heads. The barrel was banded with flat-iron bands set 12 inches apart. The bands were held together with 8 bolts, which also served as truss rods for supporting the staves. The inside of the heads was lined with wood, through which communication to the inside of the barrel was made at one end, but not at the other.

The whole of the inside of the cylinder was lined with coena matting and inside of that again was set asbestos filter-cloth. The filter-cloths were in 8 sections and were held in place by the same number of baffle-boards, which were wedged into place in slots built to receive them. The baffles were set longitudinally to agitate the pulp in the barrel as it was rotated on its axis. Two man-holes served for the admission of workmen to fit up the inside of the barrel, and for the subsequent charging of the ore and discharging of the tailing. All internal fittings were made with wooden dowel-pins, as the corrosive nature of the solutions rendered the use of iron nails impracticable.

The discharge of the solutions is through externally fitted rubber hose, eight in number, which are kept separate until united at a common header in the trunnion at the blind end of the barrel. This allows each section of the filter to be tested separately and leaky sections to be replaced with a minimum of disturbance. One of these hose-fits is shown at the bottom of the barrel in Fig. 1.

The open end of the barrel has connections for admitting steam, compressed air, and chlorine.

In operation, the barrel was half-filled with hot strong mill-solution and the ore from the roaster was charged through one of the man-holes. These were then closed and the barrel revolved. When sufficient agitation had been given, steam under pressure was admitted. The barrel was designed for a maximum pressure of 25 pounds, but the full pressure was rarely necessary to form the cake. The steam heated the solution and at the same time forced it out through the hose arranged for its discharge and following the solution, gave the cake a thorough wash. On release of the pressure, the cake peeled off, due to the sagging of the filter-cloths, and the second wash was admitted through the open trunnion-end while the barrel was revolving. The pro-

cedure was the same with the second wash, and on its discharge the third wash was admitted. This was the salt wash for lead chloride. At this point one of the particularly strong features of the agitator-filter was demonstrated. The admission of steam under pressure raised the temperature of the pulp above 100° C., which materially increased the solubility of lead chloride in salt solution, so that the steam following through after the wash cleaned out the last traces of that difficultly soluble salt.

To discharge the residue, the cake was churned with water, the man-holes were opened and a few revolutions of the barrel were sufficient to empty it.

To make a dry discharge, compressed air was turned on for a few minutes, the pressure allowed to fall, the man-holes opened, and, the cake peeling off, the filter soon dropped through the man-holes as the barrel was revolved.

The regular charge was 4 tons of roasted ore, which was reduced to 3 tons by the dissolution of the soluble constituents, and formed a 2-inch cake, the regular practice.

THE CHEMISTRY of the tube-mill and roaster reactions has not been completely worked out, though the results are known. Taking 'M' as a di-valent metal, such as lead, zinc, or copper, the tube-mill reactions in all probability are:

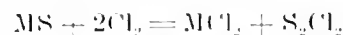

or combining the two equations,



All three reactions probably take place simultaneously in the tube-mill. In presence of moisture some side reactions occur, such as:

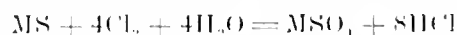

The formation of sulphates has been observed in the tube-mill product when the temperature has not exceeded 70° C. It would seem likely that the presence of sulphates would hinder the extraction of lead, as lead sulphate is almost insoluble in water, but it has been found that when boiled with ferric chloride or sodium chloride, lead sulphate is decomposed with the formation of lead chloride and the sulphate of iron or sodium. For this reason the formation of sulphates does not interfere with the extraction of lead.

This reaction offers an alternative method for introducing chlorine into the mill system to replace wastage by taking the chlorine, as indicated, from salt in place of buying zinc chloride, which is the normal course and which would be used in starting the mill. It also offers a basis for a method of treating lead ores without electrolysis, particularly where salt is available at a low price.

These reactions do not depend on the use of pure chlorine gas, though in certain cases the use of nearly pure gas may be advantageous. During the early work in Montana the gas was obtained from the electrolysis of aqueous solutions of salt and contained from 3 to 5% of chlorine. The gas from the electrolysis of fused zinc



FIG. 5. CHART OF 1000-AMPERE CELL RUN.

chloride can be obtained as nearly pure as desired.

Similar equations to the above could be shown for metals having other valencies than two, such as ferric iron, which is tri-valent and silver, which is mono-valent. Their behavior is strictly analogous.

The formation of sulphur chloride can be demonstrated readily on a small scale. If the tube containing a charge of sulphide ore be heated above the boiling point of sulphur chloride, say to 150° C. and chlorine admitted, the sulphur chloride can be distilled over and condensed as a dark-brown liquid, which is promptly decomposed by water with the liberation of part of the sulphur in its plastic form.

Under similar conditions with an ore containing arsenic and antimony, the chlorides of those metals were distilled over and condensed.

As a rule carbonates are not attacked in the tube-mill. However, at Bunker Hill it was found that siderite (ferrous carbonate) in presence of chlorine, air, and moisture was converted into ferric oxide, probably by direct oxidation of the ferrous salt to ferric and the subsequent loss of CO₂, since ferric carbonate is unstable. In absence of moisture ferric chloride was formed.

The control of the tube-mill reaction is maintained by varying the quantities of ore, air, and moisture, the supply of chlorine being kept constant.

The roaster reactions probably are:

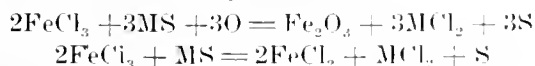

depending on the presence or absence of air. With excess air some of the sulphur would be burned to sulphur di-oxide. In presence of moisture some hydrochloric acid gas is formed, which at once attacks the metallic sulphides with formation of chlorides.

The refinery reactions are simple. They consist of the replacement of one metal by another.



The elimination of iron takes place according to the following equation:



The resultant ferric oxide is granular, quite unlike the slime produced by precipitation with ammonia.

MECHANICAL PROBLEMS. In handling corrosive substances like chlorine and chloride solutions, discretion has to be exercised in selecting the materials that are allowed to come in contact with them. For the tube-mill, iron is permissible, because dry chlorine even when hot does not readily attack iron. For solutions, wooden tanks are safe; and for pipe-lines, pure gum-rubber hose has a reasonable life. Valves on pipe-lines have been conveniently made by using pinchcocks on the rubber hose. Where this has not been possible for other reasons, the new alloys 'duriron' and 'tantiron' have shown great powers of resistance and have been used with satisfactory results. Pumps made from these alloys have been employed and air-lifts through wooden pipes have elsewhere demonstrated their value. Chlorine gas was handled by suction through vitribestos pipes.

Modern Blasting Practice

By P. B. McDonald

FOR blasting to best advantage, it is now recognized that the use of strong detonators makes for greater efficiency by intensifying the less sensitive explosive of the charge. The advantage of thorough tamping or 'stemming' of drill holes, preferably with a proper clay brought underground for the purpose, is also well understood by mine superintendents.* The recent tendencies in blasting practice have been along the line of using higher explosives, blasting longer holes and more of them at one time; and directing special attention to the primer. In general, the economy of blasting in more wholesale fashion has become apparent. Especially in stoping at mines with wide orebodies, the effort is being made to replace the small-gauge methods suitable for driving and sinking, by a system of breaking huge masses at one blast, then, if necessary, to block-hole these pieces for reduction to a size convenient for handling. Mammoth blasts, large-scale bench-stoping, and deeper drill-holes are becoming the order of the day. Of course, in narrow veins of three or four feet width, it is difficult to increase materially the proportion of the blasting; in such stopes higher explosives may solve the problem, together with more attention to the detail of primer, caps, and tamping. It is in stoping that the greatest room for improvement now lies; practice in driving and sinking is already of a high order, and the relatively self-contained and standardized procedure of advancing a drift or shaft, has been perfected to an admirable degree during late years.

Why large-scale blasting breaks more ground proportionately than scattered efforts was stated clearly by W. S. Simpson at a recent meeting of the South African Institution of Engineers, and recorded in the *Journal* of that society. Mr. Simpson says: "When two or more holes are drilled close to each other (see Fig. 1) and blasted in the usual way—that is, consecutively from below upward—these holes between them break more ground than had they been drilled far enough apart not to influence one another; there is a tendency for the holes to do their normal work—to throw out, for example, the craters *A* and *B*—and besides to throw down the rock *C* between these craters; the more nearly simultaneously the two holes are blasted, the more intermediate rock will be broken; if the holes are blasted with a long interval between blasts, little of the intermediate ground will come away."

This simple illustration indicates the gain by blasting a number of holes together, such that each hole helps the others around it. The advantage of placing long holes so that a large slab or mass of ore will be dislodged by

one blast (then reducing the pieces by block-holing or sledging) has effected a decided lowering of cost in the Michigan copper region, where the Calumet & Hecla, as a result of sedulous experiment, now employs 12, 14, and 16 ft. drill holes for stoping in place of the former 6 and 8 ft. holes. The contrast in the practice of stoping, as compared to that of sinking or driving is quite definite. While the former is tending toward the use of longer holes, the latter is becoming more like the European practice of employing shorter holes and more frequent blasting. The greater flexibility of shorter 'cuts' for sinking and driving has been made possible by the introduction of the light hammer-drills both of the jack-hammer and mounted types.

As Mr. Simpson's paper is not available to many American readers, a further reference to it may be of interest. He records a number of tests made in the Rand mines in order to determine the relative advantages of

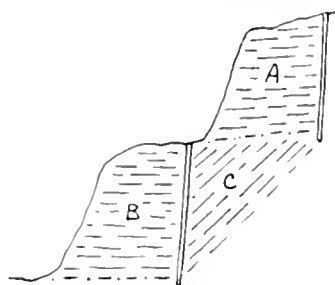

FIG. 1.

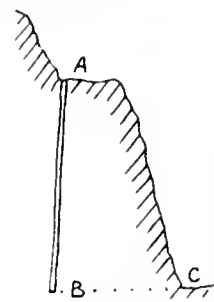

FIG. 2.

several explosives. The results show that in two stopes of different character, a blasting gelatine of 92.75% nitro-glycerine (and 7.25% nitro-cellulose) was 25% more efficient as an ore-breaker than a 'gelignite' of 56.4% nitro-glycerine, (with 2.5% nitro-cellulose, 30.7% sodium nitrate and 10.3% wood meal). In this he checks the manufacturer, who gave the comparative 'ballistic strength' of the two explosives at 100 and 75.6, as determined in laboratory by the ballistic pendulum method.

Referring to primers, Mr. Simpson has the following to say: "The primer, even if it consists of the same high grade of explosive as the charge, does not perform as much work as any one stick of the charge, because unlike them, the primer cannot be compressed to occupy the full width of the hole; however, it is not recommended to employ a cheaper explosive for a primer, though some miners advocate a primer of 40% 'ligdyn' because of its certainty and regularity of response to the detonator." The tests showed that by using 40% ligdyn as a primer for gelatines of 92.75 or 67.1% nitro-glycerine, the efficiency of the explosives was much reduced. In fact, with

*See 'The Efficiency of Tamping,' by Edgar A. Collins, M. & S. P., May 22, 1915.

the 40% primers the 92.75% gelatine broke little more ground than the 56.4% 'gelignite.' Ligdyn is a dynamite of 13% wood meal and containing, besides 40% of nitro-glycerine, 45% of sodium nitrate and 2% of wheat flour. It had been recommended previously for primers by several authorities, because, as they stated, "it increases the speed of detonation of other explosives and secures the detonation of every cartridge in the charge." In view of the seeming contradiction between the statements of Mr. Simpson and the powder experts (of whom Dr. Comey of the Du Pont company was one) as regards the efficiency of ligdyn as a primer, the following is suggested by Mr. Edward Walker of the *Mining Magazine*, "the fact that Mr. Simpson found the ligdyn

could have been employed, so that the distance *BC* could have been increased. On the other hand, had a socket of 30% of the hole been left, it would be evident that too great a burden was assumed, and the distance *BC* should be decreased. The top of a hole usually breaks easily; it is the bottom of the hole that makes the trouble. The burden, both the distance to the face and to adjoining holes, should always be measured (or estimated) as between the bottoms of the holes—not their tops.

By employing a higher explosive in stopping, a greater burden can be assumed, and the holes of a row can be spaced somewhat farther apart. A shorter socket will probably be left than with a slower explosive, and more shattering will be done, so that more rock can be picked



WHERE 'WELL-DRILLERS' ARE USED TO DRILL HOLES FOR BLASTING. THE PIT OF THE NEVADA CONSOLIDATED COPPER CO., ELY.

primer of no assistance may be interpreted to mean that the high velocity of detonation secured by its use is not so suitable for rending hard rock (such as on the Rand) as a slower transmission of the detonating wave." This is a technical point that is now being studied by engineers and mining men.

Perhaps the most pertinent part of Mr. Simpson's paper is his discussion of burdens and sockets. The 'burden' is the width of rock between the bottoms of the hole and the face, the measurement being made at right angles to the hole. In Fig. 2 the burden is *BC*. The 'socket' is that small part of the bottom of the hole that is left after the blast; many American miners call this the 'boot.' As pointed out by Mr. Simpson, "the main factor in stopping is the adjustment of burden to depth of hole; most holes when blasted will leave a certain length of socket, say four inches; when no socket is left, the chances are that the load on the hole was too small." That is, if the hole in Fig. 2 left scarcely any socket at all it would indicate that probably a greater burden

down after the blast. Both in driving and in stopping, a higher explosive will be apt to reduce the rock fragments to smaller pieces. Some superintendents consider this an advantage, as tram-cars will hold more ore when the fragments are fine, and the coarse crushing in the rock-house or mill is simplified, as well as such inconveniences as large pieces becoming stuck in skips, chutes, and grizzlies are eliminated. However, too much attention given to reducing to fine fragments in one blast will generally result in small-scale stopping methods of higher expense than the employment of longer holes, more of them, and a generally larger scheme of blasting. An added consideration is the inevitable loss in dust of precious metal ores when fine blasting is done. Primarily, the blasting of ore in stopping has for its object the separation of the ore from rock in place. If it breaks in huge slabs, the huger the better, for the expense of reducing these large pieces to a convenient size is insignificant as compared with the fundamental task of detaching the ore from the containing rock. Naturally a high explosive,

containing 60 or 80% nitro-glycerine, will cost more per pound than a 40% explosive. Whether the high explosive is economical in the end is a matter that must be decided for individual mines. In testing such explosives, difficulty may follow from the prejudice of the miners, who, as regards such changes, are decidedly conservative. The best method is probably that adopted by several mining companies who recently changed to the use of a higher explosive; they scoured dynamite on which the proportion of nitro-glycerine was not indicated in any form, so that its higher percentage was not known to the miners, and insisted upon a prolonged trial under fair conditions.

Mr. Simpson thinks that "too often the miner is told to put more ground on his holes"; he continues, "there is in stoping a decided tendency to make the burden too large; to check this tendency, burdens and sockets should be measured frequently—the sockets measured carefully, not merely looked into—and the ratio of the socket to original length of hole determined." In considering his remarks it should be recalled that he refers to practice on the Rand, where is probably the hardest and toughest ore of any important mining region in the world, also that the lodes are comparatively narrow.

A mine-superintendent recently remarked that, disregarding the present tendency to use more powerful dynamite in smaller cartridges for the purpose of reducing the drilling, he considers that a hole drilled with smaller charges in gauge of the steel affords a tighter receptacle for the dynamite and will blast to better advantage. In other words, a more even hole (perhaps begun at $1\frac{1}{2}$ in. and ended at $1\frac{1}{4}$ in.) filled for three-quarters of its length with $1\frac{1}{4}$ -in. dynamite that fits snugly in the relatively narrow space, will ensure a better explosion, just as firm tamping improves the ordinary hole. For primers, he emphasized the desirability of an explosive fully as high as the charge. He had, he said, advocated for loading much-tapered holes a 60% dynamite in the bottom, 40% for the bulk of the charge, and a primer of 60%. The purpose of putting a higher explosive in the bottom is two: the hole is smallest there, and the burden heaviest.

Harry East Miller, formerly superintendent for the Judson Dynamite & Powder Company and the Giant Powder Co. Cons., suggests an additional reason for using the high explosive at the bottom of the hole, namely, using it as a primer. Dr. Miller maintains that the speed or velocity of detonation of the primer, and not its ballistic value, is the greater factor in the work performed by the charge. The primer he says, is but a small proportion of the charge and the extra work performed cannot be attributed to the primer itself, but to the influence that the primer exerts on the balance of the charge. Hence he recommends the use of 60% "straight" dynamite (which is the highest grade of dynamite that can be shipped by rail) as a primer; half a cartridge is sufficient, for it is the quality and not the quantity that counts. With "straight" dynamite the velocity of the explosive wave increases with the nitro-glycerine content but this is not the case with gelatine dynamites. This

60% dynamite will start an explosive wave of the highest order and the wave will be communicated to the remainder of the charge and make it perform the maximum work. By "straight" dynamite is meant one that contains only nitro-glycerine and "dope," but no other nitro-compound and no ammonium nitrate.

The American International Corporation is the name of the new combination of industrial corporations and banks, which has for its purpose the extension of American enterprise in foreign lands. It is organized under the laws of New York State with a capital of \$50,000,000 and with a charter so broad as to permit the carrying on of almost any business, from gold mining on the Rand to establishing a machinery business in China, or resuscitating a coffee company in Guatemala. The chairman of the Board of Directors is Frank A. Vanderlip, the president of the National City Bank of New York, which institution is known to be an indefatigable worker for promoting American participation in foreign opportunity. Included in the large board of directors are: William E. Corey, James J. Hill, Otto H. Kahn, Ambrose Monell, John D. Ryan, and W. L. Saunders. Chase A. Stone, the president, has said, "We Americans are far behind the Europeans in building up foreign trade through association with foreign people and study of their ways. The Europeans have their young men scattered the world over. Ours have stayed at home, or, when they have ventured forth, have not had the time or the disposition for intensive study of the customs, manners, and business of foreign people." The first step taken by the new corporation was the purchase of the seven vessels of the Pacific Mail Steamship Co. operating along the west coast of North and Central America. The essential purpose of the corporation, however, is stated to be "not acquisition of property, but co-operation and resuscitation."

CHINA'S imports from the United States are 7.3% of the total imports into that country. Half of the imports from the United States is kerosene; the remainder includes lumber, machinery, iron and steel products, tobacco, and cotton cloth. Since the War began, American manufacturers of machinery and transportation equipment have obtained a good deal of business in China that formerly was supplied by European firms. A pamphlet recently issued by the Guaranty Trust Co. of New York predicts that "the next few years may bring among our people a greatly increased interest in China."

LARGE PROFITS in zinc during the recent 'war order' times are indicated by the statement that the New Jersey Zinc Co. paid dividends in 1915, aggregating 130% on its former capital of \$10,000,000; this company capitalized its large surplus through a stock dividend of 250%, which raised its capital to \$35,000,000. The Butte & Superior Co. is now paying dividends at the rate of \$40 per share per annum. The American Zinc Co., which has mines in eastern Tennessee that produce a high-grade spelter, declared a 50% dividend in preferred stock.

Tungsten District of Boulder County, Colorado

By Charles T. Kirk*

INTRODUCTION. Boulder county, Colorado, has been unique in having ferberite, the tungstate of iron, in commercial quantity; this explains the common saying that Boulder controls the price of tungsten. Scheelite is less desirable on account of making a pasty slag in the furnace; the higher manganese content of wolframite and hübnerite is also difficult of separation from tungsten. "It is interesting to note that two or more of the large manufacturers of incandescent lamps

trict, has produced two-thirds of the tungsten output. It includes the Barker, Bradley, Primos, Rogers (now Vasco), Union, and smaller tracts, the Crow patent (Colorado Tungsten Corporation) and the Boulder Tungsten Production Co., Great Northern, and other groups of claims, besides considerable Government land unclaimed. The tracts and other areas patented before being taken as tungsten mining land have vertical side-lines, but the mining claims located as such are under the law of the apex.

The only comprehensive publication concerning this area[†] is now exhausted, while a reprint is soon to appear, the following notes will doubtless have a wider circulation than the necessarily limited State paper. As I have made detailed examinations of only special portions of the field, I have secured permission to add to my observations from other sources, as cited. I have to thank Dr. R. D. George, as well as Messrs. Fair, Clark, and Rafter for many courtesies.

ACCESSIBILITY. The middle of the district lies 15 miles south-west of Boulder, or 45 miles north-west of Denver. It is reached by the Denver, Northwestern & Pacific Rail-

way to Rollinsville, near its southern border, and by the Colorado & Northwestern (an extension of the Colorado & Southern) to Cardinal, near its western border, 2 miles west of Nederland. The latter line is to connect with Nederland this summer. Interurban trains run on the Colorado & Southern tracks between Denver and Boulder, and from the latter place connect with Nederland, 20 miles distant, by an excellent county automobile road up Middle Boulder canyon. This last is by far the most rapid route, making Nederland only three hours from Denver.

PHYSICAL FEATURES. The relief of the region is rugged, ranging from under 7000 to over 9000 ft. Sugarloaf and Bald mountains and others are evidence of even a higher level that has been reduced by erosion.

*The Main Tungsten Area of Boulder county, Colorado, by R. D. George, State Geologist, with notes on the intrusive rocks by R. D. Crawford, geologist; First Rept. Colo. Geol. Survey, State University, Boulder, Colorado.

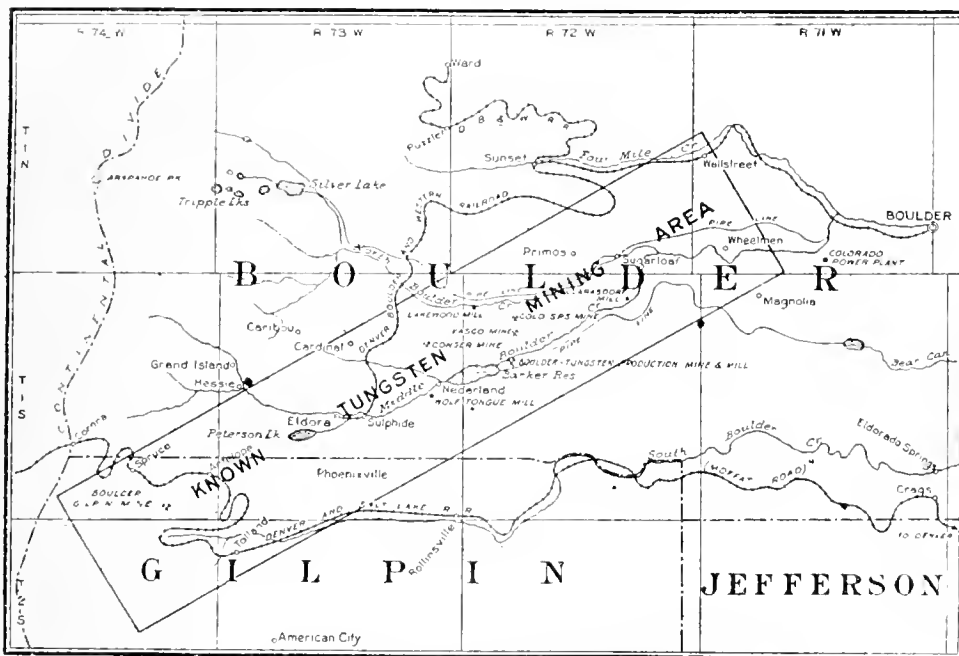

THE TUNGSTEN BELT OF BOULDER COUNTY, COLORADO.

specify that Boulder county tungsten must be used in the filaments."¹ Only the Saxon and Bohemian deposits compare in purity with those from what was formerly called the Nederland district, but which has been so extended by recent discoveries as to become known as the Boulder County tungsten field. A recent discovery is reported only a half-mile from the town of Boulder. A convenient sketch of the 'Known Tungsten Mining Area' was published on February 20, 1916, by the *Rocky Mountain News*. This shows a belt, 4 by 20 miles, extending south-westerly from Wheelmen and Wallstreet to three miles beyond Tolland and Spruce. While the sketch is reliable, it is known that favorable country-rock exists well beyond this area, especially to the south, in Gilpin county.²

A small area, 2 by 4 miles in the middle of the dis-

*Engineering geologist, Albuquerque, New Mexico.

¹George, R. D., First Rept. Colo. Geol. Surv., p. 90, 1909.

²George, p. 85, and recently reported discoveries.

As this chain is a part of the Front Range, the influence of the plains causes the snow to disappear earlier than in the more remote mountain regions. Only 20 inches of precipitation is recorded annually. The country is therefore sparsely wooded, but good spruce and pine saw timber abounds locally, while smaller growth is well distributed.

FUEL AND POWER.—The local supply of wood is much used for fuel, but the plentiful coal resources of Colorado can be drawn upon at moderate expense for fuel and power. Abundant electric power is developed from the reservoir of the Colorado Power Co. in the Boulder Creek valley near the middle of the district. This creek below the dam runs 15 to 20 second-feet, which is a plentiful supply for ordinary mining purposes.

COUNTRY-ROCK.—The region is part of a typical pre-Cambrian complex of probably sedimentary⁴ gneiss, with local schist, intruded in irregular fashion by normal biotite granite. Dikes of pegmatite and of fine-grained granite have followed the solidification of the earlier magmas, while a series of basic dikes—not fully correlated mutually, but apparently ranging from acid to basic in order of age—intruded after the pegmatite and before the tungsten metallization. A dike of fine-grained granite trends roughly parallel with a belt of productive mines in the north-eastern part of the district, while hornblende-andesite dikes trend nearly east-west through the productive area about Nederland. Within the massive granite I observed many rock inclusions, remote from contacts, some of them apparently of schistose structure but others decidedly not. None was longer than 15 inches, but much larger blocks have been noticed near contacts.⁵ Some of the smaller xenoliths are well rounded, while others are sub-angular to sharp. Tongues of fine-grained granite intruding into the metamorphites, as well as much baking of the gneiss and schist, are significant features of the contacts.

THE VEINS.—These are the latest structural features. They are generally well defined, and vary from less than an inch to as much as 14 ft. in width,⁶ running commonly 2 to 4 ft. Where they pass through granite country, the foot-wall is frequently gneissoid. The tungsten-bearing portion of the vein may lie either on the foot or hanging wall, or it may ramble from side to side. It may range from $\frac{1}{16}$ to 15 inches of solid ferberite, but where thicker it usually branches into small stringers. Almost no replacement of the wall-rock is noticeable, and delicate qualitative tests made upon a well-fluxed and thoroughly digested sample of wall-rock taken but two inches from a 2-inch ferberite vein showed only a trace of tungsten.

The persistence of the veins, both in width and metallization, is more dependable along the dip than strike, as shown in the workings of the Conger, Rafter, and Barker mines. The veins sometimes coincide with the laminations of the gneiss, where that rock encases them,

but evidently are not generally so controlled. Possibly they are most associated in direction with the pegmatite dikes, and therefore appear to be reopenings along these old planes of weakness. An examination of the vein-matter shows that it has been brecciated at least three times, and though the extent of the movements cannot be determined, they appear to have been only a few feet. While the veins occasionally strike north-west, in the main they range into the north-easterly quadrant. In this respect, as well as in some others,⁷ they seem related to the gold-bearing veins of Gilpin county, directly south-west of the tungsten district. Most of the tungsten veins of north-easterly strike have a steep dip to north-west usually from 75 to 90°. Vein intersections are common, though but little offsetting can be detected at the crossings. Almost invariably the intersections favor good ore-shoots, with occasionally such bonanzas as the Conger, the Barker No. 3, and the Parker-Elmette vein-junction in the Rafter group.

In the mines along the deeper creeks the water-level may be 500 ft. from the surface. In the Barker No. 3 shaft, almost on the bank of the reservoir, only 400 gallons per day was drawn from the 225-ft. level. It is interesting to note that a drift on the 140-ft. level, extending under the reservoir to within 50 ft. of its bottom, was nearly dry. In areas of less relief, the water-level is from 200 to 100 ft. below the surface.

The vein-filling consists commonly of brecciated granite, gneiss, pegmatite, or occasional schist, all somewhat kaolinized and stained by iron oxides in the present workings. Into these rock-filled fissures, and into many others not so filled, there have been introduced no less than four successive solutions containing silica and tungsten. The silica is usually crystalline, but is occasionally of the chalcidonic type, known locally as bone and hornstone. Possibly more of this hornstone was found in the earlier workings in the eastern part of the district,⁸ but it shows in some of the present mines at depth.

The ferberite occurs in three distinct types: (1) well-defined crusts, vugs, and open breccias, including a cemented breccia of the 'peanut-ore' type; (2) massive and firm fillings, not generally associated with breccia; (3) highly silicious ore, sometimes crystalline, but usually sub-crystalline (hornstone) and often frozen to the ferberite.

Among the occasional minor minerals in the ore are hübnerite (manganese tungstate), scheelite (calcium tungstate), and wolframite (iron-manganese tungstate). In earlier reports wolframite is discussed in connection with these deposits, but this mineral has been shown, by Hess and Schaller, to be ferberite.⁹ These writers assert that the manganese content of the tungstate increases from south to north across the district.

Among the uncommon minerals not bearing tungsten, the sulphides sphalerite, galena, chalcopyrite, and molybdenite have been noticed, as have also the oxides

⁴George, p. 19.

⁵George, p. 18.

⁶Hess and Schaller, U. S. Geol. Survey Bull. 583, p. 19, 1914.

⁷Forbes Rickard, M. & S. P. Vol. 106, p. 853, June 7, 1913.

⁸George, pp. 67 and 75.

⁹See Hess and Schaller, U. S. G. S. Bull. 583, pp. 37-38.

magnetite, hematite, and limonite. Much of the magnetite contains manganese, and occurs in small massive lumps easily mistaken for ferberite, especially in surface exposures with crystalline quartz. In the north-east, near Wheelmen, a telluride of gold and silver, probably syl-

orthoelase) are reported.¹⁰ While sericite (secondary muscovite) has not been revealed by the microscope, other conditions of mineralization and the general appearance of the wall-rock suggest its presence. The weathered granite, which I examined with only a lens,

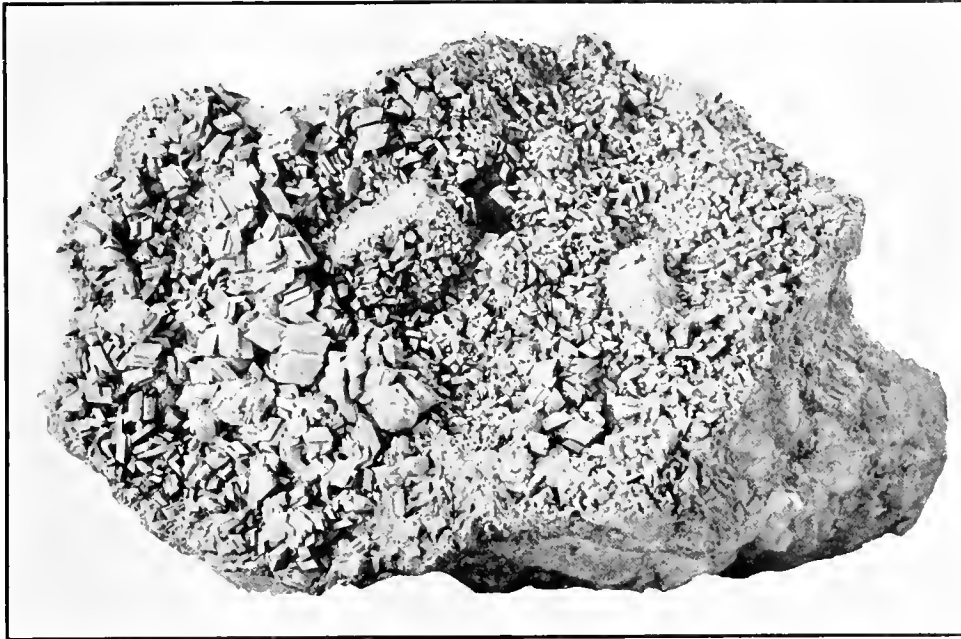

FERBERITE WITH RHOMBIC CRYSTAL FACES. (By courtesy of U. S. Geological Survey.)

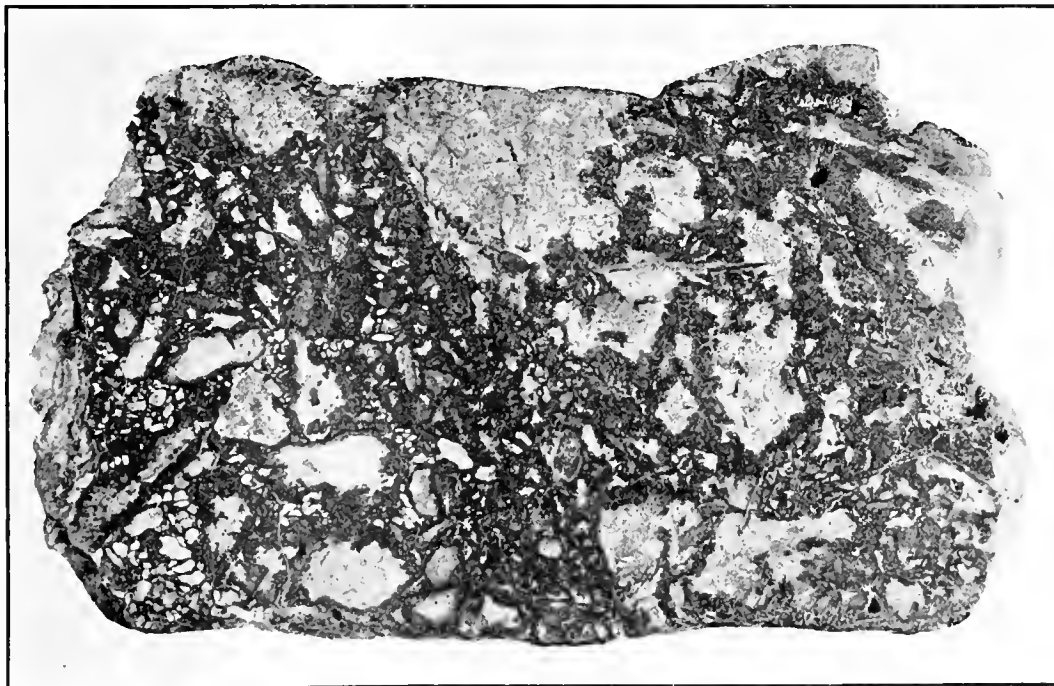

FERBERITE ENCLOSED IN FINELY BRECCIATED GRANITE. (By of U. S. Geological Survey.)

vanite, is not uncommon. Gold in some form is present in nearly all the tungsten ores, in places in commercial quantity; indeed, many of the dumps and stope-fillings of former gold mines are now being re-treated at great profit for tungsten. Fluorite is doubtfully accounted, and both adularia and valencianite (secondary forms of

did not reveal evidence of propylitic action¹¹ other than the reasonably sure presence of sericite and the fine-grained silica. The absence of cassiterite, tourmaline, and other common associates of tungsten is remarkable.

¹⁰Lindgren, *Econ. Geol.* Vol. 2, pp. 461-463, 1907.

¹¹Kirk, *Econ. Geol.* Vol. 7, p. 67, January 1912.

PROBABLE CONDITIONS OF MINERALIZATION. Hess and Schaller state:

"It seems probable that the tungsten minerals may have been deposited from the hotter water emanating from magmas, and silver and gold from the solutions after they have somewhat cooled." This conclusion would provoke the inference that the Gilpin county gold deposits are of a higher level, the extension of which has been eroded. Spurr, Ball,¹² and Ransome¹³ bear out Lindgren's conclusion that as much as 5000 ft. of rock has disappeared from the tungsten area. In the discussion cited, Lindgren uses the conclusions of Spurr, Ransome, and Ball together with his own inferences based upon the significant mineral associations mentioned above, and classifies these deposits among those of intermediate vein-zone depths—1000 to 12,000 ft. below the surface at the time of their filling.

A small amount of characteristic alteration (propylitization) is apparent, as well as evidence of too much brecciation and open vein-filling for the lower depth given for that zone. On the whole, the evidence seems to permit the supposition that the deposits as explored at present—to 1000 ft. in depth—were formed near the top of Lindgren's intermediate vein-zone, or at about 6000 ft. from what was then the surface.

ORIGINS OF THE ORE. Reasonably good evidence in the form of inclusions of different kinds of rocks, some of them well rounded, evidently by digestion and absorption into the granitic magma, indicates that there was a variegated roof-rock over this magma; indeed, it seems probable from certain erosion remnants that several thousand feet of rock has been removed since the cooling of the granite. It is also known that ferberite is slightly soluble in ordinary vadose (meteoric or surface) waters. This seems the strongest tangible evidence at hand to account for deposition by downward enrichment from formerly overlying rocks of possible tungsten content.

Opposed to these threads of evidence are (1) the fact that they do not suggest a source for the metal; (2) the tungsten minerals have close genetic association with a typical acid magma; (3) they have genetic connection also with the post-Cretaceous formation of the Front range, that time being one of widespread metallization throughout the Rocky Mountain region; (4) the evidence cited from Lindgren and others indicates that the ore was deposited at intermediate depths, probably 6000 ft., rather deep for the effective downward circulation of meteoric waters; (5) there is an absence of sources for acids stronger than humous or carbonic types, there being almost no sulphides in these deposits; (6) the tungsten minerals are only slightly soluble in the carbonic and other acids to be found in water near surface, no downward enrichment being recognizable in the existing mine workings; (7) the veins are constant in depth as far as developed, about 1000 ft., being more depend-

able in this direction than is usually the case horizontally.

These and other observations appear to show that the metals emanated from the granitic magma below, probably long after the solidification of at least the upper zone. The many generations of thermal vein-minerals signify that the cooling and contraction causing the earthquake action that shattered and sheared the veins extended over a long period, and that emanations of silica and ferberite-forming constituents continued till the sources below were cut off through solidification.

DEPTH OF THE OREBODIES. Upon the source and manner of deposition of the ore depends largely the life of the tungsten mines. The conclusion that the metallization occurred from below upward seems well justified, and the continuity of the veins to much greater depth than yet prospected is reasonably assured. I have made close studies of the veins at Butte; those, though metallized chiefly in copper, are similar to the veins of Boulder county in several respects. From the tightness and intense propylitization of the Butte veins, as compared with the Boulder veins, it would appear that the parts left by erosion at Butte were formed much deeper than the tungsten deposits as mined at present. It seems fair to infer, then, that the latter may persist to even greater depth than the present lowest levels of the Butte mines—3000 feet.

HINTS ON PROSPECTING. The following points on prospecting are classified into unfavorable and favorable conditions. Among the first are:

- (1) Schistose areas and those of more easily crushed gneiss do not generally carry continuous veins.
- (2) Areas where chalcedony is abundant generally yield ore difficult to concentration, especially in depth.
- (3) Time may be wasted by sinking on a showing of manganese-bearing magnetite that resembles ferberite. A weak magnet will attract this mineral, while a powerful magnet will be needed to pick up the ferberite. The streak of magnetite is black while that of ferberite is brownish black to reddish black—becoming more ruddy where exposed to weathering. Hematite has a dull-red streak, and is lighter in weight and harder than ferberite. Hüblnerite, the manganese tungstate, less desirable than ferberite, is rare. Its elongated, hair-brown crystals are easily distinguished from the rhombic glossy black crystals of ferberite.

The more favorable conditions are:

1. Areas in the neighborhood of pegmatite veins.
2. Many prospectors and engineers have faith in the country near the basic dikes, especially those of hornblende-andesite and pyroxene-andesite.
3. Occasionally a fault-zone along or across a hill is denoted by a valley. But valleys are also eroded in the schist belts, so that this is only a suggestion.
4. Ferberite withstands weathering, and may therefore be found naturally exposed, especially on steep slopes, in dikes of pegmatite, and in float broken from either of these.
5. Where conditions are favorable, it is sometimes

¹²U. S. Geol. Survey Bull. 583, p. 14, 1914.

¹³U. S. Geological Survey, Prof. Paper 62, p. 145, 1908.

¹⁴U. S. Geological Survey Prof. Paper 75, pp. 60-62, 1911.

advantageous to undercut the vein by an adit; but since the ore is generally more persistent in dip than in strike, it is well to prove the vein by sinking at or near the point of discovery.

6. Assays are not generally necessary. Ferberite is easily distinguished from other minerals occurring in these deposits by its high specific gravity (7.5), and its bright, almost cubic crystals of easy cleavage and dull reddish-brown streak (or fine powder). The prospector soon learns that it is folly to discard any ferberite at all. When tungstic acid is worth \$100 per unit (\$5 per pound) pure ferberite is worth about \$4 per pound. It is well to have assays made of old dumps, for in these the ferberite may be ground or weathered too fine for recognition.

LEASING. A large part of the production comes from lessees, who pay a 25% royalty and operate under agreements subject to cancellation on 90 days' notice. Occasionally the lessee contracts to mine at the same royalty a block of ground of, say, 70 by 100 ft. within the vein, and may proceed until it is all extracted, provided he does so continuously—day by day. Some operators have engaged to lease a definite distance along any veins cut in an adit for a period of two years from the time the veins are cut, provided they work continuously. The method of development by leasing is satisfactory to the lessee, who in turn exploits the ore possibilities in that part of the vein near his lease, and also gives a fair cash return for his rights.

MILLING. Some of the ore does not need concentration, but much of it must be milled to bring it up to 60 or even 48% grade. None of it is refined to tungstic acid on the ground. A small penalty is exacted for shipments running below 60% WO_3 ; ore running above 0.25% phosphorus or 0.01% sulphur is not sold. The ferberite is ordinarily more easily crushed than its gangues, so that careful dressing is necessary. R. D. George, State geologist of Colorado, has shown by experiment that stamping the ore till it is separated from the gangue reduces it to a pulp that will remain long in suspension, causing large losses in the tailing. As a result recent mills have installed initial grizzlies, followed by coarse jaw-crushing of oversize and immediate screening, passing thence to rolls for finer sizing and screening, lessening the possibility of 'pulsing' to a small portion of the ore. This dressing is seen to be not unlike that applied to the zinc ores of Missouri.

SILVER is used for a nation's coinage whenever a large amount of small coins is needed, as in paying troops, even though the gold standard is the basis of exchange in the country. When prolonged uncertainties of war or financial straits cause the hoarding of gold, a demand for silver coin ensues. In a recent discussion of silver for coinage, the *New York Times* asks the following question and answers it: "Why should a Government go to the trouble and expense of buying silver for coinage? Why not go on issuing paper money for circulation? Is not the fact that a Government is able to buy silver

proof enough of its solvency? The answer is that money must be related to people. Theory alone will not suffice. Traditions, habits, and prejudices have to be considered. There is a limit to the amount of paper money that people will freely accept. The limit is variable between different people. It is probably much lower in Russia than in France and England. But with any people there is a more or less definite ratio which metal money should bear to paper money. Paper money has been increased enormously in Europe. That circumstance alone would call for a greater coinage of silver. But it is probable that at the same time people have been hoarding silver. That would be only natural. Gold they are forbidden to hoard; silver they may. If they save at all, they would be at liberty to put silver aside and spend the paper money. Silver has an intrinsic value and always will have. Paper money, no matter how much confidence you have in it, is open to risk. Silver in hand would not be changed in value by the outcome of war, whereas some of the paper money now appearing in Europe may be greatly depreciated by the conditions of peace."

Tempering Drill-Steel

One of the companies that manufactures rock-drills recommends, for the tempering of drill-steel, the use of a special solution of blue vitriol and sal-ammoniac in place of water. Such a solution, as used at the testing-plant of the company, is mixed in an earthen jar in the ratio of 7 lb. of blue vitriol and 4 lb. of sal-ammoniac to 15 gallons of soft or distilled water. It is necessary, with this solution, to provide a hood just overhead with stove-pipe attached, to conduct the fume that arises when the bits are tempered. In case it is not practical to use this special tempering-bath, a strong brine is recommended. Although not absolutely necessary, it is preferable to anneal the steel after forging it and before tempering; this is best done by heating the steel a trifle higher than the tempering-heat and laying it across a piece of iron or in dry ashes to cool to blackness; care should be exercised not to place the steel on the damp ground to cool, as this rapidly conducts the heat away and produces strains in the steel.

To temper, heat the bit slowly to a bright cherry-red for about three inches from the cutting-face, and plunge in the bath for $\frac{1}{2}$ or $\frac{3}{4}$ in., holding the steel vertical and moving it slightly until the cutting-edges are cool. Then plunge the entire bit for 6 or 8 in. into the bath and withdraw quickly, after which one wing should be polished in order to detect the proper tempering color. When this color is secured at the bit end, quench it in oil, letting it remain there until cold.

A quicker method of tempering is to anneal the steel, bank the fire, and insert the bit, heating only $\frac{1}{4}$ to $\frac{2}{3}$ in. When the desired heat is obtained—a cherry-red—the bit is simply plunged and left in the brine to cool. The manufacturing company, which recommends the above methods, advises "not to use clear water for tempering, as the acid solution or brine gives much better results."

Concentration of Quicksilver Ores

As previously announced by the State Mineralogist, Fletcher Hamilton, an investigation is being conducted into the methods of concentration of quicksilver ores. The experimental work is being carried on in the mill of the Department of Mining, at the University of California, Berkeley, by Walter W. Bradley, of the staff of the State Mining Bureau. Much experimental work has yet to be done, but sufficient data have been gained, so far, to make a preliminary statement of partial results, pending the issuance of the final report in bulletin form later. This is done in the hope that it may assist those who are making inquiries along these lines, and also that it may elicit suggestions from those who are similarly experimenting at various mines throughout the State.

Aside from the present war-begotten flurry of high prices, quicksilver mining in California has become more and more a question of economically handling larger tonnages of lower grade ores. Since Robert Scott evolved his fine-ore, tile furnace in 1871, there have been no improvements worthy of mention in the metallurgy of quicksilver until the present agitation for concentrating. A very surprising feature of the situation, particularly to one familiar with metallurgical practices in the reduction of gold, silver, copper, etc., is the absolute lack of any systematic sampling and assaying at the quicksilver mines. So far as we have observed there is not a quicksilver mine in California which possesses or utilizes an assay-office, at least there was none up to within the last six months. The distillation assay with the Whitten apparatus is simple, quick, and accurate. The old-timers have been complacently saying "the furnace gets it all," and that therefore they did not need to assay. It is doubtful if the Scott fine-ore furnaces in operation in California are averaging 75% extraction. In addition they are notorious for the quicksilver absorbed by the furnace and condenser walls; also soot is formed which has to be re-treated for contained mercury. The products of fuel combustion being mixed with the vaporized mercury, cause condensing troubles.

Our experiments have shown that high extraction (above 90%) can be obtained by water concentration on tables, with friable ores in which the cinnabar is distinctly crystalline. Crushing by rolls produces a minimum of slime. If, however, the pulp contains a cinnabar slime, either from 'paint' ores, or by reason of having to crush fine to release the sulphide, the extraction by tables will be low. In such cases, though, it can be improved by classification, and treating the different sizes on separate tables. The slimed cinnabar can be recovered by flotation. A high extraction has been obtained by flotation tests in finely-ground (—80 mesh) fresh ores, utilizing either pine-oil derivatives or eucalyptus oils. We say "fresh" ores, because, contrary to common conception, cinnabar on exposure does oxidize sufficiently to affect flotation results, as some of our tests

have indicated. Good results were obtained by table concentration on an ore carrying natural quicksilver.

The concentrates being obtained, have yet to be roasted. Retorts are of limited capacity; and the concentrate, because of its high specific gravity, requires stirring to prevent packing. A small furnace of the Scott type could be used, with a narrower shaft and narrow shelf slit; such as in use at the New Idria mine for treating soot. Here again we have the fuel-combustion products mixed with the quicksilver vapor, and the attendant condensing difficulties. Some form of rotary roaster may be adapted, or a small-size unit of the McDougall or Wedge type of mechanically rabbled furnace muffle-fired.

The ultimate decision between a straight furnace reduction or concentration and roasting of the concentrate, will be a matter of comparative cost coupled with comparative extraction. The initial installation of a Scott fine-ore furnace unit is high (including condensers, etc., \$1000 per ton-day capacity. We know of instances where the cost has been materially less than this figure, but they are the exception rather than the rule); the extraction is low (in the majority of cases probably less than 75%); cost of operation is low (50c. to 75c. per ton for large units, economically managed, though this does not include high cost-repair, interest, or depreciation on the high initial installation capital). A concentrating plant of equal capacity will require less than one-tenth the initial capital expenditure, and a correspondingly lower depreciation charge; it will give 25 to 30% higher extraction; but the operating cost, on account of finer crushing, will be 30 to 50% higher. These points will have to be determined for each individual property.

Gold as a factor in finance was discussed by Mr. Adam Shortt at a recent meeting of the Canadian Mining Institute. "Gold," he stated, "is used in international exchange only to meet the temporary fluctuations in point of limited time. Owing to the fact that London has been the exchange centre of the world, and that people everywhere have confidence in the soundness of its finances, many of the sales effected between distant countries, for instance, between South America and China and Japan, pass through London, although the goods may not go within two or three thousand miles of England." This is not due so much to the accumulation of an enormous gold reserve, as France can probably furnish more gold than Great Britain. But it is a consequence of the great foreign trade and inter-relations of Britain. "The actual test of the efficiency of the credit of a nation is the small amount of gold that is required to serve and maintain that credit." This last pronouncement has a direct bearing upon the investigation being made in Canada as to the advisability of increasing the Dominion's gold reserve. Likewise it relates to a condition of finance in this country, where the amount of gold maintained has never been large, until recent importations in consequence of 'war orders' have diverted a good deal of gold from Europe to the United States.



GENERAL VIEW OF ATOLIA FROM THE RAILROAD STATION.

The Tungsten Mines of Atolia

By Charles T. Hutchinson

ATOLIA is near the boundary between San Bernardino and Kern counties, California, about 40 miles west of Kramer, a station on the Santa Fe railroad. This detailed statement is rendered necessary by the fact that until about a year ago nobody would have cared where Atolia was. Now thousands of people, at war and at peace, are directly affected by the well-being of Atolia, or, to be more specific, the Atolia Mining Company, which is the nucleus around which Atolia has grown.

The reason for this is the output of tungsten ore, of which the Atolia Mining Company is one of the largest producers in the United States. A comparatively short time ago, the output from the scheelite deposits of the Mohave desert was of no importance. The bulk of the tungsten used in the United States was imported from Europe; the prevailing price at that time, about \$7.50 per unit in the spring of 1914, was such that with careful management a small profit could be made by operating the company's mines and mill, and in treating small quantities of ore mined by lessees and owners of small mines near-by.

Now, however, tungsten has become one of the lustiest of all 'war babies,' and the Atolia Mining Company has jumped from comparative obscurity into such prominence that when a fire partly destroyed the mill in January last, the market price of tungsten immediately jumped from \$35 per unit to \$75 and over, but which is now somewhat lower.

When the Allies began to organize their munition department in real earnest, orders for millions upon millions in various iron and steel products were placed in the United States. To machine this iron and steel, correspondingly great quantities of high-speed steel for cutting-tools were required, while the great machine-shops of Europe were equally clamorous in their demand. Tungsten is the alloy commonly used in making

steel of this character, most of the high-speed tool-steel carrying from 12 to 18% of tungsten. A price of 65c. before the War has jumped to over \$3.25 per pound at present writing, and the supply is inadequate to fill the demand. It has even been stated that one of the great American steel companies had an order from Europe for 26,000,000 lb. of high-speed tool-steel at a price of about \$3 per pound. It is not surprising, then, that the well-informed are curious about Atolia.

The method of milling the ore is comparatively simple, wet concentration being used. Primary breaking is done in a Hercules-Blake crusher, while the finer grinding is completed in a Marey ball-mill and Huntington under-driven roller-mills. Sand and slime are separated by Dorr duplex classifiers, while Callow tanks are used for dewatering; subsequent concentration is effected by Deister Simplex double and single-deck tables. The concentrate is then sacked in the usual way, while the tailing is dewatered in an Oliver continuous filter and the cake carried to the tailing-pile by a trough-belt conveyor. The slime-tailing is deposited in a separate settling-pond where it is impounded for ultimate re-treatment. Hand-jigs fill a useful function in eliminating much of the slime before concentration.

Preparations were under way at the mill to substitute electric motors throughout, in place of distillate-engines; in fact, only one of the distillate-engines was in commission at the time of the fire, and it was this engine that was responsible for the conflagration. Back-firing caused the almost complete destruction of the mill, followed by an increase in the price of tungsten of \$15 per unit, and of high-speed tool-steel \$2.75 per pound.

Atolia is teeming with life. Even beyond the city's limits, if there be such, the subtle influence of the boom is felt. On the way in the train, the conductor whispered mysteriously of great deposits of the once base, now nearly precious, metal. Taking an automobile as a

substitute for the slow train from Kramer, and voyaging recklessly toward Atolia over the thank you ma'ams masquerading as a road, the chauffeur gently insinuated that he knew of a fine deposit of "placer tungsten," which could be made to "pay big" for an expenditure of only \$1500.

Estimates from various sources place the present population at 850 souls, and some Mexicans. The appearance of the tented city is pleasantly reminiscent of Tonopah and Goldfield during the early days. The mines and mill of the Atolia company are operated on three 8-hour shifts, the same is true of the construction crew at work on the rebuilding of the mill. The restaurants meet the exigencies imposed by these conditions and are on the job all the time. Accommodations for strangers, and even old-time residents of, say, a week's standing, are nil. Space there is plenty, tents are scarce, hotels are non-existent. One miner rather pathetically observed through the wicket-window at the company's office that he had been "on the pay-roll four days," that he had been "sleeping on the soft side of a pile of lumber for four nights," and that resulting therefrom had come upon him "the gol-durnedest kink in his back that ever was," and that therefore an enforced rest was necessitated until such time as a bed and tent could be procured for him by fair means or foul.

The chief of construction, finding certain topographic advantages in that portion of the city corresponding to Forty-second and Broadway, pre-empted the greater portion of it for use as a framing-yard, and three shifts of millwrights are busily engaged in framing the new building. It is an almost continuous procession of building material, machinery, and supplies that passes from the railroad freight-platform down the street to the mill. Record time was made in the work of rehabilitation after the fire. The still-smoking ruins were removed in a few days, such machinery as presented possibilities of repairs was hauled out of the debris and new parts ordered, while the scrap was piled up to one side. As fast as new machinery arrived on the ground it was installed and put to work, and the production of concentrate was well under way long before there was even a suggestion of a roof over the building. Weather conditions fortunately were favorable, while the management of the mine was not of the type that is dismayed by obstacles. Tungsten at \$60 per unit and fairly strong is a powerful spur toward strenuous efforts at renewed production.

The camp has no water, so from four to five earloads, each of 10,000 gallons, have to be freighted daily from Kramer, a distance of about 40 miles. The cost per earload is \$18.50. This quantity represents the total consumption of both mill and town; the company furnishes the domestic water-supply, having installed tank-storage and an electrically-driven pump for the purpose. In order to save the enormous waste of water ordinarily incident to wet concentration, an Oliver filter was purchased, for dewatering all the tailing.

The scarcity and high cost of water would indicate

that Atolia is a dry town. As a matter of fact it is, literally, being geographically within the confines of San Bernardino county, which has been 'on the wagon' for some years. Randsburg is the nearest dispensary of the kind of wet goods that comes in bottles and kegs, but, strange to say, there is little visual evidence of over-indulgence on the part of the people of Atolia—in fact, of any indulgence at all. A place on the pay-roll is contingent upon regularity of attendance and performance of duties; wages are good and the 8-hour day prevails; so it would appear that the American workman is beginning to realize that 40 rod whiskey and all-night spees are not the Gold Dust twins that produce either happiness or prosperity. An imposing dignitary, slouch-hatted and starred, stalks around the camp all day in his capacity of representative of the majesty of the law, and if it were not for the high grader, his position would be a sincere indeed.

The high-grader, like the poor, seems always with us. Now that the value of tungsten ores may be expressed in terms of pounds, rather than tons, the temptation is great for the mentally weak to walk off with their shirt-fronts bulging with rich specimen rock. One man was caught red-handed with no less than 180 pounds of high-grade in a sack on his back. A trip at the county expense to Barstow was the result, and the offender will have a few years before him in which to realize that honesty pays.

The names of the adjoining towns would indicate that the original discoverers had spent some time in South Africa. Thus we have Johannesburg, Randsburg, and Rand, all within about ten miles of Atolia. Many of those employed by the Atolia company 'commute' between Atolia, Randsburg, and Johannesburg, by aid of the omnipresent jitney, the handiwork of the great pacifist of Detroit being everywhere in evidence. Round-trip tickets between Johannesburg, or Jo'burg in the vernacular of the native, cost 50 cents. There is a good desert hotel at Johannesburg, for some reason named neither the Palace nor the Grand. It is operated on the Golden Rule plan, by which guests are informed as to rates and then let blissfully alone until ready to depart. Each guest renders a verbal account of his meals and sleeps, pays his bill, and departs. This is no place for the certified public accountant.

The hospitality of the waste places is proverbial, the honesty likewise, and, take it all in all, there is a fascination about the desert peculiarly its own. One morning, three old-timers were sitting outside my bedroom-window, comparing notes on the topics of the day. The conversation switched to the comparative merits of the various intellectual centres of the Mohave desert. After listening to the views of his companions, one old patriarch said, with an air of finality that left no room for doubt, "I have tramped this desert for nigh onto forty years; I bin to Ballarat, Lone Pine, Barstow, and once I was way over to Bakersfield. I bin everywhere in this whole country, and take it all in all, little old Jo'burg is good enough for me."

REVIEW OF MINING

As seen at the world's great mining centres by our own correspondents.

LEADVILLE, COLORADO

ORE PRODUCTION.—MINING LAW.—SILVER, IRON, AND MANGANESE ORES.

Leadville's output is growing at a great rate. During April, approximately 72,500 tons of ore was sent out, an increase of 10,000 tons over the quantity in February. The greater part of the ore is zinc carbonate and zinc-lead sulphide, products which have been rushed onto the market because of the prevailing high prices. The Western Mining Co., shipping 350 tons of carbonate daily, led the individual producers with a total output of 10,500 tons for the month. The Ibox, Garbutt, Yak, Iron Silver, and Star, each produced from 200 to 350 tons per day. The Star dispatched 350 tons of manganese ore. New properties are commencing continually and the district's production is growing accordingly. It is estimated that the output for the year will total over \$18,000,000.

The proposed Federal mining law now pending in Congress is not thorough enough; this is the conclusion arrived at by the Lake County Metal Miner's Association at a meeting held recently for the purpose of considering the measure. The new law would not be complete and would not offer provisions that would entirely remedy the defects of the present statute, and therefore, could not be considered as a desirable change. Additional litigation and court rulings would be required to make the proposed law workable. Copies of the report of the committee on the mining law signed by R. D. McLeod (city attorney), and W. O. Reynolds, Harry Mamlock, H. H. Norton, and John Harvey, well-known mining men, will be mailed to Bulkley Wells, chairman of the Colorado Metal Miner's Association. Other copies will be forwarded to Senator Charles S. Thomas and Congressman Edward T. Taylor, both of Colorado and chairmen of the mining committees in Congress. Among the faults found in the present mining laws, and which are not fully provided for in the pending measure are the apex theory, the procedure of acquiring rights to claims where mineral is not near the surface and where discovery must be long deferred, tunnel locations and the complications arising from them, the law of discovery, the law of assessment, individual privilege for the location of unlimited number of claims, and locations by proxy. Some alteration has been made in the new law which is regarded as an improvement over the existing measure in connection with the above shortcomings, but the improvement is not as great as the mining industry has the right to hope for and expect. Should the proposed measure be adopted in its present form, it will prevent the introduction of a better bill in Congress for a long period, and would cause a new and troublesome era of litigation over new phraseology that has been substituted for language already construed by the Courts. In short, the mining bill does not provide proper legal authority for the requirements of the mining industry. It should be killed in Congress and an ample provision drawn-up without further delay.

Leadville is a heavy producer of silver ore, and the recent advance in price is of importance here. Such properties as the Louisville, Dinero, Yak, and New Monarch secure the greater part of their revenue from the silver in their ores. Every mine in this district, with the possible exception of the zinc properties, produces some silver, and the increased value of the metal will make a material difference in the

settlements. In the Dinero and Louisville, ore is mined that contains as much as 5000 oz. of silver per ton. Iron properties are also reaping the benefit of the high price of silver. In the past it has been difficult to operate these mines, mainly as there was little received for the silver. All the iron produced in the district contains from 3 to 15 oz. silver per ton, and the price offered for the ore has been just sufficient to pay for mining it. Iron operators now are able to develop their properties at a fair profit, with the result that a number of old abandoned iron mines are being re-opened.

The Julia Mining Co., incorporated, with a capital of \$10,000, has purchased the Cloud City and Home Extension properties in the Down Town mining area now being drained through the Penrose shaft. A few men are employed at the Home Extension installing machinery and repairing the shaft, which is 600 ft. Large bodies of iron and manganese are known to exist in the property; these will be re-opened as soon as the shaft work is completed. The Cloud City and Home Extension have been idle since 1907. At that time they were heavy producers of these ores. Trouble in coping with the water and low prices for ore closed the properties. The resumption of activity is partly due to the draining of the ground through the Penrose, but more so to the high prices offered for manganese. The Extension is expected to commence shipping in the next few weeks. Clarence Jarbeau, a retired Denver attorney and well-known Colorado mining man, is the organizer and manager of the new company. Associated with him are Mayer Harrison of Denver and Edwin R. Cooper of Los Angeles.

A well-known Leadville man, W. J. Davis, has organized a local leasing company for the purpose of developing the North Side claims on north Fryer hill. A new shaft is being sunk about a quarter of a mile south-west of the Harvard where the U. S. S. R. & E. Co. is draining the entire section. The territory is rich in iron, manganese, and lead-silver ores.

Cramer & Co., operating the Star No. 5, Waterloo, Yankee Doodle, and Aetna properties on Carbonate hill, have opened the largest bodies of iron-manganese ever encountered in the district. Contracts for the ore have been closed with the Colorado Fuel & Iron Co. at Pueblo, and a steady output of 200 tons per day is made. The properties are also producing a good deal of carbonate of zinc and fluxing iron. With the exception of the Star No. 5, these properties have been closed down for a number of years, and it is only the recent demand for manganese and iron that has brought them back to activity. The Porter shaft on the Star property is also shipping 100 tons daily of manganese ore, this going to the C. F. & I at Pueblo.

WASHINGTON, D. C.

LEASING BILL, OIL RESERVES, MINING LAW

After a delay of several weeks, Senator Phelan of California has written his report to the Senate on the so-called leasing bill for the exploration of oil, gas, etc. It has been ordered out favorably by the Committee on public lands, being a substitute for the Ferris bill passed by the House of Representatives. The Senate's amended bill differs in the main from that of the House through its omission of the section bearing on coal lands in the public domain. It is stated that a separate bill covering the disposition of this point will be presented later

and urged for passage. The omission is a considerable surprise, and it is considered at Washington that it was decided on to help along the passage of the bill, as it has been reported to the Senate by the affirmation of the opposition of the coal men, leaving these to fight their battle separately later and weaker thereby. However, the coal men are fighting more than anything else the principle involved in the blasting idea, and they can combat it as successfully as if it included in its scope coal blasting as well.

The naval oil reserves are also discussed in the Phelan report. It seems to question the good to the Government in burning oil on its ships with the valuable by-products unextracted, and it asks if the Government is not going to perpetrate such waste as it going into the business of refining? The report declares that "the navy should not lay its hands on the legitimate business of the man who located and developed the oil in limited areas, and revealed the wealth of the West to a country now conscious of its greatness." Congress should grant equitable relief to such claimants, the report asserts.

It is however not likely that the bill will receive any immediate consideration in the Senate, especially if it is going to evoke discussion, as it surely will, because the calendar is being crowded with other highly important business, while the summer is coming on fast and Congress wishes to adjourn as early as possible.

The measures in Congress calling for the codification and revision of the mining laws are dormant. The House Committee on mines and mining has done nothing so far with reference to the Foster bill, making the codification. The special sub-committee appointed to study and draft the final proposition has not met once. In the meantime the Committee is receiving a number of communications from mining men and lawyers all over the country in criticism (some of it most caustic) and elucidation of the Foster measure, which has been declared wholly tentative.

JOHANNESBURG, TRANSVAAL

AMERICAN CAPITAL FOR THE RAND.—UNDERGROUND CONDITIONS.

According to a cable from London an American syndicate has been formed to help exploit the Far East Rand. W. W. Mein and Karl Hoffman, both well-known figures on the Rand, are named as the engineers of this syndicate. I had no notion that anything was on the carpet when I wrote my last notes. The syndicate has every chance of doing well, and the promoters are to be congratulated on engaging engineers who have had former Rand experience. An idea that mining on the Rand is a simple stereotyped business, and requires only capable 'muck-shifters,' is one of those fallacies that die hard. Pretty well each mine here has its own peculiarities, and in many cases the mining of the really profitable ore in a banket mine is a more difficult problem than in a quartz proposition. John Hays Hammond is reported to have said "Damn the Rand, I don't want to stay in a country where every office-boy is a mine-valuer, give me a quartz country." Well, the office-boy mine-valuer has not exactly been a success, and much money has been lost thereby. Of course, a quartz mine has chances of enrichment that in a general way a banket one lacks. Profitable, however, surprises are still in store for those who intelligently look for them. At the Bantjes, exploration of the Main Reef Leader long considered no good, is helping to put a handsome complexion on an otherwise unhealthy looking venture. On another mine, whose name I am not at liberty to give, a re-examination of old cross-cuts has enabled the management to locate a profitable orebody from 24 to 30 inches wide assaying 30s. (\$7.20) over an assumed stopping-width of 40 inches. This orebody had been frequently cross-cut at different levels. Here again the mine was nearly closing-down, but is now in a fair way to earn real substantial profits, not paper ones. So even on the older mines the pleasantly unexpected sometimes happens.

The Phthitids Commission has completed its labors and will probably among other things advise that the blasting of ore be confined by law to one single shift. This is quite as it should be, and will both be a real economy and a health preservative. A great improvement on the mines has taken place, as far as phthitids prevention is concerned. Lots more yet requires to be done to weed out the 'slackers.' And the rigid enforcement of single-shift blasting will only be opposed by incompetents or managers forced to push under developed mines. And these deserve no consideration. The Government is taking strong measures against anyone convicted of breaking the dust and



Plans showing the distribution of well-defined patches or shoots of conglomerate in the Far East Rand. (A) Brakpan; (B) Nigel. The dark patches represent stopped areas; in the Nigel these correspond closely with the distribution of the conglomerate, in Brakpan with special areas of conglomerate. The two plans are drawn on the same scale and oriented alike.

..... Outcrop of reef. D = dike.

Scale approximately 1 in. = 1000 ft. (after Mellor).

smoke regulations. In many cases, however, the real offender or cause of the offense escapes. I know a case of a mine manager who took over a section of a big mine, and found tramping shifts working in smoke and dust, the men being sent down before the mine had a chance to clear itself. He called the general manager's attention to this, and suggested an alteration in the time of the shift, pointing out that this would mean a temporary falling-off in tonnage. The reply was "It will be a very serious thing for you if tonnage falls." This manager, wise in his generation, moved to another mine. Now, in this mine, another section was paid a surprise visit by a Mining Inspector. The men were working under the worst conditions possible, owing to the shift going down immediately after, and in some cases before, blasting. An enquiry was held, the general manager claims he knew nothing of the practice; in fact, knew nothing at all about such details. The manager just appointed claimed ignorance too. The mine captain, the least to blame of the three, will probably lose his ticket, and

get fined. This may be an exceptional case; still it is not altogether an isolated one.

There is little excuse even for a section manager allowing anyone to influence him in breaking the law, as he can always report to his board. Nevertheless, an unscrupulous or incompetent general manager can do, and does do, a lot of harm, by indirectly encouraging breaches of the law. Of course, if trouble occurs he pleads ignorance and always gets off scot-free.

The worst abuses occur on the big unwieldy mines that have a large number of officials, with limited powers and responsibilities. In case of trouble, some underling is sacrificed and nothing more is said or done. The best-run and healthiest mines are undoubtedly those, like the Albu group, where there is a manager responsible for everything, and in close touch with his chairman or managing director. Sir George Albu has set a good example by supporting his managers in their efforts to improve health conditions. And he has plainly intimated that any unsatisfactory health reports will hurt the individual manager's standing with the board. The phthisis question is such an important one on the Rand that you will excuse me for dilating on it.

A rather amusing echo of the last strike is being heard in the law-courts. Sir George Albu is being sued by the recently returned deportees for libel. In a speech at the Chamber of Mines soon after the strike he called them "criminals" and apparently added in the "widest sense of the word." Now they are suing him for libel; judgment is not yet given, but no evidence to justify the language was forthcoming, and Sir George by this time should have understood the English language better than to have said what he did. Apparently he wished his remarks to be construed in a "pickwickian sense." German-born though he is, he has sent his son to fight for his adopted country. Good luck to them both.

In the *Journal* of the Chemical, Metallurgical and Mining Society of South Africa for February is given the full text of E. T. Mellor's paper, 'The Conglomerates of the Witwatersrand,' from which the accompanying sketch is taken.

GUADALAJARA, MEXICO

SUBSTANCE OF A DECREE BY THE PRESIDENT OF MEXICO, INTRODUCING IMPORTANT CHANGES IN MINING LEGISLATION.

The new export and import taxes are to be effective from May 1, 1916, and the taxes on mining property, as mentioned in the decree, to be in force from July 1, 1916. Taxes are to be paid in Mexican gold coin. (American money is usually accepted at the rate of 2 for 1.)

Article 1: (A) Metals exported in the form of ore, cyanide products, sulphides, furnace products, or in whatever other form combined or mixed with substances that are not metals properly speaking, as follows: Gold and silver, 10% *ad valorem*. Other metals, 5% *ad valorem*. (See Article 7 transitory.)

The Secretary of Hacienda will fix the value of the different metals each month according to the ruling prices in the foreign markets. (This means New York quotations.)

(B) Metals treated in Mexico to the point that they are only alloyed or mixed with other metals, and whatever may be their grade, are subject to a reduction of 20% on the duties given in preceding paragraph (A).

Article 2: The following are not subject to the Interior Stamp Tax. (In this case meaning not subject to export duties.)

(A) Refined gold delivered to the mint for coinage, or presented in the Government offices in exchange for silver money at the rate of 0.75 gram of fine gold for one *peso*.

(B) Gold and silver money of current coinage whether Mexican or foreign. (Nevertheless risky to attempt exportation of Mexican money.)

(C) Silver in any form, natural or artificial product when the silver is less than 250 grams per ton (1000 kg.).

(D) Gold and silver imported into Mexico, in the form of ores, cyanide precipitate, concentrates, furnace products, etc., for treatment in Mexican metallurgical plants. Within a period of four months after their importation into Mexico.

(E) Gold and silver used in Mexican industries.

(F) Samples of mineral in their natural state. (In lots not exceeding 10 kg.)

(G) Copper in ore containing less than 3% copper. Lead in ore when less than 10%. Zinc in ore when less than 15%. (This applies when an ore or product contains one, two, or three of these metals.)

Article 3: (Referring principally to metals delivered to the Mint.) Costs of assaying are only charged when the work is done at the request of the owner or by legal requirement or by Government order. Costs of melting when bars are not homogeneous, or the cost of parting is to be paid by the owner if he wishes the work done; and at a cost based on the cost of operation of the respective Government offices.

Article 4: Metallurgical establishments are subject to the common laws in all of their operations.

Article 5: Special stamps worth P10 Mexican gold must be affixed to each title to mining property for each *pertenencia* covered by the title, regardless of the mineral substance. (This applies to titles already existing and to new titles that may be taken out.)

Article 6: The annual tax on mining property shall be as follows, for gold and silver properties:

(A) 1 to 10 *pertenencias*, \$6 per year; \$2 every four months.

(B) 11 to 50 *pertenencias*, \$12 per year; \$4 every four months.

(C) 51 to 100 *pertenencias*, \$18 per year; \$6 every four months.

(D) 101 or more *pertenencias* at the rate of \$24 per *pertenencia* per year, or \$8 every four months.

The above amounts are for each *pertenencia* or fraction. (*Pertenencia* is a square 100 metres on each side.)

Properties other than gold and silver:

(A) 1 to 50 *pertenencias*, \$6 per year per *pertenencia*; \$2 every four months.

(B) 51 to 200 *pertenencias*, \$12 per year; \$4 every four months.

(C) 201 to 500 *pertenencias*, \$18 per year; \$6 every four months.

(D) 501 or more *pertenencias*, \$24 per year; \$8 every four months.

(All amounts per *pertenencia* and in Mexican gold coin.)

Article 7: The progressive increase is applicable when the *pertenencias* are of one owner and situated in the same mining district (whether the *pertenencias* owned are contiguous or separated.)

Article 8: State taxes shall not exceed 2% of the value of the product.

Article 9: The following material is free from import duties when for use in the treatment of ores:

Zinc in bars, filings, granulated, shavings, or in small sheets (including large sheets perforated so as to render them useless for other purposes); sulphur, alkaline cyanides, hypsulphite of soda, and nitrate of potash or soda.

Article 10: All payments to be made in Mexican gold coin.

Transitory articles: 7th. The tax of 5% on metals other than silver and gold, mentioned in Article 1, applies to copper when the New York price for that metal is less than 25c. U. S. currency per pound; when the price of copper is 25c. and up to 30c. per pound the tax shall be 6%, and when copper exceeds 30c. American currency per pound in New York, the tax shall be 7%.

(Signed) V. CARRANZA.

Dated Mexico City, May 1, 1916.

THE MINING SUMMARY

The news of the week as told by our special correspondents and compiled from the local press.

ALASKA

JENSEN

During the first 10 days of May the Alaska Gastineau mill has been treating 6000 tons daily, assaying \$1.60 per ton. This is a great improvement over the 94-cent average in April.

On May 11 the Treadwell foundry cast a 5-ton drop-hammer, the largest casting ever made in the North. It is 41 in. high and 12 in. at largest diameter, and is used for breaking large scrap castings for re-melting. On May 29 the Alaska Treadwell company pays 50c a share.

KETCHIKAN

(Special Correspondence.)—About 250 men are employed by the producing mines in this district. Seven copper mines are shipping at the rate of 12,000 tons a month; three gold mines are yielding ore, and a number of gold-copper properties are being developed. The territorial mine inspector, W. Maloney, has just completed an inspection tour of the local mines—F. B. Hyder, mining engineer and geologist for the Alaska Gastineau company is examining gold properties at Sea Level, Thorn arm.—G. M. Fripp has bonded the Cymru mine at North arm.

ARIZONA

COCHISE COUNTY

Renewed activity is reported from the Bowie, Golden Rule, and Whetstone districts, the first two being gold producing areas.

The advance in silver is greatly benefiting the Bunker Hill

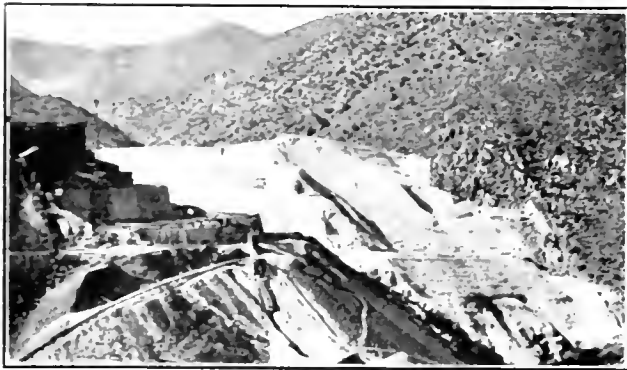

DETROIT COPPER CO.'S TAILING DUMP AT MORENCI, ARIZONA.

property at Tombstone, which has increased its output of ore containing that metal and manganese. Water caused the shutting-down of the old operating company, and the present owners have not bothered much, save to pump 100,000 gal. daily for current use.

GILA COUNTY

At the Old Dominion the A shaft is producing over 1100 tons of ore a day, mostly from No. 12, 14, and 16 levels. The flow of water is now 7,000,000 gal. in 24 hours. The concentrator treats 700 tons, and the flotation plant 300 tons daily. Some fine concentrate is sent to the International smelter at Miami.

Development and production at the Iron Cap is reported as very satisfactory.

When No. 19 and 20 sections are working in the Inspiration mill the plant should treat nearly 20,000 tons daily. The floor area of the whole is 4 acres, against 8 acres needed for a gravity concentration plant of 7500 tons' capacity. In the mine a system of block-signals is to be installed to regulate ore haulage.

MOHAVE COUNTY

In the old Stockton Hill district the Arizona Buttes Mining Co. has acquired 500 acres, developed it considerably, and is now ready to erect a 120-ton mill. Henry M. Crowther is general manager.

CALIFORNIA

AMADOR COUNTY

Following is the preliminary statement of the Plymouth Consolidated for April:

| | |
|-------------------|----------|
| Ore milled, tons | 11,000 |
| Total value | \$59,900 |
| Working expense | 27,136 |
| Development | 4,188 |
| Surplus | \$28,576 |
| Other expenditure | \$ 4,273 |

BUTTE COUNTY

The old Willard placer mine at Magalia has been acquired by S. D. Mesmith and W. E. Young of San Diego from F. H. Dakin. Development is to commence at once. In 1856 a 54-lb. gold nugget was found in this mine, which has been idle for 40 years.

CALAVERAS COUNTY

Farmers of Calaveras and Amador counties, owning 20,000 acres of land, have joined in 34 suits in the U. S. District Court at San Francisco to recover damages of \$300,000 from the Penn Mining Co., which operates a smelter on the border of the two counties.

It is alleged that fumes from the smelter have destroyed crops and stock. The company has replied that it is not the gases that have ruined the crops, but poor farming.

PLUMAS COUNTY

At the Walker copper mine the cross-cut adit is in 500 ft., and at 440 ft. cut what is probably a parallel vein to the main ore-body. The ore shows carbonate, chalcopryrite, and glance.

SAN BERNARDINO COUNTY

Although little has been written about Goldstone lately genuine development is reported, with good results. There are now seven operating companies.

The Atolia company announces that it has shut-down the Parr and East Union mines, releasing 100 men, on account of the poor showing in the bottom workings of these two mines and the collapse in the price of tungsten.

SHASTA COUNTY

From the mine of J. J. Hartigan and H. T. Mecum on Mears creek, 4 miles west of Sims, 40 tons of asbestos has been railed to Oakland for sale.

TRINITY COUNTY

San Francisco and Los Angeles capital, represented by W. B. Winston and C. A. March, has bonded 1500 acres of land

between Lewiston and Pokes Bar on the Trinity river. The average price was \$200 an acre. Keystone drills have been prospecting for some time. One dredge is to be built at once and two later on.

COLORADO

It is reported that leading mine operators in this State are to have an enquiry into wages paid, and a re-adjustment of same, to be fair to all concerned.

GILPIN COUNTY

By means of the Newhouse tunnel the Ophir Burroughs, Pozo-Gilpin, and Gunnel mines are being actively worked. In the near future mines in the Nevadaville and Quartz Hill sections of the county will benefit by drainage through the tunnel.

SUMMIT COUNTY

During April the Breckenridge district dispatched gold worth \$50,000 to the Denver mint. The Tonopah Placers Co. has three dredges at work, and the French company, one. The latter saved a number of small nuggets, one worth \$150, and other coarse gold in April.

The Wellington Mines Co. shipped 1500 tons of zinc ore and concentrate last month. Both mills, with a total capacity of 150 tons, are working. A market has been found for the iron-silver-zinc product, and shipments will be 100 tons weekly.

TELLER COUNTY (CRIPPLE CREEK)

In the first quarter of 1916 the Vindicator Consolidated earned \$225,000 net from 33,086 tons of ore. Developments in its Golden Cycle mine are encouraging.

On No. 19 level of the Portland the No. 1 vein is 6 ft. wide, worth from \$50 to \$125 per ton. Between the lowest workings and the Roosevelt drainage-tunnel there is 200 ft. of unexplored ground.

IDAHO

CUSTER COUNTY

Work has been resumed at the well-known Lost Packer copper mine on Loon creek. Little work is done in winter, but in summer the smelter and concentrator are operated.

SHOSHONE COUNTY (COEUR D'ALENE)

The monthly yield of the Success zinc mine in the Nine-Mile district is 1800 tons of ore. Development at 1300 ft. is good. April profits were \$90,000.

In the Carney copper mine, near Mullan, reserves are estimated at 50,000 tons. Ore is being sent to Tacoma.

The Interstate-Callahan shaft is being sunk 6 ft. daily with three shifts and four men on each.

Approximately \$120,000 was paid to 4000 men in the Coeur d'Alene in the week ended May 13, the largest amount ever distributed for a week.

The Day interests have secured control of the Ray-Jefferson Mining Co. The treasury contains \$100,000 to finance development and equipment. The new 250-ton mill is to be ready by July 15. Development continues good. The same people have also got control of the Basin Mining Co., operating in the Burke district, through their connection with the Hercules company.

MONTANA

LEWIS AND CLARK COUNTY

On account of the increased scale of operations in the Marysville, Rimini, Scratch Gravel, and other adjacent districts, Helena is said to be busier now than for 20 years.

LINCOLN COUNTY

After spending \$40,000 in preparatory work, the Bear Creek Placer Mining Co. has commenced work 18 miles south of Libby. The steam-shovel, screening, and sluicing plant can handle 500 cu. yd. of gravel daily.

SILVERBOW COUNTY (BUTTE)

In the first quarter of 1916 the Davis-Daly company made a deficit of \$27,504. Sale of 4208 tons of ore, producing 278,389 lb. copper and 17,844 oz. silver realized \$42,540. Development cost \$36,981, and mining \$30,856. At 2500 ft. depth the ore-shoot is 380 ft. long as far as developed, with high grade in parts. A Nordberg hoist of 1000-ft. capacity, lifting 3½ tons, has been ordered. Ventilation is a serious problem.

The Tuolumne Copper Co. has increased its capital from 800,000 \$1 shares to 2,500,000 of the same par value.

In the first quarter of 1916 the Butte & Superior Mining Co. had the following results:

| | |
|------------------------------------|-------------|
| Ore treated, tons | 164,500 |
| Zinc content, per cent | 15.692 |
| Silver, oz. per ton | 6.844 |
| Concentrate produced, pounds | 90,242,000 |
| Zinc-content, per cent | 53.122 |
| Extraction, per cent | 92.855 |
| Total cost per ton of ore | \$5.61 |
| Revenue | \$4,623,143 |
| Profit | 3,554,940 |

In the corresponding period of last year the profit was \$1,163,156, and in 1914, \$337,241.

MICHIGAN

THE COPPER COUNTRY

April yields of Calumet & Hecla and subsidiaries are as follows, in pounds:

| Mines | April | Year to date |
|-----------------------|-----------|--------------|
| Ahmeek | 2,158,451 | 7,109,721 |
| Allouez | 929,960 | 3,262,254 |
| Calumet & Hecla | 5,709,434 | 24,073,838 |
| Centennial | 257,790 | 820,899 |
| Isle Royale | 950,580 | 3,768,491 |
| La Salle | 95,863 | 439,646 |
| Osceola | 1,783,470 | 6,444,503 |
| Superior | 385,034 | 1,140,909 |
| Tamaraek | 559,374 | 2,310,780 |
| White Pine | 404,587 | 1,441,417 |

MISSOURI

JASPER COUNTY

In the week ended May 14 ore prices declined in the Missouri-Kansas-Oklahoma field, to an average of \$88, \$71, and \$97 per ton for blende, calamine, and lead, respectively. The output was 7051 tons blende, 424 tons calamine, and 1297 tons lead, worth a total of \$782,093. For 19 weeks the total is \$16,555,409.

NEVADA

ESMERALDA COUNTY

The Florence Goldfield Mining Co. has purchased the flotation plant of the Nevada Metal Extraction Co. to treat Florence's dumps. The plant will be increased to 300-ton capacity. The 50,000 tons of ore assays \$5 per ton; the mine also contains 75,000 tons of \$4 ore. The percentage of copper varies.

The Reorganized Booth company has declared a dividend of 5c. a share for June 6. This makes 35c. in three months, or \$350,000. The money is from the sale of shares in other companies with which the Booth had apex suits.

During April the Jumbo Extension produced 2721 tons of \$29.03 ore, at a profit of \$25,000. Development is yielding good results. A 5-c. dividend has been declared.

LYON COUNTY

The Nevada-Douglas leaching plant has started work, treating 250 tons daily.

At the Thompson smelter of the Mason Valley company, the 10-ton leaching plant, in charge of E. R. Weidlein and G. A.

Bragg has treated 10 tons of low grade oxide ore for a month, and will be doubled in capacity. The Minnesota-Nevada mine owners are sending ore to this plant for treatment.

MINERAL COUNTY

(Special Correspondence.) There is activity in the Reservation district, and several gold, copper, and silver-lead deposits are receiving attention. The Packsaddle mine is worked by Carson City people, with George L. Hedges as superintendent. An adit is being driven along No. 4 vein, showing some free-milling gold ore. It will be extended 800 ft., and is expected to cut three cross veins. Copper ore of shipping grade has been opened, and early shipments are contemplated.

The Mt. View mine is extracting free-milling gold ore through three adits and is working a small mill with water from the Walker river. Profitable ore has been opened to a depth of 200 ft. Some work is being done at the nearby Sebastopol and Reservation Hill mines.

The Yerrington Mountain Co. is shipping copper ore to Schurz, from which point it will be sent to custom smelters. The orebody is 7 ft. wide, with 12 in. of high-grade. A compressor has been installed, and driving from the Azurite shaft is proceeding with machine-drills. The shaft is being arranged for operations from the 500-ft. level.

Reservation, May 11.

The Luning district's mines shipped a total of 2500 tons of copper ore in April, mostly by lessees.

NEVADA COUNTY

During the week ended May 13, Tonopah mines produced 934 tons of ore valued at \$192,678. The Belmont shipped bullion worth \$137,092, and the Extension \$89,000.—The MacNamara mill is expected to resume work in the near future, and may treat custom ore as well as its own.—At a depth of 1200 ft. in its Sand Grass claim the Tonopah company has cut the Murray vein.

STOREY COUNTY

At 2500 ft. depth in the Mexican, and 2700 ft. in the Union, driving north is under way. Stops in the latter are yielding up to \$48 ore. The Mexican mill is again treating ore.—Fair ore is reported on the 2700-ft. level north in the Ophir.—The Jacket mill is kept busy.

NEW MEXICO

SOCORRO COUNTY

On account of the higher price for silver the Mogollon and Socorro companies at Mogollon are netting \$2 extra per ton.

UTAH

All smelters in the Salt Lake valley are at capacity. The lead plants can treat 3000 tons daily, and cannot receive more ore; while the copper plants, of 5000 tons' capacity, are ready to receive ore.

BEAVER COUNTY

On Sunday, May 15, about 50 mining men, brokers, and others from Salt Lake City visited the Star district. The recent developments at the Paloma and Cedar-Talisman were inspected: one is copper and silver, the other silver-lead and zinc.

BOXELDER COUNTY

Working on an extension of the Lakeview company's vein the Lakeview Volunteer Mining Co. is opening 20 to 30% zinc ore at its new camp called Spelter. F. Jardine is general manager.

SUMMIT COUNTY

Park City with its 5000 people is very optimistic as to the future on account of the high metal prices, large ore output, and increased wages.

TOOHEE COUNTY

From the Deep Creek district, near Gold Hill, over \$5000 worth of schreibite is being shipped each week by parcel post by Wilson brothers. Others are busy looking for the mineral.

WASHINGTON

FRANK COUNTY

Present shipments from the Lone Pine-Surprise mine at Republic, which is being worked by the Republic Consolidated Mines Co. are 100 tons daily of \$12 gold ore, to be increased soon to 200 tons. The 300 and 400-ft. level drifts will be extended to the Pearl vein. Work on the double-compartment shaft is progressing satisfactorily and will be continued to the 1000-ft. point. A. J. Laughon is manager. Extensive improvements are under consideration.

KING COUNTY

At Van Asselt the Antimony Smelting & Refining Co. of Seattle has started operating its new smelter. C. M. Philipson is in charge.

OKANOGAN COUNTY

Many minerals, especially antimony, gold, silver, and tungsten are found in this county, and greatly increased attention is being directed to possibilities.

SPOKANE COUNTY

Work in the Loon Lake copper mine, 46 miles from Spokane, has opened a fairly long shoot of high-grade ore at 200-ft. depth, and the mine will be a regular producer in a few months.

CANADA

BRITISH COLUMBIA

There is greater activity and more evidence of prosperity among the mining regions of this Province than ever before, and the current year undoubtedly will establish a new high record of earnings and production for the operating companies, according to Andrew G. Larsen, who is connected with the Lucky Jim Zinc Mines Co., and who recently returned from an extended tour of the different centres.

During the 9 months ended March 31 the Granby Consolidated produced 28,122,261 lb. of copper at its Anyox and Grand Forks smelters. The net income was \$2,373,863. Dividends absorbed \$674,933.

There is said to be an extensive mining area, almost unprospected, east of Hope, within 100 miles of Vancouver. It includes the Coquahalla river country. Two railways now make the district easily accessible, and some promising prospects are being developed.

During March the Standard Silver-Lead company made a profit of \$136,943 from 1295 tons of crude lead ore and concentrate shipped. On May 10 2½c. per share, or \$50,000, was paid.

ONTARIO

One hundred additional stamps are to be erected at the Hollinger mill, doubling the capacity, equal to 4000 tons daily.

Flotation is being tried on tailing at the Trethewey mine at Cobalt.

In April the Nipissing output was \$167,446, from 119 tons of high and 6934 tons of low-grade ores. The refinery produced 708,524 oz. of silver, partly from custom ore. The higher price of the metal now permits of poor ore at several shafts and on dumps being treated.

Tailing value at the Dome Lake is now only 40c. per ton, due to the new cyanide plant.

In *The Canadian Mining Journal* for May 1 most of the space is occupied by interesting and well-illustrated articles and company reports on the operations at Poreupine. There are also notes on the Boston Creek goldfield, Kirkland Lake.

and other centres. The record of the leading producers, as reported to the Ontario Bureau of Mines, for 1915, was as follows:

| Mine | Ore milled, tons | Gold recovered, ounces | Value per ton |
|-------------------------|------------------|------------------------|---------------|
| Hollinger | 334,750 | 156,573 | \$ 9.67 |
| Dome | 317,740 | 73,726 | 4.79 |
| Acme | 106,486 | 49,933 | 9.69 |
| McIntyre-Porcupine | 101,955 | 36,094 | 7.31 |
| Porcupine Crown | 46,419 | 29,032 | 12.92 |
| Tough-Oakes | 26,196 | 26,658 | 21.04 |
| Vipond | 35,899 | 11,871 | 6.83 |

For the whole Province 1,036,387 tons of ore was treated, the yield being 411,588 oz. of gold and 77,126 oz. of silver, with

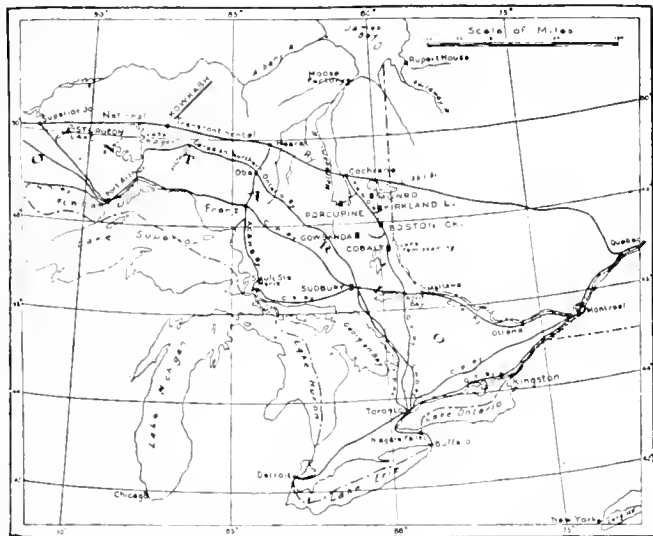

MAP SHOWING POSITION OF PORCUPINE, KIRKLAND LAKE, MUNRO, BOSTON CREEK, AND KOWKASH GOLD AREAS.

a total valuation of \$8,539,887, or an average of \$8.24 per ton. The aggregate value of gold produced in Ontario to December 31, 1915, was \$23,324,389. T. F. Sutherland estimates the gold ore blocked-out in mines operating in Ontario at \$40,000,000. He estimates the 1916 production at \$16,000,000.

YUKON

No. 1 dredge of the Canadian Klondyke company commenced digging on Hunker creek on April 17, the same date as in 1915.

Copper mines in the vicinity of Skagway are being worked full time, shipping ore to Tacoma.

The U. S. Civil Service Commission announces an open competitive examination for mining draftsman, on June 7 and 8. From the register of eligibles resulting from this examination certification will be made to fill a vacancy in this position in the Bureau of Mines, Pittsburg, Pa., at an entrance salary of from \$1020 to \$1200 per annum, and vacancies as they may occur in positions requiring similar qualifications.

The AMERICAN CHEMICAL SOCIETY held its 52nd meeting at the University of Illinois, Urbana, on April 18-21. Over 600 members were registered. A total of 283 papers were presented on all subjects allied to chemistry. Charles A. Herty is president.

The AMERICAN ELECTROCHEMICAL SOCIETY held its 29th meeting at Washington, D. C., on April 27 and following days. The new president is Francis A. J. Fitzgerald of Niagara Falls.

The quarter-centennial of the University of Chicago is to be celebrated on June 2 to 6.

PERSONAL

Note: The Editor invites members of the profession to send him particulars of their work and appointments. This information is of unquestioned interest to our readers.

F. M. MANSON, of Reno, is in town.

G. WOOLCOTT, formerly at Cripple Creek, is at Oatman, Arizona.

T. W. GRUETTER, of Medford, Oregon, is here on dredging business.

R. D. MONTGOMERY of the San Vicente mine, Mexico, is at Los Angeles.

ERNEST J. LOCKE is returning from Oatman, Arizona, to Hollywood, California.

EDWIN E. CHASE and son have returned to Denver from a two weeks' trip to south-western Texas.

EDWIN F. YATES has sailed for the Philippines to take a position with the Colorado Mining Company.

CHARLES B. CRONER is examining the Eldorado Gold Star Mining Co.'s properties at Searchlight, Nevada.

R. T. BAYLISS, according to latest news, is recovering satisfactorily from the injuries recorded in our issue of May 6.

GEORGE E. FARISH has been appointed consulting engineer for the Tri-Bullion Smelting & Development Co., New York.

WILLET G. MILLER and T. F. SUTHERLAND sailed on May 23 by the *Sonoma* for Sydney, on their way to New Caledonia.

CHARLES F. WILLIAMS, lately with the Chino Copper Co., at Hurley, New Mexico, is now at Cananea, Mexico, in the capacity of mining engineer for the Cananea Consolidated Copper Company.

Among those who marched in the great preparedness parade at New York on May 13 were: J. PARKE CHANNING, C. R. CORNING, LAWRENCE ADDICKS, JOSEPH RICHARDS, E. A. SPERRY, BENJAMIN B. THAYER, and W. L. SAUNDERS.

The Nevada section of the AMERICAN INSTITUTE OF MINING ENGINEERS was successfully installed at Reno on May 18. The local section commenced with a membership of over 90. The officers elected were J. W. Hutchinson of Goldfield, chairman; F. C. Lincoln of Reno, vice-chairman, and Henry M. Rives of Reno, secretary-treasurer. An executive committee was selected, composed of nine members, including the chairman and vice-chairman, and John G. Kirchen of Tonopah, Frederick Bradshaw of Tonopah, W. H. Blackburn of Tonopah, C. B. Lakenan of McGill, E. A. Julian of Reno, Governor Emmet D. Boyle of Carson, and ex-Governor Tasker L. Oddie of Reno.

During the proceedings attending the installation, addresses were delivered by Governor Boyle, J. W. Hutchinson, and W. L. Saunders. Charles Butters, Whitman Symmes, and J. C. Jones addressed the section. A discussion ensued. In the evening a banquet was held at the Riverside hotel; in this 40 members and their ladies participated. During the course of the banquet Professor Lincoln of the Mackay School of Mines delivered an illustrated lecture on the 'Evolution of Mining.' On the following day a party of 33, including Mr. Saunders, journeyed to Virginia City by automobile, stopping on the way at Steamboat Springs, where Professor Jones acted as guide to the party. At Virginia City members and their ladies were taken care of by Mr. Symmes and T. F. McCormick, who took them down the Union shaft to the 2700-ft. level and through various workings, emerging from the C. & C. shaft. Luncheon was then served at the Masonic Hall by the ladies of Virginia City, the party being welcomed by Judge Frank P. Langan. Governor Boyle replied in behalf of the Nevada section. Mr. Symmes presided at this luncheon. The party left Virginia City at 4:30 in the afternoon and proceeded to Carson, where they were received at the Governor's mansion by the Governor and Mrs. Boyle, after which the trip to Reno was completed.

THE METAL MARKET

METAL PRICES

San Francisco, May 23

| | |
|---|------------|
| Antimony, 40 lb. per barrel | 37.00 |
| Electrolytic copper, cents per pound | 31 |
| Pig lead, cents per pound | 1.15 8 1/2 |
| Platinum, soft metal, per ounce | \$80 |
| Platinum, hard metal, 10.00 carats, per ounce | \$84 |
| Quicksilver, per flask of 75 lb. | \$20 |
| Spelter, cents per pound | 22 |
| Tin, cents per pound | 50 |
| Zinc dust, cents per pound | 30 |

ORE PRICES

San Francisco, May 23

| | |
|--|-------------|
| Aluminum, 40 lb. per barrel (10 or 20 lb.) | \$2.00 |
| Chromite, 40 lb. per barrel (California) per ton | 12.50 |
| Manganese, 50 lb. per barrel (Silica) per ton | 12.00 |
| Tungsten, 60 lb. per unit | 30.00 10.00 |

At Boulder, Colorado, the Boulder Tungsten Production Co. is paying \$40 per unit for 60 lb. product. Grades under 20% are rejected at the mill. The Primus company is paying \$40 per unit. The Boulder County Producers Association has been formed at Nederland to study the market and fight price manipulations. The stock interests are accused of making profits to suit themselves.

EASTERN METAL MARKET

(By wire from New York.)

Market for tin is quiet and easier, lead is dull and easy, copper is weak and neglected.

COPPER

Prices of electrolytic in New York, in cents per pound.

| Date | Average week ending | | |
|-----------|---------------------|---------|-------|
| May 17 | 29.27 | Apr. 11 | 27.50 |
| 18 | 29.00 | " 18 | 28.25 |
| 19 | 29.00 | " 25 | 28.50 |
| 20 | 29.00 | May 2 | 28.75 |
| 21 Sunday | 29.00 | " 9 | 29.29 |
| 22 | 29.00 | " 16 | 29.50 |
| 23 | 29.00 | " 23 | 29.04 |

Monthly averages.

| | 1914 | 1915 | 1916 | 1914 | 1915 | 1916 |
|------|-------|-------|-------|-------|-------|-------|
| Jan. | 14.21 | 13.60 | 24.30 | July | 13.26 | 12.99 |
| Feb. | 14.46 | 14.28 | 25.62 | Aug. | 12.34 | 17.27 |
| Mar. | 14.11 | 14.80 | 26.85 | Sept. | 12.02 | 17.69 |
| Apr. | 14.19 | 15.44 | 28.02 | Oct. | 11.10 | 17.90 |
| May | 13.97 | 15.72 | 28.88 | Nov. | 11.75 | 18.88 |
| June | 13.65 | 19.77 | 20.67 | Dec. | 12.75 | 20.67 |

Below are given the average New York quotations, in cents per ounce, of fine silver.

SILVER

| Date | Average week ending | | |
|-----------|---------------------|---------|-------|
| May 17 | 77.77 | Apr. 11 | 61.91 |
| 18 | 77.77 | " 18 | 62.42 |
| 19 | 77.77 | " 25 | 63.52 |
| 20 | 77.77 | May 2 | 71.45 |
| 21 Sunday | 77.77 | " 9 | 75.86 |
| 22 | 77.77 | " 16 | 76.10 |
| 23 | 77.77 | " 23 | 74.14 |

Monthly averages.

| | 1914 | 1915 | 1916 | 1914 | 1915 | 1916 |
|------|-------|-------|-------|-------|-------|-------|
| Jan. | 57.58 | 48.85 | 56.75 | July | 54.90 | 47.52 |
| Feb. | 57.70 | 48.45 | 56.74 | Aug. | 54.25 | 47.11 |
| Mar. | 58.01 | 50.61 | 57.89 | Sept. | 53.75 | 48.77 |
| Apr. | 58.01 | 51.75 | 54.37 | Oct. | 51.12 | 49.40 |
| May | 58.21 | 49.87 | 49.12 | Nov. | 49.12 | 51.88 |
| June | 56.43 | 49.07 | 49.27 | Dec. | 49.27 | 55.34 |

The fundamental reason why silver is declining is because Europe is now on a gold basis, the banks' governments holding tightly to their gold.

Given exhausted stocks, 20% expectations, the part of producing mines, and enormous purchases arising from the necessities of coinage, enquiries which can hardly be stayed off—and which emanate from several countries at one time—the situation admits of little or no modification. Any temporary lull in the demand and easing of the price would only serve to encourage speculative interest, and for that reason a reaction, when it does come, may be comparatively small and short-lived, according to Samuel Montagu & Co. of London.

Most of the Cobalt Ontario companies have raised miners' wages 25c. a day from May 1; all employees will receive a bonus of 25c. daily during each month in which the metal averages 70c. or more an ounce.

Silverware has advanced 25% in price in the last three months.

LEAD

Lead is quoted in cents per pound, New York delivery.

| Date | Average week ending | | |
|-----------|---------------------|---------|------|
| May 17 | 7.30 | Apr. 11 | 7.79 |
| 18 | 7.15 | " 18 | 7.76 |
| 19 | 7.10 | " 25 | 7.56 |
| 20 | 7.30 | May 2 | 7.50 |
| 21 Sunday | 7.30 | " 9 | 7.46 |
| 22 | 7.30 | " 16 | 7.43 |
| 23 | 7.25 | " 23 | 7.37 |

Monthly averages.

| | 1914 | 1915 | 1916 | 1914 | 1915 | 1916 |
|------|------|------|------|-------|------|------|
| Jan. | 4.11 | 3.73 | 5.95 | July | 3.80 | 5.59 |
| Feb. | 4.02 | 3.83 | 6.23 | Aug. | 3.86 | 4.67 |
| Mar. | 3.91 | 4.04 | 7.26 | Sept. | 3.82 | 4.62 |
| Apr. | 3.86 | 4.21 | 7.70 | Oct. | 3.60 | 4.62 |
| May | 3.90 | 4.24 | 7.25 | Nov. | 3.68 | 5.16 |
| June | 3.90 | 5.75 | 7.25 | Dec. | 3.80 | 5.31 |

The Federal Mining & Smelting Co., operating four mines in Idaho, pays 1% or \$120,000, on preferred stock on June 6.

A bulletin including notes on the lead production of the Central States in 1916, especially Missouri, with 210,440 tons metal, has been issued by the U. S. Geological Survey.

QUICKSILVER

The primary market for quicksilver is San Francisco, California being the largest producer. The price is fixed in the open market, according to quantity. Prices, in dollars per flask of 75 pounds:

| Date | Week ending | | |
|---------|-------------|-------|-----|
| Apr. 25 | 125 | May 9 | 100 |
| May 2 | 115 | " 16 | 90 |
| | | " 23 | 90 |

Monthly averages.

| | 1914 | 1915 | 1916 | 1914 | 1915 | 1916 |
|------|-------|-------|--------|-------|-------|--------|
| Jan. | 39.25 | 51.90 | 222.00 | July | 37.50 | 95.09 |
| Feb. | 39.00 | 60.00 | 295.00 | Aug. | 30.00 | 93.75 |
| Mar. | 39.00 | 78.00 | 219.00 | Sept. | 26.25 | 91.09 |
| Apr. | 38.50 | 77.50 | 141.60 | Oct. | 53.00 | 92.90 |
| May | 39.00 | 75.00 | 115.00 | Nov. | 55.00 | 101.50 |
| June | 38.60 | 90.00 | 115.00 | Dec. | 53.10 | 123.00 |

On page 796 of this issue will be found some interesting notes on investigation into quicksilver reduction processes.

ZINC

Zinc is quoted as spelter, standard Western brands, New York delivery, in cents per pound.

| Date | Average week ending | | |
|-----------|---------------------|---------|-------|
| May 17 | 15.50 | Apr. 11 | 18.18 |
| 18 | 15.25 | " 18 | 19.21 |
| 19 | 15.25 | " 25 | 18.83 |
| 20 | 15.25 | May 2 | 17.92 |
| 21 Sunday | 15.25 | " 9 | 17.37 |
| 22 | 15.25 | " 16 | 16.35 |
| 23 | 15.15 | " 23 | 15.27 |

Monthly averages.

| | 1914 | 1915 | 1916 | 1914 | 1915 | 1916 |
|------|------|-------|-------|-------|------|-------|
| Jan. | 5.14 | 6.30 | 18.21 | July | 4.75 | 20.54 |
| Feb. | 5.22 | 9.05 | 19.59 | Aug. | 4.75 | 14.17 |
| Mar. | 5.12 | 8.40 | 18.40 | Sept. | 5.16 | 14.14 |
| Apr. | 4.68 | 8.78 | 18.62 | Oct. | 4.75 | 14.05 |
| May | 4.91 | 17.03 | 18.62 | Nov. | 5.01 | 17.20 |
| June | 4.84 | 22.20 | 18.62 | Dec. | 5.40 | 16.75 |

A bulletin including notes on the zinc output of the Central States in 1916, especially Missouri, with 136,309 tons of metal, has been issued by the U. S. Geological Survey.

American Zinc, Lead & Smelting Co.'s net profit in the March quarter was \$2,255,000. Butte & Superior is earning \$1,250,000 net per month. New Jersey Zinc Co.'s profit in the March quarter was \$8,561,385, of which \$6,650,000 was distributed. These three companies are earning a total of \$58,000,000 per annum, equal to \$16, \$56, and \$91 per share respectively.

On June 30 the Interstate-Callahan company of Idaho pays \$1.50 per share, or \$697,485, making \$1,394,970 for 1916, and \$3,952,415 since April 1915. The rate is at 60% on the capital, and 25% on the present \$26 shares.

TIN

Prices in New York, in cents per pound.

| | 1914 | 1915 | 1916 | 1914 | 1915 | 1916 |
|------|-------|-------|-------|-------|-------|-------|
| Jan. | 37.85 | 34.40 | 41.76 | July | 31.60 | 37.38 |
| Feb. | 39.76 | 37.23 | 42.60 | Aug. | 30.20 | 34.37 |
| Mar. | 38.10 | 48.76 | 50.50 | Sept. | 33.10 | 33.12 |
| Apr. | 36.10 | 48.25 | 51.49 | Oct. | 39.40 | 33.00 |
| May | 33.29 | 39.28 | 40.26 | Nov. | 33.51 | 39.50 |
| June | 30.72 | 40.26 | 40.26 | Dec. | 33.60 | 38.71 |

Tin is quiet at 48.50 to 49.50 cents.

Eastern Metal Market

New York, May 17.

Copper continues the most active of the metals, although after a brief period of activity, mostly on foreign account, it is relatively quiet. Prices are firm and forward deliveries a trifle higher.

Zinc has slumped badly and the end is not yet in sight. Buyers are showing no interest at all.

Lead strengthened a little under stimulus of foreign buying, and quotations of the various interests are now fairly uniform.

Tin is easier because of liberal arrivals.

Antimony is down to 32c., against 45c., a few weeks ago. There appears to be an over-supply, while demand is lacking.

Aluminum is quiet but firm.

In tungsten ore there has been a heavy drop in prices, but it is thought to have been checked.

In a broad way it may be said that the peak of the iron and steel boom, with its famine prices and rush to buy, was passed in March. Since then easier prices and deliveries have come to light in several products, though in the main quotations are as strong as ever. Pig-iron has become quiet. This is not surprising in view of the enormous tonnages for which contracts were entered. In metal-working machinery, deliveries are easier, but it is noticeable that as these become better, buyers become more discriminating as to what they buy. These indications are not to be taken as meaning that business is not good. It is very good, but conditions are undergoing a change, as is to be expected with the passing of the hectic war demand. Even though new business is lighter, more normal, the steel mills and metal-working industries are filled with work for the year, and catching-up with deliveries will be slow work.

COPPER

Late last week there was a flurry of activity with a fair amount of buying on the part of France, and to a lesser extent by Great Britain and Russia. Domestic consumers also bought. It led the trade to hope that another large buying movement might be under way, but this did not materialize. The market became quiet again, but prices are firmer than they were a week ago. Although relatively quiet, the copper market is still most active of any. Third-quarter electrolytic can be had at about 28.62½c., cash, New York, or 28.75c., 30 days, delivered. The quotation for June is 29.50c., and for prompt 29.75 to 30.25c. Prompt copper is easier for the reason that considerable re-sale metal is being offered, some of it by manufacturers who over-bought. While brass rods and discs are now much easier to procure than they were a few weeks ago, this is not true with sheet and spinning brass. The brass mills are not receiving any new orders of importance for munitions, but more are in prospect. Third quarter Lake is nominally quoted at 29c. The London electrolytic quotation has continued to advance, and the price cabled yesterday (the 16th) was £158. Exports this month, including the 16th, totaled 9690. The total exports in the first four months of this year were 92,286 tons, against 90,662 tons in the corresponding period of last year.

ZINC

Spelter quotations are on the down-grade, and the trade is wondering when and how the decline will be checked. Yesterday the New York quotation for prompt was down to 15.50c. and that at St. Louis stood at 15.25c. Consumers are holding strictly aloof from the market, and it is conceded that they cannot be interested while the present trend is on. They will not again take hold, in the opinion of the trade, until the decline is checked and is followed by a turn upward. The St.

Louis quotation for June, on May 16, was about 15c.; for July, 14.50c.; and for third quarter, 13.75 to 14c. The lack of new war business precludes any heavy buying by the brass mills, inasmuch as they do not buy to cover such contracts until the business is actually in hand. The London quotation for spot zinc, May 16, was down to £95. American sellers have by no means lost faith in the spelter market, and insist that at least one more up-turn is logical to expect. Exports from May 1 to 16 totaled 2449 tons.

Sheet zinc is lower at 24.50c., carload lots, f.o.b. mill.

LEAD

The dullness of the lead market was broken last week by a moderate amount of foreign buying, and there are still further inquiries before the trade. Much of the buying was of Mexican lead in bond, part of which is to be manufactured here and then exported with the advantage of the drawback duty, while some of it is to be exported in pigs. The foreign activity gave the market a better tone, and the quotation of the Independent producers drew up to that of the A. S. & R. Co.—7.50c., New York. The Independents have been quoting 7.40c., St. Louis, whereas the leading interest is still asking 7.42½c., St. Louis. When prices took on a better aspect the amount of lead that was offered surprised the trade, inasmuch as under such circumstances the sellers usually wait for higher levels. Their action is taken as evidence that they have had enough of inactivity. Exports from May 1 to 16 totaled 2086 tons. The London quotation, on the 16th, stood at £33 15s.

TIN

The market shows an easier trend because of the fairly large arrivals of both Straits and Banca tin. The latter is being freely offered, and is being used by many consumers who formerly considered that Straits was essential for their purposes. On the whole the market has been dull, although on May 15 Western consumers purchased 400 tons, and did not conclude their buying. The quotation for spot on Monday, and yesterday also, was 49.25c. Arrivals of the month up to the 16th totaled 1233 tons, and there was afloat on that day 4520 tons. Government figures show that the imports of tin at Pacific ports in March totaled 774,237 lb. in the San Francisco district, and 4,511,077 lb., valued at \$1,609,743, in the Washington district.

ANTIMONY

It seems almost impossible to interest consumers in antimony, despite the fact that the quotation for prompt Chinese and Japanese grades is down to 32c., duty paid. June shipment from China is quoted at 25c., c.i.f., but this is inactive also. The fact is that there is an over-abundance of antimony on the market and consumers know it, and inasmuch as their supplies are sufficient for the present they are not going to buy when there is a prospect of lower prices.

ALUMINUM

The nominal quotation for No. 1 virgin aluminum, 98 to 99% pure, stands at about 58 to 60c. per pound. An interesting fact with regard to aluminum is that because of its high price and scarcity, several of the automobile manufacturers are abandoning its use and substituting cast iron or some other metal. Some of the automobile makers have surmounted the high prices for all metals by advancing the prices of their cars, and have contracted heavily for aluminum for 1917.

The U. S. Geological Survey has issued statistics on lead in 1915. The yield from domestic ore was 537,012 tons compared with 534,482 tons in 1914, but of much higher value.

COMPANY REPORTS

HECLA MINING CO.

During 1915 this company, which operates a well-equipped mine at Burke and a mill at Gem, Idaho, distributed \$565,000 in dividends. Over 6 years' ore reserves are developed, a total of 1,100,000 tons. The ore averages 9% lead and 5 oz. silver. Last year the output was 24,917,867 lb. lead and 692,444 oz. silver from 112,646 tons treated, also 11,340 tons shipped to smelters. Lead averaged 48656e. per lb., and silver 59.38c. per oz. The income was \$1,934,487. Costs were \$2.548 per ton. The profit was \$461,752. James F. McCarthy is general manager.

MAGMA COPPER CO.

This company operates a mine at Superior Pinal county, Arizona. The known ore-bodies occur in a strong fault-fissure filled with porphyry and cutting diabase, quartzite, and limestone. Development in 1915 covered 5619 ft. A new three-compartment shaft was completed and sunk from the main 200-ft. adit level to 30 ft. below the 1200-ft. level. Work below 800 ft., in diabase, has shown commercial ore on all levels. In the low ground zinc-lead-silver ore has been opened, distinct from the copper ore, there being 10,000 tons assaying 14% zinc, 4% lead and 19 oz. silver. The mill is to be arranged to treat this ore. Other reserves consist of 90,000 tons containing 6.65% copper, 6.75 oz. silver, and 0.029 oz. gold.

The water concentration and oil-flotation plant treated 55,063 tons, averaging 5.21% copper, and 6.04 oz. silver, with 86.76% recovery, yielding 15,039 tons of 16.67% copper and 19.95 oz. silver concentrate. Nine hundred tons of carbonate ore assayed 8.2% copper, 4.55 oz. silver, and \$1.20 gold per ton. The yield of refined copper was 6,046,459 lb., at a cost of 682c. per lb.

Metals sold, including \$208,658 from precious metals, realized \$1,923,876. The operating profit was \$670,886, less \$59,157 for depreciation. Two dividends absorbed \$240,000. The year ended with a balance of \$495,797, compared with \$34,008 in 1914. W. C. Browning is in charge.

ISLE ROYALE COPPER CO.

By the end of August 1915 the three units of the new stamp-mill, to replace the burned plant in December 1914, were treating 2000 tons of ore daily. Everything is motor-driven, power coming from a 600-kw. low-pressure turbo-generator. During the erection of the plant ore was sent to the Franklin and Tamarack mills. Wages were raised and bonuses given during 1915. Development totaled 14,346 ft., against 9694 ft. in 1914. The deepest shaft is 3211 ft.

Results were as under:

| | 1915 | 1914 | 1913 |
|---|-------------|-----------|-----------|
| Ore hoisted, tons..... | 799,890 | 541,373 | 371,774 |
| Waste discarded, per cent. | 15.9 | 12.4 | 15.4 |
| Ore treated, tons..... | 680,270 | 474,349 | 314,679 |
| Copper per ton of ore, pounds | 13.7 | 13.9 | 13.2 |
| Refined copper yield, pounds, | 9,342,106 | 6,601,235 | 5,887,600 |
| All costs, cents per pound, | 14.94 | 13.65 | 18.81* |
| Revenue from copper, | \$1,715,251 | | |
| Silver sold | 38,974 | | |
| Profit | 489,277 | | |

*Of this cost, 14.94c., nearly 2c. per lb. was the expenditure of \$183,293 on re-building the mill, and charges at shafts. Assets include cash \$394,265, metals on hand \$790,524, and supplies \$135,865, a total of \$1,220,654. Current liabilities total \$856,164. With the balance from 1914 and the 1915 profit the surplus is \$1,339,848.

MINING DECISIONS

MINERAL LEASE FROM ONE CO-TENANT—EFFECT OF PARTITION.

One who leases mineral rights from one of several co-tenants of a certain tract is not entitled in a subsequent partition suit to set up any claim in kind as against all the co-tenants. The lease will automatically expire when partition takes place. The right of the lessee to share in the lessor's portion of the proceeds of the partition sale was not passed on in this case.

Spence v. Lucas (Louisiana), 70 Southern, 796. February 7, 1915.

OIL AND GAS LEASE—COVENANTS

In an oil and gas contract which amounts to a conveyance of an interest in the land, and not a mere rental contract, the agreement of the original lessee to pay 50 cents per acre for a six months' extension of time for beginning operations is not a covenant running with the land, and is therefore not binding on an assignee of the contract. A reservation of title to one-eighth of the gas and oil is a covenant running with the land.

Pierce Fordyce Oil Association v. Woodrum (Texas), 183 Southwestern, 12. February 19, 1916.

OIL LEASE—EFFECT OF CONVEYANCE OF LAND LEASED

A deed conveyed certain oil and gas lands with a reservation of royalties under an existing lease. Prior to the expiration of the lease the grantee renewed it for a period of years upon stipulated rentals. Held, upon suit by the grantor against the grantee for a recovery of equivalent royalties that there was nothing on which his claim could be based, as no well has as a matter of fact been drilled, and no royalties due to anyone; and that the grantee had acted within his rights in renewing the lease.

Bond v. Priest (West Virginia), 88 Southeastern 111. February 29, 1916.

MINING CORPORATIONS—FEDERAL INCOME TAX

Mining companies are not denied the equal protection of the laws, nor deprived of their property without due process of law, contrary to the Constitution by the Federal income tax provisions which limit the deduction for depletion of ore deposits to 5% of the gross value of the yearly output at the mine, or by the provisions which give certain individuals and non-profit organizations exemption from various provisions of the act which are made to apply to corporations alone. The tax in question is held to be in the nature of an excise tax and not a property tax.

Stanton v. Baltic Mining Co. (U. S. Supreme Court), 60 U. S. L. Ed., 278. February 21, 1916.

PROSPECTING RIGHTS UNDER THE LOUISIANA CODE

Held, that under the laws of Louisiana the right to prospect and explore for oil and gas is an incorporeal right which may be conveyed by the landowner, without obligating the grantee to drill wells or perform any other condition than the payment of certain rentals. Nor will the Court inquire as to the sufficiency of the considerations where rentals substantial in amount are called for.

Saunders v. Busch-Everett Co. (Louisiana), 71 Southern, 153. February 21, 1916; 70 Southern, 78, February 7, 1916.

Note: It is interesting to observe this late expression from the Louisiana Supreme Court as a principle which has long ago been regarded as established in practically every other State.



EDITORIAL



T. A. RICKARD, Editor

JAMES J. HILL was not only a railway 'magnate,' he was a railroad builder; he was not only a financier, but a pioneer of industry; not only a rich man, but a useful citizen. Few men employed their wealth so beneficently. These to his memory.

THE purchase of three ore-carrying vessels, of 6500 to 7000 tons apiece, by parties allied with the Guggenheims is reported from New York. Two of them are to be used in South American business, aiding the Chuquicamata and Braden mines; the third will carry supplies of metal to Europe.

METAL markets reflect peace talk, re-sales of supplies bought on a rising market, and timidity concerning the immediate future. Our weekly report will be found interesting. It expresses the opinion of one detached from the metal-selling brokers and speculators. Foreign buying has been less in evidence, especially in lead and zinc. We expect a recovery when peace rumors have faded into the smoke of renewed battle. The time for peace is not yet.

A QUESTIONNAIRE circulated among 4500 men of affairs throughout the country elicited replies from 1710, of whom 696 favored military intervention in Mexico and 653 were opposed to it; protection of American citizens in foreign countries was deemed essential to the extension of trade by 1155 and non-essential by only 181; that business would be directly affected by peace in Europe was the opinion of 728, while 750 said No; 'preparedness' was endorsed by 1306 and opposed by 78 only.

SPEAKING of the apex law, it is unfortunate that American engineers were influential in getting the extra-lateral right embodied in the Rhodesian code for locating mining claims, instead of copying the Mexican and Australian regulations. In consequence, the Globe & Phoenix Gold Mining Co. is having a severe dose of litigation with its neighbor, the Amalgamated Properties of Rhodesia, in regard to its right to follow a lode beyond the side-lines vertically extended. As the workings already reach to 21 levels, on veins that join or cross each other at intervals, it is easy to imagine the tangle of fact and theory developed by the law-suit. Incidentally, the suggestion was made, by one of the parties to the case, that an independent engineer be sent to Rhodesia by the Court to advise concerning the facts in dispute. This suggestion was opposed by the other side, presumably on account of uncertainty as to what

engineer would be selected for the task. Of course, all expert witnesses ought to be 'independent,' that is, chosen and paid by the Court. That is a reform urgently needed in this country also.

FLOTATION is to be used on a large scale at Goldfield, as is indicated in the review of mining in Nevada contributed by Mr. R. L. Richie. The copper content of the ore in that district favors flotation, because payment for copper at nearly 30 cents per pound goes a long way to meeting the cost of marketing the concentrate. At Tonopah, however, the ore is relatively free from copper and other cyanicides, save in one stop in the Tonopah Extension mine, where an ore unusually rich in copper is exposed. While an extraction of 90 to 92% by flotation is practicable on sulphide ores, the marketing of the concentrate represents 10% of the assay-value, making the net return 81%, while from the extraction by cyanidation—also 90 to 92%—only 1.6% has to be deducted for the cost of marketing bullion. In other words, flotation is a concentration process, cyanidation a process of direct extraction.

AMONG the great mines uncovered during the present decade the Hollinger, at Poreupine, takes an honorable place, not only for its dividends but for the high character of its management. We note that this enterprise is to be enlarged by a consolidation with the Acme and Millerton mines, of which the former produced \$900,000 in 1915 as compared with the Hollinger's output of \$3,000,000. The Millerton is a smaller property near-by. It is estimated that the ore reserves of the Acme and Hollinger, to 800 feet in depth, will amount to 5,594,570 tons containing \$48,196,390 in gold. But the diamond-drill has proved that several of the veins continue ore-bearing to 1400 feet in vertical depth, so that the possibilities of production are about twice those already proved probable. The improvements now being made in the mill will give it a capacity of 1900 tons of ore daily, and an extension of the plant as planned for the next year will increase the capacity to 3500 tons, equal on average ore to an output of about \$25,000 daily.

CHINESE coins in bulk have been melted by the Japanese in order to make the most of the high price now being paid for the copper and zinc they contain. The Chinese government has prohibited the export of this currency, but the embargo is evaded by melting the coins in China and shipping scrap metal to Japan. The coins are mostly of very small denomination, because the trifling individual purchases of a dense population,

in a country where the majority of the inhabitants are poor, require a great proportion of minor coins. Many of them have a square hole in the centre, both to economize metal and to facilitate stringing them on a belt for wearing around the body. The *li* contains 25% zinc and 75% copper, when melted, such coins to the face value of 27 *yen* Japanese will yield, at the present high price of metals about 12 *yen* worth of zinc and 29 *yen* worth of copper. A *yen* is equal to half a dollar. The operation therefore is profitable. The recent export of copper and copper products from Japan to Russia has far exceeded the rate of production of the Japanese mines. The difference is said to have been supplied by the melting of Chinese coinage. We note that the demand for copper in Japan has led Japanese committees to visit Australia to arrange for purchases there.

IN the advertisement annex of our last issue we note two pages of reading matter. We happen to know about the subject therein discussed because Mr. R. W. Sloan came to us complaining of a reference made to his company, without the mention of its name, in a contribution to discussion. We told him that it did not seem proper to give much space to an incidental question not related to mining, so he said he would pay for the requisite space to obtain the publicity that he desired for his explanation. No line of reading matter being for sale, we introduced him to the department of advertising, where no space is gratuitous. The episode is worthy of mention because we find many people not fully aware of the value of publicity and of the proper way to obtain it. 'Write-ups' and 'reading notices' we abhor; they are sneaking impositions on the reader—not to mention the publisher—and therefore they irritate rather than interest him. It is sound business and it is good sportsmanship to buy publicity where it is for sale honorably and where the reader is prepared to give it respectful attention. The ante is part of the game.

‘COMMERCIAL ORE’ and ‘commercially mineralized’ are terms coming into frequent use in the West. They constitute contributions to current jargon and in no way enrich the language of technology. ‘Commercial’ means relating to ‘commerce,’ which is the exchange of products. A mineralized mass in the ground is not the subject of commerce because it is not exchangeable until it has been mined and otherwise submitted to preliminary treatments, usually of great complexity, as, for example, that undergone by an ore of copper before the refined metal is finally made ready for the market. A commercially mineralized mass is a mass of metalliferous rock that can be exploited profitably; in short, it is ‘ore,’ neither more nor less. The use of the adjective ‘commercial’ was introduced by verbose reporters and illiterate promoters, it is pure jargon, and should be taboo among engineers and others desiring precision. It all comes from the misuse of the word ‘ore’; the application of it to what is not ore, in untechnical prospectuses and flamboyant reports. If we

could school ourselves to use such basic terms as ‘ore,’ ‘cost,’ and ‘profit’ thoughtfully and accurately, we should, merely by so doing, kill a whole lot of chicanery, tomfoolery, and misunderstanding in mining affairs.

DISCUSSION this week includes a friendly endorsement of Mr. Burch's idea, for helping American boys in the mine, from Mr. D. M. Folsom, Professor of Mining in Stanford University. Mr. H. L. Layng contributes some interesting notes on a subject of timely interest, namely, the cyanidation of flotation concentrate, bringing out the point that oil is not the cyanicide but ferrous salts made by oxidation of pyrite. Mr. John B. Platts writes concerning the geology of Oatman, supplementing the articles by Messrs. Howard D. Smith and Frank H. Probert previously published by us. He argues that the gold-bearing ore in that district is a primary deposit from ascending solutions, indicating therefore that processes of secondary enrichment have not played an important part. Against this, however, is the fact that the richer orebodies do not outcrop, having been cut at depths between 300 and 500 feet. We understand that the water-level is between 200 and 350 feet below the surface and that no sulphide, or pyritic, ore has been found in the Tom Reed mine down to 1185 feet. Apparently, as is not uncommon in the desert region, oxidation extends to a considerable depth.

FOREIGN domination of American metal continues to receive attention. The Federal Trade Commission in a recent report states that “for years the copper trade of the world has been ruled by a vast German metal-buying organization centred in the Metallbank and Metallurgische Gesellschaft of Frankfort on the Main.” Yet the United States produces more than half the world's output of copper. As regards silver, this report says that “four London firms, known as the Fixing Board, daily set the price of silver for the world.” Yet the United States produces 30% of the world's annual production of that metal. The Commission concludes that “these foreign combinations constantly make the individual American producers bid against each other, and are thus able to buy at prices near or below the cost of production. By similar means and the manipulation of the foreign future markets the German metal-buying combinations over a series of years have bought millions of tons of American copper at prices averaging nearly a cent per pound below the prices paid by American consumers.” Finally, this report gives a warning: “If American business men are to make the most of the great opportunity now before them, are to build securely in foreign trade, and are to avoid disaster in the shock of the stern and determined competition that will doubtless follow the War, they must at once perfect the organization demanded by the conditions of international trade.” We do not apologize for the number of these quotations, they come from a source compelling respect, and they deal with a matter of vital moment. As we have suggested before, the American

Institute of Mining Engineers or the Mining and Metallurgical Society of America could do a signal service to the mining industry by appointing a committee to investigate metal-selling methods at New York. They could gather a great deal of information of practical value to mine operators and they could prepare the way for the establishment of a real Metal Exchange.

FIFTY years of mining activity on its lands is to be celebrated by the Calumet & Hecla company of Michigan, although the present corporation was not organized until 1871. The Quincy mine at Hancock, whose pure copper is famous for the making of melodious church-bells, was in operation before the Calumet & Hecla lode was discovered, as was the old Huron mine at Houghton, now the Isle Royale. But the greater activity of the early days of copper mining on Keweenaw peninsula was centred northward on the point around Eagle River, ten miles beyond Calumet. In those days, before the railroads, the copper concentrate was loaded into boats along the shore of Lake Superior for shipment to Detroit. It is in this historic part of the district that Mr. Thomas F. Cole has been acquiring large holdings of land for exploration by the Keweenaw Copper Company. Much interest is being taken in the recent acquisition, by the same group, of the 1880 acres belonging to the Seneca Copper Company, lying north of the successful Ahmeek and Mohawk mines. Mr. W. J. Uren has stated in a recent report that the land contains the extensions of the Calumet & Hecla, Kearsarge, and Allouez conglomerates, and the Osceola, Pewabic, and Kearsarge amygdaloid lodes. These efforts to revive copper mining in an old district are rendered peculiarly interesting by the fact that the locality was the boyhood home of Mr. Cole, as of several other mining men with Cornish affiliations.

The Purchase of Machinery

At a recent meeting of the Engineers' Society of Western Pennsylvania, Mr. George A. Orrok, a mechanical engineer in the employ of the New York Edison Company, contributed some interesting remarks on this subject. "The purchaser of large machinery," he said, referring to a typical case of an engineer acting for a company "must be as broad as is consistent with his knowledge, reasonably quick in making decisions, and of judicial mind. Such an engineer will not take up fads, and will not be frightened by cost in block, knowing that it is cost per unit of output that counts in the result." According to Mr. Orrok, there are three principal methods for the purchasing of large machinery. The first he calls the 'English' method, the second may be styled the 'American,' while the third is a combination of the other two, and is stated by Mr. Orrok to be the best.

In the first method, "the purchaser's engineer prepares detailed plans and specifications on which bids are

taken, an award is made, and the successful bidder builds the apparatus." This places responsibility for everything but material and workmanship upon the purchaser's engineer, who is therefore unhampered by any consideration other than that of designing apparatus to meet the requirements exactly. This course, however, adds enormously, and in the majority of cases unnecessarily, to the first cost, because new patterns and drawings must be made; moreover, it involves 'taking a chance' upon the skill and experience of the engineer as a designer of apparatus upon which he may not have specialized to the same extent as the manufacturer.

The second, or American way, so-called, is to place the responsibility plump on the manufacturer. The purchaser, or his engineer, furnishes a specification "setting forth the conditions of the problem, the end to be sought, and the sizes to be observed." In addition, economies, with guarantees as to performance and delivery, are required, as well as the customary bonus-and-forfeit clauses. This method, according to Mr. Orrok, "usually secures a machine not quite fitted for the work and a set of construction details adapted from some other type of apparatus. The minor economies may be up to guarantee, and usually are, but the over-all economy is not secured in the way it should be. The manufacturer will likely furnish apparatus not quite up to the state of his art, as he will be afraid to use his latest knowledge to any extent for fear it will not please the purchaser." As to the third method for the purchasing of large machinery, "it should be borne in mind that the best engineering is one man's work, although he should have many advisers." In the combination method, this end is achieved as follows: "The purchaser's engineer prepares a skeleton specification on which a series of consultations take place, in which the entire problem is gone over with the engineers of the various bidders. During these consultations, the specification undergoes changes, and is added to until it is no longer a skeleton. Sometimes only one bidder may be selected, or it may even be found necessary to start all over again."

Anybody even slightly familiar with American manufacturing conditions will perceive at once the extravagance of the first method. Every engineer is to some extent a faddist, and loves to ride his own hobby. There are comparatively few engineers in private practice to whom could be entrusted the design of large machinery, meaning apparatus costing over the \$100,000 mark, and of those the majority are under retainer to the big corporations. The design of large machinery, as well as of small machinery is a highly developed specialty: it is a branch of engineering requiring knowledge of every department of manufacture as well as familiarity with the conditions to which the machinery is to be applied after manufacture. The average consulting engineer or advisor to the operator is seldom a manufacturing specialist, and when he attempts to act for his clients in any direction away from his specialty, the odds are all in favor of his making a blunder. Any departure from

established standards adds enormously to the manufacturing cost, in fact, many machinery houses will decline to make special apparatus of any kind unless the consideration is a large one. For the purchaser's engineer who insists upon trivial or inconsequential changes we have nothing to say, except that he exists in every community, and is a nuisance alike to the manufacturer and the operator. The second method is better than the first, but not very much. This is what is commonly called by the consulting engineer, "machinery house engineering," by which the buyer is popularly supposed to succumb to the wiles of the smooth-tongued sales engineer and buy a lot of stuff that he does not need, or that proves with use to be unsuited to the conditions of operation. We need not discuss this method. The third, as Mr. Orrok says, is the only rational one, whether in the purchase of large or small machinery. The more skilled the engineer for the purchaser, the more carefully he examines into the characteristics of standard apparatus in order to be sure that existing designs are not suited to his conditions before attempting to devise something on his own account. The engineer exerts a necessary check upon the manufacturer, for manufacturers also are faddists, and each has something 'exclusive' with himself that he is pushing as hard as he can, and which he is sure possesses merits that are not to be found in the apparatus made by his competitor. Taking them as a class, manufacturers have a keen sense of responsibility, and will go to great lengths to ensure the selection of the right apparatus by the purchaser. When things go wrong, it is, in the mind of the purchaser, invariably the fault of the manufacturer, in which opinion the purchaser's engineer enthusiastically joins him. Knowing this, the wise and experienced manufacturer takes care to fortify himself throughout all the steps of a negotiation, and will not become responsible for the performance of any piece of apparatus except as specifically stated in the contract. Blanket guarantees are not made by the initiated; a crusher is never guaranteed to crush so many tons per hour, but so many tons per hour to pass a ring of specified size and having a definite power consumption under these conditions. In matters of this kind there has been a steady growth of common sense, the product of experience and a realization of the fact that good business must be mutually profitable.

Molybdenum and Tungsten Steel

An erroneous impression prevails that molybdenum is being much sought at the present time as a substitute for tungsten, and in consequence there has been excessive activity in the search for deposits of that metal. About ten years ago molybdenum was tried fully by progressive steel-makers in this country, and an encouraging degree of success was attained, but the price of the raw material mounted so rapidly as to become prohibitive, the output of pure ore and concentrate being insufficient to supply an active market at figures stimulative to a

continuance of the demand. Another factor of importance was the existence of the Halcomb patent—issued in 1903—which completely controls the manufacture of the best grades of molybdenum steel, the range covered by this patent being the use of quantities of molybdenum from 6 to 15% in steels containing under 1.2% carbon and less than 2% silicon, as well as covering the use of chromium in practicable amounts in conjunction with steels of the composition specified. The right to use this patent, enjoyed by the Crucible Steel Company while Mr. Halcomb was president of that corporation, gave promise of creating a demand that would have necessitated further study of the metallurgy of molybdenum to overcome the difficulties and high cost of refining in order to make it available in competition with tungsten. On the retirement of Mr. Halcomb from the Crucible Steel Company the validity of the patent was tested, and the decision sustained the rights of the patentee. Since then the only use that American steel-manufacturers have been able to make of molybdenum has been in alloys not covered by that patent, and such uses represent only an unimportant consumption. In England molybdenum is employed to a small extent, but the use of it is not general, and during the present war the British Admiralty has rejected offers of the metal from many parts of the world. The commandeered Australian supply has been adequate for home needs. The French have made a thorough study of molybdenum-steel, and they make large quantities regularly. The Germans also have developed the practice of steel-hardening with molybdenum to a degree equaling that of the French. The oft-repeated statement that a given quantity of molybdenum will harden twice as much steel as the same quantity of tungsten is only partly true. In the finished steel products of equal efficiency such a ratio between the two hardening metals, as shown by analysis, is approximately reached, but a wastage of molybdenum takes place in the process of manufacture, making the actual consumption, to obtain similar results, about equal. As a substitute for tungsten, therefore, molybdenum must enter the market on a basis of even competition as to price, and in normal times the actual selling-price of tungsten in the form of ferro-tungsten is about 65 cents per pound for the contained tungsten. Molybdenum must accordingly be placed on the market at about 65 cents per pound in the ferro-compound, and it must show no trace of copper, lead, or arsenic, while the phosphorus may not exceed 0.03%. The remarks of Gin in his treatise on the rare metals are still applicable: "The manufacture of steel will absorb easily and voluntarily a considerable quantity of ferro-molybdenum if the price is kept at acceptable figures. The ores should be better exploited on a large scale, creating a stable market and a steady foundation for the industry." Upon the expiration of the Halcomb patent the use of molybdenum in America is certain to receive a sudden stimulus, since that metal is more abundant than tungsten, and the exhaustion of the richer tungsten deposits will maintain tungsten at a higher price than before the War, except in the face of a rival.



DISCUSSION

Our readers are invited to use this department for the discussion of technical and other matters pertaining to mining and metallurgy. The Editor welcomes the expression of views contrary to his own, believing that careful criticism is more valuable than casual compliment.

The American Boy and the Mine

The Editor:

Sir—In your issue of May 13, Mr. Albert Burch discusses the future supply of trained miners and advances the suggestion that schools be established in mining centres where, with the co-operation of the operating companies, the younger employees should have an opportunity to study the theory of mining and its practice in other districts. I wish to express my hearty approval of this suggestion and to offer on behalf of the mining department of Stanford University any possible assistance which can be given to the initiation of such a plan into actual practice.

There may be some question as to the amount of practical assistance that any mining school can give to such a scheme, but the co-operation Mr. Burch suggests in planning a course of study and in recommending young graduates who will have the experience and judgment to conduct such courses, can certainly be given. Also wherever the mining districts are within reach of a university certain members of the teaching staff of the mining school will be glad to give their aid, at least in starting instruction. The lectures which they may give to the men from underground will necessarily be simpler and more elementary than those given in the university class-rooms, but the enthusiasm behind the work will be no less. The idea of the modern university is service to the community. This is well exemplified in the School of Agriculture at the University of California.

If the mining schools of this country can be of real service to the mining profession by helping in the training of shift-bosses, foremen, and superintendents, and through helping to provide such opportunity encourage American boys to follow mining, then that is part of their mission.

D. M. FOLSOM.

Stanford University, California, May 14.

Cyaniding Flotation Concentrate

The Editor:

Sir—In reference to an article by Mr. Paul W. Avery appearing in your issue of May 6, I offer the following suggestion:

It is quite possible that the great difference in the amount of cyanide consumed between the tests run on raw (oiled) flotation concentrates and those run on alkaline-treated and water-washed flotation concentrates

is not due to the oil being a cyanide but to a cyanide, such as a ferrous salt, contained in the concentrate. In flotation the concentrate is coated with a film of oil that would prevent the oxidation of a ferrous salt contained in the so-coated concentrate; upon treating such a concentrate with an alkaline cyanide solution the ferrous salt would be free to react with the cyanide to form ferrocyanide compounds, thereby causing a consumption of cyanide relative to the amount of ferrous salt present. Treating the concentrate with alkalis and washing would cause the removal of the oily coating from the concentrate, thereby permitting oxygen present in the water or atmosphere to react with the ferrous salt to form a ferric salt, which, in the presence of caustic alkalis, would be ferric oxide. This does not react with cyanide, therefore such an alkaline-treated concentrate would not cause a material loss of cyanide through the formation of ferrous-cyanide compounds when it is subsequently treated by a cyanide solution.

The concentrate produced by a concentrating table is considerably oxidized during the process and it is also considerably washed, which would cause removal of much of the soluble ferrous salts; therefore, such a concentrate so produced would consume less cyanide than an otherwise similar concentrate produced by oil-flotation. The actions of ferrous salts corresponding to my suggestions are shown in the following tests, which I made on an ore containing both ferrous sulphate and ferrous sulphide. The dry crushed ore was divided into three equal parts. Part *A* was treated direct with cyanide solution containing lime; part *B* was treated with water and lime for three minutes by air-agitation, then lump cyanide equivalent to the amount contained in lot *A* was added to the test; part *C* was washed with alkaline water, then treated with cyanide and lime solution as in the case of lot *A*. All three parts were subjected to 24 hours air-agitation, lime and cyanide being added to maintain all three solutions at the same strength. The results were that in lot *A* the formation of ferrous-cyanide compounds (both soluble and insoluble) caused a consumption of 45 lb. KCN; in lot *B* the same cause resulted in a 0.2 lb. KCN consumption; and in lot *C* the same cause resulted in a 10 lb. KCN consumption per ton of ore. The consumption of cyanide due to other causes that were actually determined are not included in the amounts above given. The figures are based on the actual cyanide found in the form of ferrous cyanide in the solution and ferric or ferrous cyanide in the tailings.

In the particular case quoted by Mr. Avery, ferrous salts may not have been present, but other cyanicides that could be overcome by oxidation, alkaline treatment, and washing may have been present. I only offer the foregoing suggestion as a means for citing a possibility, and I believe it is worth consideration.

H. R. LAYNG.

San Francisco, May 10.

Geology of Oatman

The Editor:

Sir—I have had occasion to read a number of reports and articles on the geology of the Oatman district, and so far have found no two writers who agree on the essential points. The following notes are from careful observation in the field.

The basal formation of the district is a pre-Cambrian complex consisting of granite, gneiss, gabbro, and many variants of these and their related schists. Lying unconformably on the basal complex is a series of Paleozoic sediments consisting of highly metamorphic limestone and shales. This formation is usually tilted at high angles. It was subjected to a long period of erosion and only fragments are left.

Lying unconformably on the Paleozoic limestones is the Older Andesite, which is a series of andesitic tuffs and breccias laid down, in part at least, under the sea. This is shown by the fact that in some places limestone and lime-shale are found bedded with the Older Andesite. An occurrence of this kind may be seen near the shaft of the Gold Range mine.

The Older Andesite dips eastward at from 15° to 20° . The upper surface is one of erosion and is extremely irregular, indicating the existence of a hilly landscape before the pouring out of the overlying lavas. In general, this erosion surface has much less dip than the bedding-planes. In the upper layers the tuffs and agglomerates give place to lava-flows with intercalated beds of tuff. A good example of this phase may be seen at the Oatman Leader mine.

The original structure of the Older Andesite has been greatly obscured by metamorphism induced by later intrusives and crustal movements. The rocks have been partly re-crystallized and have developed marked porphyritic structure.

Above the Older Andesite is the "Green Chloritic Andesite" of Schrader, and regarded by him as an intrusive. Flow structure and amygdaloidal bands are observable in this formation in many places, indicating surface flows. It is undoubtedly intrusive in the Older Andesite in places, since it had to pass through the older formation in order to reach the surface. Hence the Green Chloritic Andesite is probably an extrusive, that is, a series of andesitic lavas poured out through fissures in the Older Andesite and covering the then surface in the neighborhood of Oatman. This formation is quite thin a short distance west of the town and appears to grow thicker toward the east. Since its lower contact

is extremely warped, it is impossible to predict the thickness of it at a given point. However, it does not seem probable that the total thickness is anywhere over 400 feet.

Lying unconformably above the Green Chloritic Andesite is another series of andesitic lavas having a more acid composition and grading into latites. These are known as the Later Andesites. They dip eastward at about 4° . Above these, and conformable with them, are flows of rhyolite that in most places cap the summit of the Black range.

Extensive fissuring and faulting accompanied the volcanic activity, and many dikes being formed corresponding in composition with the various lava-flows. Thus the older dikes are andesitic in character and do not cut the Later Andesites. Dikes of buckskin-colored rhyolite are a prominent feature of the landscape and they cut everything but the upper rhyolites.

The most important ore-producing veins, such as those found in the Tom Reed, United Eastern, and Big Jim mines, are found in a complicated series of fissures extending along the base of the range in a north-westerly and south-easterly direction. Part of these fissures strike nearly $N45^{\circ}W$, and others strike about $N60^{\circ}W$. This relation produces many intersections and large ore-bodies are found near many of the crossings. The veins all dip steeply to the north-east in this belt.

The vein-filling was originally calcite and contained little gold. Later activity, probably induced by the rhyolite intrusions, re-opened the fissures and part of the calcite was replaced by quartz with some adularia. The gold occurs principally in hematite (pseudomorphic after pyrite) in the quartz.

The larger orebodies are not found on the surface but appear at depths between 300 and 500 ft. Some geologists have reasoned from this that the gold has been leached from near the surface and deposited as secondary enrichments below. It is evident from the nature of the gangue that acid solutions could not exist and hence the theory of W. H. Emmons cannot be applied. Except for the oxidation of the pyrite, there is no evidence of the action of surface-water on the ore. Therefore I believe that the ore is essentially a primary deposit formed by hot ascending water. The calcite came from the andesitic magmas with possible contributions from underlying limestones, and the quartz and adularia came from the acid magmas.

Although the veins cut the Green Chloritic Andesite, it is probable that the important orebodies occur in the Older Andesite because they are found at depths below 300 ft. and, as was noted above, the Green Chloritic Andesite cannot extend much deeper than 300 feet.

The belt, or zone, above described does not extend over 4 miles long by 2 miles wide. The remainder of the Oatman district is still in the prospect stage, and deductions as to its geology cannot be made satisfactorily at this time.

JOHN B. PLATTS.

Oatman, May 4.

Surficial Indications of Copper—II

By Frank H. Probert

THE relationship of physiography to ore deposits is important, but in many districts the details of it are difficult to determine. Each of the complex changes in the physical history has its effect, and, for the formation of an ore deposit, there must be a for-

phery of plus areas of elevation on the American continent. This relationship is particularly well shown in the lead-zinc mines of the Ozark uplift, in the metal mines of Montana, Idaho, Utah, and Nevada, and on the western slopes of the Sierra Nevada and the Andes.

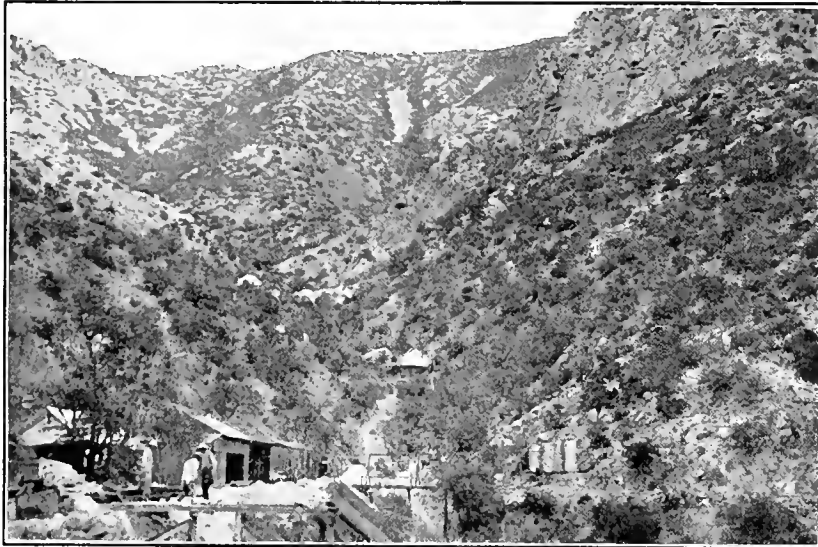

FIG. 9. RUGGED TOPOGRAPHY, 3 R MINE, PATAGONIA, ARIZONA.

fortunate combination of many favorable factors working harmoniously together, the absence of any one of which may prevent sufficient concentration to make a mass of ore.

The nature and genesis of an ore-deposit affect the topographic expression of the outcrop. It is, of course, necessary to distinguish between present contours and those of the mineralizing period. Elevated areas are frequently the result of comparatively recent orogenic movements, of recent fracturing; hence processes of oxidation are seldom advanced. Precipitous slopes mean rapid run-off. Gravitational stress may cause a constant widening of fractures.

Ores of igneous origin, where concentrated by later processes of oxidation and precipitation, may be sought on the middle or lower slopes of mountainous areas. However, the slow downward migration of the belt of weathering furnishes the final favorable condition for the accumulation of secondary minerals by descending waters. At a recent meeting of the San Francisco section of the American Institute of Mining Engineers, Dr. Bailey Willis presented some broad generalizations showing the distribution of mining districts around the peri-

The relative hardness of the rocks, as well as the topography and rainfall, determines the amount of erosion. A brecciated vein, silicified shear-zone, or metamorphosed limestone, will be more resistant than the enclosing rock and will weather out conspicuously in the landscape. In looking over a new district, all unusual features, such as steep scarps, rock-ribs, 'blow-outs,' and sudden changes of color, should be investigated.

The longer the period of time that the mineral deposit has been subjected to surface influences the more advanced will the alteration be, and, other things being equal, the greater are the possibilities of an extensive zone of enrichment below. Most of the chalcocite bodies already exploited on the North American continent belong to early Tertiary time. The end of

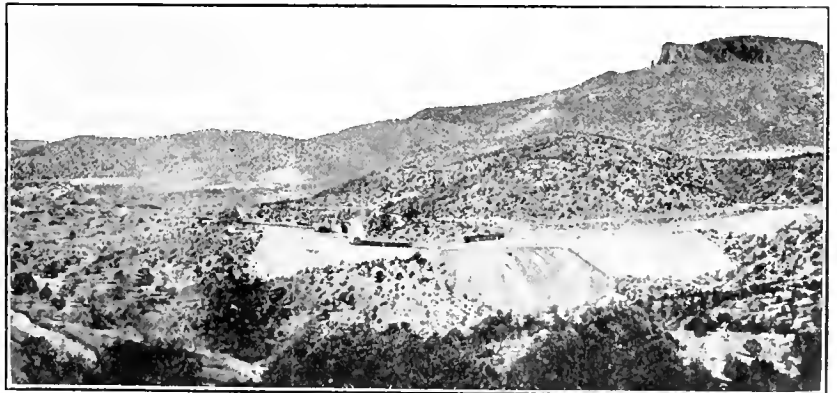

FIG. 10. ROLLING TOPOGRAPHY, CHINO COPPER CO., SANTA RITA, NEW MEXICO.

this geologic period was marked by a general adjustment of the earth's crust attendant on protracted volcanism. Many of the orebodies were faulted, fractured, or crushed by tectonic movement, initiating a period of vigorous oxidation. Freedom of circulation is essential for solution, precipitation, and consequent concentration.

Solution prevails in the zone of oxidation. The phenomena of solution are of supreme importance in the concentration of metallic ores. A magmatic ore owes its segregation to a relative insolubility in the magma. A

residual or detrital ore is formed, at least in part, by the removal from a rock of the more soluble constituents, the less soluble thereby becoming concentrated. Sedimentary ores are deposited from solution, either directly or by precipitation, and metalliferous veins represent another aspect of the same processes. "The original magmatic rocks are separated, by solution or leaching, into different fractions, and then by direct deposition, by precipitative reactions, or by metasomatic replacement—orebodies, and especially vein-fillings, are formed. In most cases probably the final workable deposit is the outcome of a series of concentrations, the result of several inter-dependent processes. By differences of solubility, the constituents of the earth's crust are separated from one another, to be laid down again under different conditions and in different places."*

The greater the number of openings, the greater the possibilities of enrichment. Many small openings are more favorable than large faults for wide-spread oxidation. Friction is greater in capillary tubes than in wide openings; hence the percolation of water is slower, contact with mineral and gangue is longer, solution more complete, and enrichment enhanced. Such conditions favor a thorough leaching of a comparatively shallow zone. It is in the intensely faulted areas that oxidation extends to great depths.

A welded bar of steel is weakest at the weld, so too in the earth's crust, a fracture once formed, even though later filled by vein-matter, is necessarily weak, so that slight movement of the crust may bring about re-opening of fissures, sympathetic breaks, and brecciation. Re-opening of fractures is common. Its effect is far reaching and to it one must attribute many of the big orebodies. It explains the alternating appearance of oxides and sulphides in the vertical range of lodes; it accounts for irregular oxidation, because clays will be formed by the grinding of the wall-rock and will obstruct the movement of aerated waters. Shear-zones, or areas of brecciation, are favorable places for enriched ore.

It is advisable to study all these structural details, the bedding-planes of sediments, joint-planes of intrusives, cleavages, slips, fractures, faults, and determine, if possible, the dominant lines of weakness. The trend of an orebody will be indicated and the possibilities for ore-shoots suggested.

In his work for the Geological Survey at Bingham, J. M. Boutwell recognized the importance of studying the complex system of fracturing there developed. He plotted patiently the strike and dip, noted all conditions, favorable or otherwise, and soon brought light from the apparent chaos. He found that the fissures devoid of mineral contents trend toward all points of the compass in about equal numbers. The fissures with feeble mineralization trend north-east. Over 84% of those that carry pay-ore range between N 5° and 43° E. In brief, the barren fissures display no regularity of direction,

while the mineralized fractures are all included within a small arc of the magnetic circle (see Fig. 13). Other districts have been studied similarly. The complex system of faults and fractures at Butte, Montana, has favored the formation of extensive high-grade orebodies; it has complicated the search for these orebodies; it has given the economic geologist an interesting field for scientific research; it was the cradle of the theory of secondary enrichment as advanced by Winchell, Weed, and Emmons; it has enriched the lawyers who have endeavored to elucidate the effects of faulting in apex litigation.

The surface does not always show the complicated structure, or the relative importance of the different series of fractures. At Bingham "only a comparatively small portion of the several hundred fissures observed underground are recognizable at the surface." The bedding-planes of the sedimentaries, the joint-planes of intrusives, if they are not too highly altered, may be noted; the relationship of dikes or sills to either of these can be established; the influence of major or even minor faults can be detected, so that there is much to be learned even from meagre surface evidence. Again, shearing will be recognized readily. Parallelism of fractures closely spaced will suggest sympathetic breaks, a slow and continued adjustment of the rock mass, from which we may infer that free circulation of oxidizing waters has taken place. Brecciation, with or without subsequent silicification, is a favorable sign. The presence of clay on fault-planes may form an impervious layer to divert the waters one way or another. At the Mount Lyell mine, in Tasmania, a gossan ore-shoot followed the foot-wall of the lode; no copper was found on the upper side, but a remarkable series of rich lenses of silver and copper was mined from the under side.

In the life-history of an ore deposit, that of the outcrop is the most eventful. It is subject to ceaseless warfare; it is torn to pieces by violent earth-movements; it is attacked by gases, waters, and acids; it is drenched by rain, frozen in winter, scorched in summer; the sand-laden winds burnish it; the soils try to protect it. Is it any wonder that the metal contents seek refuge at a lower horizon? They gather themselves in zonal array, temporarily protected by the impoverished surface, to await the constant attack of the elements. These zones are continually descending; it is an orderly retreat under normal conditions, but when the onslaught is too great, much of the metal is dissipated; its form is annihilated, its disorganized remnant is made captive and transported elsewhere.

Ore at the outcrop may represent what was once primary mineral; afterward enriched sulphide ore; still later oxidized, enriched sulphide ore; later still leached, oxidized, enriched sulphide ore; and finally it may have become the gossan. Any one of these particular phases may show at the surface. Again, the transition from one condition to another may be very slow; they may be

*F. W. Clarke, 'Data of Geochemistry,' U. S. G. S., Bulletin 516, p. 633.

serially blended with no sharp line of demarcation. The actual depths of the various zones vary widely in different districts, in different parts of the same district, or even in the same deposit, depending upon the local conditions of the water circulation.

In support of these statements, I shall quote from the writing of three close students of the subject.

changes in the relative abundance of certain minerals, indicates the proximity of the oxides, while in the case of the oxides, there is seldom, if ever, any change to indicate a nearness to sulphides."

It is essential to determine the original position vertically of that part of the orebody exposed today. This done, we can formulate some idea of its further possibilities.

The changes wrought in the zone of oxidation are the net results of the combined work of the elements from above and of subterranean forces. The latter cause the main fractures; they buckle the surface and force into or through the overlying rocks great quantities of molten material, initiating mineralization. Then, on the shrinkage of volume, due to cooling, new planes of weakness and rupture develop, and finally the metallic residuum of the magma escapes, completing the primary mineralization. Now comes the deluge from above, gathering strength in its descent through the belt of weathering, destroying the original character of the mineralization; but its vitality is soon exhausted; wearied of its burden, it deposits secondary sulphides, and finally it is lost in that water zone, the top of which is known as the ground-water level.

Outcrops and the zone of oxidation are so closely related and intimately associated that they must be de-



FIG. 11. OUTCROP OF VEIN AND DESERT TOPOGRAPHY. PLANET MINE, BOUSE, ARIZONA.

F. L. Ransome says of Bisbee: "Within the transition zone between completely oxidized and unaltered sulphide ores, which has a maximum depth or thickness of about 900 ft., the oxidizing processes are controlled to a large extent by recent, irregular fissuring and by the relative permeability of the various sulphide masses to descending waters. Fissures, cutting through masses of lean pyrite, are almost invariably accompanied by streaks of rich ore, often containing chalcocite together with cuprite and native copper. Where there are several such fissures closely spaced, important orebodies result."

Waldemar Lindgren says of Morenci: "The oxidation does not extend down to any well defined water-level, which must be far below the deepest workings, but acts most irregularly, sometimes leaving fresh, metamorphic limestone at the surface and again reaching down to a depth of 400 ft. along fissures and faults. The present orebodies probably fell an easier prey to oxidation by reason of their richness in sulphides and their favorable exposure to percolating waters."

Reno H. Sales says of Butte: "Examined from the surface downward, the oxidized portion of a copper vein will show but little variation in physical character or mineral composition between the outcrop and the sulphide ore. The line of separation, marking the change from oxidized to sulphide ore is very sharp and clean-cut. There is no partial oxidation of the veins, no mixture of sulphides and oxides. The entire change in any single cross-section takes place within two or three feet vertically. Generally the sulphide ore, through slight

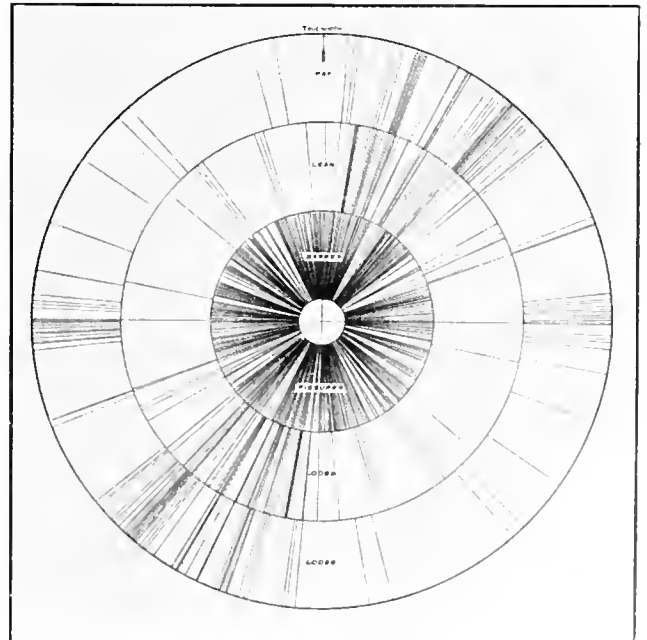

FIG. 13. DIAGRAM SHOWING TRENDS OF BARREN FISSURES AND OF LEAN AND PAY VEINS AND LODS OBSERVED IN BINGHAM, UTAH. (Copied from Prof. Paper No. 35, U. S. G. S.)

scribed and discussed together. Forces that have developed the one have influenced the other, and as ground-water level has been the accepted dividing line between

the indicator and the indicated in the voluminous discussion of secondary sulphides, I shall limit myself to that portion of copper deposits directly influenced by meteoric agency.

All the waters in the belt of weathering are of meteoric or surface origin. They are the most potent factors in the enrichment of primary deposits. Generally speaking, their power is spent on reaching the ground-water level, although in a number of cases they have enriched areas below this level by diffusion of contents.

Ground-water level is the level at which water lies in any particular district. It tends to follow the contour of the country. If the rock is shattered and the openings are large and numerous, the ground-water level will be at a considerable distance from the surface, since meteoric waters can readily penetrate. There is likely to be a marked rise in the level where the openings change from super-capillary to capillary size. The proximity of streams or other bodies of water cause the ground-water to rise. In the eastern United States, the depth of ground-water varies from 0 to 100 ft.; in the high limestone region of Kentucky, it stands about 220 ft. below the surface; in the western part of the great Plateau region east of the Cordilleras, it is reached at from 150 to 240 ft., whereas, in arid regions of the Southwest, it may be 1000 ft. or more down. The average depth throughout the United States is from 90 to 150 feet.

Franz Posepny first called attention to the striking difference of conditions above and below ground-water level. James F. Kemp vigorously attacked the theories advanced by C. R. Van Hise regarding the relative work of meteoric and magmatic waters in the origin of ore deposits. He pointed out that there is a grave objection to the supposition of a universal ground-water level. The deep shafts of Lake Superior are dry, even dusty, although from their geologic structure and proximity to large bodies of water, conditions are favorable for much water. At Pzribram the mines are dry at 2400 feet.

Whenever possible, it is advisable to determine the permanent water-level in the district being examined, as it may have a marked bearing on the value of the property, but in interpreting the phenomena of the outcrop, it is well to bear in mind the later geological history of the section, because subsidence, together with choking and elevation of surface drainage, may raise the ground-water above its old level. Where the rainfall is slight, contributions to persistent water are proportionately small; the level may be far down, or, if the rocks are shattered, it may be entirely lacking, and oxidized ores, so far as they can be produced without the aid of much water, may extend to depths infinitely great.

I use the term water zone advisedly. T. A. Rickard has, on several occasions, emphasized the importance of recognizing a stratum in the earth's crust above and below which water, as such, is not found. The lower limit of ground-water may present a very irregular surface, depending on the penetration of fractures. In the *Engineering & Mining Journal* of March 14, 1903, and

in the *MINING AND SCIENTIFIC PRESS* of June 27, 1908, Rickard cites several instances to support this contention, and says, "All the evidence is in favor of the essentially superficial character of ore formation; in other words, the precipitation of ore, and especially the concentration that makes the richer bodies of it, is measurable from the surface accessible today and has been affected by geological conditions near that surface. Of these conditions the most important is the existence of a blanket of meteoric water charged with oxygen and salts leached from the oxidized zone overhead."⁶ This is an important subject and invites investigation and discussion.

Ground-water level is never the same over any long period of geologic time. It is constantly changing, and this movement in the vertical scale has an important bearing on the mineral sequence, causing alternating periods of oxidation and reduction, enrichment and impoverishment. Practically all the workable deposits of today are the result of successive concentrations, effected by circulating waters. The periodic rise and fall of ground-water is most marked in arid regions. These fluctuations cause the oxidized and enriched areas to exhibit great irregularity in vertical range.

At Kyshtim, in Siberia, the level of ground-water is relatively constant, 100 ft. below the surface of the broad shallow valleys in which the copper deposits are found. There is a noted parallelism of the several mineralogic zones with the ground-water level. The latter has an intimate relation to the vertical range of minerals. The gossan does not extend down to the water, indicating the retreat of standing water to greater depth. The zone of oxidation is only about two-thirds the width of the primary ore. Leaching and impoverishment of copper contents extends down 50 to 135 ft. below ground-water, while residual sulphides are found 25 to 95 ft. below the present level, again attesting to the variability of the horizon of ground-water.

At Ajo, Arizona, the oxidized ores continue to a horizontal plane 20 to 150 ft. underground. This plane does not conform to the present topography but corresponds with the present water-level.

John A. Reid describes⁷ an interesting situation at Copperopolis, in California, where the surface zone of oxidation is very shallow, 30 ft. or less, and the zone of enrichment entirely lacking. He attributes this fact to the intense lateral pressure in the rocks, preventing the formation of an active vadose circulation.

Ground-water level oscillates in different localities with seasonal changes, and has been subject to rise and fall in geologic time, but generally speaking, it moves downward with the erosion of the surface. We must not be misled by this statement, however, for present-day outcrops may be the net result of reactions, chemical and physical, extending over geological epochs.

The zonal arrangement of the products of alteration is influenced by the structure of the rock-mass. They

⁶M. & S. P., Vol. 96, p. 875.

⁷*Economic Geology*, Vol. 2, pp. 380-417.

are not constant; any one zone may be highly developed or conspicuously absent, depending on local conditions. At Ducktown, in Tennessee, the gossan extends from the surface to 100 ft. It is rich in iron and has been smelted for a number of years as an iron ore. Below this is a dark-colored area of enriched sulphides, which is approximately parallel with ground-water and present surface, but where the lodes are crossed by running streams, chalcocite is seen at the surface.

As a rule these zones are roughly conformable with the present topographic surface and hydrostatic level, but they may be much more irregular than either. The zone of sulphide enrichment nearly always contains nuclear masses of primary ore. In moist countries the zone of secondary sulphide is usually below water-level,

Lindgren says: "Chalcocite perhaps forms at the present time in the upper levels of the belt occupied by this mineral, where copper sulphate solutions from oxidizing chalcocite above are abundant, and free oxygen absent. Direct oxidation has, in fact, already penetrated to the deepest levels attained in the pyritic zone, due to the presence of fissures and seams, but it is slowly spreading." He regards the chalcocite zone as formed about an ancient water-level much higher than the present. During the period of formation of the Gila conglomerate, the water-level was surely at least several hundred feet higher than it is now, and it was probably still higher during Tertiary time, during which a moist climate most likely prevailed. Precipitation may be caused by evaporation, as is the case in all efflorescences and in-



FIG. 12. RAY, ARIZONA. OUTCROP OF OREBODY IN MIDDLE DISTANCE.

whereas in arid regions it is partly or entirely above it.

Ground-water is generally accepted as the level at which reduction of the oxygenated water begins and where secondary enrichment may be expected. The statement does not always apply, for, if the deposit is very porous, oxy-sulphates may develop and continue for a considerable distance. A mineral soluble under given conditions does not precipitate readily as long as those conditions last. The waters below the persistent water-level are not oxygenated except by diffusion and that only to a limited degree.

Many deposits of secondary sulphide in the arid South-west are above the ground-water level. In a number of mines, the primary ore has been exposed and no water is found. This is probably on account of change of climatic conditions. If the change was sudden, the primary ores may have had but little chance for alteration. Nearly all the mines are dry at Morenci (Arizona) in and below the chalcocite ore. Of these mines, Mr.

crustations in mine-workings. Melanterite, chalcocite, goslarite, gypsum, and alum are common in surface workings. Local accumulations of sulphates may lead to the formation of veins of stopeable width, for example, the melanterite veins near Whitehall, in Montana, and the chalcocite veins of the Bluestone mine, in Nevada, and in Chile. Rapid evaporation may induce surface circulation.

The nature of the outcrop will suggest the duration of erosive conditions and extent of their work. Where the mineral contents of a vein are subject to rapid solution, rapid erosion favors rapid concentration. Weathering generally precedes erosion; and where erosion is slow, the surface may be entirely leached of its metallic content, so that large or concentrated areas of enrichment are produced. The present enriched zones not only represent the added value from the known oxidized covering, but may contain that from horizons already eroded.

The estimate of the amount of mineral removed by erosive action is more of academic interest than of commercial value. An exhausted mine is seldom interesting, and that part of an ore deposit which Nature has mined can never be figured as an asset unless it has been concentrated elsewhere on the surface of the earth. Nature is kind to the gold miner in this matter, as is instanced by 'The Golden Sands of Nome,'¹ and in all likelihood, the copper deposits of the Red Beds of the Triassic sandstones owe their origin to the re-concentration of transported material.

If we know that the primary ore is uniform in character, the secondary sulphides can be used as a factor to determine roughly the amount of material that has been removed from the present surface. The formula

$$x = \frac{a(l - p) + b(c - p)}{p}$$

x = vertical distance in feet of the eroded portion.

a = present depth of impoverished leached surface zone.

b = depth of enriched zone above accepted datum line of primary ore.

l = assay of the leached zone.

c = assay of the enriched ore.

p = assay of primary ore.

gives but a rude approximation of the amount of material eroded, but in conjunction with other geologic data, can be used to check conclusions regarding the past history of the vein.

It has been applied at Ducktown and shows that there the copper content of the eroded area was dissipated, for the depth of the leached zone now exposed is sufficient to account for all the re-concentrated copper of the secondary sulphide ore.

In the early days of activity in the Ray district, J. E. Spurr determined the amount of schist that has been leached and partly removed, to produce the known orebody. Using the data from nine representative drill-holes, he estimated that 467 ft. of rock had been leached and removed by erosion from the present surface. This agreed with the aerial geology.

The forces at work and the conditions under which they operate in the upper zone are so complex and inter-related that they almost defy analysis or division for individual consideration. Cause and effect are confused. Reactions are reversible and variable; chemical conditions cause complementary changes. Oxidation and desulphidation, carbonation and disilication are complementary processes in the oxidized zone. They may take place simultaneously.

The effects of the physical and chemical forces are not independent of one another; on the contrary, they are most intricately interlocked. To a considerable degree any one of the forms of energy may transform into the others; consequently, the action of one almost always produces an effect upon the action of the others. Frequently, all of the forces, contributing to the constant

change, are important simultaneous factors in the results; again, one or two of the forces may be prominent or even dominant, the other playing a subordinate part. In every transformation, if all the energy-factors of the entire system be taken into account, some of the energy is converted into heat, and heat accentuates chemical change.

In the study of the underground circulation, one has to consider the total effect, the final result of all the component causes and effects rather than the niceties of simple operations. Circulation is rapid in proportion as the hydrostatic head, the gravity, and mechanical action are great. It is slow in proportion as the internal friction is great. In proportion as the openings are continuous, it will be rapid; in proportion as the porosity of the rock is increased, circulation will be accelerated. Of all these the size of the openings is the most important, and as a corollary, the oxidation of an orebody will be advanced by the development of these favorable conditions. The molecular structure of the vein or deposit will influence percolation; hence, anything that tends toward abstraction of material, chemically or mechanically, will promote leaching and oxidation. For a given pore-space per unit of area, the faults are likely to give a greater flow of oxygenated waters than areas of shearing or fissility. This follows from the greater size of the few openings. Hence, other things being equal, the zone of oxidation in veins is generally more advanced and much deeper than it is in the disseminated deposit. The size of openings also effects the transmission of oxygenated waters, for the smaller the opening the greater the quantity that is held by imbibition or adhesion to the walls. Here the time element comes into play, for the solvent power of water is in proportion to the time of contact. Waters moving slowly are the more potent. The geological—I might say the economic—work of the ground-water is favored by smallness of openings, by time, pressure, and heat. Pressure and temperature are factors of depth and therefore influence the vertical range of the work done by circulating waters. Heat depends upon depth of penetration. It is increased by chemical action, mechanical action, and the presence of intrusive rocks. Not only is the rate of solution increased by higher temperatures, but the capacity for holding material in solution is greatly augmented. The hotter the water, the less the viscosity, which assists flow through minute openings. The underground journey of waters seeping downward may occupy centuries of time. The adjustment of a rock to its environment is never complete; therefore changes are always in progress; and the conditions are always those of chemical dynamics; but the changes are so slow that an attempt to duplicate the reactions in a laboratory would fail utterly. It is a case of chemical statics. Time is an essential factor.

Time is not a force or agent of alteration or chemical change, but alteration is a function of time. A comparatively weak force, chemical or physical, working through a long interval of time, may accomplish an incredible amount of work. We cannot compare condi-

¹Geology Applied to Mining, T. A. Rickard, *The Mining Magazine*, October 1914.

tions in the earth with laboratory work; for instance, in the laboratory, quartz is almost inappreciably soluble in water, whereas it is beyond question that enormous quantities of silica have been dissolved and transported in the earth's crust. The geologist has to think not in hours, days, or even years. The effect of time is recognized in constructive and destructive geology. It is of even greater importance in studying chemical change.

In proportion as rocks or ore deposits are old, they are greatly altered; in proportion as they are young, they are less altered.

If the geologist ignores this fact, and reasons in reference to the potency of forces and agents in metamorphism, as a chemist and physicist does in the laboratory in reference to the same forces and agents, he is certain to fall into serious error.

Metal Output of the Central States

A summary of mine production of silver, copper, lead, and zinc in the Central States in 1915,* is as follows:

| State | Ore treated Short tons | Silver Fine ounces | Copper Pounds | Lead Short tons | Zinc Short tons | Total value |
|-------------------------|---------------------------|-----------------------|--------------------|--------------------|--------------------|----------------------|
| Arkansas | 110,000 | | | 63 | 3,209 | \$801,754 |
| Illinois | ‡316,000 | 3,864 | | 954 | 5,534 | 1,464,067 |
| Kansas | 709,400 | | | 1,212 | 14,365 | 3,676,448 |
| Kentucky | ‡ | | | 251 | 764 | 213,066 |
| Michigan | 12,334,700 | 585,933 | 265,283,378 | | | 46,721,659 |
| Missouri | 15,573,700 | 57,756 | 402,160 | 210,440 | 136,300 | 53,683,420 |
| Oklahoma | 891,800 | | | 7,306 | 14,314 | 4,236,636 |
| Wisconsin | 1,934,000 | | | 2,322 | 41,403 | 10,486,212 |
| Total 1915 | 31,869,600 | 647,553 | 265,685,538 | 222,548 | 215,889 | \$121,283,262 |
| Total 1914 | 23,734,923 | 482,983 | 164,398,821 | 203,845 | 168,032 | \$ 55,171,306 |

*The following are the average market prices used by the U. S. Geological Survey in figuring values of production of metals for the calendar year 1915: Silver, per fine ounce, \$0.507; copper (electrolytic), per pound, \$0.175; lead, per pound, \$0.047; zinc (spelter), per pound (average sales price), \$0.124.

‡Includes only ore from north-western Illinois.

‡Tonnage not available.

The productive lead and zinc territory in the Central States naturally falls into seven regions, three of which are not limited to any single State. For statistical purposes the tables showing the production of lead and zinc

for convenience. The Joplin region produced 16% of the lead and 76% of the zinc of the Central States in 1915, and was much the largest producer of zinc in the United States, yielding 36% of the total zinc production from domestic ores, against 38% in 1914. The upper Mississippi Valley region yielded a little more than 1%

of the lead and nearly 22% of the zinc produced in the Central States in 1915.

Mine production of lead and zinc in the Central States in 1915, by regions, in short tons:

| Region | Concentrates | | Metal | | Total value of metals |
|---|-------------------|-------------------|----------------|----------------|--------------------------|
| | Lead ¹ | Zinc ² | Lead | Zinc | |
| Joplin ³ | 45,350 | 321,695 | 35,052 | 164,544 | \$44,101,800 |
| South-eastern Missouri ⁴ | 278,104 | 1,104 | 183,906 | 372 | 17,379,420 |
| Upper Mississippi valley ⁵ | 3,854 | 162,029 | 2,817 | 46,937 | 11,905,174 |
| Northern Arkansas | 79 | 8,531 | 63 | 3,209 | 801,754 |
| Kentucky and southern Illinois | 1,011 | 2,172 | 710 | 764 | 256,212 |
| Arbuckle mountains, Oklahoma | | 132 | | 63 | 15,624 |
| Total, 1915 | 328,398 | 495,663 | 222,548 | 215,889 | \$74,459,984 |
| Total, 1914 | 294,124 | 390,213 | 203,845 | 168,032 | \$33,039,174 |

¹Includes both galena and lead carbonate concentrates.

²Includes sphalerite, zinc carbonate, and zinc silicate concentrates.

³Includes south-western Missouri, south-eastern Kansas, and north-eastern Oklahoma.

⁴Includes a very small production from central Missouri.

⁵Includes Iowa, Wisconsin, and northern Illinois.

by States are necessary and are so given. For practical information, however, it seems desirable to compile the production by the natural regions, irrespective of State lines. As stated by J. P. Dunlop, of the Survey, the south-eastern Missouri and central Missouri regions produced about 83% of the lead output of the Central States. The production from central Missouri is small, and it is included with that of south-eastern Missouri

Arkansas made a great increase in output, namely, 110,000 tons of concentrates against 20,000 tons in 1914. Other States showed increases, in tons of concentrates:

| State | 1915 | 1914 |
|-----------------|-----------|-----------|
| Illinois | 316,000 | 261,300 |
| Kansas | 709,400 | 510,500 |
| Missouri | 4,004,900 | 3,179,830 |
| Oklahoma | 891,800 | 763,920 |
| Wisconsin | 1,934,000 | 1,387,490 |

International Smelting Company Miami Plant

We are indebted to Mr. L. R. Wallace, resident manager for the International Smelting Co., at Miami, Arizona, for the following details concerning the operation of this highly efficient and successful plant.

DRIVING PLANT STATISTICS

| Composition of Charge | | Analysis of Charge | |
|-----------------------|------|--------------------------------|-------|
| | % | | % |
| Concentrates | 82.6 | Cu | 30.97 |
| Crushed ore | 0.3 | SiO ₂ | 16.02 |
| Converter secondaries | 8.3 | Al ₂ O ₃ | 5.83 |
| Pyrite | 1.9 | Fe | 16.65 |
| Limestone | 2.9 | CaO | 1.80 |
| | | S | 19.57 |
| | | Undetermined | 9.16 |

Steam produced at 187 lb. pressure and 210 C., per ton of charge, 1324 pounds.
 Ruling temperatures in furnace at bridge, 1540 C., at throat, 1220 C., gas after passing boilers, 300 C.
 Approximate gas analysis at throat: CO, 11.97%; O, 2.6%.
 Draft at throat in inches of water, 0.25.
 Temperature of oil at burners, 99 C.
 Pressure of oil, 80 pounds.
 Pressure of air used for atomizing, 8 pounds.

CONVERTER PLANT

Blast pressure, 14 pounds.
 Air per ton of bullion, 142,000 cubic feet.
 Average time for blow, 3 hours 10 minutes.
 Average weight of matte per charge, 26 tons.
 Copper produced per charge, 13.1 tons.
 Grade of matte, 51.5%.
 Average time to blow one ton of copper, 14.2 minutes.
 Tons of ore used per ton of copper, 0.30 ton.
 Copper produced per converter-day, 101 tons.

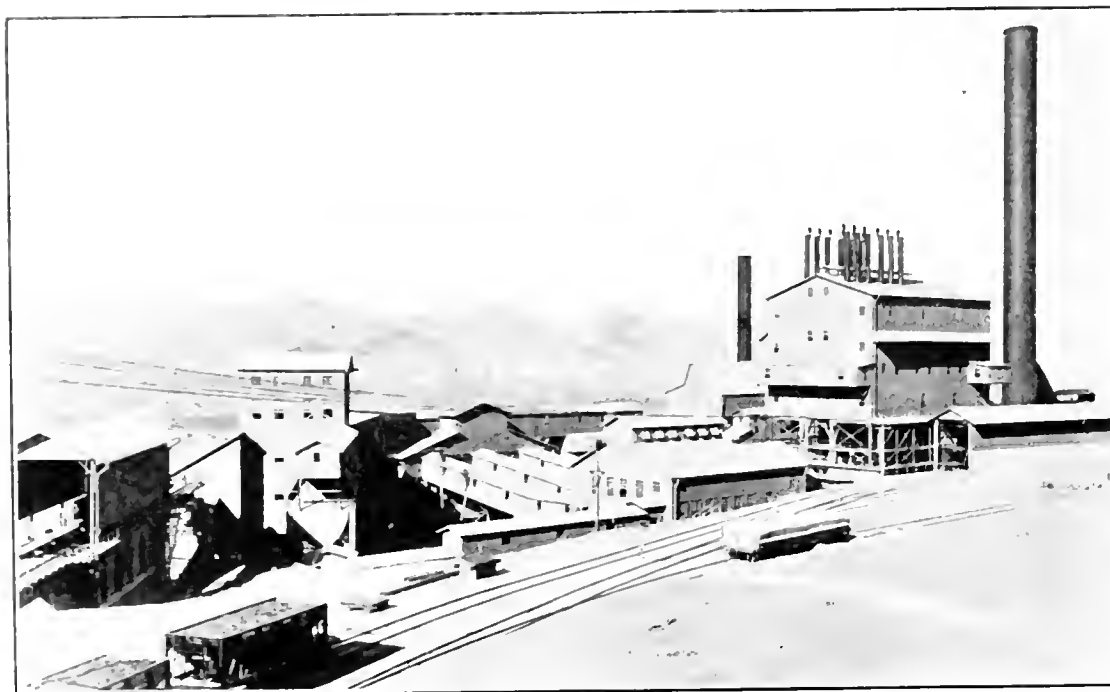

THE INTERNATIONAL SMELTER, AT MIAMI, ARIZONA.

Capacity per furnace-day, 185 tons.
 Oil consumed per ton, 5.15 gallons.
 Temperature of calcine, 145 C.
 Flue-dust produced, 9.7%.
 Volume of gas at 80 C., per ton of charge, 13,700 cubic feet.
 Maximum velocity of gas in Cottrell tubes, 3 ft. per second.
 Average temperature in tubes, 80 C.
 Gas contained: CO, 4.4%; O, 14.4%.
 Moisture in concentrate, 15.9%.

REVERBERATORY PLANT

| Composition of Charge | | Analysis of Solid Charge | |
|-----------------------|------|--------------------------------|------|
| | % | | % |
| Concentrate | 89.4 | Cu | 30.2 |
| Silicious ore | 0.8 | SiO ₂ | 16.2 |
| Conv. secondaries | 19.2 | Al ₂ O ₃ | 5.8 |
| Conv. flue-dust | 0.3 | Fe | 17.0 |
| Pyrite | 1.9 | CaO | 8.1 |
| Limestone | 3.7 | S | 15.9 |
| Hot conv. slag | 19.4 | Undetermined | 9.8 |

Solid charge per furnace-day, 454 tons.
 Oil per ton solid charge, 0.72 barrels.

ANALYSIS OF ORES AND PRODUCTS

| | SiO ₂ | Al ₂ O ₃ | Fe | CaO | S | Cu |
|---------------------|------------------|--------------------------------|------|------|------|------|
| Concentrate | 16.8 | 6.5 | 12.1 | 0.4 | 20.2 | 35.2 |
| Silicious ore | 65.7 | 13.8 | 1.4 | 0.5 | ... | 4.5 |
| Conv. secondaries | 15.7 | 3.5 | 41.1 | 1.9 | 6.1 | 16.6 |
| Converter-slag | 19.2 | 1.1 | 51.0 | 0.5 | 1.1 | 3.5 |
| Reverberatory-dust | 19.8 | 9.5 | 4.2 | 2.9 | 9.9 | 18.3 |
| Converter-dust | 5.9 | 2.9 | 5.2 | 0.6 | 15.9 | 34.9 |
| Pyrite | 4.6 | 1.1 | 41.3 | ... | 45.9 | 2.3 |
| Limestone | 4.4 | ... | ... | 48.8 | ... | ... |
| Dryer-dust | 27.0 | 12.5 | 5.6 | 1.4 | 8.4 | 25.6 |
| Reverberatory-slag | 19.2 | 12.7 | 27.0 | 4.3 | ... | 0.8 |
| Reverberatory-matte | ... | ... | 21.6 | ... | 21.5 | 51.7 |

The complete flow-sheet is given on the opposite page.

THE INTERNATIONAL SMELTER reduced 70,304 tons of concentrate and 17,105 tons of ore, producing 51,769,669 lb. of copper from May 21, 1915, when operations were started to December 31. There was also produced 70,000 oz. silver and 822 oz. gold.

Tungsten Mining in Arizona

By Charles F. Willis

ARIZONA leads in production of copper, but the excitement caused by the demand for tungsten has given that metal temporary prominence. Tungsten mining is distinctly the prospector's game, the ore occurring generally in small deposits, narrow veins, and pockets. It has been found in Arizona at a number of places.

In the Dragoon district of Cochise county, hübnerite, accompanied by small quantities of scheelite, occurs with fluorite in quartz veins cutting granite, and in placers derived from these veins. This district has produced tungsten ores for years, but many new claims have now been staked. From the mines of the Primos Chemical Co. regular shipments of high-grade concentrate are being made to Pennsylvania. In the Dragoon mountains at Russellville, hübnerite and scheelite are found in small quartz veins, cutting a granite stock, which is in the shape of an oval area four miles by two. Every arroyo in these mountains is being searched for tungsten placers. Many rockers and 'long toms' are in evidence, operated by Mexicans, who get 10c. per pound for the concentrate, and make an average production of 10 lb. per day.

In the Whetstone district in Cochise county, wolframite veins are found in quartz and granite, with a little scheelite. This is about 12 miles south-east of Benson on the west slope of the Whetstone mountains. The American Tungsten Co. has purchased the old Euclid wolframite claims 10 miles south-west of Benson. This company is erecting a concentrating plant, to cost \$75,000. The tungsten mines in this district owned by the Primos Chemical Co. are making a good production, 250 men being employed. In the Bower district of Cochise county, in the Chiricahua mountains, scheelite occurs in veins with pyrite and chalcopyrite. Discoveries of tungsten have also been made in Gila county near the Globe-Miami district. The Powers Gulch Development Co. has been organized for the operation of these claims. The tungsten is found to a depth of 120 ft., which is unusually deep for Arizona. West of Miami another strike was made, and upon talk of 60% tungstic trioxide there was almost a stampede to the district. Some of the tungsten shipped from the Powers Gulch claims ran 67%. The property was opened for copper, and nearly 2000 ft. of development work has been done on the 22 claims.

Mohave county has two tungsten districts, the Aquarius, about 12 miles from Owens on the Big Sandy river 60 miles from Kingman, and the Yucca district, 12 miles east of Yucca. At the Tungsten Mountain claims in the Aquarius district the country-rock is chiefly granite, and the ore is in fissure-veins 1 to 3 ft.

wide, some of which have been traced for 2000 or 3000 ft. along the strike. Wolframite occurs in bands between quartz, and disseminated in the vein-filling. These bands have a maximum width of two inches of solid wolframite, although there is little regularity; in places the vein-matter is almost barren. What is called the upper system consists of two veins dipping at 45° into the mountain from opposite sides. The wash in many places shows a little tungsten, one 1000 lb. lot of gravel yielding 50 lb. of concentrate. The claims in the

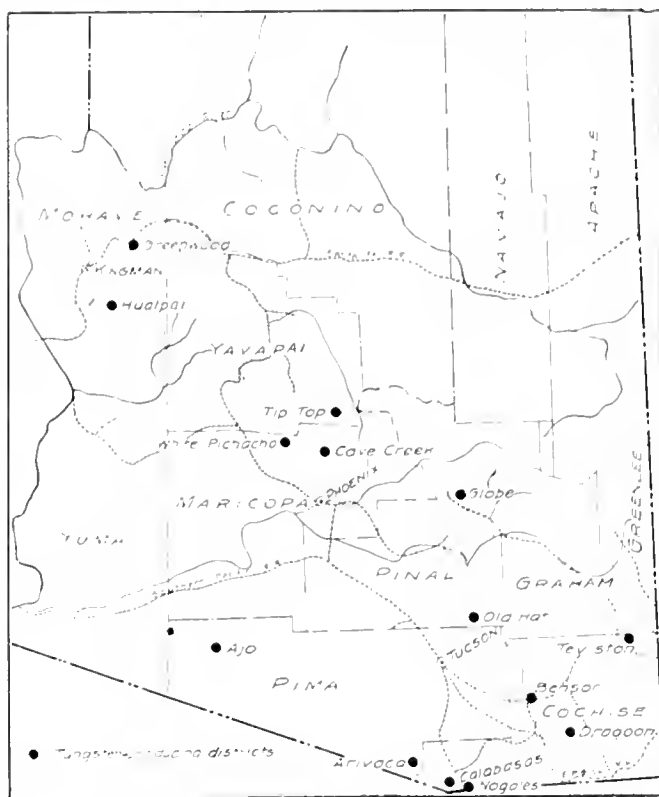

MAP SHOWING THE TUNGSTEN DISTRICTS OF ARIZONA.

Aquarius district have recently changed hands. Last October a 50-ton concentrator was put into operation, and is being worked steadily. In the Yucca district, the Yucca Tungsten Mines Co. is developing its claims preparatory to the installation of a milling-plant. The ore is found in a big dike, and also in a 12-ft. vein parallel with the dike. The Yucca district is important as a producer of the rare metals, including the Leviathan and American Molybdenum companies.

In the White Picacho district of Maricopa county, a vein carrying wolframite has been found; it is only a couple of inches wide, and although of high-grade, it has not been developed. The Pittsburg Tungsten Co. has been operating its copper-tungstate properties at

Cave Creek, 35 miles north of Phoenix, and with success.

The discovery of a 4-inch vein of wolframite has been reported from the Ajo district of Pima county, by M. G. Levy, the owner of the Young American claims. In the Arivaca district of Pima county, locally known as the Las Guigas district, hübnerite, accompanied by wolframite and a little scheelite, occurs in quartz veins. The International Tungsten Co., H. Whitecomb, manager, has produced tungsten ore, and has been incorporated for \$10,000,000 to consolidate many of the smaller properties in that district. The Las Guigas Mining Co. was incorporated to take over the Bent and Sampson claims, which are old-time producers of tungsten.

Robert C. Boydkin and associates have a portable mill, which is moved around to various parts of the Las Guigas district. The mill consists of three units, a pumping-plant, crushing-unit, and concentrating-unit; it can be mounted on a wagon for transportation. The concentrator is a 4 by 7-ft. Wilfley table, with special head motion. Fairbanks-Morse engines are used, Roy & Titeomb rolls, and a Blake crusher. The outfit cost about \$7000. It has turned out \$200 worth of concentrate in a three-hour run.

Scheelite occurs with gold and silver in the Maudina mine in the Old Hat district of Pinal county. Colonel William Cody, better known as 'Buffalo Bill,' has spent a fortune in developing a scheelite property at Bonita in the same district. A mill was erected several years ago, but it was not adapted for economical treatment of the ore, and operations were suspended. With the improved methods of reduction and the higher price for tungsten, it is hoped that the Bonita mine will be revived and that 'Buffalo Bill' will get some of his money back.

Placer operators on a small scale are in evidence in many parts of Santa Cruz county, although in the Calabasas district wolframite is found in place. A low tongue of land between the Santa Cruz river and the Nogales wash is underlain by a porphyritic granodiorite, which is cut by two types of intrusive rocks, one of feldspar and quartz with small amounts of mica, and the other of dense, black, fine-grained dikes, associated with wolframite. The contacts of the dikes with the granodiorite are well defined, and but little altered except for a fraction of an inch. Along the belt there is contact mineral, epidote and chlorite. The intrusive material is dense and black along this contact and for a fraction of an inch inside is unchanged. The deposits are veins showing a beautiful comb-like structure, and in places there are bands of quartz and wolframite. Sometimes the order of the bands is reversed, and it may be that deposition was simultaneous, as wolframite and quartz crystals are mixed. Post-mineral movement is indicated by the walls, but the veins are not much cut or disturbed. In places the quartz is stuck to the wall by a thin layer of dense greenish material, resembling a silicified shale, which may be the intrusive rock altered by the solutions that formed the vein. The principal gangue-mineral is quartz, but there are small crystals of

calcite, and both gangue and walls are iron-stained. The only metallic minerals are wolframite and scheelite. The wolframite is partly crystallized, but most of it is massive. The crystals in large veins have grown into an open space filled with vitreous quartz. The wolframite near the surface is partly altered to iron oxide, showing the form of the original crystal. Most of the veins are less than 10 in. wide, although some are 2 ft., but the wider ones are mostly quartz. The veins traverse the dikes, and the granite near the dikes. The association between the wolframite and the intrusive rocks seems very close. The veins are numerous but most of them are barren; the wolframite being found in small pockets widely scattered. Ore was discovered in 1906 and some shipments are said to have assayed over 50% tungsten.

The Tule Creek, Tip Top, and Eureka districts of Yavapai county have tungsten ores. A custom-mill is planned in the Tule Creek district, to be erected on the creek near Castle Hot Springs. The isolation of this locality, with its lack of wagon-roads, makes a local mill necessary. The claims of the Thompson brothers are being developed, and new locations by R. E. Clark and C. E. Parlan are recorded. One claim is reported to show a streak 10 in. wide of nearly solid wolframite, while another has a streak of equally good quality, but only 8 in. wide. The finding of these claims, five miles south of the Tule Creek mines, indicates that the area is larger than has been supposed. On the Gardner claims a vein 8 ft. wide with wolframite 30 in. wide is being mined. A new strike has been made upon the Cook-Plummer ground in the heart of the district.

Deposits of hübnerite and wolframite are being developed along pegmatite belts in the Eureka and Tip Top districts of Yavapai county. The old Tip Top mine is a producer of tungsten ore; in former years this was a rich silver mine. At that time a large tonnage of what the operators classified as 'black jack' was thrown on the dump; this 'black jack' proves to have been wolframite, and the mine is now being worked to find out how much of this ore was left standing in the drifts and stopes. The first shipment of tungsten ore from Yavapai county was made in April 1914 from the Connors claims in the Eureka district. During the last month, 14 mining locations for tungsten claims in the Tip Top district were filed in two days at the office of the County Recorder. Even the cowboys are deserting the roundup to seek for the metal.

OATMAN is now said to be a low-grade district, but the ore is free-milling and some of the veins are as much as 30 ft. wide. The customary procedure of a new company in sinking, say, 400 ft. before cross-cutting to search for ore, costs about \$40 per ft., or \$20,000 in round numbers, to determine if there is a mine. The United Eastern is estimated to have \$10,000,000 in probable ore. As in all gold districts, the question of persistence of ore at depth is engaging the thoughts of the local mining fraternity. Oatman will likely develop into a gold producer of moderate importance.

Mining in Utah

By L. O. Howard

The general improvement in mining conditions noted in my recent articles continues, marked by no one occurrence of great moment, but by numerous small advances in all the districts. Increasing shipments have been noted from time to time from the old districts, but it is only now that the result of the intensive development of the last few months is becoming fully evident. Tintic's production has been breaking records each week, until in the week ending May 19, 212 cars were shipped, bringing the output for four weeks to 43,200 tons, worth over \$1,000,000. Not only is production heavy, but all the old-time mines are being re-opened and new incorporations financed. The new chlorination plant is said to have made a slight profit in April. Owing to trouble with the roasters and the high cost of chemicals, neither capacity nor extraction has been brought to the highest point. Effort is now concentrated on increasing the capacity and efficiency of the roasting-plant. Competent labor is scarce in the district and bases are in great demand.

The effect of new development work has also been felt at Bingham, where a new producer has been developed in the Silver Shield. Two veins of \$30 to \$40 ore, 2000 ft. apart, are reported. The Utah Copper mills are treating an average of 27,000 tons per day, on occasion handling up to 35,000 tons. Favorable indications are noted in the tunnel of the Bingham-Tooele. The Utah-Metals, now earning nearly \$200,000 per month, may add a flotation department to its mill, which has a capacity of 225 tons per day. A dividend is expected in July, making the company the second new dividend-payer in the district this year.

At Park City, work has been commenced on the new adit of the Silver King Consolidated, and also on its mill. The shipping list now includes 12 companies. The New Quincy has furnished the latest sensation, the value of its stock having quadrupled in a week, on the report of a 19-in. face of \$30 ore in a bed that was discovered accidentally in the drift from the top of a raise put up from the Daly West 900-ft. level, through which the property is worked. The ground adjoins that of the Daly West and Daly Judge; it was a large producer in the early days, and from time to time in recent years has made small shipments.

The Dugway district, 50 miles from the railway, the Salt Lake route, in south-western Utah, has a number of promising properties, on which development is being resumed. The long wagon-haul limits the grade of ore that can be handled at a profit. Most of the ground has been under location for years and developed desultorily while awaiting transportation. The high price of the metals has made it possible to ship poorer ore, the value of which in some cases has been increased three-fold. In the neighboring Clifton district there is much excitement in tungsten, although there has not yet been

time to get the benefit of complete development. From \$5000 to \$10,000 worth of scheelite is being shipped each week by parcel post.

A second company expects soon to start shipments of zinc ore from Promontory. Ore containing 20 to 30% zinc has been developed for a length of 50 ft. along the vein and to a depth of 125 ft. Over 200 men are at work in this locality.

Five properties are shipping from the old Stockton district, and one mill is operated. Zinc ore makes up most of the shipments, although lead, silver, and gold are also sought.

In the Cottonwoods more of last season's producers are sending out ore. Shipments from Big Cottonwood are heavily curtailed during the construction work on the road. Every week adds to the number of new companies. There is now considerable one-man development under way in the lower geologic horizons, the Cottonwood quartzite and slate series receiving most attention. The South Cardiff has been organized to explore this formation south-west of the Cardiff, and a large group of claims along the divide between Big and Little Cottonwood in this same formation is the basis of another incorporation. On the north-eastern side of the district the Big Cottonwood Consolidated plans development in higher formations than those in which ore is being found in any amount. The principal drainage project, the Alta Tunnel & Transportation, has improved its position by taking over 65 acres adjoining the Prince of Wales, Alta Consolidated, and Emma Copper, all past producers and now actively developed.

For years the large deposits of low-grade oxidized copper ore in the Jurassic-Triassic sandstones of south-eastern Utah have been known. It remained for the present prosperous times to render them productive. These properties are situated about 70 miles from the D. & R. G. railroad, and about 25 miles from Moab, in the same part of the State from which ores of radium, manganese, and zinc have been shipped, these also occurring in similar sandstones. A 300-ton mill is said to be planned by one company in which Jesse Knight and Senator Reed Smoot have a large interest.

The valley lead smelters are now operating at capacity and some fear is expressed by the smaller lead shippers that the market will be closed to them. There is, however, plenty of capacity yet to be utilized in the copper plants. Considerable idle blast-furnace capacity for copper ore is available, and while the tonnage of fine ore has increased, the amount received from the smaller mines of the State bears a small proportion to the increased shipments of lead and silver ore. From time to time there are rumors of the intended establishment of a zinc smelter in the valley but it appears much more probable at this time that any facilities for reducing zinc ores will be provided by the expansion of hydro-metallurgical methods.

A rich strike of gold ore is reported from the Gold-strike-Virginia mine in Washington county in the south-western corner of the State.

Roasting and Acid-Making at Braden, Chile

*The plants for this work are at an elevation of 6800 ft. above sea-level. Wilfley table concentrate from the mill, containing 33% sulphur and 16% copper, is fed to a 7-hearth Wedge furnace, having a total roasting-area of 2140 sq. ft. On No. 1 floor the temperature is 380° C.; on No. 7, 630° C. In its passage through the furnace the sulphur is reduced to 3%, while the copper-content is raised to 19.2%.

The sulphur, when burned, forms the dioxide gas (SO₂) that is used in the manufacture of sulphuric acid (H₂SO₄). This gas is drawn from the furnace by a motor-driven fan, the impellers of which are of 6% anti-mony-lead mixture, through a brick flue to the Glover or hot tower.

This apparatus is constructed of timber, protected by a tar coating. It is octagonal, 15 ft. diam. and 43 ft. 2 in. high, with sheet-lead curtains hung on the frame within 6 in. of the bottom of a 2-in. thick sheet-lead pan 24 in. deep. The tower is packed with obsidianite, a chemical brick, laid checker or staggered. On top of the brick is 2 ft. of quartz packing for the even distribution of the circulating acid. The top of the tower is of sheet-lead, above which are the system and chamber-acid tanks of 350-cu. ft. capacity each. The most important function of the Glover tower is to deprive the nitrous vitriol flowing from the bottom of the Gay-Lussac tower of its nitrous compounds, and to restore it to a proper state of concentration for application again at the top of that tower. The Glover also cools the furnace-gases before entering the lead chambers.

The Gay-Lussac tower, 21 ft. 9 in. diam. and 68 ft. high, is of steel, with lead curtains, and resembles the Glover. The interior is filled with acid-proof brick arches on which rests quartz packing. The principle of the apparatus is the same as in the Glover, only that in the latter the nitre, absorbed in the acid during its passage through the Gay-Lussac, is de-nitrated in its descent through the Glover, and the nitrous gases from the de-nitrated acid enter the first chamber along with the SO₂ from the furnace, for oxidation and the formation of sulphuric acid.

Three nitre ovens, 3 ft. diam. and 7 ft. 2 in. long, are at the base of the Glover tower. They are charged with Chile saltpetre and sulphuric acid, and heated. The gas generated is piped to the bottom of the Glover tower.

The four lead chambers, in which all the ingredients for making sulphuric acid are mixed, have a total capacity of 187,000 cu. ft. The wooden frame is covered with 1/2-in. sheet-lead. Water is supplied to the chambers in the form of a spray.

The process of acid manufacture briefly is then: The SO₂ gas from the roasting-furnace, entering the bottom of the Glover tower with the nitrous gas from the ovens, passes up through the brick filling, coming into contact

with the descending nitrous vitriol. This vitriol being de-nitrated on its passage down the Glover tower, falls into the lead pan at the bottom, thence to 12 settling-pans. The acid here has a temperature of 100°C., and is cooled before going to the Gay-Lussac tower to recover

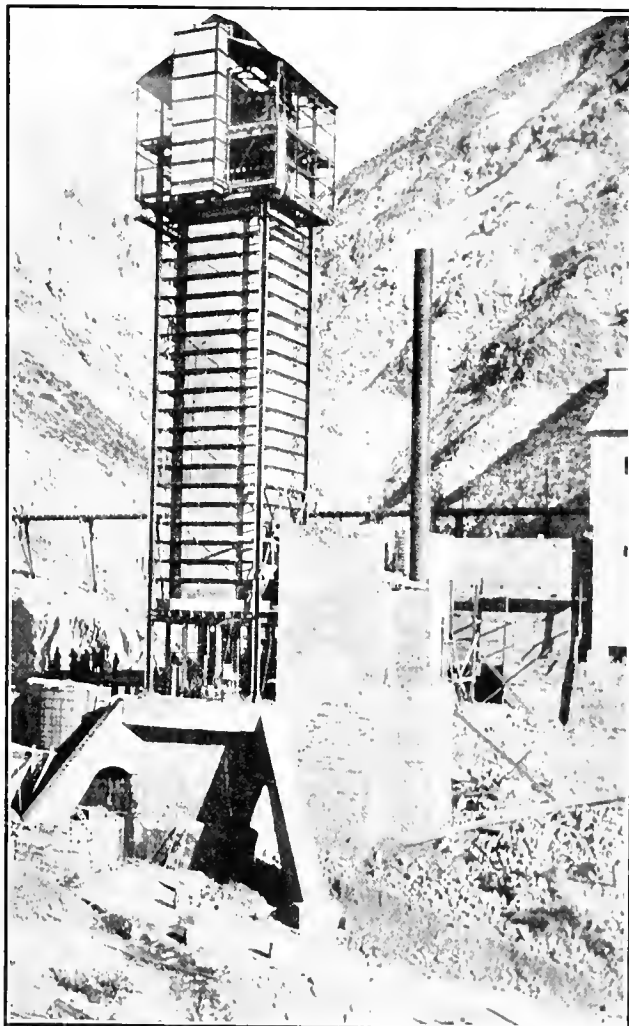

THE GAY-LUSSAC TOWER AT BRADEN.

or absorb more nitrogen compounds. The acid gases from the Glover tower pass to the four lead chambers, in which the water-vapor is introduced. Then the gases enter the bottom of the Gay-Lussac tower. A complete circuit is thereby made. The reactions in the lead chambers are

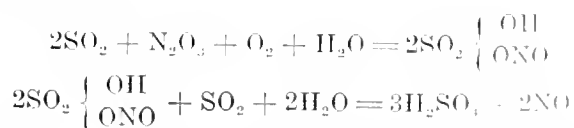

The gaseous mixture from the last chamber contains nitrous oxides, which must be recovered to make the plant work properly and efficiently. About 66% of the nitre is saved thereby. Strong sulphuric acid absorbs the fume in the Gay-Lussac tower.

*Abstract from *Teniente Topics*, December 1915.

The chambers yield 23 tons of 66° B. acid daily, while the Glover tower makes another 5 tons. Chamber acid with a specific gravity of 1.58 is either sent to the mill supply tank for the flotation plant, or to the storage tank at the top of the Glover tower for concentration.

The net daily output is from 25 to 28 tons of 66° B. acid.

Acid eggs or blow-cases are used for circulating liquors to the towers. Compressed air forces the acids out of them through lead pipes to the desired points. 'Dur-iron' (acid-proof iron) locks are used in the pipe-lines.

Alkalinity of Cyanide Solutions

By Alfred Merritt Smith

This important phase of cyanidation, concerning which so much study and observation has been given by competent metallurgists, is now, as a rule, well understood. A few practical operators of the old school persistently cling to an illusion of benefit to be derived by using, with all ores, solutions of very high alkalinity in lime. In the all-slime treatment of ordinary sulphide gold ores, this must be decried as bad practice. A case came recently under my observation in which excessive lime was the cause of fouling the solution, and increased consumption of chemicals in the mill. Besides augmenting the cost of treatment, the actual extraction of gold was lower than it would have been had less caustic lime been employed in the process.

The ore under treatment was a tough amorphous quartz, verging on quartzite, containing finely-divided free gold, and some pyrite. Traces of copper were present, as shown by the zinc-box reactions, but generally speaking, the ore was clean and simple.

The process in use was all-slime cyanidation. The ore was crushed by stamps, classified, and tube-milled through a closed circuit to the extraordinary degree of 200 mesh, with the exception of 16%, 14% of which passed 100 mesh. This gave a mill-capacity of only 3 tons per 24 hours per 1000-lb. stamp. The average grade of the ore was .85 in gold and one ounce of silver per ton. The discharged residue ranged from \$2.65 to \$3 gold, and one ounce silver per ton, practically no silver being extracted in the milling. I made sizing-tests on the residue, disclosing the following facts:

Of the total residue, 72% was true slime, or 'colloid,' containing nearly all of the residue-value, the value remaining in the 16% of 100-mesh sand being much less per ton, and negligible. Of the value in the colloid, 55% was dissolved, not washed out, while 45% was undissolved gold; 11% of 200-mesh sand assayed but little more than the 100-mesh sand, and much lower than the colloid.

The loss of dissolved gold was due in part to a poor arrangement of the mill. Insufficient decantation and replacement of gold solution with barren solution caused a high level of solution-value to be reached all over the mill before an equilibrium of values was established. An incomplete precipitation of a relatively small proportion of the total circulating solution that passed the zinc-boxes tended to raise the solution-value still more. The slime going to the vacuum-filter therefore held high gold-value in solution, and the constant loss due to imperfect

washing of the filter-cake was thereby greatly increased.

An examination of the mill-solution showed an average strength of 0.55 lb. sodium cyanide per ton, 1.7 lb. lime as CaO, and considerable sulphur as thio-cyanate. Tests made of the solution coming from the tube-mill discharge showed alkaline sulphide present at that stage, probably formed by excessive grinding of pyrite in the highly alkaline solution. Lead acetate and litharge were being added in excess at very irregular intervals, and in almost any quantity, as a corrective to solution trouble, without knowing definitely just what was accomplished by its use other than a belief that it "got rid of the sulphides." On one occasion the operator used so much lead salt in a short interval that the following clean-up was principally metallic lead. Zinc consumption was increased by the lead salt, and, as used, it is doubtful if a real benefit was derived.

At the time of my visit much stress was being laid on the assumed value of high protective lime in the solution, and its use was being carried to extreme lengths on a perfectly normal gold ore. A quantity of slaked lime on hand in a store-room was discarded and thrown over the dump as being worthless, someone having advanced the theory that it had "reverted to carbonate." I sampled this material and found it to be fairly good slaked lime, worth in that locality about \$30 per ton.

The following corrective measures were indicated, and are being applied with a marked improvement of results:

1. Coarser grinding. This results in less wear of tube-mill lining consumption, and much greater tonnage milled.
2. A decrease of protective alkali, the mill solution to test from 0.2 to 0.5 lb. CaO per ton. This results in less sulphur in solution, and more rapid solution of gold.
3. An increase of cyanide strength to not less than 1 lb. per ton of solution throughout the mill. Better precipitation results, and any silver dissolved may not be re-precipitated as a sulphide in excessively weak solutions.
4. The regular addition of lead acetate at the tube-mill and the agitators, in small quantities, until reactions at the zinc-boxes show the presence of a little lead, and precipitation of gold and silver in a properly-dressed clean zinc-box is almost complete.
5. Addition of thickeners to the mill were advised to permit wider use of counter-current decantation and replacement, and to permit of all the solution being clarified and precipitated before entering the battery-circuit.

Mining in Nevada

By R. L. Richie

PRONOUNCED activity is seen in every department of mining in Nevada owing to the growing demand for metals other than gold and silver. All parts of the State are enjoying the benefits of this activity, but more particularly are those districts where silver, copper, quicksilver, tungsten, antimony, and zinc are found. Gold mining has not been neglected, profiting from the stimulus that has been communicated to the industry generally, and in large measure from the wider application of the flotation process. Prospectors are to be found everywhere in the hills and the revival appears to have a substantial foundation, happily devoid of the wild-cat promotions that have marked earlier periods of mining activity.

Discoveries of tungsten ores have caused veritable stampedes to several localities, notably in the Snake Range region, east of Ely; in the Mina district in Mineral county; at Toy, in Humboldt county, and at points in Esmeralda, Nye, and Eureka counties. Several reduction plants of limited capacity are treating tungsten ores, so that the production of commercial tungsten is attaining notable proportions. For the most part the mineral is found in the form of hübnerite and scheelite. Discoveries of antimony have been reported at a number of points and several of these are being worked.

At Goldfield an addition is being made to the mill of the Goldfield Consolidated Mines company for a 1000-ton flotation plant. The equipment includes 48 Callow pneumatic-flotation cells and accessories. The crushing and re-grinding machinery is already adequate for a larger tonnage than the capacity required for the flotation annex. This new plant will be in operation in June and will involve an expense of approximately \$36,000. It should effect a saving of \$360,000 to \$400,000 annually. A 50-ton test-plant has been operated for several months and has demonstrated the success of straight mill-feed, effecting a recovery of 99% of the copper and 93% of the gold in the ore. The flotation concentrate will be roasted and leached with sulphuric acid, and the copper precipitated on iron, as at present with the cyanation residue. The oil mixture is composed of 80% coal-tar, 17% creosote, and 3% pine-oil, the total cost of oil not exceeding 8c. per ton.

Work on the deeper levels of the Consolidated mines was suspended early last year, as the high copper content in the deep-level ore precluded its profitable treatment by cyanidation. These levels are again being opened and extended, showing large quantities of gold-copper ore of far better grade than the average treated during recent months, and a product well suited for flotation. Tests with ores from other properties in the district indicate an equal degree of success in treatment,

so that it is likely the Consolidated plant will eventually be equipped to treat the output of a number of properties here. Several non-productive mines, upon which considerable development has been done, are being sampled to determine their tonnage possibilities for flotation, with a view to providing facilities to treat this product.

In the Jumbo Extension mine, the product of which is shipped to smelters in Utah, a substantial tonnage of gold-copper ore, too low-grade to ship profitably, has been exposed and is being tested for flotation. Last year the mine produced more than 1,250,000 lb. of copper,

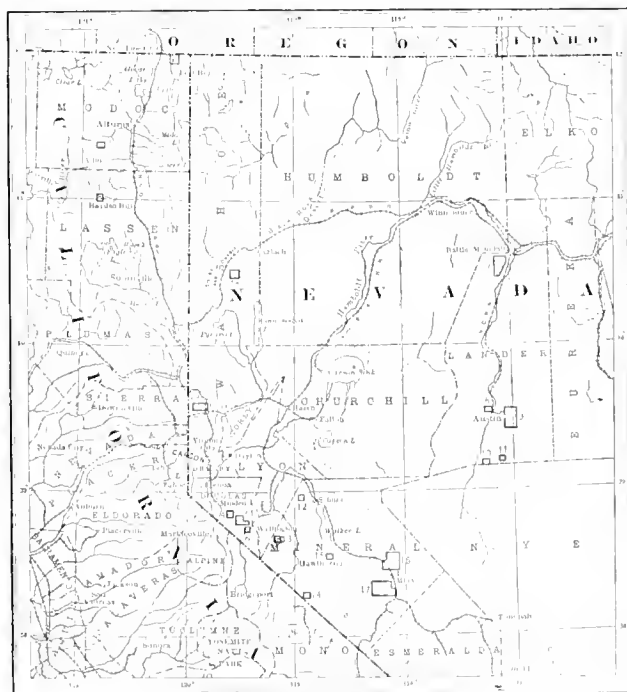

together with some silver, but these metals have been regarded heretofore as by-products. The ore now being shipped contains less gold and more copper and silver. A substantial increase in production will follow the completion of ore-bins at the No. 2 shaft, on the Velvet claim, which hereafter will be the principal outlet of production from the stopes on deeper levels. The Florence Goldfield company has purchased and is enlarging the 150-ton flotation plant erected by a leasing company on the site of the old mill. The dumps, estimated at 50,000 tons of \$5 ore, have reverted to the Florence company and blocked ore in the mine is estimated at 70,000 tons that will yield a net revenue, by flotation, of \$4 per ton. A Marcy ball-mill has been ordered and will be the principal grinding unit, supplemented by the tube-mill now in use, the estimated capacity being

100 tons. The present flotation equipment, consisting of 11 Janney machines, is said to be ample; another Oliver filter and improved pumping equipment will complete the plant. Ore that is suitable for flotation has been exposed in considerable quantity in the Atlanta, Kewanas, C. O. D., Black Butte, Silver Pick, Great Bend, and in small quantity in several other properties. Pay ore has been found lately at a depth of 500 ft. in the New Jersey Mines property, three miles east of the central area. Properties now being worked here include the Atlanta, Merger Mines, Kewanas, Sandstorm, Kendall, Florence, Spearhead, Grandma, Great Bend, Yellow Tiger, Black Butte, Silver Pick, Blue Bull, New Jersey Mines, Cracker Jack, and Goldfield Ore. Several others, including Jumbo Junior, will be working shortly. Dividends have been declared lately by Jumbo Extension and Reorganized Booth, both at the rate of 5¢ per share.

Tonopah mines are producing a large part of the State's supply of silver and earnings of the producing



companies have been enhanced in important measure by the rise in price of the metal. Mine forces have been increased in nearly all the working properties, while development work is being extended in all directions. A few of the chief producers adopted a policy last year of storing a part of their silver to await better prices and have profited in consequence. Among the foremost producers are the Tonopah-Belmont, Tonopah Extension, Tonopah Mining Co., Jim Butler, West End, Montana-Tonopah, and Resene-Enla. The last-named has developed lately from a prospect of doubtful value to a mine of substantial proportions. Ore is being treated from several other properties, including the Halifax, North Star, Mizpah Extension, Midway, and Mac-Namara. Tonopah Extension has lately increased its mill-capacity.

Manhattan, in Nye county, is again attracting interest, owing to the success achieved in the treatment of the refractory ore of the White Caps mine, for which milling facilities will be provided shortly, and to a renewal of activities elsewhere in the district. The Big Four mine and mill have been leased to C. L. Wittenberg of Tonopah, and the mill is being prepared to treat a larger tonnage than before. J. J. McCarthy, a former manager of mines in this district, has secured and is working a property for Oatman mining men. Four mills are in operation in the district and work is progressing on the placers.

North of Rhyolite, the Pioneer Consolidated Mines property has a large tonnage of mill-ore in reserve and the 10-stamp mill is treating 30 tons daily, more than paying expenses. A larger mill, with fine-grinding machines, is to be erected. Near Cuprite, 12 miles south of

Goldfield, development is being done by men in the employ of W. A. Clark, directed by E. W. Clark, manager of the Ophir mine in Utah, which is owned by the former senator for Montana. Surface conditions are said to resemble those at the Copper Queen mine, at Bisbee; many locations have been made and are being prospected over a wide area. In the Gold Mountain district, 15 miles south of Goldfield, shipments are being made from the Butte Goldfield property, and ore will be sent by motor trucks from the Quigley property to a flotation plant at Bonnie Claire. At Hornsilver, 28 miles southwest of Goldfield, high grade silver-gold ore is being shipped from the Dumphy lease on the Orlean property and several others have shipping ore ready. Farther south, the Nevada Empress mine of the Nevada Co-operative Mines Co. has exposed a large vein of good free-milling gold ore. In the Cocomongo district, on the Nevada-California boundary, copper, tungsten, and antimony have been found. In southern Nye county a large deposit of kieselguhr (diatomaceous earth used for dynamite making) has been discovered.

Goodsprings, in Clark county, is making a substantial output of zinc and lead. At Pioche a new mill is nearly completed. Searchlight is producing regularly, but less than in former years.

Ely is now the foremost mining camp in Nevada, in point of population and the value of its output. The pay-roll is said to approach \$350,000 monthly. Operations of the Nevada Consolidated Copper Co. are conducted upon an increasingly big scale. Discoveries of scheelite and hübnerite in the Snake Range region, east of Ely and extending for many miles along the west slope of the range, have attracted mining men from all parts of the State.

The Luning district has become one of the chief centres of mining activity owing to the advance in the price of copper. A large number of properties are being developed in a comprehensive manner and ore shipments have reached a large volume. In the Wonder district the Nevada Wonder mine continues to pay regular dividends. Work will be started shortly on adjacent ground, owned by the New York Oro Corporation. Near Mina, Douglas, and Sodaville there have been discoveries of tungsten, copper, and antimony that have caused local excitement.

In the northern part of the State, Humboldt county has witnessed a marked revival of mining activity. Rochester and Seven Troughs are making a substantial production of silver and gold; National is producing some rich ore; a mill is being built at Winnemucca mountain and another will treat ore from Kramer hill, near Golconda. Battle Mountain, in Lander county, is the centre of several active districts. In Elko county there are good prospects for the revival of Tuscarora, Cornucopia, and other old districts; Jarbidge is producing on a substantial scale and Gold Circle is treating a good tonnage of high-grade ore. Tin has been found near the Isenhood (Eisenhut) ranch, near Battle Mountain.

Mining in Colorado

By George J. Bancroft

The long expected drop in the price of tungsten has finally come. Tungsten is said to have sold as high as \$120 per unit (\$6 per lb.). It is doubtful if any big lots were bought at this price, but it seems probable that one or two buyers filled their requirements at almost any price, and no doubt a few pounds were sold at or near the above quotation. Large quantities were sold at \$75 to \$80 per unit. Then the price slumped. Last week the mining papers quoted various prices ranging from \$42 per unit upward, but there were few sales made in Colorado. The condition of the market suggests strongly that after a period of feverish buying to fill existing contracts, the purchasers formed some sort of a union and determined not to buy at all until the price was right. However this may be, the 'shake-down' is sure to be a good thing for the tungsten industry, unless the price goes below \$25 per unit. Prices have been too high for the last six months. Everybody recognized this fact. Capital does not like to invest in an industry operating under an inflated price. As a result, capital has been shy. While everybody realized that a fall in price was inevitable, few felt competent to name the figure at which the supply and demand for tungsten would find a lasting balance. Now that the break has occurred, it seems fairly certain that a stable price will emerge from the present conflict between sellers and buyers. As soon as this takes place, tungsten mining will command the consideration of capital, and operations can be conducted in a more systematic manner than has been possible recently. It seems the consensus of opinion among well-informed operators that the stable price will not be below \$25 per unit and that an important industry can be maintained at that figure. It is earnestly pointed out, however, that there should be a protective tariff established to protect Western miners against possible floods of tungsten from foreign countries.

An important series of tungsten discoveries has been made south of South Boulder creek. From Elk Park, on the slopes of James peak, eastward to Missonri lakes, well out toward the foot-hills, tungsten ore has been developed in important quantities. This district may be considered as a southern extension of the Boulder County tungsten field. Tungsten has been found in the South Park, at Leadville, in Maggie gulch, near Silverton, and in the San Louis valley. It is not known yet whether these new localities will be important producers or not.

Probably the most significant happening in the last month is the announcement that the famous Moffat tunnel has been tentatively financed, providing the present railroad bondholders will consent to exchange their bonds for preferred stock. The Moffat territory has not proved important in metalliferous mining, but it has big resources in its coal and hydrocarbon deposits. As mentioned previously in these articles, the mining of non-metalliferous minerals in Colorado is advancing more

rapidly than the mining of the metals. The present output of 'Routt County' coal is important and the tunnel will make it more so. The Moffat tunnel is in a small way somewhat like the Panama Canal in that it provides an improved highway for commerce between important industrial divisions separated by a mountain range. The main continental divide has no good pass; the Denver & Rio Grande climbs over it; the Union Pacific crosses a bleak snow-swept mesa in Wyoming. The Santa Fe and Southern Pacific traverse deserts. The Moffat tunnel will no doubt be connected with the Denver & Rio Grande at Dotsero, and will gain a transcontinental avenue, with advantages over the competing lines.

Extensive drilling for oil is promised for Routt and Moffat counties during the coming summer. Charles A. Smith, consulting engineer for the Wolff Creek Oil Co. of Cleveland, Ohio, already has a rig at work. Incidentally the Midwest Refining Co., which is earning at the rate of \$500,000 per month or 40% annum on its outstanding stock of \$18,000,000, is now one of the most important oil producers and refiners in the Rocky Mountain states. There will be a good deal of prospecting for oil in Wyoming this summer. Districts that have already been drilled with shallow holes will be drilled deeper. The Laramie plains and the Lander oilfields will receive attention. The Pilot Butte basin seems to be well proved already.

The connection between the Cripple Creek deep drainage adit and the Elkton shaft has been completed, and the shaft re-timbered. Henceforth the waste-rock from the adit will go up the Elkton shaft, saving 4000 ft. of tramming to the El Paso shaft. The water-level in the central part of the Cripple Creek district has begun to subside as a result of the cutting of several water-courses. Cripple Creek is keeping up a steady production of over a million dollars per month. The Vindicator Consolidated Gold Mines Co. paid the last note for the purchase of the Golden Cycle mine 13 months after the purchase was made, and has kept up its regular dividends besides. The total issue of notes was \$1,250,000.

The rise in the price of silver has stimulated enterprise in the old silver districts, such as Idaho Springs, Georgetown, Montezuma, Leadville, Creede, Rico, Silverton, Ouray, and Aspen. At Idaho Springs, development is particularly active along the big tunnels. As the snow recedes, work is starting at mines not connected with the big tunnels. At Leadville the principal interest centres around the unwatering projects. Steady progress is being made in all of them. There have been the set-backs customary where electricity is used underground for motive power. Insulators invariably become water-soaked in the course of time and then trouble ensues. After the water-level has been lowered, the drifts must be timbered and cleaned, and development done before a large production can be made. In the meantime, the district is keeping up its usual output from ground already drained. The Little Johnny is one of the wonderful mines of the State. It is now producing copper, as gold, and silver, while tungsten has also been found.

CONCENTRATES

Readers of the MINING and Scientific PRESS are invited to ask questions and give information dealing with technical and other matters pertaining to the practice of mining, milling, and smelting.

MINERAL PRODUCTS constitute 90% of Bolivian exports.

Gossan is a Cornish word applied to the reddish decomposed rock capping a pyritic lode.

CAPACITY of a mill is generally rated per 24 hours, but in the Joplin district of Missouri the period is only 10 hours.

ELECTRIC HOISTS on the Rand number 143, exclusive of winches. The combined continuous rating of these machines is over 71,000 horse-power.

FRANIUM AND NIORIUM minerals in pegmatite are found in considerable quantity in the centre of the island of Madagascar, off the east coast of Africa.

POWDER CONSUMPTION at the mines of the Mining Corporation of Canada in 1915 amounted to 1,866 lb. per ton of ore extracted, and 11,617 lb. per foot of development.

CYANIDE CONSUMPTION on the Rand may be allocated to the following causes, according to H. A. White: loss by dilution, 30%; loss by cyanicides, 25%; loss as HCN gas, 25%; and loss as NH₃ gas and N compounds, 20%.

GOLD CONCENTRATE containing up to 4% arsenic is being successfully treated at the Boise-Rochester mine, Atlanta, Idaho, by cyaniding with solutions as weak as 0.05% KCN. Stronger solutions attack the base minerals and cause considerable trouble.

SAND-CEMENT is a definite mechanical mixture of portland cement and a silicious material, say 52% and 48%, respectively, which, on the addition of water, develops physical properties but little, if any, inferior to those of portland cement when used in mass concrete. The manufacture of it involves no chemical reactions. All that is required is the reduction of the silicious material to a size small enough to permit its being completely mixed with the portland cement. The two materials are then ground together to an impalpable powder, smaller in grain than the portland cement itself.

MISSED HOLES in blasting constitute a danger that it is not always easy to avoid. A miner at one of the Anaconda mines suggests in the *Amalgamator* that a good preventive is to put the primer in the bottom of the hole, instead of at the top of the explosive charge. The 'primer,' it is scarcely necessary to add, is the stick of dynamite that contains the blasting-cap or detonator. He argues, "if a primer is in the bottom of the hole and it misses fire, the fuse or part of it will protrude from the hole in plain view. If the primer explodes, then all

the other powder, being on top of it, will explode also. On the other hand, if the primer is placed at the top or centre of the charge, as is usually done, the top of the hole may be blasted away, leaving several sticks of powder in the bottom of the hole." This happening, which is difficult to detect, is not unusual in blasting practice. It may occur where the primer explodes so long after the other holes, that it is in a mass of broken rock when detonation comes. In such cases, the required number of reports would be heard, while still leaving unexploded dynamite in the bottom of the hole.

ZINC ores do not seem to be confined to any particular horizon. Those of the Appalachian belt are Cambro-Ordovician; at Joplin, Missouri, and Cumberland, England, they are Carboniferous; in Westphalia they lie in the Devonian limestone; while in the Alpine district these ores are most abundant in Triassic limestones. Zinc ores occur in nature in a great variety of ways, namely, (1) as true metalliferous veins; (2) as cavity fillings not of true fissure vein type; (3) as irregular masses in metamorphic rocks; (4) as irregular masses, or disseminations, formed by replacement or impregnations in limestones and quartzites; (5) as contact metamorphic deposits; and (6) in residual clays. The associated minerals are galena, pyrite, marcasite, and chalcocopyrite, with calcite, dolomite, barite, and fluorite as gangue-minerals. In the zone of weathering the sulphides are altered to smithsonite, hydro-zincite, and calamine. Although these oxidized ores may contain less metal, they may be of greater value than the unoxidized ores, as they often yield more readily to metallurgical treatment than the sulphide ores.

THE HYDRAULIC RAM is an automatic device by which the fall of a comparatively large volume of water furnishes the power to raise a portion of the water to a height greater than that of the source. Such a system is convenient for furnishing water for drinking or domestic purposes, where, perhaps, a brook can be made to elevate water in a small pipe-line to a dwelling or office. A fall of 3 or 4 ft. suffices to operate a ram; the height to which water will be delivered varies from 10 to 30 times the height of the supply, and the amount of water raised is from 1/15 to 1/3 of the flow. The ram is mechanically the simplest self-contained pumping unit known. The principle of operation is that the water by successive flows, made by its rushing down the drive-pipe, forces a portion of itself into the air-dome and up the delivery-pipe. In construction, a ram has an impact-chamber with two valves, one connecting to the air-dome, the other to the outside air. The former is a check-valve preventing water once in the dome or delivery-pipe from returning. The other valve is the waste-valve, and its length of stroke can be adjusted. Water flowing through the impact-chamber and out the waste-valve soon shuts the latter, and goes into the air-dome, where finally the packed air compels successive rebounds, sending the water along the delivery-pipe.

REVIEW OF MINING

As seen at the world's great mining centres by our own correspondents.

LEADVILLE, COLORADO

PROSPECT MOUNTAIN.—DINERO SILVER.—TUNGSTEN.

The Valley adit, which is being driven into Prospect mountain in charge of Warren F. Page, manager of the Valley and Silver Spoon properties in the Big Evans gulch district, is opening a large area of ground that promises to prove as valuable as any of the rich parts of the district developed in the past. During the last two months, the sinking of an interior shaft has been in progress. A winze is being sunk at a point about 1700 ft. from the portal of the adit, and practically in the centre of an area previously explored by a series of drill-holes driven from the lower workings of the Valley shaft. Rich silver and manganese ore was cut by the drills at an estimated depth of from 150 to 250 ft. below the adit-level. The extent of the orebodies could not be ascertained from the cores, and the winze was immediately started to thoroughly prospect the ground. The winze is now in the contact at a depth of 200 ft. The same formations found in the drill-holes has been reached, and ore is expected to appear in the bottom at any time. The exact value of the ore cut by the drills has not been made public, but Mr. Page has stated that it was much better than he expected. The rapid advance in the prices of silver and manganese will greatly increase the value of the ore, and mining men are eagerly awaiting the announcement of another bonanza brought to light with the cutting of the ore in the winze. Prospect mountain will be the scene of great activity this summer. The finding of commercial orebodies in the Valley adit, a happening certain to occur within the next few weeks, will be the signal for starting work on several large adjoining tracts.

The Dinero property on Sugar Loaf is being blocked out and leased. The decision of changing the policy in operating the property was reached at a meeting of the shareholders held recently. The manager, Warren F. Page, has just completed plans for instituting the leasing system. The Dinero has been one of the richest mines in the district, and has paid many dividends. The property has long been famous as the greatest silver mine in the Leadville district. Ore that has carried as high as 5000 oz. of silver per ton has been shipped, and the average value of the entire tonnage taken from the mine is over \$100. Ore in the Dinero and other properties on Sugar Loaf is found in strong fissure veins. Several of these have been cut by the long Dinero adit, and extensive development has been carried on both above and below the level. The property is thoroughly opened, and offers promising opportunities to lessees. Several small parts of the mine now being worked by the company have been retained. The Dinero adit is equipped with first-class electric haulage, and is situated about a mile from the nearest railroad siding. A good road has been constructed to the property, and every convenience has been provided for the transportation of ore. The property is now producing 400 tons a month of high-grade silver ore.

Tungsten exists in the Leadville district. Its presence has been proved by the discoveries of scheelite and hübnerite recently made in the Garbutt and Ibex properties on Breece hill. Bunches of the ore occur in gold vein now being mined in both properties, but as yet no attempt has been made to save it. R. S. Fitch first found the tungsten ore in the Garbutt last fall, when he made a special report on the property. Since that time pockets of the ore averaging 50 to 100 lb. have been

found. A peculiar feature connected with tungsten in Garbutt is the greatly increased gold value in the vein immediately surrounding the tungsten and in the tungsten itself. For this reason there has been no sorting of the ore, and the tungsten is shipped along with the gold ore to the smelters, where it is lost in the slag. It has been estimated that \$100,000 of tungsten has been wasted in this way. Rich tungsten specimens have been received from prospectors throughout the area between Lake and Chaffee counties, south of Twin Lakes. Several important discoveries of tungsten have been made in this district, and it is thought that large deposits of the ore will be found there during the coming spring and summer. Deep snow prevents prospecting in the mountains until late in May. Reports of the discovery of tungsten in the Home-stake district of Eagle county have been received from Red Cliff. This area borders on Lake county on the north-west, and should the reports from across the range prove true, Leadville will no doubt be the source of other discoveries from this side. Mining men are eagerly waiting for the snows to melt so that they can make careful search for tungsten. The Siwatch range to the west is a granite barrier, and offers the most promising field for tungsten.

LEWISTON, MONTANA

BARNES-KING PROPERTIES.—OIL PROSPECTS.

The North Moccasin property of the Barnes-King Development Co. is developed by a shaft 500 ft. deep. The orebody has been followed by winzes 180 ft. below the shaft. The lode varies from a few inches to 50 ft. thick, and in places is 400 ft. wide. It has been followed for over 1000 ft. on the dip. Starting at the surface the orebody pitches about 60°, but flattens out below the 500-ft. level until it becomes almost horizontal. The ore occurs entirely as a replacement in limestone; no porphyry is found in the mine itself. The richest ore, averaging \$25 to \$30 per ton, is found below the 500-ft. level; this ore is of a soft, clayey character, and so carboniferous that roasting is necessary before cyanidation; even then the recovery is not as high as from the oxidized ores of the upper levels. Pumping is unnecessary above 500 ft., and below that the water is all pumped to a sump at the bottom of the shaft. Not long ago this sump was deepened five feet, when a vug was found. The water now drains naturally away through this crevice in the limestone, saving thousands of dollars annually on pumping bills.

The Kendall mine, near the Barnes-King, has been worked for the last nine months by lessees. During this time they have extracted \$40,000 from ore averaging a little less than \$4 per ton. The ore has come entirely from the open-cut, and there is said to be more ore opened now than when work was first resumed. The Barnes-King now owns the Kendall property, but the lease has been renewed for another year. The total output of the Kendall has been \$3,750,000, from which over \$1,500,000 has been paid in dividends.

The Tanberg Oil Co., capitalized at \$100,000, has just been organized. J. C. Tanberg, E. C. Tanberg, and B. F. Hoyt of Thermopolis, Wyoming, and H. L. De Kalb and J. E. Lane of Lewistown are directors. Boring for oil has been started by other concerns south of Judith Gap, near Franklyn in Meagher county. Many leases have been obtained in various parts of

... and adjacent counties. Three well-defined anticlines are found in eastern Pima county along the Musselshell cover. In certain parts of these anticlines a dome structure is found that would seem to be favorable for oil and gas accumulation. The exposed strata varies in age from the Colorado shales (Cretaceous) to the Lance formation of Tertiary age. Several engineers and oil geologists have recently reported on prospects for oil in Pima county to both local and Eastern capitalists. Naturally their reports have not been made public.

QUARTZITE, ARIZONA

Dry Placer Mining Methods

At Quartzite, in Yuma county, a large Quinner-Stebbins dry concentrating plant has been erected to treat the so-called low grade gravel of this district on an extensive scale. The plant may revolutionize the profitable handling of the large placer deposits of the Southwest, where water has always been the principal handicap. In this particular district water is more or less plentiful, both in and about the Quartzite valley (perhaps better known as the Tyson's or the Posas valley) as well as in the Colorado river.

These placers were first discovered about 1865. The town of La Paz was then founded, which later became the seat of Yuma county. In the seventies it supported a population of over 5000 persons, mostly working on placers. It is said that \$1,000,000 in placer gold passed through La Paz between 1865 and 1870.

Owing to the gravel being cemented, the gold is in many parts fairly uniformly distributed throughout the deposits, which vary in thickness from a few feet to 50 ft. The minimum value is placed at 50c. per yard, and the maximum much higher. Present conditions and apparatus leave little profit for the miner.

There is nothing new about the Quinner-Stebbins plant, but rather a combination of different parts, all of which have been in successful use elsewhere. The pulverizer is the invention of Max Quinner and consists of a cylindrical drum rolling on axes slanting, the latter having numerous steel slugs hung on bars in spiral shape. The shafting revolves at 600 r.p.m., while the drum revolves 100 r.p.m. in an opposite direction. The gravel first passes over a large grizzly on a bin above the machine. Cement gravel fed in at one end is quickly pulverized, the fine product dropping through the drum to a bin beneath, while the boulders are thrown out at the other end with great force perfectly smooth. A two-inch rim at end of the drum catches all the heavy gold. The fine material is then taken by elevators to a bin above the Stebbins dry concentrator. Waste from both the Quinner and the Stebbins machines is either dragged away or stacked by drag-line or swinging-stacker.

The Stebbins dry concentrator is the invention of Mr. Stebbins of Los Angeles, California. This machine is conceded to be excellent for dry work. When the dirt is perfectly dry it makes a 95% saving, and is especially good for fine gold. A complete Stebbins plant is in operation on lead-zinc ores at Good Springs, Nevada, replacing a wet plant. The large tables are 12 ft. long, and work practically on the same principle as the dry placer miner manipulates the gold pan, that is, with a jerky motion. This, with a blower beneath, constitutes the chief working parts. The openings in the table where the air enters consist of small slits, so arranged that the blast from below travels upward and over the table. The gold works along the upper riffles, dropping from one to the other until it drops into a receptacle at the end of the table. The second, which contains much black sand and some fine gold, are carried on the second riffles to the end of the concentrator, and then taken automatically back to the bin to be run again over the table. The Quinner pulverizer has a

drying effect on the gravel. The great velocity at which these machines work thoroughly dries even wet gravel.

There are several companies now erecting plants on the Plomosa and La Paz placers. Each has his own method for

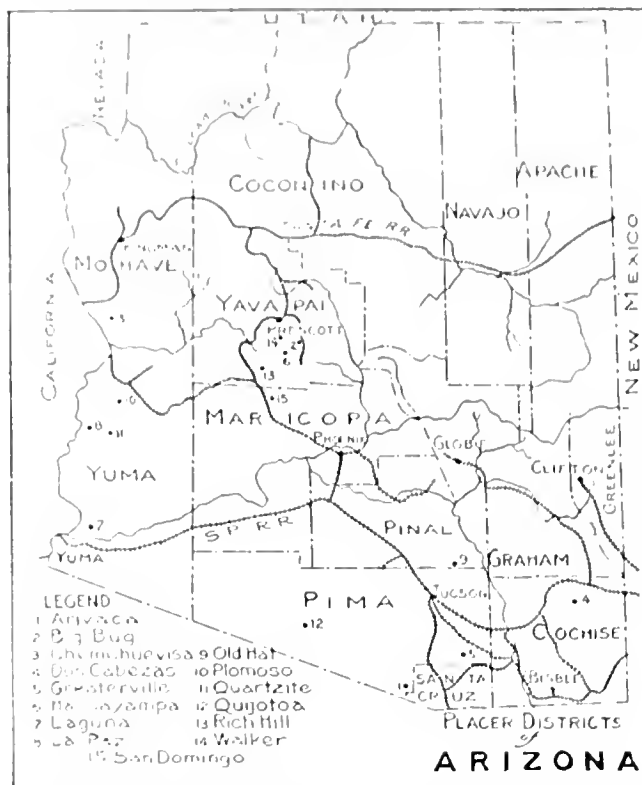

transferring gravel to plant, as well as digging and the taking care of the waste material, but all agree that the Quinner-Stebbins combination is the most necessary part of the plant.

The Plomosa and Yuma Consolidated companies are installing 1000 and 2000-yd. plants respectively. The La Paz company will also erect one.

ATOLIA, CALIFORNIA

PRESENT CONDITIONS IN THE TUNGSTEN CENTRE.

The rush of new people continues here, and is now a regular boom. Atolia has fully 1200 inhabitants. New business firms are being organized nearly every week. The town has four general merchandise stores, two stationery stores and newsstands, three butcher-shops, two lumber-yards, three garages, two theatres, three shoemakers, three barber-shops, three pool-halls, a drug store, two physicians, new sampling and reduction plant, a permanent shooting gallery, large bowling alley, blacksmithing and machine-shop, half-a-dozen commodious hotels for the accommodation of transient trade, besides nine boarding houses and restaurants that take care of the regular miners employed in the district: two weekly papers, the *News* and *Tungsten Review*; a bath-house, bakery, three produce dealers, a second-hand furniture store, three ice-cream parlors, and a saw-mill. Besides these Atolia has two systems that distribute water to the people: ample electricity for light, heat, and power, the rate for heat and power being only 4c. per kilowatt; both mail and express *via* Barstow and Kramer over the Santa Fe, and *via* Mojave by auto-stage and truck-lines, that connect with the Southern Pacific twice each 24 hours; about 20 jitneys ply night and day between Atolia and Randsburg and Johannesburg; a stage runs regularly to Bakersfield and Taft, in Kern county, and regular bus-lines to connect with the Owens River Valley railroad at Rand station, about 8 miles west of Randsburg. There are fully 500 dwellings, composed principally of tent-houses and portable

structures that are especially designed for the desert. The people are law-abiding and desire to keep the place decent.

Three or four surveyors are busy in platting and surveying new claims recently located and old ones that have lain dormant for 20 years. The area of tungsten-producing territory now extends 10 or 12 miles east and west and 5 miles north and south. New finds of tungsten are recorded every week, and the production of ore has increased to over 100 tons daily. The price of ore fluctuates, due to local manipulation, and when offers are not attractive, the miners bury their 'spuds,' as the scheelite nuggets are termed, and patiently await a return to better terms. A combine of the buyers lately refused to buy anything, but outsiders soon wired in their orders and there was a rush to acquire what they knew was stored in and around Atolia.

New activities at Atolia have drawn attention to other mineral resources of this belt in San Bernardino county, and there are hundreds of placer and quartz miners that are finding profitable employment in mining for gold, manganese, and antimony. Several important discoveries have been made. The district proper has been a gold-mining region for 25 years, and has regularly produced from \$500,000 to \$750,000 every year. The Yellow Aster, King Solomon, Windy, Butte, Consolidated, Sunshine, Winnie, Buckboard, Baltic, Napoleon, and Santa Ana, are all mines that have been producing for years.

It is generally considered likely that there will be a return to leasing by the Atolia Mining Co.; those who are in a position to know speak confidently that such is soon to be announced from the head office at San Francisco. Some of the reasons assigned therefor are given as follows: A reduction of expenses in production; better ability to control the sale and price of the product; elimination of all liability in connection with the State law in regard to accident insurance; and the cessation of high-grading, which is now a subject of grave concern. Scheelite, which is regularly stolen in tons from the workings of this company, which has been of such importance to the Atolia district, finds its way through indirect channels to those steel manufacturers who are competing against the plants that derive their tungsten supply from Atolia. Notwithstanding every effort has been made to stop this trouble, there has been but little cessation in the monthly losses of the Atolia company from peculations of both employees and outsiders. It is thought that a change in its employees might solve the problem, and a hundred or more were recently discharged, and this action is pointed out as a direct cause of recent losses disclosed by late arrests and prosecutions of persons 'caught with the goods.'

Outside production, however, goes on apace, and there are individual claims at Atolia that are producing several tons per month, which, in the aggregate, is considerable. All of this goes to Eastern agents, notwithstanding the efforts of local agents to buy it up for those interested in the production by the Atolia Mining Co. Another fact in this connection it is stated is that the Schwab interests, constituting the Crucible Steel Co. of Pittsburg and their auxiliary steel manufacturers, now control the entire product of the Atolia Mining Co., at prices that existed over a year ago, and the recent efforts to depress the market is shown in the refusal of their agents to buy Atolia scheelite. Whatever is correct, outside producers of this district are organizing and already have available several hundred tons that can be bought just now at prices from 75c. to \$1.25 per pound for 60% ore. This quantity is increasing every day and, unless taken up by Schwab auxiliary middle-men, must find its way to competitive steel manufacturers, one of whose agents visited Atolia this week.

On May 10, cash amounting to \$20,000 was stolen from Illingworth & Dunnell, merchants at Randsburg, who also are interested in mines, grubstake prospectors and lessees, and take care of money for customers generally.

PLATTEVILLE, WISCONSIN

NEW PRODUCERS IN THE ZINC REGION.

The following list includes new power and concentrating plants that have commenced service in the Wisconsin field since January 1, those in course of construction, and others planned and to be built:

| Company, Mine, and District | Daily capacity in tons |
|---|------------------------|
| Milwaukee-Linden, Gilman, Linden | 200 |
| Stoner Bros., Stoner, Linden | 100 |
| Optimo No. 3, Rolling, Linden | 200 |
| Burr, Treganza, Benton | 200 |
| Longhenry, Spenseley, Benton | 100 |
| Frontier, Hird, Benton | 200 |
| Monmouth Zinc, Hammil, Hazel Green | 300 |
| Vinegar Hill, Blackstone, New Diggings | 300 |
| Oliver Mining Co., Muleahy, Shullsburg | 300 |
| McMillan Zinc Co., Murphy, Hazel Green | 400 |
| Little Giant, Little Giant, Shullsburg | 100 |
| Coming into service by June 1: | |
| Blockhouse, Cruson, Platteville | 300 |
| Vinegar Hill, Graham, Day Siding | 300 |
| Wisconsin Zinc Co., Birkbeck, Mill Brig | 300 |
| Standard Metals Co., Anthony, Cuba | 200 |
| Sally Mining Co., Sally Waters, New Diggings | 200 |
| Building and complete by July 1: | |
| Wisconsin Zinc Co., Longhorn, New Diggings | 400 |
| Wisconsin Zinc Co., Thompson, New Diggings | 400 |
| M. & A. Mining Co., Big Tom, Mifflin | 300 |
| Saxe Bros., Lampe, Highland | 200 |
| Little Corporal, Burke, Galena | 200 |
| Plans complete, work of building to start at once: | |
| Tiffany Mining Syndicate, Lucky Three, Potosi | 400 |
| New Jersey Zinc Co., Kennedy, Highland | 400 |
| Bell Mining Co., Graham, Platteville | 300 |
| Mineral Point Mining Co., Twin Flats, Mineral Point | 200 |

The Kroll and Red Jacket plants are being restored at Highland; Liverpool at Mineral Point; Weigle at Linden; and Merry Widow, White Rose, and Glen Ridge at Galena. Two new zinc-ore 'refineries' have been completed and put in operation within the past 60 days, one at Mineral Point for the New Jersey Zinc Co., the other for the Galena Refinery Co. at Galena, Illinois.

GOLDFIELD, NEVADA

DRILLING AT THE SILVER PICK.—FLOTATION AT BONNIE CLAIRE.

Considerable interest has been aroused by the intersection of rich ore in the Silver Pick by the Calyx drill. Drilling was started west of the ore-channel traversing the Goldfield Consolidated, and the shale-latite contact was entered at an approximate depth of 1000 ft. The drill first penetrated a zone of quartz and silicified material, showing some gold, and then passed through shale for 40 ft. Below this was 12 ft. of quartz, succeeded by shale. It is stated both belts of quartz yielded some high assays in gold. Preparations have been made to sink the 700-ft. shaft 300 ft. deeper, and commence lateral work.

Tailing at the Bonnie Claire mill is to be treated by flotation, by the lessees G. W. Quigley, J. Manion, and H. M. Clifford. The Jumbo Extension company formerly treated ore at this plant, and the lease includes its tailing also.

Work has been resumed by the Grandma, Cracker Jack, Jumbo Junior, and other companies. The Yellow Tiger is about to start work, and it is reported the Oro will be operated shortly. Black Butte will probably start shipping on a small scale soon.

THE MINING SUMMARY

The news of the week as told by our special correspondents and compiled from the local press.

ALASKA

FAIRBANKS

Work on the railroad from the Fairbanks end is to commence from the Sheep station of the Tanana Valley line, then south toward Nenana. Of the 500 men necessary, 300 can be secured at Fairbanks. It is expected that Nenana coal will be available in the interior within two years.

JULIA

April returns of the mines on Douglas island were as under:

| Results | Alaska Mexican | Alaska Treadwell | Alaska United |
|----------------------|-------------------|---------------------|------------------|
| Stamps dropping | 120 | 540 | 300 |
| Ore crushed, tons | 12,880 | 77,991 | 42,190 |
| Gold by amalgamation | \$10,668 | \$57,991 | \$44,222 |
| Concentrate, tons | 365 | 1,780 | 1,018 |
| Gold by cyanidation | \$9,630 | \$76,257 | \$40,153 |
| Yield per ton of ore | \$1.58 | \$1.72 | \$1.98 |
| Operating expenses | \$22,185 | \$97,608 | \$69,873 |
| Construction | \$3,232 | \$10,492 | \$6,891 |
| Profit | | \$24,838 | \$6,765 |
| Loss | \$5,321 | | |
| Other income | \$3,600 | \$10,801 | \$3,600 |

ARIZONA

In Bulletin 20, by P. E. Joseph, the Bureau of Mines at Tucson, has some interesting notes on zinc. The centre of zinc mining in this State is in Mohave county, where are the Golconda and Tennessee mines, which produced a total of 7000 tons of spelter in 1915. In Pima county the San Xavier and Twin Buttes mines produce some ore. In many scattered districts the metal is found, but at present the deposits are of no commercial value. Bulletin 22, by the same author, deals with antimony. In Arizona, stibnite is found in the Vanderbilt mine, Cerbat district of Mohave county. The mineral occurs often in silver in Yavapai county, and with gold in the Bradshaw mountains. Under prevailing conditions none of the antimony deposits of Arizona are of commercial value.

GLA COUNTY

Special Correspondence.—The Greater Miami Copper Co. has been incorporated with a capital of \$1,555,000; par value of stock \$1 a share, non-assessable. Directors are William S. Warne, Joseph Perry, N. E. Milford, F. E. Pearl, and C. O. Wentworth, all of Miami. Officers are William S. Warne, president; Joseph Perry, vice-president; N. E. Milford, secretary; and F. E. Pearl, treasurer. The company has taken over a group of 20 claims on Mineral Creek, in the Globe-Miami district, formerly belonging to W. R. Jones and Grover Sikes. A great deal of work has been done, and several carloads of shipping ore is on the dump. The ore assays 17% copper, 10 oz. silver, and \$2.75 gold. A permanent camp has been established, and men are employed in development. The Arizona Corporation Commission has authorized the selling of 25,000 shares at 25c. each, and 25,000 at 50c., the first lot being practically all taken locally. It is the intention of the company to list the stock in New York, and Boston early in the fall.

Miami, May 16.

A controlling interest in the Inspiration Needles group of 16 claims and the Prospector group of 32 claims, adjoining

the Southwest Live Oak and Inspiration Consolidated properties at Miami, is to be sold by the owners, D. R. Williamson of Globe and others, and C. E. Phillips and others, respectively. Drilling is to commence at an early date.

YAVAPAI COUNTY

This county contains many mines, but more treatment facilities are necessary, and it has been reported by J. E. Russell, an attorney at Prescott, it is likely that a large smelter may be erected near the town.

The Consolidated Arizona Smelting Co. reports as under for the first quarter of 1916:

| | |
|--|-----------|
| Blue Bell and De Soto mines produced, tons | 25,618 |
| Concentrator treated, tons | 19,369 |
| Smelter treated (custom material included), tons | 20,842 |
| Copper production, pounds | 1,691,000 |
| Silver production, ounces | 21,903 |
| Gold production, ounces | 905 |

Net profits were \$26,312 in January, \$55,771 in February, \$78,395 in March, a total of \$160,478.

Operations during January and February were seriously interfered with by bad weather, making it impossible to maintain regular shipments.

MOHAVE COUNTY

With the Big Jim, United Eastern, and Gold Ore mines developing ore of unusually high value for the Oatman district, with the Carter seemingly just entering its vein on the 350-ft. level, with the Fessenden, Ivanhoe, and United Western expecting to cut their veins at any time on the 500-ft. levels, and with the Boundary Cone driving in its main vein on the new 750-ft. level, optimism in this district is tremendous. In addition to the above developments, the Tom Reed has developed an important orebody on its new 600-ft. level in the Black Eagle workings. More than 100 companies are sinking shafts, their objective points being anywhere from 300 to 600-ft. depth. A number of companies have started lateral work at depths ranging from 300 to 400 ft., but these laterals are as a rule mainly exploratory to enable the operators to keep in close touch with the character of the formation. Building operations continue in Oatman, and machinery is continually arriving. During the last ten days not less than 14 machinery equipments arrived in the district, the hoists ranging from 25 to 40 hp., and the compressors from 300 to 500-cu. ft. capacity. It is estimated that more than 2000 miners are employed at present in the Oatman district, and that more than \$25,000 per day is being expended for wages and machinery.

A new gold discovery is reported from the Black Range mountains, 64 miles north-east of Kingman by road, where F. E. Young and C. G. Walker have a rich though small vein.

On May 11 *The Chloride Herald* made its first appearance at the promising centre of Chloride, north of Kingman, on the Santa Fe railroad. In a review of conditions in the district, the editor of the new paper, Anthony McCauley, says that "Chloride has awakened from her 30-year period of coma * * * and again is ready for years of activity." The most important mines near-by are the Golconda and Tennessee—both zinc producers—while the Payroll, Midnight, Schuykill, Elkhart, Distaff, Molly Gibson, New Jersey, Empire, Keystone, Comanche, Schenectady, and Rainbow are opened to 300 to 600 ft. depth, exposing a large quantity of good gold-silver ore.

Chloride gets its name from the character of the ore found in the district. In the early days millions in silver was extracted in a few years. The ore was taken overland to the Colorado river, floated down to tidewater, and sent by sailing-vessels to Swansea, Wales, for treatment. During this period of the camp's existence the Indian tribes caused the settlers

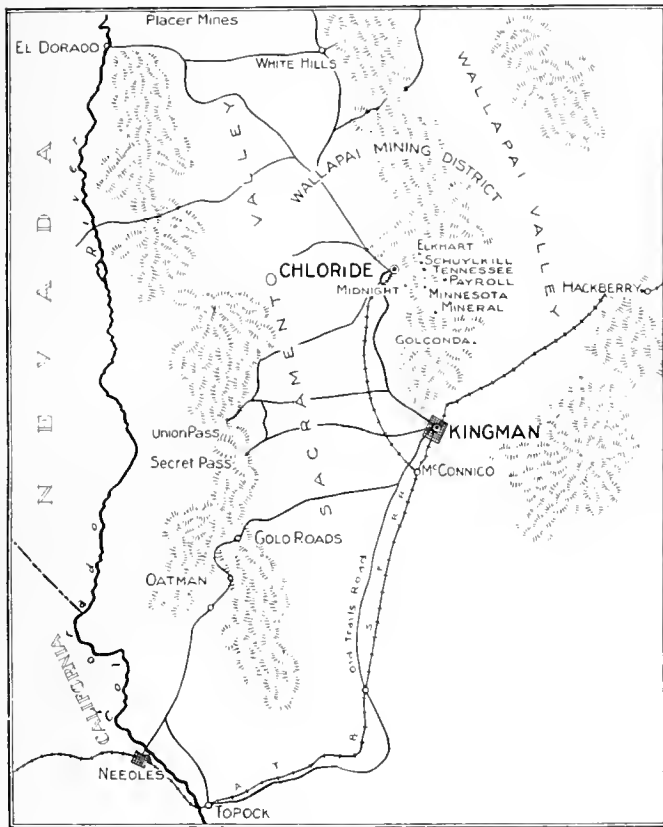

MAP OF CHLORIDE DISTRICT, ARIZONA.

trouble and several lives were lost. The Chloride Mining Bureau has issued a pamphlet on the Wallapai district, of which Chloride is the main distributing point, briefly describing the principal producers. A list is given of the mines, their depth, and total production. The output in 1915 was \$3,000,000; estimates for 1916 place this at \$7,000,000.

YUMA COUNTY

It is possible that a 200-ton smelter may be erected at Parker by a syndicate represented by A. L. Kreiss, who is now investigating the ore supply.

CALIFORNIA

Oil production of this State in April amounted to 7,372,480 bbl. against 7,525,081 bbl. in March. Stocks declined from 54,436,065 to 53,022,830 bbl. There were 6368 producing wells, while 21 were abandoned, 53 completed drilling, 220 were drilling, and 77 had rigs up. These figures are from the Independent Oil Producers Agency.

AMADOR COUNTY

(Special Correspondence.)—Electric transformers have been installed at the old Eureka mine, and the hoist and compressor are being wired. Three motor-driven sinking pumps will be used to unwater the mine, but until this installation is completed drainage of the shaft will continue by baling. A modern steel head-frame will replace the temporary hoist now in use as soon as practicable. The manager, T. Walter Beam, has a few men engaged in installing pumps and other machinery, erecting buildings, and at other preliminary work. W. Morgan, who has had charge of surface construction work

since February, has returned to Colorado, where he is to erect a mill.

Unwatering of the old Rose or Poundstone mine, a mile east of Sutter Creek, continues. The Sutter Creek Mining Co. has an option on the property from L. R. Poundstone, and has a small crew at work re-opening the old shaft near the summit of the hill north of the shaft, through which the last work was done. This mine is equipped with a 10-stamp mill. Alexander Rennie is supervising the work.

Ten stamps of the old Oneida mill have resumed crushing as a result of the ore developed in that property below the level of the drift connecting with the South Eureka mine. The South Eureka company owns both properties, and is contemplating an increase in the number of stamps at the Oneida for the more economical treatment of orebodies east of the main South Eureka workings. H. Malloch is general manager, and W. H. Schmal superintendent of the combined properties. Ninety stamps are in operation, and from 250 to 300 men are employed.

Sutter Creek, May 23.

KERN COUNTY

The annual meeting of shareholders of the Yellow Aster Mining & Milling Co. was held at Los Angeles on May 16. The Aneker-Mooers-Burcham faction voted 75% of the stock, and elected the following directors: Albert Aneker, E. D. Mooers, W. J. Cotton, R. L. Burcham, E. L. Kenney, R. A. Dallugga, C. G. A. M. de Pauw. At the meeting of directors, held the next day, the following officers were elected for the year: Albert Aneker, president; E. D. Mooers, vice-president; W. J. Cotton, 2nd vice-president and managing director; and R. L. Burcham, secretary. The 100-stamp mill is crushing 500 tons of ore daily, yielding up to \$40,000 per month by amalgamation. Improvements are contemplated at the plant to eliminate waste from the ore.

NEVADA COUNTY

With a capital of \$200,000, the Cassidy Mines Co. has been formed by San Francisco men, with M. Walters as president, to develop the Cassidy and Linden veins, parallel to and between the Empire and W. Y. O. D. at Grass Valley.

Capital has been secured for his Elsie A. mine by Thomas Nolan of the Narrow Gauge railway.

A rich shoot is said to have been cut in the Champion mine.

The Pittsburg mine, about a mile from Nevada City, has been sold by the Weissbein family to the Schlessinger brothers of San Francisco. H. Oates is in charge.

It is proposed to hold a first-aid contest at Nevada City on July 4.

PLUMAS COUNTY

The Walker Copper Co. is being sued by J. C. Gladden for \$200,000, alleged to be due under an agreement with J. R. Walker, who, later on, became connected with J. F. Cowan of Salt Lake City in the property.

SHASTA COUNTY

For the sum of \$85,000, and paying delinquent taxes amounting to \$13,000, the Stowell mine has been acquired by the Mammoth Copper Co. from Mrs. H. M. Rose of Auburn, acting for the estate of her deceased brother J. H. Stowell, who located the claims.

Redding people have organized the Shasta National Copper Co. to develop property adjoining the Mammoth company.

SIERRA COUNTY

Owing to the re-opening of a number of mines near Sierra City there is considerable optimism in the district.

TRINITY COUNTY

The option on the Globe Consolidated mine at Dedrick, held by the Crown Reserve company of Cobalt, Ontario, has been dropped.

COLORADO

COEUR D'ALENE COUNTY

(Special Correspondence.)—Work is about to be resumed on the Red Oak property. The Sceptre and Sunburst adits will be reworked and connected by a raise. The Ader mine lying on the apex of the mountain, between the Sceptre and Sunburst will also be overhauled. This mine, famous for the high grade silver ore in past years, belongs to the Red Oak company. Work will be in charge of Mr. Hershey of Idaho Springs. Also the names are in working order the intention is to rebuild the old aerial tramway from the mine to the base of the mountain and there build a concentrating mill on the site of the one burned many years ago.

Frank Kacer has leased the third level of his Mascotte mine, where there is a 4 ft. vein of lead-copper ore, about 1 ft. of which is solid smelting ore of high grade. He has men starting a fourth level, some 150 ft. above the wagon-road. When the orebody is out, and after tests have been made, he will erect a small mill to treat the lower grade ore.

Up 120 ft. in No. 3 raise in the Onondaga mines, a 3-ft. ore body has been opened, which is improving as progress is made. On the 180 ft. level the vein is 4 ft. wide. The general manager, Tallmadge Kynor, expects when these shoots have been sufficiently developed that a mill will be needed. Ore is now shipped to the Hudson mill at Idaho Springs at the rate of a carload a day netting \$8 per ton. No sorting is done.

Sampling of the Colorado Central dumps and mine is progressing satisfactorily. Some of the zinc ore in the dumps assays 61% metal.

Georgetown, May 13.

LAKE COUNTY (LEADVILLE)

Drainage projects at Leadville are at the following stage:

The Wolfson pumps are discharging 2100 gal. of water per minute. Good progress is reported at the Harvard shaft on Fryer Hill. Water stands at 375 ft., leaving 50 ft. to be unwatered. In 52 days 117 ft. was drained. At the Down Town company's Penrose shaft the water is nearly all out, at a depth of 780 ft. This work occupied 53 weeks. The efficacy of electric centrifugal pumps was thoroughly proved in this work. The old station, at 780 ft. is to be cleaned. If the metal markets get weaker, these companies that are to re-open old and explore new ground when unwatering is completed, will suffer considerably, as the projects were started with high prices prevailing.

The First National in Iowa gulch has sent its first lot of lead-silver ore to the Arkansas Valley smelter.—The Hex also sent some gold ore from the Connors lease.

IDAHO

OWYHEE COUNTY

The old South Mountain property, 29 miles south-west of Silver City is being framed by Stanley A. Easton of the Bunker Hill & Sullivan company. In its Golconda mine are good shoots of lead-silver ore.

SHOSHONE COUNTY (COEUR D'ALENE)

For the first quarter of 1916 the Consolidated Interstate Callahan Mining Co. reports as follows:

| | |
|---|-------------|
| Ore milled, tons (28.15% zinc) | 26,514 |
| Lead concentrate shipped, tons (59.4% lead, 19.85 oz. silver) | 503 |
| Zinc concentrate shipped, tons (49.12% zinc) | 12,972 |
| Crude ore shipped, tons (59.14% zinc) | 2,219 |
| Net value of shipments | \$1,029,149 |
| Profit | \$12,783 |
| Dividends declared for half-year (\$3 a share) | 1,394,979 |
| The total cost per ton of ore mined was | \$7.06 |

Mill recovery improved from 82 to 88%. The president, John A. Percival, says in his report: "We are gratified to

state that the litigation in which the company has been involved during the past year in the State of Idaho has been settled favorably to the company's interests, so that there is now nothing in the way to prevent the early listing of the stock of the company on the Eastern exchanges."

A 150-ton mill is to be built at the Constitution mine in the Pine Creek district. Good lead and zinc veins are being developed.

From its first carload of antimony concentrate the Coeur d'Alene Antimony Mining Co. on Pine creek received \$2781 net. The mill is working 10 to 12 hours daily. Twenty men are employed. Electric power will soon be available from the Washington Water Power Co. The company's capital is to be increased. The debt is \$35,000.

MICHIGAN

THE COPPER COUNTY

(Special Correspondence.)—The Mohawk company has purchased from the Roebling interests 900 acres of Torch Lake shoreland, with a mile over to Portage lake. It is a good site for a mill, and gives good dockage on the latter lake.

Ore from the Champion mine is yielding 37 lb. of refined copper per ton. Baltic ore gives 31 lb. The Trimountain mill is being re-built slowly. These are Copper Range properties.

At the Ahmeek mill 8 stamps will soon be ready to crush ore, and the daily quantity is estimated at 5600 tons, next to Calumet & Hecla and Copper Range in output.

At a depth of 1230 ft. the conglomerate has been cut in the New Baltic by drilling. A shaft is to be sunk at once.

Houghton, May 17.

MISSOURI

JASPER COUNTY

On the 1000 acres of land recently bought by J. Breigle and others west of Webb City 20,000 ft. of drilling is to be done.

The Cisco Mining Co., leasing land west of Prosperity, has started its 1000-ton mill (oper 24 hours). It is thoroughly modern and electrically driven, motors totaling 1200 hp. The jigs are the largest in the district, with cells 48 in. wide and 42 in. deep. The cleaner jigs are 31 by 12 in. Concentrate contains 60% metal. A complete sludge plant has been erected. Ore is mined at a depth of 250 ft., the face being 18 ft. high. The average content is 3% zinc and lead.

During the third week in May the market for zinc-blende sold from \$65 to \$100 per ton, basis of 60% metal. The output of the Joplin district was 5862 tons blende, 68 tons calamine, and 1978 tons lead, averaging \$86, \$55, and \$95 per ton respectively. The total value was \$612,038.

MONTANA

From Madison county on the south to the Little Rockies on the north, and from the Kendall district on the east to Saltese on the west, mining districts of this State are increasing in activity. A dozen centres that were idle two years ago are now as busy as possible.

BEAVERHEAD COUNTY

A rush has set in to a gold discovery near Redrock, on the Oregon Short Line, 30 miles south of Dillon.

BROADWATER COUNTY

Near Radersburg the Keating Gold Mining Co. is to erect a 50-ton stamp-mill. The mine is well developed by a 1200-ft. shaft and adits.—Work is soon to start on the Black Friday mines near-by, recently acquired by Breitung & Co. of New York.

SILVERBOW COUNTY

A cross-cut on No. 22 level of the North Butte mine has passed through a new vein over 4 ft. wide, assaying 10% copper and 8 oz. silver per ton.

On May 22 the Tuolumne Copper Mining Co. closed a deal absorbing the Butte-Main Range, Colusa-Leonard Extension,

and other ground in the producing area of Butte, a total area of over 80 acres, worth \$1,000,000. The Main Range has a shaft 716 ft. deep, and is fully equipped.

During April the Butte & Superior mill treated 50,000 tons of ore, yielding 12,080 tons of concentrate worth \$83.79 per ton. In April 52,089 tons was treated.

NEVADA

ELKO COUNTY

Operations in the Gold Circle district are steadily increasing. At the Elko Prince the cyanide plant has produced considerable gold. The mine contains a fair quantity of good gold-silver ore.—Developments are said to be particularly encouraging at the Eastern Star, June Bell, Rex, Esmeralda, and others. Leasing is done to some extent.

ESMERALDA COUNTY

Final figures of the Goldfield Consolidated company's April operations show the profit to be \$60,041 from 39,400 tons of ore treated. Costs were \$4.94 per ton. Development covered 2865 ft. at \$5 per foot. Nothing of importance is reported from this work.

HUMBOLDT COUNTY

On October 31, 1915, the Rochester Mines Co. owed \$200,000 for development and mill construction; on May 15, 1916, it was free of debt. With silver at 75c. per oz. the monthly profit is \$25,000.

At the La Tosca mine in the Humboldt range, 10 miles south-east of Oreana, the main adit is in 2800 ft., a vertical depth of 1345 ft. A third vein has been cut. John Newman is in charge for the Humboldt Consolidated Mining Co. of Chicago.

Many discoveries of tungsten ore are reported from scattered parts of this county. The Beeson mine, 25 miles south-west of Lovelock, is to have a mill on the edge of Humboldt sink, near the plant at Toy. Teams and a Holt tractor are hauling 500 tons of tungsten ore from the mine for shipment to Utah.

In the year ended April 30, 1916, the Seven Troughs Coalition company's revenue amounted to \$337,577, of which \$98,978 was clear profit. The 1600-ft. level north drift is opening very rich ore.

NYE COUNTY (TONOPAH)

In the week ended May 27 the district produced 9400 tons valued at \$194,460.

At the Extension the additional 10 stamps have been tested, but the tube-mill, agitators, etc., will not be ready until early in July.

During April the Belmont treated 12,335 tons of ore, yielding 234,727 oz. bullion, and a profit of \$103,300.—The Tonopah company treated 7364 tons for a profit of \$59,100. Out of 100 stamps an average of 72 was crushing last week.—The Extension milled 7232 tons for 176,819 oz. bullion, and a profit of \$89,863.

In the winze below the 1200-ft. level of the Tonopah company's Sand Grass claim the vein is 8 ft. wide, of good grade.

The Umatilla-Tonopah Mining Co. and Montana-Tonopah Mining Co. are to organize a new company to work part of both properties. It is to be called the After All Mines Co.

STOREY COUNTY

On May 23 fire broke out on the 1400-ft. level of the Yellow Jacket mine, on the Comstock, resulting in four miners dying from fume and injuries. Twelve others were rescued. A fuse blew-out in the motor-driven compressor station, setting fire to the timber.

WHITE PINE COUNTY

(Special Correspondence.)—The Nevada Consolidated is crowding production, treating 12,000 tons per day. All but about 1500 tons comes from steam-shovel operations, the balance from the Ruth mine underground work. There is much

trouble in holding the ground as it swells, breaking the timbers in a few days. It is understood that the company is to 'glory-hole' from underground certain sections on a level by itself. It is a question, if eventually other methods will not have to be adopted at the Ruth.

On the Consolidated Copper Mines, old Giroux, adjoining the Nevada Consolidated, two drills are in operation, just west and a little south from the Morris. It is reported that a large body of high-grade sulphide ore has been encountered. Shares have risen to \$3 from less than \$2 each. Rumors are that the litigation has been settled with Colonel Wall and something may be doing later.

There is generally much activity throughout the county, more prospectors in the hills than for many years. While the tungsten areas are attracting the most of them, others are looking for anything in lead or silver. The old Pleadas mine, adjoining the Ward, 18 miles south of Ely, is being put in shape for resumption of work.

It is the intention to start work on the Argus at the old camp of Taylor, across the valley from Ward. This mine had a production in the 80's of \$1,000,000 in silver. The adjoining mine, the Monitor, produced about the same. Neither is over 250 ft. vertical depth. A mill is being erected on the Piedmont property in Spring valley, on the east side of the Shell Creek range. Most of properties that have any showing are being worked.

The tungsten boom has subsided somewhat owing to the drop in prices, but most of those interested are confident of profits from the larger milling grade properties.

Ely, May 20.

OKLAHOMA

TULSA COUNTY

At the smelter of the U. S. Zinc Co. at Sands Springs 450 men demanded a 10% rise in wages last week, and struck. The furnaces are now out of commission.

OREGON

JOSEPHINE COUNTY

The Waldo copper mine has been unwatered and is now being examined. The lower adit has been under way for several months to complete the drainage. At the same time the upper levels yielded some high-grade ore.

UTAH

JUAB COUNTY

During May the Tintic district produced 46,400 tons of ore valued at \$1,125,000. There were 35 shippers.

SALT LAKE COUNTY

The Clement property of 65 acres, in the centre of the Big Cottonwood district has been acquired by the Alta Tunnel & Transportation Co.

The Utah Metals & Tunnel Co.'s mill is treating 225 tons of ore daily. Monthly profits are over \$100,000. A flotation plant may be added. Mine development continues good.

Most of the Alta mines are in better physical condition than ever before. At the South Hecla is 2250 tons of ore, worth \$30 to \$35 per ton, ready for shipment. Teams are hauling the first ore for the season out of American Fork canyon.

SUMMIT COUNTY

At Park City the Daly West mill is again in operation, there being an ample water supply.

During May the district produced 8214 tons of ore worth \$350,000. There were 7 regular shippers.

CANADA

BRITISH COLUMBIA

To support the Mines Development Act, now before the Legislature, the minister of mines, L. A. Campbell, spoke in its

favor before the House last week. The object of the bill is assistance to prospectors by the supplying of money for the construction of roads, trails, and bridges to facilitate development and operation of claims, the mineral value of which warrants assistance, and to carry out which the sum of \$200,000 will be set aside. An investigation of the iron ore deposits on Vancouver island is under way, while the establishment of iron and steel works is to be considered.

ONTARIO

(Special Correspondence.)—Part of the Gillies timber limit, embracing about 8000 acres, adjacent to Cobalt, has been thrown open for prospecting and staking. From time to time sections of the limit have been opened for prospectors, and some development done, but hitherto mining operations have met with little success.

The Beaver Consolidated deep shaft is now down nearly 1600 ft. It will shortly be decided whether the polley in sinking to the lower contact between the diabase and Keewatin formations is justified. The monthly rate of sinking is 70 to 75 ft.

Toronto, May 29.

KOREA

The Kapsan Mining Concession, controlled by Messrs. H. H. Colbran, H. R. Bostwick, and associates has been sold to the Kuhara Mining Co., which ranks with the Fujita as the largest copper enterprise in Japan. The concession covers about 600 square miles and includes a developed copper mine 500 ft. deep, together with other prospects. The price was \$3,000,000. The Japanese have been nibbling at the property for several years and it is understood that the Government at Tokyo is behind the deal.

MEXICO

HIDALGO

(Special Correspondence.)—Early in May a strike of miners started at Pachuca. They demanded the old rate of wages, paid in silver. The value of the paper *peso* is about 2½ cents U. S., but the Mexican government is to issue new paper, printed in the United States, to replace the present circulation. It was said that the new money would be guaranteed by the Government, making the *peso* worth 10 *centavos Oro Nacional*, but it was later admitted that the value would fluctuate. All railway fares and freight are payable in *Oro Nacional* or its paper equivalent. This resulted in quadrupling the fare from Mexico to the U. S. border. Trains will not be so crowded now, as everybody cannot get 'passes.' Stamp duties have also been doubled temporarily.

Pachuca, May 9.

Later news states that the strike at Pachuca was settled in a few days.

The U. S. Civil Service Commission announces an open competitive examination for metal-mining engineer for the Bureau of Mines, for service in the field, at a salary ranging from \$2400 to \$3600 per annum. Applications must be filed with the Commission at Washington, D. C., by June 20.

The U. S. Civil Service Commission announces an open competitive examination for mineral technologist in the Bureau of Mines, at \$2400 to \$3600 per annum. Applications must be filed with the Commission at Washington by June 13.

The San Francisco section of the A. I. M. E. met on May 31. Members of the A. I. M. E. were invited. Slides at Panama were discussed by J. C. Branner of Stanford University.

The ninth annual meeting of the MINE INSPECTORS' INSTITUTE of the United States will convene at Joplin, Missouri, on June 13.

PERSONAL

A. A. The Editor invites members of the profession to send him particulars of their work and appointments. This information is of unquestioned interest to our readers.

ROBERT HAWKINS is at Philadelphia.

N. H. RUBY of Butters Salvador Mines, Ltd., is here.

R. S. BURSTON has returned to Petrograd from the Lena.

HOWARD D. SMITH is examining mines at Alleghany, California.

A. D. MOIR, mining engineer with the Shell Oil Co., is at the Court Hotel.

W. T. BYSSETT is re-opening the old silver mines in Socorro mountain, New Mexico.

H. G. OFFICER of New York is on his way to Chile for the Andes Exploration Company.

BENNETT R. BATES, on the staff of H. L. HOLLIS, has been transferred to the Chicago office.

JOHN W. MICHIE has gone to Ecuador, on a periodical visit of inspection to the Zaruma mines.

FRED HELLMAN'S departure from New York for South America is postponed until June 10.

EDWARD L. STENGER has returned to Berkeley from the Sissert mine in the Ural Region, Russia.

HENRY B. LOWE and C. C. COMPTON, both from Denver, are inspecting mines at Alleghany, California.

RICHARD A. PARKER has returned to Denver after a month spent in New York, Boston, and Cleveland.

C. B. NICCOLTS, of Chicago, who has been at Lovelock, Nevada, in connection with the tungsten properties, is here.

V. H. SMITH, recently with the Butte & Superior company, is now superintendent for the Beaver Creek Mining Co., at Zortman, Montana.

J. J. MARLIN, general manager of the Chiksan Mining Co., is returning to Korea by the *Empress of Russia*, sailing from Vancouver on June 15.

W. H. SEAGRAVE, formerly manager of the Kennecott mines, is now general manager of all the Kennecott Copper Corporation's mines in Alaska.

J. W. SHERWIN has been appointed general superintendent of the West End and Halifax mines at Tonopah, succeeding the late J. W. CHANDLER.

R. R. LESLIE, manager of Butters Divisadero Co., sailed from New York for London by the *Philadelphia* on May 20, and will return to America in about three weeks.

R. B. WATSON has resigned his position as general manager of the La Rose Consolidated. He is succeeded by G. C. BAYEMAN, who has been acting as field engineer for the company, and was previously connected with the Canadian Mining & Exploration Company.

EDWARD W. RAAB, formerly superintendent of the Tennessee mine at Chloride, has been appointed general manager for the Tom Reed Gold Mines Co., in place of S. S. JONES, resigned. CHARLES GRIMES, president of the Tom Reed for about 10 years, has retired, W. B. MOERBYKE, of Pasadena, succeeding him. [Mr. Grimes died since this note was written, on May 29.]

LOUIS BAIRD, formerly at Guadalajara, well known in Mexico for his excellent work as a mining engineer in Jalisco, and recently mill superintendent for the Cinco Minas company, has been killed in action with the British expedition in Mesopotamia, where he was serving as lieutenant in the Royal Field Artillery.

D. M. TOMLINSON, holding the rank of major in the Royal Engineers, has been killed while serving in Flanders. He was general manager for the Kapsan Mining Concession, in Korea.

THE METAL MARKET

METAL PRICES

San Francisco, May 31.

| | |
|---|-----------|
| Antimony, cents per pound | 37.50 |
| Electrolytic copper, cents per pound..... | 31 |
| Pig lead, cents per pound..... | 7.75—8.75 |
| Platinum: soft metal, per ounce..... | \$80 |
| Platinum: hard metal, 10% iridium, per ounce..... | \$81 |
| Quicksilver: per flask of 75 lb..... | \$75 |
| Spelter, cents per pound..... | 22 |
| Tin, cents per pound | 50 |
| Zinc-dust, cents per pound | 30 |

ORE PRICES

San Francisco, May 31.

| | |
|--|-------------|
| Antimony: 50% product per unit (1% or 20 lb.).... | \$1.75 |
| Chrome: 40% and over, f.o.b. cars California, per ton..... | 11.00—15.00 |
| Magnesite: crude, per ton | 7.00—10.00 |
| Magnesite: calcined, per ton | 25.00—30.00 |
| Tungsten: 60% WO ₃ , per unit..... | 30.00—40.00 |

At Boulder, Colorado, the only sales of tungsten ore are by lessees under contract at \$50 per unit.

Cobalt averaged \$1.50 per pound at Cleveland, Ohio, last year. This is the price of the metal today.

New York, May 25.

Antimony: Dealers quote \$2.50 per unit for all positions, a level maintained by high ocean freight rates.

Tungsten: A New York dealer (Charles Hardy) writes: "The market has experienced in the past week a most severe drop. The sudden stopping of all buying by the most important users of tungsten ore has brought about a decline which was accelerated by the fear of speculative holders that the market would break away altogether. Instead of withholding offers for a time, they pressed their offers at reduced prices until ultimately \$40, immediate delivery, was reached. At this figure a little buying has taken place and prices now range from \$40 to \$45 for prompt and forward delivery, but it is still difficult to find buyers. The increased production is discounted by the reduction of prices, and as the demand continues the quotation should remain steady for some time." South American mines are curtailing production on account of drop in prices. As there is continued demand for ferro-tungsten, dealers look for an improved market for ore.

Tin: Arrivals of tin ore are reported at New York, but there is no market, and it is stated that the ore will be stored awaiting demand. Where this market will develop does not appear, inasmuch as the A. S. & R. Co. has covered its requirements for some months to come.

EASTERN METAL MARKET

(By wire from New York.)

May 31.—Re-sale offerings have weakened the copper market; lead is dull; spelter is neglected and weak.

SILVER

Below are given the average New York quotations, in cents per ounce, of fine silver.

| | |
|-------------------|---------------------|
| Date. | Average week ending |
| May 24..... | 71.50 |
| " 25..... | 71.50 |
| " 26..... | 71.37 |
| " 27..... | 71.12 |
| " 28 Sunday..... | 70.62 |
| " 29..... | 70.62 |
| " 30 Holiday..... | 68.75 |
| " 31..... | 68.75 |

Monthly averages.

| | | | | | | |
|-----------|-------|-------|-------|------------|-------|-------|
| 1914. | 1915. | 1916. | 1914. | 1915. | 1916. | |
| Jan. | 57.58 | 48.85 | 56.76 | July | 54.90 | 47.52 |
| Feb. | 57.53 | 48.45 | 56.74 | Aug. | 54.25 | 47.11 |
| Mch. | 58.01 | 50.61 | 57.89 | Sept. | 53.75 | 48.77 |
| Apr. | 58.52 | 50.25 | 64.37 | Oct. | 51.12 | 49.40 |
| May | 58.21 | 49.87 | 74.27 | Nov. | 49.12 | 51.88 |
| June | 56.43 | 49.03 | | Dec. | 49.27 | 55.34 |

A reaction in silver is still apparent; but the undertone is good, due to continued buying for coinage, a great deal of which has been almost without limit in price. Indian "bull" speculators rushed in at the top of the market to take profits, and owing to a temporary slackening of coinage demand the market fell. The new regulations in Mexico forbidding export of silver as bullion should eventually benefit the market.

Silver stored by the Tonopah Belmont company at the be-

ginning of March amounted to 980,794 oz. The Tonopah Mining Co. had \$431,011 on the same date, calculated at 50c. per ounce.

COPPER

Prices of electrolytic in New York, in cents per pound.

| | |
|-------------------|---------------------|
| Date. | Average week ending |
| May 24..... | 28.75 |
| " 25..... | 28.50 |
| " 26..... | 28.25 |
| " 27..... | 28.00 |
| " 28 Sunday..... | 28.00 |
| " 29..... | 28.00 |
| " 30 Holiday..... | 28.00 |
| " 31..... | 28.00 |

Monthly averages.

| | | | | | | |
|-----------|-------|-------|-------|------------|-------|-------|
| 1914. | 1915. | 1916. | 1914. | 1915. | 1916. | |
| Jan. | 14.21 | 13.60 | 24.30 | July | 13.26 | 19.09 |
| Feb. | 14.46 | 14.38 | 26.62 | Aug. | 12.34 | 17.27 |
| Mch. | 14.11 | 14.80 | 26.65 | Sept. | 12.02 | 17.69 |
| Apr. | 14.19 | 16.61 | 28.02 | Oct. | 11.10 | 17.90 |
| May | 13.97 | 18.71 | 29.02 | Nov. | 11.75 | 18.88 |
| June | 13.60 | 19.75 | | Dec. | 12.75 | 20.67 |

LEAD

Lead is quoted in cents per pound, New York delivery.

| | |
|-------------------|---------------------|
| Date. | Average week ending |
| May 21..... | 7.25 |
| " 25..... | 7.25 |
| " 26..... | 7.25 |
| " 27..... | 7.25 |
| " 28 Sunday..... | 7.25 |
| " 29..... | 7.25 |
| " 30 Holiday..... | 7.25 |
| " 31..... | 7.25 |

Monthly averages.

| | | | | | | |
|-----------|-------|-------|-------|------------|-------|------|
| 1914. | 1915. | 1916. | 1914. | 1915. | 1916. | |
| Jan. | 4.11 | 3.73 | 5.95 | July | 3.80 | 5.59 |
| Feb. | 4.02 | 3.83 | 6.23 | Aug. | 3.86 | 4.67 |
| Mch. | 3.94 | 4.04 | 7.26 | Sept. | 3.82 | 4.62 |
| Apr. | 3.86 | 4.21 | 7.70 | Oct. | 3.60 | 4.62 |
| May | 3.90 | 4.21 | 7.38 | Nov. | 3.68 | 5.15 |
| June | 3.90 | 5.75 | | Dec. | 3.80 | 5.34 |

The Bunker Hill & Sullivan company distributes \$163,500 on June 3.

QUICKSILVER

The primary market for quicksilver is San Francisco, California being the largest producer. The price is fixed in the open market, according to quantity. Prices, in dollars per flask of 75 pounds:

| | |
|------------|-------------|
| Date. | Week ending |
| May 2..... | 115 |
| " 9..... | 190 |

| | |
|-------------|----|
| May 16..... | 90 |
| " 23..... | 75 |
| " 31..... | 90 |

| | | | | | | |
|-----------|-------|-------|--------|------------|-------|--------|
| 1914. | 1915. | 1916. | 1914. | 1915. | 1916. | |
| Jan. | 39.25 | 51.90 | 222.00 | July | 37.50 | 95.00 |
| Feb. | 39.00 | 60.00 | 295.00 | Aug. | 80.00 | 93.75 |
| Mch. | 39.00 | 78.00 | 219.00 | Sept. | 76.25 | 91.00 |
| Apr. | 38.90 | 77.50 | 141.60 | Oct. | 53.00 | 92.90 |
| May | 39.00 | 75.00 | 90.00 | Nov. | 55.00 | 101.50 |
| June | 38.60 | 90.00 | | Dec. | 53.10 | 123.00 |

ZINC

Zinc is quoted as spelter, standard Western brands, New York delivery, in cents per pound.

| | |
|-------------------|---------------------|
| Date. | Average week ending |
| May 24..... | 15.00 |
| " 25..... | 14.75 |
| " 26..... | 14.62 |
| " 27..... | 14.25 |
| " 28 Sunday..... | 14.25 |
| " 29..... | 14.25 |
| " 30 Holiday..... | 14.25 |
| " 31..... | 14.25 |

Monthly averages.

| | | | | | | |
|-----------|-------|-------|-------|------------|-------|-------|
| 1914. | 1915. | 1916. | 1914. | 1915. | 1916. | |
| Jan. | 5.14 | 6.30 | 18.21 | July | 4.75 | 20.54 |
| Feb. | 5.22 | 9.05 | 19.99 | Aug. | 50.20 | 31.37 |
| Mch. | 5.12 | 8.40 | 18.46 | Sept. | 33.10 | 33.12 |
| Apr. | 4.98 | 9.78 | 18.62 | Oct. | 30.40 | 33.00 |
| May | 4.91 | 17.03 | 16.91 | Nov. | 33.51 | 39.50 |
| June | 4.84 | 22.20 | | Dec. | 33.60 | 38.71 |

TIN

Prices in New York, in cents per pound.

| | |
|-----------|---------------------|
| Date. | Average week ending |
| Jan. | 37.85 |
| Feb. | 39.76 |
| Mch. | 38.10 |
| Apr. | 36.10 |
| May | 33.29 |
| June | 30.72 |

Monthly averages.

| | | | | | | |
|-----------|-------|-------|-------|------------|-------|-------|
| 1914. | 1915. | 1916. | 1914. | 1915. | 1916. | |
| Jan. | 37.85 | 34.40 | 41.76 | July | 31.60 | 37.38 |
| Feb. | 39.76 | 37.23 | 42.60 | Aug. | 50.20 | 31.37 |
| Mch. | 38.10 | 48.76 | 50.50 | Sept. | 33.10 | 33.12 |
| Apr. | 36.10 | 48.25 | 51.49 | Oct. | 30.40 | 33.00 |
| May | 33.29 | 39.28 | | Nov. | 33.51 | 39.50 |
| June | 30.72 | 40.26 | | Dec. | 33.60 | 38.71 |

Eastern Metal Market

New York, May 24.

Without exception the metals are dull, and prices are seeking lower levels. The immediate wants of consumers are coveted, some of them have more than they need, and as for the future, they are buying only to cover new orders. Much depends on the placing of additional war orders to infuse activity into the metals, and in this connection it may be noted that the American Locomotive Co. has received an order for fuse parts valued at \$9,000,000, but this is the only mention of new orders for shells or their parts.

Efforts to sell re-sale copper, fourth-quarter delivery, at concessions have found no takers.

Zinc has continued to decline, but the producers believe a turn will come soon.

Lead is dull and weak, both as to foreign and domestic demand.

Tin has declined in New York and London, largely because of the liberal supply of Banca tin that is available.

Antimony has slumped badly, consumers showing no interest, even at greatly reduced prices.

Aluminum is unchanged so far as current deliveries are concerned, but 1917 business is reported at substantially lower prices.

With the exception of large export orders for shell and gun forgings, the steel market has experienced less activity in the past week. The mills are turning out material at a record pace, but new business is less impressive. As a rule, prices are unimpaired, although some softness is noticeable in pig-iron, scrap material, and steel billets; but the easiness is due solely to the lull in demand. Any substantial inquiry would quickly revive quotations.

COPPER

The market is extremely dull, and prices are softer, but the situation is a peculiar one. With the producers well sold up to September, there is little reason for them to lower their quotations; but large quantities of electrolytic are coming on the market from other directions. It has been said repeatedly that there was a large amount of unsatisfied demand for the last quarter of the year, but events of the past week do not bear out the assertion. A broker has offered, far and wide, 1,000,000 lb. of copper for the fourth quarter at 28.75c., full terms, but without the slightest success, whereon he made the price 28.50c., full terms, and still failed to obtain results. This metal was bought on speculative account, and it would not be at all surprising if 28c. were accepted for it. There are two sources of copper, aside from the producers, at the present time. There is speculative metal, also a considerable quantity that was purchased by consumers whose plants were tied up for weeks by strikes, yet who continued to receive deliveries of metal on their contracts, giving them more than they can use. The surplus metal they have placed in the hands of brokers for disposal at the best figure possible. The consumers who were approached in connection with the re-sale copper referred to gave various reasons for not buying, among others that they did not wish to buy so far ahead unless it was to cover specific orders, also that they regarded the market as soft, and they thought that they could buy more advantageously later on. In the past week spot electrolytic has been quoted at 29.50 to 30c. June and July at about 29.25c., and August and September at 29c., but it is certain that these prices could be shaded substantially were business to present itself. May electrolytic probably could be had at 29c., and perhaps a fraction less. Lake is nominal at 29c. cash, but none is to be had for nearby delivery. The London market for electrolytic continues unchanged at £158, but standard is

down to £156, a spread of £22. Exports from May 1 to 23 totaled 13,196 tons.

ZINC

The slump in zinc has continued, and though the representatives of producers consider that another upward swing is not far off, what they pin their faith on is not evident, unless, as one of them says, "the low prices ought to start something." The galvanizing trade is still working at considerably below normal capacity, and if it sees fit to buy it may be the influence that will change the tide. May spelter is to be had easily at about 11.75c., St. Louis, and 15c., New York. June spelter is quoted at about 11.25c., St. Louis, July at 13.75c., and third quarter at 13.25c. All there is to the entire situation is that buyers are holding aloof from the market. The London quotation for spot is down to £95. Exports from May 1 to 23 totaled 3251 tons. Sheet zinc is unchanged at 24.50c., f.o.b. mill, carload lots.

LEAD

The expectation that the market in lead would be upheld by heavy foreign buying has failed to materialize. Japan had an inquiry out for 10,000 tons, but if the business was closed, it was quietly taken by the leading interest and had but little effect on the market. Domestic consumers are doing nothing. The A. S. & R. Co. continued to quote 7.50c., New York, and 7.42c., St. Louis, as bases for its average monthly price, but small lots have been sold by independent sellers at less. The general quotation yesterday was 7.15c., New York, and 7.25c., St. Louis, but small lots are known to have been sold at 7.30c., New York. The spot quotation at London yesterday was £31. Exports from May 1 to 23 totaled 832 tons. There is a feeling in the trade that the leading interest will reduce its quotations as soon as it has absorbed any foreign business which may be pending.

TIN

To all outward appearances the market has been quiet in the past few days, but there has, nevertheless, been a moderate amount of trading in future shipments from the Far East. Banca tin is playing a big part in the present situation, inasmuch as it is coming here freely and is being used by many consumers who previously thought they could not do without Straits tin. On May 23 there was a drop of £2 15s. in Straits tin at London, based on the fact that there had been large arrivals of Banca tin at Liverpool. The market here quickly responded to the London decline, and the New York spot quotation dropped from 48.75c., on the 22nd, to 48c. on the next day. Arrivals this month have been good, totaling up to the 23rd, 3192 tons, while there was afloat on that day 3542 tons. One ship which arrived May 17 brought 1100 tons from Batavia, Java.

ANTIMONY

The market for this metal has comparatively gone to pieces. It seems impossible to interest buyers at any price, and the result is that Chinese and Japanese grades have been offered at 28 to 29c., although some of the sellers have discontinued offerings to check the decline so far as possible. May shipment from the East can be had as low as 22c., and some sellers say they doubt if an offer of 25c. for spot would be declined. Needle antimony has been offered at 15c. with no takers.

ALUMINUM

Newcomers having need for aluminum are quoted 58 to 60c. for No. 1 virgin metal, 98 to 99% pure. It is reported that regular consumers of the metal have been covering their 1917 requirements with the leading producer at 35c. for ingots and 40c. for sheets. The spot market is dull.

COMPANY REPORTS

SHANNON COPPER CO.

Owing to the strike and other causes this Arizona company only operated 7 months in 1915. The property is now in full working order. Current assets are \$555,688 in excess of liabilities, exclusive of \$381,000 Shannon-Arizona Railway Co.'s first-mortgage bonds. The outlook for 1916 is excellent.

The metal output was 6,017,642 lb. of copper, 690 oz. gold, and 35,450 oz. silver, sold for a total of \$1,102,275. The profit from this was \$248,650. This was reduced to \$209,678 through various charges. The balance from 1914 was \$703,584, and that for 1916 \$834,019.

GOVERNMENT GOLD MINING AREAS (MODDERFONTEIN) CONSOLIDATED

This is one of the newer producers on the Rand, and its equipment is being increased to a capacity of 100,000 tons a month.

The manager, J. L. van Eyssen, reports that in 1915 there was 25,278 ft. of development accomplished. Work on payable 'reef' totaled 9880 ft., averaging \$16.80 over a width of 48 in. Large blocks of satisfactory ore were opened. Reserves are estimated at 3,665,000 tons, worth \$6.90 across 68 in. The average width of machine stopes was 69 in. There was extracted from the mine 608,546 tons. From all sources 658,387 tons was available, of which 12.529% was discarded as waste.

The mill crushed 576,100 tons, employing 100 stamps and 10 tube-mills. The leaching plant treated 219,785 tons of sand, and the slime plant 353,738 tons. The gold yield was 169,413 oz., and recovery 94.33%.

All costs amounted to \$4.70 per ton. The gross profit was £156,210, of which £16,497 was paid the Union Government as profit and income taxes.

IVANHOE GOLD CORPORATION

This is one of the largest gold producers in Australia, operating at Kalgoorlie in the western State. It is now working at a depth of 3514 ft. vertical.

The general manager, R. B. Nicolson, reports that development down to 3470 ft. totaled 4074 ft. From 3320 and 3470 ft. a series of bore-holes were put in to test the east lode after it had left the influence of the porphyry bar. At 3620 ft. more drilling will be done. Ore reserves total 1,026,801 tons, 715,550 tons being in the east lode, averaging \$8.84 per ton.

The 100-stamp mill, fine grinding, sand, slime, and concentrate plants treated 238,514 tons for 89,559 oz. gold and 18,489 oz. silver, with 86.75% extraction.

The year's revenue was £389,382, of which £115,984 was profit. Dividends absorbed £105,000, equal to \$2.52 per share. On December 31, 1915, cash on hand, etc., was £35,138, and value of investments £174,614. All costs in 1915 were \$5.24.

The output to date is £8,241,632 from 3,219,000 tons of ore, and £3,460,000 in dividends.

TAMARACK MINING CO.

The annual report of this company is interesting on account of the remarks of the president, Philip Dexter, pertaining to the proposed purchase of the property by the Calumet & Hecla company. An examination by W. E. Parnall, who knows the ground thoroughly, gave a valuation of \$4,616,734, less debts of \$349,286, but he does not put a value on the mineral veins, as those that should be worked along with those opened are not blocked out enough. James MacNaughton, general manager, considers that the mine does not pay to operate, except under the present unusual conditions, but Mr. Parnall thinks that another system of mining would make a difference. C. & H. officials state that the unopened lodes are of no value. The

C. & H. offers \$2,563,486 and to pay the debts, a sum equal to \$59 per share on 60,000 shares. The shareholders since voted to sell to the C. & H. at \$59 per share.

Results in 1915 were as follows:

Development totaled 880 ft. The five shafts are 3409, 4355, 5253, 4450, and 5305 ft. deep, respectively. No. 1 is used for pumping. No. 2 was extensively repaired, most of the mining was done from No. 3 incline shaft, and No. 5 was used for pumping and mining from April.

| | 1915 | 1914 | 1913 |
|---------------------------------|-----------|-----------|-----------|
| Ore crushed, tons | 217,027 | 57,410 | 227,563 |
| Refined copper, lb. per ton... | 17.9 | 18.7 | 18.3 |
| Refined copper, pounds..... | 3,888,150 | 1,074,808 | 4,168,743 |
| Price of metal, cents per pound | 19.10 | | |
| Cost of metal, cents per pound | 17.07 | 29.08 | 16.60 |
| Revenue | \$742,796 | | |
| Profit | 78,988 | | |

The mill was sold for \$230,000. The balance of assets at the end of 1914 was \$895,993, and at the end of 1915, \$1,204,981. No dividends have been paid since July 1907, when the total to that time was \$9,420,000. Good progress was made at the re-grinding plant.

TONOPAH BELMONT DEVELOPMENT CO.

This is one of the greatest silver producers in the world, and during the year ended February 29, 1916, returned 2,968,565 oz. In the past 5 years it yielded 1.77% of the world's total output, according to the president, Clyde A. Heller. During the past year the option on the Surf Inlet gold mine on Princess Royal island, British Columbia, was exercised, the final payment of \$150,000 being made. A good tonnage of \$12 ore has been developed. The Bull Moose mine in Nye county, Nevada, is under option; also the Biddlecome near-by.

The general manager, Frederick Bradshaw, reported that development at Tonopah aggregated 21,362 ft., mostly on the 900, 1000, and 1100-ft. levels. The cost of this work was \$1.026 per ton milled, a decrease of 14.1c.; and \$6.834 per foot, a reduction of 41.2c. Ore reserves are estimated at 142,164 tons, a considerable shortage. Stopping cost \$2.857 per ton. Total mining charges were \$4.166 per ton, 14.7c. lower than in 1914-15.

A. H. Jones, superintendent of mills, stated that the 60-stamp mill and cyanide plant at Tonopah treated 165,157 tons of ore assaying 0.196 oz. gold and 19.603 oz. silver, equal to \$13.883 per ton. In the previous term the value was \$16.721 per ton. The recovery was 96.18% of the gold and 91.69% of the silver, equal to a total of 92.97%. Stamps averaged 9.15 tons per stamp-day. The cost was \$2.682 per ton, or 13c. per oz. of bullion, compared with \$2.564 and 10.4c. Increased cost of chemicals and supplies contributed mainly to the higher expense of treatment. A new filter leaf and new type of tube-mill liner was devised, tested, and regularly used. The plant at Millers, 12 miles north, treated 56,730 tons of custom ore, assaying 0.309 oz. gold and 25.01 oz. silver per ton. The recovery was 91.33% of the value, which totaled \$1,073,517. The cost was \$3.798 per ton. A profit of \$33,398 resulted from custom work. Continuous decantation superseded filtration, improving recovery and reducing costs.

Results were as follows:

| | |
|--|-------------|
| Gold recovered, ounces | 31,112 |
| Silver recovered, ounces..... | 2,968,565 |
| Silver on hand at beginning of year, ounces..... | 1,646,099 |
| Silver sold, ounces (51.76c. per oz.)..... | 3,385,015 |
| Net revenue from metals, custom work, etc..... | \$1,001,028 |
| Balance from previous year | 1,963,286 |

| | |
|--|-------------|
| Total available | \$2,964,314 |
| Dividends paid | 750,016 |
| Balance for 1916 (after deducting sundries)..... | \$2,084,741 |

Dividends to April 1, 1916, total \$8,018,027.

INDUSTRIAL NOTES

Prevention of Corrosion in Pipe

In a 15-page illustrated pamphlet, the reprint of a paper presented by F. N. Speller of Pittsburg at the annual meeting of the American Society of Heating and Ventilating Engineers, is a great deal of interesting matter on the important subject of pipe corrosion.

Casual observation will show marked differences in the degree of corrosion of pipe in service. For instance, hot-water heating-systems and sprinkler-systems show practically no deterioration in service after 25 years, while low-pressure steam returns sometimes give trouble after 15 years' service or less. Galvanized pipe in hot-water supply systems, where

tened by carbonic acid and mineral salts dissolved. Oxygen is also necessary for a continuance of corrosion. The elimination of dissolved oxygen is one remedy to reduce 'pitting' of pipe. An alternative method is to 'satisfy' or fix the free oxygen, using clean iron turnings, or preferably sheet iron, through which the water can flow. The accompanying electrotype shows some 2-in. wrought iron and steel pipe (galvanized) after 13 years use in an 'open' heating system, while the small pipe is of copper, used under the same conditions in a 'closed' heating system for 6 months. The corrosion of low-pressure steam lines depends principally on the amount of oxygen that finds access to the system.

Summarizing very approximately, Mr. Speller considers that in the influence of various factors on corrosion, it appears from the experience gained so far that developments in the metallurgy and manufacture of steel pipe promise to add 50 or perhaps 100% to the life of pipe compared with the service obtained under like conditions 10 or 12 years ago.

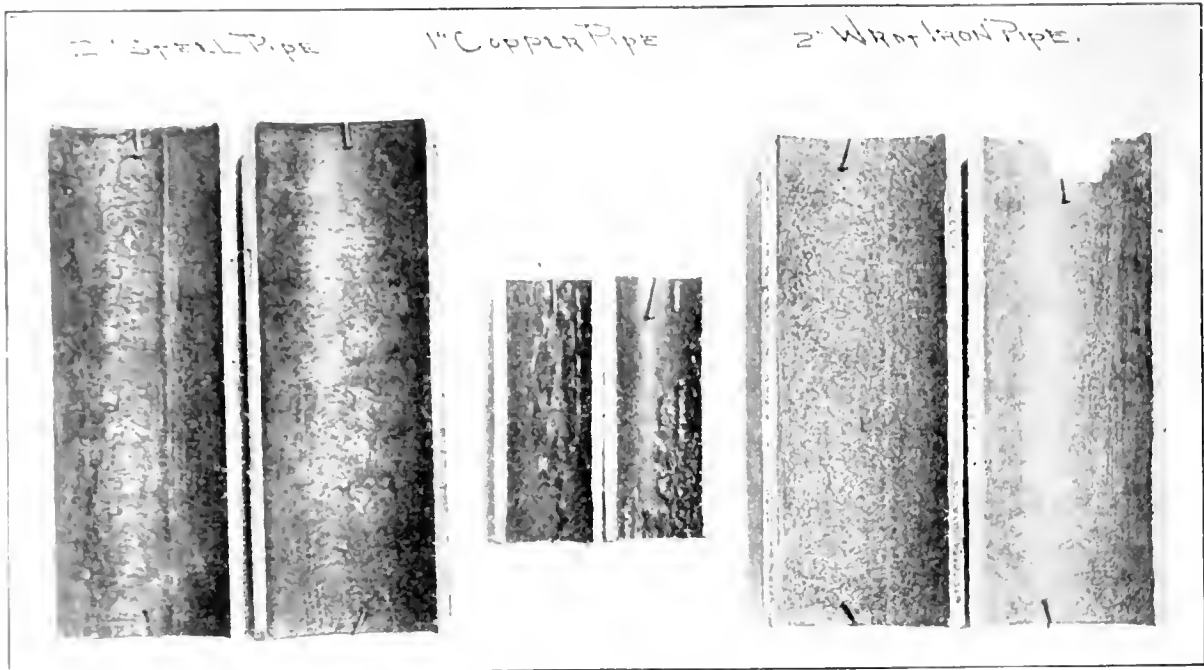

CORROSION IN VARIOUS TYPES OF PIPE (Photo from National Tube Co.)

the water is heated under pressure, lasts from about 5 years upward, depending on the temperature and quality of the water and volume of flow. The last-named condition is so severe on iron and steel pipe that many are compelled to use brass pipe at a cost approximately 10 times that of galvanized pipe. These few instances are the extremes, but are surely suggestive when it is considered that in pipe carrying ordinary water under some conditions there is no apparent deterioration in a generation, whereas in other cases, the same grade of pipe is seriously damaged in a few years. Some years ago, when steel pipe was comparatively unknown and not fully developed, it was natural to question this material; but comparisons of the modern wrought iron and steel pipe in the same lines in service have shown, beyond any question, that where corrosion is found one material suffers on the average as much as the other.

Water alone is not responsible for corrosion, but rather something brought in with the water. All water supplies carry more or less foreign matter in solution. The purest natural supplies are generally saturated with oxygen and carbonic acid, which cause such water to be very corrosive, particularly when heated. Iron is soluble to a certain extent in water. The phenomenon of solution of iron is an electrochemical reaction, which is the initial cause of corrosion, has-

However, it appears well within the bounds of possibility to predict that de-aeration of the water, through the use of plants designed with this end in view, should at moderate expense increase the life of some piping systems four or five times.

Bulletin No. 26 of the National Tube Co. consists of 47 pages describing in an informing manner the autogenous welding of 'National' pipe. As oxy-acetylene gas is used so much for welding and cutting now-a-days, every engineer should secure a copy of this useful publication.

The National Tube Co. has also issued Bulletin No. 25, entitled 'National Pipe in Large Buildings.' It covers 87 pages, 41 of which are devoted to photographs of important buildings in the United States, in which the firm's pipe is used. As is usual with the publications of this company, there is a large amount of valuable technical information given on pipe generally.

In Bulletin No. 34-Q the CHICAGO PNEUMATIC TOOL Co. describes a few applications of 'Giant' gas and fuel-oil engines, as made by this firm. The illustrations and brief notes tell all that is necessary.

John F. Bertling succeeds R. J. Kaley as sales manager for the SULLIVAN MACHINERY Co. in the Lake Superior region, with headquarters at Ishpeming, Michigan.



EDITORIAL



T. A. RICKARD, Editor

EXAMINATION and assaying of ores is not done by the editorial staff of this paper. Our readers are referred to the assayers, metallurgists, and ore-testing works whose names appear in our Professional Directory.

THE Salt Lake Branch of the U. S. Bureau of Mines has contributed much useful information concerning the operation and physics of the flotation process. In this issue we publish a timely article on flotation-oils by Mr. O. C. Ralston, who is known to our readers by his previous valuable contributions to our pages.

DISCUSSION this week starts with a letter on the electric theory of flotation from a highly competent investigator, Mr. James A. Block, of Salt Lake City. Mr. E. Jacobs, a Canadian statistician known to our readers, corrects certain figures of production from the Atlin district in British Columbia. A Nevadan mining engineer throws a hand-grenade at the mining law and urges us to accept the British Columbian rule in regard to locations. Finally, Mr. Leon J. Pepperberg, an experienced geological surveyor gives some useful hints, apropos of the recent article by Mr. Charles A. Porter.

WHETHER mining really benefits from the kiting of shares on local stock-exchanges and the use of mines as an excuse for a game in which the dice are loaded is a moot question. The only good we can see is the actual work done at the mines, the employment given to labor, and the market created for machinery. Wild-cats have been known to develop into domestic felines hardly distinguishable from the best-bred Angoras; that must be conceded. The harm is done not by the open-eyed gambling of the knowing ones, but by the loss of money to that portion of the public unable to distinguish between the 'game' and the 'industry' of mining.

CONTRIBUTORS to this paper are reminded that drawings intended for publication should be made with indian ink, that the lettering should be large enough to permit of reduction, and that the spelling should conform to our style. In making a drawing it is well to keep in mind the amount of reduction that it will undergo when reproduced. Most men who can make excellent sketches or drawings are unable to do the lettering as well as it should be done; to them we suggest the peneiling of the lettering, leaving it to our draughtsman to do the rest. Diagrams on sectionalized paper are not suitable; we have to re-draw them because the subordinate lines are too close, even when they are in colored inks that are suitable for photographing. Tracings therefore are preferable. Blue-prints are no good, except to

be copied; this entails not only expense but the chance of error. Manuscript should be typed with double spacing to facilitate revision, but we are always glad to have a good article re-typed in our own office. In fact, we do not mind poor drawings and ragged manuscript if they convey useful information clearly, but, like other people, we would like to avoid unnecessary trouble and chances of error. Hence this note.

ABSENTEE ownership in relation to mines is a phrase with a derogatory suggestiveness not always warranted. Many owners of mines, themselves unversed in technology, have sense enough to leave such things to an experienced manager. Mr. Philip Dexter, president of the Tamarack Mining Company, declares that he has never seen the Tamarack mine, and "what is more," he states, "I would not know any more about it if I had." The fussy kind of mine-owner is a handicap to a good superintendent. However, it is well to keep informed. Mr. William Guggenheim is suing his five brothers for \$10,000,000, equivalent to a sixth share in a property, the Chuquicamata, that "he did not know was valuable," and that has become even more valuable since, thanks to the combination of clever finance and good management.

ONE of our oldest subscribers writes to say that he is "shocked" at our publication of patents "in the unintelligible language usual to those documents." He suggests that we should translate them into English. We sympathize with him, but disagree as to the remedy. As he admits, a patent specification is a "document," a legal document, the wording of which cannot be altered without impairing its authenticity. Not only would an attempt at transliteration be unwarrantable, but it would be grossly misleading, for the simple reason that the language of a patent is usually intended to be obscure. The editor would be exceeding his function and making trouble all around if he ventured to do anything of the kind. Only this week we heard an inventor complain that certain people, in using his process, were depending upon the description in his patent, which was meant not to disclose the true inwardness of his method, but to afford him protection and to compel them to come to him for engineering advice.

OUR correspondent in the City of Mexico sends a deeply interesting letter, reviewing the conditions of affairs in that country. The reader will find it under Special Correspondence. This letter is written with a frankness that does not mince matters. The impression he gives is that the various factions and their leaders

leave little to choose, even Carranza and his 'liberators' in their scheme to raise money have not hesitated to victimize the peons. Famine has been used as a lever to recruit an army. Our correspondent describes the iniquity of the Casa La Garda, a heartless monopoly to control the grain trade. Then came the paper money plague, another means of spoliation. The marvel is that mining operations still continue in several important districts, despite the insecurity of life and property and the lack of adequate railway transport. At El Oro the Esperanza and Dos Estrellas resumed operations recently and are still at work, according to the latest advices. At Pachuca there has been a strike among the miners, but the Real del Monte, Santa Gertrudis, and other important mines are active. In the North, of course, the confusion is greater, but even there some of the isolated large mines are pegging away. Whether Carranza is bluffing or whether he really intends to force the United States to withdraw the punitive expedition is a question that will be settled in a few days. The President is unlikely to sanction another veracruzade.

PATENTS are numerous and interesting just now. Much metallurgical ingenuity is at work devising new machines and processes, as our periodical selections indicate. In this issue we give extracts from the Patent Gazette showing that a number of well-known practitioners are among the inventors; notably the great exponent of ore-dressing, Mr. Robert H. Richards, with two devices, one a jig and the other a classifier. Messrs. E. H. Nutter and A. H. Higgins, both of the Minerals Separation company, have patents for treating by-product tars with sulphuric acid, so as to save consumption of acid by direct addition. Mr. A. W. Thompson has another flotation patent, in which a jet of gas is used to break the froth, after it has done its duty. The same result, of de-aerating the froth, can be achieved by dropping the froth on a rotating disc. Mr. Karl Senn, maker of the well-known concentrator, contributes an ingenious amalgamating device. We note also the name of Mr. John E. Rothwell, the nephew of the late Richard P. Rothwell, and himself honorably prominent in former days for his work in chlorination. Finally, Mr. W. E. Greenawalt, who contributed an article on patents in a recent issue of our paper, appears with another leaching process. Evidently many minds are on the alert to hasten metallurgical progress.

Panama Canal

On May 31 the local section of the American Institute of Mining Engineers was favored with an interesting account, by Mr. John C. Branner, ex-President of Stanford University, of the structural geology governing engineering work on the Panama Canal. Dr. Branner, as our readers will recall, was a member of the commission appointed at the end of last year by the President to investigate the cause of the landslips that have obstructed and endangered the Canal from the very first. The chief difficulty has been in the immediate vicinity

of Gold hill, on the northern side of which is the big Culebra cut with its famous slides and on the southern side the equally important Cucaracha cut and its corresponding landslips. Not only has the Canal been blocked by the movement of the ground, but an area of fully 130 acres has been cracked and put into a condition of unstable equilibrium. The core of Gold hill, as of Contractor's hill on the opposite side of the waterway, consists of basalt of columnar structure, flanked by sedimentary rocks dipping toward it from all sides and suggesting contraction of the volcanic plug after cooling, so that the strata were first intruded, elevated, and then pulled down, just as if a gigantic nail of eruptive matter had been driven through the softer material. Wherever water penetrates the argillaceous sedimentary rocks they become soft and slippery, finally changing to an incoherent mobile mass, not much better than mud. On the south, or Cucaracha, side the movement continued until the angle of rest was not more than two or three degrees, while a little distance back the rock held firm; on examination the interesting fact was disclosed that several plugs of basalt, none of which reached the former surface, had served to restrain further movement. Whether similar geologic factors will come into play on the northern or Culebra side is not known as yet; if they do, they will prove most useful in retarding the slipping of the ground. This is caused, of course, by the seepage of water, of which not less than seven feet (not inches) falls per annum. This excessive rainfall begins in May and lasts till December, becoming heaviest at the end of the wet season, when the Canal is most imperilled. At the meeting, Mr. George L. Dillman suggested the running of an adit through the basalt of Gold hill and extending laterals into the moving ground in order to drain it. Dr. Branner declined to suggest any remedy, leaving it to the engineers to do so, but he indicated his belief that the speedy removal of the surficial water was of paramount importance. Professor E. A. Hersam made the pertinent remark that "it was better to shingle your roof than to pump out your cellar." Professor A. C. Lawson suggested the use of lime to destroy the mobility of the clay. Other ideas will be put forward and an earnest effort will be made to save the great work of engineering that promised to be one of the big things of the world, but, it must be confessed, the outlook is not nearly as cheerful as we would like it to be. Unquestionably the geologic conditions were insufficiently studied before the decision to build the Canal was reached, although it is true that the particularly unfavorable structure of Gold hill was not discernible until excavation had disclosed it; nevertheless, it is a fact that the engineering commission appointed under the Spooner Act in 1904 did detect signs of possible trouble and did give a warning, as was stated by Mr. C. E. Grunsky, a member of that commission, at the meeting to which we are now referring. Indeed, if the choice had lain between a lock-canal in Panama and one in Nicaragua, the latter would have been selected, and it was the first decision to build a sea-level canal that put the Nicaraguan

project out of court, not to be re-considered when the Panama scheme was changed to a lock-canal. We may well hope that the adverse conditions disclosed along the Canal, now that it is built, at a cost of \$400,000,000, will be overcome by engineering skill and systematic energy, but many engineers are beginning to question whether it would not be cheaper to build a new canal in Nicaragua. Danger from earthquakes does exist. As Dr. Branner indicated, the argument that these earthquakes need not be feared because one or two old houses remain standing in the town of Pauama, and more particularly the well-known flat arch, is not at all convincing; but expert opinion is fairly unanimous in regarding the destruction of dams and locks, even by a severe earthquake, as highly improbable. Does the acquisition of a concession in Nicaragua presage a new canal enterprise? Whether it does or not, it is clear that "making the dirt fly" is not enough when Nature is ready to make the dirt flow at an equal rate, threatening to obliterate man's handiwork. Engineering advice was insufficiently weighed at the outset, as is now acknowledged. The Army engineers merely carried out plans too hastily accepted; their administration, of course, was splendid, but the damage had been done by bureaucratic muddling long before they took hold. The Canal remains an engineering problem half-solved; it remains to be seen whether the natural obstacles, at first lightly regarded, can be overcome so as to ensure an open waterway between the two oceans.

Tungsten

The reviews of mining progress in the Western states, as published periodically in this paper, have made frequent mention of a metal that was scarcely known to the average miner a couple of years ago, nor for the matter of that to persons supposedly even better informed, for in the latest issue of *The Annalist* we read about tungsten as a "mineral" and are told that it is "converted into an acid for the hardening of steel tools." By this time our readers know all about the minerals in which the metal tungsten exists as an acid radical, tungstic oxide. Tungsten is a Swedish word meaning heavy (*tung*) stone (*sten*). The chemical symbol W is taken from the Latin *wolframium*. In California the chief ore is the tungstate of lime, scheelite, and it is a noteworthy fact that during recent months the most profitable mine in the State has been a tungsten enterprise, the Atolia Mining Company in San Bernardino county. In Arizona hübnerite and wolframite, the tungstates of manganese and iron, share economic importance with scheelite, while in Colorado, particularly in Boulder county, the mineral ferberite, a tungstate of iron, is the characteristic product. In all these minerals the content of tungsten tri-oxide (WO_3) ranges from 75 to 80%, the actual treatment of the ore yielding a concentrate containing 60 to 65%. This concentrate is reduced with carbon, together with iron ore, in an electric furnace, the resulting ferro-tungsten containing 75 to 80% tung-

sten. This is added to the charge when making certain kinds of steel. Alloy-steel, especially for high-speed cutting-tools, consumes most of the production. Another important use is as wire in the making of filament for incandescent lights; when used for this purpose a pure tungstic oxide is obtained by chemical process and then reduced at a temperature of 1000°C. by hydrogen or pure carbon, yielding a black powder that is pressed into bars through which an electric current is passed in order that the heat may agglomerate the metallic particles so that the bar can be shaped, becoming so ductile that it can be drawn into wire. Previous to the War, the world output of tungsten was about 10,000 tons of 60% concentrate; and out of this total Burma contributed 2700 tons, the United States 1390 tons, and Portugal 1380 tons. At the end of 1913, Portugal's output was increasing the most rapidly, having nearly trebled in five years. Until recently the manufacture of ferro-tungsten was mainly a German industry; now England is making supplies for herself and her allies. The placing of an embargo on the shipment of tungsten ores and products from England or her overseas dominions has had a beneficial effect in stimulating the mining and metallurgy of tungsten in the United States, where the making of high-speed tool-steel is at its maximum. Hence the extraordinary rise in price. During 1913 the price ranged between \$6 and \$7 per unit of 60% concentrate. In 1914 the average was \$7 per unit. By the middle of February 1915 the quotation was \$40, rising slowly to \$50 in February of this year, when a jump to \$105 per unit, or \$5.25 per pound, was recorded. Whereupon there ensued a veritable scramble for tungsten ore all over the West; the resulting production, together with large shipments from South America, flooded the market so that the price declined rapidly until now it is at about \$40 per unit. That incorrigible ratio of supply and demand has a way of asserting itself, despite all we may hope or dream.

The MacArthur-Forrest Process

Cyanidation and MacArthur are names so linked in the historical development of modern metallurgy that our readers will appreciate the appropriateness of an account of the discovery of the cyanide process by the discoverer himself. To these last words Mr. MacArthur will demur, for he shows himself anxious to give a large share of credit to his associates, notably Dr. Robert W. Forrest, whose name is usually joined with his to make MacArthur-Forrest synonymous with the beginnings of cyanidation. Our readers will like the article; it is written without any affectation, with a directness and a charm quite characteristic of one of the most useful of living technicians. It will be noted that the publication of a description of an electrolytic chlorination method was the first step toward metallurgical distinction. The pen is a lever for lifting men to a point of vantage. The next step was, he says, to make "plenty of mistakes" and "acquire knowledge" from them. Thus do metal-

lurgists rise on stepping stones of their mistakes to high achievement. The little band of investigators foregathered in a 'glory hole' in which unfamiliar use of the word the Western miner will find the origin of a term now glorified indeed. 'Glory hole' is a corruption of 'glauy hole,' a name given by Scottish sailors to the place for refuse in the waste of a ship. At our Western mines it became convenient to throw the discard from the boarding house into the nearest open-cut, so that the latter became a glauy hole in the Scottish sense, which was soon forgotten in the fact that many open-cuts, as at the Alaska Treadwell and the Combination mines, were made by excavating rich ore. Thus the term became synonymous with mineral wealth. Much in the same way 'lumber room,' a garret for storing odds and ends, came to us from 'Lombard room,' a shelter for Lombard refugees. Thus do words wander from their origins. We apologize for the digression. The next point is more important: the founders of the cyanide cult made it a rule, in their search for a workable process, to regard no gold as extracted that was not "put on the table." That showed their hard-headed sense: it was a good plan to follow, but it was nearly over-done. Mr. MacArthur relates how their epoch-making discovery was delayed a year by the fact that they relied so much upon the recovery of the gold as bullion "on the table" that they failed to assay the tailing from the first experiment in which potassium cyanide was used and assumed a failure from their non-success in precipitating the gold when employing an ineffective reagent, namely, sulphuretted hydrogen. The discovery came when the residue from similar experiments was assayed in October 1887.

These investigators knew what they wanted, namely, a solvent that would dissolve the gold without attacking the encasing sulphides, in short, one that would "hold the gold against all comers." Heretofore experimentation had been confined to metallic gold, by itself, using reagents that were impracticable in the presence, for instance, of pyrite. Again, the process had to be cheap, therefore it could not depend upon the help of roasting, which is "neither simple nor cheap." Of course, the solubility of gold and silver was a matter of encyclopedic record; what MacArthur and Forrest did was to prove that a solution dilute enough to be cheap would effect the extraction, and they followed this by providing the means for precipitating the dissolved metals so that they could be collected as bullion. It was the use of zinc in an easily soluble form that made cyanidation an immediate success. Mr. MacArthur makes mention of the precedence shown by Mr. Louis Janin, Jr., who is still with us, although unfortunately withdrawn on account of ill health from participation in the metallurgical research for which he exhibited such signal ability in his early manhood. In our interview with Mr. Hennen Jennings, last December, a mention was made of the first trial of the process at Johannesburg, and Mr. MacArthur now gives a whimsical account of the test, together with a friendly handshake across the years with the chief

sceptic. The mention of Elsner's blunders and how they were perpetuated in books of reference recalls the fate of feldspar, which became 'felspar' by the dropping of the 'd' in Kirwan's 'Elements of Mineralogy,' published in 1784. It is evident that MacArthur and his friends did not allow themselves to be side-tracked by Elsner's mistakes, nor did they permit themselves to be misled by chemical subtleties; they aimed consistently to find a real metallurgical process, namely, one to extract gold from ore economically. Therefore they did not assume that the reaction between cyanide and gold was on all fours with the effect of potassium cyanide on gold incased within the sulphide minerals of the base metals. They persevered, doing their work while all the (other) respectable people of Glasgow were asleep, energizing themselves occasionally with the weird concoction provided by Dr. Forrest, of which we can say, having consulted the family physician, that it was a respectable medical cocktail.

It is 29 years since the cyanide process was given to the miner by MacArthur and the two Forrests. Not long ago fully 60% of the world's annual production of gold was being extracted by it and the world's greatest goldfield—the Rand—while yet in its infancy was developed by aid of it. What gold mining in South Africa would have been without cyanidation, we do not know, but it is quite certain that the industry would have remained puny and sickly as compared with the magnificent growth since 1890. The troubles over patent rights were settled in due course, and it is only fair to add that in the case of cyanide, as in that of flotation, it was not the discoverers of the process but the purchasers of the patents, in the guise of royalty-gathering companies, that made most of the trouble. Indeed, the absurd claims made for the process by the first American exploiters of it and their crass ignorance of the operations involved were such as to discredit cyanidation in the West, 25 years ago, as was related by Mr. Philip Argall in the interview we published last January. For the rest, most of us will recall our astonishment when we first found out that we could extract gold from a pyritic ore without any apparent chemical change in the ore. The pleasure of those early experiments and experiences has never been quite staled by frequency. In a faint way we can imagine the keen delight of the little group of earnest investigators who, in October 1887, suddenly placed a finger on an epoch-making fact. Such moments are rare in life. Moreover, that early work disclosed the basic idea: the chemistry of cyanidation is in essence much as it was ascertained then, the progress of later years being mainly in the line of mechanical improvement. Undoubtedly the cyanide process reached a high state of chemical and mechanical efficiency in the first decade of this century; it has, we believe, seen its best days, because flotation is destined increasingly to invade its domain, just as cyanidation previously invaded that of amalgamation. It was a good time to tell the story of the discovery and to express the gratitude of the profession to the discoverers.



DISCUSSION

Our readers are invited to use this department for the discussion of technical and other matters pertaining to mining and metallurgy. The Editor welcomes the expression of views contrary to his own, believing that careful criticism is more valuable than casual compliment.

The Electric Theory of Flotation

The Editor:

Sir—Mr. Fahrenwald's article, 'Electro-Statics of Flotation' in your issue of March 11 is very interesting, and I consider his criticism of Bains's electro-static theory most opportune, but in the course of his criticism he attempts to prove that the electro-static charges present on the surface films cannot be great enough to effect flotation: an assumption which, if true, would discredit all electric theories. I do not in the least agree with his line of reasoning in this matter, and shall confine myself to this point. Mr. Fahrenwald makes absolutely no distinction between electro-static units of quantity and of potential. These are as different as the coulomb and the volt, and either can exist in large amounts without necessitating a large amount of the other. An electro-static unit of quantity is a quantity of electricity which will repel a similar quantity of electricity separated from it by a distance of one centimetre of air with a force of one dyne. It has been proved experimentally and theoretically that it takes 3,000,000,000 of these electro-static units of quantity to equal one coulomb. Now the electro-static unit of potential is correspondingly large. It is a difference of potential of such magnitude that one erg of work is required to move one electro-static unit of quantity through this difference of potential. Since a coulomb is one-tenth of an absolute electro-magnetic unit, and since a volt is 10^8 absolute electro-magnetic units, an electro-static unit of potential equals 300 volts.

Mr. Fahrenwald calculates that a charge of 25.9 electro-static units of quantity must be present on the surface of the air bubble in the particular case he takes up. He then takes up the distances that various differences of potential will discharge through, and shows that 25.9 electro-static units of potential will discharge through a fraction of a centimetre of air. Both of these statements are perfectly true, but it is possible to have practically any quantity of electricity at practically any potential difference, if we care to build a condenser to suit the requirements. To take the particular case of a bubble of air in water, probably the best known work on this subject is that of H. A. Taggart, published in the *Philosophical Magazine*, 1914, 27: 297 and 28: 367. He found that an air-water surface film had a difference of potential between its two sides of 0.055 volt, and that the surface density of the charge was 0.00004 coulombs per sq. cm. If we convert these into electro-static units we

see that the density of the charge is 12,000 electro-static units per sq. cm., and that the difference of potential between the two sides is 0.00018 units of potential. It would be useless to multiply instances similar to this. The molecular forces bound up in surface films are nothing less than enormous. While they may ordinarily be 'bound,' that does not in the least prevent our putting them to useful purposes, as is done in flotation.

JAMES A. BLOCK.

Salt Lake City, May 18.

Gold From Atlin Mines

The Editor:

Sir—With regard to the total quantity of gold from placer mines of the Atlin district, I think Messrs. Chester F. Lee and T. M. Daulton have inadvertently understated the value, which they place at \$4,518,000 in the interesting paper of which you printed an abstract in your issue of May 13 (p. 721). The British Columbia official records, as printed in the annual report of the Minister of Mines, will, I think, be found to give a total to the end of 1914 of \$6,163,000; add the amount for 1915, \$377,000, which most likely has not yet been published. Thus a total of \$6,540,000 is obtained, not \$4,518,000 as given by the writers of the paper quoted from. This larger amount, I take it, is the total of recovery from all the creeks in Atlin mining division, for all years, 1898-1915, both inclusive.

E. JACOBS.

Victoria, B. C., May 15.

Mining Law

The Editor:

Sir—Apropos of the proposed revision of our mining laws, it is to be regretted that American legal practice cannot reconcile itself to simplicity. Our mining laws as at present enforced lend themselves notably to endless litigation. Decisions are rendered on the most absurd technicalities: in numerous cases it seems that it is not justice that is sought, but the vindication of legal fictions.

The proposed legislation seems not to be a great improvement: yet it must have some positive virtue, for the newspapers chronicle a meeting of Colorado legal talent for the express purpose of combating the new legislation. This sinister conference has not yet defined its attitude toward mining law as it stands at present,

but one need only glance over the 'stand pat' attitude of the legal fraternity toward every proposed change in legal practice to be assured that anything save a rigid adherence to present practice will be met with howls of derision, not to say graver charges.

What should distinguish our mining code is simplicity, add to that certainty. A long step in that direction would be taken if the Federal Government were to adopt the British Columbian practice of making locations 1500 ft. square and abandoning the principle of extra lateral right. The principle of extra-lateral right is a bugbear, a snare, and a delusion. Evolved from the brain of a capable brilliant lawyer, and through his remarkable ability and powers of persuasion made to serve his ends, it has continued on its pernicious course nearly 50 years; no other single feature of our mining law has been so prolific of discussion and the accumulation of fees.

I can not understand why the B. C. system is not more strongly supported by mining men. The system of posting is as good as our own and lends itself equally to wooded and desert country. It gives ample room. Fifteen hundred feet square on a vein is enough for any one, if the vein proves good; if it isn't good it makes no difference.

E. B. BAU.

Midas, Nevada, May 25.

A Quick Method of Locating Geologic Features

The Editor:

Sir—In your issue of May 20 Mr. Charles A. Porter describes 'A Quick Method of Locating Geologic Features.' Mr. Porter states "in the examination of prospects, an approximate method of determining the position of landmarks is often desired." I believe that where the prospect has economic possibilities, or in case the engineer is making a preliminary report to clients who are not familiar with the property, a map is necessary. On such a map the approximate location of landmarks and geologic features is essential and always desirable.

The triangulation system described is commonly called the 'two point' method by those familiar with plane-table surveying. Locations made in this way are fairly accurate when the angle formed by the intersection of the two lines at the unknown point is about 90°. Better locations are determined by the intersection of three or more sights toward the unknown point.

Having determined the location of several stations by this method the observer can occupy a vein outcrop or other geologic feature and determine its approximate position with reference to the established stations by the intersection of the lines from such stations, the bearings of which are determined from the unknown occupied location, and so on *ad libitum*.

It is advisable to plot the lines in the field, using a small protractor during the course of the examination.

If done at that time many geologic data of value to the examination will be collected and properly tied to the map as the observations are taken. These data will be of inestimable value to the report, as factors from which to appraise the prospect investigated. The whole method as here described and as set forth briefly in your issue of May 20 has been used by engineers and geologists for many years.

San Francisco, May 23.

LEON J. PEFERBERG.

Discussion should be one of the most important things in the world, for it is almost our only arena of thinking. It is here that all the jumble of ideas and impressions that we get from reading and watching are dramatically placed in conflict. Here only is there a genuine challenge to put them into some sort of order. Without discussion intellectual experience is only an exercise in a private gymnasium. It has never been put to the test, never had to give an account of itself. It is some such motive that impels people to discussion; though they are too often content with the jousting of pasteboard knights. But a good discussion is not only a conflict. It is fundamentally a co-operation. It progresses toward some common understanding. This does not mean that it must end in agreement. A discussion will have been adequate if it has done no more than set the problem in its significant terms, or even defined the purpose that makes such a setting significant. You turn up things in your mind that would have remained buried without the incision of some new idea. The effort to say exactly what you mean, sharpening your idea to the point that will drive home to others, is itself invigorating. A good discussion tones up your mind, concentrates its loose particles, gives form and direction. When all say exactly what they mean, then for the first time understanding—the goal of discussion—is possible. Discussion demands a mutual trustfulness, a mutual candor. But this very trustfulness makes discussion vulnerable. It is particularly open to attack of the person who sees in the group a forum. The physical signs of such a misinterpretation are familiar. The eye becomes slightly dilated, the voice more orotund. The suggestion develops into an exposition, the exposition into an apologia or recrimination. Discussion is slain. Another enemy is the person who sidetracks a sentence and then proceeds in a leisurely way to unload its freight into his own wagon. But in a good discussion the traffic is kept constantly moving in both directions along a rather rigid line of track, and the freight arrives somewhere. Some people have a fatal gift of derailment. Wit is perhaps the most common means. Discussion has no greater enemies than those who can catch an idea and touch it off into a puff of smoke. Wit should salt a discussion but not explode it. Good discussion is so important that those who set about it may be rather pedantic and self-conscious in their enterprise. One may acutely realize oneself as being, for the time, primarily a mind.—Randolph Bourne in *The New Republic*.

The Discovery of Cyanidation

By John S. MacArthur

MY training in practical chemistry and metallurgy began in the Glasgow laboratory of the Tharsis Sulphur & Copper Co. This company owns mines of copper pyrite at Tharsis and Calanas in the south of Spain. The ore is high in sulphur and iron, low in copper—not over 2%—and contains small quantities of gold and silver, say, 0.025 oz. and 1 oz., respectively. The pyrite is shipped to various chemical centres in Britain and the continent of Europe, where the sulphur is burned off to make vitriol, while the cinder—often called ‘burnt ore’—is returned to one of the extracting works of the Tharsis company that are dotted over the country in the chemical centres. The ‘burnt ore’ is mixed with salt and roasted to solubilize the copper and leave the iron as ferric oxide, called ‘blue billy’ in this form, which is insoluble in water and weak acids. In the course of salt-roasting the gold and silver are chloridized, the gold imperfectly and the silver perfectly. The heat is only a dull red, but at this temperature a variable proportion of the copper, about 10%, is volatilized and condensed by a descending flow of water in a coker-tower. The copper vapor entrains the aurous chloridic and anhydro-chloric acid, both of which are formed in the roasting. The silver chloride resists volatilization at this temperature and remains with the insoluble iron.

It fell to me to make a research, under the guidance of my chief, the late R. A. Inglis, to see if it were possible to recover the gold from the aqueous acid solution of copper without materially affecting the copper or the acid. We found that this could be done by adding a minute quantity of a soluble sulphide that precipitated its equivalent of copper sulphide and at the same time entrained all the gold, leaving the liquor practically unaffected and ready for its next duty of washing out the basic salts of copper, which are not soluble in water, from the mass of roasted ore, now transferred to lixiviation tanks.

This process is called the Longmaid or Henderson, after the two men, who, at different times and in different circumstances, had elaborated its leading principles. It is in general use in Europe, but in America is employed only in the Eastern States.

Besides this method of gold extraction, I had to investigate various methods of extracting gold devised by men who assured us that the pyrite contained much more gold than we imagined. All these methods, whether propounded in good faith or bad, came to nothing, but thus it was that I became familiar with the industrial chemistry of gold and some of the problems of gold extraction, though at this time I had not even seen a gold mine.

About 1885 the Cassel Gold Extracting Co. was formed

at Glasgow to develop a patented process for the extraction of gold from refractory ores. This process was essentially one of electrolytic production of chlorine from weak brine in presence of the ground ore, with simultaneous electrolytic precipitation of the gold. In the summer of 1886 the inventor, H. R. Cassel, disposed of his interest and left Glasgow, leaving the company in a state of chaos. I made a research on the subject in the premises of a friendly electrician who gladly gave the facilities. As a matter of fact, gold was extracted, but I had no data as to efficiency of action or as to cost. In a weak moment I yielded to the persuasion of a friendly journalist and published (anonymously) the result of my essay. Very soon it leaked out that I was the writer and I was asked privately if I would disclose myself to the Gold Extracting Co. For various reasons—one of them being that I had not sufficient grip of the subject—I declined.

My friends, the brothers Robert W. and William Forrest with George Morton, advised me to continue researches on gold extraction, promising co-operation and support. We soon formed ourselves into a research syndicate, each of us having an equal financial responsibility as to cost, but Mr. Morton guaranteed my salary in case it should be necessary for me to give up my situation with the Tharsis company. We certainly were not capitalists, only a quartet of enthusiasts carrying out research in the evenings in a glory-hole under the consulting rooms of the two Forrests, both of whom were doctors. We worked hard and made plenty of mistakes, but kept on acquiring knowledge and gathering data.

The Gold Extracting company was still under a cloud, an influential shareholder in it and in the Tharsis company pressed to be allowed to introduce me to William Verel, who was both the general manager of the Tharsis and an honorary director of the Gold Extracting company. I declined his introduction respectfully but said that as Mr. Verel was my own ‘governor,’ I would see him myself. He was surprised to know that the chief assistant in his own laboratory had investigated the subject and, the two companies being on the most friendly terms, I soon found myself transferred to the Gold Extracting company as technical manager while still retaining the goodwill of my Tharsis friends. It was a condition of the engagement that my new employers should have the first call on any invention or discovery resulting from the work of the MacArthur-Forrest research syndicate, but the Gold Extracting company assumed no responsibility as to the expenses unless it took over the problematical invention looming in future, at least in the Syndicate’s dreams. It will be seen that the assistance of the capitalist did not arrive until after the in-

vention had been made, proved, and taken over. The whole burden of research was on the shoulders of our quartet.

The Syndicate resolved not to use electricity, as my one short experience of the difficulty of applying the electric current to a mass of sodden ore was quite dissuasive. All the same, I did my best for a year to make electrolytic chlorination an industrial possibility. An occasional flash of success lured us on time after time, but the work was disheartening; we might get a good result on an ore from India or Victoria, but not on ores from Peru or Queensland.

The Research Syndicate laid it down as a rule that we would not reckon gold extracted as the difference between the assay of the original ore and that of the tailing, but in every case the gold must be put on the table. We were methodical; we tabulated our program of possible solvents, including many chlorine and bromine mixtures, so devised as to minimize the action of chlorine or bromine on the pyritic minerals always associated with the average gold ore. These mixtures were more or less successful but never to the point of uniform success.

We never thought of using *aqua regia* as a solvent of gold in ores; we knew very well its powerful action on gold, but that concerned us very little, for we knew that in interaction with it the pyritic minerals took preference; and if by any chance a little gold was dissolved, the metallic sulphides and even some metallic oxides precipitated it at once and restored the *status quo*. Anyone can find a solvent for gold, but until we undertook our researches no one had suggested the possibility of a simple solvent that would primarily attack gold and shun base sulphides. We thought that the resources of chemistry were not exhausted, and we searched for this hypothetical solvent.

At an early stage in our work, during November 1886, we used cyanide of potassium as a solvent and followed our rigid rule of putting the gold on the table. We invariably used sulphuretted hydrogen as the best all-round precipitant and did so on this occasion, forgetting that it does not precipitate gold and some other metals when they exist as cyanides. This trial was put among the non-successes; the residue from the cyanide treatment was, like many others, wrapped neatly in paper, labeled, and put on the shelf.

Nearly a year passed when, in October 1887, I had occasion to separate gold from mercury in a cyanide solution. As the separation was being made I recalled our cyanide trial eleven months before. Cyanide solution was again tried on one ore and another and another, and to our delight the residues showed a full extraction. We then went to the shelf, selected the parcel of residue that had been sleeping there holding its secret for nearly a year, assayed it, and found no gold. Then followed the usual hurry and excitement of consultation with the patent agent, drafting of specifications, and the plunge into the sea of troubles that awaits the successful inventor.

△ The Mac Arthur-Forrest invention was covered by two

British Patents: 14174 of October 19, 1887, and 10223 of July 14, 1888. The principal points covered were:

1. Treatment of the powdered ore with a weak cyanide solution.

2. Drawing off the gold-bearing solution from the treated ore.

3. Precipitation of the gold by zinc.

Among all the mass of 'anticipations' unearthed by the lawyers, not one prescribed the simple treatment of ore with a simple cyanide solution, and none prescribed drawing off the solution for precipitation by zinc. Cyanide was invariably associated with some other chemical agent, or as an electrolyte, or as a means of removing base metals or of grease, but never as a simple solvent of ore-locked gold or silver.

The one man who had any idea of the possibilities of cyanide was Louis Janin, Jr., who, on December 21, 1889, more than a year after we had recorded our invention at the British Patent-Office and a few months after our publication, wrote an article in the *Engineering and Mining Journal* of New York, in which with remarkable prescience he adumbrated some of the principal features of cyanide practice, for example, he indicated not only that a cyanide solution is a powerful solvent of gold and silver from their ores, but that a weak solution is better than a strong one, and that the base metals are more easily attacked when the ore is roasted.

Before the end of 1888 the Gold Extracting company had sent expeditions to Queensland and New Zealand, while I went to America. The first cyanide gold was banked at Ravenswood, Queensland. It was extracted from some foul tailing by the adaptation of an old pan-mill equipment. The first cyanide plant, designed as such, was erected for the Crown Mines, at Karangahake, in the North Island of New Zealand. As this mine is still being worked, I presume that the old plant is still in evidence. [The Crown property was closed indefinitely early in 1916.—Editor].

In America the process was received with frank incredulity, and while the inventor had no reason to complain of any lack of politeness, it was so mixed with the kindly forbearance usually meted out to ill-informed enthusiasts that he often felt most uncomfortable. The American view was well put by W. D. Johnston in the Report of the State Mineralogist of California for year ending December 1, 1890. In the course of a most interesting article he wrote:

"The claims set forth in the above article undoubtedly caused great surprise to the chemists as well as to the mining engineers of the civilized world. That cyanide of potassium would dissolve metallic gold and silver, forming soluble double cyanides of gold and silver, had long been known to chemists and electroplaters, and the double cyanide of gold and potassium is now the favorite solution of gold used in gold-plating. That a dilute solution of cyanide of potassium would extract gold and silver from their combination in sulphurets of iron, etc., leaving the sulphurets apparently unchanged by this treatment, was certainly an amazing statement, and just-

ified to a great extent the incredulity with which chemists received the article, and the refusal of many of them to test the truth of the statement for their own satisfaction.

"The writer confesses to have shared in the doubts of the majority, and for a time looked upon the subject as a companion of the schemes attempted to be palmed off on our capitalists by Alfred Paraf, of oleo-margarine fame; Major Tichenor, of Calistoga notoriety; Robertson (*alias* potassium cyanide), of San Francisco; and the 'green gold' swindlers of San Rafael."

Soon after the expeditions to Australia and New Zealand, the Gold Extracting company despatched Al-

fred James as scout and pioneer to South Africa. At this time Barberton was waning and Johannesburg, only three years old, was asserting itself as the centre of the gold industry. In a few months James returned, reporting that there was a good field for the process and that a small syndicate, afterward called the Gold Recovery Syndicate, was ready to take up the process of the Gold Extracting company, and would prove it on the spot to its satisfaction. A great demonstration was arranged for the following year. James went out with the plant and a small squad of mechanics and when the plant had been erected I followed in May 1890, and superintended the demonstration. We had several classes of ore and tailing to work on, but our great triumph was on the Percy concentrate, which was almost wholly arsenical iron pyrite containing 20 oz. gold per ton. Our extraction was 98%. As described recently by Hennen Jennings,* the

cyanide treatment was by agitation—an extravagance justified by the high grade of the material. Then, as now, we worked ordinary tailing by percolation. A big group of engineers and metallurgists attended at the Salisbury battery to assist at the demonstration. They were all determined to "see it through," and were excessively zealous for an hour or two, but as afternoon merged into evening and evening into night, "important engagements," "urgent business" and "headaches" dragged them away one by one until Jennings and I were left alone; even Alfred James was down with a touch of



JOHN STEWART MACARTHUR.

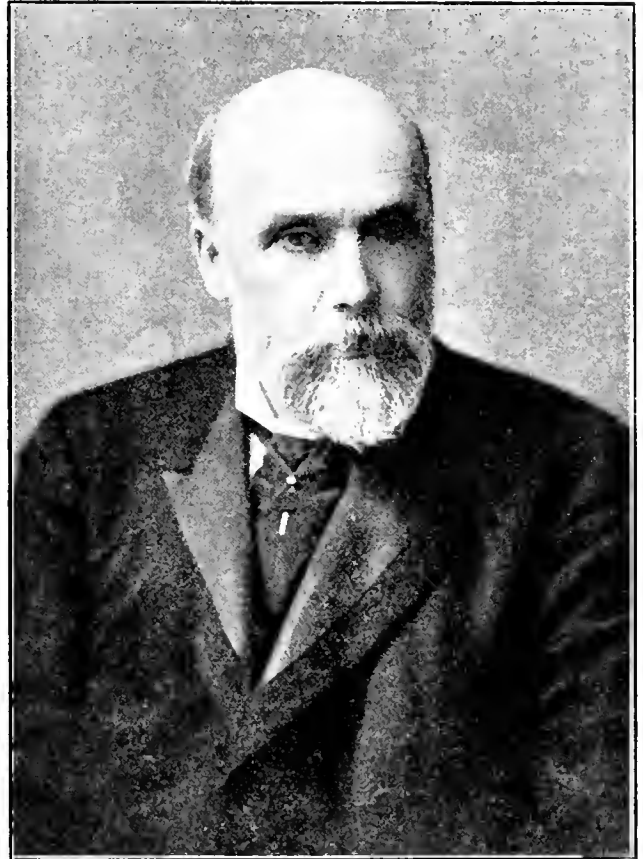

ROBERT WARDROP FORREST, M.D.

fred James as scout and pioneer to South Africa. At this time Barberton was waning and Johannesburg, only three years old, was asserting itself as the centre of the gold industry. In a few months James returned, reporting that there was a good field for the process and that a small syndicate, afterward called the Gold Recovery Syndicate, was ready to take up the process of the Gold Extracting company, and would prove it on the spot to its satisfaction. A great demonstration was arranged for the following year. James went out with the plant and a small squad of mechanics and when the plant had been erected I followed in May 1890, and superintended the demonstration. We had several classes of ore and tailing to work on, but our great triumph was on the Percy concentrate, which was almost wholly arsenical iron pyrite containing 20 oz. gold per ton. Our extraction was 98%. As described recently by Hennen Jennings,* the

fever that night. At the beginning Jennings made it quite clear that he was there to watch and check everything and everybody, especially myself. I told him that we would be quite happy together—and we were. For three days and two nights we worked, ate, and rested together, and then began the friendship that remains unbroken. I was fortunate in having such a man to investigate our process and from that day to this I have regarded Hennen Jennings as the embodiment of strength, honor, and fair play. It was a fitting and happy coincidence that in 1903, he, as President of the Institution of Mining and Metallurgy, should hand me the medal of the Institution on the occasion of its first award. He is right in saying that the use of dilute solutions was the key to the success of the process, but perhaps it is not clear to him and to others that, prior to our first British patent, there was an utter absence of knowledge concerning the power of cyanide in weak or strong

*M. & S. P. December 25, 1915, Page 964.

solutions to dissolve gold and remove it from its base associates in gold ores. All through I had known of the power of zinc to precipitate gold from cyanide solutions, but this power is exerted so feebly that the use of ordinary zinc sheets for this purpose was impracticable, and we used fine saw dust produced by milling cakes of cast zinc. This did well, but it was far from perfect. As a boy I had bought a pennyworth of fine zinc ribbon to burn as a cheap substitute for magnesium ribbon and now to my regret found that magnesium had become so cheap, or boys so rich, that zinc ribbon was no longer to be had. I had confided the trouble to our foreman-mechanic, who, one day, in making a zinc case for packing blocks of cyanide, made a thin shaving while using one of his tools, he then made a handful, brought them to me, and the thing was done.

The further history of cyanide in South Africa is a story still being told volume by volume as the years pass.

The Gold Extracting company had from the start to manufacture cyanide for consumers. Previously it had been made by the pound as a fine chemical, now it was demanded by the ton. The Germans, quick to appreciate a good thing, even if new, immediately went into the trade, made an excellent article, tried to oust the Gold Extracting company, which stoutly held its own, until today it is the Cassel Cyanide Co., producing the best cyanide in the world.

Among those who helped to introduce the MacArthur-Forrest process and still survive are Dr. R. W. Forrest, George Morton, co-inventors; A. Forson Stewart and H. M. Leslie, research assistants; W. Dempster, a New Zealand pioneer; C. J. Ellis, who took the process to India; William Jones, a South American pioneer; and W. A. Caldecott, who assisted at the Salisbury battery in 1890 and has for years been one of the leading metallurgical authorities on the Rand.

The use of cyanide in metallurgy is not yet fully developed, but for the present I am content to enjoy the reminiscences of its past.

*The guidance on this subject to be obtained from chemical and technical text-books was scanty, meagre, and sometimes misleading. The standard books of reference on chemical matters must copy largely from a few original sources, and if an inaccuracy or error occurs at the fountain-head, it is sure to be perpetuated. We could get no information whatever on the action of cyanide solutions on gold ores, and no direct or useful information as to the action of cyanide on the ores of base metals. We did get, however, some information regarding the action of cyanide solutions on the metals themselves. For instance, Elsner states (*J. Prakt. Chem.*, 37 [1846], 441) that iron is soluble in cyanide solution and mercury is not acted on—both statements palpably erroneous. Other investigators stated that mercury was dissolved in cyanide solution, but the fact

that commercially pure iron was not appreciably acted on was first noted, I believe, in the course of my own work. Possibly the iron used by Elsner contained some silicon—if so, hydrogen would be evolved, but no iron would be dissolved.

There was a similar confusion as to the action of cyanide solution on gold. Elsner stated that oxygen was necessary for the reaction. Percy (referring to silver) says that either hydrogen is evolved or oxygen derived not from the air, but from any cyanates that might be present. (Percy's 'Metallurgy,' Part I, pp. 111-115.) Guélin also thinks the cyanates may supply oxygen. Faraday indicates clearly that air contact and the formation of air voltaic circles are necessary for the reaction. He does not hint at any oxidizing action being necessary (*Phil. Trans.*, Vol. 147, p. 147). As Faraday may fairly be taken to represent the high-water mark of knowledge on this subject in his generation, I think it well to quote his words. Referring to the dissolving of gold leaf in cyanide solution, he says:

"Air voltaic circles are formed in these cases, and the gold is dissolved almost exclusively under their influence. When one piece of gold leaf was placed on the surface of a solution of cyanide of potassium, and another, moistened on both sides, was placed under the surface, both dissolved; but twelve minutes sufficed for the solution of the first, whilst above twelve hours were required for the submerged piece. In weaker solutions, and with silver also, the same results were obtained: from sixty to a hundredfold as much time being required for the disappearance of the submerged metal as for that which, floating, was in contact both with the air and the solvent. An action of this kind has probably much to do with the formation of the films to be described hereafter."

These references and all others available referred to the action of cyanide on metallic gold with which we had little concern, and did not touch on its behavior toward ores or the minerals usually found in ores. Amid all this confusion of authority, we had to work out a metallurgical process rather than attempt to solve delicate chemical questions concerning reactions among pure materials.

On the general assumption that the addition of oxygen, or at least air contact, was necessary for the chemical action, we constructed our first apparatus with a wonderful arrangement of ploughshares which turned the ore, sloppy with cyanide solution, over and over, always exposing fresh surfaces to the air. This apparatus gave such good results that we tried the simplification of plain stirring, which also did well, and we came down to a revolving barrel, which did equally well. After this we came down to a plain percolation of the cyanide solution through the ore, which gave such satisfactory results that we concluded that, even if air contact or oxygen were necessary, it was not necessary to devise any special form of apparatus to introduce air to the mixed ore and cyanide solution. Thus all special mechanism was eliminated and the process be-

*Abstracted from the *Journal of the Society of Chemical Industry*, April 15, 1905, from a paper entitled 'Gold Extraction by Cyanide: A Retrospect,' by John S. MacArthur.

came less of a complex process and more of a simple operation.

While this practical work was being carried on, the chemical aspect was not neglected. Experiments were carried out on ores treated with cyanide solutions which had been made from water boiled to expel all dissolved air, and the extractions were the same as under normal conditions. At this time I also suspended a sheet of gold by a fine thread in a cyanide solution, about an inch under the surface of cyanide solution, and found that it dissolved surely and steadily. It was clear that there was no need for air contact, and as no one had ever sug-

former, and can adduce no proof of the latter; but I think the latter the more probable, because I cannot conceive oxygen penetrating even a film of cyanide solution without at once oxidizing the cyanide to cyanate. * * * However, we do not concern ourselves much with the reactions of pure gold, but, as a matter of fact, we cannot find that oxygen plays any part in the cyanide extraction of gold from ores. We have treated an ore with cyanide with free access of air, and then a parallel experiment was done with boiled water, the bottle filled to the stopper with solution and ore, and the stopper sealed. The extraction was the same in both cases."



A GROUP OF CYANIDERS WHEN THE PROCESS WAS ONLY THREE YEARS OLD. IN FRONT, J. S. MACARTHUR HAS ALBERT JAMES ON HIS RIGHT AND C. J. ELLIS ON HIS LEFT.

gested that air or oxygen was dissolved and held unchanged in cyanide solution, all appearances went to show that the chemical action was independent of oxygen.

At that period I expressed my opinion on the subject to this section, thus: "Elsner has stated that metallic gold dissolved in cyanide of potassium only in the presence of oxygen. Not having seen the original account of Elsner's researches, I am not in a position to criticize his experiments, but I never could find that the presence of oxygen was necessary either to dissolve gold by itself or from ores by cyanide. If a piece of gold be immersed in cyanide solution, so that air to act on it would have to penetrate two to three inches of the solution, the gold will dissolve in its usual slow and steady fashion. The equation shows that either oxygen must be absorbed or hydrogen evolved. I have seen no evidence of the

Over and over again this guarded statement of a reaction, avowedly imperfectly understood, has been construed into an absolute assertion that oxygen was unnecessary.

The question was solved as regards metallic gold *per se* by MacLaurin of Auckland, New Zealand, who discovered the fundamental fact that oxygen remained uncombined in aqueous solution along with cyanide, and did not, as generally stated and assumed, oxidize the cyanide to cyanate. (Proc. Chem. Soc., 1893 [122], 81.) He confirmed the equation usually attributed to Elsner:



The cyanide process had been in general and increasing use several years before MacLaurin instituted his research, and the fact of its economical working proving the stability of the solutions in spite of protracted air exposure naturally carried with it the suggestion that,

assuming the necessity for oxygen in the chemical reaction, it must be soluble unchanged, in the cyanide solution. It was, however, left to MacLaurin to prove definitely what had been mistakenly called Elsner's equation, which in justice now ought to be called MacLaurin's equation.

As a matter of fact, Elsner does not give this equation. Previous experimenters, myself included, had not reckoned on oxygen being held free and in solution in cyanide solution, but had gone on the text book assumption that cyanide solutions readily absorbed and combined with oxygen to form cyanates—another mistake. In practice, cyanide solutions of the fixed alkalis are now found to be stable in air for all ordinary purposes.

There is a strong general tendency to assume that the reaction between cyanide and metallic gold is reproduced exactly in the case of the gold contained in ores, and this general assumption has often obscured metallurgical investigation. No allowance has been made for the number and variety of mineral substances, possibly unacted on themselves, but still capable of modifying the reaction between gold and cyanide. Highly suggestive work directed toward the elucidation of this complicated problem has been carried out by Gore, who found that metallic gold was dissolved more quickly when in contact with some minerals than with others, and that such inert substances as ground glass and sand had a distinctly accelerating influence. He found that a gold disc lying on clean white sand dissolved nearly five times as quickly as when immersed in cyanide solution. What is the nature of the action in this case, I do not pretend to say. No one has yet suggested that sand has any chemical action under the circumstances. Possibly they occlude oxygen—I cannot say.

Another investigator found that the merest trace of ferric oxide induced the action. Again I do not pretend to explain; but, if this is so, the comparatively easy and rapid dissolving of gold from ores is accounted for, as practically all auriferous ores contain more or less ferric oxide.

Acting on the assumption that the chemical action is the same in the case of gold ores as in the case of gold already extracted, refined, and prepared, many propositions have been made to apply air or oxygen by mechanical means to the ore and cyanide mixture—compressed air in all forms, mazes of perforated pipes and stirring apparatus have been tried in all countries; but, as far as I know, not one has been worth the trouble involved or has justified its existence, and all have therefore dropped out.

Many chemical means of oxidation have also been suggested—peroxides of barium and calcium, dichromates, and even nitroglycerine; but they are little heard of now.

Other methods of oxidation—without oxygen—have been proposed, by which cyanogen has been generated direct to combine with the gold. The principal of these are the addition of ferrocyanide—of any alkali metal—to the usual cyanide solution, used in the laboratory by

myself, but afterward independently worked out and patented by Moldenhauer in 1892; and bromide of cyanogen suggested by Dr. E. J. Mills to myself in 1888; but independently worked out by Sulman and Teed in 1894 '95. This last method—the Sulman-Teed—is the only modification of the original cyanide process as invented and described by the Forrests and myself that has taken root. It has been found of great utility in working the tellurides of Western Australia, but not much heard of elsewhere.

So far, we have dealt with the problem of getting the gold into solution, which is by far the most difficult part of the question. The precipitation from solution is comparatively easy. We knew well that zinc precipitated gold from its cyanide solution; but it remained to make this reaction industrially applicable. We used various forms of finely divided zinc with more or less advantage; but a picture of some fine zinc shavings, bought with other things in a shilling box of chemicals in my boyish days, haunted my mind, and repeatedly I described it to one of the works foreman without effect, until one day, when making a zinc case for packing cyanide, he made a shaving by a sharp tool and came asking me if this was what I wanted. My reply was "Yes," and in half an hour he had prepared the first bundle of zinc shavings for gold precipitation—the pioneer bundle of hundreds of tons of this flimsy but useful material.

We had, of course, to design an apparatus for using the zinc. Here the difficulties of small-scale work hampered us seriously. It seemed such an easy matter to put the zinc in a jar with a hole at the bottom and allow the gold-cyanide solution to run through it; and this simple scheme did very well for a few hours; but gradually the interstices in the zinc mass became choked with extremely fine precipitated gold, the solution flowed more and more slowly, till finally the zinc mass became impervious and the solution overflowed. A small tank, really a water-tight box with a compartment arranged for the well-known alternate up-flow and down-flow, was used; but the down-flow compartments did not work satisfactorily. Finally the form now in use, in which the down-flow is through zincless compartments and the up-flow through zinc-full compartments, was devised in its first form by the metallurgists then in charge of the MacArthur-Forrest installation in New Zealand. It was modified in detail by myself, to economize space and give ease of working, and was used in 1890 in substantially its present form.

Zinc precipitation is one of the weak points in the process. With care, the precipitation is complete to a few grains per ton, but the gold is collected in such fine mud, drying into dust, that loss is inevitable. Various modifications have been suggested in the method of precipitation, to avoid this and other inconveniences. Zinc itself has been used in the form of a fine dust which was mixed with the cyanide gold solution into almost an emulsion. The gold was quickly precipitated and the gold precipitate with a large excess of zinc allowed to settle, and was then collected. This, however, did not

get over the trouble of the gold being in soot-like dust, likely to loss with each breath of wind.

*Unfortunately, I have no photograph of the early period of cyanide work. At that time we did not realize to what extent we were making history. The principal researches were carried out in the lowest flat of a tenement at 319, Crown street, Glasgow, a place little better than a cellar that had the supreme advantage of no front door and therefore no distraction from visitors. We did most of our work between 8 p.m. and 2 a.m. when the Forrests had finished their day's work, as I had finished mine. It was usual to have pies and a pot of tea sent in from the nearest restaurant about 11 p.m. and when we were more than usually sleepy Dr. Robert Forrest brought out a bottle of a weird mixture labeled 'kid-reviver' and gave us a dose all round to keep us awake.

One line of research was the use of nascent chlorine and bromine, and at this time we had the usual text-book idea that there was "no simple solvent for gold"—a vague statement that served to confuse the mind and lead it away from the fact that mixtures of the *aqua regia* type were only devices for the production of a simple solvent, for example, chlorine. Mr. Morton, our commercial partner, one day innocently suggested that we might find a simple solution to act as solvent. I glibly gave the text-book answer that noble metals were not attacked by simple solvents. Instantly I mentally rebuked myself for giving such a feeble reply, and cyanide was entered on our list as a possibility. Again, I should say that we were little concerned as to the action of any solvent on gold itself, and I do not know that we ever tried our solvents on gold, though we did recognize that anything that would extract gold from ores would dissolve the metal, but not the reverse. It was common knowledge that *aqua regia* would dissolve gold, but that did not take us far, for every gold ore contains a small proportion of pyrite or other sulphide, which instantly precipitates the gold from its chloride solution. If the ore is oxidized by roasting, the precipitation does not occur, but we wanted a simple cheap process, and roasting is neither simple nor cheap. This throwing back of the gold (I hardly dare to call it re-precipitation, though 're' does mean 'back' as well as 'again') by pyrite is common to all acid solvents. To state it in other words: all acid solvents act first on base sulphides and if by a fluke gold does happen to be dissolved the sulphides do their work and throw it back. This is the nature of the action described in my former note in reference to the recovery of gold from cupreous tower-liquors where CuS precipitates gold from the chloride solution. A solvent to be available for the extraction of gold from ores must be able not only to dissolve it but to hold it against all comers. Cyanide does this, and, so far as is known, it is the only solvent that can do it. This is the real essence of the invention—the matter of weak or strong solutions follows as a matter of chemical

(and commercial) economies. It was a great step to find that cyanide of any strength would act thus, and a much smaller step to find that a weak solution was all-round better chemically (and commercially) than a strong one. Certainly the use of zinc as a precipitant was the keystone of the invention, but in itself it was a small affair. We knew that if we could dissolve the gold we could easily find a precipitant. It was common knowledge that zinc would precipitate gold from

74 *Tr Nuc Vom*
Pharm 1898 M + + +
Sp Chloroformi ʒij
Tr Aurant ʒp
- Zingib tost ʒv
Sp Vinæ Rect ʒip
Syr Lemonis ad ʒvi
##
Sig The Stimulating Tonic

Dose a dessert to a table-spoonful
in water.

More or less water to be used to
make an agreeable drink Rect

PREScription FOR THE KID-REVIVER.

its cyanide solution and it required no great mental effort to arrive at the conclusion that finely-divided zinc, because of its greater relative surface, would act better than massive zinc. It took us months to arrive at cyanide, but zinc was settled (mentally) in five minutes. The zinc position was neatly put by the Examiner of Patents, the late F. P. MacLean at Washington, when I was trying to persuade him to pass our zinc claim from the process standpoint: he looked at the drawing of the zinc extractor and said "That's not a process, that's a thing."

SOME interesting results are being obtained from a tube-mill in the O'Brien mill at Cobalt. This machine is 16 by 6 ft. One 6-ft. section of this has been partitioned off and crushing is done in it with cast-iron balls. The partition consists of a diaphragm separating the load of balls from the load of pebbles beyond it. It has been found to work satisfactorily. It requires more power, but the increased tonnage more than compensates for that additional cost. It has been roughly computed that it requires 15 hp. more to drive it, but there is a 30% increase in the quantity reduced. Another interesting result is that there is a wastage of 4 lb. of pebbles per ton ground, against 1.75 lb. of balls per ton ground.—*Northern Miner.*

*Extracts from a recent letter to the Editor.

Mining at the Nevada Consolidated

By P. B. McDonald

Comparatively little has been written about the mines of the Nevada Consolidated Copper Co. During the nine years that the company has operated, the best reading of what has been done is contained in the statements of the president and consulting engineer as published in the annual reports to the stockholders. These reports have chronicled the cost of mining by steam shovel in open pits, and the amount of ore in reserve after each year's extraction. The ore reserve has always been a critical factor, and has militated against buying of the stock as an 'investment,' as was widely done with Utah Copper shares. In 1906, when Mark L. Requa delivered his address at the driving of the last spike of the Nevada Northern railway, which bridges the 150 miles from the mines and smelter of the Nevada Consolidated near Ely to the main lines of railway to the north, he said, "to justify the building of the railroad required the development of millions of tons of ore; I think you will agree with me that we are justified when I say that there is developed at Copper Flat and at Ruth sufficient ore to supply the reduction plant for at least ten years." At that time the assured ore was computed at 11,432,962 tons averaging 1.97% copper. Since the beginning of operations to the present time the company has produced and sold 400,000,000 lb. of copper, yet the recoverable developed ore on December 31 last was estimated at 59,525,289 tons of 1.652% copper, assuring a life of at least 15 more years. That is, at the end of the mine's allotted 10 years of life, after producing a good deal more copper than had been estimated, there still remains an ore reserve more than three times larger than the orebody as originally limited.

As is seen by the accompanying table of yearly ore estimates, the company is in the best position since its inception.

| | Tons | Copper % |
|----------------|------------|----------|
| Sept. 30, 1907 | 11,432,962 | 1.97 |
| Sept. 30, 1908 | 20,000,000 | 1.94 |
| Sept. 30, 1909 | 20,000,000 | 1.94 |
| Sept. 30, 1910 | 19,260,823 | 1.79 |
| Dec. 31, 1911 | 19,853,371 | 1.66 |
| Dec. 31, 1912 | 18,850,551 | 1.67 |
| Dec. 31, 1913 | 20,198,599 | 1.65 |
| Dec. 31, 1914 | 41,920,296 | 1.68 |
| Dec. 31, 1915 | 59,525,289 | 1.652 |

The following general considerations can be stated: a great deal more ore has been proved available than was at first estimated; the grade of ore has been somewhat lower than was anticipated; although many economies and improvements have been effected by the operating staff, the proportion of copper recovered from the ore has been less than 70%. However, it is quite evident that the judgment of F. W. Bradley, J. H. Mackenzie, and Mark

L. Requa, who developed the enterprise, of J. Parke Channing, who interested capital in it, and of Pope Yeatman and C. B. Lakenan, who have directed its management, have been splendidly vindicated.

Regarding the low proportion of extraction, it was remarked recently by a pessimistic critic* that the companies operating the 'porphyry copper' mines of the West have nothing in particular of which to be proud. He argued that "an enormous quantity of cupriferous material is rushed through mills, and sufficient copper is caught to pay temporary dividends. The copper has been taken out and sold, largely to foreigners, at an alleged profit of from two to three cents per pound, and in doing this nearly two pounds of copper have been wasted for every three pounds recovered." It can be stated, in answer to this, that the proportion of copper recovered at the disseminated copper mines is now being decidedly increased. This is a result of the introduction of operating economies by the staffs at the reduction works, and of the saving grace of the new metallurgical aid, flotation. In the figures quoted by Mr. Austin in the above criticism of 'big business' he gave the recovery of copper at the Nevada Consolidated in 1912 as 66%; this has been increased to 70.18% for 1915 and probably will be improved further for 1916, when the refinements of the flotation process have been adjusted. To illustrate the bettered copper recovery of the porphyry mines, the Inspiration mine made a 79.95% recovery in 1915, the Miami 75.17%, while Utah Copper, Ray, and Chino, the recoveries of which ran from 50.6 to 57.4% in 1910-'11-'12, rose to 66.04, 67.88, and 67.86% in 1914. Still higher recoveries are possible, but not profitable, at this time; however, the flotation process is bound to raise the proportion recovered—some authorities predict as much as 10%.

Nevada Consolidated compares with the other porphyry coppers as follows, the figures being for operations in 1915: the grade of ore mined, 1.54% copper, was the lowest of any of the six companies except the Utah Copper, which was 1.434%, Chino and Miami being highest with 2.155 and 2.17% respectively. As to size of output Chino, Ray, and Nevada Consolidated each produced between 62,000,000 and 69,000,000 lb. of copper. The Nevada Consolidated mined the largest tonnage of ore, 3,981,520 tons, except Utah Copper, which mined 8,494,300 tons; these figures compare well with those of the Mesabi range iron mines. The Nevada Consolidated paid the largest amount in dividends, \$2,999,185, next to Utah Copper's \$6,904,082.

It is interesting to note, as pointed out by the financial

*W. L. Austin on 'Big Business,' M. & S. P., July 24, 1915.

press, that the shares of the porphyry copper mines have not attracted the same sentimental interest in trading on the stock exchanges, in proportion to their dividends, as, for instance, the Anaconda. Either the great disseminated orebodies, mostly worked by steam-shovels in open pits, do not appeal to the share-buying public to the same extent as the Michigan or Montana coppers, or perhaps the personality of the controlling interests of the porphyries does not inspire the same confidence as those concerned with the mines at Butte, Bisbee, or Calumet. Of course, the predictions of 10 years ago that the porphyry coppers would swamp the market with 5-cent copper did not materialize. In 1915 their total cost per pound of putting electrolytic copper on the Atlantic seaboard varied from 7.12c. in the case of Chino to 9.42c. for

Mudd, Spencer Penrose, E. P. Shove, W. Hinckle Smith.

CHINO COPPER Co.: C. M. MacNeill, president, D. C. Jackling, managing director, Charles Hayden, K. R. Babbitt, A. Chester Beatty, Sherwood Aldrich, Mark L. Sperry, Arthur J. Ronaghan, W. Hinckle Smith.

INSPIRATION CONSOLIDATED COPPER Co.: William B. Thompson, president, Joseph W. Allen, John F. Alvord, Thomas F. Cole, Edmund C. Converse, William E. Corey, Charles A. Corliss, Philip L. Foster, Eugene Meyer, Jr., Louis D. Ricketts, William G. Rockefeller, John D. Ryan, Charles H. Sabin, William B. Thompson, William D. Thornton, Albert H. Wiggin.

MIAMI COPPER Co.: Adolph Lewisohn, president, J. Parke Channing, vice-president, J. H. Susmann, Sam A. Lewisohn, Theo. L. Herrmann, B. Hochschild, William

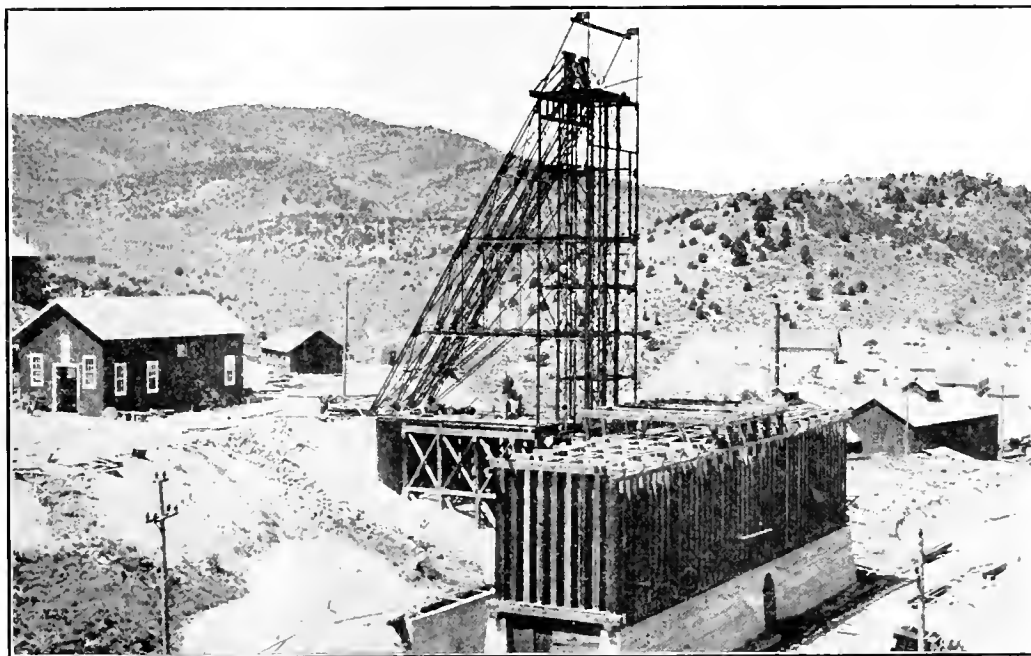

THE RUTH MINE OF NEVADA CONSOLIDATED, AT RUTH, NEVADA.

Ray, with Nevada Consolidated at 8.23c. and Utah Copper at 7.48c. These costs include "all possible charges, such as shipping, refining, marketing, legal expense, taxes, plant, and depreciation charges." The personnel of the boards of directors of the six porphyry coppers is a matter of general interest. It is as follows:

UTAH COPPER Co.: C. M. MacNeill, president, D. C. Jackling, managing director, Charles Hayden, Spencer Penrose, K. R. Babbitt, Murry Guggenheim, S. R. Guggenheim, S. W. Eccles, William Loeb, Jr., W. Hinckle Smith, John Hays Hammond, Wm. B. Thompson, Frank A. Schirmer, Eugene Meyer, Jr., Kenneth K. McLaren.

NEVADA CONSOLIDATED COPPER Co.: S. W. Eccles, president, D. C. Jackling, vice-president, C. M. MacNeill, Murry Guggenheim, S. R. Guggenheim, Judd Stewart, W. Hinckle Smith, Charles Hayden, W. E. Bennett, J. N. Steele, Wm. B. Thompson.

RAY CONSOLIDATED COPPER Co.: Sherwood Aldrich, president, D. C. Jackling, managing director, A. Chester Beatty, Charles Hayden, C. M. MacNeill, Seeley W.

H. Nichols, Walter T. Rosin, F. W. Estabrook, Hermann Sieleken.

In the way of practical mining, the Nevada Consolidated is somewhat different from the other porphyries. An important bearing upon its mining methods is occasioned by the comparative softness of the orebodies as compared, for instance, with the harder ore of the Ray mine. Again, the copper is found more uniformly disseminated through the ore, unlike the bunchy aggregates of copper sulphide in the Utah Copper monzonite. The large amount of iron sulphide has always been a troublesome difficulty in the concentrating. This has reacted against the efficient concentration of the ore at the mill. Regarding this, the consulting engineer, Pope Yeatman, said in his last report: "the average per cent copper contained in the concentrates was appreciably greater in 1915 than in 1914, being 6.14% in 1914 and 7.77% in 1915." Even this figure, 7.77%, is evidently very low, contrasting with 41.91% at Miami and 32.67% at Inspiration. However, Nevada Consolidated is the only

one of the six porphyry mines that smelts its own ore, suits low grade concentrate is less of a disadvantage.

The Nevada Consolidated has been an open pit mine worked by steam shovels. But during recent months the mining of the Ruth orebody, which is a half mile from the pits, has been started by underground methods, and the 11,000,000 tons there will be extracted by a modified 'caving' system. By reason of the deeper overburden on this orebody, it was estimated that the cost of stripping and working by pits would be greater than by underground methods. The ore at the Ruth is of comparatively high grade, being 2.35% in copper.

The starting of underground mining at a mine where open pit work has been the practice attracts a different set of men. Surface-work is largely a problem in rough and ready railroading. The qualities necessary in the employees are forceful 'get-there' leadership, some skilled mechanics, and a gang of common laborers. At the underground mine a different note predominates, and the individualistic characteristics that distinguish underground metal-miners are apparent in the faces seen. The large proportion of young men at the Ruth mine is especially noticeable. The decision to extract the Ruth orebody by underground mining, rather than by pits and steam-shovel, gives point to the opinion of some engineers who think that if the Utah Copper Co. were to open its mine anew, it would be done by underground mining because of the higher cost of the pit work than had been estimated.

It is scarcely fair to compare the mining costs of mines in different stages of their history, but for an approximate comparison the following figures are interesting. The mining cost at the Nevada Consolidated in 1915, practically all from open pits, was 15.24c.; added to this is a 'redemption cost' for the removal of overburden, varying from 15 to 30c. per ton of ore at the three pits of the company. At the Utah Copper, where open-pit work by steam-shovel accounted for practically all the ore produced in 1915, the cost of mining was 24.41c. per ton, of which 7.50c. represents charges for stripping. At Chino, also open-pit, the cost of mining ore in 1915 was 19.47c.; the charge for stripping is not given. At Ray Consolidated, where underground mining is done, the cost of mining in 1915 was 58.97c. per ton; which includes all fixed and general charges. At Inspiration, an underground mine, the mining cost for 1915 was 68c. per ton, which includes 20c. per ton of calculated charge for development by drifts, raises, and haulage-ways. At Miami, an underground mine, the mining cost in 1915 was 81.01 per ton, of which 31c. was for development and 70c. for mining.

The Ruth orebody is a nearly flat slightly-dipping wedge or lens, several hundreds of feet in length and width, and about 125 ft. thick on average. The greatest depth of ore from surface is 500 ft. In many ways this mass of soft copper ore is similar to the iron deposits of the Mesabi range, and the problems incident to its economical extraction are nearly identical. A difference lies in the fact that this copper mine is dry, as compared

with the torrents of water that complicate underground mining in Minnesota. A vertical shaft has been sunk in rock several hundreds of feet from the orebody and the levels marked off by drifts at regular intervals.

The stoping is done by a combination of the Ray system of room and pillar mining, by shrinkage and caving, with a branched raise method on the lower levels. The Ray system is more suitable for hard ore, so it has been found advisable to employ it at Ruth only in a modified way. The general principle of the Ray method, it will be recalled, is to over-hand slope a number of comparatively small shrinkage-rooms, with pillars of ore between, which are later extracted by caving; the idea being that it is easier to cave the orebody in a checker-board of small operations, where the work can be watched and directed carefully, than to engage in a wholesale method such as block-caving. Incidentally, the worth of the system of stoping at Ray was questioned by Professor F. W. Sperr in a recent article² on stoping methods, when he suggested that block-caving might have found excellent adaptation there. Above the 300-ft. level in the Ruth mine, caving by the Ray method has been generally applied. A good deal of difficulty was encountered in holding up drifts in such soft ground, where heavy angle-braced timbering only lasts a few weeks before it becomes crushed. The character of this orebody is not unlike that of an old compacted stock-pile; it is crumbly and broken to an extreme degree. Below the 300-ft. level, inclined raises have been put up from the 500-ft. or main tramming level. From these raises, branches are extended near the top, so that eight branches, at 12½-ft. centres at their tops, feed into one loading-chute. All raises are inclined, because the ore runs better, not blocking itself as it would in vertical raises. The long main raises are on a 50 or 60° incline, the short branched raises are 45°. Careful surveying is necessary to bring the tops of the raises at the properly spaced interval, 12½-ft. centres, so that practically no shoveling or wheelbarrowing of ore need be done. All raises are timbered closely with heavy squared timbers (not the ordinary loose cribbing)—a considerable item of expense. As regards this method of stoping by branched raises, the following is quoted from a recent article on 'Mining by Branched Raises' by F. W. Sperr:³ "Soft ore has a greater tendency to pack in chutes at a high angle, as well as to hang up in chutes at lower angles. The best angle for the worst ores is 65°, but some ores run freely at 45°. With hard ore, not so much trouble is experienced from packing in vertical raises; therefore the raises are made vertical in places for convenience of arrangement. Accessibility to the vertical chutes for the purpose of relieving the tendency to pack, can be more readily provided where the branches are inclined throughout their entire length, than in the case where they are partly vertical."

Robert Marsh, Jr., the general mine superintendent of the Nevada Consolidated, summed up the advantages

²M. & S. P., February 19, 1916.

³M. & S. P., May 29, 1916.

and disadvantages of mining such a soft heavy orebody by saying: "It is economical in powder and air, but it is necessary to count on the ground falling wherever it has any chance; it is not uncertain ground, for it will always fall; the caving of the overburden must be done according to some regular plan, or it will get mixed with the ore; it can be caved along a horizontal plane or on a slope, but care must be taken not to cave tongues of overburden into the ore." A recent incident at the mine was the raising of a 500-ft. incline from the tramming-level to surface, in order to get a small stock-pile of ore that was extracted in sinking an old incline shaft. This stock-pile could not be reached handily by teams on sur-

at its best in soft rock, because clayey cuttings are apt to choke the circulation of water. The mounted hammer-drill, such as the Leyner, is generally best in medium-hard rock, but in this mine the ore, while soft, is not clayey. As to stoper drills, the underground foreman remarked that he had tried thoroughly the products of two well-known manufacturers. Both did good work at the start, but one wore much better than the other, so he is putting in that type. Robert Marsh, the general mine superintendent, had a word to say about too many automatic devices on rock-drills. "They are likely to be valuable only for salemen's arguments," he remarked.

A mechanical ore-loader of the Halby type is being tried underground at the Ruth mine; it is too early to say if it will be a success. This machine loads tram-cars in drifts by electric power; it is manufactured at Marquette, Michigan. No candles are allowed in the Ruth mine, on account of fear of fire in the dry timbering. Carbide lamps are used with good satisfaction. The problem of giving the men what they want in their dinner-pails, so that individual taste is provided for, is solved by a modified 'cafeteria' arrangement. The men walk along where the foods are served, and each one's lunch is put up according to his preference. Such consideration for the men is well advised; good food promotes effective work.

At the pits, the operation of getting loaded cars out and empty cars in; of efficient steam-shoveling; and of drilling and blasting, have been perfected to an admirable degree under the direction of E. E. Vanderhoef. Churn-drills, or 'well-drillers,' of the Keystone type are employed to drill 6-in. vertical holes along the benches, usually to 30 or 50 ft. depth. These holes are put down 5 ft. deeper than the bench-level below, to make sure that the steam-shovels will not have to dig in unbroken rock. An iron funnel and long canvas hose are used to facilitate dropping the 'sticks' or cylinders of dynamite in the holes. Several kinds of dynamite and black powder are used as the various types of blasting may require. The holes are sprung or enlarged several times before being filled with explosives. Drift-blasting is only occasionally considered necessary. The 'well-drillers' give excellent results and appear adapted both for mining of the soft ore and for the stripping of overburden. These machines are used also to churn-drill to a depth of 500 ft. for exploring the orebody in advance of the mining. They are moved on their own wheels, but at times are transported on railroad-cars for longer distances. At the copper mines at Chuquibambata, Chile, where the ore is much harder, the churn-drills for blasting are said to have been superseded by tunnel-blasting, the 'tunnels' being driven by hand. We shall have some notes on this shortly from Howard W. Moore, with drawings showing how the tunnels are loaded.

The Nevada Consolidated is on the Lincoln Highway, which extends from New York to San Francisco. A sign-board on a rather indifferent piece of road in front of the mine, in the midst of mountain peaks and sage-brush flats, is labelled 'to New York.'

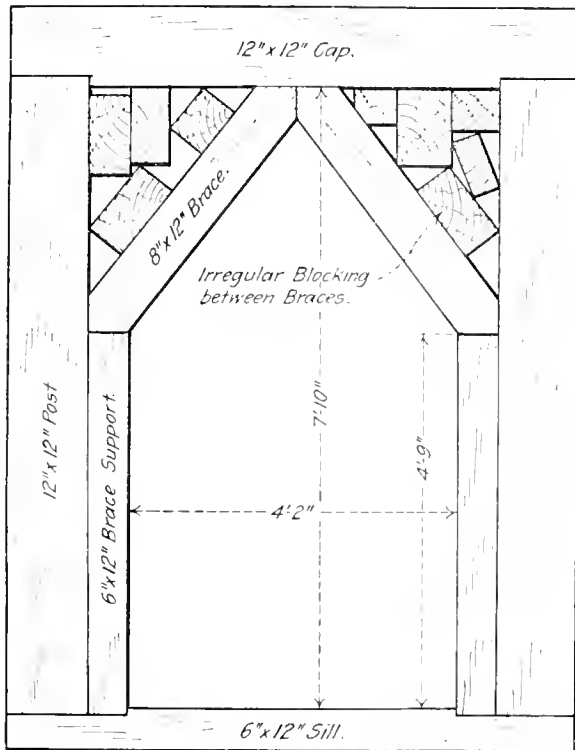

ANGLE-BRACED TIMBERING IN THE RUTH MINE, WHICH BECOMES CRUSHED IN A FEW WEEKS.

face, as it lay over a ridge of rough ground. It will be taken down the long raise, trammed to the shaft, and hoisted in the usual way.

The rock-drilling practice is somewhat different from that of a hard-ore mine. Seven or eight 6-ft. holes are employed in driving, making 45 ft. of drilling per cut. A record of fast driving was made in the development of the mine when 476 ft. was achieved in one month by two miners (one per shift) and four trammers, a total of six men. A light mounted one-man drill was used. But, after making this whirlwind record, the type of drill was found not adapted to this soft ore, and has been discarded. It was not that the rock was too hard for the drill, but that it was too soft. Being designed for a harder rock, the parts of the drill were too strong for this work and quickly wore themselves out by getting stuck in the soft rock and breaking the rotating device.

The mounted hammer-drill is well liked here. This is interesting, as such a type of drill is not supposed to be

Mining in Sardinia

By O. C. Engelder

The north end of Sardinia is due west of, and 140 miles from Rome. The island is 150 by 60 miles, with an area of 9187 square miles, exceeding that of Massachusetts. Steamers depart from Civitavecchia, a port 30 miles from Rome, every evening and arrive at the north end of the island early the next morning, where connection is made with the railway. An American tourist in Europe, with an eye for scenery, would be well repaid to give Sardinia a few days. The roads, hewn from solid rock and kept in perfect condition by the Government, fulfill all the demands of the motorist. Villages of one to five thousand inhabitants are scattered over the mountain slopes. The low buildings of stone and adobe with their whitewashed walls and red-tile roofs, and the curved and cobbled streets, are in accordance with customs that have not changed for centuries. Cagliari, with its 60,000 inhabitants, is the chief city.

The lead-zinc mining district is in the south-west. It is impossible to tell when the first lead ore was mined, since the civilization of this island dates back to pre-historic days. From relics found in old mines, such as bronze tools, lamps, stone picks, jasper hammers, lead slabs with dates cast in them, and from ancient tombs and mounds, it is known that the mining was done by the Phoenicians, Egyptians, Carthaginians, and finally the Romans. Until 1865, lead with its silver content was the only ore mined; this consisted of galena and cerussite. It was discovered then that much of the material discarded as waste was calamine, the silicate of zinc. From that time the mines of Sardinia have supplied much of Europe's lead and zinc, especially the latter.

Both the carbonates and sulphides of lead and zinc are mined in veins traversing schist, or in limestone at its contact with the schist, or in granite. The ore-shoots are irregular, but fairly persistent in depth. Until four years ago all drilling was by hand. Since then power-drills have been replacing the 'single-jack,' on the initiative of Charles W. Wright, resident manager for the Pertusola company. Many of the operators, however, are slow to appreciate the advantages of machinery. Practically all development is by adit, there being no large hoisting plants. A power-plant was completed during the past year and the more important mines will soon be operated by electric power.

The ore is concentrated near the mines. Water is abundant. The milling practice is much the same as in the United States. Hand-sorting receives much attention on account of cheapness of labor. Jaw-crushers, rolls, trommels, staking screens, jigs, etc., are of the usual pattern. The Wright table is replacing concentrators of an older type. No mills have as yet installed the flotation process, but several are experimenting with it. The chief loss has been in the slime, and since the ores are not complex, flotation should prove helpful.

The total lead concentrate production of Italy in 1913 was 11,651 metric tons, of which Sardinia produced 13,511 tons. The corresponding figures for zinc concentrate were 158,278 and 140,115 tons. The average grade of the lead concentrate was 56.26% lead, and 11.4 oz. silver per ton. The zinc concentrate averaged 40.26% zinc. Also 501 tons of mixed lead silver concentrate was produced, or a total of 203,136 tons of concentrates valued at \$5,624,000. Detailed statistics for the last two years are not yet available. Production during that period, however, has been curtailed by the War. Zinc mining was suspended with the first declaration of war, since practically all the concentrate was smelted in Belgium and Germany. Lately a limited amount of blende has been sold, and one calamine producer is shipping to the United States. The Pertusola company owns its own lead smelter, near Spezzia, and is accepting concentrate from some of the other producers.

No definite scale of wages for miners and shovelers exists. Employees are paid according to ability and the time served with the company. This method has its advantages, but also some disadvantages. To pay for labor according to quality and quantity is the ideal method, but a man's opinion of himself never agrees with the foreman's opinion, consequently there ensues some dissatisfaction. Efficient labor is not plentiful, and the companies are bound to have a large proportion of inefficient men on their payroll. Skilled labor is paid 70 to 90 cents per day, ordinary labor 40 to 60c., helpers and apprentices 30c. up. The best miners draw 50 to 70c. per eight-hour shift; ordinary labor is paid 40 to 60c., and boys 25c. up. In the mills, and where ore is sorted on surface, many boys are employed at a rate as low as 20c. For this work girls also are employed, receiving 15 to 25c. Mill and mine foremen receive \$35 to \$40 per month. Assayers, shift-bosses, office-men, etc., receive \$25 to \$40. These wages are low, and so is the efficiency. The men, especially common labor, are ignorant, slow and not healthy, consequently not strong. They are satisfied to live in an easy-going way; to earn enough for daily needs and to exert themselves as little as possible.

The mining laws, strictly enforced by the Government, are in favor of the laborer. One regulation that causes inconveniences to the companies and works against the cost-sheet compels employers to notify an employee a week in advance before suspending him. The employee, also, must give the company the same notice if he intends to quit. It means the company must pay the employee a week's wages when suspending him. Salaried employees must receive three months' notice. If an employee has a grievance, he reports the same to the nearest deputy, who appears at the mine-office in behalf of the employee in a few hours. Mines and mills are not permitted to operate on Sunday unless there has been a holiday during the week. No brothers are allowed to work in the same mine at the same time. Labor unions are unknown, so that the companies are not bothered with strikes.



TOPOGRAPHY OF THE JUDITH MOUNTAINS, MONTANA.

Gold Mining in the Judith Mountains, Montana

By O. W. Freeman

INTRODUCTION. On the plains of Montana east of the continental divide rise several detached smaller mountain groups. Mineral deposits are found in most of them. Since 1880 the Judith mountains have been producing gold and minor amounts of other metals. This group rises abruptly from the plains in central Montana to an average height of 6000 ft., or about 2000 ft. above the rolling plains around them. Judith peak, 6386 ft. altitude, is the highest point.

These mountains consist of several detached peaks connected by ridges, and run in general north-east. Weed and Pirsson first showed (18th Annual Report U. S. G. S. Part 3, Pages 437-616) that these peaks are the result of laccolithic intrusions in post-Cretaceous time. In the case of Judith peak, however, no floor of sedimentary rocks, which is necessary in order to have a laccolith, has been discovered; hence the intrusion is more in the nature of a stock. The outcrop of this stock is four miles across. More differentiation could occur in this large mass of igneous rock than in the smaller laccoliths, and therefore the richest gold deposits are found in its vicinity. The laccoliths are chiefly composed of rhyolite-porphry, but some granite and syenite are found. Later dikes and sheets of phonolite-porphry intrude both the rhyolite and sedimentary rocks. Mineral deposits are found associated with intrusions of both periods. Small amounts of gold and other metals have been detected, by assay, in the intrusive rocks, and there is no question but that the mineral deposits were derived from the molten magma.

GEOLOGY. No pre-Cambrian rocks are found in the Judith mountains as in the near-by Little Rockies and Little Belts, but there occurs a complete and apparently conformable series of Paleozoic rocks ranging in age from the Cambrian to late Carboniferous. Only the top of the Cambrian, which includes shales, conglomer-

ates, and limestones, is exposed, but this is known to be over 500 ft. thick. The rest of the Paleozoic is from 1000 to 1200 ft. thick. The Carboniferous formation in the Judiths is mostly limestone, belonging to the Madison formation of the Lower Carboniferous. At Yogo in the Little Belts 1200 ft. of shale and sandstone overlies the Madison and is known as the Quadrant formation, but in the Judiths this formation appears to be practically absent. Several thousand feet of Jurassic and Cretaceous shales and sandstones once covered what is now the Judith mountains, but erosion has removed these except where protected in synclinal folds between two intrusions as at Ruby Gulch and Maiden. From the tops of the laccoliths erosion has removed from 5000 to 6000 ft. of sedimentary rocks and exposed the intrusive rhyolite-porphry. The sedimentary rocks dip steeply in all directions away from the laccoliths. Some of the peaks are themselves composed of porphyry, but more often the highest points are ridges of hard limestone, while the valleys between are eroded in the softer porphyry and Cambrian rocks.

A few small veinlets are found in the porphyry; in Alpine gulch west of Maiden these are gold-bearing and in Judith peak east of Maiden they carry lead and copper, but they are small and unimportant. Claims have also been located near the contact of phonolite dikes, but actual gold production has been small. The valuable orebodies are replacement deposits of gold in limestone near the contact with intrusive laccoliths or sheets. The ore deposits usually occur in well defined shoots and chimneys, which sometimes consist of high grade ore surrounded by low-grade. If the ore is near a sheet of porphyry, it is always underneath the porphyry, which serves as the hanging wall. The richest ore, as at the Spotted Horse mine, is accompanied by purple fluorite. The fluorite resulted from the action of hydrofluoric acid

on limestone. This acid probably was brought by solutions from the intrusive molten magmas and may have aided in dissolving the gold. The gold-bearing limestone of the orebodies is usually siliceous, often jasperoid, and is more crystalline than before mineralization. The chief mineral deposits occur in the Carboniferous limestone, and are usually restricted to the upper part of it. This probably results from the upper Carboniferous limestone being thin bedded with many crevices that mineral-bearing solutions could follow, while the lower Carboniferous is massive and thick bedded. The limestone near the intrusions has frequently been brecciated, the angular fragments being cemented and replaced by ore. As the intrusive porphyry cooled, its volume would naturally contract and crevices would open along the contacts with the sedimentary rocks, which would serve for the passage of mineral-bearing solutions. The solutions could more easily dissolve the limestone and replace it with sulphides than the shales and sandstones, therefore little mineralization has occurred except in the limestone. Also carbonaceous matter in the limestone may have helped to precipitate the gold, as would also the lower pressure and temperature in the limestone. The orebodies are chiefly restricted to limestone and porphyry contacts, but occasionally shoots are found to extend some distance into the limestone, and sometimes the porphyry itself has been replaced. The gold seems to have been chiefly deposited as a telluride along with quartz, pyrite, calcite, and fluorite. Since the mineralization happened, erosion has removed the overlying rocks and exposed the mineral deposits. Surface waters and the air have oxidized the pyrite, chiefly to limonite, resulting in staining much of the ore a red, yellow, or brown. Practically all of the ore thus far mined is softened and decomposed by the agents of weathering. Free gold is rarely seen.

THE MINES in the Judith mountains require little timber, what is required being cut near-by. A good grade of sub-bituminous coal outcrops in the foot-hills a few miles away. Maiden, the chief town in the Judiths, is situated near the centre of the range and has a population of only a 100. At one time nearly 1000 people lived there. Hilger, on a branch railroad from Lewiston, is ten miles from Maiden and is the nearest railroad point. A daily stage connects with the trains. Lewiston, the county seat of Fergus county, is about 18 miles south-west of Maiden. Placer gold was discovered in Alpine gulch, near Maiden in 1880, and quartz claims were located soon afterward. The placers were small and were quickly exhausted, but the production from the quartz mines has been probably \$9,000,000.

The most important mines are those near Maiden, and of these the best known is the Spotted Horse, which is the largest producer. This mine was located in 1881 and operated fairly continuously until 1902, when it was closed, not to be re-opened until 1912. Its total production is considerably in excess of \$5,000,000. Much of the gold produced during its early operation was from high-grade ore, some being worth \$30,000 per ton.

The fluoritic gold ore shipped to the smelter averaged about \$100 per ton. A modern cyanide mill has just been completed and is now in successful operation on the lower grade ore. The mill has a rated capacity of 50 tons, but its actual capacity is more nearly 75 tons. Before the mill was built, no ore worth less than \$20 per ton could be shipped profitably to the smelter, now ore as low as \$3 per ton can be milled at a profit. The mill is provided with concentrators, the concentrate being shipped to the smelter. The mine is only developed to a depth of 585 ft., but the geologic conditions are such that it is reasonable to expect large orebodies. Enough ore is in reserve to supply the mill for several months. The mine is now producing about \$12,000 in gold per month.

The McGinness mine was located about 1880 and was worked at intervals to 1899. It was then closed until 1909, and since then has been worked chiefly by lessees. New machinery is being installed, and the mill is being overhauled. The McGinness has produced nearly \$2,000,000 in gold. The mine is developed to a depth of 426 ft. with over a mile of drifts. It is equipped with a 10-stamp mill, a concentrator for high-grade ore, and a cyanide-plant for the low-grade. As at the Spotted Horse much high-grade ore averaging \$100 per ton was shipped to the smelter. The ore of both the Spotted Horse and McGinness occurs in the Carboniferous limestone below steeply inclined sheets of porphyry that serve as the hanging wall of the stopes. The richest ore, consisting mostly of quartz and fluorite, is of a purple color.

The Cumberland mine, near the Spotted Horse, has been operated in recent years by lessees. It has produced about \$270,000, mostly in gold. It is developed by a 1000-ft. adit, and is equipped with a 150-ton cyanide-plant. The ore is found at the contact of limestone and porphyry. Above the adit the known ore has been removed, but recently the lessees have found ore of milling grade below the adit in a drift from a winze 40 ft. deep. Further development is now in progress.

The War Eagle is near the Cumberland and since 1910 several shipments of zinc ore carrying gold, silver, and lead have been made. The Cave mine on West Arnell's creek has also produced lead-silver ore in recent years. On the north side of the Judiths much development work has been done on the Copper King claim, where copper is the principal mineral. Prospecting has also been done on many other claims around Maiden, among which might be mentioned the Mount Grassy group, which has recently been bonded and sampled.

On Elk Mountain at the east end of the range work has been done on a lead-silver claim with encouraging results. The high price of the base metals has encouraged prospecting and work is active on several properties that ordinarily it would not pay to operate.

The Gilt Edge mine is on the east side of the mountains south of Maiden. The town is practically deserted today, but for several years following 1898 the neighbor-

ing mines were the most productive of any in the district. Their production is probably not far from \$1,500,000. The ore is low-grade, but a high recovery can be obtained cheaply by cyanidation. These mines were located in 1884 and '85. The orebodies occur under an intrusive sheet of porphyry in the soft thin-bedded Upper Carboniferous limestone. The 300-ton cyanide mill at Gilt Edge produced \$1,250,000 in gold from ores that came mostly from the Gold Reef and Great Northern properties. The mill was dismantled a few years ago and the production since then has been small, although a little gold-silver ore has been shipped from time to time.

The Whiskey Gulch mine has a 100-ton cyanide-mill and produced \$165,700 in 1903-'04 from \$5.50 gold ore, but has been closed since, on account of friction between stockholders. It is claimed that a large amount of low-grade ore is developed. The Mammoth near-by also has a 100-ton cyanide-plant and ore developed that will average \$6 per ton, but production has been small and it has been closed for several years owing to disagreement between the owners. A lease has been taken on the Whiskey Gulch mine and it is hoped that both of these properties will be re-opened soon.

The New Year mine is on the north side of the range west of Maiden. Several claims were located in New Year gulch in the early '80s, but although much money has been spent on development work the production has been small. As at Gilt Edge the orebodies occur in limestone under sheets of porphyry. The New Year itself is now idle, development work having failed to disclose any large orebodies. The New Year mill was re-built in 1911, and is of 150-ton capacity. Development work is now being done on the Gold Acres claims adjoining the New Year property. An adit 800-ft. long has been driven and work is progressing in drifts and raises. It is said that ore worth \$4 per ton has been developed. It is planned to treat this ore at the New Year mill, and if development continues, favorable to construct a large cyanide-plant. Among the other prospects located near New Year are the claims of Finlaw and Allister, who have found ore suitable for cyanidation.

OUTLOOK. Besides the mines and prospects mentioned, work is being done on others, several of which have produced some gold, such as the old Florence mine. The total production of metals from the district, chiefly in gold, is estimated at from \$9,000,000 to \$10,000,000. Unfortunately, development has rarely preceded extraction, and usually has been of a haphazard character. Frequently when the ore in sight was exhausted the mine was abandoned. There is little doubt but that careful prospecting and development will disclose large bodies of low-grade cheaply-mined gold ore, and possibly some deposits of the base metals will prove valuable. Mining has been at a low ebb in these mountains for several years, the output in 1914 being only \$100,810, mostly in gold. Recently several old properties have been re-opened and other new properties have entered

the list of producers. The high price of metals has stimulated prospecting, and the outlook is the best for many years.

SULPHURIC-ACID production of the United States during 1915, expressed in terms of 50°B., amounted to 3,868,152 short tons, valued at \$29,869,080. The average price was \$7.72 per ton, according to the U. S. Geological Survey. The 66° acid sold for \$13.95 per ton. By-product acid was as follows:

| Source | Quantity | Value | Price per ton |
|--------------------------------|----------------|--------------------|---------------|
| Copper smelters, 60° | 360,522 | \$2,749,633 | \$7.63 |
| Zinc smelters, 60° | 484,942 | 4,292,493 | 8.85 |
| Other strengths | 59,189 | 579,115 | 9.78 |
| Total | 904,653 | \$7,621,241 | \$8.42 |
| 60° acid reduced to 50°B. | 1,056,830 | | |

Too much weight must not be attached to the values given in the tables, as prices varied widely during the year. Producers who had previously entered into long-time contracts sold acid at prices much below those now current, especially during the last part of 1915. The trade in strong acids was active on account of the demand from the explosives and war munitions' industries, but this demand came only after the first quarter of the year and was very strong only during the last half. Before that time some acid plants were shut-down. The average values given are therefore much below those which ruled on the market at the close of the year. In 1914 the output of acid, reduced to 50°B., was 3,762,417 tons valued at \$24,163,331, or \$6.42 per ton. Of this, 950,798 tons was recovered from copper and zinc smelters.

ERZERUM, the city in Armenia recently captured by the Russians, has long been an important trade centre. It is 110 miles south-east of Trebizond on the Black sea, on a fertile plateau 6000 ft. above sea-level. Snow-clad mountain peaks surround the city and the climate is severe, the winters being long and cold. One of the principal industries is the working of copper, iron, and brass. It will be recalled that in Turkish countries, a man's wealth is indicated by his stock of copper vessels, which are prized highly. Erzerum is a settlement of great antiquity, having been founded by one of the early Roman emperors. It is on the caravan route from Trebizond to Teheran, and from Teheran to Mecca—a much traveled pilgrimage for Mohammedans. The importance of the caravan routes has declined somewhat since the building of the trans-Caucasian railway.

THE COMPANIA REAL DEL MONTE of Pachuca, Hidalgo, Mexico, is, perhaps, the largest producer of silver in the world. It operates in normal times eight silver mines about 70 miles north-east of Mexico City. The company is a subsidiary of the United States Smelting, Refining & Mining Co. of Boston. The Anaconda company at Butte, produces nearly as much silver as the Real del Monte, the silver being a by-product of its copper output.

Mica Mining

A number of enquiries have come in to us as to the practicality of mining mica in the Western States. At several metal mines a good deal of mica in fairly large crystals has been noticed, and the question has been asked as to whether it is worth while to sort out the mica and try to market it. At the start it can be stated that the marketing of mica, like that of the other secondary minerals, is a business not easy to arrange on a satisfactory basis. This is due to the fact that the marketable qualities of many non-metallic minerals vary so greatly that a consumer who has been obtaining his supply from a particular source, which has proved fairly satisfactory, is loath to buy from a new producer, because, even if the quality of the material seems good

but the General Electric Co., for instance, mines its own product in New Hampshire and Ontario. Muscovite, the light colored tough elastic potash mica, is the only variety of mica mined in this country. North Carolina leads in production, in that State farmers go mica hunting when crops do not require their attention. The deposits of commercial value have been found usually in pegmatite. Quebec is also an important, but irregular, producer.

To prepare mica for market, careful sorting is necessary, followed by splitting in plates $\frac{1}{16}$ in. thick. These plates are trimmed and split further. Rough small mica and the waste from sheet mica are ground fine. Both wet and dry grinding are done, but the methods are kept secret. The average price for sheet mica in this country during 1913 was 21c. per lb. as compared with 33c. in

| | | | | | | | | | |
|--|---|---|--|---|---|---|--|--|---|
| 1,000 lb. mine-run mica goes to riffers, each riffle handling 200 lbs. per day | 600 lb. thumb-trimmed plate goes to cutters | { 80 lb. uncleaned stove mica goes to cleaners 220 lb. waste goes to grinding. | { 50 lb. finished stove mica @ \$1.50 lb. \$ 90.00 20 lb. thin split goes to tube makers { 1500 tubes @ \$10.00 per M. 15.00 5 lbs. waste goes to grinding | | | | | | |
| | | | | 50 lb. 2 1/4 in. washer stock goes to washer cutters. | { 40 lb. uncleaned washers goes to washer sorters. 10 lb. waste goes to grinding | { 75 lb. electric plate finished @ 50 cents per lb. 37.50 20 lb. thin split goes to tube makers { 1500 tubes @ \$10.00 per M. 15.00 10 lbs. waste goes to grinding. | | | |
| | | | | | | | 60 lb. 1 1/4 in. washer stock goes to washer cutters | { 45 lb. uncleaned washers goes to washer sorters. 15 lb. waste goes to grinders. | { 20 lb. finished washers @ 40 cents per lb. 12.00 10 lb. waste goes to grinding. |
| | | | | | | | | | |
| 120 lb. waste goes to grinding. | { Total Waste, 765 lb Total shrinkage in entire process, 23 lb | { makes 28 lb 200-160 mesh @ 2 1/4 cents.63 makes 56 lb 160-120 mesh @ 2 cents. 1.12 makes 70 lb 120-80 mesh @ 1 3/4 cents. 1.22 makes 195 lb 80-40 mesh @ 1 1/2 cents. 1.57 makes 423 lb 40-19 mesh @ 1 1/2 cents. 5.34 | | | | | | | |
| | | | Total Value..... 1354.32 | | | | | | |

AVERAGE RECORD FROM A NEW HAMPSHIRE MICA MINE.

at first, he is not sure that future lots will continue so. Government publications, and those of various State departments, contain a lot of statistics of production and imports of mica, but information of the sort that the miner wants is scarce. In fact, the essential knowledge of how to prepare and market many of the non-metallic minerals is held only by individuals actually engaged in the business. Some consulting engineers make a specialty of non-metallic and minor minerals, and their advice should be secured in preference to spending much money on a plant or development, if the operator is in the dark as to the conditions of the trade. The companies that deal in unusual ores will generally buy odd lots of miscellaneous minerals if they can inspect them in advance and determine that they are valuable.

London has always been an important market for mica, and the products from India, Canada, Africa, and Brazil are brought there and sold. Sale is by auction, as this method enables the buyer to see exactly what he is getting. In the United States, the companies manufacturing electrical machinery require more or less mica,

1912 and 16c. in 1911, according to the U. S. Geological Survey; in other words, it is about as valuable as copper. Scrap mica was sold in 1913 for \$15.50 per ton. The total value of the country's mica production in 1913 was \$436,000, the largest annual output recorded. Sheet mica contributed \$353,517, the value of 1,700,677 lb.; scrap mica was 5322 tons, valued at \$82,543. During the same year, imports of sheet mica into this country were \$943,018 compared with \$748,973 in 1912. Uses of mica other than for insulators in electrical machinery are for stoves, washers, rings, and tubes. Ground mica is used to some extent as a lubricant; also in paints, as an adulterant in rubber goods, and for various minor industrial purposes. The accompanying flow-sheet of an average run of 1000 lb. of mica from a New Hampshire mica mine is taken from Bulletin 16 of the Arizona State Bureau of Mines.

FULLER'S EARTH production in 1915 was 47,901 tons, valued at \$489,219, an increase of 6920 tons and \$85,573 over the 1914 total. Imports decreased to 5536 tons.

Heard in the Bunk-House—III and IV

By W. H. Storms

III

"I'm just after readin' about a couple of fellows that got blowed up with powder," remarked 'Swede' Murphy when the men had quieted down in the bunk-house after supper. "It's a wonder they wouldn't get wise some day."

"A great many men think powder is not dangerous to handle," said the timber-boss. "What were these men doing with the powder?"

"Thawin' it out at an open fire," replied Murphy.

"It is safe enough to thaw powder if you do it right," responded the timber-man. "Hot water is pretty good. Most of the patent thawers and others that are any good use hot water."

"I once knew a pocket-miner that was the craziest man with powder I ever seen," said the miner from Arizona. "Him, and another fellow named Joe something worked once in the same tunnel on separate leases. The old man, Hank Gill, worked in the face of the main tunnel and Joe was putting up a raise at the end of a branch from the main tunnel. Joe was a fine blacksmith, but old Hank was no good at it. He'd over-heat the steel and then plunge it in the slack-tub and when he came to drill, the bits would break like glass. The old man had a pretty good blacksmith outfit and shop near the mouth of the tunnel. Joe had an outfit too, but his was at another mine up on top of the hill quite a long way from the tunnel. So to make it convenient, Joe agreed to sharpen the old man's steel for the use of his shop to sharpen his own. This worked all right. One day Joe quit about half-past eleven to sharpen his tools and get his dinner. He packed his picks and drills to the shop, made a fire in the forge—one of these portable affairs it was—and went to work on the steel. He was nearly through when he heard Hank coming. Hank came into the shop whistling and packing a small powder-box under his arm. In the box was 14 or 15 sticks of dynamite. These he began to take out of the box and lay them around the edge of the forge-fire on the black coals. Joe was most scared to death and says, 'For God's sake, Hank, what you tryin' to do—blow up the shop?'"

"It's froze," says Hank. "I want to thaw it out. It won't take long."

"Joe, having finished his work, only lingered long enough to see Hank pile some coal on the fire, punch it vigorously, and commence to stick his drills in, whistling and working the blower to beat the band all the time. Joe started for his cabin some distance away, after again telling Hank he would blow the whole outfit to hell.

"'Ain't you goin' to sharpen these drills?" called old

Hank after him. "What's the matter of ye—there ain't no danger."

"By this time Joe was on the run, but he yelled back: 'Run, you old fool, you will blow the whole outfit up.'

"'This powder won't hurt nothin,' Hank yelled in return. 'I eat it every morning for breakfast.'

"Joe went about getting his dinner, wondering how long old Hank would be lucky enough to stay alive. It was about fifteen or twenty minutes later that the entire Jackass Hill region was rocked with a terrific explosion. 'There goes old Hank and the shop,' Joe said aloud to himself. 'What a fool I was not to drive the old idiot out of the shop.'

"He hastened to the door of his cabin and looked in the direction of the blacksmith shop, when he was surprised, almost terrified, to see the old man running toward him from the direction of his own cabin. He was waving his arms wildly as he ran, yelling at the top of his lungs: 'By Gad, it *did* go off—it did go off. Yes sir, I wouldn't a believed it—it *did* go off.'

"'Where were you?' inquired Joe, much relieved to know that old Hank had escaped such a terrible death.

"'Me,' responded Hank: 'Oh, you know I can't sharpen and temper worth a cent, and as I was hungry I thought I would go up to the cabin and get me a bite to eat.'

"'Where did you leave the powder?' inquired Joe.

"'On the forge,' ingenuously replied Hank, 'an' just like you said, the damned stuff *did* go off—I wouldn't a believed it.'

"A visit to the site of the shop showed that a part of one post that had formed a corner of the structure was all that remained. Shop, tools, forge, everything, had vanished. The anvil was found over a hundred feet away, at the foot of the dump. It was uninjured. The forge was blown into shreds, the debris taking the direction of the tunnel, as was shown by numerous slivers of steel sticking in the timber-sets back from the mouth of the tunnel. As the old man said, 'It *did* go off.'

IV

"You was telling the other night, Murphy, about that ghost placer-mining outfit," said the timber-man to 'Swede' Murphy.

"Yes, an' wasn't it a beaut?" responded Murphy.

"It was," replied the timber-man, "but no worse than one I saw down on the Colorado river once, though this was built on different lines."

"Let's have it," put in Jimmy Glee, with a grin of anticipated pleasure, for Jimmy liked to hear about these freak mining outfits, and could tell of some interesting observations of his own.

"This company," said the timber man, "was a big concern, as far as money went, for they had plenty of it and put it out liberally, too. They bought up half a dozen sections or so of gravel beds near the Colorado river 50 miles above Yuma. The best of this gravel lay back 5 miles from the river and 250 to 300 ft. higher than the river. What they called 'gravel' was just the loose small rocks and dirt that came from the rocks under it—not washed smooth at all, but just such stuff as you can see almost anywhere on the desert. All the same there was gold in all of this gravel, and for years the Indians and Mexicans had been working it. They worked in different ways, but they always got some gold. Some of them would dig out a lot of this dry dirt—there wasn't a drop of water anywhere nearer than the river. They'd throw out the biggest rocks, screen the rest of it through about a quarter-mesh sieve, and then dump the fine stuff on a blanket, when two of them would catch hold of it, one on each side of the blanket, and toss the dirt up into the air. The very fine stuff would be blown away by the wind and the heavy part would fall back on the blanket and in this, of course, was the gold. This racket could only be worked on windy days, but that was pretty near any day, and sometimes it blows so hard down there that even the gold would be lost. In later years the Mexicans, and some white men too, took in dry-washing machines and these did pretty well whenever they could find a place that had not already been worked over about half a dozen times. From the very fine stuff the men would pick out the little pebbles and blow out the sand and in that way clean the gold. I expect when this gravel was first discovered they must have done pretty well at the dry-washing business. As the best of the ground had been worked over and over, there wasn't much doing when this outfit bought some ground and got ready to tackle the Basin on a big scale. Surveys were made for pipe-lines and flumes. A big pumping-plant was built along the river and pipe laid up the gulch five miles long. This pipe was 10 inches diameter. The scheme was to pump water from the river five miles up-hill to a reservoir located at a place above the gravel-beds, and then to lay another pipe-line from the reservoir to the head of the flume and just sluice the whole country down into the Colorado river, and get all of the gold left in the gravels in a short time by one big operation. When they came to figure on the cost of a cement reservoir in that place they decided to build a wooden tank instead. The tank was built. It was just about such a tank as you will see around almost any mill and would hold perhaps 3000 or 4000 gallons of water. Just think, Murphy, of running a big hydraulic mine with a 3000-gallon tank at the head of the system."

"Great scheme," laconically responded Murphy.

"When the pipe-line and tank was all finished, the flume built, and the big pumping-engines was ready, they started up and the pumps began to send a steady stream up the long pipe-line towards the great tank at the other end of the line. It worked all right for awhile,

but after a bit, when the pressure began to show on the gauges, the engines slacked up. There was not power enough, or something not enough, for only a small stream reached the tank at the upper end of the pipe. There was a misene somewhere.

"They tried it for some time, but could do no good in the way of mining, so the whole business came to an end. The company was in the hole about half a million and concluded to call it a loss and quit. I don't know much about such things, but it seems to me this all might have been figured out beforehand, but very evidently it was not done by competent engineers—'*quien sabe?*' as the greaser says."

"I knew a man once," said the Arizona miner, "that was a jeweler, and pretended to be an assayer too. He used to do assaying—his way—for a dollar when the regular price in that camp was three and a half. He picked up many a dollar from the honest prospector, too, I'm telling you. He used to cook the rock some way with acids and things. He always had something on his little stove—the fumes was enough to drive you out of the place. When he had finished cooking a sample of rock he would wash the pulp in a little porcelain dish, dry the concentrate, which generally was so small that no one could tell what it was without putting it under a high-power microscope, and then pretend to weigh this stuff. He called it the button; and then putting his jeweler's glass in his eye, he would go to the window and look carefully at it for a minute or so, talking to himself in a low tone all the time. Then he would solemnly write out a certificate of assay, stating that the rock went so many dollars in gold or silver, or copper, or whatever he claimed it to be, and take the poor sucker's dollar and invite him to come again. One day I took him a piece of white quartzite full of little black specks of horn-silver. I told him I was hard up and could not afford to waste any money on an assay, but would like to have his opinion as to its value, and then, if he thought it worth while I would have it assayed or not as the case might be. He took the ore to the window as usual, looked at it for some time earnestly and then came back to me and says, 'My friend, it's a piece of sandstone, not worth assaying; keep your money in your pocket and come in again when you find something else.'"

"I thanked him for his information, and assured him that I would call again, and then I asked him what the little black specks were. 'Them,' he said, 'is fly specks.' Fly specks—what do you think of that? The piece of ore from which I broke my sample had assayed over 1800 ounces silver per ton, and this old fraud didn't know chloride when he saw it."

"He was as dishonest in his small way," remarked the timber-man, "as some of the big outfits that defraud the public out of thousands."

TWENTY BROKEN CAM-SHAFTS at the Simmer Deep mill on the Rand have been welded, and since worked from 8 to 491 days, with an average use of 100 days.

Flotation-Oils

By O. C. Kilsten

*The sudden development of the art of flotation has brought about peculiar conditions in the oil market. A few years ago there was considerable expansion in the wood-distilling industry throughout the South on the hope of selling turpentine at not less than 50 cents per gallon. This hope was never realized and the industry became demoralized owing to excessive production and the efforts of some plants to keep going even at a loss. Pine-oil, which previously has had little sale, is a by-product from this industry and has been found one of the best oils for flotation purposes. At the time of the introduction of the flotation process into the country a stock of pine-oil was for sale at an attractive figure.

This supply of pine-oil and its derivatives has been largely exhausted and we are having to depend upon current production for the present supply. Hence the price has soared, and some of the pine-oil on the market has been adulterated.

During 1915 the principal investigation in connection with the flotation-oils was conducted for the purpose of finding a substitute for pine-oil on account of its cost. Most of the wood-creosotes have proved acceptable and are now being sold at lower prices than the pine-oils. How long this condition will continue is a matter of conjecture. The creosotes have proved to be good preservatives of wood, especially of railroad ties. However, coal-creosotes excel wood-creosotes for preserving timber, so that flotation will probably cause most of the wood-creosote to be diverted from timber preservation.

In view of such a possibility, considerable work has been done to determine whether coal-tar and its creosote derivative could not be successfully used as flotation-oil. In many instances it was possible to do so only after adding a small amount of one of the true wood-oils. There is some difficulty in getting the thick heavy coal-tar to mix well with the pulp, so that it is not the most desirable medium, and for that reason the coal-creosotes have met with more favor. Consequently, most of the gas-plants throughout the country have been able to contract for their output of creosote for some time to come. A similar condition prevails with regard to most of the wood-oils. There has been somewhat of a rush in the mining industry for contracts for these products in order that proposed mills will be assured of being able to operate. When Germany gets into the coal-creosote market again there will doubtless be lower prices for that particular product.

The petroleum men have not been slow to seek the flotation-oil market but their products have not as yet met with much success when used alone. It is possible

to mix small amounts of pine-oil or creosote with various petroleum products such as stove-oil and to obtain flotation with some degree of success, but the general tendency of petroleum products is to float both gangue and mineral non-selectively. The petroleum products that have met with the most success are some of the crude oils, such as Texas crude, and especially certain high-sulphur crude petroleum, obtainable in Kansas and in California. Stove-oil has met with some success in the copper-concentrating mills, as copper minerals do not have to be concentrated to the same degree of purity as do the lead and zinc minerals.

One other product that has proved successful has been the kerosene acid sludge from certain of the petroleum refineries. This material is the resultant of the removal of certain impurities with sulphuric acid and often consists of as much as 50% sulphuric acid.

The following is a list of dealers in different oils who have placed on the market various products. A host of these dealers are prepared to supply these products at any time, and of fairly uniform quality. None of them has been able to exactly duplicate their earload shipments, so that the general practice is to test each shipment of oil in a laboratory testing device to determine the proper method of using a given shipment of oil. This non-uniformity of shipments will doubtless vanish when the market becomes steady.

DEALERS IN FLOTATION-OILS

WOOD-OILS

Pine-Oils, Resin-Oils, Wood-Creosotes, Tar-Oils, Turpentine, Etc.

- 1—Pensacola Tar & Turpentine Co., Gull Point, Fla.
- 2—General Naval Stores Co., New York.
- 3—Georgia Pine & Turpentine Co., 158 Perry St., New York.
- 4—Central Distilling Co., Helena, Ark.
- 5—United Naval Stores Co., New York.
- 6—American Tar & Turpentine Co., New Orleans, La.
- 7—Cleveland Cliffs Iron Co., Cleveland, Ohio.
- 8—Chesapeake Tar & Rosin Co., Baltimore, Md.
- 9—Custer City Chemical Co., Custer City, Pa.
- 10—Yaryan Naval Stores Co., Brunswick, Ga.
- 11—Hussay & O'Connell, Savannah, Ga.
- 12—Florida Wood Products Co., Jacksonville, Fla.
- 13—Oregon Wood Distilling Co., Portland, Ore.
- 14—National Wood Products Co., Wilmington, N. C.
- 15—Chapman Manufacturing Co., Savannah, Ga.
- 16—Spiritine Chemical Co., Wilmington, N. C.

Eucalyptus-Oil

- 17—Atkins, Kroll & Co., San Francisco, Cal., and other importers.

COAL-TAR, COAL-CREOSOTES, AND AROMATIC HYDROCARBONS

- 1—The Barrett Co., New York.
- 2—F. J. Lewis Manufacturing Co., Chicago, Ill.
- 3—American Creosoting Co., New Orleans, La.
- 4—American Tar Products Co., Chicago, Ill., and St. Louis, Mo.

- 4—Republic Creosoting Co., Indianapolis, Ind., and Minneapolis, Minn.
- 6—American Coal Refining Co., Denver, Colo.
- 7—Numerous municipal and similar coal-gas plants.
- 8—Numerous by-product coke ovens, such as:
 - Pennsylvania Steel Co., Steelton, Pa.
 - National Tube Co., Penwood, W. Va.
 - Milwaukee Coke & Gas Co., Milwaukee, Wis.
 - Pennsylvania Steel Co., Lebanon, Pa.
 - Solvay Process Co., Syracuse, N. Y.
 - By-Products Coke Corporation, South Chicago, Ill.
 - Semet Solvay Co., Detroit, Mich.
 - Central Iron & Coal Co., Tuscaloosa, Ala.
 - New England Gas & Coke Co., Everett, Mass.
 - Illinois Steel Co., Joliet, Ill.
 - Maryland Steel Co., Sparrows Point, Md.

VEGETAL OILS

- 1—Cottonseed oil, etc., Southern Cottonseed Oil Co., New York.
- 2—Corn oil, Corn Products Co., New York.
- 3—Palm oil, Peter van Schaack & Co., Chicago, Ill.

ANIMAL OILS (FATTY ACIDS)

- 1—Oleic acid, Peter van Schaack & Co., Chicago, Ill.
- 2—Oil flotation grease emulsion, Mohawk Refining Co., Cleveland, Ohio.

PETROLEUM PRODUCTS

Crude, Asphaltum Base

- 1—California crude
 - Union Oil Co., Santa Paula, Cal.
 - Associated Oil Co., Los Angeles, Cal.
 - Standard Oil Co., Richmond, Cal.
- 2—Road oil No. 80, Harris Oil Co., Los Angeles, Cal.

Reconstructed Petroleum Oils

- 1—Special mineral separator, Continental Oil Co., Salt Lake City, Utah.
- 2—Solulene and minolene, Star Lubricating Co., Salt Lake City, Utah.

Refined Petroleum Products

- 1—Stove oil, Standard Oil Co., San Francisco, Cal.
- 2—Stanolind, etc., Continental Oil Co., Salt Lake City, Utah.
- 3—Flotation oils, Utah Oil Refining Co., Salt Lake City, Utah.
- 4—Heavy mineral flotation oils, Geo. P. Jones & Co., St. Louis, Mo.
- 5—Refinery acid sludge, any refinery.
- 6—Lubricating oils, any company.

SPECIAL MIXTURES OF MINERAL AND WOOD OILS

- 1—Calol oils, Standard Oil Co., Richmond, Cal.
- 2—Mine & Smelter Supply Co., Denver, Colo.

1—Hendrie & Bolthoff Manufacturing & Supply Co., Denver, Colo.

The costs of flotation oils have varied so much, owing to the unsettled market, that it is almost impossible to give an idea of what they should cost. For a rough estimate it is possible to say that crude petroleum will cost the same as for other purposes. Many of the specialized products such as coal-tar, listed above, will cost about 5c. or less per gallon. The coal-creosotes and the wood-creosotes cost 15 to 30c. per gal.; the pine oils 15 to 60c., and eucalyptus oil will cost \$1.50 or more per gal. The effect of the ending of the War as regards coal-tar and creosote in the American market is uncertain, but, so far as known, wood products will not be affected, and petroleum products for flotation will almost certainly be little affected. Flotation men do not like to have their oil costs go over 5c. per ton of slime treated, and many costs are nearer to 2c., or possibly even less.

There can be no doubt that the higher-grade pine-oils and other wood-oils are the best adapted to general flotation work, but the question of what is commercially feasible is entirely different. Thus, the wood-creosotes are meeting with much favor. Many of the special petroleum products, especially those high in sulphur, are adaptable for rough concentration of copper ores, but the most favored materials for such ores at present seem to be the coal-tar products in combination with topped crude petroleum oils from which the lighter fractions have been removed by distillation. Coal-tars and creosotes, with a small addition of pine-oils, are being used a great deal in zinc work, and the wood-creosotes find favor in the treatment of galena ores. Gold and silver ores seem to require much pine-oil, although the pine-oil can be diluted with some of the coal-creosote oils.

It will be found that there is a considerable number of oils that will give good results on any given ore, if the mechanical treatment is adjusted to suit each given oil.

Following is a table showing the amount of flotation-oils being consumed every month throughout the United States. These figures were collected at the beginning of 1916 by direct communication with the companies.

MONTHLY CONSUMPTION OF FLOTATION-OILS IN THE UNITED STATES

| Type of ore | Monthly tonnage of ore | | Monthly consumption of flotation-oils, beginning of 1916, lb. | | | | |
|------------------|------------------------|------------------------|---|--------------|------------|-----------|------------|
| | Beginning 1916 | End of 1916, estimated | Wood products | | | Petroleum | |
| | Tons | Tons | Pine-oil | Pine-tar oil | Eucalyptus | Creosote | Turpentine |
| Copper | 1,218,000 | 1,942,000 | 59,300 | 750 | ... | 417,000 | 1,500 |
| Zinc and complex | 248,000 | 350,000 | 60,750 | 667 | ... | 262,500 | 3,330 |
| Lead | 115,000 | 136,000 | 3,900 | ... | 216 | 121,000 | ... |
| Gold and silver | 45,700 | 123,000 | 9,830 | 750 | ... | 40,250 | ... |
| | 1,656,700 | 2,551,000 | 133,780 | 2,167 | 216 | 840,750 | 4,830 |
| | | | Monthly consumption of flotation-oils, beginning of 1916, lb. | | | | |
| | | | Coal products | | | Petroleum | |
| Type of ore | | Oleic acid | Tar | Creosote | Cresol | Crude | Fractions |
| Copper | | ... | 677,000 | 403,000 | 8,340 | 79,000 | 1,702,000 |
| Zinc and complex | | 5,830 | 10,670 | 46,500 | ... | 157,000 | 41,090 |
| Lead | | ... | ... | 9,250 | ... | ... | 660 |
| Gold and silver | | ... | 27,450 | 4,920 | ... | 7,090 | 6,250 |
| | | 5,830 | 715,120 | 463,670 | 8,340 | 243,090 | 1,749,910 |

Recent Patents

1,176,403.—PULSATOR RIFFLE-JIG. Robert H. Richards, Boston, Mass. Filed Aug. 13, 1914.

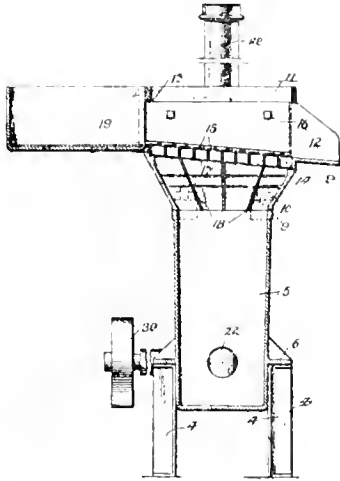

1. The combination with a jig including a screen and means for producing a unidirectional pulsing upward flow of water therethrough, of a plurality of transversely extending riffles, having an inverted L-shape in cross section mounted directly above the screen.
2. The combination of a sluice having an opening in its bottom; a screen mounted in said opening; a hutch beneath said screen; a plurality of closely spaced inverted L-shaped riffles extending transversely of said sluice mounted immediately above said screen with the upper flanges extending substantially horizontally in the direction of gravital flow in the sluice; and means connected with said hutch for producing a pulsing flow of water through said screen and riffles.

1,172,673. GRINDING-MILL. David Cole, Tucson, Ariz. Filed Nov. 10, 1913. Serial No. 800,184. (Cl. 83—9.)

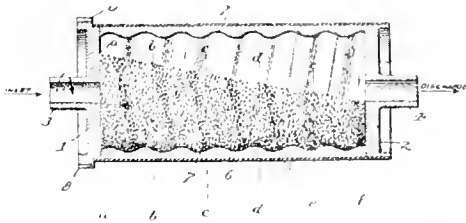

1. In a grinding mill, the combination of a rotatable hollow drum adapted to receive material at one end and discharge it, when ground, at the other end, and having a reversely feeding spirally corrugated inner surface; and means for rotating said drum, the spiral being of a direction to move the larger bodies of the charge in contact therewith, toward the inlet or receiving end of the drum when the latter is rotated in its normal grinding direction.

1,170,665. CONCENTRATION OF ORE. Edward Hoit Nutter, San Francisco, Cal., assignor to Minerals Separation American Syndicate (1913) Limited, London, England. Filed Aug. 31, 1915. Serial No. 48,169. (Cl. 83—85.)

1. A process of concentrating ores which consists in mixing the finely crushed ore with water, adding a minute quantity of a product obtained by treating a hydrocarbon (composed exclusively of hydrogen and carbon) with sulfuric acid, agi-

tating and aerating the mixture to form a froth, and separating the froth.

2. A process of concentrating ores which consists in mixing the finely crushed ore with water, adding a minute quantity of a product obtained by treating a mixture of hydrocarbons (composed exclusively of hydrogen and carbon) with sulfuric acid, agitating and aerating the mixture to form a froth, and separating the froth.

1,173,465. DREDGE SLUICE-JIG. Donald Steel, Palo Alto, Cal. Filed Dec. 24, 1914. Serial No. 878,865. (Cl. 83—58.)

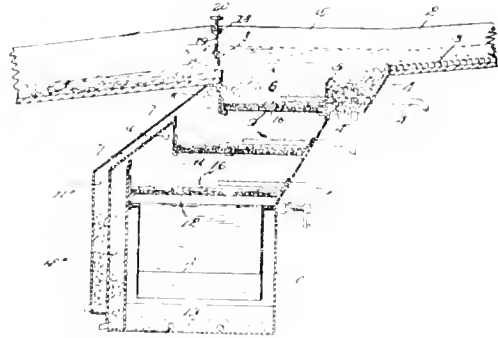

1. In combination, a sluice, a concentrating apparatus interposed therein for segregating the solids and values from the feed material, a trap to check the flow of material thereto and having means for supplying a rising stream of water for gently feeding part of the solids to said apparatus, an adjustable gate on the discharge side of said apparatus above the over-flow level of the trap for regulating the flow and depth of quiet water above said apparatus, and a dam below said gate to regulate the depth of solids held in the apparatus.

1,170,637. ORE CONCENTRATION. Arthur Howard Higgins, London, England, assignor to Minerals Separation American Syndicate (1913) Limited, London, England. Filed Aug. 31, 1915. Serial No. 48,177. (Cl. 83—85.)

1. A process of concentrating ores which consists in mixing the finely crushed ore with water, adding a minute quantity of a sulfuric acid derivative of an organic body, agitating and aerating the mixture to form a froth, and separating the froth.
2. A process of concentrating ores which consists in mixing the finely crushed ore with water, adding a minute quantity of a sulfuric acid derivative of an organic body and a small quantity of acid, agitating and aerating the mixture to form a froth, and separating the froth.

1,172,171. PAN-MOTION AMALGAMATOR. Karl Seun, Alameda, Cal. Filed Dec. 26, 1913. Serial No. 808,703. (Cl. 83—68.)

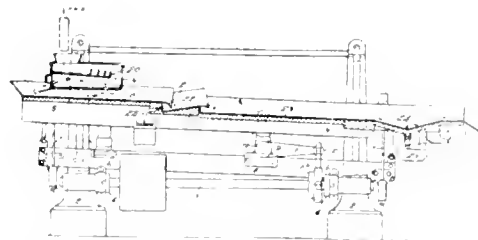

1. In an amalgamating apparatus, a table arranged at an incline and having an amalgam plate at its high end, said table having a pocket adjacent said high end, the inner end

the plate being downwardly inclined to extend in the pocket, an additional plate on the upper end being inclined downwardly in a direction toward the high end of the table and having its top end and bottom end downwardly, a third additional plate on the table having one end underlying said tailing end of the second additional plate and having its outer end portion concealed to form a pan the bottom of which extends below the plane of the third plate, said pan having a discharge outlet and said pocket also having a discharge outlet.

1,179,399. SINTERING MACHINE. John F. Austin, Montebey, Mexico, assignor to The American Smelting & Refining Company, New York, N. Y., a Corporation of New Jersey. Filed June 18, 1913. Renewed Sept. 17, 1915.



1. In a sintering machine, the combination with a movable carrier for the material to be treated, of an ignition device arranged above said carrier, said ignition device comprising a combustion chamber having an opening therein to receive the upper portion of the material on said carrier, and means for supplying a combustible fuel to said chamber.

1,180,089. PROCESS AND APPARATUS FOR SEPARATION OF ORES BY FLOTATION. Albert W. Thompson, Fitchburg, Mass., and David Cole, El Paso, Tex.; said Thompson assignor to G. M. Parks Company, Fitchburg, Mass., a Corporation of Massachusetts. Filed Jan. 13, 1916.

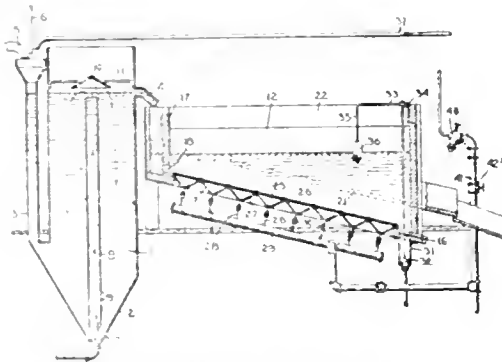

1. An apparatus for separating froth from the contents of the flotation process, comprising a nozzle for directing a jet of gaseous fluid commingled with globules of a liquid.

1,179,848. APPARATUS FOR THE PROCESS OF CLASSIFYING MINERALS. Robert H. Richards, Boston, Mass. Filed July 25, 1907. Serial No. 385,503. (Cl. 82-82.)

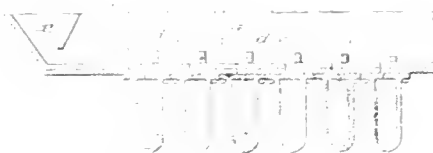

1. A classifier having a pocket of substantially constant area in horizontal cross-section throughout its entire depth, and

having a chamber below said pocket in communication therewith by a thoroughfare both concentrated and constricted with reference to at least one dimension of said pocket measured in a horizontal plane, whereby quicksand conditions may be maintained in said pocket and a high velocity of flow in said thoroughfare, a water inlet to said chamber, and a discharge from said chamber for heavier grains or particles previously passed through said thoroughfare.

1,179,658. AGITATING AND SETTLING TANK. John E. Rothwell, Butte, Mont., assignor to Colorado Iron Works Company, Denver, Colo., a Corporation of Maine. Filed Apr. 11, 1914. Serial No. 831,298. Renewed Sept. 10, 1915.

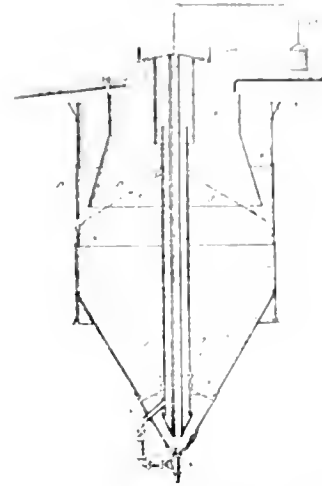

1. An apparatus of the class described comprising a tank, means for maintaining agitation therein, means for simultaneously withdrawing clear liquid therefrom and means above the normal level of the contents of the tank for withdrawing a portion of the material circulated through the agitation means.

1,179,522. PROCESS OF EXTRACTING METALS FROM THEIR ORES. William E. Greenawalt, Denver, Colo. Filed Sept. 30, 1912.

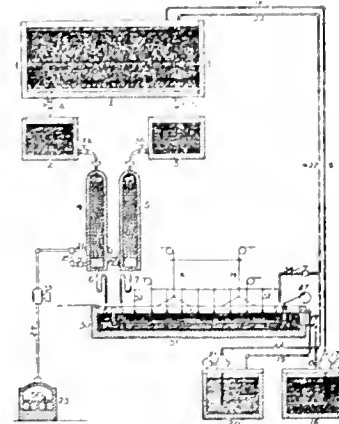

1. A process of extracting metals from their ores which consists in treating the ore with dilute sulfuric acid; separating the resulting rich metal sulfate solution from the gangue and introducing it into the cathode compartment of an electrolyzer; washing the residue and introducing the washwater into the anode compartment; then electrolyzing the solutions, whereby copper is precipitated at the cathode and the acid radical transferred to the anode, thus enriching the anolyte in acid; rejecting the cathode solution; returning the anode solution to the ore which in turn becomes the metal solution to be electrolyzed as the catholyte while fresh washwater is used as the anolyte, and repeating this cycle of solution, precipitation and regeneration as often as necessary to get the desired results.

REVIEW OF MINING

As seen at the world's great mining centres by our own correspondents.

MAGALIA, CALIFORNIA

PAST AND PRESENT.—LODE AND DRIFT MINES.

The Magalia district of Butte county is experiencing a real live revival. It has been a famous gold producer in past years, approximately \$50,000,000 having been taken from drift, placer, and surface mines within a radius of 10 miles of Magalia. The third largest nugget in the State was found here in the Willard claim or Red Hill, it weighing 832 oz., worth \$13,312. This claim also produced a 132-oz. nugget, and several weighing from 70 to 145 oz. The Perschbaker or Magalia drift mine was exceedingly rich in its day. For a generation the district has slumbered, with only a small amount of work being irregularly done; but the past few months have witnessed a change, with some really important developments.

The Springer and Mathewson mines on the Mathewson dike, 7 miles from Magalia, have been bonded by Harry M. Thompson representing San Francisco capital. A steam-shovel of 1500-cu. yd. capacity in 10 hours has been operated for two months. Working with this machine is a large crusher followed by rolls reducing ore to 1-in. size. From the rolls the product is run through sluice-boxes to catch the coarse gold. The head and tail samples are carefully assayed. If the latter are worth it they will be re-ground in tube or ball-mills. At present the work is entirely for sampling purposes. The vein-matter being opened is extensive. Ten men are employed. Results have been so satisfactory that last week the sampling was stopped. A concentrating plant is now being erected.

The Willard claim, or Red Hill, as it is better known, four miles from Magalia, has been bought through W. E. Young for San Francisco people and will be operated at once. The purchase price is reported to be \$10,000 cash. This property has been idle for nearly 20 years.

The Eureka (quartz), on Little Butte creek, has been examined recently by an engineer and a deal is expected in the near future. The property is owned by C. Crowder and others of Chico, who recently purchased it from J. Mugford and associates, all local people. At present a drift-channel is being opened. Eugene Richards is foreman and 8 men are employed.

W. F. Anderson has bonded a quartz property at Yankee Hill; operations will be started this summer.

Rich ore has been found at the Smith-Understock quartz mine on the west branch of Butte creek. A cross-cut to the vein was driven 120 ft. The ore shows plenty of free gold. The title to this property is in dispute at present, but the owners have a good property.

The drift mines are active also, as is shown by the following:

The Robinson, on the west branch of Butte creek, is being opened by J. A. Veatch, backed by San Jose and Napa people. Eight to ten men are employed, and an incline is being driven to open the old river channel. This company is also operating the Royal drift mine, four miles below the Robinson. Six men are at work extending the main adit to cut the channel. The report that this company has under option all of the drift mines along the Big Butte ridge is erroneous, as the titles to some of these claims are in dispute, the railroad lands also being mixed up in it. Carelessness in the matter of assessment work is the main cause of trouble in most cases.

The Oro Fino is producing, with W. F. Anderson in charge of 6 to 8 men.—At the Blue Hog, near Magalia, 6 men are working under J. Evans. This drift mine is owned by Los Angeles people, and is at present under bond to San Franciscans.—The old Thompson drift mine above Magalia is being opened by G. C. Allen and Chico men. An incline is being sunk to the channel. Four men are employed.—J. F. Littlefield, representing the Sutro interests, is at work with 4 men on a drift-channel adjoining the Eureka property on Little Butte creek.—The well-known Mineral Slide drift mine on Little Butte creek, from which over \$1,000,000 has been extracted, is expected to resume operations shortly.—The Lucky John drift mine adjoining the Mineral Slide is being opened by J. D. Hubbard and associates, with 4 men.

Judging from the number of engineers and others looking for gold mines, that have been in Magalia during the past month, it seems as if the old district is about to take on a new lease of life. The gold is more difficult to win now, but plenty of it is left. Once capital becomes interested in drift-mining, and good results are secured, more will be obtainable.

MEXICO CITY, MEXICO

SOME PERTINENT REMARKS ON MEXICAN CONDITIONS

In my letter published in the PRESS of January 29, I stated that the dominant faction, the Carranza, was the "best-behaved" of all; but in order that no false hopes may be raised in the breasts of mining men by this adjective, I shall now endeavor to explain what is meant by good behavior from a Mexican revolutionary faction. It is curious that the Liberal leader, Venustiano Carranza, should have been—like his arch reactionary enemy, Victoriano Huerta—a graduate of the Diaz school of *cientificos* or systematic grafters. However, such is the fact, and all available evidence indicates that the State army which Carranza used, when he first led his Constitutional army against the usurper Huerta in 1913, had originally been got ready to fight Madero, because the latter had been so officious as to undertake to investigate the disappearance of Federal funds entrusted to Carranza as governor of Coahuilla. If Huerta had been a different man, he might have succeeded in his usurpation in spite of both Carranza and President Wilson; but as his only mental equipment was a certain bulldog tenacity and ferocity, he was bound to fail in his attempted task of restoring the *hacendados* or slave-holders to power. Huerta was not shrewd enough to understand that the Madero revolution had tolled the knell for Mexican peonage, and that no ruler can re-enslave his native masses when once they have been awakened, unless he possesses an irresistible force of alien mercenaries. Moreover, whatever military sagacity he possessed was continually befogged by douches of brandy, which liquid was likewise the inspiration for his numerous political assassinations, performed in a style worthy of the best traditions of the African Gold Coast.

In spite of Huerta's political blunders and military stupidity, Carranza made little headway against him until he was lucky enough to get the aid of that invincible pair, Villa and Angeles, the first, a born leader of ruffians; the other a foreign-educated officer of artillery. The removal of the United States embargo on arms, in February, 1914, was soon followed by the fall of Huerta's stronghold of Torreon. And the seizure of Vera Cruz, two months later, by Admiral Fletcher, and the loss

of Zacatecas soon after decided Huerta to start for a European trip while the going was still good.

The entrance of the Constitutionalists into Mexico City, in August 1914, was hailed with joy by resident Liberals, even though the Judicium were grieved at the vast amount of stolen property, especially horses, that was flaunted by the victorious liberators. This grief was increased when the residents were initiated into the mysteries of 'intervention,' which implied the wholesale seizure without payment of private houses, automobiles, or anything else that happened to be defined as a 'military necessity' by the various generals. The climax came when Luis Cabrera, the spokesman of Carranza, arose in the general military convention of September and announced an indefinite suspension of the Constitution, and its guarantees of individual rights, in order that the Revolutionists might avoid any legal obstacle in their work of reconstruction. Curiously enough the Convention, when it had moved from Mexico City to Aguascalientes in October and deposed Carranza as First Chief in favor of Eulalio Gutierrez, announced its adherence to the Constitution. So, thereafter, there existed the anomaly—possible only among a people as illogical as the Mexicans—of a 'Constitutional' party repudiating the Constitution and of an 'Anti-Constitutional' party accepting it.

In the subsequent fratricidal struggle between Carranza and the Convention (described in my letter of April 8) the "immorality" of the Mexican people was never better exhibited than by the apathy with which they viewed the unscrupulous methods, used by both sides for partisan advantage, from the disregard of life and property to the incitement of race hatred. Thus, several Vera Cruz policemen were shot by General Candido Aguilar for the heinous offense of continuing at their posts during the American occupation. During February 1915, when General Obregon was "castigating" Mexico City with the help of Dr. Atl, he had that adventurous artist select a number of the best paintings in the National Museum, and soon thereafter these treasures mysteriously disappeared from their frames and started for parts unknown. But the most abominable of all the crimes of the Mexican liberators has been their organized system for starving the very people they came to liberate. This system was first used extensively by General Obregon in Mexico City during the punishment inflicted for its partiality to the Convention. It involved the stoppage of wholesale food importation, by failure to provide railroad-cars, and the closing-down of the chief employing concerns, by various devices. Among the latter, the most effective was the organization or encouragement of the local unions of the *Casa del Obrero* (I. W. U.) by the clever Dr. Atl. For, with an enthusiastic 'local,' a Government agent, in the guise of a 'comrade,' could easily call a strike and force a factory to shut-down rather than yield to his impossible demands. When food became dearer every day, and no work was obtainable, the workmen had the choice between Carranza's army and starvation, but the helpless women and children had only the latter alternative.

In the case of the Mexico City tramways, the Government got up a strike as an excuse for 'intervention,' in 1914, and has since operated them, as it is also now operating all the privately-owned railroads. In Mexico City the American Red Cross and a German relief society fed thousands for a while, but in October, Carranza prohibited further foreign charity, and the stricken masses began again to perish rapidly of famine and typhus. At first, the famine was artificial, having been organized by Obregon to recruit the army; but it soon became genuine, owing to the wholesale export of food during the spring of 1914. Part of this export was conducted directly by Carranza, in exchange for foreign munitions, and the balance was handled by all sorts of traders, who rushed to enjoy the huge profits incidental to exportation from a country in the throes of a rapidly depreciating currency.

Although the export taxes had been put on a gold basis and greatly augmented, the Mexican currency fell much faster than

prices rose. As Carranza saw that the lion's share of the profit from exportation was still flowing into private pockets, he decided to organize an export monopoly. This monopoly was called the *Casa Exportadora, Angel La Garda* and its artful combination, for its own ends, of the different branches of the political administration, indicate that the ingenuity of the Mexican mind has been greatly underrated by some critics. The export monopoly utilized the services of the Federal, State, and Municipal governments and of the railroads (all of which are now 'intervened' by Carranza) in the following manner: The Federation prohibited the export of food from the national territory, while the States prohibited its export beyond their own boundaries, and installed 'prebostal' committees to fix its selling price. Each municipality had also a prebostal sub-committee. Finally, the Casa La Garda was given first choice in the assignment of empty railroad-cars.

The trap being set, we may now watch its functioning in a certain maize-raising State during the autumn of 1915. Owing to the export of the old crop, the new maize began to sell at the hitherto unknown price of \$60 (Mexican paper) per hectolitre (2.75 bushels). Immediately the Prebostal Committee came to the rescue of the "defrauded masses" and to save them from the "unscrupulous greed of the traffickers in human misery" announced a legal maximum price for maize (beyond which no one could sell under pain of confiscation) of \$30 per hectolitre. The producers were astounded, but helpless, and most of them hid their maize to await a better price. Soon the big producers were visited by the suave agents of the Casa La Garda and offered \$40 per hectolitre for their grain. Fearing discovery of their stock by the Prebostal Committee, and a possible confiscation on the charge of "hoarding," many producers accepted the La Garda offer and delivered their hidden maize to its waiting railroad-cars. Then, in spite of State boundaries and port detectives, the La Garda grain found no obstacle in soon reaching the hold of an Atlantic liner, and departing on its mission to finally gladden the heart of some European chief of commissary. As an additional perquisite, the Casa La Garda controlled its returning empties, and lucky was the importer who could secure one of them for a premium (beyond the railroad charges) of less than \$3000 per car.

The result of these adroit maneuvers of the Casa La Garda was that the price of the staple foods—maize and beans, which had weakened a little at the time of the autumn harvests of 1915—began to soar again in December and in February 1916 reached the prices of the August famine. At present writing, food prices on paper are far beyond the February level and are following closely the equivalent prices abroad in gold. Had the export-prohibitive decrees of last October been really enforced, the price of food would have continued on the basis of local paper money and thousands of the innocent victims of starvation and pestilence would now be alive. In only a few industries has it been practicable to advance wages as fast as the rise of prices.

Ostensibly, the vast profits of the Casa La Garda go to the Government, to pay the huge expenses involved in the maintenance of its army of 150,000 men. And though many affirm that the bulk of the profit is really diverted to the gaping pockets of the inner ring of Carranza generals and politicians, I have no conclusive evidence on this point. But whoever gets the gain, the results of the export operations are equally disastrous for the proletariat, whom Carranza came to "rescue and save." The very perfection of the La Garda export machine will tempt its controllers to continue its functioning long after any military excuse for it has ceased; and in this event the Mexican people are surely doomed to decimation by a famine of a severity and extent unknown even in Hindustan.

The paper-money plague (described in my January letter) still overshadows and hoods all commercial transactions. The Government acknowledges the issue of P700,000,000 of genuine Provisional Government and Constitutional Army notes, while the number of 'counterfeit' bills is legion. Gen-

eral Gringas was shot dead last summer by his own Carranza faction for the crime of passing counterfeit money, strangely enough within a year of surviving a volley from a firing squad of the opposite party. The Gringas operations involved mostly the circulation of ₧50 and ₧100 Provisional-Government bills, and were the cause of the extensive official 're-sealing,' which was practised subsequently to ensure the genuineness of these denominations. There is good reason to believe that General Gringas was simply a scapegoat for men higher up, and that these latter were among the chief officials of the Carranza treasury department.

On May 1, when the old notes had already reached a value of below 2c. (U. S.) per *peso*, they began to be replaced by a new issue of "unfalsifiable" bills which are redeemed in gold, at the rate of 10c. (U. S.) per *peso*, by a newly appointed *Comision de Cambios*. The old notes are decreed to be worth only one-fourth as much as the new notes and are continued as legal tender only until July 1, beyond which date probably no one, not even the *Comision de Cambios* itself, knows what will be their status or value.

The handling of the Carranza paper money has exhibited as much knavery but much less cunning than that of the export monopoly. In fact, the main reliance for the success of the former has been the paper decree. These decrees have formed the chief literary output of the Revolution and have been printed by the million and posted everywhere—a fresh one nearly every day—to announce to the victims the intentions of their "benevolent" rulers. Nowhere—not even in an American legislature—has there ever existed such a childlike belief in the efficacy of human fiat. Every subject has been tackled, from the fixation of prices and wages to the compulsory literatization of the whole peon class within eight months, but, luckily for the victims, the enforcement of the new decrees has usually lagged far behind their announced content.

Perhaps the worst mistake in the fiat-money operations has been the gradual repudiation by the Government of its own notes for the payment of public dues. After putting the mining, the export, and the import taxes on a gold basis, it announced, on May 1, a gold basis for railroad-fares and freight-rates. Though the subsidized I. W. W. propaganda (described in my January letter) was suppressed last February, the I. W. W. unions still remain, and these recently declared a general strike of railroad men who demanded the payment of wages on a gold basis. After being out two days the strikers were put under martial law and ordered back to work, pending "due consideration of their grievances." This strike indicates that the worm has at last turned and that the workers are beginning to refuse to be the chief victims of the rule of fools and of rogues, posing as reformers. If the demands of the railroaders are granted, the Army will be the next to request the payment of its wages in gold, and this event is liable to finish the Carranza régime. As the Mexican army has no commissary, a soldier must buy his food from his pay. Under Diaz, the daily wage of the common soldier was 62 centavos; this was increased to ₧1 under Madero and ₧1.50 under Huerta. But these wages were all in silver, while the ₧2.50 rate, now paid by Carranza, represents only 25 centavos in silver, and with food prices approaching a gold basis the soldier is finding it increasingly difficult to live on his wages.

At present, the two chief obstacles to the general resumption of operations by equipped mines are the lack of railroad transport and of protection for life and property. Thousands of locomotives and cars have been destroyed since 1911, and the survivors are mostly monopolized for the Army, the Casa La Garda, or by some local general as his personal perquisite. Even the ownership by a mining company of its own rolling-stock gives no assured relief, for such is liable to be "intervened" at any time for military purposes. Only a few rich districts, like Pachuca, have enjoyed anything like regular transportation, and this is due to sheltered locations and the fiscal interest of the Government in maintaining the bullion

outputs of the operating companies. Even these properties are not able to work at full capacity.

The danger of brigandage takes two forms: first, it may come from the visits of organized bands of rebels, who may merely collect all the arms, powder, and cash in sight and depart, or stay and make a systematic clean-up of everything from the brass pump-valves to the manager's underwear; and second, it may arise from the discharge of a vicious workman, who is liable to seek revenge by joining the local garrison and return a few days later to attack his erstwhile employer, accompanied by a group of fellow-soldiers as unscrupulous and blood-thirsty as himself.

Like his reactionary predecessors, Carranza maintains a rigid censorship and a complete collection of official newspapers to supply misinformation to a credulous populace. In the Capital are the morning vultures *El Pueblo* and *El Democrata*, and the evening viper of the literary Dr. Atl called the *Accion Mundial*. There is also the weekly *Revista Nacional*, and a separate daily for nearly every State capital. In Mexico City is established an official press bureau, guided by two American newspaper men whose function is to censor all foreign telegrams and to prepare such local bulletins as are considered suitable for foreign consumption. The limitations enforced by law and public opinion, on even the yellow journalist of the United States, do not bother his Mexican brother, provided the latter has loyalty to his temporary political chief and literary skill; his pen is as free as the wind, and neither truth, decency, or consideration of consequence need hamper the soaring or sinking of its composing muse.

In spite of the above facts, the existing woes of Mexico are not entirely due to Carranza's incompetence or his subalterns' viciousness; they proceed as much from historical and social causes. Indeed, many of the Federal and State executive departments now contain various well-intentioned officials; and if few of these have the knowledge and ability required for efficient work, this is a result of the wretched educational system maintained by the Diaz dictatorship. For this reason, no executive efficiency can be expected from any Mexican régime of this generation that chooses to continue the present rule against the employment of foreign experts in public offices.

The Diaz usurpation of 1876 arrested the progress that Mexico had been making toward self-government under Juarez and Lerdo de Tejada. Though Diaz and his rascally henchmen were shrewd enough to maintain peace (so as to encourage the foreign enterprises, from whose legal and illegal taxation they thrived), they left the official and educated classes of Mexico in a much worse moral and mental state than they found them. The destructive anarchy, now so prevalent among even the Carranza leaders, simply arises from the possession of modern weapons by men who have never been disciplined by education, and have followed their own wild impulses from the cradle upward. If Mexico could find a local Kossuth or Garibaldi she might hope for salvation from even her present dreadful plight; but as such a discovery is most improbable, it is considered by thoughtful natives that the only remedy is an appeal to the United States for such aid as she gave Cuba under like circumstances.

At all large sales here of New York exchange, Army officers are eager buyers and hundreds of them now have tidy fortunes, safely deposited in American banks, as the concrete result of three arduous years of patriotic labor. It is unlikely therefore that many of Carranza's officers will care to fight the country where their fortunes are deposited and where they soon expect to move to enjoy them. As for the rabble of peons, ranging in age from 7 to 70 and impressed into the Army by starvation, they have little love for their leaders and less for their Government. Thus, the American punitive expedition, should it decide to stay indefinitely in Mexico, might be heartily welcomed by everyone except Carranza; and his resistance would probably be restricted to big words at long range.

THE MINING SUMMARY

The news of the week as told by our special correspondents and compiled from the local press.

ALASKA

Thirty-three miles of track is completed on the railroad from Anchorage, allowing fairly fast trains to run. On the branch line to the Matanuska coalfield there are 670 men at work. At all points there are 2921 men on the pay-roll, also 296 horses. On May 19 Congress at Washington voted an appropriation of \$5,247,000 for the railway.

CHISANA

It is reported that A. McGettigan and others have discovered rich gravel 29 miles from Shushanna City.

JUNEAU

The Alaska Gold Mining & Development Co. has been incorporated by Carl E. Lund and Ray H. Stevens of Juneau and John McWilliams of Douglas, with a capital of \$1,000,000 to acquire, develop, and operate mining properties wherever found.

The incline shaft at the Ready Bullion mine was completed to 2488 ft. depth, with an inclination of 70°, on May 24. Sinking and raising connected with great exactness, credit being given to the surveyor at the Alaska Treadwell, J. Johnson. Work commenced on March 19, 1915. The completion of this shaft, although an expensive undertaking, will be a money-saver. Ore will now be hoisted to the surface at a saving in some instances of over a quarter of a mile haul. The old shaft will be used for filling only.

VALDEZ

According to the Valdez *Mail*, the season for the Prince William Sound copper mines opens full of promise and with increased activity. The Latouche, Ellamar, Granby, Three-Man, Alaska Mines, Reynolds-Alaska, Seattle-Alaska, Thomas, Dickey, and many others on the mainland and islands in the Sound are developing well.

ARIZONA

YAVAPAI COUNTY

Churned-ore is to be done at the Shea property, adjoining the Copper Chief at Jerome. This is the first time that any

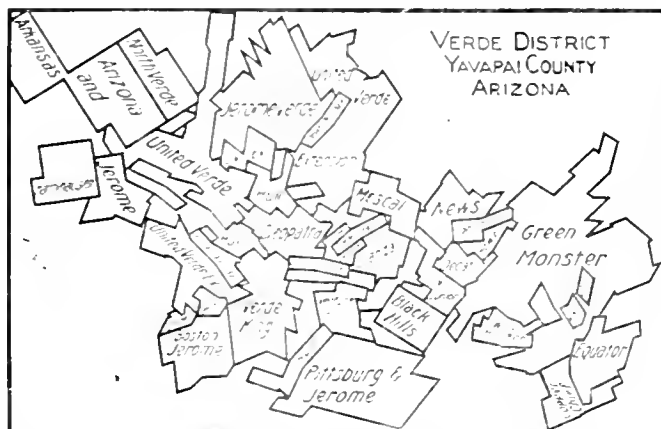

ground at Jerome has been prospecting. A. P. Thompson is in charge. The Copper Chief is shipping 30 tons of ore daily, also treating some ore locally.

Following the action of the Green Monster company, the Boston & Jerome Copper Co., whose property is south of the United Verde, has listed its stock in San Francisco. The United Verde Extension is producing 200 tons of 15% copper ore daily.

COCHISE COUNTY

For the sum of \$600,000 the property of the Leadville Mining Co. of Courtland has been optioned to the Needles Mining & Smelting Company.

Property of J. Letson and D. E. McGarry near Bisbee has been acquired by the Arizona-Bisbee Copper Co., recently formed at Phoenix. Extensive exploration will follow at an early date.

CALIFORNIA

The second annual California first-aid and mine-rescue field meet will be held at Sacramento, during the State Fair, on September 6. This meet will be held under the auspices of the California Metal Producers' Association, assisted by the Industrial Accident Commission, and the U. S. Bureau of Mines. Entries should be sent at the earliest possible date to Robt. I. Kerr, 1109 Merchants National Bank building, San Francisco, by August 1.

AMADOR COUNTY

(Special Correspondence.)—The new stamp-mill for the Argonaut mine at Jackson is being constructed by the Knight company of Sutter Creek. The new mill is to replace the present one, and will be erected on the opposite side of the hill to the west of the present plant, the change of site being favored because of the better facilities for impounding tailing. From the new mill-site, the residue will flow by gravity to the large natural basin, at the lower end of which a concrete dam 400 ft. long and 40 ft. high at the lowest point is nearing completion. This structure is being built under contract by Bent Bros. of Los Angeles at a cost of \$25,000, and will be known as the Eastwood dam, after the company's consulting engineer, F. Eastwood. An underground hoist has been installed at the lowest level of the Argonaut mine, which will make possible the sinking of the shaft an additional 3000 feet.

Persistent rumors are afloat to the effect that the Moore mine, south of Jackson, is shortly to be re-opened by W. J. Loring and A. Burch, well known in these parts. The title was cleared, and papers in the transaction prepared prior to Mr. Loring's recent trip East.

The Central Eureka company has accepted the resignation of J. E. Davis, who has superintended the property for several years, and appointed in his stead a Mr. Jose of San Francisco, who recently had charge of operations at a mining property at Towle, Placer county. C. E. Julihn was employed by the company to make an examination of the Central Eureka property to ascertain whether the shareholders would be justified in paying another assessment to carry on the work. His report shows that only a middle section of the lode has been explored, and that other veins will undoubtedly be developed on both sides of this middle portion. Just as productive veins have been proved in adjacent mines in the vicinity of the hanging and the foot-wall of the lode. He also recommends sinking a winze from the 3200-ft., the present lowest level, to 3300 ft., claiming that there are substantial prospects for more ore in depth, judging by the ore-shoots

worked above 3200 ft. A 5c. assessment has been levied. The mine is equipped with an electrically-driven 40-stamp mill, steam hoist, electric pumps, and other modern machinery. The shaft is in excellent condition.

Sutter Creek, May 31.

CALAVERAS COUNTY

(Special Correspondence.)—An option and lease have been taken on the Ozark gravel mine, Six-mile creek, near Angels Camp, by R. E. Herndon, C. Fishman, and D. Headington. The property has been unwatered and the old workings cleaned out and re-timbered. A 10-hp. hoist and a rotary mill have been installed, all driven by electric power. Mr. Herndon is resident there. New ground is being opened, and it is expected that the mill will soon be treating good gravel from the lower channel.

The Economic mine near Esmeralda is being operated by the Standard Amalgamated Exploration Corporation. Equipment consists of a 20-stamp mill and a gasoline-driven electric lighting plant. A 100-hp. motor-driven compressor is being installed, electric power supplied by the P. G. & E. Co. The property has been extensively developed from the adit-level. The main adit is out 1100 ft. north, from which an east cross-cut has been run 1200 ft., and a west cross-cut 400 ft.; 1400 ft. of raises have been put up, and a large body of ore has been developed. It is expected that the stamp-mill will be started in about 30 days. L. Robin is superintendent and consulting engineer

Angels Camp, May 22.

ELDORADO COUNTY

At the Montezuma mine, 10 miles south-west of Placerville, the new shaft is down 830 ft. Cross-cutting is under way at 500 and 800 ft., where on both levels wide shoots of \$5 to \$10 ore has been opened. The mine is under option to G. Wingfield and W. J. Loring of the California Exploration Co.—Development in the Rhetta, south of the Montezuma, is reported to be very satisfactory.

NEVADA COUNTY

In the east drift at 1800 ft. in the Providence mine of the North Star company rich ore has been opened, much of it containing telluride of gold.

Six feet of ore showing free gold and arsenical pyrite has been cut in an adit of the Red Ledge mine, near Washington. Williamson brothers and C. Cole are owners.

PLUMAS COUNTY

(Special Correspondence.)—The Engels Copper company has commenced cross-sectioning its survey (location) for a railway up Indian creek from the Western Pacific line to the mine. The present transport scheme for concentrate is aerial tram to Lower Camp, then in three wagons, carrying 25 tons, hauled by a caterpillar-tractor, using distillate, to Taylorsville, finally to the W. P. line at Keddie by motor-truck. The light steel bridges on the county roads make the last change necessary.

A number of prospects in this district are worthy of attention.

Taylorsville, May 26.

COLORADO

During June the leading metal producers in the State will raise wages, affecting 5000 miners. It is thought that the increase will be general, benefiting a total of 25,000 employees.

BOULDER COUNTY

(Special Correspondence.)—The Blue Jay and Burnt Mountain claims in the Nederland tungsten district have been taken over by J. Conners of Oatman, Arizona, and S. T. Weller of Denver. A company called the Tungsten Girl Co. will operate the properties. In the transaction a good deal of cash changed

hands, while the original owners will receive royalties until the total price is paid. Both mines have good prospects. Ore will be treated at the National Tungsten Co.'s mill, whose property adjoins.

Ward, June 2.

OURAY COUNTY

In *The Plaindealer* of Ouray on May 23 a brief history of mining in this county is given by William Rathmell. In September 1874, prospectors located claims. Permanent settlement started in 1876-'77. Up to 1893 the region was considered a silver-lead producer; after that gold predominated.

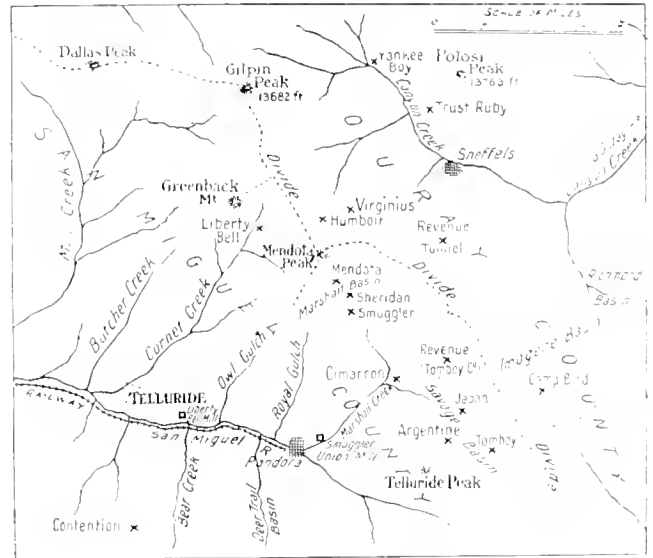

PART OF THE SAN JUAN REGION.

Such mines as the Camp Bird, Yankee Girl, Guston, and American Nettie were opened later. The country consists of a deeply-scored volcanic plateau, the volcanics lying on a great series of sedimentaries.

The Camp Bird company reports as follows for the first quarter of 1916:

| | |
|---|-----------|
| Ore treated, tons | 6,813 |
| Bullion and concentrate sold | \$215,975 |
| Profit (after deducting London and Paris charges) | 135,000 |
| Profit from Santa Gertrudis, Mexico | 206,000 |

Development totaled 1101 ft. There was spent on the cross-cut adit from the mill, \$19,421. It is in 329 ft., of the total of 10,700 ft. to reach the vein. The work is to be performed by the Camp Bird Tunnel, Mining & Transportation Co. The measurable ore reserves are reduced to a negligible quantity of about 1200 tons, and there is little prospect of developing any more of consequence in the Camp Bird vein until after the adit has reached the vein. Work in ninth level discloses a character of vein and rich ore showing along the floor fully sufficient to warrant exploration at greater depth. Further, this stretch of ground represents but about 10% of a mineralized vein, the remainder of which can only be worked with any degree of safety, if indeed at all, through a drainage-tunnel; and while it is possible the ground immediately under No. 9 level might be explored by sinking No. 3 shaft, the other 90% of the vein would still remain but partly developed. For this reason it was decided not to sink a shaft that would only partly develop, but to drive a drainage-tunnel, with the completion of which will leave all of the mineralized stretch, some 4000 ft. in length, accessible for exploration at minimum expense.

TELLUR COUNTY (CRIPPLE CREEK)

(Special Correspondence.)—The Consolidated Mines & Reduction Co., with head office at Denver, is developing the Buck-

horn Kitty Wells, Dante mine, Lendertoot tunnel, and Ella W. claims. Most of the ore shipped, 3 carloads per week, comes from the Dante. The general superintendent, James A. Force, formerly of San Francisco, states that the company is now constructing a concentrating plant of 500-ton capacity on its property. The mill-site has been selected, and building operations will commence not later than September of this year. The mill will be of similar construction to those in general use in the district, differing only in that flotation concentration will be featured to a greater extent than has been heretofore attempted here. It is the intention of the company to give preference to flotation over gravity concentration, possibly to the extent of eliminating the tables entirely. Future operations of this plant, if proposed plans are carried out, should be of general interest to the mining fraternity.

Criddle Creek, May 28.

Total output of the district during May was \$1,185,840 from 84,150 tons of ore.

IDAHO

LEWIS COUNTY

(Special Correspondence.)—Two 25-hp. oil engines, machine-drills, and other machinery have arrived at the Copper Queen mine, 20 miles from Salmon City.

The tungsten mine on Patterson creek shipped 100 sacks of 65% concentrate in April, worth a total of \$10,000.

There are more mining deals in progress in the district than for years. An active season has begun.

Salmon City, May 22.

SHOSHONE COUNTY (COLEER MINE)

Owing, it is said, to the physical condition of the Marsh mine at Burke, and the company's financial condition, the mine and mill are closed indefinitely. Some directors voted themselves a lease on Marsh ground, in spite of protests by E. Pohlman of Spokane. In April, he said, the mill feed averaged 7% lead; a profit was made on this. On May 15 the cash resources were \$15,000. The mine contains 20,000 tons of ore.

The new 125-ton mill at the Hypotheek mine is ready for work. The ore averages 10% lead and 10 oz. silver per ton. Concentrate of 25 to 40% grade will go to the Northport smelter. At 500, 700, and 900 ft. depth the mine has two years' reserves.

Construction of a spur from the O-W, R. & N. line at Kellogg to a new smelter of the Bunker Hill & Sullivan company is soon to begin. Excavation for the plant is also to commence. W. K. Mallett of Anaconda will be in charge of erection.

The total cost of the Millan district in May totaled \$110,000 for labor alone. Of this the Federal paid \$60,000; Hunter, \$30,000; and National, \$10,000.

MICHIGAN

THE COPPER COUNTY

(Special Correspondence.)—Utilization of mill tailing for underground filling is again in vogue in the different mines of the Copper Range company, where practicable. The Quincy now proposes to use the same system.

There is reason to believe that the Quincy will have but little future trouble from severe air-blasts. Some years ago when the situation was at its worst manager Lawton put into practice the plan of maintaining a 200-ft. solid rock surrounding each shaft as it was sunk. This required the locking-up of a great deal of valuable ore near the shaft, but it was effective, as there have been no air-blasts in any of the lower levels since that time. Every blast, hit, on the other hand, occurred at a point but was from surface to the bottom, and when damage has been done to the shaft proper it has happened where shaft-pillars were particularly narrow. The reason for the hope that there will not be future trouble comes

from the fact that shafts No. 2 and 7 "came home," as the Cornish miners say, some time ago. And a couple of weeks ago No. 6 shaft "came home" too, a little late, but doing some damage in getting in. Thanks to foresight there was not a fatality nor a serious injury resulting from the No. 6 air-blast. Further than that, a re-arrangement of the miners above the spot where the damage was done made it possible to maintain production of rock at a figure nearly normal. The shaft was damaged for a distance of several hundred feet, and repair work has been hastened to a remarkable extent.

Houghton, May 23.

MISSOURI

JASPER COUNTY (JOELIN)

When complete early in June, the D. C. & E. No. 2 concentrating plant north of Webb City will have a capacity of 1500 tons per 24 hours. Part of the ore comes direct from the crusher to the rougher-jigs, eliminating a lot of feed to the rolls. Ore is mined at a depth of 134 to 160 ft.

Ore prices declined again due to lower spelter, the range being between \$60 and \$95 per ton. The lower average basis price for May means a reduction of 50c. per day in wages for June, namely, \$3.75. The output of the Missouri-Kansas-Oklahoma region last week was 5822 tons blende, 268 tons calamine, and 992 tons lead, averaging \$75, \$52, and \$92 per ton, respectively. The total value was \$515,811.

MONTANA

LEWIS AND CLARK COUNTY

With a capital of 1,500,000 \$1 shares, the Thomas Cruse Mining & Development Co. has been incorporated. Richard Cruse is president. The Thomas Cruse estate, including the Franklin mine in the Scratch Gravel district, the Bald Mountain mine and other properties, collectively known as the Cruse mine at Marysville, the Blue Cloud and other mining claims in Lewis and Clark county, the Jackson Creek and other claims and real estate in Jefferson county; numerous mining claims in Meagher county; 1000 acres of patented oil-land in the heart of the oilfields near the Montana-Wyoming boundary line, not far from Red Lodge; and real estate in the city of Helena, are to be developed.

SHARROW COUNTY

The Butte Workmen's Union is demanding an increase of 50c. per day in wages, and a strike has started which may spread to great proportions. At present this does not affect the mines.

NEVADA

CLARK COUNTY

Ore shipments from Goodsprings in April were between 5000 and 6000 tons. Production increases each month, new mines entering the list. Tungsten is being mined at Clark mountain, 31 miles from Goodsprings.

ELKO COUNTY

(Special Correspondence.)—There are three well-equipped mills in the Gold Circle district, and prospects are numerous. Comparatively nothing is known of the district beyond its immediate neighborhood. We are in the position of most camps which have had a transient boom; a wild rush at the outset, a few strikes of high-grade pockets which were dug out almost as soon as found, then a slow but sure dying out of interest and the consequent desertion of the place. Where money has been spent intelligently results have justified the expenditure. At present one mine here, the Elko Prince, is adding more to the mineral production of Nevada than all the much-advertised Rochester district, yet Gold Circle gets no publicity. Possibly this is the fault of its miners and owners.

Midas, May 24.

ESMERALDA COUNTY

The Goldfield Consolidated reports for May as follows: ore treated, 32,400 tons; gold recovered, \$214,500; profit, \$52,500.

HUMBOLDT COUNTY

A boulder of antimony ore weighing 640 lb., containing 70% metal, was recently found at the Syndicate mine east of Kodak, which is 6 miles north of Lovelock.

NYE COUNTY

Some time next month the Round Mountain Mining Co. will publish a statement regarding its mine, placer ground, and finances. Dividend possibilities will also be discussed.

Work continues at the Pioneer Consolidated at Pioneer. At a depth of 110 ft. \$3 to \$7 ore is being broken for a width of 10 ft.; also a fair grade across 15 ft. at 170 ft. At 250 ft. is \$6 ore over a great width, while rich ore is being sacked. The mill is saving 60 to 70% by amalgamation; tests show that additions to the plant would give 98.85%. Enough bullion is being saved to pay mining and milling.

Tonopah last week yielded 8778 tons worth \$183,264. At 1240 ft. in the Halifax is 20 ft. of good ore.

OREGON

JOSEPHINE COUNTY

On the Illinois river G. E. Anderson has a gravel mine yielding gold and platinum. A recent clean-up from about 20 days' sluicing recovered 122 oz. of gold. About 10 oz. of platinum is saved each winter. Two giants and an elevator are operated.

SOUTH DAKOTA

LAWRENCE COUNTY

A dividend of 2½c. a share, or \$12,500, has been declared by the Wasp No. 2 company. The gold ore maintains its average, and a carload of wolframite is expected to sell for \$90,000.

TEXAS

BREWSTER COUNTY

(Special Correspondence.)—The recent bandit raid and Mexican disturbances in the Big Bend country of this county have not caused any cessation of quicksilver mining operations in the Terlingua district, which is west of Boquillas. Most of the American mining men along the border have sent their wives and families to the interior as a matter of precaution. The International Mining Co. expects to resume operations at its mine, situated just across the river in Mexico from Boquillas, at an early date.

The old Buick mine, situated in the Boracho district, not far from Van Horn, is proving a rich producer of zinc ore. S. W. Howard, owner of the property, resumed development on it a short time ago, and he has already shipped considerable quantities of ore that settled well at the smelter. Other zinc prospects in the same locality will be opened in a short time, it is announced.

Exploration work in the Hazel mine in the Van Horn district brought to light a large body of silver and copper ore recently. This property has been on a producing basis for some time.

William Crosby and R. R. Foster are preparing to develop a deposit of tungsten ore which they recently discovered in the Quitman mountains, south-west of here.

J. A. Johnson and associates are installing machinery preparatory to opening up a copper mine on Canal creek, in Foard county, near Crowell. It was in that same locality that George B. McClland and associates operating under the name of the Grand Belt Copper Co. built a smelter to treat the copper beds in 1884. The company spent about \$500,000 in prospecting and development, and then abandoned it all because it was found to be unprofitable.

Alpine, May 17.

UTAH

BOXELDER COUNTY

At the Lakeview Mining Co.'s property at Promontory 90 men are employed. Heavy shipments of zinc ore are made regularly. The southern part of the mine will become a large lead producer. The main adit is in 1200 ft. Lessees are employing 50 men. The district is thriving, and new companies are being formed.

JUAB COUNTY

The Tintic Milling Co. is to enlarge its plant to three times its present capacity of 100 tons per day. The leaching capacity is 300 tons. Six new roasting-furnaces will be erected.

PIUTE COUNTY

The Mineral Products Co.'s potash plant at Marysvale is not giving entire satisfaction. New machinery is to be installed to overcome the trouble. At present 115 tons of ore is treated daily, yielding 15 tons of potash by the Chappell roasting and boiling process. A sulphuric-acid plant is being added. G. T. Jones is in charge. At the mine the adit is in 1000 ft. in a good grade of alunite, up to 40 ft. in width.

The Florence Mining & Milling Co. of Philadelphia, near the Mineral Products Co., has purchased a mill-site. The proposed plant will treat 100 tons of alunite daily, yielding 12 to 15 tons of potash.

SUMMIT COUNTY

East of Clayton's peak, near Park City, the Daly Judge Extension Mining Co. has commenced work at a depth of 90 ft. A 700-ft. adit has also been driven. Prospects are said to be good.

Daily shipments from the Silver King Consolidated are 60 tons of \$50 ore. Development and production is under way at 1800 ft. Machinery for a 10,000-ft. aerial tram and 500-ton mill has been ordered.

WYOMING

PARK COUNTY

Extensive deposits of sulphur have been developed by the Midwest Sulphur Co. near Cody, and its 4-ton capacity plant of refined sulphur is to be enlarged to 12 tons a day, costing \$20,000. The output so far is 1800 tons of sulphur. The ore is quarried, and some contains 40%. Contracts have been made for the output at \$35 to \$40 per ton; normal prices are from \$20 to \$25.

PLATTE COUNTY

An extensive pocket of copper ore has been opened in the Colorado Fuel & Iron Co.'s mine at Sunrise.

CANADA

BRITISH COLUMBIA

During the year ended April 30, 1916, the Rambler-Cariboo Mining Co., operating at Three Forks, produced 1,292,614 lb. lead, 472,871 lb. zinc, and 156,755 oz. silver, from 21,000 tons of ore concentrated. Revenue from all sources totaled \$155,964. Dividends absorbed \$52,500. Cash on hand amounts to \$16,509. The mine is in good condition. On the 700, 800, 900, 1000, and 1200-ft. levels new shoots were opened. On June 15 there will be paid 2c. a share, or \$35,000.

A small stamp-mill is to be erected at the Emancipation mine of M. Merrick and partner near Hope. A recent shipment of 3 tons to the Selby smelter netted \$1594 per ton.

It is reported that the Tonopah Belmont company of Nevada is negotiating for purchase of the Queen gold mine near Salmo. Wisconsin people are the present owners. The mine is equipped with a 20-stamp mill and has been developed to a depth of 700 ft. On the lowest level the drift has been carried 20 ft. wide for more than 100 ft. in length, and the average of all the ore thus extracted was \$9.50 per ton. The mill saves 60% of the value on the plates, and produces 100

tons of high grade concentrate monthly. There is an immense accumulation of tailing which will pay well when treated by cyanidation or flotation.

There are 10,000,000 tons of reasonably assured and probable ore carrying 1.73% copper and about 20¢ in gold and silver, in the Copper Mountain holdings of the British Columbia Copper Co., a subsidiary of the Canada Copper Corporation, according to Oscar Lachmund, general manager, who was recently at Spokane. The ore is all of a milling character, and the company plans to treat it all by flotation. The property is to be equipped with a 2000-ton daily capacity reduction plant. Meanwhile the company is prosecuting development of the upper orebodies that can be mined by the glory-hole system. Diamond drilling is finished for the present, and the orebodies so disclosed are being proved by regular development. In doing this a 2000-foot tunnel is being driven, opening a set of levels with raises, installing surface equipment, and building a power transmission line 12 miles long from Princeton to the mine. About 125 men are employed. At Greenwood only one furnace was in blast until April 2, when the second and smaller one was blown in. The company is now treating 1400 tons of ore daily, of which about 100 tons is custom ore. It has been getting a good deal of ore from mines in the United States and could handle more, provided it is not too silicious. Coke shortage is causing some trouble.

KOREA

The Seoul Mining Co., operating the Suan concession in Whang Hai province, Chosen, reports the following results for April:

| | |
|-------------------|-----------|
| Ore treated, tons | 16,432 |
| Mill worked, days | 27 7/8 |
| Recovered Bullion | \$65,000 |
| Concentrates | \$7,310 |
| Total | \$152,310 |
| Expenses | \$57,500 |
| Operating profit | \$94,810 |

Copper is figured at 15¢ per lb.

Results are a little better, owing to improved extraction at the new mill. If copper were calculated at market prices the production returns would be materially increased, since the copper equals well toward 50% of total value recovered.

The April element of the Oriental Consolidated was worth \$143,700.

The price of the Kamsan Mining Concession in Korea was 2,000,000 yen, equivalent to \$1,500,000. The ore developed amounts to 168,000 tons of 10.5% copper ore. The Japanese appear to have made a good bargain.

MEXICO

Oil shipments from Tampico during April were 1,262,987 bbl., against 749,641 bbl. in 1915. Ocean tankage is scarce.

JALISCO

(Special Correspondence)—A decree dated May 11 prohibits the exportation of Mexican money or its removal from the country. The new "infalsifiable" money has commenced to circulate, and is declared officially to have a value of 20¢ Mexican gold, per peso. In Mexico City it appears to be worth about four times as much as the older paper money still in circulation; in Guadalajara about twice as much. There was a recent edict giving the value of the new infalsifiable at 20¢ Mexican gold, stating that the older paper money should have a relative value to the new, as fixed by the respective State secretaries. Very noticeable about the new money is the absence of "promise to pay" of any sort, printed on them. They are well made, however, and difficult to counterfeit, being made by the American Bank Note Company.

Guadalajara, May 15.

PERSONAL

Note: The Editor invites members of the profession to send particulars of their work and appointments. This information is interesting to our readers.

LEONARD WEATHERS is in Russia.

H. F. MARITON is at Johannesburg.

COURTNEY DE KAHN is at Los Angeles.

W. S. REVELL was at Oroville this week.

ERNEST WILLIAMS is here from British Columbia.

A. H. WIDDY is working with the Red Cross in Europe.

FREDERICK P. BURRILL, of New York, is going to the Yukon. H. E. COLLIER is on a visit with JOHN B. FARISH at San Mateo.

A. L. CLARK is now in the employ of the Anaconda company at Butte.

H. VINCENT WALLACE, recently at New York, is now at Helena, Montana.

A. F. KELDS is returning to London from Burma by way of the United States.

C. C. BURGER was here this week on his way back to New York from Arizona.

ORVILLE R. WHITAKER, of Denver, passed through San Francisco on his way to Arizona.

CHESTER W. PERINGTON has been re-engaged as consulting engineer to the Lena Goldfields.

E. W. MILLS and J. F. MANNING have reached San Francisco from Korea, on their way to Boston.

F. G. CLAPP of the Associated Geological Engineers is conducting geological explorations in southern Oklahoma.

W. L. BROWN, D. E. HOFFMANN, W. N. S. VAN DIVERTER, and N. WAGGONER have returned from the Belgian Congo and are now in London.

E. E. WHITE, geologist of the Cleveland-Cliffs Iron Co. during the past seven years, will go to India to take a similar position with the Tata Iron & Steel Company.

E. M. RAMB, formerly superintendent of the Gold Road and Tennessee mines, both in Arizona, has resigned to accept the management of the Tom Reed mine, at Oatman.

JAMES A. LANSON has succeeded WEBSTER P. CARY as superintendent at the Atlas Mining & Milling Co., Ouray, Colorado. Mr. Cary resigned to take a position with James M. Callow, Salt Lake City.

FRED B. CLOSE, who has been in charge of the exploration and development at the White Pine Extension, Michigan, has resigned, and is succeeded by WILLIAM R. BOLLBY, who has been engineer at the property for the past year.

LEONARD R. DICKERSON of Chicago was found dead at Kenosha, Wisconsin, on May 16. It is believed that he fell from a train. He was vice-president of the Chicago club of Michigan College of Mines men.

The Colorado School of Mines at Golden announces the following appointments, to take effect September 1: GEORGE J. YOUNG, now professor of mining engineering, University of Minnesota, to the professorship of metallurgy; CLYDE C. VAN NEYS, now professor of physics, South Dakota School of Mines, to the professorship of physics; CARROLL C. DOLMAN, now principal of the High School at Monte Vista, Colorado, to the assistant professorship of English and foreign languages; FRED G. CURTIS, University of Wisconsin, to be athletic director.

On June 1 the technical societies of Los Angeles, including the local sections of the national engineering organizations, met to discuss preparedness, also the formation of an engineer corps of California.

THE METAL MARKET

METAL PRICES

San Francisco, June 6.

| | |
|--|-----------|
| Antimony, cents per pound | 37.50 |
| Electrolytic copper, cents per pound | 31 |
| Pig lead, cents per pound | 7.25-8.25 |
| Platinum: soft metal, per ounce | \$80 |
| Platinum: hard metal, 10% iridium, per ounce | \$84 |
| Quicksilver: per flask of 75 lb. | \$72.50 |
| Spelter, cents per pound | 21 |
| Tin, cents per pound | 46 |
| Zinc-dust, cents per pound | 30 |

ORE PRICES

San Francisco, June 6.

| | |
|---|-------------|
| Antimony: 50% product per unit (1% or 20 lb.) | \$1.75 |
| Chrome: 40% and over, f.o.b. cars California, per ton | 11.00-15.00 |
| Manganese: 50% metal, per ton | 12.00 |
| Magnesite: crude, per ton | 7.00-10.00 |
| Magnesite: calcined, per ton | 25.00-30.00 |
| Tungsten: 60% WO ₃ per unit | 30.00-40.00 |

At Boulder, Colorado, \$40 is offered for 60% tungsten ore.

The U. S. Geological Survey's bulletin on fuller's earth has been issued. The average price in 1915 was \$10.21 per ton.

Asbestos bulletin of the U. S. Geological Survey has been issued. The output in 1915 was 1731 tons, worth \$76,952, an increase of 39%.

New York, May 31.

Molybdenum: There is a market, though a narrow one, for concentrate containing 50% and better of metal. For the low-grade, 60c. per pound is quoted; for the high-grade up to \$1.15. There are but few users of molybdenum in this country, but the Germans are using it extensively in the manufacture of high-speed steel. The practice most approved is to use a small amount of molybdenum in conjunction with tungsten.

EASTERN METAL MARKET

(By wire from New York.)

June 6.—Copper is quiet, with re-sale metal irregular; lead quotations for this week are those of the A. S. & R. Co.; spelter is active and prices stronger.

SILVER

Below are given the average New York quotations, in cents per ounce, of fine silver.

| Date | Average week ending |
|------------|---------------------|
| June 1 | 68.75 |
| " 2 | 64.87 |
| " 3 | 64.75 |
| " 4 Sunday | |
| " 5 | 66.50 |
| " 6 | 66.87 |

Monthly averages.

| | 1914. | 1915. | 1916. | | 1914. | 1915. | 1916. |
|------|-------|-------|-------|-------|-------|-------|-------|
| Jan. | 57.58 | 48.85 | 56.76 | July | 54.90 | 47.52 | |
| Feb. | 57.53 | 48.45 | 56.74 | Aug. | 54.35 | 47.11 | |
| Mch. | 58.01 | 50.61 | 57.89 | Sept. | 53.75 | 48.77 | |
| Apr. | 58.52 | 50.25 | 64.37 | Oct. | 51.12 | 49.40 | |
| May | 58.21 | 49.87 | 74.27 | Nov. | 49.12 | 51.88 | |
| June | 56.43 | 49.03 | | Dec. | 49.27 | 55.34 | |

COPPER

Prices of electrolytic in New York, in cents per pound.

| Date | Average week ending |
|------------|---------------------|
| June 1 | 28.00 |
| " 2 | 28.00 |
| " 3 | 28.00 |
| " 4 Sunday | |
| " 5 | 28.00 |
| " 6 | 28.00 |

Monthly averages.

| | 1914. | 1915. | 1916. | | 1914. | 1915. | 1916. |
|------|-------|-------|-------|-------|-------|-------|-------|
| Jan. | 14.21 | 13.60 | 24.30 | July | 13.26 | 19.09 | |
| Feb. | 14.46 | 14.38 | 26.62 | Aug. | 12.34 | 17.27 | |
| Mch. | 14.11 | 14.80 | 26.65 | Sept. | 12.02 | 17.69 | |
| Apr. | 14.19 | 16.64 | 28.02 | Oct. | 11.10 | 17.90 | |
| May | 13.97 | 18.71 | 29.02 | Nov. | 11.75 | 18.88 | |
| June | 13.60 | 19.75 | | Dec. | 12.75 | 20.67 | |

April returns include the following: Anaconda, 30,000,000; Chino, 4,496,270; Inspiration, 10,122,686; Nevada Con., 7,771,681; Ray Con., 6,294,033; and Utah Copper, 11,557,282 pounds.

Kennecott has produced 10,000,000 lb. of copper from its Alaska property in 4 months.

A dividend of \$10 per share is expected in July from the Mohawk company of Michigan, on account of profits during the past financial year.

Calumet & Hecla pays \$15 per share on June 21. Calumet & Arizona has declared \$2 per share for the quarter. An increased dividend is expected from Granby Consolidated, whose April output was 3,950,469 pounds.

LEAD

Lead is quoted in cents per pound, New York delivery.

| Date | Average week ending |
|------------|---------------------|
| June 1 | 7.00 |
| " 2 | 7.25 |
| " 3 | 7.25 |
| " 4 Sunday | |
| " 5 | 7.25 |
| " 6 | 7.00 |

Monthly averages.

| | 1914. | 1915. | 1916. | | 1914. | 1915. | 1916. |
|------|-------|-------|-------|-------|-------|-------|-------|
| Jan. | 4.11 | 3.73 | 5.95 | July | 3.80 | 5.59 | |
| Feb. | 4.02 | 3.83 | 6.23 | Aug. | 3.86 | 4.67 | |
| Mch. | 3.94 | 4.04 | 7.26 | Sept. | 3.82 | 4.62 | |
| Apr. | 3.86 | 4.21 | 7.70 | Oct. | 3.60 | 4.62 | |
| May | 3.90 | 4.24 | 7.38 | Nov. | 3.68 | 5.15 | |
| June | 3.90 | 5.75 | | Dec. | 3.80 | 5.34 | |

QUICKSILVER

The primary market for quicksilver is San Francisco, California being the largest producer. The price is fixed in the open market, according to quantity. Prices, in dollars per flask of 75 pounds:

Week ending

| Date | Week ending |
|-------|-------------|
| May 9 | 100 |
| " 16 | 90 |

Monthly averages.

| | 1914. | 1915. | 1916. | | 1914. | 1915. | 1916. |
|------|-------|-------|--------|-------|-------|--------|-------|
| Jan. | 39.25 | 51.90 | 222.00 | July | 37.50 | 95.00 | |
| Feb. | 39.00 | 60.00 | 295.00 | Aug. | 80.00 | 93.75 | |
| Mch. | 39.00 | 78.00 | 219.00 | Sept. | 76.25 | 91.00 | |
| Apr. | 38.90 | 77.50 | 141.60 | Oct. | 53.00 | 92.90 | |
| May | 39.00 | 75.00 | 90.00 | Nov. | 55.00 | 101.50 | |
| June | 38.60 | 90.00 | | Dec. | 53.10 | 123.00 | |

ZINC

Zinc is quoted as spelter, standard Western brands, New York delivery, in cents per pound.

| Date | Average week ending |
|------------|---------------------|
| June 1 | 13.50 |
| " 2 | 13.25 |
| " 3 | 13.00 |
| " 4 Sunday | |
| " 5 | 13.00 |
| " 6 | 13.25 |

Monthly averages.

| | 1914. | 1915. | 1916. | | 1914. | 1915. | 1916. |
|------|-------|-------|-------|-------|-------|-------|-------|
| Jan. | 5.14 | 6.30 | 18.21 | July | 4.75 | 20.54 | |
| Feb. | 5.22 | 9.05 | 19.99 | Aug. | 4.75 | 14.17 | |
| Mch. | 5.12 | 8.40 | 18.40 | Sept. | 5.16 | 14.11 | |
| Apr. | 4.98 | 9.78 | 18.62 | Oct. | 4.75 | 14.05 | |
| May | 4.91 | 17.03 | 16.01 | Nov. | 5.01 | 17.29 | |
| June | 4.84 | 22.20 | | Dec. | 5.40 | 16.75 | |

Zinc ore at Joplin during May declined from \$115 to \$95 per ton for 60% product, lower grades at \$70.

TIN

Prices in New York, in cents per pound.

| | 1914. | 1915. | 1916. | | 1914. | 1915. | 1916. |
|------|-------|-------|-------|-------|-------|-------|-------|
| Jan. | 37.85 | 34.40 | 41.76 | July | 31.60 | 37.38 | |
| Feb. | 39.76 | 37.23 | 42.60 | Aug. | 50.20 | 34.37 | |
| Mch. | 38.10 | 48.76 | 50.50 | Sept. | 33.10 | 33.12 | |
| Apr. | 36.10 | 48.25 | 51.15 | Oct. | 30.40 | 33.00 | |
| May | 33.29 | 39.93 | 49.10 | Nov. | 32.51 | 39.50 | |
| June | 30.72 | 40.26 | | Dec. | 33.60 | 38.71 | |

Tin is steady at 43 cents.

Income of the International Nickel Co. in 1915-16 was \$13,470,106 net, against \$6,712,387 in 1914-15 (the year ends March 31). Preference dividends amounted to \$534,756, the same as before; while common received \$9,131,893, compared with \$4,753,928. The surplus is \$1,781,720, against \$909,377.

Eastern Metal Market

New York, May 31

Copper, zinc, lead, tin and antimony are inactive and quotations for them are lower.

All that is supporting the copper market is the sold-up condition of the producers. In the course of a few days the London market for electrolytic has declined £14. After today, by Government order, standard copper will not be dealt in on the London Metal Exchange. This restriction applies to tin also.

Zinc has declined steadily, and is soft, but the sellers are confident that a turn upward is near.

A reduction in the price of lead is looked for and, if it comes, it may revive domestic demand.

Tin has declined in both New York and London.

Antimony is down to 25c. per pound.

Aluminum is quiet and unchanged at 58 to 60 cents.

Manufacturing plants of all sorts are running at capacity, and have orders enough in hand to keep them busy for the remainder of this year, and numbers into 1917; but there is no denying that new orders are lighter. Business is restricted by the high prices, many building enterprises, for instance, having been postponed because of the cost of steel, brick, concrete reinforcing bars, lumber, etc. At lower prices there is much such business in prospect for the future. Ocean freight-rates are easier; this will mean a large export trade when commodity prices are lower and the domestic demand appeased. Strike troubles are less conspicuous, although demands continue to be made for the 8-hour day.

COPPER

The market is dull and re-sale lots are lower, but consumers do not appear to want more copper than they have under contract. Two or three facts stand out strong in the situation, and one of these is that despite some recession the market remains fairly firm, which it would not do were the producers not so well sold-up for the next few months. Another phase of the situation is that for some time consumers have been buying only to cover contracts actually booked, and the fact that they have not been buying lately is an indication that they are receiving less new business. Producers have been holding to their quotations and not offering concessions. Second-hands, however, have sought business at cut prices, but so far unsuccessfully. Large quantities have been offered, as stated a week ago, down to 28c., third quarter delivery, and bids under this figure have been solicited. Prompt electrolytic can be had at 28.25 to 28.50c. These prices indicate the extent to which the quotations for prompt and future deliveries have drawn together in the past month. The London market is peculiar, inasmuch as the electrolytic quotation there today is £144, against £158, May 24, a decline of £14. One explanation of this drop in price is that American electrolytic has been more freely offered in the London market, but the real explanation may be elsewhere. It may be that the London market is re-adjusting itself to the condition that will prevail after today. It will be remembered that in March the British Minister of Munitions took steps to stop speculation in the metals on the ground that such operations were causing the Government to pay too much for copper, tin, etc. At that time a committee of the London Metal Exchange appealed for leniency, and the Minister agreed that operators might have until June 1 to terminate speculative contracts. This means that after today (May 31) standard copper and tin will not be dealt in on the London Metal Exchange; that business will be in electrolytic copper and Straits tin. Just what effect the enforcement of the rule will have is yet to be determined. Exports from May 1 to 29 totaled 14,662 tons.

ZINC

This metal has steadily pursued a downward trend both here and abroad. Prompt can be had today at about 13.75c., New York, and 13.50c., St. Louis, and perhaps these nominal prices might be shaded, but no one seems to want the metal. June is quoted at about 13c., St. Louis, July at 12.50c., and third quarter at 12c. As with copper, the mills have their contracts well covered, and the dearth of new business is not only sending prime Western down, but causing the premium for brass-mill special to disappear. Exports for 29 days totaled 3746 tons. The London market, between the 26th and 29th declined £10, from £90 to £80. A seller states:

"Once the market starts up, a higher range of values will likely prevail for some time. Present low prices have been brought about by an entire absence of buying both here and abroad. The consumption is, of course, as large as ever and we expect a better demand in the near future. More interest is already manifested. The situation remains sound, and prices will advance with the first sign of renewed activity."

The base price of sheet zinc declined 2c. on the 29th, and is now 22.50c., carload lots, f.o.b. mill.

LEAD

The A. S. & R. Co., for the purpose of obtaining a basis for its average price, continues to quote 7.50c., New York, and 7.42½c., St. Louis, but the independent producers and sellers are eager to sell below these levels. They quote freely at 7.35c., New York, and would not refuse 7.25c., New York. It is reported that 7.10c. and 7.15c., St. Louis, has been done. The feeling of the trade is that prices will be reduced in the near future. Domestic consumers are no more anxious to buy lead than they are to take the other metals, and sellers have concentrated their attention on some inquiries from Japan and South America which have been before the trade. It is considered, however, that the business did not come to this country. The London quotation on the 29th was £31 10s. Exports to the 29th totaled 1025 tons.

TIN

Only dullness is to be reported. At times the offering of price concessions has aroused consumers from their apathy, and there have been moderate-sized sales, but the buyers usually were sorry afterward, in view of the fact that prices continued to recede. The quotation on the 29th was 46.75c., for spot metal. The London market in the first three days of this week declined £5 19s., probably as a result of the termination of speculative contracts with the end of this month, and the refusal of the British government to permit a continuance of such business. Arrivals of the month up to the 29th totaled 3812 tons, and there was afloat on that day 3502 tons.

ANTIMONY

Quotations show considerable variance, but there is no doubt about the acceptance of 25 to 26c. for round-sized lots of Chinese or Japanese, or domestic brands of antimony. The market is absolutely neglected. No trading whatever in needle antimony is reported.

ORES

Antimony: Considerable inquiry is before the trade, but no sales are reported, and the nominal price is \$2.50 per unit.

Tungsten: The market is perhaps a little steadier, but otherwise unchanged. Some re-sale lots have made their appearance, and the course of prices cannot be certain until they are absorbed. No ore has come from South America for several weeks. The nominal price is \$40 per unit.

COMPANY REPORTS

RAND MINES, LIMITED

This company holds shares in over 20 operating companies on the Rand, including the City Deep, Crown Mines, East Rand Proprietary, Ferreira Deep, Geldenhuis Deep, Modder B, Nourse, Robinson, Rose Deep, Village Deep, and Victoria Falls & Transvaal Power Co., all totaling an investment of £4,091,345. Dividends received on shareholding amounted to £868,539, while other revenue made a total of £927,213. The profit was £886,356, a decrease of £279,895, due to less dividends received. Dividends paid by the Rand Mines (2 of 160%) amounted to £850,398. The balance for the current year is £320,289, against £339,103 carried forward to 1915.

Ore reserves in the mines in which this company is interested total 47,773,430 tons.

NORTH BUTTE MINING CO.

The past three years of this company compare as follows:

| Operations | 1915 | 1914 | 1913 |
|----------------------------------|--------------|-------------|-------------|
| Development, feet | 15,333 | 11,551 | 19,449 |
| Ore extracted, tons | 378,105 | 337,415 | 454,984 |
| Copper produced, pounds | 19,235,285 | 18,421,761 | 28,318,321 |
| Gold produced, ounces | 1,122 | 1,108 | 1,567 |
| Silver produced, ounces | 940,632 | 1,092,300 | 1,422,177 |
| Price received for copper, cents | 16.70 | 13.74 | 15.09 |
| Cost, cents | 13.12 | 14.54 | 13.06 |
| Revenue from metals | \$ 4,155,522 | \$3,084,774 | \$5,182,674 |
| Profit | 1,127,646 | 358,215 | 1,437,777 |
| Dividends | 387,000 | 635,000 | 820,000 |
| Surplus | \$ 740,646 | *\$276,785 | \$617,777 |

*Deficit.

All new equipment at the Granite Mountain shaft was completed in 1915. This has an electric hoist, while the Speculator has a steam plant. Development generally was satisfactory, and much new ore disclosed.

BROKEN HILL SOUTH SILVER MINING CO.

The report of this Australian company is for the half-year ended December 31, 1915, and the manager's (W. E. Wainwright) notes include the following:

Development to a depth of 1370 ft. totaled 6913 ft. Completed stopes were filled with 43,730 cu. yd. of residue and ash. Of the ore stoped, 95.3% was by contract, the miners averaging \$3.84, and the trammers \$3.24 per 8-hr. shift. Results were satisfactory, and reserves remain at 3,350,000 tons. The cost of ore extraction was \$3.20 per ton.

The concentrating plant treated 164,210 tons of ore assaying 14.6% lead, 7.5 oz. silver, and 14.8% zinc, yielding 30,658 tons of concentrate containing 60% lead, 23.6 oz. silver, and 9.9% zinc. The recovery by water concentration was 76.6%, 58.9%, and 12.5% respectively, at a cost of 96c. per ton. The zinc-bearing tailing, amounting to 101,044 tons, assaying 17.3% zinc, 3.1% lead, and 3.4 oz. silver, was sent to the Amalgamated Zinc (De Bavay's) flotation plant. The recovery from this was 71.8%, 12.9%, and 27.9% respectively. The total recovery was 89.5% lead, 86.8% silver, and 91.3% zinc. A flotation plant is ready to treat the slime, which contains 9.9% lead, 6.1 oz. silver, and 14.4% zinc. All costs were \$5 per ton.

An average of 1287 men was employed. A voluntary increase of 24c. per shift was paid the men, pending arbitration. The rainfall was 5.49 in. The company has lent three lathes for making gun shells for the Australian army.

The revenue was \$1,730,000, and profit \$913,000. Two dividends absorbed \$432,000. The balance for 1916 is \$1,872,000, an increase of \$320,000.

CALUMET & HECLA MINING CO.

The 82-page report of this Michigan company for 1915 includes results of its own operations, and those of the companies which it controls or has a large interest. These include the Ahmeek, Allouez, Centennial, Cliff, Gratiot, Isle Royale, La Salle, Laurium, Osceola, Seneca, Superior, Tamarack, White Pine, and Calumet Transportation companies. Some of their reports have already appeared in this journal; others will in subsequent issues. During the past year the C. & H. received a total of \$866,776 from the Ahmeek, Allouez, and Osceola, compared with \$245,322 in 1914. The following results are for the past year:

| | Copper per ton of ore lb. | Cost of copper per per lb. cents | Earnings per share | Dividends per share |
|-----------------|---------------------------------|--|--------------------------|---------------------------|
| Ahmeek | 23.00 | 7.96 | \$11.34 | \$8.25 |
| Allouez | 18.78 | 9.31 | 9.25 | 2.00 |
| Calumet & Hecla | 22.28 | 9.33 | 65.54 | 50.00 |
| Centennial | 15.63 | 12.45 | 1.58 | |
| Isle Royale | 13.70 | *14.94 | 3.32 | |
| La Salle | 9.67 | 21.23 | | |
| Osceola | 14.50 | 10.03 | 16.75 | 11.00 |
| Superior | 18.23 | 12.29 | 2.45 | |
| Tamarack | 17.90 | 17.07 | 1.32 | |
| White Pine | 24.76 | †14.44 | | |

*Includes 1.88c. per lb. for extraordinary construction.

†Includes 5.64c. per lb. for construction.

On the Conglomerate lode of the C. & H. there are 10 operating shafts, from 6102 to 8132 ft. deep on the incline. The South Hecla No. 9 and 10 are 142 ft. under No. 82 level. Driving on this lode amounted to 5522 ft. In extracting 1,739,984 tons of ore, containing 29.74 lb. of copper per ton, the cost was \$2.13 per ton. There were 51 drills removing shaft pillars, and cleaning-up arches and backs of old stopes, producing 379,201 tons. Shafts on the Osceola lode are from 1460 to 3274 ft. deep. Development covered 10,206 ft. At a cost of \$1.07 per ton, 1,448,599 tons of ore, averaging 13.32 lb. per ton, was mined.

There were no notable changes at the mill. At present 17 stamps are crushing conglomerate and 11 amygdaloid ore. The two re-grinding plants reduced 505,704 tons of tailing, averaging 13.14 lb. copper per ton. The saving was 4.25 lb. at a cost of 5.72c. per lb., excluding smelting and selling. The reclamation plant, working on the Calumet sand bank, consists of a dredge, classifying house, and re-grinding plant. The dredge has a 20-in. suction, and is of 10,000-ton daily capacity, from a depth of 100 ft. Forty-eight Hardinge mills reduce the tailing, with 16 to be added. The reclamation plant treated 181,732 tons of 21.8-lb. tailing, saving 8.71 lb. at a cost of 4.02c. Work continues at the leaching plant, which may be in part operation early this summer. It will be of 2000 tons' capacity. At the Hubbell smelter the new furnace is about ready for work.

Results in 1915 were as follows, compared with the previous two years, the figures being for C. & H. proper.

| | 1915 | 1914 | 1913 |
|---------------------------------------|---------------|-------------|-------------|
| Ore treated, tons | 3,188,583 | 2,592,462 | 2,035,625 |
| Refined copper produced, pounds | 72,613,320 | 53,691,562 | 15,016,890 |
| Refined copper per ton of ore, pounds | 22.28 | 20.70 | 22.11 |
| Cost, cents per pound | 9.33 | 11.35 | 14.25 |
| Price received, cents per pound | 18.11 | 14.01 | 15.77 |
| Dividends paid, per share | \$50 | \$10 | \$32 |
| Dividends paid, for year | \$5,000,000 | \$1,000,000 | \$3,200,000 |
| Total to date | \$129,250,000 | | |

The Tamarack mine has been purchased; a large majority of the stockholders sold their shares to Calumet & Hecla for \$59 per share.

INDUSTRIAL NOTES

A New Turbo-Blower

A low pressure turboblower to deliver from 3,000 to 35,000 cu. ft. of air per minute at from 1 to 24 lb. has been devised by the Ingersoll-Rand Company.

These machines are particularly adapted to such service as foundry-cupola blowing, atomizing oil for oil-burners, supplying blast to heating and annealing-furnaces of various kinds, blowing air for water-gas generators, pneumatic conveying,

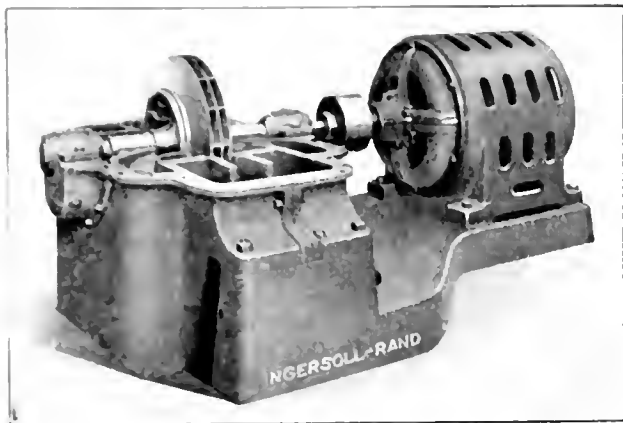

NEW TYPE OF TURBO-BLOWER.

and ventilating. They are of the single-stage, double-flow type, and are supplied either electric motor, steam turbine, or water-wheel driven. Electric drive is generally employed for the classes of service above mentioned, and in the case of the I-R turbo-blower, the high operative speed permits direct coupling to motor, a first cost economy. The motor-driven I-R machine maintains constant pressure, while delivering any volume from zero to maximum demand, and proportionately varying the electrical horse-power input.

These blowers embody the four-bearing construction featured in all turbo machines of this make. The casing is horizontally split for ease in installation and subsequent inspection. The impeller is of the enclosed double-flow type, claimed by the manufacturer to secure the highest efficiency. The wheel is machined from a solid, special steel forging. Every care is taken to reduce skin-friction. Impellers are keyed to a heat-treated forged-steel shaft. Labyrinth packing is employed to prevent leakage between impeller and casing. Bearings are ring-oiled, and both bearings and their housings are horizontally split. The use of flexible couplings between blower and driving unit is standard practice on all I-R turbo-blowers. Machines are all of the closed intake type. The intake opening is at the bottom, and discharge at the top. It is to be noted that the only lubrication necessary is that of the bearings, all other parts working without friction.

The 'Meeseco' gas-engine clutch (Bried patents, issued and pending) a new friction-clutch for gas-engine or short-shaft work, is described in Bulletin No. 5-15-16 of the MEASE & GOTTFRIED Co. of San Francisco. For its size great power is claimed. It is made in two styles: one in which it is bolted to an engine fly-wheel when there is no projecting shaft, and that where it is attached to a projecting shaft.

The OLIVER CONTINUOUS FILTER Co., San Francisco, has received an order, by cable, for two filter units, each of 150-tons capacity, to be shipped to the Furukawa Mining Co., Tokyo, Japan.

RECENT PUBLICATIONS

U. S. Bureau of Mines, Washington, D. C., 1916:

INSTRUMENTS FOR RECORDING CARBON DIOXIDE IN FUEL-GASES. By J. F. Barkley and S. H. Flagg. Bulletin 91. P. 61. Ill., chart, index.

THE INFLAMMABILITY OF ILLINOIS COAL DUSTS. By J. K. Clement and L. A. Scholl, Jr. Bulletin 102. P. 71. Ill., index.

SOME PROPERTIES OF THE WATER IN COAL. By Horace C. Porter and O. C. Ralston. Technical paper 113. P. 30. Illustrated.

THE CASTING OF CLAY WARES. By Talne G. McDougal. Technical paper 126. P. 26. Illustrated.

EXPLOSIONS OF GASES FROM MINE FIRES. By George A. Burrell and George G. Oberfell. Technical paper 134. P. 31. Illustrated.

COAL-MINE FATALITIES IN THE UNITED STATES IN 1915. Compiled by Albert H. Fay. Also list of permissible explosives, lamps, and motors tested prior to January 1, 1916. P. 80. Illustrated.

U. S. Geological Survey, Washington, D. C., 1916:

CHROMIUM-IRON ORE IN 1915. By J. S. Diller. P. 6.

SAND-LIME BRICK IN 1915. By Jefferson Middleton. P. 2.

A RECONNAISSANCE IN PAID PINTO COUNTY, TEXAS. With special reference to oil and gas. By Carroll H. Wegemann. Bulletin 621-E. P. 9. Illustrated.

This is a corrected issue of the same bulletin.

ANALYSES OF COAL SAMPLES FROM VARIOUS PARTS OF THE UNITED STATES. By Marius R. Campbell and Frank R. Clark. Bulletin 621-P. P. 127. Index.

WATER POWER OF THE CASCADE RANGE. By Glenn L. Parker and Frank B. Storey. Water-supply paper 369. P. 169. Ill., maps, index.

NORTH PACIFIC DRAINAGE BASINS. Water-supply paper 332. P. 748. Ill., index.

ORIGIN AND DISTRIBUTION OF ORE IN THE COEUR D'ALENE. By Oscar H. Hershey. P. 32. Illustrated. For sale by the MINING AND SCIENTIFIC PRESS. Price, 25 cents.

Submitting theories and discussing other papers on the same subject, which should be of interest to Idaho mining men.

FOREST PROTECTION IN CANADA. Compiled under direction of Clyde Leavitt. P. 317. Ill., maps, index. Commission of Conservation, Ottawa, Canada, 1915.

An interesting volume on an important subject.

PETROLEUM IN ILLINOIS IN 1914 AND 1915. By Fred H. Kay. Also GEOLOGIC STRUCTURES OF CANTON AND AVON QUADRANGLES. By T. E. Savage. Extract from Bulletin 23. P. 36. Illustrated, map.

MESOZOIC AND CENOZOIC MACTRINAE OF THE PACIFIC COAST OF NORTH AMERICA. By Earl L. Packard. P. 100. Table, 35 plates. University of California, Berkeley, May 1, 1916.

THE COMPRESSIBILITY OF NATURAL GAS AT HIGH PRESSURES. By G. A. Burrell and J. W. Robertson. Technical paper 131, petroleum technology 31. P. 10. Illustrated.

THIRTEENTH ANNUAL REPORT of the director (Alvin J. Cox) of the Bureau of Science, Philippine Islands. P. 85. Ill., index. Manila, 1915.

DESCRIPTION OF THE LABORATORIES OF THE MINES BRANCH OF THE DEPARTMENT OF MINES, OTTAWA, CANADA. Bulletin No. 13. P. 51. Ill., plans.

THE LURE OF CRIPPLE CREEK GOLD. By Wm. Y. Seaman. P. 48. Price, 15 cents. 1842 Stout street, Denver, Colorado.



EDITORIAL



T. A. RICKARD, Editor

AMONG war supplies a great increase of export is noteworthy in brass, of which \$27,725,470 was exported in March this year, as against only \$2,749,835 worth in the corresponding month of 1915—a tenfold increase. Copper exports have risen from \$9,995,487 worth in March 1915 to \$18,409,615 in March this year—a doubling of foreign business. The larger part of this trade in copper was with France.

FOUR of the greatest zinc-producers in the country are the New Jersey Zinc, Butte & Superior, Consolidated Interstate-Callahan, and American Zinc companies. It is a curious fact that the first named has its chief mines within 50 miles of New York city, the second is situated in a district famous for copper, the third in a region known principally for its lead-silver mines, while the fourth obtains its ores from eastern Tennessee, which is best known as a mining region through the productive activities of the Tennessee and Ducktown copper companies.

DEFICIENT postage on a letter is not conducive to business. An engineer writes to us from Salvador to remark that many people in the United States seem unaware that the postage to Salvador from this country is 5, not 2, cents. If less than the requisite stamp is put on the letter, then the party to whom it is addressed has to pay a fine of 30 centavos, which, at the current rate of exchange, is equivalent to 11 cents U. S. If the letter is from a friend the impost is paid without demur, but if it proves to be a circular the fine irritates. Such an oversight on the part of business houses is likely to cause loss of trade, for a merchant is not in the best frame of mind to prepare a repeat order after he has had to go to his petty cash. These remarks apply to correspondence with persons in other foreign countries, of course. Every office should consult the Postal Guide and avoid unnecessary blunders.

IT is a coincidence that the Nevada Consolidated and Calumet & Hecla companies mined nearly the same tonnage of ore last year. Each treated slightly over 3,000,000 tons, the recovery by the Nevadan company being 21.6 lb. of copper per ton, that of the Michigan company 22.28 lb. per ton. One extracts its ore, native copper disseminated in conglomerate and amygdaloid, by means of underground mining through shafts; the other mines chalcocite disseminated in monzonite porphyry, using steam-shovels in open pits. Calumet & Hecla paid \$5,000,000 in dividends, while Nevada Consolidated paid \$2,999,158, the former having 100,000 shares outstanding, the latter 2,000,000. Incidentally,

the Chino mine in New Mexico produced more copper last year than Nevada Consolidated, 68,293,893 lb. as against 62,726,651 lb., from a smaller tonnage of ore, 2,379,800 against 3,081,520 tons. This was possible because of Chino's 2.15% average against Nevada Consolidated's 1.54% of copper.

RECOGNITION of the fact that industrial conditions are abnormal prevents heavy commitments for the future. Such over-buying as is evident has been prompted by rising prices and the fear of a shortage of the necessary supplies. Nobody cares to be left with heavy stocks when Peace brings a re-adjustment of conditions. Construction work is being delayed by the high cost of metals, but postponement cannot continue indefinitely, particularly in railroad improvement. The revenues and tax-receipts of the Government exhibit an enormous increase, reflecting the growing wealth of the country.

WHEN publishing the diagram illustrating the sequence of metallurgical operations at the International smelter, at Miami, in our issue of June 3, we should have explained that the ore contains no more sulphur than is needed; therefore the drying is conducted at a temperature at which volatilization is at a minimum. This accounts for the rather low tonnage treated by the reverberatory furnaces, since the charge, compared with that at other plants, is rather cool and lacks the advantage of such incipient fusion in the roasters as increases the rate at which the calcine will smelt. The reverberatories are charged, exclusively, at the side-walls. About 82% of the concentrate is the product from flotation. The recovery of copper for the last four months has averaged 97.3% and the manager of the smelter, Mr. L. R. Wallace, expects to attain 98%. In March the production of bullion was 8111 tons.

HIGH-GRADE copper ore is not so common in the West as formerly. Aside from the Jerome district in Arizona and the remarkable 60% ore of the Kennecott mine in Alaska, the Calumet & Arizona and the Old Dominion furnish the best examples of the mining of high-grade copper ore. The Calumet & Arizona company, it is scarcely necessary to recall, operates mines at Bisbee adjoining the Copper Queen property of Phelps, Dodge & Co. The ore mined by the Calumet & Arizona during last year averaged 98 lb. of copper per ton, or nearly 5%. From 664,152 tons of ore mined, the production was 63,126,931 lb. of copper, an output equal to that of the Chino, Ray, or Nevada Consolidated. By way of comparison, the Isle Royale Copper Company, in Michigan,

one of the lowest grade producers in the country, mined a greater tonnage of ore than the Calumet & Arizona, but produced only 9,312,106 lb. of copper, because the content of the ore was but 1.17 lb. per ton, or 0.68%. The Old Dominion company, which operates very wet mines at Globe, also mined ore of an average grade of nearly 5% copper during last year. From 256,699 tons of ore mined, 25,307,702 lb. of copper was produced. This is more metal than the Quincy mine, in Michigan, produced from 1,269,000 tons of ore. We note that the report of the Copper Queen Consolidated for last year states that "the grade of ore in five of the six producing divisions is only 5.36%, but that of the sixth is 7.27%, which raises the average to about 6% copper." The Copper Queen mines produced last year 93,900,000 lb. of copper. Among recent developments the most remarkable is the orebody in the United Verde Extension, at Jerome, where a mass of ore 250 feet square averaging 17% copper has been uncovered, with the happy result that a number of technical men, among the shareholders, have been made independent.

DISCUSSION this week starts with a letter by a Nevadan metallurgist, Mr. Alfred M. Smith, on the heating of cyanide solutions, arguing that the use of heat is dangerous unless applied carefully and with an understanding of the chemical results that may ensue. Mr. F. C. Brown, the inventor of the Brown agitator, erroneously called the Pachua tank, writes on a matter quite divorced from cyanidation, namely, the advisability of working on Sundays. He quotes from a book that is not always to be found in the library of the engineer when away from home, but which no thinking man can treat save with profound respect. The tone of his remarks does honor to our columns. In these days when efficiency is being preached as if it were a recent revelation from on high, it is well to consider the question of Sunday labor as a factor in promoting the good health of employees. Every man who works is entitled to his own opinion on the subject, and not the manual laborer only. Our own experience as manager of mines goes to show that men will accomplish as much in the six days as in seven, and that uninterrupted daily labor is broken eventually by staleness or illness. This applies to the technical staff on a mine just as much as it does to the trapper or the roanabout. Of course, the economy of interruption on Sundays may be lessened where a mine is extremely wet or where otherwise the cost of maintenance or the overhead charge happens to represent an excessive proportion of the total expenditure. Now that prohibition is established in so many mining communities the danger of the Sunday 'drunk' and the Monday reaction has been lessened appreciably. That used to be a decided objection to closing-down on the Sabbath, the argument being that it hurts a man less to over-work than to over-drink, as to which there is good reason for doubt. However, we feel assured that Mr. Brown's letter will be given friendly consideration. Next we have a contribution on Chinese mining regulations by Mr. M. B. Yung, whose name

suggests the fact that he is a Chinese engineer technically educated in the United States. Therefore he writes from a point of view particularly desirable on a subject involving Chinese rights and American desires. 'Put yourself in his place' is a good motto for those of us who discuss the exploitation of mines in foreign countries. Imagine Chinese syndicates claiming the right to mine along the Mother Lode or on the Copper Range, and consider what latitude you would think it proper to give them in their operations. What is sauce for the goose is sauce for the gander. Mr. Yung's comment is eminently reasonable. The last letter in the Discussion department is one from our Mr. P. B. McDonald, who discusses the character of the literature, ephemeral or classic, as the case may be, that mining men read. He is rightly contemptuous over the daily press, for he has in mind not the newspapers of New York but those that prostitute journalism in San Francisco. The reading of these debauches the mind and dulls the wit. We agree with him that those living in remote localities are saved the temptation of reading much that is merely trivial. Young men on solitary mines or in places where company is scarce will be wise to make the most of their detachment from social activities by reading books that are worth while. If a young man does not read the masters—such as Huxley and Darwin—and the monographs—such as Emmons's 'Leadville' and Lindgren's 'Tertiary Gravels,' during the time of his apprenticeship, he is likely not to read them at all; for they demand time and quiet. We know at least one mining engineer who was marooned at a hole in the ground long enough to obtain the chance, while on salary, to read several volumes the bulkiness of which would appal a busy man. In short, use the opportunity to read and thereby lay the foundation for an enrichment of the mind that will endure.

Zinc

The price of this metal is declining in value for reasons not in the least obscure, namely, excess of production prompted by the high prices created by War conditions. At the beginning of 1915 the price was 5½ cents per pound; last June it was 27; now it is 13. Producers are sold several months ahead. For a short time concentrate containing even less than 40% zinc could be exploited at a profit, owing to the abnormal demand; the expansion of the market caused hundreds of new producers to become active, prompting the erection of additional smelters on a liberal scale, until the growth of production had more than met the unusual demand. Several new reduction works will shortly come into operation. The Allies were expected to buy large quantities of spelter for the second half of the current year, but these purchases have not come through; hence the recent collapse. Meanwhile the Australian zinc industry is being reorganized to meet conditions created by the War. The output from Broken Hill in 1913 was 525,000 tons of 45% zinc concentrate, as compared with the 337,000 tons of spelter produced in this country during the same

year. Most of the Australian concentrate used to go to Antwerp and Rotterdam, for distribution among the Belgian and German smelters. The Belgian plants were largely under German control and the German smelting companies had been aided in the expansion of business by ship-subsidies from their Government. At the outbreak of hostilities, therefore, the Australian zinc industry found itself in the grip of an enemy. All shipments ceased and there arose talk of building reduction works in England and Australia, but existing contracts with the German and Belgian smelters paralyzed action. In August, 1915, the Commonwealth government passed a bill cancelling contracts with enemy-aliens, and thereby cleared the way for the Associated Smelters, a consolidation of mining interests at Broken Hill organized to treat the lead and zinc output from that district, starting with the Broken Hill Proprietary works at Port Pirie as a nucleus. The only companies not included were the British Broken Hill Proprietary and the Zinc Corporation, both of which were registered in England and were tied by German contracts that were not released by the Australian enactment; another exception was the Sulphide Corporation, which owns the Central mine at Broken Hill, and controls both the Central zinc smelter near Newcastle, in England, and a lead smelter at Cockle Creek in New South Wales. All the efforts to organize a new and big reduction works in England were blocked by German contracts, which the British courts were slow to set aside. However, in September 1915 a beginning was made by the transfer of the small smelter at Swansea Vale in South Wales, from Aron Hirsch & Sohn of Halberstadt to a syndicate headed by Messrs. H. C. Hoover and F. A. Govett, representing a group of financiers identified with the Zinc Corporation and the Burma Mines. Finally, on May 12, 1916, the British government made an order 'determining' the contracts made in 1910 and 1912 between the British Broken Hill Proprietary Company and the Zinc Corporation on the one side and German smelters on the other. At about the same time the Sulphide Corporation made an arrangement, with the British government's sanction, to purchase the Central Zinc Company's plant in England and enlarge it to a capacity of 30,000 tons of concentrate per annum. Furthermore, it is announced by the *Financial Times* that the directors of the Zinc Corporation have definitely decided to erect a smelter of their own in England, at an expenditure of \$10,000,000, unless the Commonwealth government extends its embargo on the export of concentrate to companies of English register, as is not likely. Meanwhile the interests tributary to the Associated Smelters have organized a Zinc Producers Association, making provision for the marketing of their united output during a period of 50 years. Arrangements with the Vieille Montagne company, with a view to protecting the Belgian zinc-smelting industry, are also likely to be made, as part of the industrial alliance between England and France. All of which is here recorded to make clear the fact that the Australian zinc industry is to be placed on its feet again and there-

fore in a position to contribute, say, 250,000 tons of spelter per annum.

The mention of the Burma Mines is significant, for that company has uncovered an orebody at Bawdwin, in the Northern Shan States, that promises to be a factor in the zinc market. Already 2,000,000 tons of ore averaging 22½% zinc, besides 27% lead, and 25 oz. silver per ton is said to be assured, with excellent prospects of a big increase of tonnage as development proceeds. It is not necessary to remind our readers how mines in the copper and lead districts have begun to contribute a large quota of zinc, for example, the Butte & Superior and the Interstate-Callahan mines; indeed zinc, in the form of blende, is a by-product of most metal-mining operations in the West. Hitherto blende has been regarded not only as a sign of deterioration in lodes valuable for their gold, silver, lead, or copper, but commonly it has been an excuse for smelter penalties of a drastic kind. It is not too much to say that blende has been regarded as a nuisance both by the miner and the metallurgist. Unquestionably this mineral is widely distributed and can be won at an accelerating rate of production if the demand is maintained. No natural monopoly of it exists, so that over-production is inevitable unless the price drops severely. That, of course, is a logical consequence of easily recognizable conditions. The price was 5 cents before the War; it is 13 cents now; a compromise between these extremes is certain. "The world of economies balances on the thin edge between 'must have' and 'must sell'." We expect to see a thriving industry maintained with spelter at about 7 cents per pound.

Enrichment of Copper Ore

In this issue we give our readers the third of Mr. Probert's articles on the 'Surface Indications of Copper.' On this occasion he discusses the chemistry of the oxidized zone and attacks problems of the greatest scientific interest. In the course of his analysis of the chemical and physical factors at play in the uppermost portion of copper deposits, he makes us pleasantly aware of the recent growth of knowledge on this obscure subject. It seems long ago since Emmons, Winchell, and Weed started the train of investigation that explained to the miner how copper migrates from one part of a lode to another and how it is arrested in that migration so as to compose rich orebodies. We know all about secondary enrichment now, at least until we try to state what we know in plain words, when we possibly discover sundry voids in our understanding of the chemical reactions, which are necessarily complex. The experiment made by Mr. Horace V. Winchell, in 1902, whereby he made chalcocite synthetically by the action of copper sulphate on pyrite in the presence of sulphur di-oxide, was illuminating, even if it be granted that the presence of sulphur di-oxide in descending waters is uncommon. Mr. H. N. Stokes showed by another experiment that a neutral solution of cupric sulphate will react with pyrite so

as to precipitate chalcocite. And while we have learned now that all chalcocite is not of secondary origin, we have abundant proof of the fact that many important orebodies enriched by that mineral, together with covellite and bornite, are the result of such a process, as is the case more particularly in the disseminated copper deposits to which Mr. Probert directs our attention in his articles. In the arid regions of the Great Basin, between the Rocky Mountains and the Sierra Nevada, the factors of temperature, depression of the ground-water level, and porosity of the surface to carbonated waters have been potent in facilitating the leaching of outcrops. To this has been added the effect of relatively slow erosion as compared, for instance, with the Arctic or other regions exposed to planing by ice-sheets. This point was elucidated by Mr. Winchell, many years ago, to explain the scarcity of secondary sulphide enrichments in the North. It is hardly necessary to remark that an apparent exception, namely, the remarkable mass of chalcocite ore at the Bonanza, or Kennecott, mine in Alaska, is conceded by Messrs. L. C. Graton and C. F. Tolman to be primary. Among other notable enrichments, the Chuquibambilla, in the high arid region of Chile, is unique in consisting chiefly of brochantite, the basic sulphate of copper, a relatively rare mineral frequently confused with atacamite and formed probably by the oxidation of chalcocite, as suggested by Mr. Waldemar Lindgren. How great a range of reactions is involved in the chemistry of copper ores is indicated by the series of equations quoted by Mr. Probert. Of course, these express only the dominant exchanges; between them come innumerable modifications and interplays quite beyond expression by any formula, and complicated, as such reactions always are in nature, by the volume of water that serves as the medium wherein they exercise their multitudinous activities. Lots of water and plenty of time must always be conceded in any attempt to follow the operations that culminate in a deposit of ore. All of which is made clear in Mr. Probert's admirable essay, wherein he also brings out the significance of cuprite, and native copper, as an indicator of the second cycle of oxidation by descending waters of surficial origin. Yes, indeed, the earth's attic, called the 'crust' by geologists, is a laboratory in which experiments on a large and conclusive scale are ever at work.

A Box of Cigars

Gratitude is defined as a feeling of appreciation for favors shown, or expected. Walpole said that "the gratitude of place-expectants is a lively sense of future favors." Dr. Johnson considered gratitude a fruit of great cultivation not to be found "among gross people," and as he made the remark while touring in the Hebrides we presume he was not feeling very well. Like most good things, gratitude can be overdone. "Thank me no thanks" exclaims one of Shakespeare's characters. "To be over-thankful for one favor is in effect to lay out for another." More true, however, is the saying of

Benjamin Franklin: "He who has once done you a kindness will be more ready to do you another than he whom you yourself have obliged." Men like to forget those to whom they are under obligation, especially if they are conscious of having failed to reciprocate, while the generous man loves to repeat his kindness to one who has shown a just, not excessive, appreciation. An excess of gratitude is unpleasant, it becomes confused with servility, it is found in dogs. Man's inability to express sentiment graciously makes him an awkward animal; to most of our species the dog can give points in showing thankfulness and remembering kindness. "The winter wind is not so unkind" exclaims King Lear "as man's ingratitude." But with the average human the failure to express the feeling is due to diffidence, to awkwardness, to a desire to do it fittingly, if at all. "Thanks, the exchequer of the poor" says Shakespeare. Sincerity of feeling and naturalness of expression do not flourish among the spoiled portion of human kind; there words become counters and frankness is taboo, or *tapu*, as the Maori says. And words, at best, are but empty thanks; so many avoid them, hoping chance may give them a better means. Our own profession, for instance, nomadic as it is, is the beneficiary of courtesy and goodwill from those whom we may meet only once. The chance to reciprocate does not offer itself, only grateful acceptance—and the resolution to pass it on, to do a similar kindness to those that, in like manner, can make no return. This is a working philosophy, at least. The ledger of hospitality—of the mind, no less than of the house—is not kept too precisely; it calls for an easy book-keeping; it discards mean details; yet in the life of a broad-gauge man the two sides of the account will strike a rough balance, with a margin in favor of credit. In youth the account is on the debit side, for the young man receives kindnesses that he cannot hope to return; but as life matures there comes the frequent opportunity to pay back to a new generation the debt accumulated to that which preceded. Yet, it is unwise to leave much to the future. The young man should never miss a chance to express thanks to his helpers. If somebody recommends him for an appointment, if another gives him a valuable hint, if a useful warning is tendered, it is well to recognize the service. *Bis dat qui cito dat*. Engineers do favors for each other. Acknowledgment is often lacking, sometimes because the spirit of the act is less appreciated than the tangible result. For instance, one man passes a professional engagement—the inspection of a mine, for instance—to another. It is curious how many waver between the grossness of a commission and the inanity of a mere 'Thanks.' Does not the island of Cuba furnish a means of adequate expression. "In the far savannahs a talisman grows that makes all men brothers," says Lewis Morris. The fragrant product of the *vuelta abajo* is more expressive than many words. Assuredly the choice leaf of tobacco, rolled in pleasing shape, is the proper medium for transmitting just that feeling of civilized gratitude that words or money alike fail to convey.



DISCUSSION

Our readers are invited to use this department for the discussion of technical and other matters pertaining to mining and metallurgy. The Editor welcomes the expression of views contrary to his own, believing that careful criticism is more valuable than casual compliment.

Heating Cyanide Solution

The Editor:

Sir—In view of the fact that some small cyanide mills recently coming under my observation are heating the mill-solution by means of circulating it through an envelope surrounding an extension of the exhaust-pipes of gas-engines, it may be well to call attention to extraction and solution troubles that may result from overheating under such conditions.

The heating of cyanide solution with a view to accelerating and increasing extraction by cyanidation was investigated at an early date by cyanide operators, and to most of those who have carefully looked into the matter it is evident that nothing is gained by heating cyanide solution above the temperature of normal summer weather. When the solution is heated above this temperature, a destruction of cyanide takes place and also a re-precipitation of some dissolved gold and silver. This is due to the increased chemical activity of both the cyanide and the caustic alkali, which attack the base elements of the ore, especially the sulphides, decomposing a part of them, charging the solution with deleterious salts, especially those of sulphur. While it is stated on good authority that the increased decomposition of the bases in the ore may result in liberating "locked up" values, and so facilitate their dissolution, I have invariably noted a poorer extraction of both gold and silver in laboratory-tests when the solution was heated much above normal.

I have on record the tabulated results of hot cyanide-solution tests made on ores from Guacimal and Tres Amigos, Costa Rica, and from four different Nevada ores, and in each case a diminished extraction and increased cyanide consumption is to be noted where the temperature exceeded 120° F. This may be explained, as regards poor extraction, by assuming that dissolved gold and silver are precipitated in the pulp by base compounds developed by excessive heating. It is probable that the hot alkaline solution, caustic lime and soda being present, decomposes sulphides to form alkaline sulphides Na_2S and CaS , which in turn precipitate silver and some gold from weak solutions. This theory is supported by the fact that I have found thiocyanate present in the solution after such tests, although no solution was used at the start, and that I found no appreciable amount of thiocyanate present when the test was made with cold solution on the same ore. The increased consumption of cyanide in the hot tests is due to its

active combination with base elements, and to a tendency to polymerize and decompose in such combination.

In heating solution by means of circulating it in contact with the exhaust-pipe of a gas-engine, if the solution is not rapidly circulated in sufficient quantity, it becomes heated almost to the boiling-point, as I have observed. This may result in a loss of cyanide and foul solution, especially if the solution bears considerable protective alkali. In addition to this, the solution, by such heating, is deprived of its dissolved oxygen, which is so essential in dissolving gold and silver. While the moderate warming of very cold solutions is beneficial in shortening the time of treatment, heating above normal is harmful.

If in extremely cold weather it is deemed necessary to warm mill-solutions, it should be done in such a manner that it does not necessitate a small constantly circulating quantity of solution being excessively heated in order to bring up the temperature of large quantities of solution.

ALFRED MERRITT SMITH.

Reno, Nevada, May 23.

[From his letter it would seem as if Mr. Smith has not followed the work at Tonopah, at the Mexican mill on the Comstock, and other silver districts, where a distinct advantage is gained by heating solutions to as high as 120° F. The reactions given by Mr. Smith may take place, but at Tonopah the increased recovery greatly over-balances the cost of heating solutions and loss therefrom. We would like to hear the latest results from this phase of cyanidation from our Nevada friends. The term "re-precipitation" as used in this letter has been superseded by "premature precipitation."
—EDITOR.]

Sunday Work at the Mines

The Editor:

Sir—Most subjects pertaining to mining come under discussion in your valuable journal, but although I have been a regular reader for many years, I do not remember coming across any views for or against Sunday work in mining.

It seems to me that in the Western States the custom of operating mines and mills on Sunday, just the same as on any other day, has become so universal that if anyone were to raise his voice against it, he would be considered either a crank or one who had not the interest of the industry at heart. But yet, just because a thing is the custom, it does not necessarily follow that it is

correct, nor the best for all concerned. In matters pertaining to the human family like the one day's rest in seven, one naturally turns to the Bible for information, in the same manner as an engineer takes up his Trautwine or Rankine if he wants to get facts relating to an engineering problem, and in the Bible we find that the Sunday question is dealt with in no uncertain way. The institution of the Sabbath seems to date back to the earliest times, as we find that in the time of Moses the commandment with respect to it begins with "Remember the Sabbath," clearly indicating that at that time it was already observed, and there is no doubt that the day was set apart by the wisdom of God, for the benefit of mankind, both physical and spiritual, but especially with regard to his spiritual nature, as the Sabbath day commandment is one of the four dealing with man's relation to God. Christ's words that the Sabbath was made for man and not man for the Sabbath endorse this view, and his whole teaching in connection with the Sabbath shows clearly that the day was for man's blessing and not his hindrance.

About 20 years ago I left the United States and went to New Zealand, and the only experience I had at the time with regard to Sunday work in mining was that it was the proper thing; and when, after I had been in New Zealand for some years in charge of mines, the question was brought up by the Government, with a view to passing a law to stop Sunday work in the mines and mills; I naturally joined with my fellow managers in protesting against the proposed action. However, the law was passed, and I can now honestly say that I look back with shame at my foolishness in standing against that which God had ordained (see Acts V, 29) and I think it safe to say that, after having experienced the Sunday closing of the mines and mills in New Zealand, there is not a manager of a single reputable company there who would like to go back to the old conditions.

The cry of the mine-owner against Sunday closing is that he is going to lose his profit, and the cry of the worker is that he is going to lose his wages. Of course, this looks plain enough, but it is well to remember that human calculations are not of much importance in the sight of God, and Sunday profits and wages are apt to turn to ashes. Since returning to the United States I have seen and experienced a great deal of Sunday work and I can truthfully say that I abhor it. To work day after day without a break, Sunday, Good Friday, Easter, and even Christmas, has a most deadening effect, and there is no wonder that when a man has had about six months of it, he calls for his time, and takes the nearest route to a 'wet' city, and has a 'bust.'

I doubt whether it pays from a financial standpoint. A man naturally goes to his work with more zest on Monday if he has had a change from toil on Sunday, and he takes more interest in it—he is better off physically, and there is no question about the spiritual gain, unless he is a man whose bringing up has given him no better way of spending his leisure than to loll about and engage

in idle conversation. There are better ways to spend Sunday than this.

Under the New Zealand law, permits are granted by the Inspector of Mines for working men on Sunday at repairs in the mills, and also for pumping, etc., in the mines. When a mill is closed down and free from noise, a repair-man can do about twice the amount of work and do it better than when he has to do it while the machinery is in motion.

Upon whom should the blame and responsibility for the existing conditions be placed? The men claim that they have to work on Sunday or lose their job; the management says the directors require Sunday work, and that the men also demand it; the directors wash their hands of the whole matter and say that they leave these details to the manager, and the shareholders clamor for dividends and ask no questions about the necessity or advisability of Sunday work.

Clearly the directors and shareholders are the responsible parties; they can say 'this' or 'that,' and have the authority to enforce their requirements. It is still the old story; money first and God second place. Away back at the dawn of the human race, wicked Cain evasively asked "Am I my brother's keeper?" and this question has been ringing through the ages ever since, and is answered by faithful Paul in his well known statement which contains the whole essence of brotherly love: "Wherefore, if meat make my brother to offend, I will eat no flesh while the world standeth, lest I make my brother to offend."

F. C. Brown.

Boise, Idaho, May 24.

Chinese Mining Regulations

The Editor:

Sir—Replying to your kind invitation of March 21 to comment on your editorial on this subject in your issue of March 18, I take pleasure in making the following remarks.

Were Mr. Lindsey entirely unknown and unheard of to me I should be inclined to welcome any change he might make, preferring unknown evils to those already experienced, but with his enviable reputation and the tribute you pay to those particular qualities of his which are sure to be called on so extensively in the task before him, I welcome most heartily the news that he is to give us a new set of mining regulations, confident that if not too much hampered there will be not only no harm in them but salvation for the mining industry of China.

It is unnecessary to discuss on this occasion the local need of a new mining law in China, and I will pass it on with a word or two. To my mind too much emphasis is laid, even by many of the younger engineers, on the need of something very special in the way of a mining law in order to conform with the multitudinous traditions and customs of China. It may be safely said that the more heed paid to these ignorant superstitions and inefficient customs, by just so much greater extent will

the good effects of any law be vitiated. China is in a great transitional stage, even a rapid one; let us have a No. 1 mining law and grow up to it instead of settling down to a makeshift. Of almost equal importance with a good law is its honest and intelligent administration; the law-makers should bear this strongly in mind. Make a civil service examination necessary and offer an adequate salary and then make it possible to put the fear of God into any official attempting 'squeeze.'

The two salient objections to the present regulations are the difficulties and restrictions put upon the prospecting and opening of mining property, and, the restrictions put upon foreign capital. These must be remedied before mining can flourish in China in the manner that it should.

Regarding foreign capital, I consider it of the first importance and am decidedly in favor of attracting it to China by means of favorable legislation. In the first place, it will develop the mineral resources of the country at once instead of fifty or a hundred years from now, and will bring with it all the benefits attendant on the economic production of raw material. Next, it will educate the people of China in all phases of the mining industry. It will educate the miner, the superintendent, the manager, the director, the president, and the capitalist. It will tend to create an efficient mine administration; in short, it will serve as a great school to train the actors for the great drama of economic mining in China; the stage is already set.

The question now arises, until a greater number of Chinese are educated up to the modern mining industrial standard, should there not be some kind of limitation put upon the number of foreign enterprises, lest before the Chinese are able to stand upon their own feet and play the game, practically all of the best properties in the country would be in the hands of foreigners? Just how this limitation should be applied or whether there should be any limitation is a question that should be decided only after the sifting of many opinions and the most careful study, but it has occurred to me that a geographical limitation might serve the purpose from the Chinese view-point and at the same time need not in any way discourage foreign capital. Suppose, for instance, within a single district or Fu (the average Fu has an area of about 2500 square miles), say, four properties were opened to foreign capital. Their engineers are allowed to prospect, examine, and choose without restriction, but once the limited number is taken up or purchased, then that particular Fu would be closed to further foreign capital. The details of such an arrangement, I believe, could be satisfactorily worked out. It seems to me that the effect of such an arrangement would be to stimulate the entrance of foreign capital rather than otherwise. A limited edition is always more coveted than an unlimited one. This would give the Chinese about the right handicap and once they learn how, the limitation could be removed, as they should then be able to hold their own with all comers.

Such foreign capital as is allowed to enter should be

given full freedom of control, but under the Chinese law. There must be no hint of extra-territoriality.

M. B. YUNG.

Hongkong, May 6.

What Mining Men Read

The Editor:

Sir—In 1910, when the Porcupine gold district was 30 miles from a railroad or any other kind of a road, the engineers and mining men there liked to 'stop-over' for a meal or a smoke at the Porcupine-Vipond mine. One reason was that Bert Poirier, the manager, extended the hospitality of his comfortable cabin without making the visitor feel uneasy. The other reason was that on the table were periodicals from the outside world. In spite of the busy times characteristic of a new district, the better-class weeklies—both technical and general—were read with an avidity that had to be seen to be appreciated. This is not unusual. Men who have journeyed to the ends of the earth comment upon the eagerness with which people cut-off from the world watch for the periodicals to arrive. A significant point is that a man on the fringe of civilization or in a foreign country will choose the really well-written papers instead of trash. A residence in a strange land gives the sojourner a new point of view; he looks at things in a detached way, and learns to appreciate the best in his native country. The *New Yorker* in Chile or the *San Francisco* in China does not want to receive the newspaper that features "Woman Leaps from Ferry" or "Heart Balm Awarded Soul-seeker's Affinity," but he wants papers written by intelligent journalists. If more of us could spend a year at a lonely mine in the Andes or Siberia, I think that our literary taste would be raised considerably.

A recent article in the *Technology Monthly* of Harvard University deplored the neglect of real literature by the engineer. The criticism was made that the technical student's reading is too apt to consist only in 'skimming through' the engineering periodicals. This may be true of the student, but it does not apply to the same man five years later, when he has got over the frivolous methods of the modern undergraduate. Particularly it does not relate to the graduate who has to do with mines. An experience in the mining industry is likely to mean more or less traveling, and an acquaintance with danger, both of which make for seriousness and breadth of view. J. Parke Channing remarked recently concerning a mine in the desert region of the Southwest, that he noticed many of the staff took the Sunday edition of the *New York Times*, and a surprisingly large number of that same excellent paper is sold every Thursday at the news-stands here in San Francisco. The proportion of Americans who are learning to distinguish a real newspaper from a 'sob sheet' is on the increase. The market for good writing is growing.

P. B. McDONALD.

Berkeley, June 1.

Notes From Lake Superior

By P. B. McDonald

An ore-carrying steamer broke in two and sank in Lake Superior four miles off Keweenaw point on May 9, most of the crew being lost. This steamer, the *S. R. Kirby*, was taking iron ore from Duluth to the lower lakes, and was probably overloaded. It is a temptation to overload an ore-steamer, because a full load of the heavy iron ore scarcely more than covers the bottom of the boat. On the same date a steamer left Houghton carrying 3500 tons of copper valued at \$2,100,000, the most valuable cargo ever sent down the lakes.

A horizontal diamond-drill hole, 1575 ft. long, near Juneau, Alaska, has attracted attention in the West on account of its great length for a flat hole and the practical difficulties of handling such a long line of rods. As pointed out by George Newett of Ishpeming, 1600 ft. for a diamond-drill hole is nothing remarkable in Michigan, where holes of 3000 ft. depth are common. But it should be remembered that a horizontal diamond-drill hole is much more difficult to drill than a vertical hole, by reason of gravity, freezing, and other troubles.

The recovery of fine flaky native copper is engaging the attention of Michigan metallurgists. This applies not only in the new White Pine district, where 67% recovery, equal to 25 lb. per ton, is being made by the White Pine Copper Co., but also at the Winona mine where a leaching process is being tried, and at Keweenaw Copper Co., where the Ash-bed lode contains flaky copper in spongy rock. Tailing carrying up to 12 lb. of copper per ton is being stored for future treatment, while experiments with flotation and leaching processes continue, as a sequel to the work of C. H. Benedict.

A dividend of \$1 per share is mentioned for Isle Royale Copper Co. This would be the second dividend paid, the first having been in 1913, although mining was started on Isle Royale land in 1853, the present company having been organized in 1899. A striking contrast is the record of the Quincy mine, which is within sight of the Isle Royale. The Quincy paid its first dividend in 1862, which was 54 years ago, and except for 1866 and 1867, has paid dividends every year since. It is still a remarkably profitable mine, with a long future ahead.

The Ahmeek is the best mine of the dozen subsidiaries of the Calumet & Hecla. Last year it sold 21,800,492 lb. of copper at 18.28c. per lb., the cost of production being 7.96c. Four dividends, totaling \$1,650,000, were distributed during the year. All operating expenses were \$1,734,919, a sum only slightly larger than the dividends paid. The new stamps added to the mill, raising the total to eight, will make the third largest mill in the Copper Country, with a capacity of over 5000 tons per day.

Lake Superior people are trying a little speculation in a Wisconsin lead and zinc venture. Shares of the Platte-

ville Consolidated Lead & Zinc Co. have been offered in the Michigan mining towns, although the company is directed from Chicago. In the past, Lake Superior men have lost money in Wisconsin zinc mines, because they have assumed that the irregular little bodies of zinc could be mined according to the big-scale methods applicable to copper and iron.

Calumet & Hecla produced 72,613,320 lb. of copper in 1915, of which 51,738,588 lb. came from the conglomerate lode, and 1,582,802 lb. from the tailing in Torch Lake. The yield of copper per ton of ore has declined steadily; in 1873 it was nearly 5%, in 1889 about 3%, in 1907 about 2%, in 1915 it was 22.28 lb. or slightly above 1%. Regarding the acquisition of the stock of the Tamarack mine, as to which some difference of opinion has existed, a large majority of the Tamarack shareholders accepted the price of \$59 per share offered by the Calumet & Hecla. W. E. Parnall and James MacNaughton differed materially in their appraisals of the Tamarack mine, whereupon the directors of the company stated that they "naturally do not undertake to decide which of two competent experts is right in so technical a matter." As to the C. & H. reclamation-plant for treating old tailing, the production, with three-quarters of the plant in operation, is at the rate of 5,000,000 lb. per year, at a cost, excluding smelting and selling, of about 4c. per pound. A 20-in. suction-dredge of a capacity of 10,000 tons per day, electrically driven and capable of digging 100 ft. below the water-line, operates in Torch Lake. The tailing is pumped to the classifying-house, through a pipe-line on pontoons. In the re-crushing house are 64 Hardinge mills.

The management of the Copper Range Consolidated believes in producing a maximum amount of copper while the price for the metal is high, rather than send a maximum amount of low-grade ore to the mill in order to extract copper from rock that would not be 'ore' in normal times. For this purpose the rock is sorted carefully and only the higher-grade ore sent to the mill. The average content of ore milled in 1915 was 32 lb. of copper per ton, which is a decided increase over the figures of 23 and 25 lb. per ton in the two years previous. The production of the Copper Range Co. last year was 37,035,642 lb. of copper, the largest in its history, the profit of \$3,459,236 being particularly gratifying. The cost of production was only 8.06c. per pound, compared with a previous cost of 10 and 11 cents. A significant note is the statement by the president, William A. Paine, that the company's new selling department, opened a year ago in New York, has effected a considerable saving in commissions. The general manager, F. W. Denton, states that in 1915, 220,920 cu. yd. of stamp-sand was run into the Champion mine for filling stopes, and 54,240 cu. yd. was filled at the Baltic mine. This sand is piped to the stopes, where the miners require additional waste-rock to enable them to reach the back, and is cheaper than the old method of breaking wall-rock for the same purpose.

Surficial Indications of Copper—III

The Chemistry of the Oxidized Zone

By Frank E. Probert

AN outcrop is not necessarily ore-bearing or characterized by gossan; rock alteration may be the sole indicator of the chemical processes that have acted in conjunction with dynamic forces to concentrate metallic minerals to form ore.

In the wonderful laboratory of the earth's crust, the same laws govern the reactions as those we were taught in our first lessons in chemistry. Acids combine with bases to form salts; molecular re-arrangement produces new compounds; chemical affinity rules in an interchange of atoms; the laws of valency are never violated. It is the same old story that, under favorable conditions, $H_2 + O = H_2O$.

This is true near the surface of the earth, or in the zone of weathering, but as we go deeper our knowledge of chemistry must be more advanced. Other factors enter into the reactions; high temperature, great pressure, mass reaction, the laws of solution, the laws of colloids, and the like, upset chemical equilibrium and bring about conditions which, try as we will, we cannot duplicate in the laboratory. We can theorize, postulate, and argue, but we cannot conclusively prove. The physical chemistry of mass reactions is but imperfectly understood. We can never determine blast-furnace practice by test-tube experiment.

Plant life accomplishes a chemical function of no little importance. Decaying vegetation furnishes acids to attack the surface rocks and minerals. J. J. Beeson, in explaining the formation of surface carbonate ores at Bingham, says¹ that "prior to steam-shovel operations, the surface of Bingham was heavily brush covered. This decayed during summer months producing humic acids and carbon dioxide, part of which remained in the soil to be later dissolved by atmospheric water. As the waters advanced down the hillside, the CO_2 and alkaline carbonate content was increased, so that on the middle slopes, copper carbonates were precipitated by reaction with sulphate waters in the rock." Meteoric waters, with the soluble salts of the surface, are the active agents of all changes brought about in the zone of oxidation.

Of the water that falls on the surface, only a small part sinks into the rocks. The water in the belt of weathering is that held by imbibition, or adhesion, between the water and mineral particles. Locally, and for a time, the belt of weathering may be completely saturated. The activity of the water is dependent on the

compounds present, and the temperature. The variability of pressure at this high horizon is negligible.

Both water and gaseous solutions are active. The chemical changes of the rock-minerals assist in the alteration of the contained metals. When the rocks are not saturated with water, gases are held in the pores and fractures so as to act as important chemical reagents. Much oxygen is carried down in the vadose circulation. Rain will absorb atmospheric gases; it will also dissolve haloid salts from passing over the surface, particularly in desert regions. Nitrates similarly may be taken into solution. These waters will attack and dissolve the alkaline earths and metallic salts, the solutions causing a series of chemical reactions of extraordinary complexity. The temperature in the belt of weathering is subject to changes due to climatic conditions. The average annual temperature near the Arctic circle is about $-15^{\circ} C$. At the tropics it is $27^{\circ} C$. Since solutions are much more active at higher temperatures, alteration is much more apparent in the lower latitudes.

The important reactions are those of oxidation, carbonatization, hydration, solution, and deposition. The oxygen of the air may act at the surface directly as a gas, but to a far greater degree through solutions.

The break-down of organic matter results in the liberation of carbonic acid gas. Carbonatization is chiefly accomplished through the substitution of carbonic for silicic acid. Carbonated waters will attack the feldspars, forming alkaline carbonates, and liberating free silica, part of which may be taken into solution as colloidal silica and part separate out as quartz. It has been ascertained that where vegetation is abundant, the amount of dissolved silica in underground water is much greater than in non-forested regions.

Hydration and dehydration are dependent on humidity or aridity. The combined work of carbonatization and hydration make solution the more active. No substance is wholly insoluble in water, even at normal temperature and pressure. Under conditions of deep water-circulation, even refractory silicates are readily soluble, as instanced by the replacement of the pebbles of the Calumet & Hecla conglomerate by copper.

A unit of solution simultaneously saturated with each of several compounds contains a greater total of solids than a unit of solution saturated with fewer of these compounds, but less of any individual salt than it would were it saturated with that salt alone. The influence of

¹Trans. A. I. M. E., New York meeting, 1916.

one compound on the solubility of another plays an important part in the reactions of the oxidized zone.

The volume of a solution is less than the volume of the solvent, plus that of the solute. It is clear, therefore, that pressure increases solubility, for solution tends to bring the molecules closer together. When soft glass—similar to many natural silicates—is dissolved in water at 210° C., the volume of the solution is 20 to 30% less than the total volume of water and glass.

Solution is the great factor in the belt of weathering; it is augmented by increase of temperature. The relative solubility of the salts formed by oxidation determines, in a measure, the sequence below, for substances dissolved in the greatest quantity are deposited in the greatest quantity. Where the evaporative factor is high, surface concentration may result.

As a sweeping generalization, I may assert that nearly all the primary ores of copper deposits are sulphides and that whatever the form, genesis, or character of the deposit may be, the oxidation, if it takes place at all, will be practically the same. In the first two of this series of articles, I have analyzed the physical conditions that accentuate secondary concentration in the oxidized zone, or in the deeper zone of sulphide enrichment. The porosity of the mass, the opportunity for the free passage of meteoric waters, is the prime essential. Quoting Ransom² on Bisbee: "The most marked physical effect of oxidation has been the great increase in the porosity of the masses acted upon. This has greatly facilitated the migration and concentration of the desulphurized ores and their segregation in workable masses from the bulk of the limonitic and clayey ledge matter. The oxidized material is more porous, softer, and more plastic, hence it weakens the rocky structure in which it occurs, causing a settling of the mass. This enhances solution and oxidation is made even more rapid. This, in turn, assists erosion." The sequence or zonal arrangement we have established, or perhaps accepted, in its relationship to the surface and ground-water level. We have seen how these zones are constantly descending as erosion proceeds. The solutions are finding new material at the bottom of the belt on which to work, therefore, as denudation goes on there is ever a belt contributing material to the zone of cementation below.

Certain minerals have their critical level, which they cannot leave without decomposition, while others have such a large interval of existence that they may be called persistent.

Copper is a peculiarly soluble metal in all its compounds. The sulphides are exceptionally vulnerable to descending oxidizing waters.

Ore minerals are variously altered by atmospheric oxygen, both in degree and rapidity. Stephen H. Emmons says,³ "The important sulphides are attacked in the following order: marcasite, pyrite, pyrrhotite, chalcocite, bornite, millerite, chalcocite, galena, blende." Pyrite and marcasite are the same chemical compounds

having different molecular structure. They do not oxidize or go into solution at the same rate. Pyrite is the more stable.

The presence of free air seems to be essential for the solution of some sulphides, and as not all portions of oxidizing deposits are equally accessible to atmospheric oxygen, residuary sulphides may be left in the upper parts of copper deposits. Chalcocite is stable in the absence of air, although, in the presence of highly oxygenated waters, it is more readily attacked than pyrite.

Oxidation and solution go hand in hand, but reduction and precipitation are not so closely related. Copper is more soluble than gold, and even where conditions are most favorable for the solution of the gold, it is precipitated as soon as the ferric liquors of the surface are reduced to the ferrous state. Residual gold is often left in the outcrop, hence there is a segregation—a relative enrichment near the surface. This explains the transition of the Mount Morgan mine of Australia from one of gold to a steady producer of the red metal. At the Highland Boy, of Bingham, and at the United Verde, of Jerome, there is a concentration of gold at the surface. H. H. Knox has described,⁴ the pyritic deposits of Koninkhoff, in Russia, where precious-metal concentration is particularly well exemplified. Silver is freely soluble in ferric sulphate, but if chlorides are present it is at once precipitated as cerargyrite, and with the reduction of ferric solutions, the native metal will drop out. The Old Dominion mine, of Globe, was worked for many years as a silver mine, and it is not at all unlikely that the present silver lodes of Butte, on which the Alice, Moulton, and Silversmith mines are located, will be worked eventually for copper.

It is perhaps advisable, at this stage of the discussion, to consider the reactions that take place. I have prepared a series of chemical equations, suggesting the sequence of change. It must be understood, however, that such simple formulas cannot express the actual complexity of reaction.

Copper sulphides, in primary ore, are invariably associated with iron sulphides. Recent researches at Butte and elsewhere tend toward the recognition of primary chalcocite at great depths, but, in nearly all deposits, copper and iron sulphide occur together. The oxidation of these sulphides produces the potent liquors.

The mineral waters in the zone of oxidation are acid and metallic sulphate solutions. They react not only on the vein-filling, but on the wall-rocks. The nature of the wall-rocks often plays an important part, particularly if a wall-rock contains much lime. The solutions readily give up their metallic content when in the sulphide zone. The reactions and products will vary with the material acted upon, and an understanding of this fact will guide the geologist in anticipating the future. We must always bear in mind what the physical forces have done in the district under investigation. Broadly speaking, the drier the climate and the less precipitous the surface of

²Prof. Paper U. S. G. S., No. 21. Page 159.

³Chemistry of Gossan, *Eng. & M. J.*, 1892. Page 582.

⁴Trans. I. M. & M., 1909. Page 273.

the land, the more pronounced will be the surface evidence of mineralization, and, in all probability, if long continued erosion is established, the chances are greater that enriched ore is now being oxidized.

Primary ore near the surface at one time or another will run the whole gamut of the list of equations given. The sequence is the same no matter what type of deposit we study, but the rate of change varies with the physical condition of the deposit.

Cupriferous pyrite, a physical mixture of iron and copper sulphides, may be accepted as the general condition of primary ores of copper. The association of these two sulphides seems to increase the rate of oxidation. Gottschalk and Buehler state⁵ that the oxidation of certain natural sulphides is greatly increased by the presence of either marcasite or pyrite, and deduce from elaborate experiments the following explanation:

1. That while there is, in mixtures of two sulphides, a large increase in the solution of the one, there is also a protective action exerted on the other.

2. That there is a difference of potential between the different sulphides which can be arranged in a series similar to the electro-chemical series shown by the metals.

3. That this fact may be of the greatest importance in the process of natural oxidation.

The oxidation of the mixed sulphides may be partial or complete, according to the time they have been subjected to the process. The first step in the break-down is the formation of ferric, ferrous, and basic sulphates with free acid, as expressed in equations No. 1 and 5. The ferric-hydrate may, by hydration, separate out as limonite. Under changed climatic conditions, this may be dehydrated again, producing the hematitic outcrops so common in desert regions. In wet mines, where pyritic ore is subject to rapid oxidation, an orange-colored gelatinous mud will accumulate on the floor and sides of old workings. This is a gel form of limonite, and with it minute black scales of specularite are often found. Limonite may occur as pseudomorphous replacements of pyrite cubes, or staining the silicious skeleton of pyritic casts.

The deep oxidized copper ores of Bisbee occur in limestone abundantly altered to limonite. There is a slow replacement of the limestone blocks by mineral waters. Rhomboidal cleavage has developed in the lime-rock and the waters, filtering through the bedding and fracture-planes, deposit at first a thin film of yellow limonite; the angular corners of the blocks are worn away, the blocks take an ovate form, the limestone is slowly replaced in concentric layers until finally the whole is a mass of hydrated iron oxide. Cupriferous waters produce the same effect and fine malachite specimens often surround residual masses of limonite.

Carbonated waters may cause siderite to form, but this is not common in the outcrops of copper deposits.

Hematite generally attracts the eye on account of its striking color. It is plentifully developed in the arid regions. The dehydration of limonite causes a shrinkage

of volume of 27%, hence the cavernous 'burnt' nature of so many iron outcrops on the desert. This increased porosity, due to chemical change, is a great factor in promoting vigorous circulation. If the country or vein is faulted after mineralization and oxidation, micaceous hematite may develop by attrition. At the Old Dominion mine, in Arizona, the hematite of the gossan is quite greasy.

The influence of the wall-rocks on the character and

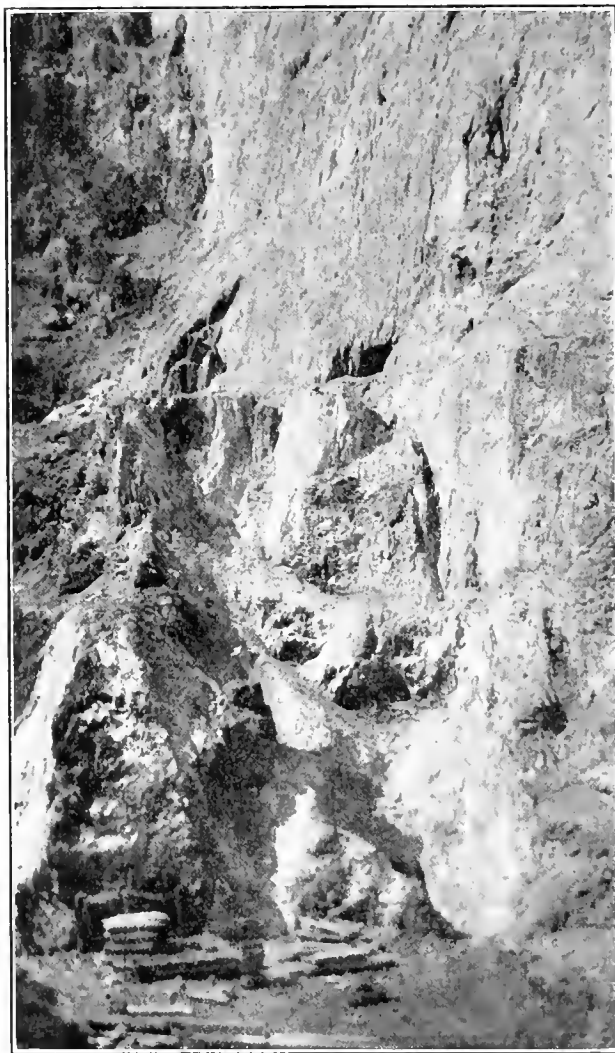

UNITED VERDE OUTCROP, JEROME, ARIZONA.

distribution of the ore in the Old Dominion mine is strikingly shown on the different levels. Rich carbonate and iron ores are found where the fault brings diabase and limestone into juxtaposition, or where fault-blocks of limestone have been caught in the vein-filling or floated in the cooling diabase and replaced. Cuprite and native copper are common in the quartzite, while the sulphides are almost wholly developed where both walls of the vein are in diabase. The presence of these rich products of meteoric waters at the higher horizons coupled with the slight development of chalcocite on the 800-ft. level convinced me, during my examination of the property in 1901, that the original pyrite had been suf-

⁵*Economic Geology*, Vol. 7, page 15.

nently cupriferous to form ore by processes of concentration.

Hematite is the final product of oxidized pyrite. In the arid regions, where ground water lies deep and the precipitation is slight, the solutions percolating through the oxidized zone are likely to be of a concentrated character, and if pyrite, marcasite, or chalcopyrite is abundant, and if the mass is porous, the chemical changes involved in oxidation may be so energetic as to develop considerable heat. This may explain the formation of specularite or micaceous hematite instead of limonite in gossans. Gagel has shown that the presence of salts in solution lowers the water tension and permits of the formation of hematite at low temperatures. It is frequently quite silicious owing to the alteration of other gangue-matter, in which case it will weather out in bold relief.

The vein mines of the Globe district are remarkable because of the great development and depth of the hematite in the oxidized zone. It was the sole indicator, and that in one short exposure, on which I pinned my recommendations for the development of the Superior & Boston property. At the Black Oxide mine, practically the whole vein-filling, which occupied a fault in diabase, is of this micaceous variety of hematite. It averages about eight feet wide and shows no change in its general character at a depth of 600 ft. below the surface, although a winze sunk from the lowest level opened a lens of rich carbonates in the hematite matrix. An incomplete analysis of the ore showed

| | % |
|-----------------------|-------|
| Copper | 6.29 |
| Silica | 18.45 |
| Alumina | 5.89 |
| Iron (metallic) | 43.90 |

Under the 'blow-out' of the Black Hawk, mixed carbonate and glance ore was mined to a depth of 500 ft. where a leached crushed zone, containing hematite and occasional kidneys of ore, gradually merged into the cupriferous belt below.

At the Swansea and Planet mines, in Yuma county, Arizona, hematite is even more plentifully developed, but the district does not promise to become a large or steady producer of copper. It presents the typical desert topography. The hills have fairly regular slopes, although recent ravines have been incised by torrential rains. The pre-Quaternary contour was vastly different from the present detrital surface. The geologic sequence is quite complex. Resting on a basal series of gneissic granite, metamorphosed limestones and argillites are seen. These were intruded by a basic rock subsequently changed to amphibolite and heavily pyritized with barren sulphides. All these rocks were cut later by a series of volcanics. The ore deposits of Swansea and Planet are of the 'replacement' type. They are essentially iron-copper deposits in the sediments and closely associated amphibolites, and are apparently confined to this series. They are limited below by the gneisses and above by the conglomerate. Oxidation is advanced to a degree such that the original nature of the deposit is

lost, but I am of the opinion that the primary ores consisted of specularite, low-grade cupriferous pyrite with accompanying quartz, calcite, and siderite as vein materials. Specularite or micaceous hematite, the predominant mineral, is, I think, in part primary and partly secondary. The origin of such enormous masses of micaceous hematite has long been a subject of interest to the mining geologist. Abundant evidence is now available to prove that it is frequently a direct product of pyrite, whether cupriferous or barren. Cupriferous pyrite is, as I have said before, an intimate physical admixture of minute crystals of chalcopyrite in the interstitial spaces of normal iron pyrite. This sulphide will oxidize first, leaving brownish rusty pyrite grains as loosely coherent masses. The presence of chalcanthite in the gossan, the absence of carbonates or silicates, and the low-grade copper tenor of nuclear masses of pyrite in the secondary hematite, convinced me that the chances for valuable ore deposits at Swansea are remote.

The copper deposits of north-western Arizona were studied hurriedly by Howland Bancroft. In reply to enquiry concerning the great quantity of hematite there found, he writes me from Chile that "In the central-western part of Arizona there is more specularite in a small area than anywhere else I can now recall. I am convinced that the specularite is the result of primary deposition from solutions, which, I think, were the result of dehydration by dynamo-metamorphism. The hematite which is common in the same district, is, I believe, entirely secondary, and may have originated from the breaking down of the so-called primary specularite, or from the oxidation of pyrite. I am inclined to the view that it is the result of the incomplete breaking-down of specularite. I am aware that specularite and hematite presumably have the same chemical formula. However, I think that more research would disclose other differences between the two minerals than the physical appearance. Red or black hematite, found in igneous regions unassociated with specularite is almost invariably an indicator of pyritic masses, and I believe this view is substantially in accord with the views of many others."

Hematite is also found in the capping of contact metamorphic deposits, but here it is an oxidation product not alone of the chalcopyrite or associated iron sulphide, but of the lime-iron garnets and the magnetite.

Magnetite is seldom an oxidation product, but is a common constituent of igneous rocks and magmatic segregations. It is generally primary. L. C. Graton, in speaking of Shasta county, California, says:⁶ "The extent to which magnetite may form in the outcrop of a sulphide orebody is a matter of considerable importance in connection with the prospecting of gossans. It is sometimes found at the surface in considerable quantities as a result of certain peculiar climatic conditions. Outcrops of magnetite have been regarded as the cappings of sulphide ores below. At most places, it has been found that massive magnetite is of primary origin and is persistent in depth. If rock making minerals or the

heavy silicates such as garnet, actinolite, etc., are intergrown with masses of magnetite, it may safely be regarded as a primary deposit, and one cannot fail in their deductions concerning it."

Before leaving the iron oxides, I must comment on the concentration of manganese oxides in the upper zone of oxidation. In the old Detroit and Manganese Blue mines at Morenci, Arizona, now exhausted, there was a series of replacement orebodies in different lime-

of the Detroit Copper Company. Morenci, chalcocite forms as an oxidation product of chalcocite. It is found above the secondary sulphides, never below.

At the Planet mine, Bouse, it occurs as veinlets and efflorescences in the oxidized material, but not in economic quantity. In old and abandoned workings, it will sweat out of the wall-rock and often makes a showing altogether disproportionate to the value of the rock from which it comes.

Brochantite, the basic sulphate of copper, is more stable than the normal salt, hence it is of much more frequent occurrence in the upper zones of copper deposits, particularly in hot climates of little rainfall. It was recognized by Waldemar Lindgren at Morenci, and is not infrequently mistaken for malachite. At the Chuquicamata mine, in Chile, practically all the ore is brochantite. Lindgren ascribes its formation to the oxidation of chalcocite in the highly altered porphyries.

Pisanite, the mixed sulphate of iron and copper, is found in stalactitic form, especially in old workings through lean pyritic ore. All these sulphates are of a distinctly blue color. They cannot be mistaken for the yellowish melanterite. Where melanterite forms as in-crustal masses, the chances for valuable copper deposits are slim.

The carbonates of copper, malachite and azurite, are perhaps the most common minerals of the oxidized zone; certainly they are the most attractive. Malachite occurs in many beautiful forms, particularly in association with limestone rocks. It is always an oxidation product of sulphide ore; it is never primary, and has been pre-eminently the indicator that has encouraged the prospector to dig.

Malachite, as it occurs in the limestones of Bisbee and in contact metamorphic deposits, is formed by direct precipitation from sulphate waters. At the Apache mine, in New Mexico, it is found replacing the angular edges of calcite crystals. Azurite is closely related to malachite and the two occur together. I need not dwell on the significance of the carbonates when found in a region of

1. $FeS_2 + 7O + H_2O = FeSO_4 + H_2SO_4$.
2. $FeS_2 + 3O + H_2O = FeSO_4 + H_2S$.
3. $FeS_2 + 6O = FeSO_4 + SO_2$.
4. $6FeSO_4 + 3O + 3H_2O = 2Fe_2(SO_4)_3 + 2Fe(OH)_3$.
5. $Fe_2(SO_4)_3 + 6H_2O = 2Fe(OH)_3 + 3H_2SO_4$
(hydrolyzation)
6. $4Fe(OH)_3 = 2Fe_2O_3 \cdot 3H_2O + 3H_2O$
(limonite)
7. (a) $Cu_2S \cdot Fe_2S_3 + 2Fe_2(SO_4)_3 = 2CuSO_4 + 4FeSO_4 + 2FeS_2$
(b) $FeS_2 + Fe_2(SO_4)_3 = 3FeSO_4 + 2S$
(c) $2S + 6Fe_2(SO_4)_3 + 8H_2O = 12FeSO_4 + 8H_2SO_4$.
8. $CuFeS_2 + 8O = FeSO_4 + CuSO_4$.
9. (a) $Cu_2S + Fe_2(SO_4)_3 = CuSO_4 + 2FeSO_4 + CuS$
(b) $CuS + 3O + H_2O + Fe_2(SO_4)_3 = CuSO_4 + 2FeSO_4 + H_2SO_4$.
10. $2Cu_2S + 10O + 4H_2O = H_6Cu_4SO_{16} + H_2SO_4$
(brochantite)
11. $2CuSO_4 + 2CaCO_3 + H_2O = CuCO_3 \cdot Cu(OH)_2 + 2CaSO_4 + CO_2$
(malachite)
12. $2CuO + CO_2 + H_2O = CuCO_3 \cdot Cu(OH)_2$
(direct carbonatization)
13. $6CuO + 4CO_2 + 2H_2O = 2(2CuCO_3 \cdot Cu(OH)_2)$
(azurite)
14. $CuSO_4 + H_2Ca(CO_3)_2 + H_4SiO_4 = CuOH_4SiO_4 + CaSO_4 + H_2O + 2CO_2$
(chrysocolla)
15. $14CuSO_4 + 5FeS_2 + 12H_2O = 7Cu_2S + 5FeSO_4 + 9H_2SO_4 + 3H_2SO_4$
(chalcocite) (formed by oxidation of sulphur of FeS_2)
16. $Cu_2S + 3Fe_2(SO_4)_3 + 4H_2O = 2Cu + 6FeSO_4 + 4H_2SO_4$
(native)
17. $Cu_2S + 2O = 2Cu + SO_2$.
18. $2Cu_2S + O = 2CuS + Cu_2O$
(cuprite)
19. $Cu_2O + O = 2CuO$
(tenorite)
20. $Cu_2O + 2FeSO_4 + H_2SO_4 = 2Cu + Fe_2(SO_4)_3 + H_2O$
(native)

CHEMICAL EQUATIONS EXPLAINING THE LEACHING AND ENRICHMENT OF COPPER ORES.

stone strata, rich in oxides of manganese and copper carbonates. Earthy manganese oxide occurs with limonite in the replaced limestone orebodies at Bisbee. It is not an uncommon associate and may be greatly concentrated in the upper oxidized portion of an orebody.

The series of equations shows that acid and metallic sulphates are the main products of the first break-down of primary sulphides. The sulphates are readily soluble and are seldom precipitated to form workable orebodies. Exceptions are rare. The bluestone of the Yerington deposits is evidently a direct oxidation product of the chalcocite (Equation No. 8). At the Central mine

limestone invaded by igneous rocks, but its presence in schistose and porphyritic rocks of the disseminated copper type must be carefully studied. Under such conditions it is frequently an oxidation product of secondary sulphides and the quantity of it may be the measure of the degree to which the chalcocite ore has been oxidized and eroded. In the first case the carbonates have formed through the agency of sulphatized waters, in the latter it is probably carbonatization, for there is insufficient pyrite to form strongly acid solutions, so that the copper, instead of migrating downward, remains at or near the surface, brilliantly stain-

ting the rocks with chrysocolla or malachite. Ransome says of the Miami district: "The largest orebodies are not found under those surface rocks that are most vividly colored by copper compounds or iron oxide." With this statement I am inclined to agree, as it is supported by observations in many other localities.

At Rossland, B. C., C. W. Drysdale reports malachite as coatings on cleavage planes and as staining the clayey gouge. He also says: "Malachite may be seen in the process of deposition wherever downward seeping surface waters trickle into the mine workings."

At Rossland and Kootenai the outcrop of the veins is seldom visible on account of glacial soil. Moreover, the oxidized capping and probably the enriched sulphide one was removed by the Pleistocene ice-sheet.

At the Cactus mine, a few miles north-west of Globe, seams and slabs of copper carbonate form a network in the highly altered sericitized schist. Churn-drill operations failed to disclose any area of enrichment, lean sulphides being found a short distance below the surface. This condition may be caused by an early arrest of the locally concentrated copper waters in the fracture-planes, probably due to carbonated surface-waters. The minerals are definitely crystalline and do not occur in the rock-mass, but as coatings along lines of weakness. I found the same condition at the Piedras Verdes mine, near Alamos, in Sonora. Had the minerals formed by carbonatization of enriched sulphides, a more general distribution throughout the rock-mass would be expected.

The silicates of copper are all due to meteoric waters and form a large part of the oxidized products in the upper zone. Chrysocolla is the one best known. It occurs in both igneous and aqueous rocks, although more frequently in rocks of acid character. Surface-waters containing carbonic-acid gas from the air, decaying vegetation or from calcareous rocks will react with the alkaline silicates, particularly the feldspars, liberating silicic acid from which secondary silica may crystallize out, or combining with metallic-sulphate waters, the several silicates may be precipitated. The same remarks apply to the silicates as to the carbonates regarding enrichment at depth.

Colloidal silicates are always forming in the belt of weathering owing to the reaction of carbonated waters on gangue or rock-silicates. While studying the Butte district, I noticed an accumulation of a gelatinous colorless slime on some joint-planes of the pyritized granite, which, on analysis, was found to be colloidal silica. On the 200-ft. level of the Ray Central mine near the top of the disseminated ore, one of the drifts was coated with a jelly of the most beautiful shades of blue and green. Terraces had formed on the floor of the drift. It was a gorgeous display of soft colors. Chemical analysis of the solid substance showed

| | % |
|--------------------------------|-------|
| H ₂ O | 28.05 |
| CaO | 1.29 |
| Al ₂ O ₃ | Trace |

It was a hydrous copper silicate closely related to chrysocolla and was forming from oxidizing chalcocite.

The study of mine-waters or surficial waters running over rocks supposedly mineralized is instructive. Many shallow deposits of copper conglomerates are known in Arizona, caused by the deposition of silicates as a cement in gravel and sand. Copper salts are often taken up by clays by absorption. I have seen many interesting samples of this condition, but none of economic value.

To continue our study of the zone of oxidation, it is necessary to accept the reactions, simple and complex, brought about by the changed conditions at ground-water level. The migration of the metal downward is here stopped, the environment changes from that of oxidation to that of reduction and precipitation. The metallic burden is deposited, and enrichment of primary ores results. Chalcocite, covellite, and kindred sulphides are formed as shown by equation No. 10. We have seen that in the downward migration of the metallic-sulphate waters, part of the copper will, under given conditions, separate out as carbonate, silicate, or sulphate. As it approaches the ground-water level, the environment changes, the oxygen is used up, air is excluded, and further reactions take place in a reducing atmosphere. Copper is precipitated as chalcocite, covellite, bornite, chalcopyrite, enargite, etc. The precipitation is often of the nature of metasomatic replacement, and pseudomorphic structure may result. As the solutions descend they lose acidity, copper sulphide is precipitated at the expense of iron sulphide. A decrease in acidity, a decrease in copper, and an increase in iron in solution bring about a state of equilibrium that is increasingly favorable to the precipitation of double sulphides.

At and near the ground-water level many complex reactions, as yet imperfectly understood, take place. The oxygenated sulphate waters in contact with enriched sulphides may bring about reverse chemical changes, so that chalcopyrite is rejuvenated. Beeson, as a result of preliminary experiments in the laboratory of physical chemistry at Stanford University, tells me that "solutions rich in iron or those containing a proper catalizer in the presence of certain iron minerals, under slightly acid, neutral, or alkaline conditions, reacting on chalcocite or bornite, will readily form chalcopyrite. Great pressure is not necessary for reverse reactions. A small quantity of sulphuretted hydrogen will act as a catalytic agent. Chalcocite in contact with hematite in the presence of sulphuretted hydrogen soon becomes coated with chalcopyrite."

The presence of lime carbonate in ore or wall-rock will check the downward migration of metallic sulphates. Hence chalcocite is seldom found in limestone rocks. Free acid in the solutions may, however, convert part of the carbonate to sulphate—an insoluble substance—and so admit of the passage of enriching solu-

| | |
|------------------|-------|
| CuO | 47.16 |
| SiO ₂ | 21.20 |

U. S. G. S. Bull. 529. Page 186.

Memoir No. 77. Geol. Sur. Canada.

tions to great depths. Silicification of limestone by contact metamorphism will also allow of the development of chalcocite, as at Bisbee.

All this we shall have to accept, referring the reader to the many papers and publications on secondary enrichment for further information." We assume that the solutions have done their work and have mingled with the great water-zone below ground-water level. It is constantly changing, as we have seen. The enriched sulphides are subject to an aftermath of oxidizing influences and there is a rearrangement, a new distribution of the copper content. The most common changes are those that result in the formation of oxides or the native metal. While not an invariable rule, the presence of native copper or the oxides of that metal is a sign of the alteration of secondarily enriched sulphides and de-

above the richer chalcocite stopes. At Bisbee, in the Hoatson mine of the Calumet & Arizona, it is abundantly developed and native copper often replaces cuprite cubes. It is connected directly with the enriched sulphide ores. Hence my statement that it is an indicator of the second cycle in the chemical changes that take place, the oxidation of the enriched sulphides as they are exposed to the constant attack of meteoric waters.

Native copper seems to be the ultimate product of this long list of progressive impoverishment, enrichment, and concentration. It is the last stage of Nature's hydro-metallurgical process. From the inappreciable quantity of the metal brought up from below by igneous rocks, by devious and varied routes, by many agents, by many steps, through long intervals of time, Nature at last turns out a product 100% pure. Surely the old earth is a great workshop.

Testing Detonators

A detonator is a blasting-cap, or copper capsule containing a small quantity of some explosive compound that is ignited by a fuse. An electric detonator is one that is ignited by a small wire that becomes heated to incandescence, or fused, by the passage of an electric current. Fulminate of mercury is a well-known detonating agent. It may be mixed with 10 or 20% of potassium chlorate, and tests have shown that the fulminate alone is inferior to a 90:10 mixture, which in turn is inferior to an 80:20 mixture. The U. S. Bureau of Mines employs 'sand-tests' for testing the relative efficiencies of detonators. A uniform clean quartz sand of 30 or 40-mesh is employed. The sand is placed in a small steel case, which has thick walls and a cover. The detonator is fired in the centre of a mass of 100 grams of standard sand placed within the cavity. The extent to which the sand is pulverized by the detonation, as measured by screening tests, indicates the efficiency of the detonator. It has been assumed that a high speed of detonation is an essential property of a detonator. This is not so. Many explosives, such as blasting gelatines and nitro-glycerine, have a higher velocity of detonation than fulminate of mercury, but they have not the properties that fit them for use as initial detonators. It appears that the explosion of mercury fulminate results in an intense local action in the form of a sudden blow. Former methods of making tests, in which the detonators were fired in holes in lead blocks or their influence tried on other detonants at various distances, had proved unsatisfactory, the sand-test being now preferred for careful work. However, a simple test can be made with a 4-in. wire finishing-nail. The detonator is fired in proximity to the nail, and the resultant bend in the nail indicates the strength of the explosion. The strength of fulminate detonators is said to be not affected by becoming moist, although detonators of trinitrotoluene are weakened by moisture. The T.N.T. detonators may become entirely unserviceable after storage for a month in a damp magazine.



BUCKEYE OUTCROP, GLOBE, ARIZONA.

notes long continued erosion. I do not include the Lake Superior copper deposits in this generalization. They are of an entirely different character.

In the description of the zonal arrangement of metallic products, the not infrequent presence of a belt of oxy-sulphides was noted. This will be more pronounced as erosion proceeds, with decreasing quantities of sulphides, but with proportionate increase in the richness of the copper contents of oxidized products.

Cuprite is characteristic of the original deeper zones of oxidation in the vicinity of the secondary sulphides. It occurs both in an amorphous earthy condition and in beautiful crystalline form. At the Ray Central mine, the upper envelope of the disseminated chalcocite is characterized by chalcotrichite, the acicular form of cuprite. This same mineral is found with cavernous limonite in the Moctezuma mine at Morenci. At the Chino mine, I have observed a blood-red train of cuprite coming off the concentrating tables, testifying to its association with the chalcocite ore. At Butte, while not common, I have seen it in association with native copper

"Genesis of Ore Deposits," A. I. M. E., 1901, "Ore Deposits," A. I. M. E., 1913, and Bull. U. S. G. S., No. 529, etc.

Gold Mining in the Philippines

By C. M. Eye

THE Arroyo district on the island of Masbate furnishes the greater part of gold produced by lode mining in the Philippines. The Colorado is the largest of these mines. During last year 50,000 tons of ore was treated at this mine, with a yield of \$425,000 in gold at a net profit of \$230,000, or 46% on the capital. Two dividends each of 10% were paid during the year, and an undivided profit of \$325,000 was on hand at the end of the year. The mine has an ore reserve of an average grade of \$9 per ton, in quantity sufficient for five years. The stoping width is 16 to 20 ft., and in a new ore shoot it will be as much as 36 ft. of \$14 ore. Waste for filling is let down through chutes from surface. It is likely that an electric haulage system will be installed.

Several changes have been made in the mill. At present only 20 hours of contact with the cyanide solution is necessary, and assays of pulp from the classifier following the tube-mills average only \$1 per ton on \$9 ore. This has made possible the elimination of agitation, the pulp being passed from the classifier to thickeners, the overflow going to precipitation, and the underflow to another pair of thickeners in parallel, thence, with the solution of \$1.60 per ton, to leaf-filters, from which it is discharged with about 20c. loss in soluble gold, and 80c. in insoluble. The overflow of the secondary thickeners is also sent to precipitating-boxes, and the entire barren solution, with the washes from the filter, is sent to the head of the mill. The mechanical changes include the installation of shaking-feeders in the chutes to the stamps for removing fine below about $\frac{3}{8}$ -in., and passing this fine directly to the classifier; an addition of another 5 by 16-ft. tube-mill to the original battery of two; the substitution of steam-pumps for the triplex pumps originally used; the replacement of revolving-drum filters by a leaf-filter, and the changing over from steam to an internal-combustion engine for furnishing power for the main operations. The depletion of available manglar wood has made it necessary to use other fuel as the main source of power, so a 500-hp. engine of the Diesel type has been purchased. Fuel-oil suitable for this engine is delivered in drums from ships in the bay, a mile from the mill. Wood costs \$3.25 per cord, delivered, but the quality has diminished in value, as the best manglar wood has been exhausted. At the beginning of operations, a cord of this wood weighing 3000 lb. had a fuel-value of at least 12,000 B.t.u. A change proposed is to remove the crusher from above the mill-bin, and set it higher, using a revolving screen below it to remove the fine. Such a screen has been tried, but is not now in use, probably from lack of head-room. Considering the sticky character of the fine, it would seem better to install a washer, as mentioned later in connection with the Syndicate mill.

for the better reduction of the coarse portion of the ore, much of which is extremely hard.

The Colorado company is developing other promising veins and has several properties under option on which it is doing development, spending in exploration \$1000 per month. These outside veins are mostly of what is termed in California 'bull quartz' the gold being apparently in a coarser form than in the main veins, so it is likely that if extensive orebodies are found, amalgamation will be a feature of the treatment.

The Syndicate mine is next in importance. It is equipped with a good mill, which treats 120 tons of ore per day. The ore from the mine is freed from fine in a revolving trommel by a wash of cyanide solution, the fine being carried to the classifier, while the coarse goes first to a Blake crusher, thence, after passing over a grizzly, to a roll-jaw crusher. The crushed product goes to a Hardinge ball-mill, taking inch material and delivering maximum particles of $\frac{1}{2}$ -in. There is also a Hardinge pebble-mill, and a 6 by 16-ft. tube-mill for final reduction of the sand from the head of the Dorr classifier. The finished product goes to a set of primary thickeners, the overflow of which goes to zinc-boxes, and the underflow to an agitator built after the description by Whitman Symmes that appeared in the *MINING AND SCIENTIFIC PRESS* of July 19, 1913. From this agitator the product goes to secondary thickeners, and thence to two Kelly filters. The final loss in dissolved gold is about the same as at the Colorado mine, namely, 20c. per ton. The average grade of ore handled is better than at the Colorado, but it does not yield so easily to treatment. The extraction might be improved by longer contact and more agitation, the undissolved gold in the final discharge being, I believe, about \$1.40 per ton.

Power is supplied by several internal-combustion engines of the Diesel type. A shortage of power to operate the various units, some of which take heavy loads intermittently, has hindered operations. Recently the operation of the plant has been handicapped by the wrecking of a 100-hp. Diesel engine of German manufacture, through crystallization and breaking of bolts on one of the crank-shafts; the inconvenience is aggravated by the fact that it is impossible to get duplicate parts from Germany. Fortunately, a 150-hp. Diesel engine of English make is on the way, a duplicate of one already in use.

The Syndicate mine near-by has a number of promising veins, and the condition of the mine is said to be good. Two dividends of 5% each were paid in 1915.

The Keystone is the next mine of importance. It is equipped with a mill for handling 50 tons of ore per day. It is kept in fairly steady operation, but, like the other

mills, has insufficient power. The motive power here is also derived from internal-combustion engines, and, as there are no filters in the plant, the load is fairly even. Therefore electrical conversion is not used, and the engines drive the machinery through line-shafting. The ore is delivered by a jig-back gravity surface tramway to a grizzly preceding a Blake crusher, whence, after passing over another grizzly, the oversize goes to a pair of rolls, 14 by 28 in. and thence to the storage-bin, where it joins the fine. Two Lane slow-speed Chilean mills are fed from the bins, delivering their product to a Dorr classifier, the sand from which, assaying \$5 to \$7 per ton, goes to four leaching-tanks, where it receives 36 hours of treatment, bringing the content of insoluble gold down to about a dollar per ton. The slime from the classifier passes to a system of thickeners where, by decantation, the treatment is finished without filters. There is also a 5 by 16-ft. tube-mill that on occasion is used to reduce sand to slime, returning the product to the classifier. But owing to shortage of power, it has been found necessary to bulkhead off about 7 ft. of this mill, converting it in action into a short mill.

The chief difficulty arises when the unoxidized ore, which is heavy in iron sulphide, is mixed with the oxidized ore, which is the main output. Mine developments show that the oxidized zone is shallow, so that, while the area to be explored is large, it is likely that the treatment will have to be changed considerably when the surface ore is exhausted. The mill is well placed as regards the future working of the property, and it is conveniently situated as regards handling of supplies, being near the beach on a cove of Aroroy bay. No dividends have been paid, but the outlook is much more promising than at any time in the past.

The Benguet district of northern Luzon ranks next to the Aroroy district in production. The new mill of the Benguet Consolidated Mining Co., which started in September, is running steadily and is furnishing the principal output. The ore at present assays about \$20 per ton, the output for February being 1500 tons, yielding more than \$25,000 in bullion. Power is furnished by a 100-kw. hydro-electric plant, using the water of Antamok river under a 320 ft. head. At this time of year, trouble is experienced from shortage of water, but the rains will begin soon. Trouble has been had with tube-mill liners, and the failure of a locked type of boltless liner tied up the tube-milling for some time. Now, however, a supply of a superior type of lining ensures against a recurrence of this trouble. It may be remarked that operation of the plants at Aroroy has been delayed through the non-arrival of supplies from the United States.

The treatment given the ore is as follows: crushing to 2-in. maximum size, stamping through 8-mesh 'Rectang' screen to a Dorr classifier in a closed circuit with a 6 by 10-ft. tube-mill, passing the product of minus 100-mesh to a primary thickener; the overflow solution is precipitated and the underflow is lifted by diaphragm-pumps to a series of three Dorr agitators, at the head of

which the solution is brought up to 3 lb.; thence to a series of four secondary thickeners where successive decantations are made, on the counter-current system, and final discharge at 1:1 with about 24c. in dissolved value, and one pound of cyanide per ton. In order to reduce the soluble loss, as well as to save cyanide, and allow of a fourth full decantation in the secondary thickeners, a Trent replacer of the Carpenter overhead-suspension type is being installed. The loss in undissolved gold has

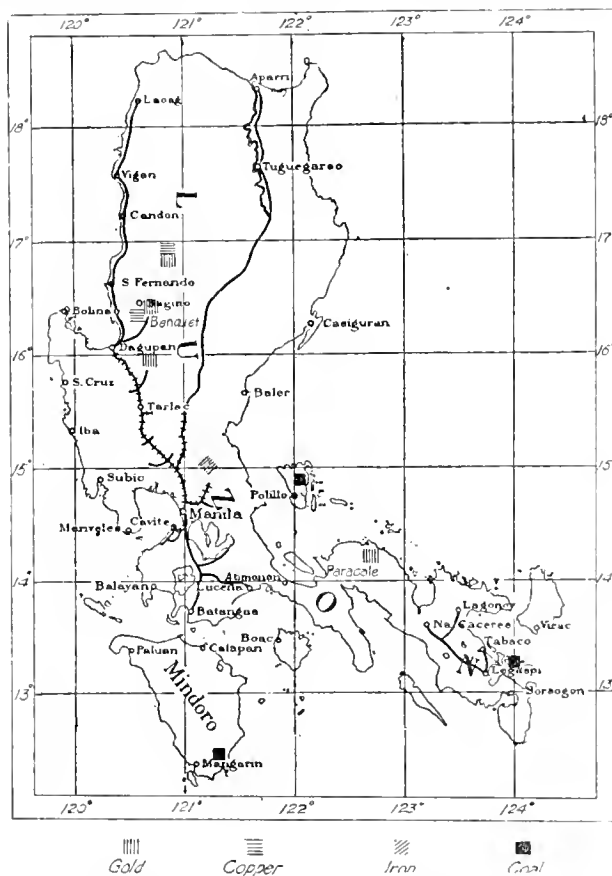

NORTHERN PART OF THE PHILIPPINE ISLANDS.

been high thus far, owing to the presence in the richer ore of a high-grade sulphide of iron that does not yield its gold easily to treatment. It is probable that a special battery of three stamps will be installed, with a concentrating sand-table for handling the ore in which this high-grade sulphide occurs, the sand and slime from this mill being then passed to the classifier of the regular mill for treatment. The stamping will, of course, be done in cyanide solution of regular mill-circuit strength, in order to avoid dewatering.

An orebody recently uncovered is looking well, both on the milling level and on the level 100 ft. below. A square-set stope has been opened 160 ft. long by 20 ft. wide, the average grade along the sill-floor being \$16 per ton. The continuation of the richer portion of this orebody to the north-west has been opened for 120 ft., showing a width of 3 to 5 ft. of ore assaying \$75 per ton. It has not been determined yet whether this ore goes to surface, 200 ft. above. Altogether the outlook for this property is most promising. The width of the mineral-

level one is about 100 ft. and the company holds patents over 3000 ft. on the outcrop.

The Headwaters mine, under lease to E. O. Hibbard, is the next largest producer in the Benguet district. The mill is operated as an amalgamating plant only; the stamps crushing through 40-mesh screen, the product passing over several sets of plates, thence to waste. As a rule, low grade ore is handled at small expense, and the recovery is fair. At present only five stamps are dropping, but the operation is said to be profitable. Of course, on a lease that has but a limited time to run, it is not likely that much development work of permanent value will be done.

The Acupan mine, on Batuan creek, is the only other producer. The three light stamps, with arrastra following, are driven by water wheel, and have been handling an accumulation of low grade, soft, free-milling ore with an output of \$800 to \$1000 of gold per month. The operating expense is light, and the profit is being applied to the development of a well-defined vein outcropping above the mill. A remarkable feature of this deposit is an appreciable quantity of cinnabar throughout. In the Lubang district, in the south-western corner of Benguet, there are several primitive mills working, but little is known regarding their operations, except the information given in the bulletins of the Bureau of Science. There may be other small prospecting mills elsewhere in the islands, of which I have not heard. It seems reasonable to assume that the output from mills treating gold ore will average \$100,000 per month for 1916, putting the output of the Colorado at \$40,000, the Syndicate at \$25,000, the Consolidated at \$20,000, the Keystone at \$10,000, and all other mills at \$5000 per month. There are no new mills being erected, but it is probable that most of the existing plants will increase their output, and none are likely to close down. A number of promising prospects are being opened in the Benguet district and elsewhere, but none that are likely to need new mills during the present year.

As regards the political situation, the general opinion among local mining men is that the policy of the Government will not be discouraging. In case independence is granted, mining will suffer somewhat, in common with other industries from the increased taxes and decreased efficiency of administration, yet it will be little worse than at present, with an administration entirely pro-Filipino and the welfare of the islands a political pawn in the game of politics at home. Many wealthy Filipinos are investing in mining stock, but it is not an industry that they can develop themselves.

Mining in the war areas of Europe will suffer for a long time. For instance, when the Russians retreated from Galicia they greatly damaged a number of the oil-wells before relinquishing them to the Germans. Again it is reported that the German administration of the Belgian and French coal and iron mines is hurrying out coal and ore with no regard for the future conditions of the workings.

A Wet Shaft

In opening the Leonidas mine at Eveleth, Minnesota, a great deal of trouble was caused by the heavy flow of water. A large vertical shaft was sunk, and lined with steel members; planking was used for temporary lathing, and replaced later by reinforced concrete slabs. Glacial drift, 72 ft. thick, covered the rock, which was taconite, a hard silicious formation, more or less broken. Water was found at 30 ft. depth, and the flow became so heavy at 268 ft. that a temporary pump-station and sump were cut and three Prescott pumps placed there. Four sinking-pumps were employed to 'shamble' water to them. At that time 1500 gallons per minute was being handled, this flow being entirely in a shaft with no levels developed. The miners were usually working in a foot or two of water, with more water pouring upon them. By the time the shaft was 356 ft. deep, 2400 gal. per minute was being pumped; this required six sinking-pumps in the shaft, one of which pumped directly to surface. So rapidly did the flow increase that it was necessary to cut another temporary pump-station at 348 ft. Four pumps were put here, two of which were taken from the 268-ft. station. This equipment served to complete the shaft, 100 ft. deeper, although at times the flow ran as high as 3500 gal. per minute. When the permanent pump-station was being cut, the flow was 4000 gal. per minute. During this work a Cameron pump and one of the sinking pumps were put in the entry, both of which discharged to surface. The large number of pumps made the shaft uncomfortably warm. A permanent pump-house of steel and concrete-slabs was built at 438 ft. depth, broken rock being filled between the concrete-slabs and the solid rock. Before this lining was erected, it was almost impossible to see from the centre to either end of the pump house on account of the torrents of water falling. After the double-pitched roof was erected the room was practically dry. The permanent pumps installed were two 16 and 32 by 8 by 36-in. Prescott, corliss, cross-compound, crank-and-fly-wheel units, each with a normal capacity of 1500 gal. per minute and a maximum capacity of 2200 gal. per minute against a head of 450 ft. This type is economical of steam; its guaranteed duty is 135,000,000 foot-pounds of delivered work per 1000 lb. of dry steam consumed (of 125-lb. gauge pressure), the vacuum being 26 in. of mercury. Each pump is supplied by a 5-in. steam-line and discharges into a separate 14-in. pipe. The pipes can be cross-connected, so that either engine can take steam from either steam-pipe and discharge into either column. An auxiliary pump is also set in the entry for use in emergency.

CEMENT PRODUCTION of the United States in 1915 amounted to 85,914,907 bbl., a decrease of 2.6%. Stocks at the end of the year were 11,781,166 bbl., a reduction of 7.8%. The average price at factory last year was \$6c. per barrel, ranging from 69.9c. in Pennsylvania to \$1.375 in California.

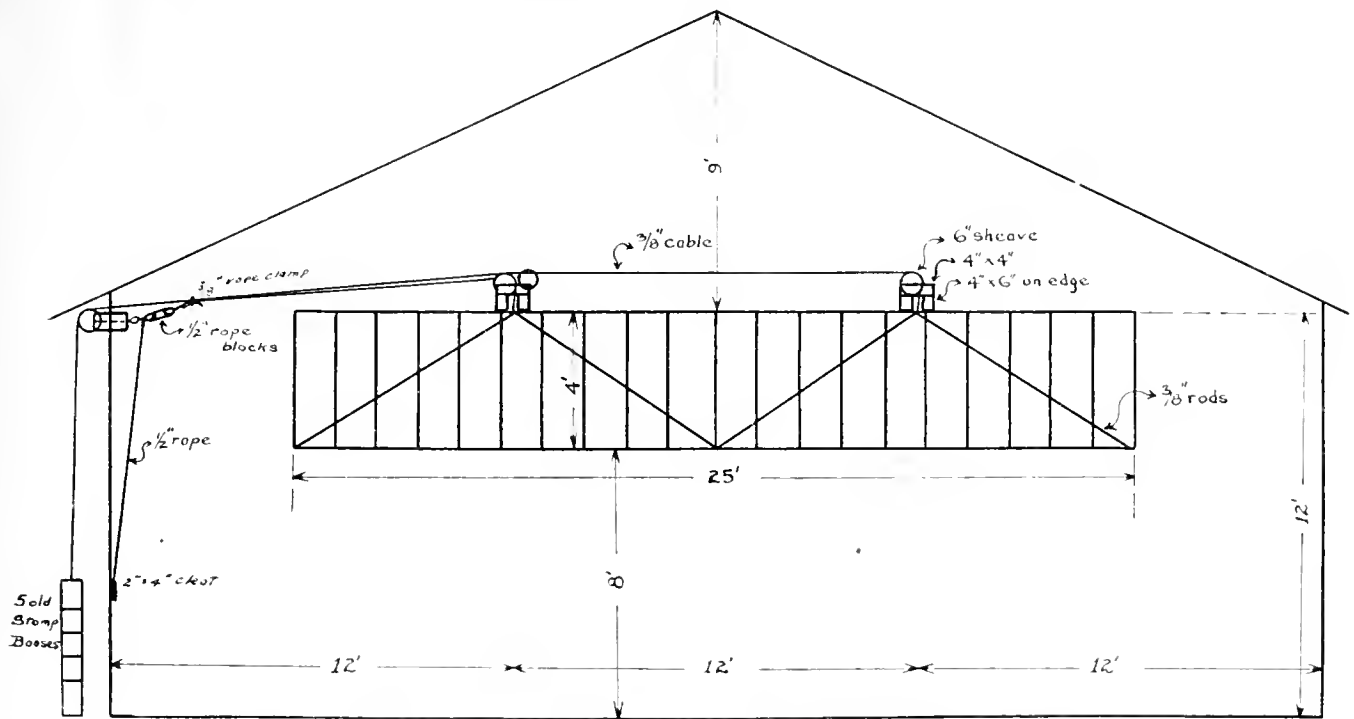

SECTION OF DRY-HOUSE, SHOWING ARRANGEMENT FOR RAISING AND LOWERING LOCKERS.

A New Dry-House

By R. E. Tremoureaux*

A new dry-house was built at the Champion mine, Nevada City, California, in November 1915, to accommodate 320 men, at an approximate cost of \$8 per man. The house is built on a level waste-dump, with concrete walls four inches above the floor-level. The floor contains 2160 square feet of concrete put in at the following cost per square foot:

| | |
|--------------------|----------------|
| Labor | \$0.044 |
| Supplies | 0.069 |
| Total | \$0.113 |

The floor is built with a grade to the centre of the shower-baths. The building is 36 by 60 ft. and 12 ft. high, with a 9-ft. rise in the roof. The building contains 5254 board-feet of lumber, built at the following cost per M board-feet:

| | |
|--------------------|----------------|
| Labor | \$14.80 |
| Supplies | 21.20 |
| Total | \$36.00 |

The roof and sides, having 5407 square feet of outside surface, including doors and windows, cost per square foot:

| | |
|--------------------|----------------|
| Labor | \$0.008 |
| Supplies | 0.143 |
| Total | \$0.151 |

The house is built to contain 8 sections of suspended lockers, each locker containing 40 compartments. The lockers are counter-balanced on the outside of the building and can be raised and lowered easily by one man. When raised the bottom of the locker is eight feet from the floor. There are four showers in the main room and one in the foreman's office. The wash-stands are built along the sides of the showers. The dry is heated through 2-in. pipe-radiators, by an Ideal hot-water boiler. The total summarized costs are as follows:

| | Labor | Materials and supplies | Total |
|----------------------------|-----------------|------------------------|------------------|
| Grading | \$ 19.50 | | \$ 19.50 |
| Concrete walls | 19.13 | 25.50 | 44.63 |
| Concrete floors | 93.75 | 149.55 | 243.30 |
| Building | 77.75 | 111.39 | 189.14 |
| Roof and sides | 41.50 | 779.08 | 820.58 |
| Windows and doors | 29.00 | 1.06 | 30.06 |
| Lockers | 217.50 | 237.84 | 455.34 |
| Ideal boiler erection..... | 12.63 | 200.30 | 212.93 |
| Boiler radiators | 103.75 | 120.55 | 224.30 |
| Hot-water boiler | 13.37 | 20.80 | 34.17 |
| Electrical work | 20.98 | 10.00 | 30.98 |
| Showers | 25.38 | 41.22 | 66.60 |
| Foreman's office | 11.75 | 7.50 | 19.25 |
| Pipe work | 20.62 | 36.65 | 57.27 |
| White-washing | 24.50 | 3.20 | 27.70 |
| Sundry | 38.75 | 2.63 | 41.38 |
| Superintendence | 60.00 | | 60.00 |
| Totals | \$829.86 | \$1747.27 | \$2577.13 |

*Assistant superintendent, North Star Mines Co., Grass Valley.

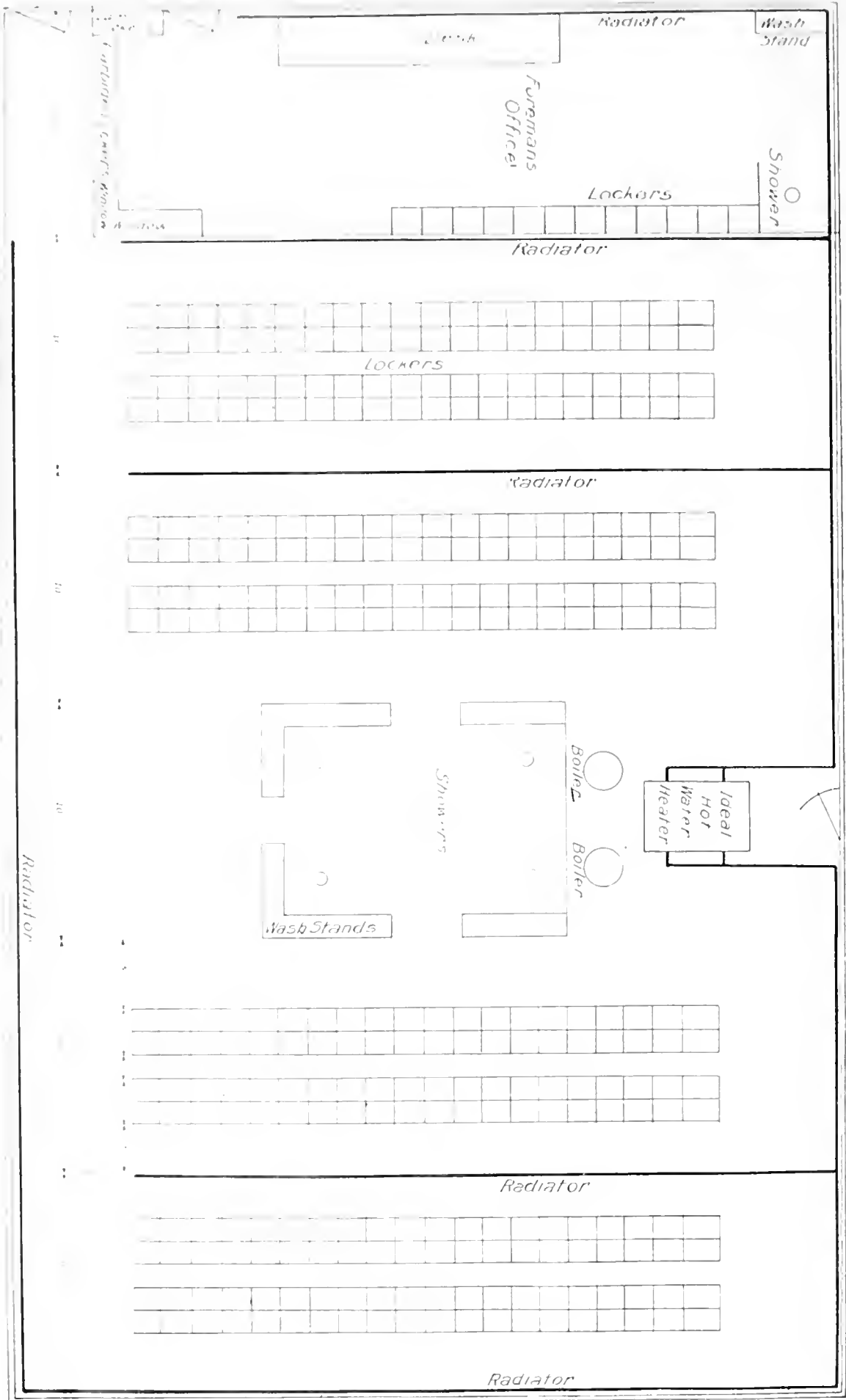

PLAN OF CHAMBER MINE 1000 FT. ST., NAVAJO CITY, ARIZONA.

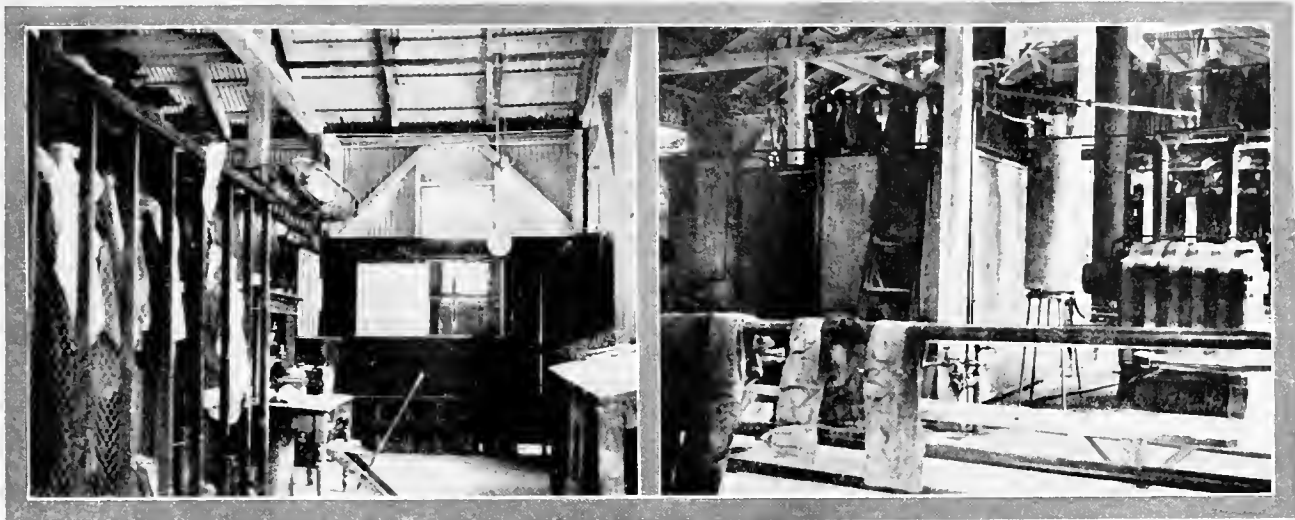

VIEWS INSIDE THE DRY-HOUSE AT THE CHAMPION MINE, SHOWING LOCKERS AND HEATER.

The lockers are made with $\frac{3}{4}$ -in. pipe and rail fittings, forming a rectangular frame 4 by 25 ft., divided into 20 small rectangles 4 ft. by 15 in. The compartments are made by screwing 12-in. pipe-nipples into the corners of the small rectangles and on both sides of the main frame. The 40 compartments, 4 ft. by 15 in. by 12 in., thus formed, are separated by wire-netting. Round iron rods, $\frac{3}{8}$ in. diam., made with an eye on one end and threaded on the other end, are used to brace the lockers to the two points of support. The eye slips over the $\frac{3}{4}$ -in. pipe and the threaded end goes through an iron plate, with an eye riveted in the centre of the plate. A $\frac{3}{8}$ -in. wire-rope clamped through the eye in the plate

runs from the right-hand support over a sheave directly over this point of support, then over a sheave over the left-hand support, then over a sheave on the wall-plate of the building. The weights are hung on this rope. A shorter $\frac{3}{8}$ -in. wire-rope, clamped to the eye in the left-hand support-plate, runs over a sheave directly over this point of support, and is then clamped to the rope from the right-hand support. A loop is left, where the two ropes are clamped, for the $\frac{1}{2}$ -in. rope-blocks to fasten to. An eye-bolt in the wall-plate of the building takes the other end of the rope-blocks. When the lockers are raised the end of the $\frac{1}{2}$ -in. hemp rope fastens to a cleat on the side of the building.

Hiring, Handling, and Firing Men

By E. F. Irwin

*After being in charge of the Employment Department of the Homestake Mining Company for 14 years I feel that if I could put the results of such experience in suitable words it would be of inestimable benefit to the students ready to begin active work in the mining world. An education along technical lines generally misses one of the greatest problems of success in mining, the human element, the handling of men. Two-thirds of the money spent in mining goes for labor. To get the best there is for that money means the study of human nature, to become acquainted with the men applying for work, and to be able to pick and choose so that the result will be a force of efficient, intelligent, and ambitious men.

I put efficiency first. To get the work done and done well, the first question is whether the applicant is physically sound and has a reasonably long life ahead of him. Working in mines is hard work at the best and it would

be poor judgment to hire a man who has given the better part of his life to previous employers. Look to the future as much in judging physical qualifications as in mental.

Intelligence is so obvious that it needs not be dwelt upon, only that in employing day laborers one is apt to think the bigger the man the more work he will turn out, losing sight of the fact that he may never be able to take a position above the pick and shovel and thus you are closing one place where an intelligent man would profit by the experience and be made into a skilled workman, ready to go higher when needed.

Ambition in a man is worth more than any other qualification. It is the spur that constantly goads him on, making hard work and poor surroundings bearable, when he knows that overcoming such obstacles better fits him for the positions higher up. Ambition fosters determination and an iron will that never admits failure. When a man says he is willing to do anything to get a start he will make a good man anywhere. Encourage

*From the *Pahasapa Quarterly*, published by the South Dakota School of Mines.

ambition in your men by promoting the most efficient, thus showing other employees the reward to be gained by ambition regardless of length of service.

Hiring men is a constant study of human nature. Talk to an applicant, ask him questions, draw him out to talk of himself. If he has been wandering all over the mining world, and is anxious to tell how many different places he has worked, he will not make a steady employee, not worth keeping a steady man out for. Do not depend on first impressions as to shifty eyes, nervousness, or inability to talk fluently. Some of the best men's eyes are constantly moving while they are talking, and many a rogue cultivates a steady gaze. In asking questions rapidly no man can deceive you long. You will see his mental activity in making up answers showing in a hesitancy of speech, a mental grouping of the best things to tell and what to conceal. Weigh all these things in your mind before judging and do not let prejudice influence you too much. While the man does not impress you very favorably he may have good qualities that can be brought out and cultivated. Hard luck stories denote an unstable man. The man who must have work immediately or starve usually is telling the same story to another mine official in another state in thirty days.

Be optimistic. Overlook the minor faults and try to bring out the good points in your men. Every man will respond to encouraging words, while sarcasm and short, ugly tones in giving orders antagonize the men. Do not try to impress men with your authority. The fact that you are in charge is sufficient evidence that you are 'boss.' To illustrate this point: A party of sightseers, among them some young ladies, were visiting a large rock quarry. They were very much interested in the work, the machinery, the blasting, and other things. After the trip one gushing young lady addressed the foreman:

"Mr. Flamigan, this is wonderful, wonderful; but how is it kept going; who looks after it all; who is the boss here?"

"I am ma'am."

"Indeed, but it does not seem possible."

"Do you doubt it? Jimmie, come here! (Jimmie comes. You're fired.)"

So Jimmie, in order that the lady might be shown who is boss, is out of a job and a new man has to be employed and broken in to take his place.

Every man employed should be watched and studied carefully, to see if he comes up to your estimate of him, and if not, make a mental note of where you were mistaken in hiring him and avoid it in the future. Be enthusiastic in your work; get that spirit among your men, and your future in the mining world is assured, even though you were not at the head of your graduating class.

When you have employed a good working force use your best endeavors to hold them together. Do not conclude, if a man quits or is discharged, you can easily get another. You lose on every change. Breaking in

new men costs money. If the man you lost was a good man your chances of getting another good one to take his place are about one in five. In other words, you will hire five average men to get one thoroughly dependable. This may sound contradictory, when you have used your best endeavor to hire good men, but good men are always in demand. They are kept when hired and the floating class you get your men from are usually the ones from other places where they failed to make good.

The social welfare of your men is just as important an item as the machinery to work with. Laborers must have diversion. The periodical drunken carouse was formerly, and, as much as we regret it, is today to some extent, the diversion of miners. But it is being replaced by means of recreation. The Homestake company has a large recreation building containing a library, theatre, pool and billiard room, bowling-alleys, gymnasium, rest-room, and swimming-pool, and it is a good investment. The men are better for it, and some way of diverting the men's mind from the continual grind of daily work should be provided at every mine.

Bear in mind that hiring is the first, handling second, and 'firing' last and least. Good hiring and handling leave little cause for 'firing.' Finally, when you have to discharge a man talk to him plainly and frankly. Try to have him understand where he failed, as you see it. He may profit by the talk, and the plain statement of it from your point of view makes a better man of him when he starts again. When 'firing' do not consign him to the job of everlasting firing in the hereafter. He may make good elsewhere and then you will regret your failure to make a good employee of him while you had the chance.

Summing up: "Do unto others as you would that they should do unto you."

Dredging in Colorado

At Breckenridge in Summit county three boats are operated by the Tonopah Placers Co., a subsidiary of the Tonopah Mining Company of Nevada. During the year ended February 29, 1916, the following results were obtained:

| | |
|---|-----------|
| Ground dredged, cubic yards | 3,242,247 |
| Ground dredged, acres | 53.175 |
| Ground remaining undredged, acres | 4,782.918 |
| Gold recovered, ounces | 23,034 |
| Silver recovered, ounces | 5,416 |
| Value, cents per cubic yard | 14.7 |
| Cost, cents per cubic yard | 6.1 |
| Operating profit | \$211,693 |
| Dividend paid (initial of 5%) | 50,000 |

SHIPPING DIFFICULTIES, from lack of ships, and the extraordinary increment in the rates for ocean freight is indicated graphically by the fact that for long voyages such as from New York to Chile or from San Francisco to Japan, the cost of chartering a steamer for a single trip is now as much as the purchase price of the steamer before the War.

Ozokerite in Utah

By L. O. Howard

INTRODUCTION. Ozokerite, although brought into the daily life of millions of people, is a rare hydrocarbon found commercially only at Boryslau, in Galicia, and in eastern Utah. It is associated with bituminous shales and sandstones, clay-schist, gypsum, and salt, usually near petroleum springs. The chief use of it is for the production of ceresin (or white wax), although the poorer varieties are distilled for liquid hydrocarbons. The color of ozokerite is from transparent yellow or greenish, in the finest varieties, to black. The best grade can be easily kneaded. The crude Galician is scaly and waxy, with resinous fracture, brittle, and hard as beeswax. Friction induces a negative electric charge and produces an aromatic odor. Inferior varieties are black and soft, or hard with a fibrous structure and conchoidal fracture; others have the hardness of gypsum and are dichroic, transmitted light being yellow, and reflected light dark-green.¹ The melting-point is between 58° and 100°C.

The Utah mineral is semi-brittle, slightly friable, cuts easily but does not adhere to the knife, cannot ordinarily be worked between the fingers, and is black, with occasional brown resinous portions. The melting-point varies from 54°C. (for an entirely black material with a pronounced petroleum odor, easily molded, and soluble in boiling ether) up to 65° (for a pure variety, usually yellow, completely soluble, and with a faint odor) and to 70° for the Colton product, which is incompletely soluble and odorless. The greater softness and lower melting-point of some specimens is caused by a larger content of bitumen and asphalt.² Where an excessive amount of bitumen is present, the ozokerite is of little value. Many reported discoveries have had this defect.

THE GALICIAN DEPOSITS. These are in the Carpathians at Boryslau, a town 40 miles south-west of Lemberg. In 1821 the first licenses were granted for working ozokerite or 'mountain tar,' but the important discovery was not made until 1854. The first distillation for the production of paraffin was in 1862. Numerous shafts were sunk by individuals, and in the '60s all the aspects of a mining boom were exhibited. Jociusky estimated the number of shafts in 1865 at 5000 to 6000 for a total output of 2250 tons. In 1881 production had risen to 10,000 tons per annum. The number of operators decreased later although the production reached a maximum of 12,300 tons in 1885. This was limited to an area of 240 acres. Stealing was common, some estimates placing the amount thus taken from 1862 to 1890 as worth \$1,200,000.

About 1885 the Government regulated the industry. A Viennese bank was given a practical monopoly. The production from 1898 to 1901 is stated as 18,248 metric tons, declining from 7759 tons in 1898 to 2707 tons in 1901.³

Galloway has given an interesting description of the origin, occurrence, mining, and refining of ozokerite at Boryslau, where it occurs in Miocene strata, from the surface to depths below 1500 ft., in association with petroleum. He states: "Ozokerite has obviously been deposited from petroleum during the flow of the liquid from the surface over beds lying at a greater depth than that in which ozokerite is now found."⁴ The decreasing temperature of the oil caused the wax to precipitate near the surface in the form of scales, sheets, and masses, in the interstices of debris, sometimes embedding huge blocks of stone. Some liquid petroleum flows through the drifts, and ventilation must be carefully watched to avoid disastrous accumulations of the explosive carburetted hydrogen, which is given off in large amounts.

The ozokerite is found in three veins, one of which is 30 ft. wide, and is crossed at right angles by two others, 4 to 5 ft. wide. An attempt is made to sort the mineral underground. The waste is hoisted in sheet-iron cars, run upon a tippie and dumped into chutes from which other cars distribute it on the dump. The low-grade material goes to a second tippie and thence by chute to the melting-house. The high-grade is taken to a locked room, where two men sort it into two classes, for melting. The re-sorted high-grade is dropped through chutes to one set of melting-pots, the lower-grade joining the second-class from the mine. The different classes are melted in water in cast-iron pots, the purer material requiring less water than the lower grade. There were 46 of these pots, 4 ft. diam. by 3 ft. deep, to which heat was applied by flues passing underneath. The 'pulp' separates into three layers: melted ozokerite at the top, silt and waste at the bottom and water between. The ozokerite is ladled in 1½-2-gal. cans into wooden launders delivering to two wooden vats, 8 ft. diam. by 7 ft. deep, in which the sediment is allowed to settle more thoroughly. The purified ozokerite is cast in iron molds, which are 2 ft. deep and taper from a diameter of 12 in. at the top to 10 in. at the bottom. After cooling, the cakes are dumped and marketed. The second class material receives two treatments of this kind, being added to the high-grade after the initial purification. The works are closely guarded by fences and gate keepers.

³'Mineral Statistics,' Home Office, Part 4, Colonial and Foreign Statistics, Great Britain.

⁴W. Galloway, South Wales Institute of Engineers, Proceedings for 1902-1904, page 223.

¹Allen, 'Commercial Organic Analysis,' Vol. 2, Part 2.

²Taff and Smith, 'Ozokerite Deposits in Utah,' U. S. G. S. Bull. 285, pp. 369-372.

THE OZOKERITE DEPOSITS are near the north end of the Wasatch plateau in Utah county, near the D & R G. railroad, 90 miles from Salt Lake City. The belt has a north-west trend, extends 11 miles, and is as much as two miles wide, the southern boundary closely paralleling the railroad from a point east of Colton, up the valley of the Price river to Soldier Summit, and down the west slope of the range.

The economic deposits are in sections 13, 14, 15, 22, and 25, T 11 S, R 8 E, and section 30, T 10 S, R 8 E, and sections 20 and 21, T 10 S, R 7 E. The pioneer work was done by R. J. Kroupa in 1886. Five mines were equipped and three separating plants erected. The three principal showings are near Colton on the north side of the Price River valley; just east of Soldier Summit, and near Media station, on the north side of the canyon close to the source of Soldier creek, west of the summit. Soldier Summit is 7 miles north-west of Colton, and Media is 3 miles west of Soldier Summit. Colton and Soldier Summit are in the broad flat channel of the Price River valley.

Taff and Smith in 1905 published the only geological information that has yet appeared. The deposits occur in limestone, shale, and shaly sandstone in the lower part of the Tertiary deposits of the Wasatch group. Woodruff and Day give a section of the Eocene 25 miles south-east of Colton. At the bottom is the Wasatch formation, 1000 to 1000 ft. thick, consisting of sandy shale, and sandstone of irregular deposition and variegated colors. Overlying it is the Green River formation, the lower member, 1000 to 1125 ft. thick, consisting of sandstone, shale, and oolite, the sandstone occurring in beds 1 to 15 ft. thick. The shale is sandy, locally calcareous or bituminous, and evenly bedded. The middle member, 100 to 700 ft. thick, consists of thin beds of shale, some of them bituminous, and thin beds of calcareous sandstone. "This member is remarkable for the uniform thin bedding and for the large amount of bituminous matter which some of the beds contain." The upper member is a thick-bedded sandstone, sandy shale, and clay-shale, 500 ft. thick.

Accepting the stratigraphy of Taff & Smith and Woodruff & Day, it is evident that the ozokerite beds are in a formation just below that including the great oil-shale deposits of eastern Utah. The association is suggestive. So far as known, ozokerite does not occur in the immediate vicinity of the oil-shale. The association of Galleian oilfields with the Boryslau ozokerite furnishes a possible parallel.

In Utah, the ozokerite is found at various positions in the Wasatch formation. The shales are friable, the sandstones moderately soft, and the limestone beds thin and brittle. Limestone occurs both above and below the ozokerite. The beds are uniformly tilted at 5° to the north-east. So far as known there are no faults of great throw. Fissures and zones of brecciation and parallel jointing intersect the strata. In these fissures and in-

terstices, ozokerite has been deposited in thin sheets and films, and locally as masses of some size. The faces of the fissures and brecciated portions generally show slickensides, as the ozokerite frequently does. The vertical displacement is, however, slight. The fissures and joint planes are almost vertical, bearing N 10° W near Colton and Soldier Summit. A half mile west of Media is a fracture-zone bearing N 30° W, and a half mile north-east of the same station is one bearing N 60° W. Both are almost vertical. The thickness of the deposits is variable, both vertically and horizontally. All of the deposits are within two or three miles of the railroad, with good wagon-roads and easy hauls.

At Colton station a shaft was sunk 110 ft. on a vertical shear-zone, 5 to 6 ft. wide. Drifts were driven at 15 ft. deep and at the bottom. Ozokerite occurs as scales or thin veins. Only a small production was made here.

Near the south-west corner of section 13, T 11 S, R 8 E, 1½ miles north-east of Colton, is a different fracture-zone, 500 ft. higher in the strata. At the time of Taff and Smith's examination, development consisted of an adit driven 225 ft. N 10° W on a shear-zone 4 to 6 ft. wide. From the end of this adit a drift was run 125 ft. east. At a point 65 ft. east of the adit a vertical fracture-zone was crossed. A shaft had been sunk at the mouth of the adit to a depth of 100 ft., and north-south drifts run at 60 ft. Small quantities of ozokerite were found here and there, as thin films along the joints. This property was developed further by the American Ozokerite Co. in 1912. It was known as the Pleasant Valley group, and consists of 12 lode-claims and a mill-site. The shaft was deepened to 180 ft., and a lower adit run 860 ft., or 640 ft. beyond the shaft. The upper adit was extended to 540 ft. This development resulted in the discovery of larger masses of ozokerite. In both the upper and lower adits the vein is 3 to 6 ft. wide. Ozokerite permeates the vein, sometimes in small lenses and sheets. The content varies widely, up to 15%. The zone has been traced about a mile, showing ozokerite distributed irregularly.

The rock was drilled with augers and a low explosive was used for breaking. All ore was taken out through the lower adit to the company's 30-ton mill. The property has been idle since 1912, but is fully equipped with power, shops, offices, and dwellings.

About a mile north of Colton near the north side of NW ¼ sect. 14, T 11 S, R 8 E, is the James Peak group of six claims. An adit follows a line of vertical fractures extending N 10° W, in which ozokerite occurs in thin sheets and small fragments. Prospects show the presence of ozokerite at various points along the zone. Other prospects that show the wax are in the SE ¼ SE ¼ sect. 14 and NW ¼ SE ¼ sect. 15, and a limited amount of mining has been done in SW ¼ NW ¼ sect. 24, T 11 S, R 8 E, on similar north-south lines of fissured and jointed rocks.

The deposits at Soldier Summit are limited to the NW ¼ sect. 30, T 10 S, R 8 E, within a half-mile east and north-east of the station. This property has been

acquired by the newly organized Wasatch Ozokerite Co. and is under development.

The mine is opened by a shaft 255 ft. deep, on a band of vertical fissures containing ozokerite, and by drifts at 44 ft., 98 ft., 140 ft., and 250 ft. The longitudinal section illustrates well the selective nature of the mining and the necessity for many working-faces. The ore is drilled with augers and broken by back-stopping. The ozokerite is found in veinlets in narrow fissures in the strike of the crushed strata and surrounding the brecciated shale and shaly limestones, with local swellings to 30 ft. Close and careful timbering is necessary. The 44-ft. level is extended to the surface and has been used as a haulage-adit. During the early development gas explosions were troublesome, so that it became necessary to obtain a better circulation of air. An air-shaft was put up from the 98-ft. level to the surface, and raises at frequent intervals now connect all the workings.

A 40-ft. head-frame is to be erected over the main shaft. Ore will be hoisted to the surface and trammed 70 ft. to the mill. Waste will be taken out through the 44-ft. adit and distributed on the dump below the mill. Development will proceed especially in the block of ground between the 140-ft. and 250-ft. levels, enough ore being anticipated from the upper levels to keep the mill operating at its intended capacity.

Two small mines have been prospected near Media in vertical fissures in shale. One is a half-mile west and the other a half-mile north-east of the station. The first zone is $2\frac{1}{2}$ ft. wide and strikes N 30° W. The other is 4 to 5 ft. wide and strikes N 60° W. The ozokerite occurs in places here in the same way as at Colton and Soldier Summit.

SEPARATING THE WAX. The practice has been to crush the soft rock and ozokerite mixture, and deliver it to long narrow-bottom steam-jacketed vats with water at a temperature of 54 to 70°C. The wax melts and floats off to cooling-vats, the residue being moved along the bottom by a screw-conveyor. The plant of the American Ozokerite Co. was well equipped, but did not operate to the entire satisfaction of the company. It was situated below the lower adit. Ore was trammed to a 300-ton bin, from which it was fed over grizzlies having 1-inch apertures to a Gardner crusher having a capacity of 25 tons per hour. The fine material was fed automatically to two vats, in which it was agitated with boiling water. After agitation the pulp went to three long V-bottom vats in which the boiling continued, the molten wax being removed by 4-ft. skimming wheels delivering to two settling-tanks, where a further boil of an hour was given. In these tanks the remainder of the dirt was eliminated. The clean wax went to a 5-ton refining-tank for the removal of entrained moisture and was then cast into 10-lb. cakes for the market. Four

grades were made, hard prime, high prime special, hard green, and soft wax.

The tailing was carried to the dump by a belt-conveyor. One of the difficulties of the process was the high fuel consumption owing to the large radiating surface. A boiler capacity of 85 hp. was used in the production of $1\frac{1}{2}$ tons of wax per day. It was also found that the positive feed and discharge of the melting-vats was a drawback to efficient operation, giving no opportunity to regulate the discharge according to the condition of the residue. In the new plant nothing will move forward until its treatment in a particular portion of the apparatus is finished.

At the mill the ore will be dumped over a grizzly to a

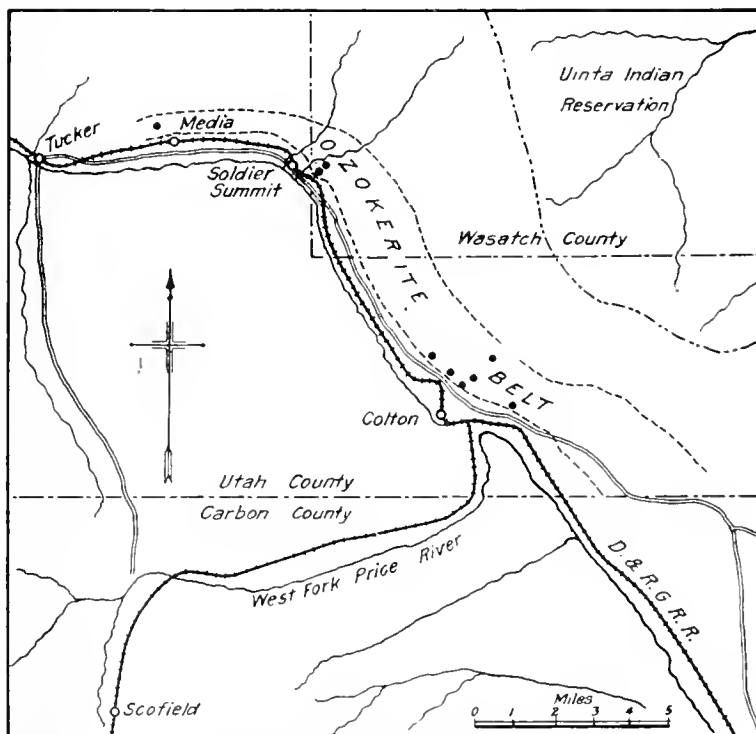

THE OZOKERITE BELT OF EASTERN UTAH.

Williams crusher, set flush with the top of the fine-ore bin into which it will discharge. This bin will be 15 by 20 by 15 ft., with a V-bottom. The ore, crushed to $\frac{1}{2}$ -in., will be delivered by automatic feeder to the first treatment tank, or 'digester,' a closed cylindrical iron tank, with conical bottom, 30 in. diam., and 6 ft. 1 in. deep over all. It is provided with a mechanical stirring device having four arms, and is steam-jacketed.

The digester has a capacity of 800 lb. of ore plus sufficient hot water to fill the tank. The average time of treatment is 30 minutes. A preliminary separation will be made into impure wax and middling. The process will be practically continuous, molten impure wax being drawn off at the top of the digester to a steam jacketed conical iron tank, $4\frac{1}{2}$ ft. diam., set at a lower level, the middling dropping through a pipe with gate-valve to a cleaning-tank set directly underneath the digester. This tank is cylindrical with flat bottom, 3 ft. diam. and 4 ft. high. It is provided with a revolving plow driven by a

central shaft and is steam-jacketed. The products of this tank will be three: clean wax at the top, silt and coarse rock at the bottom, and a mixture of these two with hot water in the middle section. Clean tailing will be made to discharge through a pipe and valve to a car operating in the tunnel beneath the mill. The wax from the top will join the wax from the digester in the conical cleaning tank. The middle layer will be drawn off by centrifugal pump and delivered to the digester near the bottom. The conical tank may be regarded as a concentrate-cleaner. Here the wax and hot water from the two preceding tanks will be subject to a further cleaning without agitation. Three products will result: a clean wax, a clean tailing, and a mixture of hot water, wax, and silt, which will be pumped back to the digester. The pure wax, with some hot water, will overflow to a shallow, round-bottom, open, steam-jacketed tank for the removal of entrained water, which will be pumped to the top of the digester, the last traces being finally removed by evaporation. The 'dry' wax will be molded for the market. This unit will have a capacity of 20 tons of ore per 24 hours. The extraction is nearly perfect. Provision has been made for the addition of other units when needed.

Steam is furnished to the jackets and the hoist by two locomotive-type boilers, with a total rated capacity of 100 hp. It will be noted that the water used for melting the wax is retained in closed circuit. Deficiencies due to evaporation will be balanced by supplying fresh water to the digester from the feed-water heater.

The rate of flow through the apparatus is subject to easy regulation, and radiation losses have been reduced to a minimum, thus overcoming the two principal disabilities of the old process. As stated, this unit was assembled and thoroughly tested, so that the company has no doubt as to its satisfactory operation when installed at Soldier Summit. Incidentally this type of plant has been found suitable for other separations, involving leaching, or more properly, digestion, one suggested use being the extraction of potash from alunite.

PROPERTIES AND USES. After separation from the gangue, ozokerite may be treated with alkali and filtered through animal charcoal, Fuller's earth, or magnesium silicate. If sulphuric acid be used for purification there

is a large loss of product. Peritz, in refining Boryslau ozokerite, secured 75 to 82% of crystallized paraffin (ceresin) and 9 to 18% of light oils. Inferior ozokerite may be distilled with superheated steam, yielding paraffin, lubricating oils, and naphtha. This paraffin should be distinguished from that obtained by filtration purification, to which the name 'ceresin' should be confined. Galician ozokerite yields, on distillation, 38% solid paraffin, 21% lubricating oil, and 25% petroleum. The

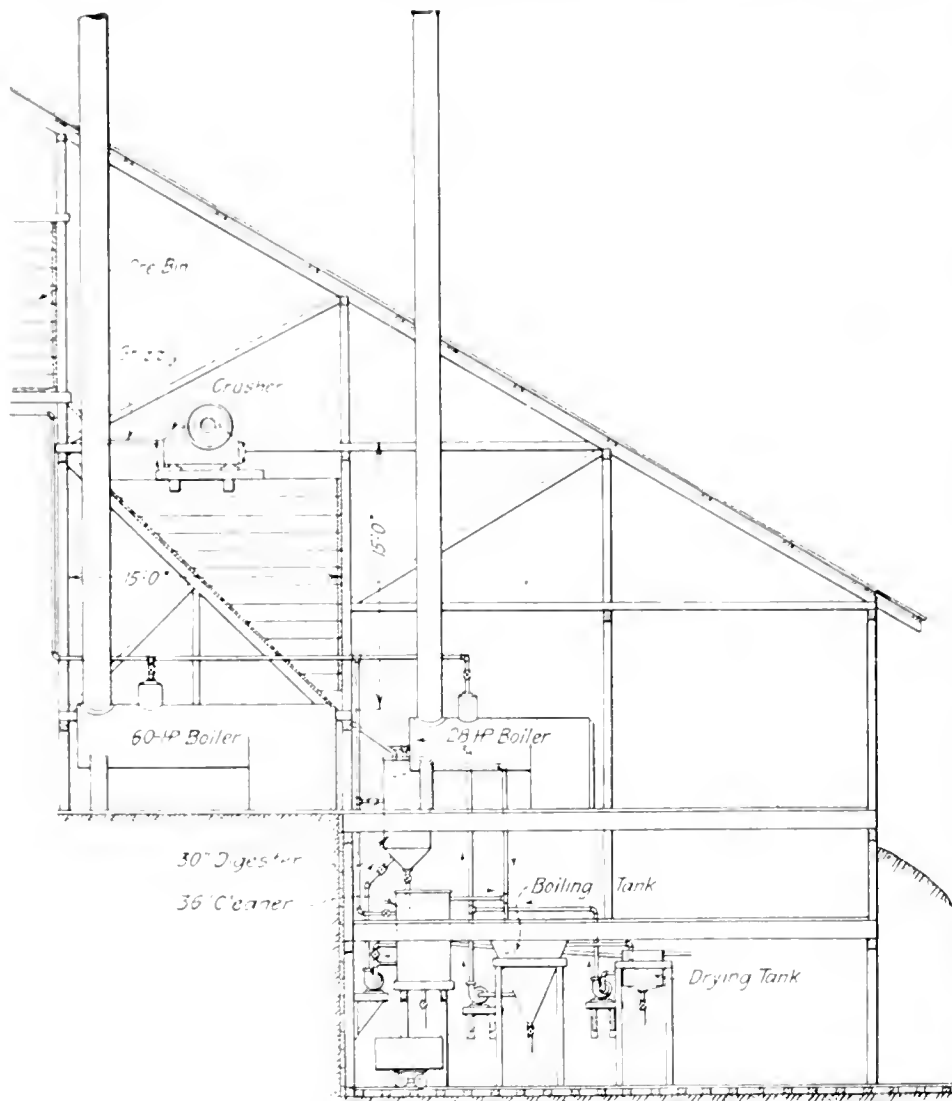

SECTION OF PROPOSED MILL FOR THE WASATCH OZOKERITE CO., UTAH.

paraffin may be dissolved by boiling in ether and purified on charcoal to a product containing 85.1% carbon and 14.57% hydrogen.⁶

The crude ozokerite is generally purified by one of the methods of filtration preceded by alkali treatment. The residue is distilled for paraffin, leaving a final residue of ozokerite pitch. At 150°C. a burning oil comes over. The fraction 200 to 300° consists of heavy oils and paraffin, which is worked for vaseline. The chief yield of paraffin is in the fraction 300 to 350°. The average yield at Boryslau has been given by Allen¹ as 6% of light oils up to 150°, 32% of heavy oils at 150 to 300°, 55% of paraffin.

⁶Beitstein & Weigand, Jour. Chem. Soc., Vol. XLIV, p. 1073.

Ceresin melts between 61 and 78°; it is odorless, colorless, has a waxy section, is hard but not brittle, and plastic without softness. It possesses the general properties of paraffin wax. Its specific gravity is lower than that of beeswax, from which it may be further distinguished by the absence of saponaceous matter. Ozokerite vaseline is produced by repeated filtrations of ozokerite through animal charcoal, followed by distillation for 3 to 4 hours with superheated steam at 250°. By this process 25 to 30% of vaseline is produced.

Ozokerite products are used for water-proofing, including waxed paper for packages; for dynamite cartridges, wrappers for soap, for lining barrels and kegs and acid-tanks; for wax candles, dolls, imitation-alabaster statuettes, decorations for confections; for liniments, salves, and plasters; for sealing jars; life-preservers, boot-blackening, varnish, shoemaker's wax; in electro-typing; for phonograph records, buttons, water-proof crayons, artificial honeycomb; as the base of many lubricating compounds, from axle-grease to gun-oil; and for pencils for writing on glass. The largest single uses are for insulating electric cables, as ozokerite pitch, and for manufacturing 'hard rubber,' such as that employed for telephone transmitters and receivers. Its increasing use is due to the ease with which the material may be manipulated, incorporated with resins, fats, and oils, by simple melting, or stained any desired color, together with the power of resisting acids. Much of the common beeswax is either pure ceresin or beeswax adulterated with it.

Before the War, there were 20 ceresin plants in operation in Germany and Austria, and none in the United States. The Austrian exports for the six years 1894-99, were 27,000,000 lb. of refined wax, and 57,000,000 lb. of crude. In 1898 the production was 17,100,836 lb. of which over 4,000,000 lb. was used in Austria. An estimate of the Austrian production from 1854 to 1910 is 662,500,000 lb. Imports into the United States in the decade from 1883 to 1892 amounted to 10,791,500 lb., ranging from a yearly importation of 565,000 to 1,870,000 lb. In 1908 imports totaled 3,595,393 lb. In 1910 nearly 8,000,000 lb. was imported and about the same amount in 1914. The total for the 5-year period, 1910-14, was 34,000,000 lb.⁷

The price of the Austrian product in the United States rose from 6 cents in the '90s to 15c. before the War. Since that time the price has soared to 45c. per lb., and it is reported that electro-typers have offered 75c. to \$1 per lb. Prospects are bright for the development of the Utah district.

PHOSPHATE ROCK sold in the United States in 1915 was 1,835,667 long tons, valued at \$5,413,449. This is a decrease of 898,376 tons, due to exports to Germany being stopped. The output came, as usual, principally from Florida, Tennessee, and South Carolina; but there was a small output from Arkansas, Idaho, Utah, and Wyoming, according to the U. S. Geological Survey.

Increase in Cost of Mine Supplies

Among the interesting information given in the report of the Hollinger Gold Mines, operating at Porcupine, Ontario, for 1915 is the following comparison of prices for supplies at the beginning of the War and at present:

| MINE SUPPLIES | Price | | Advance, % |
|-------------------------|-----------|-----------|------------|
| | Aug. 1914 | Mch. 1916 | |
| Material and unit. | | | |
| Connecting wire, lb. | \$0.50 | \$0.70 | 40 |
| Dynamite (40%), cwt. | 13.10 | 19.70 | 50 |
| Dynamite (50%), cwt. | 14.60 | 22.45 | 52½ |
| Detonators, 1000 | 12.60 | 39.70 | 215 |
| Fuse (safety), case | 23.95 | 28.20 | 18 |
| Fuse (time), 1000 | 5.40 | 10.25 | 90 |
| Rails, ton | 43.00 | 57.50 | 33 |
| Shovels, doz. | 7.60 | 9.00 | 18 |
| Steel (drill), lb. | 0.07 | 0.09 | 30 |
| Steel (hollow), lb. | 0.12 | 0.16 | 33 |
| Track-spikes, keg | 3.25 | 4.50 | 39 |
| Track-bolts, keg | 6.00 | 9.00 | 50 |
| MILL SUPPLIES | | | |
| Borax, lb. | \$0.11¼ | \$0.17¼ | 47 |
| Cyanide, lb. | 0.15 | 0.16 | 7 |
| Crucibles | 0.07½ | 0.13 | 74 |
| Cams, each | 20.26 | 23.20 | 14½ |
| Cam-shafts, each | 83.00 | 90.00 | 8½ |
| Lead acetate, cwt. | 8.10 | 14.30 | 75 |
| Liners (tube-mill), lb. | 0.03¼ | 0.03½ | 8 |
| Litharge, cwt. | 5.65 | 12.60 | 127 |
| Lead (pig), cwt. | 5.65 | 10.06 | 78 |
| Muriatic acid, cwt. | 1.70 | 2.93 | 80 |
| Pebbles (Danish), ton | 22.03 | 26.80 | 22 |
| Snoes and dies, cwt. | 4.85 | 6.55 | 37 |
| Zinc-dust, lb. | 0.06¾ | 0.27 | 427 |
| Zinc, spelter, cwt. | 6.48 | 17.25 | 276 |
| GENERAL | | | |
| Machinery and parts | | | 10 to 40 |
| Electrical equipment | | | 20 to 50 |
| Corrugated iron | | | 50 |
| Iron and soft steel | | | 50 |
| Tool-steel | | | 500 |
| Pipe | | | 60 |
| Nails | | | 40 |
| Lubricating oils | | | 10 |
| Fuel-oil | | | 51 |
| Gasoline | | | 65 |

JAPAN's foreign trade, particularly in the export of copper and war munitions to Russia, has been stated recently to have increased tremendously, yet the official figures show but little increment in the total of the country's foreign trade for 1915. Exports from Japan last year were but \$58,000,000 greater than for 1914. The total was \$304,000,000, of which only 11% went to Asiatic Russia; the United States took a much larger proportion, 29%, and China took 20%. Great Britain and India taking 16% between them. Of Japan's imports, a total of \$266,000,000, the United States supplied 20%, India 28%, China 16%, and Australia 15%. It is evident that the United States and Japan are good customers of each other; also that the British possessions and China have an important trade with Japan.

⁷Mineral Resources of the U. S. U. S. G. S. for various years.

CONCENTRATES

Readers of the MINING and Scientific PRESS are invited to ask questions and give information dealing with technical and other matters pertaining to the practice of mining, milling, and smelting.

POTASH occurs in the leucite of the lava of the Leucite hills of Sweetwater county, Wyoming, but its commercial extraction has not yet been proved feasible.

CORNER in some of the silver ore (1170 ft. level) at the Tonopah Extension mine caused an increase of cyanide consumption in the last financial year of the company.

SINCE 1880, when mining first commenced in Alaska, the Territory has produced gold, silver, copper, tin and other minerals to the value of \$300,953,751. This great mineral region was acquired by the United States in 1867 for \$7,200,000, on the advice of William Seward.

EXPLOSIVES in Rand mines are often carried in fibre bags, which are inflammable. Experiments show that when the canvas is immersed in saturated solutions of sodium tungstate, ammonium phosphate, or sodium silicate, dried, and tested, they are not liable to catch fire.

WIRE ROPES should be lubricated carefully, not hastily. The lubricant should penetrate to the hemp centre and should coat thoroughly the inside wires. Cables can be lubricated while running, if their speed at the time is not too great. They are passed through a trough containing lubricant, being pressed under the oil by hand or by passing beneath a small sheave arranged for the purpose.

SALTS containing precious metals continue to rise to the surface of tailing-dumps at Tonopah, Nevada. During the year ended February 29, 1916, 1018 tons of 'sweepings' were recovered by lessees from the Belmont ponds. This material assayed 0.343 oz. of gold and 55.92 oz. of silver per ton, and was worth \$34,328. Smelter charges on this fine stuff are exorbitant, and a plant to treat it locally is to be erected.

IN TESTING a part of the Mother Lode in Calaveras county, recently, over a length of 6000 ft., it was found that 5600 ft. of trenching had to be done, excavating 43,000 cu. ft. of rock; 1502 samples being taken and assayed, the whole operation costing \$4500. The loose dirt was first removed and then fresh rock was blasted. The trenches were 22 ft. apart when in ore, and averaged 84 ft. apart over the entire distance.

ADVOCATES of crushing gold ore in cyanide solution years ago made a great point of the saving of cyanide effected; but according to T. B. Stevens, in a communication to the C. M. & M. Society of South Africa, his experience does not confirm this. Apart from the dissolving of the gold he found that in order to obtain good

precipitation on the zinc a much higher cyanide strength is required, than when the solutions are frequently renewed by dilution, as when crushing in water; in fact he visited many plants where a high cyanide strength has been in use solely for the purpose of obtaining good precipitation.

ADVANCE in the price of silver makes the intrinsic value of silver coins a matter of interest, for, if the intrinsic exceeds the nominal value, there is always a strong possibility of coins being melted into bullion, and the refined contents being placed on the market. The Mexican silver dollar is already worth more dead than alive. Legally it is supposed to circulate as 50 cents U. S. Its intrinsic value as unrefined bullion in May was about 56c. Had not Mexico been already denuded of silver dollars owing to internal strife, the Government would have found it difficult to retain these silver dollars as currency. Should the price of silver exceed 90c, it would begin to be worth while to ship to Europe and there refine the Indian rupee, and at 92c., the Straits' dollar. The amount of Straits' dollars affected is about 12,500,000. In March 1907 the weight of this dollar was reduced from 416 to 312 grains, owing to the rise in the price of silver. An advance in the price of silver to 90c. would create a serious problem for the British authorities. Considering the size of the stock of rupees it would be impossible to recall and re-mint the metal quickly into a coin with less silver-content.

DEGREES BAUMÉ, a term which is in common use among acid and petroleum operators, refiners, and manufacturers, is likely to be confusing to those who are not acquainted with the method by which the system of units was established. For liquids lighter than water, among which are mineral oil and acids, the Baumé measurements are opposite to those of specific gravity. That is to say, the greater the specific gravity of the liquor, the lower the Baumé measurement, and vice versa. The use of the Baumé scale of gravities for liquids has given considerable annoyance as well as convenience in certain industries, especially oil. A natural and common mistake due to the use of Baumé scale is in the mixing of different gravities of oil to obtain a product of certain gravity on the assumption that the Baumé scale is a direct measure of specific gravity. The Bureau of Standards has adopted the following relation between specific gravity and degrees Baumé, for liquids lighter than water:

$$\text{Degree Baumé} = \frac{140}{\text{specific gravity at } \frac{60}{32} \text{ F.}} - 130, \text{ or}$$

$$\text{Specific gravity at } \frac{60}{32} \text{ F.} = \frac{140}{130 + \text{degrees Baumé}}$$

Some Baumé and specific gravity equivalents, as given in Redwood's 'Treatise on Petroleum,' are as follows: 10B. = sp. gr. of 1, or water; 20B. = sp. gr. of 0.9333; 30B. = sp. gr. of 0.875; 50B. = sp. gr. of 0.7778; 60B. (gasoline) = sp. gr. of 0.7368; and 90B. = sp. gr. of 0.6364. A table for acids, heavier than water, should be found in any good chemistry text-book.

REVIEW OF MINING

As seen at the world's great mining centres by our own correspondents.

PLATTEVILLE, WISCONSIN

ZINC, LEAD, AND PYRITE MARKETS AND PRICES IN MAY.

Abnormal prices for zinc ore were reduced to lower standards during May. The base range for top grades at the beginning of the month stood at \$100 to \$110 per ton, premium grades selling at the latter; second grades ruled strong and in good demand, on 52% zinc-content; low grades were eagerly sought by the refineries operating in the field. All producers were thus satisfied, and no surplus ore was found at any point in the field. About the middle of the month prices sagged appreciably, and lower-grade products experienced a noticeable indifference on the part of buyers, which increased toward the close of the month, to the point where such ore was not sought at all, and operators not connected with refineries were left out entirely, with the result that from 4000 to 5000 tons of concentrate was left in bins unsold. The base price had dropped to \$80 per ton for top grades down to \$75 per ton base for medium grades, assaying down to 52% zinc-content. Production of mine-run ore continued unabated, regardless of the steadily declining markets, and shipments compared favorably with periods of high prices. A score of new producers came into operating existence at as many different points in the field. Splendid weather and road conditions fostered operations in all branches. Mill building received an impetus on a scale unknown before. Contracts were closed for new plants in every centre of the field. A careful enquiry revealed 57 drilling-machines on exploration work in virgin and old ground.

Lead ore continued in good demand, the month opening at \$100 per ton for 80% product, declining until the close of the month to \$88 and \$93. There was little surplus ore in the field at the close of the month.

Producers of pyrite experienced a dull month in spite of commercial sulphuric acid being high. A heavy surplus was carried over.

Zinc carbonate producers, mostly in the northern districts of the field, sold a small quantity of ore in open market, the product going to the Eagle-Picher Lead Co., a recent amalgamation of large corporations. While quotations ranged from \$55 to \$70 per ton, sales were reported at \$40 to \$45 for choice ore. Production showed appreciable gains, good weather affording the incentive to miners to rig-up open-air wash-places, as this class of zinc ore cannot be cleaned advantageously during severe winter weather.

Deliveries of ore totaled 40,714,000 lb. of zinc, 944,110 lb. of lead, and 7,427,300 lb. of pyrite. The gross turn-in of raw concentrates for the month from mines aggregated 16,000 tons; net deliveries to smelters 11,600 tons. Sales were distributed among 15 buying concerns, 20,357 tons in all. The New Jersey Zinc Co. secured 28% of this. The Granby Mining & Smelting Co., although not represented on the ground, was much the heaviest buyer of high-grade refinery ores. The present situation in the field warrants the extension of separating-plants. The Benton district lead with 9360 tons of blende, followed by Galena with 2496, Millin with 2306, Cuba with 2229, Hazel Green with 1543, Linden with 1000, and Platteville with 774 tons. Cuba supplied 1522 tons of pyrite also.

Good results are reported from the Wisconsin Mining School at Platteville, of which R. Davis is director. The class of 1916 was the largest since its opening.

TORONTO, ONTARIO

HOLLINGER-ACME-MILLERTON MERGER.—MCINTYRE AND OTHER PORCUPINE DEVELOPMENTS.—GOLD AT BEATTIE.—OTTAWA MINT TO BE ENLARGED.

The merger of the Hollinger, Acme, Millerton, and other properties at Porcupine into the Hollinger Consolidated Gold Mines, Ltd., with a capital of \$25,000,000, was formally ratified by shareholders of the companies concerned at Montreal on May 15. The general manager, P. A. Robbins, was added to the directorate. The enlargement of the mill as foreshadowed in the manager's report on the consolidation will be proceeded with at once. The company has increased the wages of surface-men 25c. per day, and has revised its loyal service bonus system so as to give employees a higher percentage on their wages.—The position of the McIntyre has been greatly improved by recent rich discoveries at 700 and 1000 ft. depth. The vein on the 700-ft. level is 62 ft. wide, valued at \$14 per ton, and has been extended 140 ft. each way. On the 1000-ft. level the orebody is 25 ft. wide, valued at \$15.30 per ton. Ore reserves as of March 31, not including later developments, were estimated at 210,000 tons valued at \$2,247,000. The total bullion production of the year was \$779,990 and disbursements \$447,946.—The Hollinger Reserve has been sold to Bernard McEnaney, and diamond-drilling will be undertaken to determine its value at depth.—The Davidson, after being in litigation for some years, has been acquired by a Western syndicate, which is unwatering it.—The Schumacher mill is treating 150 tons daily. The company is now extracting ore from the 600-ft. level. Gold valued at \$23,000 was shipped in April.—The West Dome Consolidated is obtaining good results from diamond-drilling. A vein cut at 513 ft. shows 5 ft. of ore assaying \$45.—At the Success, No. 1 vein at the 20-ft. level has widened to 18 in. and assays well.

An important discovery of gold has been made in Beattie township, northern Ontario, about 3 miles from the Croesus mine. The vein is from 8 to 18 in. wide. Rich samples have been taken. C. A. Foster, of Haileybury, has acquired a controlling interest.

The Croesus in Munro township is producing at the rate of about \$1000 per day. The gold is free and easily recovered.

The Canadian government will enlarge the mint at Ottawa to meet the great demand for gold caused by the War. A new temporary building will be erected immediately adjoining the present permanent structure and the output of gold coinage considerably increased.

Metal outputs of the Province in the first quarter of 1916 are as follows: gold, 76,307 oz.; silver, 5,200,167 oz.; copper, 3644 tons; nickel, 6680 tons; pig-iron, 94,678 tons; cobalt, 450 lb. There were increases in all, gold being 31,511 oz. more. The total value was \$14,276,382, against \$9,358,210 in this period of 1915.

At Cobalt there are 2700 men employed, about half underground. Silver is higher than at any time in the life of the district. On account of general mining activity and considerable recruiting for the army there is a scarcity of labor through northern Ontario. The Union does not consider the recent wage increase sufficient.

On June 17 the Hollinger company pays \$120,000, making \$4,890,600 in 4½ years.

JOPLIN, MISSOURI

1500-TON MILL AT WEBB CITY. PLANT OF SIMILAR CAPACITY AT Picher, Oklahoma. DRILLING CAMPAIGN. NOTES

With a capacity of 1500 tons of ore per 24 hours, the No. 2 mill of the D. C. & E. Mining Co., on a 30-acre lease of the Carter land, north of Webb City, Missouri, will equal in size the mills of the Media, and the Star company's, north of Webb City, and the Granby company's Klondike mill at Granby, Missouri. The new plant is ready for operation. It is situated on a shaft started a number of years ago by Chapman and Lennan, and completed by the present company, of which J. J. McLellan is general manager. To the south-east from the mill, situated on much higher ground, is the old shaft of the Bird Dog Mining Co., to which a tramway, 75 ft. high has been constructed. This shaft is 650 ft. from the mill. The tramway is the highest in the district. North east of the mill is the old Blue Bell shaft, 100 ft. away, to which a tramway has been built. At the mill shaft and at the Blue Bell shaft mining is done in sheet-ore at a depth of 131 ft., continuing down to 160 ft.; but at the Bird Dog shaft, due to the greater surface elevation, the formation is found deeper. Part of the ore feed

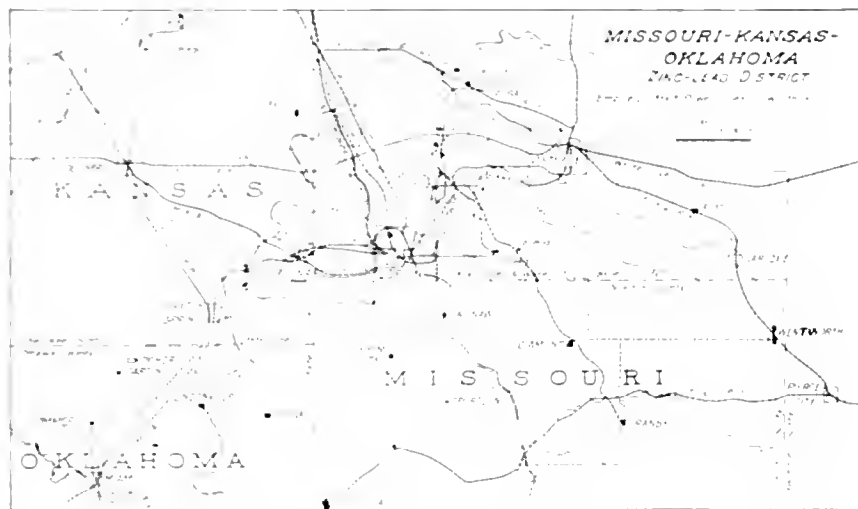

to the rougher-jig comes direct from the crusher, thus eliminating the necessity of handling a large tonnage of 'dirt' over the rolls. Any ore that passes through $\frac{1}{2}$ -in. mesh goes direct to the rougher. A Corliss steam-engine plant has been installed to drive the mill, the equipment of which is to consist of two rougher-jigs, one cleaner, and one sand-jig. The cleaner has seven 26 by 48-in. cells, and is the largest in the Joplin district. The concrete settling-tank, 40 ft. wide by 50 ft. long and 10 ft. deep at the deepest point, is likewise the largest tank in the district. Ten sludge-tables are housed in a separate building, a short distance north-west of the mill. The tract that is to be mined is now thoroughly drained, for the first time in six years, as this section of the district has been inactive since the shutting-down of the big Yellow Dog property. The operators say they will recover 4% of blende and lead.

Almost duplicating in general features the plan of the D. C. & E. plant, north of Webb City, is the new 1500-ton mill of the Picher Lead Co. at Picher, Oklahoma, the fourth plant to be constructed by this company in a field that only recently has been developed. In the matter of jig-feed, sludge will be taken off by dewatering screens immediately after the crushed ore leaves the crusher, and before it reaches the rolls, undersize from a $\frac{1}{2}$ -in. screen passing directly to the rougher in as dry a form as possible where it is distributed. Oversize goes to rolls, and is again screened and dewatered before going to the rougher. The three mills now in operation by the Picher company are producing heavily. Ore is mined at a general depth of 250 to 300 ft. The plants now at work have a capacity

of 350 tons each per shift, or about 1000 tons per day. These mills make the district generally very busy.

North of Picher, a number of prospecting drills are at work. Lucius Buchanan has 12 drills on a 40-acre lease of the Toskoff land lying along the State line in Kansas. The good strikes made by the Picher company on the south, and by the Commerce Mining & Royalty Co. on the north, have encouraged Buchanan, who intends to devote at least six months to his prospecting campaign, regardless of whether he finds ore or not. On the Cooper land, near to the Toskoff property, a big drilling campaign has been launched by G. Bayless and Will and Joe Walker, who have more than 100 acres under lease. In the first hole put down 'shines' of zinc-blende and galena were found from 220 to 240 feet.

Sheet-ground mining is to be started on the Continental ground, in west Joplin, by the C. M. & H. Mining Co., now operating the Glendale mine, where all the work in the past has been in an upper formation, beyond the sinking of a shaft to the sheet-ore which occurs at a depth of 200 ft. The disseminated ore, heretofore worked, is found at 140 ft. In working the deeper ground, tests show that a recovery of about 2½% may be expected.

The Wade Mining Co., of which Evans W. Buskett is the Joplin manager, while John L. Fay, C. E. Brenton, and Frank W. Bane, of St. Louis, are the operators, has taken a lease on 120 acres of the Wade land, 15 miles south-east of Joplin, in a district that has not been mined for eight years. The Gilt Edge Mining Co. operated a mill at that point, but later removed its plant. A sub-leasing company will construct a tailing-plant on the Gilt Edge dump, while the Wade company has purchased the Emperor mill, from a west Joplin company, and will move it to its new mine which has now been quite extensively developed. Ore is opened in two shafts at a depth of 40 to 80 ft. in soft ground, and will yield 5 to 15% blende.

As an indication of the increased operations in the Joplin district, the figures of power output of the Empire District Electric Co. during a recent week are of interest. The demand was 2,936,870 kilowatt-hours, with a peak load of 28,700 kw., compared with 1,588,680 kw.-hr. and 16,700 kw. a year ago. In the third week of April 587 hp. was contracted for, over five times the amount of that week in 1915.

Owing to the lower prices of ore, wages are to be reduced in this district and the 'hoister-men' at several mines have 'quit.' They were paid \$4.75 per shift, but a cut of 50c. was to be made. Their union of 400 members is the strongest. Some shovelers also have 'downed tools.'

The output of the Missouri-Kansas-Oklahoma region last week was 5827 tons blende, 70 tons of calamine, and 844 tons lead, averaging \$73, \$54, and \$83 per ton, respectively. The total value was \$501,717, and for 22 weeks, \$18,214,975.

A 400-ton mill was erected for the Milton company, between Webb City and Carterville, in 31 days. This is claimed to be a record in construction.

A suit has been started at Miami by Mrs. M. N. Warner, a Quapaw Indian, and her husband, against the Commerce Mining & Royalty Co. and others for \$200,000, already collected by the defendants as royalties on lands which they allege were secured by the defendants from them by fraud, also further damages amounting to \$300,000. The land was sold by Mrs. Warner for \$8500, without her knowing that it contained zinc and lead ore. Production so far is \$800,000, on which defendants received \$200,000 in royalties, and \$1,000,000 of ore still remains.

In 62 holes drilled near Cardin only three revealed no ore.

THE MINING SUMMARY

The news of the week as told by our special correspondents and compiled from the local press.

ALASKA

Since 1898 the U. S. Geological Survey has been systematically investigating the Territory, yet much remains to be done. Alfred H. Brooks is in charge, with (this season) T. Chapin at Ketchikan, G. H. Canfield in the south-east (water resources), D. C. Witherspoon, A. C. Spencer, and H. M. Eakin at Juneau, J. W. Bagley, and B. L. Johnson in Prince William Sound, F. H. Moffit in the lower Copper River region, G. C. Martin, A. G. Maddren, and R. M. Overbeck in the Neanana coal-field, S. R. Capps and C. E. Griffin in the Kantishna district, J. B. Mertie at Tolovana, and R. H. Sargent with G. L. Harrington on the lower Yukon river.

JUNEAU

During May the Alaska Gastineau produced 175,215 tons of ore averaging \$1.40 per ton, against 165,930 tons at 94 cents in April. The recovery was 82.85%. Conditions underground continue to improve.

The Treadwell group reports will be reviewed next week.

The Lituya Gold Mining & Dredging Co. has been incorporated with a capital of \$400,000 by H. H. Williams of Juneau and F. P. Cook of Spokane, to develop property on Lituya bay. Prospecting by drill is to be done this summer, to be followed by a dredge if satisfactory.

ARIZONA

COCHISE COUNTY

Recent happenings in the Bowie district, in which is the Dos Cabezas range, are attracting attention to its possibilities. There are included four mining areas, namely, the Apache Pass, 10 to 14 miles south; Happy Camp, 9 miles south; Buckeye Canyon, 8 miles west; and Gold Gulch, 12 to 16 miles west of Bowie. The north slope of the range is well mineralized, with gold, silver, copper, and lead. In Apache Pass the old Quillian is the most important property, yielding silver-lead ore. Happy Camp has two good copper mines. In Buckeye canyon the Bowie Mines Development Co. is to build a 50-ton mill to treat silver-lead-gold-copper ore. Gold Gulch has promising ground. J. H. Jaque, publisher of the *Bowie Enterprise*, is taking an active interest in the development of the district.

GILA COUNTY

The Inspiration treated 470,000 tons of ore during May, equal to 5,640,000 tons per year. The new sampling mill is almost complete. Foundations for a duplicate motor-generator set are ready for the machinery. This is for the main shaft hoists.

At the Old Dominion mill changes include installation of Senn vanners and Allen cones. The plant treats 800 tons daily. Foundations for new power machinery are being poured. Two Sterling boilers will be erected. The mine flow of water is 6,500,000 gal. per day, a decrease. The May output was 3,500,000 lb. of copper.

From the Gibson mine at Globe the company and lessees are shipping up to 400 tons of ore monthly to the International smelter at Miami. In April the total was 460 tons. The ore is chalcopryrite, much containing 20 to 35% copper. Development at 1400 ft. in the Arizona Commercial, the deepest work at Globe, is good. The monthly output of copper from No. 10, 12, 13, and 14 levels is 500,000 lb., with earnings over \$70,000.

MOHAVE COUNTY

Forty-six miles east of St. Thomas in Nevada is the Grand Gulch copper mine, producing 80 to 100 tons of ore per week. On June 1 there was paid 2c. a share. Ore shipped contains 12 to 16% metal. A dump of 15,000 tons assays 5%; this is being graded up to 12%. The haul to the railroad is 45 miles; 75 men are employed.

A wide body of milling ore has been cut at 1400 ft. in the Tom Reed mine.

SANTA CRUZ COUNTY

The Chamber of Commerce of Nogales is awakening to the importance of the mining industry of this county, says a report of the Arizona State Bureau of Mines. Recently a meeting of that body was held, the object of which was to discuss the erection of a custom mill, with an arrangement for having facilities for treating tungsten ore. Many other parts of the State have need in this line.

CALIFORNIA

AMADOR COUNTY

On June 5 the syndicate that acquired the old Eureka mine recently made the first payment of \$41,000, being one-fifth of the purchase price, on the Wildman-Mahoney-Lincoln claims owned by the Lincoln Consolidated Co., which owns 4000 ft. on the strike of the Mother Lode on the northern side of Sutter creek. It is also reported that another syndicate of Seattle operators has taken an option on the ground extending from the Golden Eagle to the Keystone, including therefore the South Keystone and South Spring Hill properties.

ELDORADO COUNTY

The new shoot at 800 ft. in the Montezuma mine at Nashville shows 7 ft. worth \$20 per ton.—The Orum mine near this place has been acquired by W. W. Hurt and others.

SAN BERNARDINO COUNTY

(Special Correspondence.)—The 'spud-diggers' in the Atolia district are pleased that the Federal government has several



HAND-JIGGING TUNGSTEN ORE AT ATOLIA.

investigators in the field who are looking over the granite formations that show tungsten possibilities, because, in case of the taking up or withdrawal of such lands the Government

may develop them by leasing. Storekeepers are displaying such signs as "cash for high-grade," "meal tickets for high grade," or "groceries for high-grade." Buyers of outside production of ore are again on the ground, and it is not uncommon to see two or three shipments by automobiles to Los Angeles, where it is sampled and sold on a basis of \$1 to \$1.25 per pound. Several tons have been picked up this week at prices varying from \$15 to \$50 per unit. Shippers of the product contend that not a pound of this output is going to the Schwab interests, or those agents representing the Bethlehem Steel Company.

Atolia, June 7.

The new mining camp of Goldstone, 33 miles north-east of Harstow, a few miles south of Randsburg and Atolia, at an elevation of 3000 ft., is beginning to attract attention. It is 8 hours by auto from Los Angeles, costing \$10 the round trip. Three recent discoveries, the Red Iridg, Goldstone, and Lucky Find, are working in high-grade ore. The district is yet in shallow depths, now about 50 ft. Free gold continues to this depth. On the Red Iridg the ore has been stripped about 200 ft. on the surface, all of which pans free gold. The formation here is schist, shale, and quartzite, with igneous rocks of different character in the nature of dikes and flows. The rich gold seems to be found near the contact of the igneous rock with the sedimentary rocks, and favors the schist.

HUMBOLDT COUNTY

(Special Correspondence.)—Wilbur H. Grant, of San Francisco, is making an examination of the Horse Mountain Copper Co.'s ground. The company desires to start a diamond-drill proving ore, with a view to offering the property for sale. Later on the company will have a mineral survey made from which will be excluded those of its 74 locations reported on adversely by Mr. Grant. By the end of this week O. H. Hershey will also examine the same ground, but independently, in the employ of Charles Willis Ward, of Long Island, New York, and Eureka, one of the largest shareholders. Mr. Hershey will also lay out further work for the drill at the Humboldt Copper Co.'s property, where an immense body of low-grade ore was discovered through his advice last year. Mr. Hershey will go to Prospect Hill near Orleans Bar, where some promising gold-bearing veins have been found, and will examine 27 claims located for Mr. Ward there.

The Corona Mining Co., which operates a gold placer at Hawkins Bar, just over the Trinity County line, and owned by Eureka people, yesterday shipped its third bar from three part clean-ups this season. The bars averaged \$1000 each. It is estimated that the mine will have water for four or five weeks yet. The riffle sand, composed mostly of pyrite, is rich in platinum metals, about an ounce of coarse metal being recovered to each 50 oz. gold amalgamated.

Eureka, June 7.

SHASTA COUNTY

For reasons unknown at Ingot, the American Metal Co., which had an option on the Afterthought copper mine, has paid-off all hands, numbering 35. The vein is said to be small and the grade low.

SIBERRA COUNTY

Hydraulicicking is soon to commence at the old Bunker Hill-Herkimer mine, 12 miles from Downieville. Some rich gravel was uncovered in January. G. Le Bretville, of San Francisco, controls the property.

TULUMNE COUNTY

(Special Correspondence.)—Work was begun this week at the Tarantula mine, recently acquired by Henry T. Gage. It is understood that S. B. Thompson of New York, and others have become associated with Mr. Gage in his properties. It was expected that at least 40 men would be on the pay-roll by the end of the week. The Tarantula and the other holdings

of Mr. Gage and his associates are situated in the vicinity of the well-known Shawmit.

Consignments of machinery for the Rawhide frequently arrive. In a carload received this week was a pump of large capacity, which will be installed on one of the stations in the mine. The work of unwatering has been in progress for many weeks.

A shoot of rich ore has been uncovered in the Chllano mine, near Tuttle town. The orebody is several feet wide, a streak of it being thickly speckled with gold.

Sonora, May 26.

COLORADO

BOULDER COUNTY

The Wolf Tongue Mining & Milling Co. at Boulder is being sued by D. and O. Hinman, who are lessees on the company's property. They allege that they delivered 13 lots of tungsten ore at the company's mill between October 12 and December 31 last. They demand \$8925.81; the Wolf Tongue offers \$3200.19. At the then market prices, ranging from \$15 to \$45 per unit, plaintiffs declare the ore was worth the amount for which the suit is brought. The defendant offered to make settlement on the basis of a \$15 schedule.—Fourteen lessees besides the Hinman brothers are interested in the outcome of the suit, as they hold similar contracts with the company. If the suit is determined in favor of the Hinmans, it is understood the other lessees will demand payment for the tungsten they delivered on the basis of the market prices, which are from 100 to 150% above the Wolf Tongue schedule.

Judge Neil F. Graham has since ruled that contracts held by lessees of tungsten lands of the Wolf Tongue company should be interpreted to require payment of market prices for ore produced by the lessees.

CLEAR CREEK COUNTY

(Special Correspondence.)—The members of the Colorado Central Leasing Co. were incorporated as a company in Denver on May 24. The plans of the company are now fully decided on, and sufficient capital has been subscribed to complete the work of sampling and re-opening the property, which will take 6 to 8 weeks. A preliminary testing plant is to be erected at the mine to determine what treatment the ore requires. Money has also been subscribed to erect a tramway a distance of two miles from the mine to Georgetown, and for the building of a mill with a daily capacity of 100 tons. Tallmadge Kyner, the manager, states that all tests made so far are beyond expectations.

J. C. Hershey, manager of the Red Oak company, expects to re-build the aerial tram from the mine to the foot of the mountain.

A recent examination made of the Bard Creek Mining Co.'s mill resulted in a decision to install almost entirely new machinery.

A new campaign is to be instituted by three mining companies here, now that the supervision of their properties has been placed in the hands of Fred B. Hitchings. Machinery will most probably be installed on each mine for driving.

The Mid Colorado company is to re-model its 50-ton mill, using a ball-mill for re-grinding, and flotation. The present aerial tram is to be extended 1000 to 1200 feet.

Georgetown, May 24.

OURAY COUNTY

During April the Camp Bird's profit from 1389 tons treated was \$26,000.

SAN JUAN COUNTY

Under prevailing conditions this county offers a good field for prospectors in gold, silver, lead, zinc, and tungsten. Flotation treatment has greatly stimulated production.

The Silverton district shipped 138 cars of ore and concentrate during May. The principal producers were the Sunny-side, S. D. & G., Gold King, and Iowa-Tiger.

SAN MIGUEL COUNTY

On June 1 employees (1000) of the Tomboy, Liberty Bell, Smuggler-Union, Colorado-Superior (Black Bear), Primos Chemical, Wagner Development, and Humboldt companies were granted a bonus of 30c. per shift, provided silver remains at 65c. or over per ounce, and each employee works the full month.

IDAHO

BLAINE COUNTY

The Wilbert Mining Co., operating near Arco, reports as follows for the year ended May 1, 1916:

The high price of lead allowed of a good deal of poor ore being extracted, also small streaks and shoots that would not pay otherwise. From No. 5 level to the surface the main shoot is nearly all stoped. The mill treated 15,204 tons, assaying 25% lead and 3.86 oz. silver. Concentrate produced was 5787 tons, averaging 52.06% and 8.02 oz., equal to 6,025,600 lb. lead and 46,419 oz. silver. The cost was \$3.56 per ton. The revenue from all sources was \$223,382. Dividends absorbed \$30,000. Cash in banks amounts to \$42,468.

The A. S. & R. Co., controlling the Federal company in the Coeur d'Alene, has taken over the North Star-Triumph lead-silver-zinc claims near Hailey. E. P. Smith is in charge. The property contains a good deal of ore, but it is rendered complex by the admixture of arsenical pyrite.

IDAHO COUNTY

In the Buffalo Hump, Ten-Mile, and other parts of this county, contiguous to Grangeville, are complex sulphide ores resisting ordinary treatment methods; but recent investigations show that flotation will give a good recovery, according to E. M. Griffith of Grangeville.

SHOSHONE COUNTY (COEUR D'ALENE)

Dividends paid in May totaled \$722,175 as follows: Bunker Hill & Sullivan, \$163,500; Caledonia, \$78,150; Hecla, \$100,000; Hercules, \$300,000; Success, \$45,000; and Tamarack & Custer, \$35,525. June payments are as follows: Bunker Hill & Sullivan, \$163,500; Caledonia, \$78,150; Federal, \$120,000; Hecla, \$150,000; Hercules, \$300,000; Interstate-Callahan, \$697,485; and Success, \$45,000; a total of \$1,554,135.

The Pine Creek district is being examined by J. B. Umpleby and E. L. Jones of the U. S. Geological Survey.

A final inspection of the Nabob, Sidney, and Little Pittsburg mines in the Pine Creek district is being made by engineers of the Anaconda company, which recently acquired the Douglas near-by.

The contract with the A. S. & R. Co. having expired, the Tamarack & Custer company, which operates lead-silver mines in the Nine-Mile district has closed-down its properties temporarily, pending diversion of the output to the Northport smelter in Washington.

In order that it may purchase more property the Stewart Mining Co. is to increase its capital from \$1,250,000 to \$3,000,000.

MICHIGAN

THE COPPER COUNTRY

G. M. Hyams, of Boston, a shareholder (1300 shares) in the Tamarack company, whose mine was recently sold to the Calumet & Hecla for \$59 per share, has brought suit to restrain the sale. The C. & H. held 19,400 shares of Tamarack, which makes the former both vendor and purchaser, the sale being made void under the statutes. The price offered is also considered too low. In view of this suit the Tamarack company has asked the C. & H. to defer transfer of the property beyond July 1, the date that this was to take place. The C. & H. directors are considering the proposal.

The old Carp Lake mine, bordering on Lake Superior, and 22 miles west from Ontonagon, is to be re-opened under con-

trol of R. T. Looney. Work was stopped in 1863, after the 16-stamp Cornish-design mill was burned. Copper was sent to Detroit before the Calumet & Hecla was discovered. Ore occurs in rich lenses in sandstone. Development can be done by adits. Examinations made show the ore to carry from 44 to 53 lb. of copper per ton.

MONTANA

GRANITE COUNTY

At the old Brooklyn mine near Maxville 6 ft. of good copper-silver ore has been opened at a depth of 280 ft. A 100-ton mill is about ready to commence ore treatment. Spokane people are in charge.

SILVERBOW COUNTY

At the Butte & Zenith, south-west of Butte, the shaft is down 765 ft., 95 ft. being sunk and timbered during May in spite of 300 gal. of water per minute. Another 300 ft. is to be sunk. The vein is of better grade at depth.

At the Butte-Main Range the Tuolumne company has commenced work. The Colusa-Leonard mine, which is to be developed by the Tuolumne, will commence shaft-sinking from 628 to 1628 ft. depth.

Sinking is finished at the Butte & London. Prospects are good.

The fire in the Pennsylvania mine of the Anaconda that killed 21 men some months ago is out and production is now 750 tons daily.

During May the Butte & Superior produced 16,150,000 lb. of zinc in concentrate, from 54,100 tons of ore. Silver amounted to 310,000 oz., and 250,000 lb. of lead. At 1100 ft. east and west of Jersey Blue shaft good orebodies have been developed.

NEVADA

An indication of the increase in mining operations in this State is shown by premiums paid by mines to the State insurance fund as follows:

| | | | |
|----------------|----------|----------|----------|
| January | \$17,245 | \$12,002 | \$18,341 |
| February | 20,553 | 11,765 | 17,195 |
| March | 21,250 | 12,695 | 16,558 |
| April | 22,143 | 13,312 | 18,736 |

The income in April of this year was the largest recorded. Mining contributes 80% of the total fund. Since July 1, 1913, the revenue totaled \$681,188, and amounts paid \$547,572.

CLARK COUNTY

Goodsprings now boasts a daily paper called the *Goodsprings Gazette*, showing that the zinc district is advancing in importance.

ESMERALDA COUNTY

(Special Correspondence.)—The Nevada New Mines Co. has purchased the Black Eagle mine and mill. The plant has a daily capacity of 75 tons. Water, piped from a near-by hill, flows to it by gravity. The company will operate both its mills, and press underground work with increased energy. Ore reserves in the main mine are reported as satisfactory.

Rawhide, June 4.

LINCOLN COUNTY

Two dividends of 2½c. a share each have been declared by the Prince Consolidated of Pioche. May shipments were 13,200 tons of ore.

LYON COUNTY

Interest in the copper and gold and silver properties in the Yerington district is increasing. A large number of prospects have excellent futures. Some of the best mines are the Western Nevada, McConnell, Malachite, Yerington Consolidated, Utah-Yerington, Butte-Yerington, Mason Valley, Blue-stone, Empire-Nevada, Montana-Yerington, Reno-Yerington.

MINERAL COUNTY

(Special Correspondence.)—At the Luning Idaho mine the road is completed, and a truck can negotiate the hill easily to the mouth of the Hahn adit. The McDevitt shaft is down 100 ft. on the foot wall. The Conte winze is down 25 ft., showing bunches of high-grade ore, both carbonate and sulphide. Indications are good for entering the solid body of ore at no great depth.

The Meyer adit of the R. B. Todd Mining Co. is in 314 ft., with a cross cut running south of the adit where some ore has been encountered. There are indications that the vein soon will be cut.

There were 11 carloads of ore being unloaded at Luning at the end of May. Shipments are being made from the following mines: Mayflower, Never Sweat, Turk and Wall Street, and Silver Guardian. This property is being worked by lessees and belongs to F. M. Smith. Lessees are also working on the Vacation, and regular shipments are being made from the Champion, Anderson, Wedge Copper, Hartwick, Houghton, and Luning Aviator. There are 12 lessees working and shipping from the Copper Queen, as well as on the Finney, Shipper, and others. There are 300 men working in the district at mining, teaming, etc. There are three boarding-houses at Luning. There are two boarding-houses in New York canyon. The town also supports three saloons, and two others are contemplated. Three stores supply the camps and there is talk of others. Mr. Beatty of Mina extended the telephone line to Luning via New York canyon and Champion; a great convenience. Car-loads of lumber are coming in, and carpenters are busy erecting buildings at Luning as well as at surrounding camps.

The leaching plant at Ludwig is working successfully. There are over 200 men employed there. The Nevada-Douglas has recently cut a large body of high-grade ore which it is shipping. The company expects to be able to receive custom ore at the leaching-plant early next month.

Luning, May 31.

NEW MEXICO

SAN MIGUEL COUNTY

Near Ribera in the Pintada canyon, on the Santa Fe railroad, the C. H. Thaggard Copper Co. is erecting a 100-ton leaching plant. The vein is of good width and will average 5% copper. The district is one of promise.

SOCORRO COUNTY

(Special Correspondence.)—The Pacific mine is optioned to the Socorro company by the Oaks Co. The shaft is being

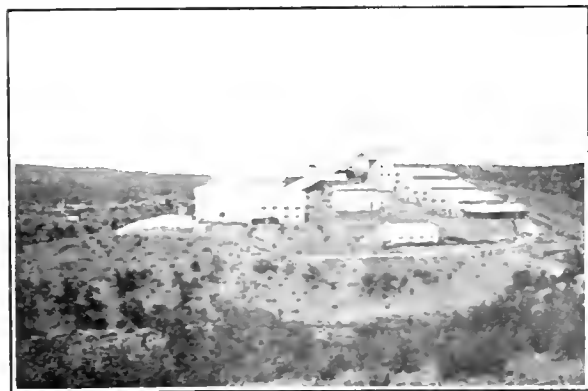

NEW MILL OF THE BURRO MOUNTAIN COPPER CO., TYRONE, NEW MEXICO.

re-timbered and other underground and surface preparations made for extensive production. An aerial tram to the Socorro company's mill will be completed within 60 days, when it is

proposed to ship from 50 to 75 tons of ore daily for reduction.

At the Confidence mine the old ore dump is being sampled with a view to shipping to one of the local custom-mills.

Installation of a large double-drum electric hoist has been completed by the Ernestine Mining Co. Skips have superseded ore-buckets in the shaft. The company has been a constant producer of gold and silver for over 11 years.

The Socorro Mining & Milling Co. is treating over 200 tons of ore daily at its plant, with a product of around two tons of gold and silver bullion per month, in addition to several tons of high-grade concentrate.

Development of the Eberle mine is conducted by the Oaks Company. The last shipment of ore to custom-mill contained 47 tons averaging \$17 per ton.

The Oaks Company recently took a bond and lease on the south half of the Clifton mine from the Socorro company. Operations will be increased as rapidly as possible, and the ore shipped to the Socorro company's mill.

Mogollon, June 5.

UTAH

BEAVER COUNTY

All mining districts in this county are busy, many shipping ore and reporting favorable developments. Rich lead ore has been found in the Antelope Star mine in the Bradshaw district.

JUBA COUNTY

The Gemini company of Tintic paid last week a dividend of \$5 per share, or \$25,000. The monthly output is 2000 tons of \$30 to \$35 ore. Over 100 lessees are working.

In April the Chief Consolidated's profit was \$69,000. Dividends are at the rate of 20% per year.

SALT LAKE COUNTY

The Fortuna Mining Co.'s property near Bingham has been sold by S. Bamberger and others to Le Roy Eccles and associates of Salt Lake City and Ogden for \$250,000. The mine contains copper ore, but has been closed for some time.

The American Fork district is busier than ever, nearly all roads being suitable for haulage of ore and supplies.

As soon as the machinery is in place, the 4000-ft. adit of the Wasatch Mines Co. in Little Cottonwood district will be started.

SUMMIT COUNTY

At the Silver King Consolidated, Park City, the aerial tram is under construction, to connect the mine and new mill. A modern mill is to be erected by the Traylor Engineering company. Slime will be treated by flotation. To separate iron from the zinc a selective process has been devised.

WASHINGTON

STEVENS COUNTY

The region in northern Washington, particularly in this county, is responding more to the revival of interest in the mining industry than any other part of the North-west, not even excepting the Coeur d'Alene of Idaho, according to Sidney Norman. There is greater activity in Northport, where the Northport Smelting & Refining Co. recently began operating its new smelter, than ever before, not even excepting the period when the old Le Roi smelter was in operation, according to Francis A. Thomson, head of the School of Mines at the Washington State College, who, with a party of his students, is investigating conditions in the Stevens County mineral belt. Samuel James is in charge of the lead smelter.

Settlements at the Trail smelter for ore and concentrate from the United Copper mine near Chewelah during April totaled \$32,000. Resumption of dividends is expected in July. The mill treats 225 tons of ore daily.

A Spokane syndicate, headed by Walter Nicholls, has pur-

chased 200,000 shares of the Electric Point Mining Co. from J. Peep of Coeur d'Alene, Idaho, for \$125,000. The Electric Point mine is 11 miles south-east of Northport, at an altitude of 5000 ft. A considerable quantity of high-grade lead ore is ready for the smelter when the road to the State highway is completed.

CANADA

BRITISH COLUMBIA

Dividends paid in May totaled \$274,977, of which \$224,977 was from the Granby and \$50,000 from the Standard. June payments are as follows: Hedley, \$60,000; Rambler-Cariboo, \$35,000; Standard, \$50,000; and Crows Nest Coal, \$93,189, a total of \$238,189.

In the first five months of the year the Trail smelter has received a total of 203,561 tons of ore from 80 different mines. The Ben Hur and Knob Hill at Republic, Washington, sent 2099 and 1296 tons respectively.

Californians have bonded a gold property on Bayonne mountain, south of Nelson, for \$142,000. J. McNichol of Butte put the deal through.

The Bayonne gold mine, in the Sheep creek region, owned principally by James W. Gerard, U. S. ambassador to Germany, and Thomas Hickey of Butte, Montana, has been taken under option by Philadelphia people, for a reported price of \$300,000. The Bayonne is a splendid property with nothing against it but its remoteness from transportation, it being situated in the mountain range between the Salmon River valley and Kootenai lake, almost due west of the Sheep Creek camp. The government of British Columbia has promised to contribute liberally to the construction of a first-class wagon-road to the mine any time the owners gave assurance that they would put the property on a firm producing basis.

ONTARIO

Silver production of the Kerr Lake mine in April was 225,423 oz., the highest since 1910. The profit was \$98,000.

In the period ended April 21 the Hollinger mill treated 42,673 tons of ore, at a cost of \$1.895 per ton for mining and 95.7c. for treatment.

In the first quarter of 1916 the Vipond produced 11,816 tons of \$5.24 gold ore. The 86.5% recovery was equal to \$4.53 per ton, while costs totaled \$4.51. There was a loss of \$355 in the period. Reserves are 91,000 tons valued at \$688,591.

KOREA

March details of the Oriental Consolidated company show that the plants treated 26,918 tons of ore for bullion worth \$136,258. Recovery at the Maibong tube-mill plant was 91.8%; at the Taracol cyanide-plant, 79%. The spring has been dry, so the steam electric plants are in use until rain comes.

MEXICO

Exports from Mexico through the 'ports' of Agua Prieta and Naco during May were \$1,985,400 and \$2,256,240, respectively. The total tonnage was 14,078. Nacozari dispatched 10,123 tons. El Tigre sent 5843 lb. of silver-gold precipitate. Greene-Cananea in Sonora is producing copper at the rate of 66,000,000 lb. per annum.

HIDALGO

From 23,148 tons treated during April the Santa Gertrudis company made a profit of \$120,000. For the first quarter of 1916 the mill treated 67,352 tons, yielding \$566,000, of which \$274,000 was profit. Development covered 3996 ft., 1622 ft. in profitable ore. The 20th level interior counter shaft is down 365 ft. on the incline below the level. The vein on No. 22 will soon be opened, about the end of June. The plant worked at 67% capacity, 78% during March. Labor is more plentiful; timber is scarce, but is being rafted from El Oro. Interesting experiments are being made with a ball-mill and flotation concentration, both of which show favorable results.

PERSONAL

Note: The Editor invites members of the profession to send particulars of their work and appointments. This information is interesting to our readers.

GARDNER WILLIAMS is at Santa Cruz.

E. S. PETTIS is now at Chickagoff, Alaska.

J. MALCOLM MACLAREN has returned to London from Korea.

T. F. COLE of Duluth is to reside permanently at New York.

W. SPENCER HUTCHINSON has spent several weeks at Oatman, Arizona.

R. E. HORE, editor of the *Canadian Mining Journal*, has been at Cobalt.

NELSON DICKERMAN has returned to San Francisco from Colombia.

O. B. PERRY, consulting engineer to the Yukon Gold, is here from New York.

W. F. STEVENS is superintendent of scheelite mines near Lovelock, Nevada.

O. M. BILHARZ has moved his office from St. Louis, Missouri, to Miami, Oklahoma.

F. LYNWOOD GARRISON sails by the *Vasari* from New York on June 17 to Brazil.

F. K. BRUNTON is on the staff of the A. S. & R. Co.'s Garfield smelter, in Utah.

CHARLES H. WHITE, professor of metallurgy in Harvard University, is here on his way from Oregon.

J. POWER HUTCHINS was in the Donetz anthracite region recently and has now returned to Petrograd.

ROBERT E. CRANSTON is at Butte, whither he will go periodically, under retainer with the Anaconda company.

L. F. LE BRUN has been appointed general superintendent to the Linda Ventura Mines at Bluefields, Nicaragua.

RICHARD HAMILTON has been chosen president of the Western Australian Chamber of Mines for the 19th consecutive year.

C. A. O'CONNELL has resumed charge of the Tough-Oakes mine at Kirkland Lake, Ontario, on his return from California.

FRANK H. PROBERT announces his permanent address as the University of California, Mining Department, Berkeley, California.

EDGAR A. COLLINS has been appointed manager of the Oceanic quicksilver mine in San Luis Obispo county, California.

WILLIAM DOBBINS, formerly with the Dominion Reduction Co. at Cobalt, has taken charge of the Good Luck mine near Arrprior.

JOSEPH STRUTHERS has been appointed treasurer to the Federal Export Corporation and the Federal Shipping Company, New York.

COREY C. BRAYTON and EDWIN R. RICHARDS have opened an office, as mining and metallurgical engineers, in the Hobart building, San Francisco.

PETER CHRISTIANSON, ELTING H. COMSTOCK, and ERVIN W. McCULLOUGH, of the Minnesota School of Mines, have been touring Western mining districts.

JOHN M. HAYES, assistant cashier of the Utah Copper Co., has been elected treasurer, and ROBERT C. GEMMELL, general manager, has been elected a director.

WALTER W. BRADLEY, mining statistician to the California State Mining Bureau, has returned from a trip through the southern part of the State, including the tungsten district around Atolia and the magnesite mines at Porterville.

The National Electric Light Association met at Chicago in the week of May 22. In its June issue of the *General Electric Review* the General Electric Co. of Schenectady has a special number of 148 pages devoted to the generation, distribution, and various applications of electric power, including mining.

THE METAL MARKET

METAL PRICES

San Francisco, June 13

| | |
|---|-----------|
| Antimony, 50c product, per unit (1 ¹ / ₂ or 20 lb.) | 37.50 |
| Chrom. 40% and over, f.o.b. cars California, per ton, 10,000 | 31 |
| Pig lead, cents per pound | 7.25 8.25 |
| Platinum, soft metal, per ounce | \$74 |
| Platinum, hard metal 10% rhodium, per ounce | \$79 |
| Quicksilver, per flask of 75 lb. | \$68 |
| Silver, cents per pound | 21 |
| Tin, cents per pound | 16 |
| Zinc dust, cents per pound | 30 |

ORE PRICES

San Francisco, June 13

| | |
|---|---------------|
| Antimony, 50% product, per unit (1 ¹ / ₂ or 20 lb.) | \$1.25 |
| Chrom. 40% and over, f.o.b. cars California, per ton, 10,000 | 12.00 |
| Manganese, 50% product, f.o.b. cars California, ton | 20.00 |
| Magnesite, crude, per ton | 7.00-10.00 |
| Tungsten, 60% Wt%, per unit | 130.00-140.00 |

At Boulder, Colorado, little tungsten is being bought. Lessees are selling at \$10 to \$12.50 per unit. One independent buyer is paying \$2.5. The Primos Chemical Co. has advanced its price for lessees from \$30 to \$32, and will pay as much for 30% as 60% ore.

EASTERN METAL MARKET

(By wire from New York.)

June 13—Copper is dull, though fairly steady; lead is inactive and weak, spelter is quiet and easier.

SILVER

Below are given the average New York quotations, in cents per ounce, of fine silver.

| Date | Average week ending |
|-------------|---------------------|
| June 7 | 66.62 |
| " 8 | 66.12 |
| " 9 | 62.75 |
| " 10 | 63.25 |
| " 11 Sunday | 61.87 |
| " 12 | 63.87 |
| " 13 | 64.58 |

Monthly averages

| | 1914 | 1915 | 1916 | July | 1914 | 1915 | 1916 |
|------|-------|-------|-------|-------|-------|-------|-------|
| Jan. | 57.58 | 48.85 | 56.76 | 54.90 | 47.52 | | |
| Feb. | 57.52 | 48.45 | 56.74 | 51.35 | 47.11 | | |
| Mar. | 58.01 | 50.07 | 57.89 | 53.75 | 48.77 | | |
| Apr. | 58.52 | 50.25 | 61.37 | 51.12 | 49.40 | | |
| May | 58.21 | 49.87 | 74.27 | 49.12 | 51.88 | | |
| June | 58.43 | 49.03 | | 49.27 | 55.34 | | |

London reports a good tone in silver, in spite of rather wide fluctuations. Slackness of demand in competition with that for English and Indian storage, coupled with re-sales and increased American supplies and Indian selling, caused a drop last week. Although rapid upward movements may not recur, a general demand for exchange is most likely. Shipments to India up to May 24 total 2,645,000, against 2,275,000 in this period of 1915. For Uruguay's new coinage 500,000 oz. has left New York, to be followed by 200,000 oz. more. Revolts in China may cause exports from that country to be less than ever.

COPPER

Prices of electrolytic, New York, in cents per pound.

| Date | Average week ending |
|-------------|---------------------|
| June 7 | 28.90 |
| " 8 | 28.90 |
| " 9 | 28.90 |
| " 10 | 28.90 |
| " 11 Sunday | 28.90 |
| " 12 | 28.90 |
| " 13 | 28.90 |

Monthly averages

| | 1914 | 1915 | 1916 | July | 1914 | 1915 | 1916 |
|------|-------|-------|-------|-------|-------|-------|-------|
| Jan. | 14.21 | 13.50 | 14.20 | 13.28 | 13.09 | | |
| Feb. | 14.46 | 14.08 | 15.02 | 12.31 | 12.27 | | |
| Mar. | 14.11 | 14.08 | 15.55 | 12.02 | 11.99 | | |
| Apr. | 14.12 | 15.24 | 18.02 | 11.10 | 11.90 | | |
| May | 13.97 | 18.21 | 19.02 | 11.72 | 13.88 | | |
| June | 13.60 | 19.17 | | 12.75 | 20.67 | | |

On June 30 the following dividends will be paid: Ahmeek, \$3; Champion, \$6.40; Clifton, \$1.25 and \$1; Kennecott, \$1.50; Nevada Con., 37¹/₂ and 37¹/₂%; Orocopia, \$2; Phelps-Dodge, \$2.50 and \$3.50; Quincy, \$4; Ray, \$1; United Verde, 75c; and Utah Copper \$1.50 and \$1¹/₂ per share.

Clarno has appropriated \$1,250,000 for plant enlargement. May outputs included 1,517,000 lb. from the East Butte, 1,074,000 lb. from the Shannon, and 10,400,000 from the Inspiration.

LEAD

Lead is quoted in cents per pound, New York delivery

| Date | Average week ending |
|-------------|---------------------|
| June 7 | 7.00 |
| " 8 | 6.95 |
| " 9 | 6.90 |
| " 10 | 6.85 |
| " 11 Sunday | 6.85 |
| " 12 | 6.85 |
| " 13 | 6.85 |

Monthly averages

| | 1914 | 1915 | 1916 | July | 1914 | 1915 | 1916 |
|------|------|------|-------|------|------|-------|-------|
| Jan. | 4.11 | 3.73 | 5.95 | 3.80 | 5.59 | | |
| Feb. | 4.02 | 3.83 | 6.23 | 3.86 | 4.67 | | |
| Mar. | 3.94 | 4.04 | 7.26 | 3.82 | 4.62 | | |
| Apr. | 3.86 | 4.21 | 7.70 | 3.60 | 4.62 | | |
| May | 3.90 | 4.24 | 7.38 | 3.68 | 5.15 | | |
| June | 3.90 | 5.75 | | 3.80 | 5.31 | | |

The Hecla company, Idaho, pays 15c. per share, or \$150,000, on June 20. The Consolidated Mining & Smelting Co. of Canada pays \$2.50, or \$209,830, on July 31.

QUICKSILVER

The primary market for quicksilver is San Francisco, California being the largest producer. The price is fixed in the open market, according to quantity. Prices, in dollars per flask of 75 pounds:

| Date | Week ending |
|--------|-------------|
| May 16 | 90.00 |
| May 23 | 90.00 |

Monthly averages

| | 1914 | 1915 | 1916 | July | 1914 | 1915 | 1916 |
|------|-------|-------|--------|-------|--------|-------|-------|
| Jan. | 39.25 | 51.90 | 222.00 | 37.50 | 95.00 | | |
| Feb. | 39.00 | 60.00 | 295.00 | 38.00 | 93.75 | | |
| Mar. | 39.00 | 78.00 | 219.00 | 76.25 | 91.00 | | |
| Apr. | 38.90 | 77.50 | 141.60 | 53.00 | 92.90 | | |
| May | 39.00 | 75.00 | 90.00 | 55.00 | 101.50 | | |
| June | 38.60 | 90.00 | | 53.10 | 123.00 | | |

ZINC

Zinc is quoted as spelter, standard Western brands, New York delivery, in cents per pound.

| Date | Average week ending |
|-------------|---------------------|
| June 7 | 13.62 |
| " 8 | 13.62 |
| " 9 | 13.75 |
| " 10 | 13.62 |
| " 11 Sunday | 13.62 |
| " 12 | 13.62 |
| " 13 | 13.62 |

Monthly averages

| | 1914 | 1915 | 1916 | July | 1914 | 1915 | 1916 |
|------|------|-------|-------|------|-------|-------|-------|
| Jan. | 5.14 | 6.30 | 18.21 | 4.75 | 20.54 | | |
| Feb. | 5.22 | 9.05 | 19.99 | 4.75 | 14.17 | | |
| Mar. | 5.12 | 8.40 | 18.10 | 5.16 | 14.14 | | |
| Apr. | 4.98 | 9.78 | 18.62 | 4.75 | 14.05 | | |
| May | 4.91 | 17.02 | 16.01 | 5.01 | 17.20 | | |
| June | 4.81 | 22.20 | | 5.40 | 16.75 | | |

For the sum of \$8,000,000 the Granby Mining & Smelting Co. of Missouri has sold its properties to the American Zinc, Lead & Smelting Company.

Butte & Superior pays 75c. and \$10 per share on July 1. New Jersey Zinc has declared an extra dividend of 5%, making 3% for the year on \$38,000,000 capital. The cash payments total \$12,300,000.

Anaconda's new electrolytic plant at Great Falls is expected to be ready early in September.

In the first three months of this year imports of zinc concentrate totaled 112,516 tons containing from 37.6 to 40.9% metal.

TIN

Prices in New York, in cents per pound.

| | 1914 | 1915 | 1916 | July | 1914 | 1915 | 1916 |
|------|-------|-------|-------|-------|-------|-------|-------|
| Jan. | 37.85 | 34.40 | 41.76 | 31.60 | 37.38 | | |
| Feb. | 39.76 | 37.23 | 42.60 | 50.20 | 34.37 | | |
| Mar. | 38.10 | 48.76 | 50.50 | 33.10 | 33.12 | | |
| Apr. | 39.10 | 48.25 | 51.13 | 30.40 | 33.00 | | |
| May | 33.29 | 39.28 | 49.10 | 33.51 | 39.50 | | |
| June | 39.72 | 40.26 | | 33.60 | 38.71 | | |

Tin is quiet at 43.75 to 44.75 cents.

Eastern Metal Market

New York, June 7.

Zinc has been active in the past few days, and prices have advanced from $\frac{1}{4}$ to $\frac{5}{8}$ c. per lb., but it remains to be seen if the turn will be lasting.

All the other metals have been extremely dull.

In copper there has been little to indicate its actual level.

The A. S. & R. Co. reduced its lead quote $\frac{1}{8}$ c. on the 2nd, but there has been little business, either before or since the reduction.

Efforts to tempt consumers into buying tin have been almost without results.

Antimony has continued to slump, and probably could be bought at 22c., duty paid. Two months ago its price was 45c.

Aluminum is unchanged.

New business in all metal, iron and steel lines is lighter, but there are plenty of orders in hand to keep the mills busy. Here and there prices are a trifle easier, as in pig-iron and structural steel. The production of pig-iron continues on an enormous scale, the total for May being 3,351,073 tons, or 108,099 tons per day, against 3,227,768 tons in April. A falling-off in production had been expected. It also is interesting to note that the country's production of ferro-manganese and spiegeleisen last month was the largest on record, amounting to 35,844 tons.

Machinery is moving steadily, though at a slower rate. Following the example of Great Britain, Russia has taken steps to curb speculation, and exports to Russia are retarded by strict regulations. Russia demands the name of the ultimate consignee, and various other data, also exacts a charge of \$50 to cover cable tolls. Ocean-freights are somewhat lower, but irregular. No new munition orders are reported.

COPPER

The market has been dull to the point of stagnancy, one effect of which has been to cause the prices for future and prompt deliveries to draw closer together. In fact, it is questionable how much of a premium a prompt delivery would command today. Most of the metal which has been offered in recent days has been in second-hands, not a little of it belonging to consumers who over-bought, and now see an opportunity to sell at a profit, buying again later to make up any deficiency in their needs, at a lower price. Offering of this sort would soon disappear should the market show an upward trend. Near-by electrolytic probably can be obtained at 28c., cash New York, and future positions at near 27.75c. There is hardly enough doing to determine how the producers would act. Lake is purely nominal at about 28.25c., cash. The extent of the dullness is indicated by the fact that sellers are asking for bids. The London market for electrolytic was quoted June 6 at £142, an advance of £2 over the preceding day. One influence which makes for dullness is the uncertainty which prevails as to the ultimate effect the limiting of trading at London will have. The effort of the British government to suppress speculation was referred to a week ago. It was predicted that trading in standard copper would cease, but quotations of standard tin and copper continue to reach here. Exports to the 6th totaled 6619 tons. Copper in manufactured form is going abroad in large quantities.

ZINC

Last Friday (June 2), with the New York quotation down to 13c., and that at St. Louis at 12.75c. both for prompt delivery, the bottom of the market appeared to have been reached, and a turn was taken for the better. Yesterday prompt was about 13.62 $\frac{1}{2}$ c., New York, and 13.37 $\frac{1}{2}$ c., St. Louis. Since Friday a great deal of zinc has been purchased. The

great question is whether consumers will continue to buy. Among the purchasers were galvanizing interests who had long been out of the market, and whose operations will speedily come to a halt again if prices advance too rapidly. On the 2nd fourth quarter was done at 10.50c., St. Louis, and the entire last half at 11.25c. Yesterday last quarter was up to 11.12 $\frac{1}{2}$ c., and last half at 11.75c., St. Louis. A strike of hoistmen in the Joplin district served to further strengthen the market, but this trouble is reported as about over. If prices for the refined metal do not advance, it is pretty certain that ore prices must come down. Methods of curtailing the production of ore have been discussed, according to report. The brass mills are well supplied with spelter for the orders they have in hand, and the premium on special grades of zinc is decreasing. It may be stated as a certainty that Europe will require large quantities of spelter in the not distant future. It was largely foreign buying that gave the market its better aspect last Friday. Exports in 6 days totaled 423 tons. The London quotation for spot on the 6th was £76.

LEAD

As was expected, the A. S. & R. Co. reduced its quotation on June 2. Late on that day it announced a reduction from 7.50c., New York, to 7c., and from 7.42 $\frac{1}{2}$ c. to 6.92 $\frac{1}{2}$ c., St. Louis. Prior to the reduction the market was dull, and there has not been much change since. Outside sellers have shaded the A. S. & R. Co. quotation about 5 points since the decline was announced, but have not obtained much action from consumers. Previous to the decline, the Independents were cutting deeply in an anxious attempt to get business. On June 1 foreign buyers took a few lots of 200 and 250 tons each. The market today is uncertain and unsettled. Exports from June 1 to 6 totaled 502 tons. The London spot quotation on the 6th was £32.

TIN

Except for a little business on June 1 and 2 the market has been extremely quiet for days, and prices have steadily declined. The quotation for spot Straits yesterday was 44.25c., while Banca could be had at 43.50c. The supply of Banca has been pretty well absorbed, but more is on the way to this country. Offerings at concessions have been made in the effort to induce business, but they only served to make consumers more timid. Deliveries into consumption in May were large, amounting to 5455 tons, of which 1255 tons came by way of Pacific ports. The total of deliveries since January 1, 25,223 tons, is an increase of 6982 tons over the same period of 1915. In stock and landing, on June 1 was 2468 tons. So far this month 1265 tons has arrived, and there is afloat 3617 tons.

Tin ore from South America continues to arrive here, but is finding no market, and stocks are accumulating. The opinion is expressed that shipments from South America should be discouraged.

ANTIMONY

Prompt Chinese and Japanese is quotable at 22c., and it is probable that 22c., duty paid, would not be declined. There is a surplus of the metal, and no one seems to want any, except, perhaps, small quantities. There is report of large foreign inquiries, but these have not taken form sufficiently to bolster up the market. Needle antimony has been offered for spot delivery at 18c. per lb. without finding buyers.

ALUMINUM

The quotation for current deliveries of No. 1 aluminum, 98 to 99% pure, is unchanged at 58 to 60 cents.

COMPANY REPORTS

HOLLINGER GOLD MINES, LIMITED

A comparison of the years 1914 and 1915 at this Porcupine, Ontario, mine, shows the following results: Ore treated, 208,936 and 334,750 tons, gold recovered, \$2,688,355 and \$3,169,814, and dividends paid, \$1,170,000 and \$1,560,000, respectively.

The report for 1915 is accompanied by that of the general manager F. A. Robbins, recommending consolidation of this company with the Acme and Millerton companies, and certain property of the Canadian Mining & Finance Co., which has since been done, forming the Hollinger Consolidated Gold Mines, Ltd. This was briefly discussed in the Press of May 20. The combined area of the properties is 410 acres. In 42 months the Hollinger produced 728,172 tons at a profit of

new company of \$25,000,000 capital—5,000,000 shares. Hollinger shareholders receive 2,400,000 shares (four for each one in the old company), Acme 2,100,000, Millerton 200,000, C. M. & F. Co. 100,000, and 200,000 to treasury. The Hollinger mill is now treating 1900 tons daily, for a profit of \$280,000, of which \$240,000 will go in dividends. The mill is to be increased to 3500 ton capacity, at an expenditure of \$750,000. It has taken five years to amalgamate these properties, the geologic research, underground work, treatment problems, centralizing of plant, etc., having all been done with this end in view.

During 1915 development in the Hollinger totaled 10,805 ft., with 8378 ft. of diamond-drilling, down to a depth of 100 ft. Ore reserves are estimated at 1,600,800 tons, worth \$10.02 per ton, an increase of 137,810 tons, but \$1.47 less in value. Mining cost \$2.183 per ton.

The mill gave a good account of itself in treating 334,750 tons of Hollinger ore, assaying \$10.11 per ton. Gold recovered was worth \$3,169,814. The cost of treatment was \$1 per ton. Extraction averaged 96.04%. All costs totaled \$3.98 per ton, against \$5.21 in 1914. There were 735 men employed.

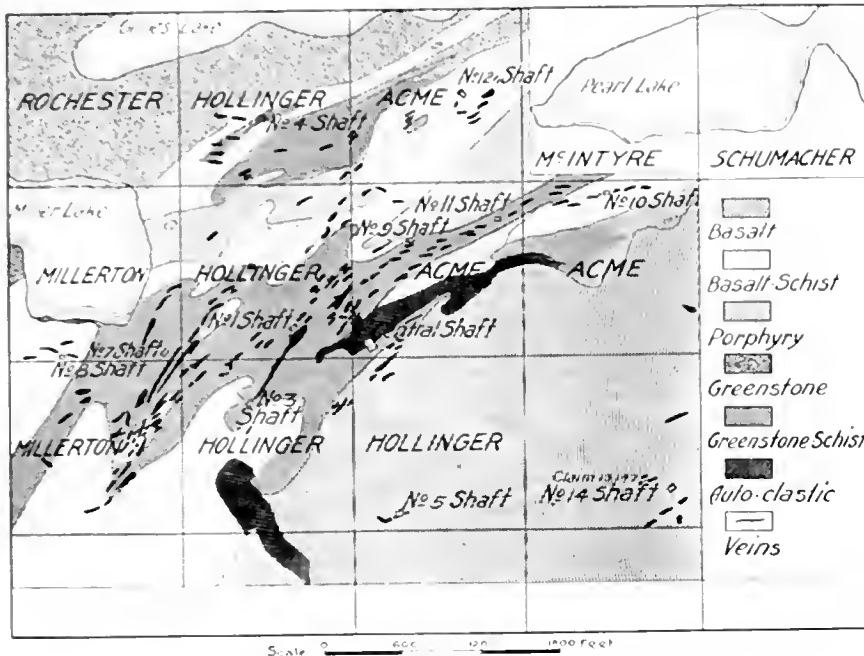

PLAN SHOWING VEIN OUTCROPS AND SURFACE GEOLOGY OF THE NEW CONSOLIDATION AT PORCUPINE, ONTARIO; THE HOLLINGER CONSOLIDATED GOLD MINES, LTD.

\$6,078,925, of which \$4,170,000 was disbursed; and the Acme \$1,035,008 of bullion from 106,486 tons in 10 months. The Millerton and claim 12,147 are not yet producing gold. The consolidation will result in economies, and minimum loss through the vagaries of geological phenomena, some of which are shown on the accompanying plan. The rocks are of the Keewatin series of pre-Cambrian age. An estimate of the relative values of Hollinger and Acme properties under various possible conditions gives 4,520,800 tons of \$7.82 ore in the former and 5,909,230 tons of 2c. less value in the latter. This is based on a depth of 1400 ft., crediting each vein with 80% of the tonnage indicated, and an average value equal to 60% of the value obtained at the surface. The Millerton may contain 400,000 tons of \$6.50 ore, and claim 12,147, a total of \$200,000. The Acme has a chance of yielding less ore than calculated on account of two tongues of quartz-porphyry, that probably join at a depth of 1500 ft. This rock does not contain profitable ore, save where it contacts with schist. Profit in the reserves is \$10,798,227 for the Hollinger and \$15,777,455 in the Acme, Millerton, and claim 12,147, a difference of about \$2,000,000 in favor of the Canadian Mining & Finance Co.'s holdings. For plant and development the Hollinger has an investment of \$1,425,000, and the Canadian company \$850,000. The Hollinger has net current assets of \$744,743. In the

TONOPAH MINING CO. OF NEVADA

This company operates at Tonopah, Nevada, and controls the Tonopah Placers Co. of Breckenridge, Colorado, and the Eden Mining Co. in Nicaragua. The first dividend has been paid by the Colorado property, while the Central American mine is having a mill erected as fast as possible. The report of the Tonopah company is for the year ended February 29, 1916; future reports will coincide with the calendar year. The remarks of the superintendents at the mine and mill, W. H. Blackburn and F. F. Heydenfeldt, respectively, are brief.

Ore reserves amounted to 53,493 tons, averaging \$11.93 per ton. Mining cost \$4.31 per ton. There were no important changes in mining and milling methods. There was treated 136,246 tons of ore averaging \$13.66 per ton. The recovery, based on net smelter returns was 90.3%, a gain of 1.3%. Cost of treatment was \$2.94

per ton, a decrease of 7.7c., in spite of increased prices of supplies. Costs in all departments were \$7.78 per ton, and profit \$4.77, metal losses being \$1.11 per ton.

Net earnings were \$468,331, plus \$314,733 from dividends in banking, placer, power, and railroad companies, also interest, etc., making \$783,064 available. The surplus at the beginning of the year was \$3,860,244; at the end \$3,704,259. Dividends (4) totaled \$800,000, making \$12,300,000 to date.

Gold recovered by the Tonopah Placers Co. amounted to \$179,018, of which \$216,980 was profit.

NEW YORK & HONDURAS ROSARIO MINING CO.

The thirty-fifth annual report of this New York company operating in Honduras, Central America, covers the year 1915. The low prices of silver affected profits considerably, however, 12% dividends, equal to \$240,000, were paid and a substantial cash reserve, \$66,578, maintained. The year's revenue from silver and gold was \$1,191,761, making \$21,172,967 since 1882. On January 1, 1915, the surplus was \$994,368; on December 31, \$990,510. The manager is A. R. Gordon, with F. H. Minard as consulting engineer, and A. G. Greeley as general agent. Grasshoppers damaged the crops, and supplies increased in price due to the War. All costs were ₡16.886 per ton.

Mine development amounted to 13,000 ft., a decrease of 2700

ft. About 20 veins are worked. Reserves are estimated at 343,716 tons, averaging \$9.76 per ton, which is 75,262 tons less than in 1914. Development is to be pushed on the San Miguel vein, south of the West vein. Surface and underground geology was thoroughly studied to aid exploration. Mining cost ₡8.962 per ton, a decrease of ₡1.

The mill treated 117,790 tons of ore averaging 16.97 oz. of silver and 0.14 oz. gold per ton; the yield was 1,748,803 oz. and 15,211 oz.; recovery was 87.45 and 92.32%, respectively. When the ball-mill and thickener are erected the capacity will be increased from 355 to 380 tons per day. Oil flotation is being experimented with. Treatment cost ₡5.5992 per ton.

The rainfall was 72.06 in., giving plenty of power. Owing to a drought in the previous year there was plenty of labor available. The rate of exchange favored the company, being 7 cents U. S. per Honduras peso higher than in 1914.

AHMEEK MINING CO.

Underground work in this company's mine in 1915 amounted to 8594 ft., compared with 4587 ft. in 1914. The four shafts are respectively 2533, 2775, 2210, and 2158 ft. deep. Results generally were satisfactory. On No. 12 level of No. 2 shaft a large mass of copper is being removed from the intersection of the fissure and the lode, and during last year 1,488,000 lb. was extracted. A number of improvements were commenced at No. 2 shaft and ore-house. The latter will include two 24 by 48-in. crushers. Two more stamps were completed at the mill.

The past three years' results were as under.

| | 1915 | 1914 | 1913 |
|----------------------------|-------------|------------|-----------|
| Ore treated, tons | 948,874 | 590,519 | 383,749 |
| Copper content, pounds | 23 | 23.1 | 24 |
| Copper extracted, pounds | 21,800,492 | 13,634,605 | 9,220,874 |
| Cost, cents per pound | 7.96 | 9.71 | 13.30 |
| Revenue | \$3,999,801 | | |
| Profit | 2,264,882 | | |
| Dividends (\$18 per share) | 1,650,000 | | |

The balance at the end of 1914 was \$968,772; at the end of 1915, \$1,583,654.

QUINCY MINING CO.

During 1915 development in this Michigan mine amounted to 27,340 ft. At the bottom of the mine is more mill ore and mass copper than for several years. Air-blasts have been more or less numerous throughout the year, and have given continued trouble and hindrance to the output; yet they have not been of an especially serious nature or of great magnitude. The necessary repairs caused by their damage have not been on a large scale, although their cost, combined with the loss incurred by delays, has been considerable.

Results were as follows:

| | 1915 | 1914 | 1913 |
|----------------------------|-------------|-------------|-------------|
| Ore treated, tons | 1,269,000 | | |
| Refined copper, pounds | 22,054,813 | 15,356,380 | 12,184,128 |
| Revenue | \$3,983,985 | \$2,054,622 | \$1,921,199 |
| Profit from all sources | 1,873,674 | 205,593 | 76,160 |
| Dividends (\$8 per share) | 880,000 | 55,000 | 412,000 |
| Surplus, inc. previous one | \$1,664,956 | \$897,531 | \$746,938 |

Copper was sold at an average of 18c. per pound.

The smelter has been busy throughout the year, especially during the latter half of the period, owing to the increase in the amount of custom work, and it is now running nearly to capacity.

MYSORE GOLD MINING CO.

The 78-page report of this English company operating at Kolar, State of Mysore, India, is for 1915. The superintendent, R. H. P. Bullen, discusses the following points of interest:

Underground exploration covered 22,238 ft., a decrease of 4010 ft. There were 101.4 rock-drills used in the mine. The Edgar vertical shaft is 3024 ft. deep. At 3226 ft. in McTag-

gart's shaft 400 ft. has been driven on a well-defined quartz lode, averaging 36 in. in width and \$14.80 per ton. A winze below this is down 90 feet on 55 in. of \$20 ore. Ore reserves are estimated at 1,044,000 tons, an increase of 30,000 tons. Costs were reduced a total of 32c. per ton.

The mill crushed 305,000 tons averaging \$13.14 per ton. The cyanide plants treated 245,866 tons of sand and 192,487 tons of slime, assaying \$2.63 per ton, some being old material. The gold yield was 207,981 fine ounces.

The revenue was £880,168, of which £335,500 was paid in dividends. The rainfall was 39.67 in. Employment was given to 161 Europeans, 128 Anglo-Indians, and 9501 Indians, a total of 9790.

Results since 1884 are 4,525,871 tons of ore, yielding £17,060,587, and £8,100,594 in dividends.

ALLOUEZ MINING CO.

This is a Calumet & Hecla subsidiary, operating in Michigan. Development in 1915 covered 1485 ft. at No. 1 shaft, which is 3544 ft. deep; and 3373 ft. at No. 2, 3407 ft. deep. Stopes tributary to the former are up to the average grade, while those at No. 2 are a little better. New 60-lb. rails were laid throughout No. 1 shaft.

A comparison of the past three years is as follows:

| | 1915 | 1914 | 1913 |
|--------------------------------|-------------|-----------|-----------|
| Ore treated, tons | 534,705 | 354,457 | 236,663 |
| Refined copper, pounds | 10,043,459 | 6,056,548 | 4,091,129 |
| Refined copper per ton, lb. | 18.78 | 17.09 | 17.29 |
| Cost, cents per pound | 9.31 | 11.18 | 12.09 |
| Price received, cents per lb. | 18.166 | | |
| Gross revenue | \$1,859,566 | | |
| Operating profit | 924,681 | | |
| Dividends paid (2 of \$1 each) | 200,000 | | |
| Quick assets | 963,811 | \$363,823 | |

At No. 1 mill, at Point Mills, of two stamps, one is crushing Hancock ore. These are simple stamps. At No. 2 mill at Hubbell, one unit crushes Allouez ore, the other Centennial. Two new Nordberg compound stamps are being erected.

CENTENNIAL COPPER MINING CO.

This is a Calumet & Hecla subsidiary operating in Michigan, and notes on the mills are the same as those in the Allouez report below this one. Openings at No. 2 shaft, 4293 ft. deep, totaled 2366 ft. No. 1 shaft is 3821 ft. deep and is used entirely for men, material, and pumping. At No. 2, good ground was opened at No. 31 and 32 levels. On August 13 this shaft was badly damaged by fire.

Results during the past three years are as under:

| | 1915 | 1914 | 1913 |
|---------------------------------|-----------|-----------|-----------|
| Ore treated, tons | 150,191 | 138,136 | 85,443 |
| Refined copper, pounds | 2,347,500 | 2,287,130 | 1,612,262 |
| Refined copper per ton, pounds | 15.63 | 16.56 | 18.87 |
| Price received, cents per pound | 18.145 | | |
| Cost, cents per pound | 12.45 | 12.56 | 13.38 |
| Gross revenue | \$434,734 | | |
| Profit | 142,440 | | |
| Quick assets | 273,118 | \$24,635 | |

STANDARD SILVER-LEAD MINING CO.

This company operates at Silverton, British Columbia, with G. H. Aylard as general manager. Mine development covered 5749 ft. Ore extracted in 1915 was 39,447 tons. Of this, 3557 tons, averaging 54.69% lead and 93.43 oz. silver was shipped to smelters. The mill treated 35,920 tons, yielding 4804 tons of lead concentrate containing 59.84% lead and 97.98 oz. silver, and 4401 tons of zinc concentrate assaying 42.51% zinc and 23.04 oz. silver per ton. The cost of all departments totaled \$5.44 per ton. The total income was \$799,473, of which \$510,430 was profit. The surplus, after paying \$250,000 in dividends, was \$260,430. Profits to date are \$2,201,757.

INDUSTRIAL NOTES

Information supplied by the main factories

A New Direct-Current Generating-Set

A generating-set for marine or stationary service, and especially adapted for lighting or power service in small plants, and for exciters for large alternating current generators in power stations is now on the market. It consists of an American Blower Co. single or double cylinder, automatic steam-engine, and a type SK direct current generator made by the Westinghouse Electric & Mfg. Co., East Pittsburg, Pennsylvania, direct-connected to the engine-shaft. For lighting or power service the standard pressures are 125 and 250 volts. For this service generators are furnished having the compound field windings so proportioned that the same voltage is obtained at full load and no load. For special systems where 125 volts are required for lighting and 250 volts for power, the larger sized generators are supplied for three-wire service. These three-wire generators will take care of any unbalancing of the two sides of the system up to 10% of the full load.

The set is simple to operate and requires little attention. The generator is mounted on the same base with the engine to which it is direct-connected. The bearings, brushes, and commutators are the only wearing-parts. The engine is quiet in operation and has automatic lubrication by pump and gravity, with large cooling, settling, and filtering area. All wearing parts are easily adjustable, and perfect speed regulation is obtained.

This set is particularly well suited for use in isolated plants at mines and dredges, as well as for driving blowers, bucket-elevators, screw-conveyors, chain-drags, hoisting apparatus, cylinder driers, and centrifugal driers.

Commercial Paragraphs

The SWEETLAND FILTER PRESS Co. has leased the entire fourth floor of the new Sperry building, Brooklyn, New York.

The E. H. MOYLE ENGINEERING & EQUIPMENT Co., Los Angeles, California, has moved its offices to Ninth street, where its works are situated and where an ore-testing plant will be equipped.

L. G. E. Bignell, formerly sales manager for the DENVER ENGINEERING WORKS, and for the past three years engineer for the Mine & Smelter Supply Co. at El Paso, has accepted a position with the Colorado Iron Works at Denver as sales engineer.

Bound in 'fabrikoid' (a leather substitute), one of its products, the E. I. DE PONT DE NEMOURS & Co. of Wilmington, Delaware, has published a 111-page book describing briefly its manufactures, whom they are used by and what for. There are 251 distinct commodities listed.

The MONARCH ENGINEERING & MACHINERY Co., San Francisco, claims to have perfected a Chilean mill in which automatic adjustments are obtained whereby a pulp of any practical degree of fineness can be delivered in one operation. The driving-spider is slidable on the drive-shaft.

Alternating-current generators, engine and belted types, are described in ALLIS-CHALMERS Bulletins 1698 and 1699. Illustrations are given of the most important parts of the generators; also of actual installations, where gas, oil, and steam engines are used with the electric machines.

A 16-page booklet on graphite for cylinder lubrication—both steam and gas cylinders—by the JOSEPH DIXON CRUCIBLE Co. of Jersey City, gives concise facts about this important subject, also about lubricators that are made to use graphite alone or

with oil. In one instance a reduction of 52.5% in lubricating cost was reported when using graphite.

Duntley electric grinders of various types are described in Bulletin E-39 of the CHICAGO PNEUMATIC TOOL Co. These machines are especially adapted for use in foundries, machine-shops, structural-shops, and for grinding rails on railways. Bulletin 192 deals with stone tools, stone dressers, air-compressors and equipment for yards where stone is cut to certain designs.

The constantly increasing tonnage produced by the Luckie 2 Tungsten Mines is causing that company to continue increasing its milling capacity. It has just given the DENVER QUARTZ MILL & CRUSHER Co. the third order for Denver quartz-mills. The first equipment installed in the Luckie 2 mill in 1910 was supplied by the Denver company. The mill is in constant operation, 21 hours a day. The Luckie 2 is among the large mine and mill operators in Boulder county, Colorado.

The Montana Power Co. of Butte, Montana, has recently placed a contract with the S. MORGAN SMITH Co. of York, Pennsylvania, for four 15,000-hp. vertical hydraulic turbine units to operate under a head of 100 ft. These machines will be installed in connection with the Holter development on the Missouri river near Great Falls. The S. Morgan Smith Co. is also building for the Great Falls development of the Montana Power Co. two 16,000-hp. vertical units, which, together with the four recently installed, will make approximately 100,000 hp. in Smith wheels at the Great Falls plant.

Bulletin No. 70-C, from the SULLIVAN MACHINERY Co., Chicago, describes its class DR-6 mounted hammer-drill with water attachment. This has been on the market for the past 18 months or 2 years, giving unusual satisfaction for driving, tunneling, and a wide range of general mining work of the heavier drilling variety. Certain mechanical features distinguish this drill from others of the same general type hitherto made. These features include: single throttle control of air and water, absence of external valve-chest, small front-end rendering changes easy, and use of hand-operated lock-ring for releasing steel from the chuck. Other interesting features are fully described in the bulletin. This machine uses hollow round steel with lugged shanks. In the Joplin, Missouri, district, it is used for drilling the flat slope holes up to a depth as great as 16 ft., while in Barre granite on down holes, it has drilled as deep as 18 ft. successfully. The DR-6 is meeting with great success in such fields as Joplin, Butte, Deadwood, Jerome, northern Michigan, Alaska, and British Columbia.

The INGERSOLL-RAND Co., New York, has recently issued three new bulletins as follows: Form 9023, 24 pages, 6 x 9 in., on 'Imperial' tie-tamping outfits. This apparatus had a gradual development under actual working conditions on some of the largest railroad systems in the country, extending over a period exceeding two years. It is comparatively new to the trade, but the railroads have been quick to appreciate the economy attendant on the use of one or more of them. The taper is employed principally in the operations of laying new track, replacing old track, and surfacing existing track, but is further effective in special applications. It will produce equally effective results in any kind of ballast—stone, gravel, earth, cinders, chat, slag, etc. Form 3026, 40 pages, 6x9 in., catalogue on Ingersoll-Rogler class PRE duplex direct-connected electrically-driven air-compressors. Among the principal features of design may be mentioned the Ingersoll-Rogler valve, the clearance controller, direct-connected drive, improved-inter-cooler, and auxiliary water-separator. The catalogue is printed in two colors, and is profusely illustrated to show construction details. Four pages are devoted to pressure charts and tables showing sizes and capacities. Form 3312, 20 page, 6x9 in., catalogue on Imperial XB duplex power-driven air-compressors. Illustrated.



EDITORIAL



T. A. RICKARD, Editor

PREPAREDNESS parades prove, not so much the willingness to enlist, as the ability to organize; and that is no small matter. Moreover, these parades will impress Congress, which is looking for signs of public opinion.

MOST of the gold produced by the South African mines, at the rate of \$16,000,000 per month, is now being shipped to Canada by way of Japan, instead of going to London. The output of the Rand continues to grow; in May it was 770,000 ounces, and for the first five months of this year the total is 3,867,000 ounces, compared with 3,651,000 ounces in the corresponding period of 1915.

AT this time of writing, the Mexican crisis is approaching the point of explosion. The exchange of notes portends a rupture, for we question whether Carranza can acquiesce in the continuance of American military occupation without inciting a revolt among his own followers. Similarly, the President has declared himself in terms rendering it impossible for him to comply with Carranza's demands. Intervention appears inevitable.

IRON being the barometer of industrial conditions, it is satisfactory to note the movement of iron ore on the Great Lakes. Navigation opened in April, and to the end of May there was shipped to lower lake ports a total of 10,107,991 tons, compared with 5,517,191 tons in the corresponding period of 1915. During May the production of iron in the United States reached a total of 3,351,073 tons—a record—as compared with 2,263,470 in May last year and 2,822,217 in 1913.

FIRE-INSURANCE is a matter liable to be lightly regarded until the opportunity for remedying carelessness is gone. The recent burning of a mill belonging, fortunately, to one of the most prosperous mining companies in California, prompted Mr. Charles T. Hutchinson to write the article, appearing in this issue, on the subject of insurance. He writes as an engineer, not an agent in quest of premiums, for he is manager of our business department. The reader will note that the counting-house of this publication can swing a pen to literary purpose.

HIGH ocean-freight rates are having sundry unexpected effects, one of which is the fact that it has become profitable to tow 3000-ton sailing-vessels from San Francisco to Balboa, the Pacific terminal of the Panama Canal. The voyage, under such conditions, takes 18 days. We are informed that one tug, the

Hercules, well known at this port, is to tow a vessel all the way to New York, through the Canal. More than a week is saved between Cristobal, the Atlantic terminal, and New York by towing a vessel, as compared with propulsion under its own sails, besides a similar saving in the Pacific portion of the voyage.

BROKERS' circulars continue to exclaim at the low price of copper-company shares as compared with the increase of dividends. Surprise is unnecessary. No mystery exists. The public is aware that the high price of copper is abnormal, being due to conditions that are not likely to persist. In valuing copper prospects, we note that many engineers use 15 cents as a price on which to base estimates of future profit. This figure is slightly above the average of the period preceding the War, but it is fully justified by reasonable expectations. We expect a price higher than 15, but considerably lower than 28, when peace is restored.

ACCORDING to Mr. William C. Redfield, Secretary of Commerce, the proportion of industrial products consumed for warlike purposes represents only 20% of the total volume of American exports during 1915, but as \$190,000,000 of similar material was exported in 1913, it may be concluded that only 15% is actually War business. Labor in the United States is benefiting enormously from the War. For example, the Industrial Commission of the State of New York reports an increase of 21% in the number of employees in April as compared with a year previous, while concurrently the total of wages has increased by 37%. Wages have increased faster than work.

INDEXERS might have had trouble with Mr. F. H. Mason's article on Cobalt if we had not added a sub-head of an explanatory character. It is true the mining district of Cobalt gains from the increased use of the metal cobalt in the arts, but the reader who is seeking information concerning the one does not care to be sidetracked onto the other. Mr. Mason writes on his subject with his customary skill. Owing to our Procrustean method of making articles fit pages or columns, as the case may be, we had to omit a friendly reference to Mr. Herbert T. Kalmaus, who is conducting research on cobalt at Queens University, Kingston, Ontario, and has published sundry admirably lucid descriptions of his work. We are glad to make the acknowledgment for Mr. Mason.

OUR compliments to Mr. H. E. McCray, editor of 'The Engineer,' the 1916 annual publication of the students in the Michigan College of Mines. It does

credit to all concerned. Among other features we like the highly intelligent faces of the Tau Beta Pi men. Looking through the directory of alumni, the fact is brought home that the Houghton School has given the mining industry a large number of useful men, among whom we recall personally W. E. Parnall, W. J. Uren, John Heaton, John G. Kirchen, W. M. Cameron, W. L. Honnold, A. E. Seaman, F. T. Greene, Charles W. Wright, Scott Turner, Louis A. Wright, and P. B. McDonald, besides many others known to us by repute.

ON another page we give part of a letter written by a mining engineer who has done effective work on the Italian battle line. He would be the first to insist that this is the sort of duty that has been done well by many of our profession serving with the various armies in Europe. We call attention to the large blast described, by which 15,000 tons of rock and earth was blown skyward by 5 tons of gelatine containing 92% nitro-glycerine.

ELECTION of Messrs. Robert C. Gemmill, C. B. Lakenan, John M. Sully, and Louis S. Cates to the boards of directors respectively of the Utah, Nevada Consolidated, Chino, and Ray Consolidated copper companies indicates that it is becoming recognized as desirable to associate the resident manager of a large mining enterprise with the general direction of affairs; in short, financiers are appreciating how much their industrial success depends upon the man actually in charge of operations.

THE American Zinc, Lead & Smelting Co., usually abbreviated to the American Zinc Co., has absorbed the Granby Mining & Smelting Co., which owned zinc and lead mines and smelters in the Missouri and Kansas region. The Granby was an old company owning large tracts of mineral land in south-west Missouri, besides coal-lands in Illinois, its entire 'net quick assets' being reckoned at \$2,750,000. The American Zinc Co., which is owned largely in Massachusetts, made a profit in 1915 of \$5,293,878 from wide-spread operations, including zinc mining and smelting and sulphuric-acid manufacture, in Tennessee, Missouri, Kansas, and Wisconsin. The famous Mascot brand of spelter, produced from mines in eastern Tennessee, is free from lead and therefore is suited for making the brass used in cartridges. Among the company's activities is the smelting of 8000 tons of zinc concentrate per month from the Butte & Superior mine, in Montana.

JAPAN is the second greatest copper-producing country in the world, ranking next to the United States. Her annual production is about 150,000,000 pounds, a total approximately equal to the 1915 output of Utah Copper or the Phelps, Dodge & Co.'s mines. In other words, Japan contributes about 7½% of the world's production as compared with the 60% produced by this country. During 1915 a relatively large proportion of the Japanese production went to Russia, and a con-

siderable portion of the remainder was exported to the United Kingdom, the United States, and France; the customary exports to China, Germany, and India being much reduced. In fact, instead of exporting copper to China, Japanese speculators imported Chinese brass coins in large amount and melted them for the copper and zinc. A noteworthy part of Japan's new production of zinc is thought to have been derived from this melting of Chinese coins.

ON June 14 the alumni of the Massachusetts Institute of Technology assembled simultaneously in 35 different cities in order to take part in a celebration of the semi-centenary of the 'Tech.', and the completion of the new buildings on the Charles river, at Cambridge. All of these 35 assemblages were put in touch with each other and the proceedings at Boston by means of an elaborate system of telephonic communication, in which 5000 men were able to participate. Among the speakers was Mr. Michael I. Pupin, the inventor of the coil that made long-distance telephony practicable, and Mr. J. J. Carty, who was the engineer to put the idea into successful service. Some of the speakers were heard in San Francisco as clearly as if they were sitting across the table, thanks to their excellent enunciation. The affair was a great success and afforded a scientific method of celebrating an event that will give pleasure to many outside the alumni association of the Institute of Technology, which includes many of our most capable mining engineers and metallurgists.

TUNGSTEN remains fairly steady at \$30-35 per unit. We understand that one reason for the weakness of the market is the fact that a group of speculators at New York had over-loaded themselves with concentrate in expectation of higher prices. The recent drop has had the effect of stopping importation from South America. The Japanese wolframite that has been coming to this country is dirty, from a metallurgical standpoint, for it contains bismuth, antimony, and other deleterious ingredients. On the whole, the scheelite from Atolia is about the cleanest product sent to the makers of tool-steel. Several alleged discoveries in California and Arizona have proved grossly exaggerated, the first sampling having been misleading. Another curious feature of tungsten mining in the West has been the development of ore-stealing; in the Atolia district several men have been caught red-handed and it appears that agents of the steel companies stimulated theft by offering \$85 per unit during the period of maximum prices.

DISCUSSION in this issue starts with a thoughtful letter by an obviously experienced metallurgist in Bolivia. Mr. Sühlein's opinions are so well expressed as to compel attention. In the second contribution a mining engineer not long ago in British Columbia discusses a subject concerning which we have written more than once. His way of stating the case is interesting, but he will pardon us for suggesting that it reads like that of a miner that quit mining to go ranching and has

found the latter so little attractive that he turns back to the digging of ore. The public that buys 10-cent mining shares is the same public that dabbles on margins in other markets. We agree as to the futility of warnings, if for no other reason that such small speculators do not read a technical periodical like this, which concerns itself mainly with the more serious work of the mining industry. The 'game' and the 'industry' are only related by marriage. That some of the money raised by gamblers is instrumental in discovering real mines, that is, profitable holes in the ground, is not gainsaid, just as some of the money won at Monte Carlo may find its way to the support of a hospital; on the contrary, many a wild-cat *in esse* is a mine *in futuro*; one of the essentials to finding ore is exploration, and that much the digging of a wild-cat does contribute. We mining engineers must not sneer too much at what appears to us to be misdirected effort, having modest regard to the large proportion of well-directed effort that fails. This concession being made, we agree with Mr. Percy Williams that the fundamentals to success in mining are money and an experienced man to direct the spending of it—a man experienced both in mining and the spending of money. We publish three contributions dealing with the flotation process as expounded in our columns. Mr. G. D. Van Arsdale defines 'froth' and discusses the rationale of it in a useful way; he also comments upon the essentials of a 'film.' Mr. Alfred Stansfield's explanation reminds us of Dean Swift's definition of an archdeacon as a man who performs archidiaconal functions. Mr. H. W. DuBois throws light on the treatment of sundry copper ores, particularly those that are coated by products of oxidation, and the use of sulphuric acid for the removal of such a coating. Just as we were going to press we received the letter from Mr. J. W. Swaren, notifying us, and our readers, that he is about to organize a volunteer engineer corps, with the concurrence of Army officers in San Francisco. Mr. R. S. Burdette's information concerning the Mexican silver dollar is timely, for it may be that the peso will be at a severe discount in a few days.

Employer and Employee

Among the signs of the times we note a better understanding of the relation of capital to labor, or, to be more precise, between the employer and the employee. Two departures from custom may be instanced, the first being the allotment of a portion of dividend as a reserve fund for distribution among employees, as has been done by the directors of the Nevada Wonder Mining Company. The scheme is to set aside a sum equal to 5% of the dividends paid annually and distribute it among the men that have been in the employ of the company for one year or more. The object, as stated by the directors, is "to establish a co-operative system by which the employees of the company may participate in the profits." As our readers are aware, the U. S. Steel Corporation set aside a large block of stock for purchase, at a rela-

tively low price, by its employees, and thereby introduced a profit-sharing system, out of which the men must have done well. It is not unusual for companies to add a bonus to the Christmas pay-roll, and most of the big copper companies have established a sliding scale of wages based on the price of copper, but the Nevada Wonder plan is an example of direct profit-sharing by a mining company. The second incident to which we refer is the opening of a town-club at Plymouth. The building is the gift of the Plymouth Consolidated Gold Mines and is meant for the use not only of those working in that company's mine, but of the townfolk generally. The management is in the hands of a committee of seven members of the club, four of whom represent the employees of the company and three represent the other residents in the town. The dues are \$1 per month. The purpose, besides providing comfortable quarters and orderly amusement, is to bring the whole community together on a friendly foundation. A 'relations' committee is chosen by the members to discuss and adjust grievances or misunderstandings; in short, instead of the company's interest being treated as alien, it is made a part of the local welfare. Trivial differences between employer and employee will be adjudicated before they become serious; also any attempt by avowedly anarchistic organizations, like the Western Federation of Miners, to make trouble will be rendered fruitless by the growth of a community spirit, likely to help the mine management so long as it shows itself reasonable and fair to all concerned. After all, the people of the town in which, or near which, a mine is situated have a direct interest in its welfare, in the continuity of its operations, and the maintenance of its success. We welcome anything that will destroy the idea that the employees are helots and the employers satraps of industry. Co-operation is essential to industrial success and fair-dealing is the direct way to ensure such co-operation.

Preparedness

Insistence upon proper preparation for national defence has been made a plank in the platforms of both political parties; therefore it may be considered a non-political subject. We propose to discuss it in relation to the engineering profession. In the first place, the engineer is a man and a citizen, he has duties to the community and the country, and he is prepared to serve both. Indeed, one of the faults of the age is that it makes too much of the lawyer, with his gift of talking, and too little of the engineer, with his ability to do things that are of the greatest practical usefulness. This is an engineering age and it is high time that professional talkers were retired to their proper place in the economy of things. Local and sporadic efforts have been made to find scope for the talent of the non-military engineer in any scheme of national mobilization. Of these the most promising is that which is now in the hands of a committee representing the national engineering societies. Mr. William Barclay Parsons is chair-

man of this committee, which has received proper consideration from military headquarters at Washington. At the instance of the War Department a bill has been introduced in Congress to provide for the organization of a Reserve Corps of Engineers, which is to supplement the Engineer Corps of the Regular Army in the event of war. This Reserve Corps is to be formed along lines similar to the existing Medical Reserve Corps and in conjunction with the latter, with the purpose of making provision for a supply of officers able to superintend engineering operations of the diversified kind incidental to modern warfare, such as the building of railroads, motor-roads, bridges, gun emplacements, and trenches. The technical men recruited from among civil engineers will also bring to bear their wide knowledge of the manufacturing and contracting businesses of the country, all of which would be called upon, to the utmost of their resources, in time of war. We used the term 'civil' engineer in its true sense, which is 'non-military.' When the profession was yet insignificant in point of numbers it was organized, both in England and in America, as a society of civil engineers, in distinction to the military branch of the profession. Since then the mining, mechanical, electrical, and chemical branches have developed and grown so as to require organizations of their own, all of which are included under 'civil' when discussing military science. Here we may remark that mining itself has a military origin, that the word 'mine' had a military significance before it became industrial, and that the European war has demonstrated the full importance of the mining engineer, whose tunneling, mining, and counter-mining are today among the most dangerous and most effective of the operations at the front. It is proposed to give commissions for a period of five years, renewable at the discretion of the Secretary of War, so that the unit may be retired without friction. Two weeks instruction yearly is to be the minimum; and while this may seem little enough, it is to be remembered that the work to be done in war is much the same as in peace, save for minor differences that can be apprehended by an intelligent and willing learner in short order. It is hoped, of course, that the younger men will go to the summer camps and avail themselves of longer periods of training, as circumstances permit. Meanwhile one fundamental purpose will be fulfilled, namely, the mobilization of engineering experience. The national resources in this kind of human material will be recorded by a card-index system, and presumably the help of the engineers will be utilized further in the obtaining of further data concerning labor skilled in construction work of every description. Similar duty is being done by the Advisory Committee to the Naval Board in other departments of industrial activity. Thus the result will be, if the plan is carried out to full fruition, to mobilize the entire resources of the country in time of peace so as to know where to find what is wanted on the sudden emergency arising from a declaration of war.

Whether the Army or the Navy as it now exists could protect the country against attack, it is not necessary

to discuss. It is past discussion. We venture to point to the fact that the United States, by reason of its enormous length of coast and the tapering of its continental area southward, is in effect a peninsula. Again, by reason of the only passage by water, except around Cape Horn, being the Panama Canal, we have there a highly vulnerable artery of maritime communication. In short, the United States is vulnerable along an enormous front.

Another phase illuminated by events in Europe is the dependence of armies and navies upon factories and workshops. Even the systematic preparedness of Germany under-estimated that basic factor, so that while an army of unquestioned efficiency and numbers was ready at the outbreak of war to take an instant offensive, it is now becoming evident that even Germany was not adequately organized to supplement her military preparedness with the requisite supply of munitions. It is probable that in future wars, as in this, a prime requisite will be a manufacturing industry so organized and so flexible as to be ready to produce whatever is wanted, in the way of warlike material, with the minimum of delay. The preparation will be useful for industrial competition as well as war; it will be a preparedness for conditions that cannot be anticipated. Just now, it looks as if an efficient aerial navy might prove the most effective defence against attack by land or sea. Nevertheless, neither armies, ships, nor aeroplanes can be effective unless the right kind of man is behind the gun. Some sort of training is required, even if Mr. Edison's prophecy be fulfilled and a machinist behind a machine prove to be the most destructive weapon of warfare. Whether you call him a 'machinist' or a 'soldier' matters not; he must have a sense not only of initiative, but of discipline, and that is not taught or learned in three weeks, especially in a genuine democracy.

One more point may be mentioned. No matter what the weapons or apparatus of war, they must be made of metal. The mineral resources of the United States are such as to ensure an adequate supply of nearly all the metals required for the purpose, and substitutes for those that we lack should be found; for instance, tin and nickel. Tin, used chiefly for plating and solder, is not obtainable in quantity on this continent, at least north of the Rio Grande. Nickel is scarce in the United States but plentiful not far across the line in the territory of our friendly neighbor, Canada. Of most of the other essential metals, particularly copper, zinc, lead, and steel-making substances, we have a superabundance. However, this phase of preparedness should be investigated carefully and the War Department, guided by the Geological Survey, ought to be placed in a position to suggest the nursing of such branches of the mining industry as are essential to the provision of specific metals or minerals, for instance, nitrate. If protection by tariff is necessary to encourage the production of sundry ingredients necessary in warfare, and now lacking, then even the sincerest free-trader may well allow an exception. In this department the mining engineer is able and willing to help, as in any other.



DISCUSSION

Our readers are invited to use this department for the discussion of technical and other matters pertaining to mining and metallurgy. The Editor welcomes the expression of views contrary to his own, believing that careful criticism is more valuable than casual compliment.

Cyaniding Flotation Concentrate

The Editor:

Sir—In the description of the plant proposed for the cyanidation of flotation concentrate by A. E. Drucker, published in your issue of April 8, 1916, occur several statements to which I must take exception.

First, how does Mr. Drucker know that a combined hydraulic and mechanical classifier will make a sand-product with more moisture (30 to 35%) than a Dorr or Akins machine? Since the machine proposed by him exists on paper only, this figure must have been arrived at by reasoning, and it is easy to show that it is precisely the other way. The moisture in mechanically-separated sand depends on the time it is given to drain, therefore decreases reciprocally with the length and the angle of inclination of the classifier. The finer the sand, the more moisture it will retain, so that the sand delivered by a combination classifier, containing less fine material on account of the hydraulic separation in the spitzlutte, ought to be drier than the product from a straight mechanical device.

Mr. Drucker recommends the combined classifier to obtain separation at a coarser size, which is perfectly right. However, he loses sight of the fact that classification is not a separation of particles at a definite size, but that the settling velocity of a grain determines whether it will pass into the sand-product or into the overflow. Separation at a definite size can only take place with perfect homogeneous material, but not with an ore-pulp containing minerals of widely varying specific gravity. A classifier, be it hydraulic, mechanical, or a combination of both systems, necessarily delivers a sand-product with smaller heavy grains and larger light grains. In this connection, I fail to see the point in Mr. Drucker's remark on the work of a Dorr classifier at Inspiration. (M. & S. P., March 25, 1916). I am certain that if the 28.8% of *minus* 48-mesh material had to be eliminated from the feed to the mills by classification, this would result in an undesirable increase of *plus* 48-mesh sand in the overflow.

Further, I cannot at all share Mr. Drucker's dislike of elevators. The difficulties are always the result of faulty construction or lack of attention, but I agree that when a pulp is so fine as to pass 100-mesh, pumps are also satisfactory and cheaper to install. It is not true that the Frenier pump is only fit to lift to eight or ten ft.; I have pumped sandy pulp with a 54-in. Frenier to a height of 16 ft. without trouble at an elevation of over

12,000 ft. above sea-level. Inconveniences of this pump are its liability to choke with thick pulp and the irregular discharge, which in most instances necessitates the installation of an equalizer-tank with spigot through which 18 to 24 in. of height is again lost.

M. G. F. SÖHNLEIN.

Machacamarea, Bolivia, May 10.

The Same Old Game

The Editor:

Sir—A quick turn of the wheel and we have with us again, for a long or a short stay, a condition of 'easy money,' meaning new accumulations of surplus capital and speculative symptoms. About once in each decade this epidemic of speculation sweeps over our country from coast to coast. Its presence in different parts of the country is characterized by certain concurrent symptoms, a distinct mania for buying without regard to value, on the Atlantic seaboard the mania finding expression in the desire to own 'War babies;' the Middle West has a penchant for toying with high-priced food-product issues, while farther west, especially on the Pacific Coast, the germ manifests its presence by the uncontrollable desire evinced by the patients to become the owners of a real mine, preferably a gold mine, or, failing that, they want to purchase a wild-cat of some kind.

The outbreak of this disease in any particular community is at first imperceptible, even subtle, but its presence becomes discreetly manifest in the suggestive enlargement of brokerage quarters, and a renewed thronging of our hotel lobbies with threadbare vendors of refurbished schemes. Bred from psychic mixtures of the germs of war, science, and social re-adjustments, the fever of "something for nothing" is in the blood and the leeches are ready at hand. Heaven knows where all these 'doctors' have been hibernating since 1907, but here they are with the same old methods of blood-letting at 12½ cents per share—"next week advanced to 20 cents—get in."

The dear old public is in the market, the clumsy, non-thinking, humor-lacking public, to whom surplus wealth is a detriment from which they must be promptly relieved, at least once in every ten years, otherwise there would be no development of the mass.

Well; what are we going to do about it? Do you think a word of warning will do any good? Not a bit of it! Even our most conservative bankers have thrown up

their hands in despair after futile attempts to keep the lid on these pots of rainbow gold. We, the cautious ones, stricken in a succession of similar epidemics dating from away back even to old Comstock days, may shake our worldly wise heads doubtfully and then join in the scramble with the rest for easy money. It is a disease whose only known treatment is copious blood letting.

Recognizing the disease and the cure, why waste time in vain forebodings, but rather let us deliberate upon the ultimate benefits that certainly do accrue after the virulence of the attack has subsided and the financial pulse once more beats normally. A hundred schemes for blood letting are conceived in the high places and the low places—the sierra and the desert, delicately whipped into shape in hotel-lobbies, clubs, and the back-rooms of real-estate and brokerage offices—and what is the result? One good money-making mine as a “shining example” for another decade at least. *Gold* mine, of course. It is so quick. Ten-cent stock becomes worth a dollar in a few jerks and the fever burns itself out, naturally, in spending the money. Or perhaps the 10c. stock drops to $\frac{1}{2}$ cent and is removed from the board and the fever subsides, unnaturally, making an effectual cure, and carrying with it at least ten years immunity.

Mining is a great industry, our greatest, next to agriculture. Its rewards are lavish and spectacular, but spasmodic and quite likely to be lavishly expended. When all is expended one cannot go to the bank, like the farmer can, and borrow at 8% to tide him over until next year's crop comes in. That's the difference between mining and agriculture—the only difference. Failure in the one means a valueless hole in the ground and a trunk-full of worthless shares—while failure in the other means selling the farm and the Ford and starting anew.

Since the symptoms of speculative fever have a distinctive accompaniment of mania for the acquisition of possible gold mines and since the antidote is either the complete gratification of the mania or a complete blood-letting, it would seem that a system of treatment embodying a maximum of gratification and a minimum of blood-letting should be the compromise sought. Accepting these conclusions, it behooves the patient to pay some regard to the fact that a newly-discovered gold camp is not necessarily the most fruitful field for the substantial gratification of his desire. The only superior merit of a new mining district lies in the fact that it is usually easier to finance a prospect there, temporarily, at least. It becomes a fashionable centre, a resort for professional blood-letters and their fever-stricken patients. The chief disadvantage of these new camps lies in the fact that it costs more for treatment (of fever) and it costs much more to obtain meritorious mining ground, suitable for prospecting, development, and exploitation, than it does in places less advertised but equally meritorious.

Every strike of real merit generally results in the ultimate establishment, in the immediate area, of three or four persistent profitable mines. You can follow the

trail of all lode mining strikes for the past thirty years and note these resultant few mines still operating in each camp, holding up their heads amid the abandoned remnants of countless mere blood-letting enterprises, Deadwood, Creede, Cripple Creek, Tonopah, Goldfield, Rawhide, Cobalt, Porcupine, and Rochester, to say nothing of lesser camps.

Since we have the fever and are going to speculate in gold mines, let us do it as rationally as possible. There is only one way to do it rationally and that is under proper guidance. If we put our money into new gold mining stocks or into un-incorporated, un-prospected, un-developed mining claims, let us be certain first of three fundamentals:

(1) That the money raised by stock-selling or private subscription is expended for prospecting, development, and operation.

(2) That some competent mining engineer has examined the projected enterprise and advanced his opinion that it is a “good gamble” at least. The best engineer in the world cannot say more than that in reference to an undeveloped piece of mining ground.

(3) That operations at the mine are superintended by experienced and honest mining men.

PERCY WILLIAMS.

San Francisco, June 8.

We discuss the subject of this letter on our editorial page.—EDITOR.]

The Flotation Process

[The following discussion appears in the June bulletin of the Canadian Mining Institute. It refers to a paper entitled ‘The Flotation Process’ presented by T. A. Rickard at the 18th annual meeting of the Institute and therefore deals with the subject as presented by the same author in the MINING AND SCIENTIFIC PRESS during February and March 1916.]

G. D. VAN ARSDALE: Mr. Rickard's paper is extremely interesting and comprehensive, covering as it does the history, practical development, theory, patents, and some of the litigation of flotation. The work that I have been doing has, until recently, been confined entirely to an attempt at investigation of the theory of the subject, so that I can only comment on that portion of the paper relating to this phase. Any part of this subject is very complicated and difficult from a research standpoint and it seems to me therefore that its study may be facilitated by making, when possible, some simplifying assumptions. The most prominent feature of our modern methods is the foam or froth. Let us consider what a ‘foam’ or ‘froth’ really is. A scientific definition would be a matter of some difficulty, but for practical purposes we can consider that a ‘foam’ or ‘froth’ is really only a collection of bubbles of greater or less size or number. We can accordingly simplify matters greatly, by considering a single bubble. Now a single bubble may be roughly defined as a surface of liquid in contact with or in some

cases entirely surrounding a quantity of gas. With this definition we can make a still further simplification, which is that what we ordinarily call a liquid surface answers to a part of this definition, that is to say, it is a liquid surface in contact with a gas, and we would accordingly expect a study of particles and oils on an ordinary surface to throw considerable light on the remaining much more complicated cases of practical flotation. If then we ask why does a particle heavier than water float on water surface we can attempt to answer this as follows: If the main cause is surface tension, there should be a definite relation capable of experimental verification between the maximum size of a particle that can float, and the surface tension of the surface. It has been stated that the maximum weight that can be supported on a surface is equal to the surface tension, that is 1 sq. cm. will support 81 mg. It can easily be shown however that 1 sq. cm. will support several times this weight, so that evidently the relation is not stated. From certain surface-tension formulae, however, we can calculate the maximum sized particle of certain shapes, for example, cylinders, that will float; and experimentally with clean copper wire of various sizes the actual size that will float is close to this theoretical maximum. This proves, therefore, that we are correct in assuming surface tension as one of our main causes. Other conditions, all of which can be proved experimentally by simple experiments, are:

1. Size and specific gravity of particle
2. Shape of particle
3. Inherent quality of surface to resist wetting, and
4. Films.

It is easy to show experimentally, as we also know from practice, that some films prevent and others promote flotation, also that these films may be either a solid, a liquid, or a gas, or an electric film, that is to say, an electro-static charge. Now summing up the above, we can state that a substance specifically heavier than water may be made to float, provided the size of particle be small enough, of proper shape with respect to size and specific gravity, and provided it has a surface film sufficient to prevent wetting, which film may be either a solid, a liquid, a gas, or an electro-static charge or a combination of these. You at once see that this statement is very close to a similar statement as to the conditions producing colloids, and the study of colloids as applied to flotation will, therefore, doubtless clear up the subject considerably. The main conclusion we have reached in the application of the above to the more complicated cases of actual flotation practice, is that surface tensions and the resultant of these which determines wetness or non-wetness of particles is the 'how' of flotation or, in other words, the immediate cause or mechanism of the results, and that the study of colloids and electro-statics will furnish the 'why' or the ultimate cause. Electro-statics will probably act as one of the explanations of wetness or non-wetness, and also possibly as one of the explanations for the attachment of films. The study of flotation oils at first glance also

seems hopeless in view of the number of these and the number of possible combinations, but we can also simplify this very much if we consider them from the standpoint of their functions.

Their main functions are evidently two:

1. To furnish a non-wet film on the particle
2. To furnish a froth by reducing the surface tension.

This at once gives us a classification of oils into two kinds with respect to these functions—

1. Oilers
2. Foamers

and by taking into account also the inter-action of physical qualities of one on the other in a mixture, we can have a somewhat rational basis for their study.

What we apparently have not so far obtained and need very much is a definite understanding and statement of the specific physical qualities of the oils themselves that they need to enable them to fulfill these functions and as a result of this a rational and scientific method of testing for their selection and use.

ALFRED STANSFIELD: In reference to the study of soap bubbles and their relation to flotation I have never been able to rid myself of the idea that the reason soap bubbles stick together is because of the stickiness of them.

H. W. DU BOIS: I also should like to express my appreciation of the value of Mr. Rickard's paper, and of the admirable manner in which he has presented the facts. The phenomena of flotation are apparently so simple that until quite recently investigation in this direction has been disregarded. It may, perhaps, be noted that whereas according to Biblical teaching the spreading of oil on water is supposed to cause its troubling to cease, in the case of flotation oil is a chief source of trouble. While one or two statements made by Mr. Rickard appear to me to be contradictory, he has succeeded in his paper in presenting the whole matter in a very clear and understandable fashion, which in view of the befuddlement caused in the past by the writings of partisan experts, represents a distinct service to the profession. Hoover, in the first edition of his book on flotation published in 1911-12, stated that it was impossible to treat by this process ores containing chalcocite or bornite. Chalcocite, however, is readily floatable; although bornite presents a more difficult problem, for bornite is invariably accompanied by a surface film, ordinarily considered now to be limonite, and this prevents the oil from coming into contact with the mineral particle. In an attempt to overcome the film effect on their oxidized ores, the Braden Copper Company started introducing the oil during the crushing period, so that a more intimate contact was obtained while the mineral surfaces were fresh. They found that it was possible to greatly increase the recovery in this way on all ores containing oxides or minerals with drusy surfaces, but recovery is by no means good even yet. When the feed is low-grade the loss due to the content of bornite is not important, but when high, as it is in the Alaskan mills (sometimes 20%), it is most important. The first attempt to overcome the effect

of this limonite film on the Alaskan bornite ores was a repetition of Braden's more or less successful work—that is, by means of fine crushing. But in the present instance this was a failure. It is, of course, possible to remove this 'film' by using sulphuric acid, but in an isolated region like Alaska the high cost of acid makes its use prohibitive. The difficulty of the problem led to a closer study of the 'reason' for flotation, and the electro-static theory seems to be the best explanation of the problem. Assuming this theory to be correct, then we can say that in flotation we have a system in which the mineral particles are positively charged and the gangue negatively. The oil particles are negatively charged, and so adhere to or 'wet' the mineral particles and repel or do not 'wet' the gangue particles. If then we consider that for some reason bornite is negatively charged, we have at once an adequate explanation of the fact that bornite has been unfloatable. Some work has been done along this line, and it has been found that by treating bornite to the fuming action of nitric acid, it is then readily floatable. This is simply a change of polarity due to high temperature, the negatively charged bornite becomes positively charged and is immediately 'wetter' by the oil and floats. It is hoped that a further study along lines suggested by the electro-static theory will yield important commercial results. I may add that a number of companies take care to regulate the feed to the flotation unit and keep it low in order to get high extraction. This possibly is correct, but their experience with high-grade ores has been that this is entirely unnecessary.

A Volunteer Engineer Corps

The Editor:

Sir—Following our conversation over the telephone, you will be interested in knowing that after a conference with Capt. Park, Col. Perkins, Col. Swift, and the Adjutant-General's office of the State of California, I have decided to recruit a battalion of engineers for use in the present emergency. I intend recruiting this battalion from all portions of the State, one company headquarters to be located in San Francisco, another in Oakland or Berkeley, and a third at Los Angeles.

There are no volunteer engineer troops west of Golden, Colorado, and not nearly enough to supplement such troops as are at present mobilized, so that it is quite certain when this battalion is recruited to its full strength, that it will see service. I am taking the necessary steps to have engineers added to the California quota, as these troops will be certainly needed to properly take care of the castrametation of the present mobilization. Provisional headquarters are at the office of the Pelton Water Wheel Co., where I can be reached at any time.

As this battalion is the first of the engineers, outside the National Guard, to offer its services to the War Department, the probability of its being accepted is very high. The San Francisco company will be organized tonight, the Trans-Bay company will be organized tomorrow night, and the Los Angeles company within the

next two or three days. Persons in the South desiring information regarding the Company can secure it from Charles T. Leeds, Central Bldg., Los Angeles.

I trust that you will be able to find space for this in your columns.

J. W. SWAREN.

San Francisco, June 19.

The Mexican Silver Dollar

The Editor:

Sir—Referring to the last paragraph on page 774 of your issue of May 27, 1916: *The Economist* is in error regarding the Mexican silver dollar. The Mexican gold dollar is worth approximately 49.8 cents U. S. or a little less, depending on the amount of service and consequent loss in weight the pieces have undergone. The old-style Mexican silver peso, commonly called "*peso fuerte*" weighs, when new, 27.073 grams and contains 0.9027 silver or 24.4 grams. The tolerance in fineness being plus or minus 0.002 and the tolerance in weight, plus or minus one gram. Of several 100 lots of used *pesos fuertes* weighed, the average weight of this coin in circulation is 27 grams, with negligible variation. The silver content of 24.4 grams or 0.785 oz. troy is worth 50c. U. S. when silver is worth 63.7 cents per ounce. Under normal conditions this silver peso, with liberty cap on one side and eagle on the other, is worth approximately 50 cents U. S. regardless of the price of silver. At present it must be classed as unrefined silver bullion.

The fractional silver coins are of less weight and contain less silver. The 50-centavo pieces, *litos*, weigh (actual average of several P100 lots) 24.8 grams per pair and are 800 fine; the silver per peso being 19.8 grams or 0.636 oz. troy. They are worth 81% of the silver peso for their silver contents.

R. S. BURDETTE.

Guadalajara, June 9.

SPAIN is said to be beginning an industrial growth of importance. The Spanish people, who have neglected the economic development of their country's natural resources for generations, are turning their attention to water-powers, mineral deposits, and manufacturing. This is a direct result of the loss of their colonies in the Spanish-American war, which made it necessary to look at home for opportunity rather than seek it in the West Indies or the Philippines. As is well-known, Spain has an important mineral output of lead, copper, iron, quicksilver, and sulphur. Barcelona, the chief industrial centre, is a seaport of 750,000 people on the Mediterranean Sea. It is possible that some of the Americans who are learning Spanish with the intention of using that language in Latin-American countries, may become engaged in operations in Spain.

HAMMER-DRILLS were originally only of one type, stopper-drills for up-holes. Now there are also mounted hammer-drills and sinkers.

Fire Insurance on Mining Property

By Charles T. Hutchinson

PREFACE. Everybody nowadays takes out fire-insurance on whatever he may possess that is subject to fire risk. It is the thing to do. The conventional procedure is somewhat like this: The prospective insured has a friend, a son, or a nephew; or some friend or director of his company has a friend, a son, or a nephew who is in the fire-insurance business. What could be more natural, therefore, than to give John, Mike, or Bill your fire-insurance, because, forsooth, he is a good fellow and can play a good hand at auction?

When the policies arrive, they are turned over to the cashier or book-keeper who chucks them in the safe, pays the bill, and then forgets all about the transaction—unless there should be a fire. Then all is changed. If the fire-proof safe has by some lucky chance escaped destruction, the insurance policies at once become objects of consuming (if not consumed, of course) interest. They are rescued from their comfortable pigeon-hole and carefully scrutinized, and not infrequently produce a series of shocks when the insured finds out that the nature or cause of his loss is not covered, that the gross amount of the insurance carried is insufficient, that the insurance is not distributed in accordance with the relative liability to fire damage of the classes of property insured, or that there is a co-insurance clause whereby the insured shares the risk with the company.

The cardinal point that everyone should realize and then take to heart is this: that after a fire the burden of proof rests upon the insured. The insurance companies are all, *ex-officio*, Missourians; they require to be shown, and the law sustains them in this position. Every claim as to what was destroyed and what it was worth at the time of the fire must be set forth in detail and substantiated in a manner satisfactory to the insurance company. The time to prepare for realizing upon a fire-loss is before the fire, not afterward, so a few business-like expedients in the interest of preparedness may save thousands of dollars.

INVENTORY. Everybody, individually or collectively, should take a physical inventory once a year of the property insured. This inventory should be prepared in detail, setting forth every item, its value and location in the building where it is stored or erected. The building itself should be inventoried in sufficient detail as to type of construction, quantity and cost of material used, labor-cost for erection, in detail, if possible, as to sub-contracts let for such items as foundations, plastering, installation of lighting and plumbing equipment, and other items. Foundations for the building proper as well as lighting fixtures and plumbing are regarded by the insurance companies as part of the building, and therefore may not be classed as machinery or plant-

equipment. Prepare the inventory in duplicate; keep one copy within the building, if you like, but send another copy to the nearest safe-deposit vault. All office-safes and vaults are not fire-proof; many of them are far from it, as the San Francisco fire showed.

DEPRECIATION. This is an item upon which experts as well as insurance companies differ. Adjusters look askance upon a plant or factory that was shut-down at the time of a fire. So many attempts have been made to sell idle plants to insurance companies through the medium of a fire, that even the honest loss is subject to the most careful scrutiny and investigation. The rate of depreciation imposed by an insurance appraiser for an idle plant is necessarily much greater than for one that had been operating continuously; in some cases it has been placed as high as 25 to 50% per annum. Such amounts as have been written off on the inventory for depreciation should be clearly shown thereon, and all copies of inventories for previous years should be kept as a matter of record in order to show the total depreciation over the period of the plant's existence.

SALVAGE. After a fire, clear away the débris as quickly as possible, provided, of course that the plant is to be re-built. Do not destroy the remains of any piece of machinery until the loss has been adjusted. If a man may be identified by his thumb-prints, so in turn may the presence of a crusher be proved by a warped and twisted shaft, although the rest of it may be unrecognizable. The insurance adjuster or appraiser is expected to check the inventory as best he can by inspecting the débris, so anything that the insured can do to facilitate the work is not only appreciated by the company but hastens a settlement. Keep track of your labor-cost for salving wreckage, as allowance will be made by the company for this item, although, of course, the total award cannot exceed the amount of insurance carried. Total losses are the exception, however, especially where machinery or any kind of plant or factory-equipment is involved.

ADJUSTMENT. After the fire, notify the insurance company—the sooner the better. The adjuster will soon put in an appearance, make an inquiry to determine the cause of the fire, and size up the situation generally. If the loss involves the destruction of property of a technical nature, he will call for an appraisal. Two appraisers will then be appointed, one to represent the insurance company, and one the insured. These two, in turn, will agree upon an umpire to settle any points upon which they cannot agree. This done, the appraisers will at once call upon the insured for a copy of their inventory, which, alas, in most cases, does not exist. In the absence of an inventory, the appraisers,

working together, must do the best they can, by examining such records, invoice files or other office data as may not have been destroyed by the fire, to prepare some kind of a list as a basis to making the appraisal and then a proof of loss. In case all records have been destroyed in the fire, verbal testimony from employees is taken from which a rough inventory is prepared. All of these expedients involve much time, expense, and labor, adding enormously to the difficulty of realizing upon the actual loss sustained. The burden of proof rests with the insured. The insurance company must be shown.

APPRAISAL. The general form upon which an appraiser's report is made is as follows:

| Item | Description | Installed Cost | Sound-Value | Loss |
|------|--------------|----------------|-------------|-------|
| 1 | Concentrator | \$575 | \$500 | \$125 |

In explanation, the installed cost includes:

- Factory cost of the concentrator.
- Transportation from factory to plant-site.
- Cost of erection.
- Cost of foundations.

The sound-value is the same as the installed-cost, less whatever allowance is made for depreciation, in other words, the value just before the fire. The loss-item is self-explanatory. The above example indicates that the concentrator was not a total loss, and salvage appraised at \$75 was recovered. The starting point in any appraisal is the installed-cost, which emphasizes the necessity for a complete inventory as a means whereby the sound-value may be established and the insurance recovered.

CO-INSURANCE. Many people who take out insurance are attracted by the lower rates made for policies having a co-insurance clause, and authorize its insertion without understanding fully what it really means. In general terms, co-insurance signifies that the insured shares the risk with the insurance company. The property is assumed to be insured for its full sound-value; the difference between the full value and the amount of insurance placed with the company is the part of the risk assumed by the insured. Here is the way this actually works out: If property is insured for \$20,000 and is determined to have been worth \$60,000 at the time of the fire, and if there has been a 33% loss, the insured gleefully expects to recover from the insurance company one-third of \$60,000, or \$20,000, the total face-amount of his policies. Not so, however. All he can recover is one-third of \$20,000, which is a very different story. By reason of the co-insurance clause, the insured assumes the risk for whatever difference there may be between the insurance placed with the company and the actual value of the property insured, in this case \$60,000 less \$20,000, or \$40,000, in other words, the insured has assumed two-thirds of the risk and the company one-third, and whatever loss may occur is settled in this proportion.

Salesmen of all kinds understand the psychology of the printed word. The average man, when offered for his consideration a printed document of any kind,

whether it be a lease, contract, insurance policy, or what not, will glance over it hastily, and if the price is right, sign it. If on the other hand, there are any riders attached, either type-written or otherwise, they will receive his careful scrutiny, while the printed portion will escape his notice. There is an air of finality about print, somehow, that, in itself conveys the impression that it cannot be changed. It suggests the idea of an ultimatum — the last word. That is why few men read their policies carefully, until after a fire; therefore read your policies, study them, and know where you stand beforehand, rather than afterward.

Selecting an insurance broker to handle such matters is or rather ought to be done on the same basis as any other kind of business. The broker is an advocate for the insured, and stands between him and the insurance company. If the broker knows his business, he can save money, and infinite trouble in case of a loss, as well as see that the policies adequately protect the interests of the insured. The careless haphazard way in which most men dispose of their insurance business, as they would a donation to the old ladies' home, is anything but intelligent. Relatives or friends of managers, directors, or others in authority may be and often are excellent fellows, but, this fact, as such, is hardly sufficient reason for their being entrusted with so important a business matter. Select your insurance broker as you would your doctor, lawyer, or engineer, and it will pay you well; and in the meantime remember that preparedness may be applied in many senses other than military. In other words, don't forget the inventory.

DOMESTIC FLUORSPAR mined and marketed in the United States in 1915 amounted to 136,941 short tons, valued at \$764,475, compared with 95,116 tons, and \$570,041 in 1914. Compared with the next highest year, 1912, the output last year represents an increase, according to the U. S. Geological Survey, of more than 20,000 tons, or nearly 18%. As usual, the bulk of the fluorspar produced was sold as gravel-spar, the quantity in 1915 amounting to 114,151 short tons, or 83% of the total. Sales of fluorspar in 1915 were reported from five states — Illinois, Kentucky, New Hampshire, New Mexico, and Colorado. All showed increases over 1914 except Colorado, where there was a large proportional decrease. The large amount of fluorspar sold in 1915 may be accounted for principally because of the great demand for steel. It is estimated that about 80% of the American fluorspar output, mainly in the form of gravel-spar, is consumed in the manufacture of basic open-hearth steel.

ZINC ORES are being imported into the United States from Sardinia, Spain, Australia, and Africa. This is a direct result of the War and the consequent demoralization of the zinc-smelting industry in Belgium and Germany. While the import of zinc ore from most of these countries will likely cease when the War is over, some of the new relations may be continued. Similar departures will probably be effected in other industries, the initiative having been supplied by the War.



HAYWARD'S COTTAGE.

THE TOWN OF SUTTER CREEK.

The Re-Opening of Old Mines Along the Mother Lode, California

By T. A. Rickard

A few days ago¹ I stood with Mr. T. Walter Beam on the hillside above the little settlement of Sutter Creek, in Amador county, California, and saw the first steps taken toward the re-opening of an old and famous mine, variously known as the Eureka, the Amador, Hayward's, and the Hetty Green mine. It was a fascinating quest on which Mr. Beam had started and the heavens seemed to smile on his endeavors. At this time of the year the foothills are carpeted green and the oaken glades give the landscape a park-like beauty suggesting human design. The hillside on which we stood, torn long ago by mining operations and seared formerly with roads, was now a verdant slope, showing one white outcrop of quartz amid several clumps of trees growing out of the open-cuts made by an earlier generation of miners. Two or three black dumps, partly overgrown with grass, looked like culm heaps, for the black slate characteristic of the Mother Lode at a distance resembles the carbonaceous shale accompanying coal. The line of the lode could be traced northward by these dumps; among the houses of Sutter Creek it was easy to pick out the Wildman mill and shaft-house; beyond it were the Mahoney mine-buildings, and near the top of the ridge on the farther side of the village were the Lincoln shaft-house and a big red open-cut that cleft the ridge right to the sky-line. These three mines are now idle, but from behind us, southward, came the muffled roar of the Central Eureka mill and over the ridges both north and south there was, we knew, a succession of busily productive mines and

mills. The village itself, nestling among the gentle hillsides, looked idyllic, the tall poplars giving the little houses a quaint dignity, which the warm sunshine mellowed into quiet beauty. Sutter Creek is too much of a mining settlement to be altogether admirable on near acquaintance, but viewed from a distance it vibrates with the afterglow of that romance which Bret Harte has crystallized for us in imperishable writing.

The Eureka mine has been closed-down since 1886—just 30 years ago. It was located in 1852, which is also the year in which the first lode-claim was staked in Amador county. A 10-stamp mill was built on the Eureka in 1852, and a new mill of 20 stamps was erected in 1856, with 20 more in 1857. The next claim southward, the Badger, was located at the same time and a 10-stamp mill was built upon it in 1854, with 6 more stamps in 1857. Alvinza Hayward, the hero of the story, acquired a controlling interest in the Badger claim in 1854; he purchased the Eureka in 1858, and became sole owner of the Badger in 1859.

Writing in 1868, J. Ross Browne² gives the length of the two consolidated claims as 1800 ft.; he states that the average width of the vein is 12 ft. and the dip 75° east. The hanging is stated to be "hard serpentine," while "the foot is slate, polished and smooth." We must not smile at the petrography of these early writers, who had no microscopes, but most of us know now that the hanging of the Eureka vein is diabase and the foot-wall schist. According to the same chronicler, the mine then exposed only one ore-shoot, which was 500 ft. long at the surface and 600 ft. long on the 1200-ft. level.

¹This was written at the end of March. Difficulty in obtaining accurate information concerning the events of 40 years ago explains the delay in publication.

²Resources of the Pacific Slope. J. Ross Browne, 1869.

"The walls come together," he says, "at the ends of the pay chimney, which dips to the north at an angle of about 80°." Thus the orebody pitched northward at nearly the same angle as the vein dipped eastward. In an earlier report, made in 1867, Ross Browne says: "The quartz vein is in places almost a powder and is mixed with slate and clay. The length of the ground worked is about 160 yards, and both north and south the vein seems almost to disappear." Such sugary or crushed quartz is not uncommon on the Mother Lode; the pinching at the end of short ore shoots gives them a lenticular shape in horizontal section. At an earlier date J. D. Whitney said: "The vein is enclosed in a dark-colored, rather soft, argillaceous slate. In the Eureka the mass of veinstone is from 8 to 20 ft. wide, but in the Badger it widens out suddenly to 40 ft. The length of ground worked out in both mines is about 170 ft.; so that the body of quartz is very short in proportion to its great width, being almost a column, or chimney, rather than a vein." The deepest incline—for the shaft was sunk on the vein—was 1230 ft., of which it is recorded that it was then "the greatest depth reached in the mines of California." At that time the two mills, aggregating 66 stamps, were kept busily employed, for the supply of ore was so plentiful that some of it had to be sent to custom-mills in the valley below. Thus, the Eureka must have been highly prosperous at the period of this report by J. Ross Browne, the distinguished father of a distinguished son, Ross E. Browne, as well known in South Africa as in California. The elder authority states that "within 500 ft. of the surface the average yield did not exceed \$10 or \$11 per ton, and now it is, according to report, \$27, with a wide vein and 125,000 tons of ore in sight—enough to keep the two mills going for five years." The total yield up to that date—1867—was said to have been \$6,000,000. Like many old and abandoned mines, the Eureka has been credited with a fabulous production. Writing in 1869, Dr. Raymond said that popular rumor concerning a profit of \$50,000 monthly was possibly true at one time. The total yield up to 1866 was estimated by Ross E. Browne at \$3,000,000. Allowing \$1,500,000 for 1866, 1867, and 1868, and taking the figures given elsewhere in this article for the subsequent years until 1875, with a guess at the yield up to 1879, I estimate the total production at about \$12,000,000.

In 1868 Rossiter W. Raymond succeeded J. Ross Browne as Commissioner of Mining Statistics and in his annual reports from 1869 to 1875 I have found a number of references to the Amador mine, as it was called then. In the first report the depth of the shaft is given as 1054 ft. vertically and 1109 on the incline, according to a new survey. Water was hoisted in buckets, the method known as 'bailing.' "This plan" says Dr. Raymond "was adopted and obstinately adhered to by Mr. Hayward, as long as he owned and managed the Eureka."

Between 1868 and 1872 the mine had its ups and downs. At the end of 1868 rich ore was struck and large reserves developed. The depth of the Eureka shaft

was deepened to 1350 ft. The Badger shaft also passed through rich ore. In 1869 the mine produced \$656,326 in gold and paid \$384,800 in dividends, from 32,510 tons that yielded \$20.19 per ton. The cost of mining is given as \$1.68 and of milling \$1.97, making a total of \$6.65. On April 15, 1870, a fire caused a suspension of work for four months. During that year the yield was \$301,533 and dividends \$111,000. In the report for 1871 it is stated that the dividends were only \$24,000, as against \$155,400 in 1870, indicating that \$11,500 must have been distributed after the report for 1870 was closed. The repairs and erection of a new hoist after the fire appear to have taken nearly twelve months, the delay being due partly to a virulent miners' strike during the summer of 1870. In the new equipment, the old bucket was replaced by a cage holding a car of 1800 lb. capacity. Drainage was effected by iron tanks, one of which is to be seen on the hillside today, somewhat battered by the exploding of dynamite by boys on the occasion of the recent celebration of the re-opening of the old mine. In 1871 only 17,790 tons was hoisted and 16,490 tons milled for a yield of \$201,357, equal to \$12.21 per ton. Colonel John D. Fry was president; he was one of the founders of the California Safe Deposit & Trust Co., he operated mines at Grass Valley, and in 1881 it was he who sent John Treadwell to Juneau and thus became one of the first owners of the Alaska Treadwell. David D. Colton was treasurer of the Central Pacific Railway, and it was through his influence probably that the branch line from Sacramento to Latrobe was built in 1869. Latrobe is 18 miles from Sutter Creek; the freight by wagon was \$12 per ton at that time, and the freight from San Francisco to Sacramento was \$5.50 per ton.

Alvinza Hayward owned the mine for about 11 years, from 1854 to 1868. Raymond's reference to Hayward's obstinacy in regard to the use of buckets for draining the mine, "as long as he [Hayward] owned and managed the Eureka" suggests that he did *not* own it at the time, late in 1868, when Raymond wrote this. Up to 1865 he had a partner named Oscar L. Chamberlain. On March 1, 1868, Hayward & Co. sold out to the Amador Company for \$750,000. Concerning the sale of the mine in 1868, Raymond said in 1869: "The dividends were \$6 per share monthly, or 18% annually on the capital stock, yet the mine was sold at \$200 per share. This is a fact which Eastern capitalists would do well to ponder. In the San Francisco market, where the value of mines is best understood, the stock of an active successful mine is not intrinsically worth par unless it is paying 30 to 40% annually." The property, which included the Eureka and Badger claims, with the mills, was examined for the purchasers by William Ashburner and Henry Janin, who computed the total reserves at 108,027 tons, having a gross value of \$1,778,336. "The cost of mining and milling," says Raymond,³ "does not exceed \$6, leaving an apparent profit of \$1,130,204." But a deduction of 25% was made for contingencies, over-estimate, etc., so

³"Mineral Resources West of the Rocky Mountains." Rossiter W. Raymond, 1869.



ONE OF THE EUREKA DUMPS.

A REMNANT OF AN OLD HOIST.

that the net value was reduced to \$847,653. The average yield in 1868 is given as \$21.77, the dividends being \$7 per share monthly on 37,000 shares. The output was 1800 to 2200 tons per month. A longitudinal section of the mine by Augustus J. Bowie, later famous as the authority on hydraulic mining, is given in the report of 1869. It shows the property covering 1850 ft. on the vein, which is given a dip of 71°, the width of quartz ranging from 3 to 20 ft. At that time it was 15 ft. wide in the lower stopes.

Hayward sold out to a group of whom Michael Reese was the principal operator. Others were Milton S. Latham, David D. Colton, and John D. Fry. Hayward was a friend of some of these men and he came to Sutter Creek occasionally, for he had other mining property in the county—at Plymouth, for example—but I believe that he did not control the Eureka after 1868. In Raymond's report for 1872, it is stated that the Amador, better known as the Hayward mine, "has been disincorporated preparatory to its transfer to English purchasers." Transfer from the Amador to the Consolidated Amador Company was completed in November 1872. The new consolidation included the Wolverine (or Maxwell) and Railroad properties, both previously owned by incorporated companies. The 'Wolverine,' had been bought by John W. C. Maxwell in 1867, as he himself has informed me. Previously Hayward had done some work, attracted by the prominent outcrop on this claim, but he abandoned it; later D. O. Mills and his brother Edgar took an option on it for two years but did no work. At the expiration of that option Mr. Maxwell bought it, for \$5000 in cash, in 1867, as already stated. Shortly afterward Milton S. Latham, D. D. Colton, and General E. D. Keyes⁴ acquired interests with Mr. Maxwell and, at their request, he organized the Maxwell Mining Co. At that time also John A. Steinberger, who became the superintendent, was given a 1/20 interest by Mr. Maxwell. He sank the shaft and opened up the vein in depth, down to 125 ft. In 1870 Mr. Maxwell sold his

remaining interest to the group that had purchased the Hayward property, namely, Latham, Colton, and Green. Latham was managing-director and Green a director of the London & San Francisco Bank. It was understood that Green would consolidate the adjacent properties with a view to placing them on the London market.⁵ Thus Green comes into the story. Edward H. Green hailed from New Bedford (Massachusetts), where also he married Hetty Robinson, who inherited wealth from her father, a local merchant. He had made money in the whaling business and in Manila hemp; he was in the shipping trade in a large way and made frequent journeys to London and the Orient. On one of these journeys he met Hayward and Colton at San Francisco. Hearing them talk about gold mining, he came up with them to Sutter Creek to see the Eureka. He became keenly interested and on his next visit to London he got several of his English friends to join him in buying the property. In this deal Hayward acted merely as introducer and promoter, he had been out of the mine for four years. Leland Stanford was in the deal with Green and became a director in Green's company, the Amador Consolidated.

The levels in the mine were named after the various stations on the way to New York. Thus the 700-ft. level was the Latrobe; the 800 was called the Folsom; then followed the Sacramento, San Francisco, Panama, and New York levels. After 1872 the lower levels were named after the directors: Green, Latham, De Laski, and Colton. Later the geographical nomenclature was resumed, and the levels become successively the London, China, and Paris.

In January 1872 Steinberger, the superintendent, reported that the vein was looking most promising in the lower workings, on the Green and New York levels. In the report for 1873 the output from December 1, 1872, to January 31, 1874, (14 months) is given,⁶ showing

⁵For these notes I am indebted to Mr. Maxwell.

⁶The Amador Consolidated company operated the mine as from December 1, 1872, hence the irregular period.

⁴The father of the late W. S. Keyes.

22,460 tons crushed, yielding \$402,294, or \$17.91 per ton. In addition, \$1953 was received on bullion produced; this may have been the yield from specimen ore. Dividends for the period were \$180,000. The North shaft had been deepened to 1873 ft. The vein had narrowed from 25 ft. on the Colton level (1425 ft. vertical) to 4 ft. at the bottom of the shaft (90 ft. deeper), but the ore was richer. "From the Colton level the vein shows much confusion," says Superintendent Steinberger. Sudden pinchings and widenings had bothered him. In 1875 the same superintendent reports for the 14 months ending on April 1, 1875, namely, from February 1, 1874, so that this connects with the previous accounting. A new level below the Colton shows a decided improvement. The North shaft has been sunk 220 ft., but there is still "much confusion" in the vein; the hanging wall is broken, the quartz is small and "much mixed with slate and granite" (meaning diabase). During this period 22,098 tons had been milled for a yield of \$239,717, or \$10.84 per ton. The 'sulphuret' account showed \$20,254 from 219 tons, or \$92.27 per ton of concentrate. The total receipts were \$270,014. Dividends \$30,000. On December 20, 1875, a fire, supposed to be of incendiary origin, started in the middle shaft. On November 24 of that year the secretary reported "two feet of good rock" in the bottom of the main shaft, which was then 2063 ft. on the incline or 300 ft. deeper than the Paris level. These lower workings have never been seen since then, for nobody penetrated below the 800-ft. level after the fire of 1875. The workings were drowned and the mine was re-opened subsequently down to the 800; desultory work continued and stopped finally in 1878. This refers to the Eureka mine. All other operations also ceased for a year or so; then some work was done at the north end in the Wolverine ground, the shaft being sunk from 600 to 1500 ft. in 1879. From the bottom a drift was started southward to tap the old mine, but there was much trouble with water, and there were other difficulties. Several years were spent in unproductive operations. In 1886 Green came to Sutter Creek, and with him Hayward; the two of them had a carousal, followed next day by a consultation at the mine. It was then decided to close-down, with the intention, at some future date, to re-open and re-equip the old Eureka workings. Assessments had been levied from 1881 to 1885, with the result that 12,000 shares were forfeited, leaving the remaining 18,000 shares in the hands of Green. All the records of the company, save a few letter-books at Sutter Creek, were destroyed in the San Francisco fire.

From Green the property passed to his widow, Mrs. Hetty Robinson Green, who refused either to operate the mine or to sell it until late last year, when, on the initiative of Mr. Beam, a syndicate was formed to acquire the property at a price a little over \$500,000 in cash. In 1894, while examining a mine in the adjacent district of Volcano, Mr. Beam's attention was attracted to the Eureka mine by the local talk concerning it. He was informed that all efforts to get a bond on it had been 'turned down' by Mrs. Green. In 1912, while on a

second visit to Sutter Creek, he collected what information was available and decided to recommend his friends to approach the old lady at New York. But she proved refractory, declining to talk business. Six months later while Mr. Beam was in New York, he managed finally to get an appointment with her son, Colonel Green (he had been on the staff of a State Governor), and on that occasion he learned that Mrs. Green had kept the property in case her son should care, at any time, to re-open it on his own account. Three years elapsed—bringing the date to 1915—before the negotiations were concluded, Mrs. Green finally consenting to take payment in spot cash when the Colonel had indicated clearly that he had no desire to go into mining. However, she insisted on a laborious inquiry being made to ascertain if any of the heirs of the friends of her deceased husband had any claims on the property, that is, those whose stock had been forfeited for non-payment of assessments during the long interval since work had ceased at the mine. The story is interesting as illustrating Mr. Beam's persistence in his purpose, which he is now in a position to fulfil. On January 10, 1916, the transfer was finally executed in San Francisco and on February 24 the event was celebrated by the people of Sutter Creek in appropriate fashion. The inscription "So long Hetty" on one of the banners, paraphrasing a vaudeville song, served to express the gratification of the local people in seeing an absentee owner transfer an idle property to men able and willing to exploit it once more. The new operators include a group of men notable in mining. The president of the resuscitated Consolidated Amador Mining Company is William D. Thornton; John B. Parish is a director; among the principal shareholders are Thomas F. Cole, John D. Ryan, Chester A. Congdon, William E. Corey, James Hoatson, Ambrose Monell, William W. Mein, and Philip L. Foster. None of these need any introduction. They are experienced men, well aware of the risk incurred in paying a large sum of money for a mine full of water, but they have justifiable confidence in the prospect of more than recouping themselves.

Alvinza Hayward has passed into local history as a courageous prospector who stuck to an unproductive claim until it developed into a rich mine. In Amador county you hear of the storekeeper who refused him a sack of flour and of another who helped him and was pensioned when Hayward became a millionaire. It is a fact that he sank the Badger shaft to 700 ft. before he struck rich ore, persisting with a miner-like tenacity of purpose until his cash and credit alike were gone. Some of his men stuck to him so that he succeeded at last in getting to the ore, which, without scientific evidence, he confidently expected to find. At that time Chamberlain, a merchant in San Francisco, gave him credit and that is how the latter became a part owner, a partner, and subsequently rich, when the mine developed into a bonanza. Hayward is also credited with great knowledge of mining and unusual sagacity in the development of mines. Much of this is untrue. Alvinza Hayward came from the northern part of New York state; he was trained in

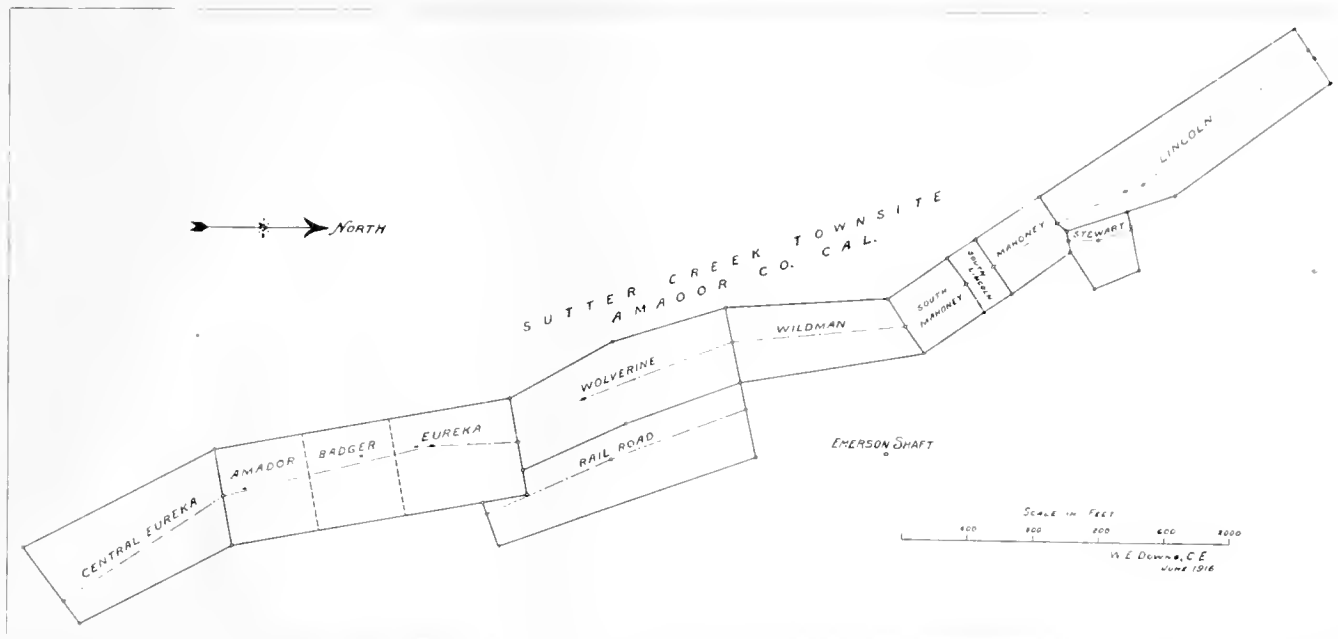

THE CLAIMS SOUTH OF THE WILDMAN UP TO THE CENTRAL EUREKA BELONG TO THE AMADOR CONSOLIDATED, THOSE NORTHWARD, INCLUDING THE WILDMAN, TO THE LINCOLN CONSOLIDATED COMPANY.

an Eastern law-school; he was a well educated and extraordinarily shrewd man; he made a lot of money in mining by intelligence, luck, and clever dealing. One characteristic story is that of the Empire and Pacific mines, now constituting the Plymouth Consolidated. When Hayward owned the control of the Empire he followed the ore-shoot where it pitched into the Pacific ground and extracted ore to which he had no right. Later, he bought the Pacific claim for himself, sold his holding in the Empire, and thereupon brought suit against the latter for trespass, on the basis of the ore removed by himself formerly. He obtained judgment, and the Empire company being then impoverished, he got that claim by default. He was a speculator and promoter, not a mining engineer. Although shrewd, he was a victim to occultism, and used to take the advice of spiritualists. For instance, it is a fact that he spent \$70,000 in erecting a furnace and otherwise equipping a quicksilver mine, near Livermore, that never yielded a

single flask of quicksilver, although, guided by the 'spirits' he bought 2000 flasks so as to be prepared for a large production.

Hayward is credited popularly with having made \$5,000,000 out of the Eureka; it is more likely that this amount represents the gross yield during the time he operated the mine and that his profit was about \$2,000,000. His fortune was increased by operations on the Comstock, the Utica mine at Angels, and by other ventures. He died in San Francisco on February 14, 1904, being then 82 years of age. He is still remembered gratefully by many old people at Sutter Creek for the personal kindness and financial help that he gave them when they were 'hard up.' Let that be his epitaph.

A SHAFT-SINKING record has been established at a mine on the Gogebic range in Michigan. The remarkable distance of 190 ft. was sunk in one month. This includes lining of the shaft with steel.

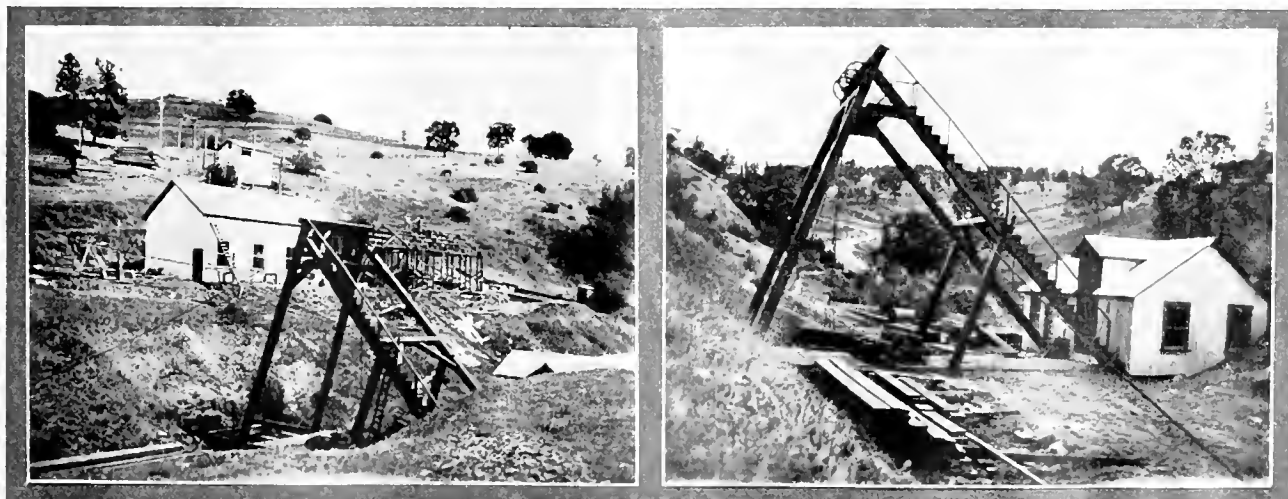

RE-OPENING OF THE EUREKA MAIN SHAFT, SHOWING TEMPORARY HEAD-FRAME.

Cobalt: Its Possible Uses

By F. H. Mason

THE average man is apt to associate cobalt with only a series of beautiful blue pigments. Of course, everyone knows that cobalt is a metal, in the same way that one knows that lithium, strontium, calcium, and many other elements rarely seen in the metallic state, are metals, but that it can serve any useful purpose other than in the manufacture of 'smalt' does not, as a rule, enter one's head. Not only does the supply of cobalt oxide produced in Canada each year greatly exceed the demand, but a large quantity of perfectly good cobalt ore goes to waste, after the silver content has been removed. Therefore the Mines Branch of the Canadian Department of Mines determined to demonstrate its own usefulness by finding a use for this surplus supply.

Both chemically and physically cobalt is closely allied to nickel. It has the same atomic weight, forms a similar series of salts, is dissolved and in many cases precipitated by the same reagents, and, like nickel, is not easily corroded; both metals have about the same specific gravity, nearly the same high melting-point, are white, and hard and capable of taking an extremely high polish that is not readily scratched. Naturally, then, the research of the Mines Branch fell into the line of investigating whether cobalt could not be substituted for nickel in some branch of industry in which the latter metal is employed. To tell how well it has succeeded up to date

(the research is still being presented) is the object of this article.

The principal use for nickel in the arts is to give a protective coating, electrically deposited, that not only greatly retards corrosion but also, in many instances, gives an infinitely better appearance to the article so treated. As long ago as 1878 A. Gaiffie* stated that cobalt could be deposited electrolytically from solutions of its double sulphate with ammonium, that the deposit was harder, more beautiful, and adhered more tenaciously to the article plated than deposits from the corresponding nickel salt; but, to get these results it was necessary to use a weak current. In those days cobalt was a rarity, and the matter appears to have escaped serious attention until the Mines Branch took it up again, with the object already stated. The investigation into the possibilities of using cobalt instead of nickel for protective plating, which forms only a part of the research, has been thorough, and the results have been published in a pamphlet entitled 'Electro-Plating with Cobalt,' which can be obtained from the Mines Branch of the Department of Mines, at Ottawa, and to which those interested in the subject are referred for more

minute detail. A considerable number of electrolytes have been tried, and great care has been exercised not only in the final result obtained but also in careful measurements of the electrical resistance and the general behavior of the various solutions. To follow the investigators through this research would be outside the precincts of this article; it will be enough to give an account of the laboratory and commercial tests of the two most successful solutions, which, incidentally, threaten to revolutionize protective electro-plating.

The two recommended electrolytes are made as follows:

I B (SERIAL NUMBER).

| | |
|---|-----------|
| CoSO ₄ (NH ₄) ₂ SO ₄ | 200 grams |
| Water | 1000 " |

This solution is nearly saturated in cobalt-ammonium sulphate.

XIII B (SERIAL NUMBER).

| | |
|--|-------------|
| CoSO ₄ | 312.5 grams |
| NaCl | 19.0 " |
| Nearly saturated solution of boric acid..... | 1000 cc. |

This solution is nearly saturated with cobalt sulphate in the presence of the other components.

In future the solutions will be mentioned by their serial numbers. The laboratory experiments with I B solution showed that cobalt could be deposited from this electrolyte on brass or iron; that the deposits are firm, adherent, hard and uniform, and can readily be buffed to a finely finished surface; that the specific electric conductivity of the solution is much higher than that of corresponding nickel solutions, or, for that matter, of any nickel solution, and consequently will plate far more rapidly than any nickel solution; that no preliminary copper coating is necessary when plating on iron or steel; that the solution does not change appreciably in cobalt content—when a cobalt anode is used, of course—or become either acid or alkaline when used over long periods of time at the recommended current densities; up to 4 amperes per square decimetre, which is equivalent to 37.2 amperes per square foot; that the solution requires little, if any, ageing to put it in condition, but gives satisfactory deposits from almost the start; that the throwing power—that is, power of reaching into indentations in the cathode—is satisfactory; and that the anodes are free from the coatings that are characteristic of nickel anodes. The laboratory experiments with XIII B were even more satisfactory, for, besides possessing all the good qualities of the other, it was found possible to use a current density of from 3.5 to 17.5 amperes per square decimetre; consequently it plates with extraordinary rapidity, and a deposit can be

*Comptes Rendus hebdomadaires des Sciences de l'Academie.

obtained in five minutes that takes an hour with the fastest known nickel bath.

The laboratory results obtained from these two solutions having proved so satisfactory, their formula and the necessary reagents and cobalt anodes were given to the Russel Motor Car Co., of Toronto, with the request that the solutions be given a thorough commercial trial. The company's foreman electro-plater, Walter S. Barrows, after eight weeks' trial during which articles of copper, brass, iron, steel, tin, German silver, lead, and Britannia metal were plated under the same conditions as are met with in nickel-plating practice, found that the practical tests more than bore out the laboratory experiments. Particularly was this the case in regard to speed in plating, for, while in the laboratory the greatest current density successfully employed was 17.5 amperes per square decimetre, equivalent to 160 amperes per square foot, excellent deposits were obtained with 244 amperes per square foot in the practical trials. Articles which usually were given a one hour nickel bath were plated in three minutes in solution XIII B so effectively that the buffer, who did not know of the existence of the cobalt bath, was unable to detect any difference in the finished article. The cobalt deposits not only withstood all the bending, hammering, and burnishing tests usually applied to nickel deposits, but were found to be harder and more ductile than the latter. In fact, so ductile is the cobalt deposit that a 1-inch tube, that had been plated for two hours in the cobalt bath, was drawn down to $\frac{5}{8}$ inch without injuring the deposit. Though cobalt is considerably more expensive than nickel, the increased cost is more than compensated for, when using it for protective plating, by the reduction in cost of labor and decreased vatage capacity necessary for a given amount of work, owing to the greater speed at which cobalt can be deposited from its solutions.

Two other pamphlets published by the Canadian Department of Mines on this subject, are 'Preparation of Metallic Cobalt by Reduction of the Oxide' and 'The Physical Properties of the Metal Cobalt.' In the former, results of experiments are given and advantages discussed of the reduction of cobalt oxide by carbon, carbon mon-oxide, aluminum, and hydrogen. Aluminum is prohibitive, except for laboratory work, on account of cost; hydrogen is to be recommended only when a pure, carbon-free metal is required; carbon and carbon mon-oxide both reduce the oxide effectively. In the second pamphlet, accounts of experiments of the determination of the density, hardness, melting-point, tensile breaking strength, tensile yielding-point, compressive breaking strength, compressive yielding-point, electrical resistance, magnetic permeability and specific heat of cobalt are given and discussed. Detailed work of previous experimenters also is to be found in this pamphlet. The effect of traces of carbon on masses of cobalt is similar to traces of that element on masses of iron: thus, it was found that while the tensile strength of pure cobalt is about 34,400 lb. per square inch, the addition of 0.06 to 0.3% of carbon nearly doubled it.

The Qualitative Test for Tungsten

By M. L. Hartmann

*The recent activity and interest in tungsten has necessitated research into the methods for detecting this element. It is frequently said that the qualitative tests are uncertain, and it was due to such a remark that this investigation of the sensitiveness of the reduction test for tungsten was begun.

Tungsten minerals, when fused with an excess of sodium carbonate, give soluble sodium tungstate (Na_2WO_4). When solutions of sodium tungstate are made acid with hydrochloric or sulphuric acids, in the cold, a white flocculent precipitate is formed (composition varies from $\text{WO}(\text{OH})_4$ to $\text{WO}_2(\text{OH})_2$, which on heating becomes yellow tungstic acid or oxide (WO_3 or H_2WO_4). If a strong reducing agent is added, the solution is changed to a bright blue color, due to a suspension of a finely divided, flocculent precipitate, consisting of oxides of composition between WO_3 and WO_2 (sometimes given as W_2O_5 , W_3O_8 , W_4O_{11}). If the reduction is carried still further, the brown tungsten dioxide (WO_2) is formed. This change was very slow at room temperatures, the blue precipitate having been kept for two days.

A rather extended investigation was made of the best method for making this qualitative test. For studying the reactions involved, a dilute standard solution of sodium tungstate was prepared. In brief, the following results were obtained:

The reducing agents usually recommended for this test are zinc and hydrochloric acid, tin and hydrochloric acid, and stannous chloride and hydrochloric acid. It was found that the use of tin and hydrochloric acid was the most satisfactory, as the evolution of hydrogen gas was not too violent, and the reduction was very rapid, due to the quadrivalence of tin. The use of zinc and hydrochloric acid was fairly satisfactory, but not as desirable as tin. The evolution of hydrogen was frequently so violent (in the concentrated acid solution required for the best results) that the blue color could not be detected in the solution. Furthermore, with very small quantities of tungsten the reduction was carried to the brown color so rapidly that the blue color escaped notice.

The use of stannous chloride in hydrochloric acid solution is not to be recommended for this test. The blue color was sometimes obtained when the concentration of the tungsten was high, when the amount of stannous chloride was large, and when the solution was heated for some time. Small quantities of tungsten could not be detected, using this reducing agent.

Hydrogen peroxide is sometimes used as a reducing agent in similar reactions. It was found that it did not reduce tungstic oxide either in the cold or when heated.

Oxalic acid is also used occasionally. This reducing agent was without effect on tungstic oxide.

*Abstract from *The Pahasapa Quarterly*, South Dakota School of Mines, Rapid City.

Using zinc as the reducing agent, and hydrochloric acid at room temperature, and sodium tungstate solution equivalent to 0.01 gm. of WO_3 , in a total volume of 10 c.c., the blue color became distinct with 0.25 c.c. concentrated hydrochloric acid in one hour; with 0.50 c.c. in two minutes, and with 1.00 c.c., practically instantaneously.

In a total volume of 2 c.c., with 0.5 c.c. of concentrated hydrochloric acid, and with tin or zinc as the reducing agent, 0.0005 gm. of WO_3 could easily be detected by the blue color. Using tin, the color was produced in the cold, while with zinc it was necessary to heat the solution to get an immediate color. If allowed to stand at room temperature, the blue color could be detected in half an hour.

Thus in solutions containing only tungsten salts the test is very sensitive. As small an amount as 1 mg. of WO_3 may easily be detected.

The above experiments were made upon pure sodium tungstate. In order to study the reduction test under actual conditions, ores of known tungstic oxide content were examined. Here, before the reduction test can be applied, the material must be brought into solution as a tungstate or in the form of tungstic oxide in finely divided or colloidal particles. There are two methods which can be used; fusion with sodium carbonate and subsequent solution, or solution of the ore in hydrochloric acid.

The following ores were tested by both methods and the tabulated results obtained:

| Material. | WO % | Reduction with tin after | |
|---------------------------------------|------|---------------------------------------|--|
| | | Solution in HCl | Fusion, solution in HCl |
| Wolframite sand, | 3 | No color | Strong blue color |
| Wolframite ore, | 16 | Strong blue color | Residue blue, but not solution |
| Wolframite concen- trate | 32 | Strong blue color | Distinct blue color |
| Scheelite ore, | 38 | Strong blue color | No color |
| Wolframite concen- trate | 68 | Blue residue, and faint blue solution | Strong blue color |
| Scheelite, | 75 | Strong blue color | Distinct blue solution, and blue residue |

From the tests made on these tungsten materials it was found not safe to depend upon a single method for all cases. Most of the ores dissolve sufficiently in boiling hydrochloric acid to give the blue color on reduction. The low-grade ore did not respond to this treatment. In the method of fusion with sodium carbonate, it was found essential to have a large excess of sodium carbonate. This is to insure the complete transformation to soluble sodium tungstate. It was further found, that for the most accurate tests, the fused mass should be first dissolved in water and then made acid with hydrochloric acid. The reason for this procedure is to insure a colloidal precipitate of the tungstic oxide, which on reduction gives the blue solution, rather than the blue residue

which forms when the fusion is dissolved in hydrochloric acid.

In conclusion, the following general directions can be recommended for testing for tungstic oxide in ores. Boil at least 0.2 gm. of finely divided material in a small test-tube with concentrated hydrochloric acid until about half of the acid is evaporated. Dilute with an equal volume of water, add a piece of metallic tin (mossy) and heat if necessary. A fine blue color indicates the presence of tungsten. If this test gives negative results, about 0.5 gm. of the material should be fused in at least 4 gm. of sodium carbonate. (This may be done with an ordinary Bunsen burner in a metal crucible, or before the blast in a porcelain crucible). Dissolve the fused mass with boiling water in the crucible. Acidify the aqueous solution with an equal volume of concentrated hydrochloric acid, add a piece of metallic tin, and warm if necessary. The volume of the solution should not be more than 10-22 c.c. A fine blue color indicates the presence of tungsten. In either case, if reduction is continued long enough, a brown color is obtained.

These tests if properly used, will show the presence of tungstic oxide in materials as low as 2%, and by using special precautions, will detect tungsten in even lower-grade materials.

NOTE. The interfering colors that might be produced by other elements present, under the conditions of the test for tungsten, are being studied at the present time. Columbium (niobium) gives a blue color which is said to disappear on dilution and which does not become brown after long reduction. Vanadium also gives a blue color on reduction, but tartaric acid will cause this reduction, whereas it will not reduce tungstic oxide. Molybdenum on reduction goes through a series of color changes from violet to blue to black. Titanium gives a violet color. No other elements are likely to interfere with the test for tungsten.

THE RISE in silver has had the effect of increasing the purchasing power of the Indian and Chinese silver coins. The increase of 30% in the price of silver raised the exchange of China with Europe from 8 taels for a sovereign to less than 6 taels. That is, an Asiatic can purchase with 6 taels an amount of goods that formerly would have required 8 taels. This may have the beneficial effect, it is argued, of increasing the demand for European and American manufactured goods among 800,000,000 Asiatics.

THE PENNSYLVANIA RAILROAD, which operates fast trains between New York, Chicago, and Washington, has not had a single passenger lose his life by train accident during the past two years. In that period 362,000,000 passengers were carried on 2,400,000 trains over 26,000 miles of track, with an equal number of freight-trains running over the same lines. This is a remarkable record.

FELDSPAR production in 1915 was 113,769 tons worth \$629,356.

Stoping Hard Ore at Miami, Arizona

By David E. Scott

INTRODUCTION.* When mining was begun by the Miami Copper Co., the hard ground in the western portion of the orebody made it advisable to use a system of wide shrinkage-stopes and pillars. As finally evolved the system was applied to the mining of 2,300,000 tons of ore by the use of stopes and pillars each 50 ft. wide. In this part of the orebody, mining has been in progress since 1910, and the final stages of extraction are now reached. A complete survey of this system can therefore be made, showing the modification of method.

DEVELOPMENT. The preliminary work included the opening of a haulage-level, the construction of a draw-off level, and the driving of sub-levels for stoping. In addition, some extra driving was necessary to determine the boundaries of the orebody, the general outline having been ascertained by churn-drilling. Development was based on stopes 50 ft. wide, with 50-ft. pillars between them. The length of these pillars varied from 200 to 500 ft., at 50 ft. below the floor of the stopes, each drift being beneath the middle of the stopes and pillars. The arrangement made it possible to load along an entire stope without switching or uncoupling. The drawing-chutes were all on one side of the drift, each chute terminating in the draw-off level 25 ft. above. With ears of $3\frac{1}{2}$ tons capacity, the rate of loading was from 3 to 5 tons per minute. In timbering, 10 by 10-in. members were used, sets being spaced at 6-ft. 3-in. centres. The standard set requires a 9-ft. post and 8-ft. cap, the posts being hitched in the ground $7\frac{1}{2}$ in. below the ball of the rail. All drift-set posts are set at a batter of $1\frac{1}{2}$ in. per foot.

A distinctive feature is the draw-off level, 25 ft. above the tram-level. This is used for handling all ore from raises that perforate the stopes, delivering the ore through grizzlies to the tram-chutes. The primary draw-raises branch from each side of the drift and deliver directly into the chutes. The secondary or intermediate raises, used extensively in the pillars, were midway between these chutes, and delivered to them by inclined slides.

CHUTES AND RAISES. The chutes into which the ore was drawn from the stope-raises were all cribbed, 5 ft. square inside, a representative group of chutes showing a life of 12,430 tons each. To eliminate boulders in the tram-chutes, grizzlies were placed over the collars on the draw-level. The grizzly opening was 18 in. square. These grizzlies are several inches above the collar of the raise to permit easy working when ore becomes caught on the grizzly. From the floor of the draw-level, in-

clined raises on each side of the drift were run up to the edges of the stope, and then funnelled. Vertical raises through the roof of the drift were originally employed, but their effectiveness is doubtful, and they are awkward to use. This arrangement gave sets of two raises in one plane along every 25 ft. of stope. Funneling of these raises to a top diameter of 20 ft. gave a practically continuous perforation of the stope. The raises were 6 by 6 ft. at the bottom. The back, or hanging wall, constituting part of the roof-pillar between the draw-level and the stope-floor, had a tendency to collapse under weight, but this proved rather an advantage in providing a larger opening for the drawing of ore. Timbering inside of these draw-raises was therefore unnecessary.

Later practice provided raises in the pillars, of the same type as the stope-raises, but the planes of these raises were not in a continuous line with the stope couples, but midway between them. The earlier type of arrangement, with stope and pillar raises all in the same plane, was also tried. This scheme is not as effective in drawing the ore. Intermediate raises also were used in the drawing of 500,000 tons of pillars. These were situated $12\frac{1}{2}$ ft. from the regular raises. To provide an outlet for the ore, these were put up from 'pony-sets' in the roof of the drift, and delivered to slides that ran down into the regular 25-ft. pocket-chutes. These intermediate raises provided double the ordinary number of openings into the floor of the pillar. The requirements of the drawing-level have shown that the drifts can be supported with 10 by 10 timbers spaced at 5-ft. centres, using 8-ft. posts and 7-ft. caps. This type of timbering remains nearly intact after two years of service. On the tram-level a minimum amount of 2-in. lagging should be used, not placed closer than 2 or 3 in. apart. The distance between sub-levels was fixed at 25 ft. Along the axis of the pillars, drifts were run to the limits of the ore. Cross-cuts at 50-ft. intervals were driven each way across the pillars. Raises for handling development-ore were provided at 50-ft. intervals along the drifts. Although in an earlier stage, cross-cuts were driven across the stopes, connecting all of the pillar-lines, these stope cross-cuts came to be regarded as unnecessary. Considerable secondary cross-cutting and raising, however, was necessary during the later pillar mining.

SHRINKAGE-STOPES. The first operation was the funneling of the draw-raises. This was done at first by cutting out a chamber above the raise and drilling 8 and 10-ft. down-holes with water-Leyner machines around the raise. This proved unsatisfactory because the holes did not break well, and it was difficult to drill deep holes

*Abstract from Trans. Amer. I. M. E. Arizona meeting September 1916.

of nearly vertical pitch with this type of machine. The method preferred was to set up in the raise and drill up-holes in a ring. This funnelled the raise successfully to a diameter of 15 to 20 ft. Continuation of this funneling produced a stope floor perforated with openings, which practically touched at the rims. Setting up on the broken ore, the ground was squared along the sides of the stope, and any stubs between funnels blasted out. The floor of the stope was thus opened with a back 50 ft. wide and a length of 200 to 500 feet.

Using the entries on the first sub-level, drilling was started along each side of the stope. Steel as long as could be swung in the space was used, and holes from 10 to 15 ft. deep were drilled upward and outward toward the centre. The results were two-fold: at about half of the distance to the next sub-level, entries were broken along the wall of the stope, and a long rib was left in the centre. The principle of caving was adopted therefore in the breaking of this central rib, which was drilled in the succeeding round. After the first cut, the back was maintained on a flat incline until connection was made with the pillar cross-cuts on the level above. Originally use was made of cross-cuts across the stope on the level immediately above, in order to drill down-holes into the back and thus assist the caving of the central portion of the stope. This was not satisfactory, principally because of the difficulty in drilling deep holes, and in getting a wide enough reach across the back. The results did not justify the extra expense of driving these cross-cuts.

After each drill-shift, the excess of broken ore was drawn to allow 6 to 8 ft. of open space between the back and the broken ore. Large blocks of caved ore were bulldozed in the stope when possible, to prevent later plugging of the draw-raises. When connection was made with each successive entering cross-cut on the level above, the back and sides were squared up and the stoping continued upward. The stopes were carried to a maximum height of 125 ft., it being necessary to break to the cap. In a typical stope of hard ore, the expansion in volume due to breaking required the drawing of 39% of the ore in the stope, the latter being full at completion. Drilling was done with Leyner drills, using steel 10—16 ft. long. The maximum footage drilled per shift was 110, and the average footage varied from 60 to 80, according to the number of set-ups required.

PILLAR MINING. The process of breaking the pillars was practically the reverse of stoping. Mining was started at the edge of the ore on the top sub-level and carried downward level by level; in each case the 25-ft. roof-pillar was broken through to the broken ore above. This retreating method was desirable for two reasons: it provided a safe exit from working-places; and it insured an even settling of the cap. As soon as the process was started, even in the hardest ground, the speed of working became essential, because the pillar took weight as soon as the cap became dislodged. The mining therefore was done successively on three or four levels at a time at different points of attack, the work on each level

being 100 ft. nearer completion than the work on the level below.

Preliminary cross cutting half-way between the original cross cuts was required to give better drilling-faces, especially in the harder pillars. After cross cutting had been well advanced on the top level, drilling was started at the end of the pillar and across its whole width. Following the first rounds, sufficient ore was removed to give entry to the sloping ore, and drills were set up on the broken ore and long holes drilled in the back. On the top level, as a rule, the ore was not broken nearer than 10 ft. to the cap. Drilling followed strict procedure in retreating from the edges of the pillar toward the central drift, and in the retreat along the central drift as the sides were broken. The roof was carried at a slope of 45°. All holes were drilled in the same direction, pointing away from the line of retreat to eliminate the chance of drilling into missed holes on the next cut. The original raises at 50-ft. intervals were used for removing the excess ore, and generally an intermediate series of raises was put up, making the interval 25 ft. The final development to tonnage ratio for the completed breaking of stopes and pillars was therefore reduced by this work to 45 tons per foot of drift, and 200 tons per foot of raise.

The first round of holes drilled from the level broke to 12 ft. above the sub-level; and the second round, on which long steel could be used, increased this height above the sub-level to 20 ft. It was common to drill through, to the broken ore above, but the remaining arch, 5 ft. or so thick, usually caved when the back was arched for the whole 50 ft. of pillar. At the start the experiment was tried of drilling down-holes in the floor of the sub-level to a depth of 5 ft. to assist this subsequent caving from the level below. It was necessary, however, to case the collars of these holes with 3-in. pipe to prevent fitchering. The breaking of these holes was unsatisfactory, so this practice was discarded.

An important detail of pillar-work was the covering of raises as the work retreated past them. Failure to do this properly would defeat the whole system of breaking, as it allowed the cap to pipe through the raises. Protection against this running of the cap was secured by means of stulls placed in each raise 5 ft. below the level on which breaking was being done, these stulls being hitched in the ground and lagged over. When the same raise was reached on the level below, the process would be repeated and the stull-covering above would then be blasted out, allowing the broken ore to fall to the newer and lower covering.

Mining on the last (or sill) floor of the pillars was subject to modifications by the pony-set raises that split the distance between the regular 25-ft. raises on each side of the pillar. These raises were funnelled in retreat from the end of the pillar, like the regular raises. This funneling was not carried more than 25 ft. ahead of the pillar-breaking, because it virtually under-cut the entire width of the pillar. Machine set-ups across the raises for the purpose of drilling the back were made on

10 by 10-in. stringers that extended across the funnel. This was done to insure against a sudden settling of broken ore in the raise.

EXTRACTION OF BROKEN ORE. Systematic drawing of the broken ore was started when about 70% of all stope and pillar mining had been completed. No draw was permitted within 100 ft. of any mining operations. The drawing of one stope next to a pillar that was in process

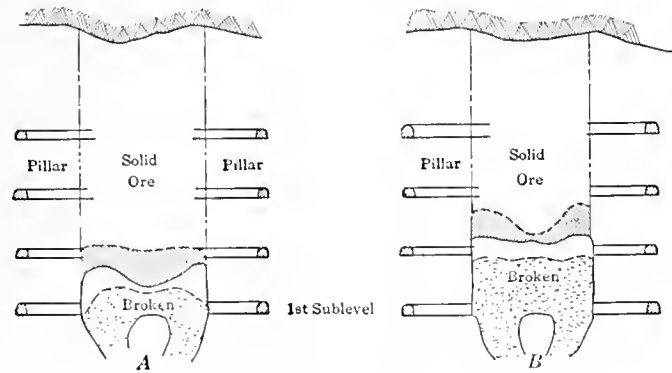

CROSS-SECTION THROUGH STOPE SHOWING POSITION OF ROOF.

of being broken was tried as an experiment, and it caused crushing and swaying of the pillar even in the hardest ground. The question of weight on the draw-off level during the drawing period is an interesting feature. At first there was considerable weight in certain definite portions of the draw-off level, and no weight whatever in other places. This variation in different places was due to a combination of factors: first, the height of cap above the ore in the northern section averaged 340 ft. with a thickness of broken ore of 125 ft. below it. This

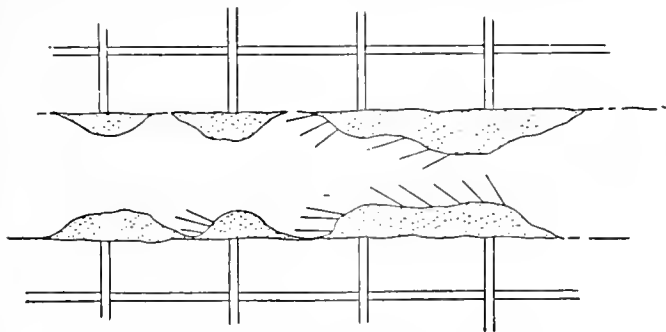

PLAN OF STOPE SHOWING DRILLING METHODS.

gave a total height of ground of 465 ft. in a moving condition. The southern section had an average cap of 250 ft. and a volume of broken ore over 100 ft. thick, with a total thickness of movable ground of 350 ft. The crushing in the northern section was such as to demand complete re-timbering in some of the stopes. In the southern section, the weight was negligible; only about 20% of the linear footage of draw-drifts became heavy enough to require repair. Second, in a small section where complete breaking of the pillars from top to bottom was impossible, there were some blocks of unbroken pillar above the draw-level. Such parts of draw-off drifts as were below these unbroken areas were always heavy, probably on account of unequal distribution of weight, or the con-

centration of the weight at a few points. Third, when drawing had become developed on a large scale over a considerable area, the weight did not show any increase, on the contrary, it showed a decided tendency to slacken. Upon the completion of drawing there was little evidence of weight, and the drifts remained open. It is likely that the broken mass of cap and ore reached a state of equilibrium, and that the weight became widely and evenly distributed. In one large section, where all the conditions during mining were satisfactory and the pillar-breaking most complete, about 70% of the timber

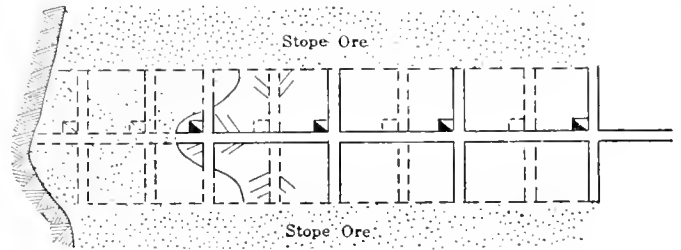

PLAN OF PILLAR SHOWING BREAKING DURING RETREAT.

placed three years ago on the draw-off level still stands.

It is apparent that weight was thrown on the draw-drifts and not on the pillars between these drifts, as shown by the presence of untimbered cross-cuts through these pillars. That the draw-off level took all the weight so that the tram-level was left intact, is shown by the present condition of the latter. Sections of the tram-level beneath badly crushed draw-level drifts do not even require lagging in the roof, and 8 by 8-in. drift-set

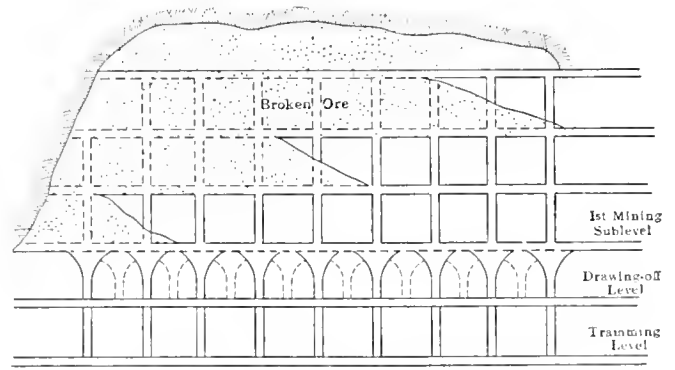

LONGITUDINAL SECTION THROUGH PILLAR.

timbers that have been in place nearly five years show no weight. This is one of the pronounced advantages of the draw-off level. The repair on the draw-off level did not cost over 10c. per ton of ore drawn on any stope or pillar line, and went considerably below this cost on the tonnage served by the entire draw-off level. Repairing was facilitated by chutes every 25 ft. along the drifts.

Control of the draw was essential for an even lowering of the cap, and to permit a retreat from the western to the eastern limits of the section. This required the pulling-down of the cap on an incline of 15° toward the western, or completed, portion. The drawing of a series of chutes in a plane at right angle to the direction of retreat, or across the stopes and pillars instead of along one

whole stope, was the most satisfactory method of getting the ore to run readily. When the draw was started there was difficulty in regulating it. The nature of the ore and the length of time between stoping and drawing, caused the chutes in some areas to pack tightly. An idea of the compact nature of broken ore under pressure can be gained from the fact that occasional cross-cuts were driven from pillars into shrinkage-stope ore, and that no timbering was required for some of these drifts in broken ore. Starting of the chutes in these stopes required special methods. One of the most satisfactory was the use of small pony set raises in the back of the draw-off drift midway between the raises. This involved running an inclined raise for 15 ft. each side of the drift to the broken ore. When a hole was drilled into broken ground, the raise was funnelled immediately, and blasting of this round loosened the ore, usually including that in the adjacent raises. A series of these pony set raises sufficed to make the ore run readily in the regular raises. This method had the disadvantage that the pony sets took weight and were expensive. The second method, which involved no extra raises and was otherwise satisfactory, employed a system of breaking the arch of hung-up ore. Entry to the back of packed ore was made through the raises, and large stulls were placed against the hung-up ore. Small drifts were then started in the foot-wall of the raise and run parallel with the long axis of the stope, at about 15 ft. above the draw-level. These drifts were driven in solid pillar ground and connected a series of hung-up raises. Starting at the end of the drift the ground was drilled vertically and horizontally across the stope. When these holes were blasted the legs between the regular raises were knocked out and an arch of broken ore left. Arches 40 ft. across and 30 to 50 ft. thick were not uncommon in this work, but these arches invariably collapsed, bringing down the stope ore. In this work the hung-up ore would not cave, even if the next raise 25 ft. away was running regularly, so that there was little danger underneath the broken ore, and no accidents occurred. Choking of chutes was caused occasionally by packing of ore in the bottom of the inclines. It was also necessary to blast out part of the brow of the raise over the chute to prevent plugging with boulders. It was desirable to eliminate blasting in chutes and a separate squad was detailed for this.

Over a period of a year, with a production of 400,000 tons, the average rate of drawing per shift was 118 tons per man. The monthly range was from 91 to 142 tons per man. Under favorable conditions the tonnage per man has exceeded 200 for several shifts. The largest individual output reached on one shift was 100 tons by one chute-man. The cost of drawing this ore into the tramming-chutes amounted to 3.7c. per ton over a year for direct expense of labor and explosives. Where special methods were required in the case of hung-up ore, the cost for short periods went as high as 15c. per ton. The result of drawing 1,700,000 tons in one section of the work showed an estimated recovery of 95% of the

original tonnage. Individual records were kept on each stope and pillar, and although the drawing from these is undoubtedly interchanged, the figures favored the stopes over the pillars by about 10%. The harder ore showed greater ease in drawing and better extraction than the softer areas, because the latter packed under pressure. The compression of broken ore is an important factor, as it increases the tendency of the chutes to ravel vertically toward the cap without drawing laterally. Even under moderate pressure, the broken ore tended to stand nearly vertically around the rim of a chute. The angle of repose was found to be 80 or 90°. In a small number of chutes where the ore was greatly packed, the ore drawn corresponded in volume to a cylinder with a diameter of 14 ft., and a height up to the cap. A large number of draw-raises per unit of area, rather than a large area in the funnelled mouth of the raise itself, is desirable for best extraction.

SECONDARY RECOVERY OF ORE. It became obvious that some clean broken ore remained in the stopes and pillars. This remainder probably stood in the shape of a wedge directly over the draw-drifts, and also along the boundaries of the old stopes and pillars. To recover the ore above the draw-drifts, the backs of the latter were shot-down to the floor of the stope. This work was done in retreat, and the ore drawn on the incline into the tram-chutes at a cost of 15 to 25c. per ton, the output per man averaging 40 tons. Results obtained from these operations confirmed the view that the clean ore stood in a series of wedges or cones with an apparent base of 20 ft. and a height of 50 ft. To recover the ore standing where the old pillars joined, a series of drifts midway between the original drawing-lines was driven. These drifts were at the same elevation as the draw-off level. Dump-chutes and supply-raises were provided from cross-cuts on the tram-level at 200-ft. intervals. The drifts were supported by 12 by 12-in. timbers set 4 ft. 2 in. centre to centre, and chutes were placed in each set staggered along the drift. The back was broken on top of the lagging, and a small shrinkage-stope about 20 ft. wide excavated until loose ground was encountered, or until caving occurred. The ore drawn from the chutes was trammed in 1½-ton cars to the main tram-raises, the maximum tramping being 100 ft. This marked the last stage of the process of mining.

PRODUCTION of crude barytes in the United States in 1915 was 108,547 short tons, valued at \$381,032. As compared with the production in 1914, which was 52,747 tons, worth \$155,647, this is a remarkable showing. Reports collected by James M. Hill, of the Geological Survey, indicate that the production in 1915 will be continued, if not exceeded in 1916. Missouri contributed 39,113 tons, Georgia 31,027 tons, and Tennessee 25,074 tons. Alaska shipped its first barytes in 1915. The general feeling of the trade is that this boom is not to be short-lived, particularly in view of the large demand for crude barytes by the newly-established barium chemical industry.

Mining in Arizona

By Charles F. Willis

The rise in the price of silver has given a finishing touch to the metal market. It means much to this State and has already stimulated transfers of property. A local newspaper without the record of several mining deals is becoming rare. These are not all small deals, involving the sale of a few claims for a few thousand dollars, but deals involving the transfer of large properties, upon which many thousands of dollars will be spent, and ensuring the re-opening of old producers.

A deal has been consummated in Cochise county for \$600,000. The claims, 14 in number, are those of the Leadville Mining Co., of Courtland, a local organization. The president of the company is William Holmes, and the secretary, William Monmonier of Pearce. The company has been at work for a number of years and the property has been under option a number of times to different parties. The stockholders have received part-payments on their holdings once or twice on account of these pending deals. The present option taken by the Needles Mining & Smelting Co. provides for the payment of \$600,000 before one year, the sum of \$10,000 to be paid as soon as the optional agreement is ratified by the stockholders at their meeting to be held at Pearce on June 3. The company is to allow the present lessees, now at work on the property, to continue under the same conditions, the royalty to be paid into the First National Bank of Los Angeles and held on deposit as part of the purchase price in the event that the property is taken over. The option requires that at least 10 men shall be employed continuously, that assessment work on the unpatented claims shall be done, and the Maid of Sunshine shaft sunk at least 80 ft. deeper and certain drifts run in that claim.

The Needles company is a subsidiary of the United States Smelting, Refining & Mining Co. A. P. Anderson, the general manager, is said to be a man of wide experience.

Another important deal in which a quick turn was made, is that of the Sitrué mines, in the Huachuca range, better known as the Exposed Reed property. This group of claims had been taken under option in April by Owen T. Smith and J. P. Steel, from Albert Steinfeld of Tucson for the sum of \$40,000. Messrs. Smith and Steel then left for New York, where they succeeded in placing the property with Charles Starek for the sum of \$250,000. The option required the payment of \$25,000 before June 10 of this year, and for the payment of \$25,000 every ninety days after, until \$225,000 has been paid. Work must be started in 30 days, and active development work continued. The property is to be worked for tungsten instead of gold. There is some machinery on the mine, and a mill and concentrator will be installed. The ore is scheelite in wide quartz veins.

George A. Brown and his wife of Dragoon have sold 80 acres of their homestead for \$30,000 to S. H. Worrell of El Paso. The land lies in the wolframite district between Dragoon and Johnson. The terms call for the payment of \$3000 on the signing of the papers, for the payment of \$13,500 within six months, and the remainder at the end of a year. The land is now being worked for wolframite both by placers and shafts. Mr. Worrell intends to install a concentrator.

Henrietta Franklin and husband have sold to Thomas R. Sorin the Bonanza claim in the Tombstone district. The property at one time produced high-grade silver ore. Charles Morgan has sold to J. L. McWilliams of El Paso an undivided one-sixth interest in three claims in the Hartford district. H. W. Rector has sold to R. T.

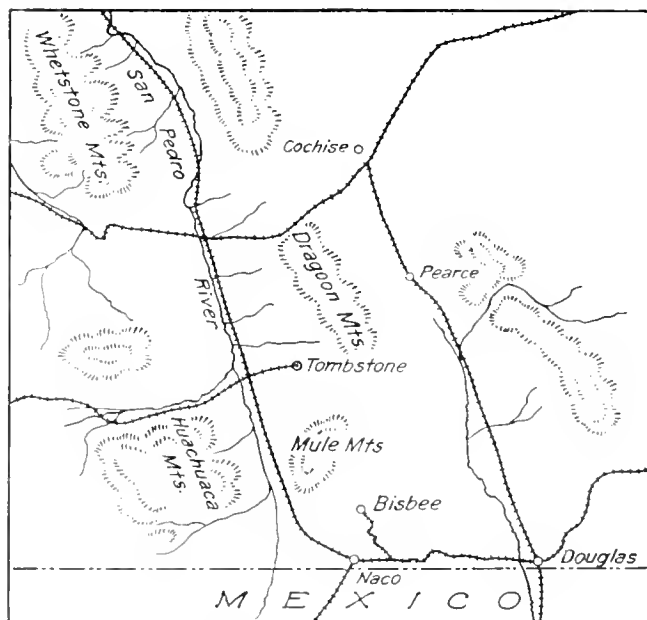

Burlingame the Rector claim in the Warren district. George W. Cox has sold to William H. Johnson the Lid claim in the Cochise district.

The San Juan mine, on the Graham county side of the mountains of the Clifton-Morenci district, has passed from the ownership of local people to F. W. Estabrook. Details were not given out. Mr. Estabrook is a member of the board of directors of the Miami Copper Co. His representative was Ethridge Walker, mining engineer, who will be the president of the new company. The 12 claims of the San Juan company were originally located by a woman who came out from the East and prospected in the Lone Star district. Subsequently she was able to interest capital and a development company was formed, which resulted in some development of the claims, the deepest work being done at 335 ft. The records show that over \$300,000 worth of ore was shipped when, owing

to a disagreement between the stockholders and the management, and the further fact that copper had dropped to 9 cents, the company ceased operations. The Arizona stockholders did the required assessment work and it was from them that the property was secured last February by R. W. Craig, Gus Hirschfeld, T. J. Sparks, and J. C. Adams. The transaction was promoted by Louis A. Dunham, who figured prominently in the sale of the Inspiration and Ray copper mines. During the short time the above-mentioned owners had the property, nine cars of ore were shipped to the C. & A. smelter at Douglas, the returns showing an average value of \$1434 per car. In addition, a number of churn-drills have been operated, the last report of the company indicating 970,000 tons of ore averaging 3.67% copper. The recent work at the mine has been in charge of Sam Fields who was previously a superintendent at the Calumet & Arizona mine and later at the Ray Consolidated. After he had worked on the property 90 days, Mr. Fields became a shareholder in the company. The rumor that the Lewishus are associated with Mr. Estabrook in this venture has been denied, but with the statement that other Miami company stockholders are concerned in the purchase.

The Old York group of gold mines, situated a mile south of Yarnell, is now active under an option given to Bliss, Wilson & Co. of San Francisco. A modern equipment has been selected, including an air-compressor and hoist. The machinery is on the way from San Francisco. The Old York has been explored extensively, the main shaft reaching to 400 ft., with several thousand feet of workings. It will not be a public-stock company; D. C. Burt of San Francisco is to be superintendent.

Details regarding the re-organization of the Inspiration Needles Copper Co. and the acquisition of 11 claims adjoining the property in Live Oak canyon, just west of Miami, have just been disclosed. The company secures control of 525 acres of mineralized ground much the same in surface characteristics as the Live Oak group of the Inspiration Consolidated Copper Co. Within 10 days three churn-drills, leased from the Inspiration Consolidated, will be operating. Nothing more than location work has been done, although the belt on which the great low-grade orebodies of the Inspiration Consolidated are found extends through the ground. A number of engineers have made favorable reports on the property, but complications have prevented development. With the claims in one group, their value is much greater than when they were held by several owners. Harry Lefkowitz, a merchant of Phoenix and Miami, promoted the re-organization of the company. Dan R. Williamson, for many years the principal stockholder of the company, continues president and F. W. Hann is secretary. The company is capitalized for \$2,000,000 in \$1 shares. Original stockholders and claim-owners have received 1,200,000 shares, and the remaining 800,000 are in the treasury. A block is to be sold at 50c. per share to raise a fund for development. The first issue of the stock was

subscribed within a few hours at Miami and on the Boston and New York curbs.

The Bisbee Ajo Copper Development Co. is the latest organization to bid for favor in the Warren district. This property is in the Sonoita range of mountains, 22 miles south of Cornelia; it includes 21 unpatented claims, known as the September Morn group. The ground was located in September, two years ago. The claims include a hill of schist and monzonite, impregnated with copper sulphides; chalcocite, bornite, and chalcopyrite. In places high-grade ore outcrops, and there is every indication of large bodies of concentrating material. The company is capitalized at \$650,000, the shares having a par value of \$1 each. Of this stock, 150,000 has been pooled for the promoters, and 100,000 shares, it is understood, have been put on the market at 25c. per share.

A mining deal that may lead to developments in the Globe-Miami district, which has long been neglected, was closed when William Buckland transferred to T. J. Minck, of New York, 16 gold claims on the eastern slope of the Pinal mountains, eight miles south of Globe. Buckland has spent many years prospecting that part of the district, and his efforts were rewarded by the discovery of gold in paying quantity, some of the ore assaying as high as \$50 and \$60 per ton. Working alone, and with scarcely enough money at times to buy powder and fuse, Buckland has sunk a number of pits and shallow shafts, and has found the best ore in the deeper openings. The road from Globe to Winkelman by way of El Capitau will run within a mile and a half of these claims.

Gold in Russia

The French paper *L'Information* gives the following details with regard to gold in Russia: "The Russian Government, anxious to increase the gold reserve of the State Bank, and to favor the production of gold within the Empire, has decided to accord for gold brought voluntarily to the laboratories or to the bank a premium of 45% on the pre-War price. Unfortunately, notwithstanding the prohibition of gold exports, the receipts of gold have barely increased; for merchants purchase the metal and send it abroad by the Asiatic route. In these circumstances the Russian Minister of Commerce and Industries has decided to ask for power to requisition gold in the hands of private people, payment to be made therefor, plus the premium of 45% as stated above."

KLNLCOTT COPPER Co. produced 57,500,000 lb. of copper in its seven months of operation during 1915 at a cost of 4.54c. per lb., of which nearly one-half was the freight from the mines in the interior of Alaska to the Tacoma and Garfield smelters. An ammonia-leaching plant, somewhat similar to that of the Calumet & Hecla, is to be built for treating tailing from the mill. The grade of the ore mined last year averaged 60% copper. The production for 1916 is estimated at 120,000,000 lb.

A Portable Equipment for Prospects

By Louis A. Rehtuss

The tendency of the age is the worship of Bigness. Nothing so catches the eye of the public as the announcement of some monster material achievement, whether it be the building of a Panama Canal or the construction of a new sky-scraper. So we need feel no surprise that our technical mining literature today should reflect the same craze and be filled to over-flowing with articles describing giant machinery or new processes to extract the last drop of blood out of a stone. This tendency would be perfectly commendable were it not for the fact that in their rush for efficiency and bigness our engineers have neglected to discuss the problems presented by the prospect and small mine, so that it is but seldom that the small operator can find anything of immediate value in technical journals, despite the fact that there are ten small mines and prospects operating for every mine of size sufficient to render the more ambitious articles necessary. There is more especially a demand for information as to what machinery is available on the market in complete units and yet small enough for prospects.

To discuss this question is the object of this article and more particularly to describe the plant we are using today in developing a prospect here at West Point, California. Suffice it to say that this outfit, which includes power, compressor, drills, air-hoist, and pump will not in the aggregate weigh over three tons, with the heaviest unit only 1800 pounds, so that the whole outfit may be moved at small expense from prospect to prospect until a mine is developed. Having been in use by us for two and a half years with complete satisfaction, it is no longer an experiment.

Operating in the East belt in the granodiorite formation that surrounds West Point, we soon realized that if we were to make much progress we must have a machine-drill. At the same time the undeveloped condition of the prospect did not warrant heavy investment in the shape of mining machinery. Most of the mines in this region use the abundant wood supply of this timbered country to fire steam-boilers, but their boilers are heavy and cumbersome, and rather wasteful of wood, so that wood-choppers' wages are a considerable item each month. Therefore we purchased a 16-hp. Clay marine gasoline engine. This engine is an upright two-cylinder machine weighing 1800 lb. An investigation of horizontal stationary engines of the same power showed that they are relatively clumsy and far heavier, and consequently unfitted for our purpose. The marine engine has given excellent satisfaction and we found it required but light foundations. A couple of logs laid lengthwise and parallel with cross-pieces for the engine and compressor, mounted at the opposite ends, has served us excellently with scarcely perceptible vibration.

For the compressor, a Rix duplex-vertical machine, 6 by 6, serves admirably. It has a capacity of from 45 to 80 cubic feet of free air per minute up to 100 lb. pressure, or sufficient for one hammer-drill. This compressor weighs only 1000 lb., but is designed to run at rather high speed from 225 to 400 r.p.m. Owing to an efficient system of lubrication, however, it stands up well under service, and, in fact, after two and a half years of work, we can testify that this machine has done remarkably



THE LEADVILLE DRILL-COLUMN HOIST IN USE.

well—the only cost for repairs in that time amounting to three or four dollars. We have not had occasion to tighten a single bearing in that time. The compressor was, of course, belted to the engine, and the speed of the engine mentioned with the fly-wheels provided we found to be suitable without reduction or alteration in any way.

There are now on the market direct gas-driven compressors that form compact units. They are, however, somewhat heavier than the combined units mentioned and are rather more expensive. These direct gas-driven compressors are made as small as 66 cu. ft. in capacity.

All of our drilling we do with an Ingersoll-Rand butterfly stopper and an Ingersoll jack-hammer, using these for overhand stopping and sinking respectively. In driving we employ the stopper to drill the upper rows of holes, while the lifters are drilled with the jack-hammer in the method shown in the sketch, sliding the drill down a U-shaped wooden trough by foot pressure. This is a peculiarly easy method of utilizing the jack-hammer for such work. The notched post from which the uppers are drilled with the stopper forms a convenient back-rest in

drilling these lifters. The cut, of course, is made by rows No. 1 and 2. We have tried many types of rounds, but we find a round drilled as shown about the most satisfactory it is possible to get in using a stoper and jack-hammer for driving. Unless the ground is quite tight, it will break practically to the bottom of the holes.

During the last few years excellent hammer drills have come on the market that can be used for all three functions: driving, stoping, and sinking. These are provided with a light column. Among such types may be mentioned the Waugh stoper, the Ingersoll 'Mounted Jack-hammer,' the Sullivan pneumatic-feed, and others. One of these would probably make the best unit for a prospecting equipment limited to one drill. The heavier types of drills are precluded because of their large air consumption.

For hoisting we employ a Leadville drill-column hoist. This is a veritable pocket hoist, but when one has air

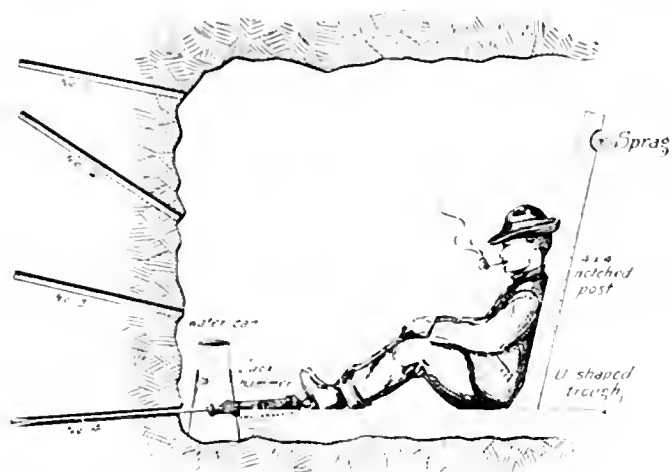

A COMFORTABLE METHOD OF DRILLING.

available for drilling, it certainly beats windlassing all hollow. By using two buckets, one being hoisted while the other is lowered at a depth of 100 feet, it will give the trammer all the work he wants to do. It will hoist loads up to 500 lb. There are several varieties on the market, including the Ingersoll-Rand 'Little Tugger' and the Holman 'Stretcher Bar' hoist, besides the Leadville type mentioned. They all operate on compressed air, and while designed to operate on a column, can be readily installed as a surface equipment. The total weight of the Leadville hoist without the column is only 250 pounds.

A small steam-pressure pump, of capacity 30 gal. per minute, will run quite well on the compressed air available and will be found large enough for most prospects in the early stages at least. Outside of a tendency to freeze now and then, this equipment gives pretty good service.

With the small amount of air available, it is not possible to perform the three operations of drilling, hoisting, and pumping at the same time. They must be performed separately. A little adjustment of routine, however, makes this work out satisfactorily. The fuel-cost is quite low. Since freight on fuel was the same in all cases, and gasoline gave better results than distillate, we used gasoline. Where the equipment is employed pretty

steadily throughout the shift—drilling, hoisting, and pumping—it will be found that the gasoline used will seldom average over \$1 per shift. So far as attention goes, it is practically nil. The engine may be started up and left to itself. It needs no attendant, no costly fireman to sit around and eat the profit. The factor of idle hands is one of the most potent of all in killing many a good prospect. A mine that is operating one machine-drill cannot afford to have a blacksmith and helper, as we have seen at some mines. Two or three hours work per day on the part of two men will attend to all the necessities of blacksmithing and do in our case, after which these men can start drilling or anything that may come along. By employing four men, two on each of two shifts and having them perform whatever comes along, it will be found that the above outfit will permit of a considerable amount of work being accomplished at a very moderate cost.

MANY MINING COMPANIES are providing buildings where the miners may remove soiled working-clothes, bathe, and put on clean, dry clothing before returning to their homes. Most workmen nowadays like to go to and from their work dry and clean. In many instances miners' cottages have no running water inside and it is a burdensome task to bathe at home. In addition to its cleansing effect, the shower-bath refreshes the tired workman so that he goes home in a more agreeable frame of mind. It is interesting to note that some of the best change-houses are to be found in Michigan, Minnesota, and Alabama, although those States have no law requiring such houses. Some of the earlier change-houses were not kept clean, and so fell into disfavor, their equipment breeding vermin. In some of the earlier buildings a wooden locker was furnished each man. This one locker was used both for street clothes and mine clothes. Because there was no circulation of air in the lockers, the mine clothes would not dry and the miner was forced to put on damp clothes for his day's work. The perforated metal locker has supplanted the wooden locker; and in order to keep the mine clothes separate from the street clothes, two lockers have been furnished each man. The one for street clothes is made of expanded metal, well perforated. The mine-clothes locker is of sheet metal and is as air-tight as possible, except for the vent-pipe at the top. Other lockers have upper and lower compartments, the upper for mine clothes and the lower for street clothes. A steam-pipe is run through the bottom of the upper compartment to furnish heat for drying the mine clothes.—U. S. Bureau of Mines. TECHNICAL PAPER No. 16.

Spokane, Washington, a city of 140,000, is a convenient centre for Coeur d'Alene mining. It is an enterprising attractive city with broad streets and modern buildings. The people of the surrounding region, which includes parts of several states and of British Columbia, like to speak of Spokane as the centre of 'The Inland Empire.'

Recent Patents

1,182,748. ORE-FLOTATION APPARATUS. John M. Callow, Salt Salt City, Utah, assignor to Metals Recovery Company, Augusta, Me., a Corporation of Maine. Filed June 15, 1914. Serial No. 845,306.

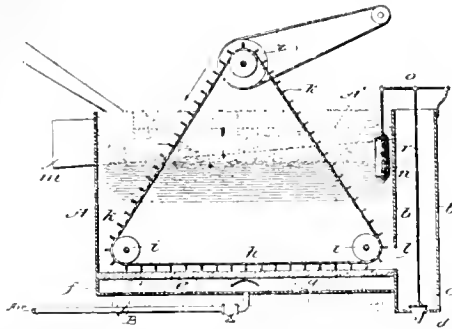

1. An ore flotation apparatus having a pulp-containing tank and a porous body therein through which streams of a gaseous fluid under pressure are admitted into the solution from below, said porous body permitting the passage of the gaseous fluid but not pulp and water, and an endless traveling carrier movable through the tank and having elements operating in proximity to the upper surface of said body for maintaining the heavier constituents of the solution in suspension to thereby prevent the blanketing of the outlets of said porous body.

1,180,209. TABLE FOR ORE AND COAL WASHING. Charles E. Thompson, Denver, Colo., assignor to The Mine & Smelter Supply Company, Denver, Colo., a Corporation of Colorado. Filed May 31, 1913.

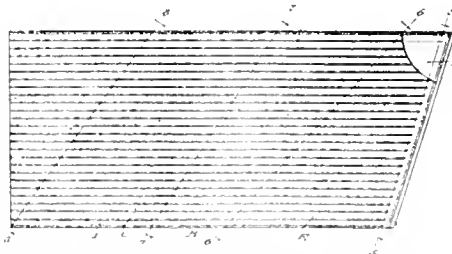

1. A table for ore and coal washing, the entire surface of which is ruffled from one end of the table to the other, forming alternate areas across the table in which the ruffles are uniform and tapering, one of these areas having the tapering ruffle located at the feed end and one area in which the ruffles are of uniform height located at the opposite or concentrates discharge end, the mergers between uniform and tapering ruffles forming diagonal lines across the table.

1,181,244. ART OF AGGLOMERATING ORES. James H. Payne, Baltimore, Md. Filed July 28, 1915.

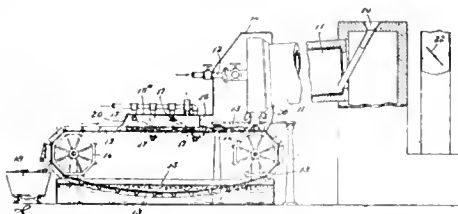

1. A process of agglomerating metal sulfids which comprises heating said sulfids, in a non-oxidizing atmosphere, to a

temperature of incipient fusion under conditions to prevent removal of material amounts of the fixed atom of sulfur, spreading out the heated ore, and cooling the same to below a roasting temperature, in the substantial absence of free oxygen.

1,181,184. ROASTING-FURNACE FOR SULFUR-BEARING ORES. Harry H. Stout, New York, N. Y., assignor to General Chemical Company, New York, N. Y., a Corporation of New York. Original application filed July 31, 1914, Serial No. 854,230. Divided and this application filed June 5, 1915.

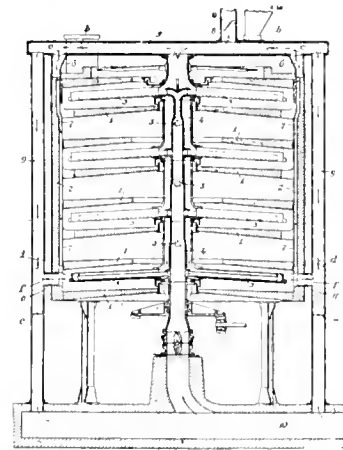

1. In an ore roasting-furnace having an outer, cylindrical wall a plurality of superposed roasting chambers and a rotary air-cooled rabble system, the combination of a metallic downwardly extending conduit the external surface of said conduit being exposed to the atmosphere of certain of said roasting chambers and the lower end thereof being in communication with the lowermost of said chambers, and means for conducting air from the upper end of the rabble system to the upper end of said conduit, substantially as and for the purpose described.

1,177,981. MAGNETIC SEPARATOR. Parvin Wright, Vancouver, British Columbia, Canada. Filed May 14, 1914. Serial No. 838,504. (Cl. 83-71.)

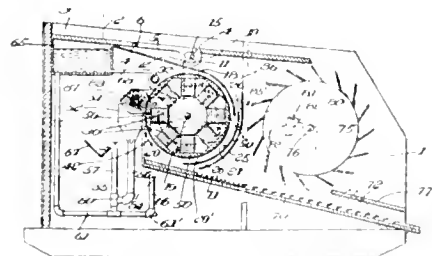

1. In a magnetic ore separator, a flume into which the ore is first placed and washed down, means for discharging the fine sand from said flume, means for separating the fine sand from the surplus water therein, a magnetic separating device for collecting the magnetic material from said fine sand when said surplus water is separated therefrom, means for discharging said magnetic material from said separating device, a second flume, means for delivering the non-magnetic material upon said second flume, and means for delivering said surplus water to said second flume to wash the non-magnetic material down said flume.

1,177,819. COMBINED SETTLER AND HYDRAULIC CLASSIFIER. Courtenay De Kalb, Tucson, Ariz. Filed Apr. 9, 1914. Serial No. 830,845. (Cl. 83-824)

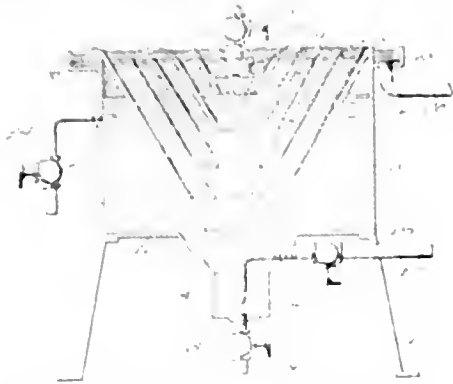

1. In an apparatus of the class described, a tank open at its upper end, a plurality of concentrically arranged baffle members positioned within the tank, and a feed sole having a concavity in its upper face centrally supported in the upper end of the tank with its upper peripheral edge in the plane of the upper edge of an adjacent baffle member.

1,182,514. THICKENER. Albert E. Vandercook, Alameda, Cal., assignor to California Mayan Company, a Corporation of California. Filed July 21, 1914. Serial No. 852,162.

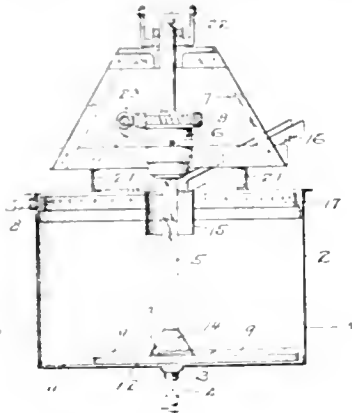

1. A thickener comprising a tank, a curved blade therein arranged adjacent the bottom thereof and having a plurality of convolutions in a plate intersecting its axis of rotation at an angle, the successive convolutions of the blade lying closer together as the blade progresses inwardly, and means for rotating said blade about said axis.

1,180,816. FLOTATION OF MINERALS. Raymond F. Bacon, Pittsburg, Pa., assignor, by mesne assignments, to Metals Recovery Company, a Corporation of Maine. Filed Aug. 11, 1914.

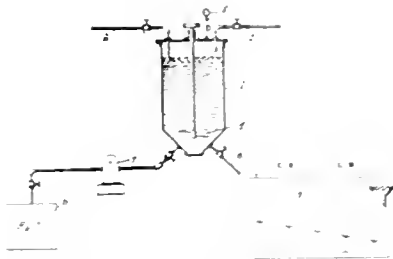

1. The method of effecting the separation of oxidized ores from associated gangue, which consists in subjecting the mixture, in a finely divided condition, to the action of hydrogen sulfid under pressure, and finally subjecting the mixture to flotation; substantially as described.

2. The method of effecting the separation of oxidized ores from associated gangue, which consists in subjecting the mixture, in a finely divided condition, to the action of hydrogen sulfid under a pressure as high as 20 pounds to the square inch, and finally subjecting the mixture to flotation, substantially as described.

1,181,626. GOLD SEPARATOR. Jerome W. Sweet, Half Moon Bay, Cal. Filed Nov. 17, 1913.

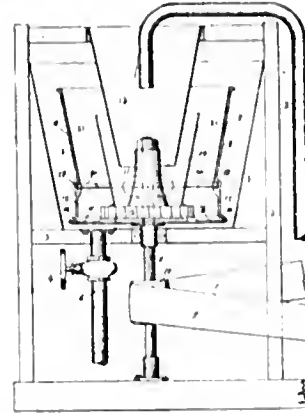

1. In a centrifugal apparatus for separating the valuable from the worthless parts of fine ore, the combination of a revolving bowl, a series of vanes extending outwardly from the centre of the bowl, a chute delivering material to be treated into the bowl directly above the vanes and near their inner ends, a depression for the heavier and larger particles of value located between the outer ends of the vanes and the wall of the bowl and communicating with a collecting groove formed in the wall of the bowl in the plane of the said depression, and means for collecting the lighter particles of value carried by the wall of the bowl and located above the said depression and the groove.

1,180,841. PROCESS OF EXTRACTING COPPER FROM ITS ORES. William E. Greenawalt, Denver, Colo. Filed Sept. 30, 1912.

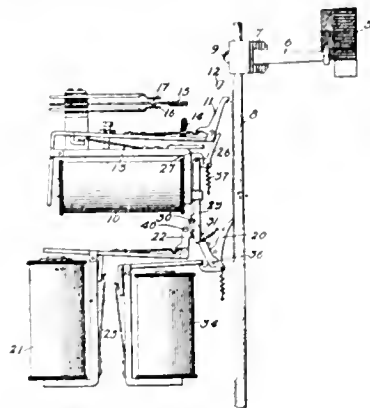

1. A process of extracting copper from its ores which consists in treating the ore with a chlorid solution to dissolve the copper; separating the solution from the gangue; treating the copper solution with sulfur dioxide to convert the cupric chlorid to the cuprous chlorid and regenerate acid; then treating the solution with hydrogen sulfid to precipitate the copper as sulfid and regenerate more acid; separating the regenerated acid solution from the sulfid precipitate, and returning it to the ore.

1,178,191. COPPER PRECIPITANT. Henry Livingstone Sulman and Hugh Fitzalis Kirkpatrick Picard, London, England, assignors to Minerals Separation American Syndicate (1913) Limited, London, England. Original application filed Dec. 27, 1913. Serial No. 868,986. Divided and this application filed June 15, 1914. Serial No. 845,086. (Cl. 23-13.)

REVIEW OF MINING

As seen at the world's great mining centres by our own correspondents.

CRIPPLE CREEK, COLORADO

GOLD OUTPUT.—DRAINAGE-TUNNEL.—MILLS AND LEASES.

Gold production of the district in June, as reported by the mills and smelters, is as follows:

| | Tons | Grade | |
|-----------------------------|---------------|----------------|--------------------|
| Golden Cycle | 36,000 | \$17.00 | \$612,000 |
| Portland | 12,000 | 21.00 | 252,000 |
| Portland | 17,800 | 2.78 | 49,484 |
| Portland | 11,890 | 2.12 | 25,207 |
| Smelters, Denver and Pueblo | 4,360 | 55.00 | 239,800 |
| Caley-Jerry Johnson | 1,800 | 3.50 | 6,300 |
| Worcester-Rubie | 300 | 3.50 | 1,050 |
| Total | 84,150 | \$14.09 | \$1,185,841 |

For some months the plant of the Golden Cycle company at Colorado City has been undergoing extensive changes and additions. The capacity of the mill at present is 1500 tons daily, instead of 1000 tons as before.

During May the advance of the Roosevelt drainage-tunnel was only 150 ft. The work of carrying forward the heading was considerably hindered by the necessity for enlarging the station at the point of connection with the Elkton shaft, and the sinking of a sump below the tunnel-level at that point.

Work on the foundations for the new Portland sampler is being rushed forward. Excavations for the concrete piers are about completed. Timbers for the frame-work are put together and are ready for erection. Steel I-beams and other structural members are arriving daily.

It is reported that the group of claims comprising the Rose Nicol property, situated on Battle mountain and Bull hill, has been leased to Edwin Gaylord and associates for five years.

J. F. Burns of Colorado Springs heads a new company to be known as the New Era Leasing Co. This corporation has been formed to develop the Minnehaha claim of the Jennie Sample Consolidated Mining Co. E. P. Arthur, Jr., of Cripple Creek, is reported to have charge of operations for the new company.

Rumors have been circulated during the past week that another 'Cresson vug' has been uncovered by lessees on the Queen Bess lode on Tenderfoot hill. While not as extensive as the famous 'jewelry shop' of Raven hill, the ore is being sacked and should give handsome returns to the fortunate lessees.

OURAY, COLORADO

FLOTATION AT THE ATLAS MILL.

The increase in the price of silver is stimulating mining in this district, and there are a dozen or more properties being worked within a radius of 10 miles of the town. Probably the largest producer in the district at present is the Atlas Mining & Milling Co., operating its mine and concentrating plant near Sneffels, which is 10 miles by wagon-road southerly from Ouray. The ground is covered by snow most of the year, the altitude being 12,000 ft., with the mill 800 ft. lower.

The company has recently installed at the mine a Westinghouse storage-battery motor capable of hauling 21 empty and 10 loaded 1-ton cars. Ore is carried from the mine to the ore-bins, from there by aerial tram to the mill, 1800 ft. distant.

This locomotive has proved economical and entirely satisfactory.

A brief description of the mill, shown in the accompanying photo, is as follows: Though lacking in any unique features, it is somewhat famous as being the first plant in the United States to successfully concentrate silver-lead ore by flotation. The ore first passes through gyratory-crushers, then to 20

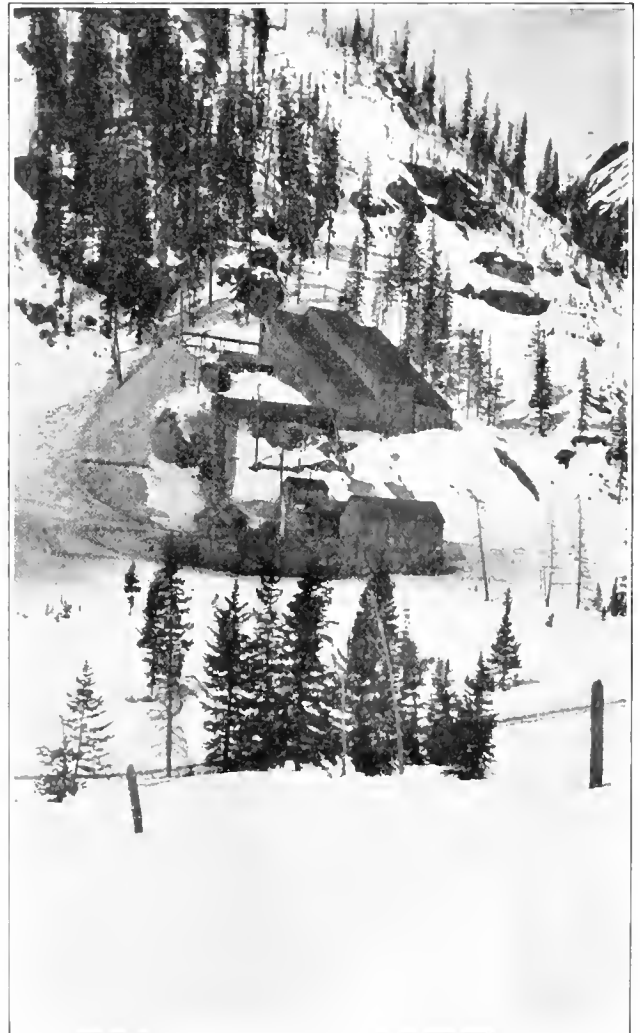

ATLAS MILL NEAR SNEFFELS, COLORADO.

stamps. The product from these flows to two Wilfley tables, then elevated and classified. The plug product from the classifier goes to Hardinge mills, and the overflow direct to flotation machines. Wilfley tables get the oversize, and the slime is fed to flotation machines.

In the flotation department an 8-compartment Minerals Separation and a 3-compartment Hebbard machine are operated. The first cell of the M. S. machine is used as a mixer, the second and third, and sometimes the fourth, cells are skimmed for concentrate, the remaining cells for middling, while the Hebbard machine is skimmed for middling only, which is re-

turned to the first cell of the M. S. machine. Concentrate is sent to the dewatering tank, and overflow returned for re-treatment. From the dewatering tank the concentrate is hauled by handcarts to the inclined drier. This is a wooden trough 20 in. wide by 18 in. deep, and approximately 90 ft. long, having three steam pipes fitted longitudinally on the bottom over which the concentrate is allowed to flow by gravity, accelerated from time to time by four or five men stationed at various points along the incline, which leads directly to the sacking-house, where the concentrate is sacked and shipped by wagon to Ouray, and transhipped by train to the smelter at Salida.

The flotation medium here is a mixture of fuel-oil and pine-oil, although cresote and other oils work apparently as satisfactorily. The recovery recently made is 91%, which must be extremely gratifying to the management of the Atlas company, of which James A. Lannon is superintendent with A. B. Shipman in general charge.

SILVERTON, COLORADO

ORE TREATMENT AT SILVERTON AND GLADSTONE.

The Meats-Witlley company is re-modeling its concentrating plant near Silverton, installing an additional Minerals Separation flotation machine of five compartments, also another tube-mill, 5 ft. diam. and 16 ft. long, manufactured by the Denver Engineering Works. With this extra equipment the mill will have a capacity of 500 tons per day. The company intends to treat tailing from the old Silver Lake mill, as has been done in the past, raising it by a specially designed pump, (centrifugal type) from the lake to the creek-bed, which carries the pulp a mile or so, then by flume two miles long to the concentrating plant. Here the tailing is re-ground to 40-mesh, and concentrated by Witlley tables and flotation machines. The mill is expected to be in operation by the middle of July.

The Kittima Mines Co. of Wyoming, with head office at Denver, is operating its mill 4 miles north-east of Silverton, using the usual crushers, tube-mills, and concentrating tables. A lead concentrate is obtained direct from the tables. The zinc heads are sent to a drier, later to be treated by three Huff electrostatic separating machines, making a product containing 48 to 52% zinc. The iron concentrate carries 19 to 16% copper and \$20 per ton gold. The company has ordered and will install at once a flotation machine to treat the tailing, built by the Dale & Tanstead company of Silverton. The mill has a capacity of 135 tons per day, the ore being carried from the mine by aerial tram, two miles in length. D. B. Carey is president of the company and A. Malchus is manager.

The Gold King Leasing Co.'s mill at Gladstone, which has been closed since February, is now operating with a full crew. The capacity of the plant is 250 tons per day. The flotation machine of 40 cells is giving great satisfaction. L. O. Bastian is superintendent and J. H. Slattery general manager. The head office of the company is at Silverton.

ELY, NEVADA

NOTES ON A PROBABLE NEW PRODUCER.

Announcement that at a meeting held a few days ago at New York officials of the Consolidated Coppermines Co. had subscribed \$100,000 with which to re-illuminare this property is considered most important for this part of Nevada. This company controls the most extensive area of any in the district, which almost surrounds the Nevada Consolidated. Engineers predict that it will eventually prove to be a prolific copper producer. It is understood that the old Giroux mill will be re-modeled and a flotation plant added for treating 500 tons per day. Negotiations are said to be progressing favorably for the Nevada Con. to treat a minimum of 1000 tons per day.

Revival of this property will add several hundred men to the pay roll of the district, and greatly increase the output.

The history of the Coppermines before and since the consolidation of the various interests now included in the holdings has been a long run of misfortune, internal dissensions, and litigation, the end of which now seems to have been reached through conciliation of all factions. Identified with its management, control, and as large factors have been such noted operators as Giroux, Cole, Ryan, Wall, and others who have seldom been in complete harmony regarding the operations of the property. Managerial operating, and financial troubles have nullified almost every effort to place the property in its right position among the great copper producers of the country.

After the loss of the Giroux shaft, by caving, to a depth of about 1300 ft. a few years ago, the Cole management sank a new shaft of five compartments, equipped with a splendid hoisting-plant; but at a depth of about 1000 ft. they encountered an immense flow of water, which was followed by a fire that wrecked the shaft. In the meantime, churn-drilling has been conducted over a large area, with excellent results reported, and a considerable production has also been made from a part of the property by means of work of the Nevada Con., which has extended its workings into this ground for acquiring convenient access to one of the steam-shovel pits. In former work at the Giroux, large bodies of high-grade oxide ore containing 25% were developed, and other work has proved the existence of immense deposits of sulphide ore over a large area.

GUADALAJARA, MEXICO

COMPOSITION OF ZAPATISTA SILVER COINS AND MONEY PROBLEMS.

Having an opportunity recently to assay and weigh some Zapatista silver pieces I include the results as under. These are of interest because of the varying fineness in gold and silver, the decrease in the weight of the pieces the second year and also, not unexpected, the pieces being marked with a gold content which they do not contain. The pieces assayed were P1 and P2 for 1914 and 1915 respectively. The workmanship is poor. There is much speculation as to the value of these pieces, and many have the idea that they are worth several times their stipulated value on account of the gold they contain. It is probable that pieces of the same denomination and with identical markings vary greatly in silver and gold content.

| Piece | Year | Weight grams | Marked | | Actual | |
|-------|------|--------------|------------|----------|--------|-------|
| | | | gold grams | Fineness | Ag | Au |
| 1 | 1914 | 14.8 | 0.3 | 862 | 29.0 | 0.43 |
| 2 | 1914 | 25.1 | 0.595 | 856 | 13.8 | 0.327 |
| 1 | 1915 | 12.2 | 0.3 | 892 | 3.2 | 0.039 |
| 2 | 1915 | 18.7 | no mark | 785 | 9.8 | 0.183 |

The money question in this part of the republic is becoming exceedingly complex. A short time ago local editions were declared out of circulation, and on June 3 the twenties, fifties, and hundreds of the editions Vera Cruz-Gobierno Provisional and of the Ejercito Constitucionalista, were declared out of circulation, all without previous notification. For a few hours in the morning of June 3 business was done with this money, and at about ten o'clock in the morning it was declared officially out of circulation. Of course the Government promises to redeem this money during July, and pay double its present value in gold to those who show their confidence by depositing their money for redemption.

The Cinco Minas Co.'s property was attacked by bandits on May 29, but the guard succeeded in driving them off after a four hours' battle with no loss of life to the mine. Two or three of the attacking party were killed or badly wounded, and furnished food for the not overfed razorbacks of the camp.

THE MINING SUMMARY

The news of the week as told by our special correspondents and compiled from the local press.

ALASKA

KNIK

The estimated gold production from quartz in the Willow Creek district for the 90-day season is \$500,000, a good increase. There are 150 miners employed. The Mabel company has erected a mill. The Yago and Matanuska companies are developing their properties extensively. In 1915 the Gold Bullion yielded \$132,000, Martin \$150,000, and Independence \$50,000. The Willow Creek Mines Co. has been formed to operate in the district. It has a lease on the Gold Bullion. Willow Creek will soon be served by the new railway from Anchorage.

ARIZONA

COCHISE COUNTY

During May the Shattuck-Arizona produced 1,383,963 lb. of copper, 25,865 oz. of silver, and 326 oz. of gold. No lead out-

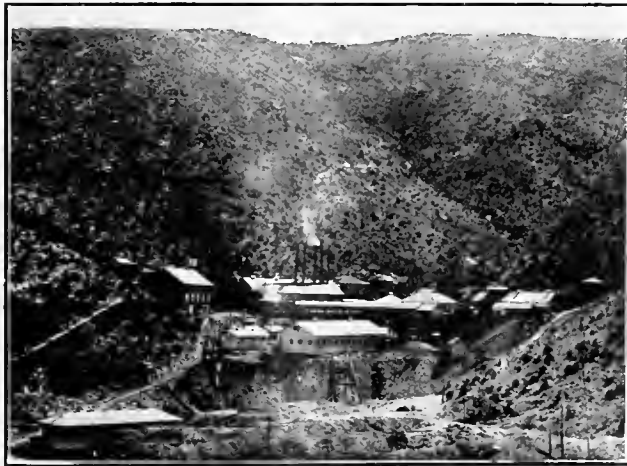

SHATTUCK-ARIZONA MINE AT BISBEE.

put was reported. The lead yield varies, the first four months of the year giving 267,853, 499,155, 714,379, and 130,570 lb., respectively. A dividend of 50c. plus an extra of 75c. per share has been declared.

GILA COUNTY

Twenty-five miles south of Globe steady development is under way at the Troy copper claims, owned by the Troy Arizona Copper Co. of Boston and New York. R. G. Mead is supervising exploration. Prospects are fairly good. The same people have bonded the Cane Springs gold claims, two miles south.

MOHAVE COUNTY

The Desert Power Co., whose lines end at Golconda, are being extended to Chloride, a distance of 8 miles.

If the Minnesota-Conner mine in the Wallapai district can be financed, another good producer would be added to the list. Past outputs total over \$1,000,000 from a depth of 700 ft. The mine is idle, but is kept dry by bailing and pumping. P. S. Virgin is in charge of this gold-silver-lead property, which is well equipped.

Ten miles from Chloride the Arizona Butte Mines Co. is working several mines. An aerial tram at the Banner is available for carrying ore from the group. As no treatment plant was near-by the mines were not worked for several years. Past production is said to be considerable, and a good deal of ore is available. Henry M. Crowther is in charge.

The Kingman Zinc Co. is producing concentrate regularly at the Cupel mill.—The Golconda Annex is shipping ore, which contains more lead than zinc.—High-grade gold, silver, and zinc ore has been opened in the Cerbat mine, and extraction is to commence soon.

Developments at 400 ft. in the Pioneer at Oatman are exciting attention, as for a length of 25 ft. there has been opened 8 ft. of ore worth \$16 per ton. The new big mines with possibilities are the Big Jim, Pioneer, and United Eastern, and the old producers, the Gold Road and Tom Reed.

CALIFORNIA

Since the Workmen's Compensation, Insurance, and Safety Act became effective on January 1, 1914, up to and including the 31st of May, 1916, the Industrial Accident Commission has decided 2240 cases (exclusive of thousands of controversies adjusted without the necessity of formal hearings). Of this number there have been appealed to the Supreme Court and the District Courts of Appeal, 88 cases, leaving 2152 decisions of the Commission from which no appeals were taken, but which decisions were accepted by the parties as final and conclusive as to the law and facts. Of the 88 cases appealed, writs of review were denied in 26, and the decision of the Commission was affirmed in 6, making a total of 32 in which the decisions of the Commission were sustained by the Appellate Courts. Of the 88 cases appealed the decisions of the Commission were reversed in 13. Four of these 13 involved but two issues, so that the Commission was actually reversed in only 11 instances as to issue presented on appeal. This means that the decisions of the Commission had been sustained in practically two-thirds of the appealed cases, and that the Commission had been reversed in less than 1/3 of 1% of the cases decided by it.

AMADOR COUNTY

The Plymouth Consolidated reports as follows for May:

| | |
|---------------------------|----------|
| Ore milled, tons | 11,780 |
| Total value | \$59,000 |
| Working expenses | 29,124 |
| Development charges | 6,929 |
| Surplus | \$22,947 |
| Other expenditure | \$ 2,787 |

BUTTE COUNTY

Old dredge and mill tailing on Butte creek, near Chico, between the Pacific Gold Dredging Co.'s land to the boundary of the United States Plant Introduction Gardens, an area of 326 acres, is being sampled for probable re-treatment. C. F. Helman, well known at Oroville, and O. W. Kay of Chico are making tests.

CALAVERAS COUNTY

At 1600 ft. in the Gold Cliff mine of the Utica company at Angels a narrow vein of very rich gold ore has been opened. Specimen ore is extracted freely.

ELDORADO COUNTY

San Francisco capital has been interested in a number of claims in the Greenwood district. Development is in progress at the Argonaut, Greenwood, Seam, Belt, Bunker Hill copper near Penobscot, and Cedarburg near Spanish Dry Diggings. The last named has been idle for 75 years.

ELYO COUNTY

(Special Correspondence.) A long, wide, and high-grade deposit of tungsten ore has been located 33 miles south-west of Mt. Montgomery, Nevada, by A. Stevens and G. McClelland. This part of the country is in one of the oldest mining districts of Nevada.

Laws, California, June 15.

SIERRA COUNTY

A consolidation of the Slate Creek, Sierra Union, Scales and Howards Flat, and other hydraulic mines near Downieville has been completed by a company headed by E. R. Ritchie of San Francisco. The properties were examined by Karl Brehme. To allow of staking being done, commission will have to be obtained from the Debris Commission.

SISKIYOU COUNTY

News from Gazelle states that the Davis gold mine is being sampled. F. Chastain and others are shipping chrome ore,



SISKIYOU COUNTY, CALIFORNIA.

and the Polar Bear has made a trial shipment of copper ore. A custom plant may be erected near Gazelle.

TUOLUMNE COUNTY

(Special Correspondence.)—All the new machinery has been installed at the McAlpine mine, which is in charge of W. A. Irwin, at one time at the Standard mine at Bodie and the Associated mine at Kalgoolie, Western Australia. Driving has been started from the 500-ft. level to get under the rich shoot worked years ago.

Coulterville, June 9.

COLORADO

CLEAR CREEK COUNTY

(Special Correspondence.)—The Mt. Colorado Mines Co. shipped 25 tons of concentrate running 49.75% zinc. Charles Lancaster is manager.

At the McClellan mine, a 6-in. vein is being opened, assaying 264 oz. silver and 6.75% copper.

The manager of the Josephine mine at Silver Plume, A. L. Stevens, shipped 60 tons of lead ore that netted \$4100. Twelve men are stopping.

Re-timbering of the Doric adit has been completed by the Onondaga Mines Co. The adit is now in a distance of 3909 ft. from its portal. The manager, Tallmadge Kyner, will probably drive ahead and let leases on some of the many lodes

already intersected. For this work a larger compressor and ventilating fan should be installed and perhaps the old plant changed from steam to electricity.

On the 100 ft. level of the Onondaga mine 4 ft. of ore is now being driven on and a carload is shipped to the Hudson mill at Idaho Springs each day.

The manager of the Capital mine, E. Bauman, is increasing production in both quantity and quality, the only hindrance to a much larger output being ventilation.

Georgetown, June 13.

LAKE COUNTY (LEAVELLE)

Routine work continues at the Harvard, Penrose, and Wolf-tone pumping shafts. The first is almost unwatered.

At the Mikado shaft on Iron Hill, 1296 ft. deep, and full of water to the 800-ft. level, extensive preparations are under way for drainage, re-timbering, and subsequent exploration. G. O. Argall of the Iron Silver company is in charge. A new 60 ft. head-frame is being constructed. A large hoist has been ordered, also pumps. The ground includes several well-known claims, and large bodies of lead-silver ore are expected to be opened.

From the Hugh lease in south Evans gulch the weekly output is 50 tons of \$20 gold ore.

IDAHO

Attention of Eastern investors is being turned to the acquisition and development of gold properties in central Idaho to an extent previously unknown in the region. Many of the camps were the scenes of some of the earliest gold rushes in the North-west, according to Henry Massam, pioneer mining operator, manager of the Idaho National company's placer holdings and the Mascot quartz mine, near Elk City. The entire central Idaho district is more active than for years, and a number of properties that have been idle and practically abandoned are to be developed. Small mills are being erected at different points in the Elk City-Newsome-Ten-Mile and other centres, and there is every reason to anticipate that the output this summer will establish a new high record.

IDAHO COUNTY

Four men operating a one-stamp (450 lb.) mill, which they dragged in over the snow last April, are extracting from \$40 to \$50 per day from the Lone Yellow Pine mine on Ten-Mile, 45 miles south and east of Stites. The property is owned by John Harmon and Doit Morrow. The battery is driven by an over-shot water-wheel. In the same district Smith brothers have 5 stamps on the New York claims. Last winter the yield was \$21,000. The Orient company is extracting \$7 per ton by amalgamation.

SHOSHONE COUNTY (COEUR D'ALENE)

Railroad connection between Wallace and the Beaver Creek district is considered necessary. The Ray-Jefferson and Interstate Callahan would then have a better outlet, also the entire Sunset region. The Northern Pacific line is expected to do something in the matter.

The west side of Nine Mile is one of possibilities judging by recent transactions and new development. On the east side are the Interstate-Callahan, Tamarack & Custer, Success, Rex, and Patuxent.

According to the *Wallace Miner*, leasing has come to be an important feature of mining operations in the Coeur d'Alene district. It was at first mostly limited to leasing old workings and to blocks of ground that could not be profitably mined by large operating companies, but which offered good pay to practical miners who devoted their own time to the work and who exercised more care in separating the ore from waste. Then there are small and rich veins which apparently did not justify a large expenditure for equipment, which have yielded handsome profits to practical miners under lease. Gradually the leasing system has been growing in popular favor, and in

the Wardner district particularly some valuable leases have been secured which yield large profits.

Reports are current at Kellogg that operations will soon begin on the 1200-ton mill for the Interstate-Callahan company on the site secured some months ago at Enaville.

Several parties are said to be considering a deal on the old Butler silver mine, near Wardner, and a resumption of operations may be expected at an early date. The property has been idle for 20 years.

During May the Interstate-Callahan company mined 12,801 tons of ore, which produced 540 tons of concentrate containing 54% lead, and 10,080 oz. silver, also 6146 tons of concentrate averaging 49.8% zinc. The mill recovery was 90.5%, and smelter returns were \$440,089. The three-compartment shaft from the main adit of the Interstate-Callahan workings was sunk 405 ft. in May, and connection has been made with the Amazon-Manhattan group adjoining, acquired several months ago by the company. The shaft will be sunk still farther, to connect with the 600-ft. adit of the Amazon-Manhattan, which is being advanced to meet it.

MICHIGAN

THE COPPER COUNTRY

Some of the tonnages of ore reported during May were as follows: Ahmeek, 110,000; Tamarack, 40,000; Wolverine, 41,000; Calumet & Hecla, 300,000; Quiney, 102,600; Wolverine, 31,100; Franklin, 24,000; Centennial, 14,000; Allouez, 47,200; La Salle, 12,500; Superior, 18,200; Mass, 31,200; and Hancock, 11,600 tons.

An editorial in a recent issue of the *Daily Mining Gazette*, Houghton, has the following:

"The equalization committee of the board of supervisors of Houghton county agreed last week to raise the valuation of the county approximately \$10,000,000. It means substantial increases in taxation. More than that, the committee, at the suggestion of the largest tax-paying interest in the county, decided that this additional valuation should be placed on the copper mines, so that the additional taxes will fall on the mining corporations and not on the other property owners in the county. It is fair and just and right. But did you ever hear of any board of supervisors in this whole State voluntarily agreeing to increase their own taxes? Increases usually come when they are forced by State officials. And did you ever hear of a board of supervisors' equalization committee practically placing a \$10,000,000 increase in valuation on the property which they themselves control and manage? It is a record in the history of politics in this State. And it is right in line with Houghton county's reputation for fairness. The facts are that the increase in valuation in this county has, in reality, come to the mining corporations. But it has, nevertheless, some effect on other property. Next year it will have a further effect on other property. But this action by the committee is entitled to commendation. It is, of course, the informal session of the committee. The figures on mine valuation have to be approved later at a formal session and then endorsed by the board of supervisors as a whole. But in the past these informal agreements on mine valuation always have stood up and the agreement at the equalization committee was unopposed."

MISSOURI

JASPER COUNTY (JOPLIN DISTRICT)

On June 19 rain amounting to 5.75 in. fell at Joplin, flooding the town and mines, stopping ore extraction for some days.

In the week ended June 11 the ore market remained firm. The Missouri-Kansas-Oklahoma region produced 6348 tons of blende, 129 tons of calamine, and 950 tons of lead, averaging \$77, \$55, and \$81 per ton, respectively. The total value was \$577,200; and for 23 weeks, \$18,792,175.

North-east of Webb City the Rollamo company has a tailing-plant treating dumps. About 1200 tons is treated in three

8-hour shifts, in two rougher, one chat, and one cleaner jig. In one day of 24 hours the mill produced 18 tons of concentrate, and in one week 90 tons. This product contains 57.6% zinc, 0.25% lead, and 1.2% iron. Ten sludge-tables are to be added. The motive power is a 150-hp. gas engine. The Millers and White of Joplin are owners.

MONTANA

BEAVERHEAD COUNTY

A small boom has started at Bannack due to renewed activity in old and new mines.

FERGUS COUNTY

During May the Barnes-King company's mines produced 3779 tons of \$7.41 and 2178 tons of \$4.59 ore, both increases compared with April. New construction continues.

MINERAL COUNTY

Crude copper ore, fine and jig concentrates (from its 100-ton mill) are averaging \$25, \$50, and \$75 per ton, respectively, from the Amador mine near Superior. The mine is opened to 700 ft., with good reserves. The mill commenced work in May. Oscar Nordquist is manager.

SILVERBOW COUNTY

All the Anaconda mines are working at full capacity, making the power-demand so heavy that at the High Ore steam hoisting has replaced compressed air, which is used at most of the mines. The High Ore is 3600 ft. deep, and is a large producer.

In the near future the Butte & Great Falls company is to sink another shaft to a depth of 1000 ft. The cross-cut being driven south from the shaft is in 575 ft. on its way to the Dewey vein. At 460 ft. the Genevieve vein was cut, showing 11 ft. of good copper-silver-gold ore.

At 1600 ft. in the Butte & London a large station is being cut. Some highly mineralized rock has been disclosed by this work.

Foundations are being prepared for the new hoist at the Davis-Daly.

The strike of various trades at Butte is over.

NEVADA

CHURCHILL COUNTY

At Wonder the Goldfield Oro company is to resume work at its Vulture mine, adjoining the Nevada Wonder. Exploration will start at 800 ft., in charge of T. F. Manning.

ESMERALDA COUNTY

During May the Jumbo Extension produced 2850 tons of ore worth \$91,500. Charges were \$17,500 for mining, \$32,250 for freight, sampling, and treatment, and \$10,500 smelting losses, leaving \$31,250 net. This profit is \$6000 above that in April, and \$10,000 in March. Shipments are now 150 tons daily. Some \$8 dump ore is being marketed.

Development at the Florence is improving, new ground at 650 ft. being of promise. Additions to the flotation plant will be ready by the end of June.

At the Silver Pick the shaft is being sunk rapidly from 700 to 1000 ft. depth.

In the Lida district, south-west of Goldfield, the Florida claims have been purchased by the Theo brothers of Goldfield for \$45,000. A flotation plant is to be erected to treat the ore and that from their mine at Hornsilver.

LYON COUNTY

(Special Correspondence.)—The leaching-plant of the Nevada-Douglas company at Ludwig has been placed in operation, treating 250 tons of ore daily. It is probable a larger quantity will be put through as the various units reach ca-

capacity. Fuel oil is used in the furnaces. The management recently announced that a large tonnage of good grade ore was available.

The Yerington Mountain company, operating near Schurz, is shipping 12 to 20 tons of copper ore per day. A cross-cut from the Levine vein has cut the vein, showing a width of 54 ft. Two feet of shipping ore is exposed in the intermediate level of the Beach workings. John G. Kirchen of Tonopah is general manager.

The Reservation Hill district continues to report progress. On the 200 ft. level of the Mountain View the vein is said to be over 30 ft. wide, with much of this of good milling grade. The mill is running steadily, using water from the Walker river. An option has been taken on the Pack Saddle group by Colorado people, and preparations are being made for extensive work.

Yerington, June 7.

NYE COUNTY

From March 9 to May 31 the Round Mountain hydraulic plant moved 106,600 cu. yd. of gravel, yielding \$40,000, with no clean-up of bedrock.

Ten mines at Tonopah last week produced 9337 tons of ore valued at \$186,126. During May the Belmont's yield was 229,351 oz. of bullion from 12,821 tons of ore, giving a profit of \$126,263. From 3153 tons the Jim Butler's profit was \$23,361. The Tonopah company treated 9239 tons for a profit of \$26,330. Only 125,000 oz. was shipped.

WHITE PINE COUNTY

(Special Correspondence).—It is announced by wire from action taken at recent annual meeting of the Consolidated Coppermines (old Giroux) Co. at Delaware, that it has been financed to the extent of \$100,000. The old mill at Pilot Knob will be overhauled to treat 500 tons per day, including flotation. Also arrangements have been made with the Nevada Consolidated to mine from the Coppermines Ore claim in Liberty pit 1000 tons daily, and treat it at the plant at McGill.

The Nevada Consolidated has under way a drilling campaign. During April 8500 ft. was drilled, which in some instances showed 1% copper ore. It is understood that there is 500 ft. depth of ore in the bottom of Eureka pit, as shown by drill-holes. The general public appears to think that the Nevada Consolidated is a surface deposit only.

Tungsten activity has somewhat subsided owing to the drop in price and no market. The U. S. Tungsten Co. has reduced its mill to one shift for want of ore. It has a contract at \$72.50 per unit. Much ore of commercial grade could be purchased, helping themselves and the prospector.—The Independent mill was started and made a short run, but has not sufficient power for the crusher and elevators.—The Consolidated Tungsten Co. adjoining the U. S. T. Co. on the south has its mill running.—The Nevada Scheelite Co. (Minerva district) has a small plant in operation for sampling purposes.

Ely, June 10.

High-grade zinc ore has been found by the Lead King company in the Dock Creek district, 20 miles east of McGill. A good deal of development has been done.

OKLAHOMA

OTTAWA CO.

For the sum of \$125,000 the U. S. Smelting Co. has purchased 60 acres of land from B. H. Marbury, north of Cardin. The lease calls for a 6% royalty to be paid to the Indian land-owners. A mill at the Ravenswood mine at Reeds, Missouri, will be moved to the new property.

UTAH

There is a cessation of ore at the starters in this State, and temporary curtailment of production has been notified to companies, especially lead-silver producers.

The Utah Ore Sampling Co. is to erect another plant at Murray. At present 500 tons daily is handled. This company has samplers at full capacity at Park City and Silver City.

UTAH COUNTY

During May the Iron Blossom earned \$40,000. The copper ore mined at 1100 ft. is expected to be cut at 1700 feet.

SALT LAKE COUNTY

High grade ore, 10 ft. wide, has been cut at 2100 ft. in the Quincy adit of the South Hecla in the Little Cottonwood district.

WASHINGTON

FLYNN COUNTY

Plans are under consideration by the Northwestern Development Co., a recently organized Spokane corporation, to convert the old smelter at Keller into an electro-chemical plant for the treatment of ores of the Keller-Nespelem region. The smelter was built seven years ago, when it was anticipated that the Colville Indian reservation would be opened and a railway constructed into the district, but the furnaces never have been blown-in. The plant, including the electric-power station, cost \$250,000, and it is said to be in excellent condition still, having been well cared for. It is provided with facilities for treating 100 tons of copper ore and 50 tons of lead ore daily. The property was taken over several months ago by the Northwestern company, which at the same time acquired the Manila and Rebecca groups of copper-lead-silver claims near-by. If the plant is operated as suggested, it will necessitate changes in the equipment that will cost not less than \$70,000, but it will obviate the shipment into the camp of expensive coke. There are plenty of good properties to supply a smelter in that locality. The Iron Creek Mining Co. is hauling ore 56 miles to Republic, and shipping it to the smelters. This ore contains 600 oz. silver and 16% lead. The Walla Walla Copper Co. is working three shifts, and has a large body of high-grade copper ore. The Summit mine has ore in considerable quantities. The Manila has as large a body of copper ore, and only needs transportation facilities. It is 435 ft. wide, as shown by diamond-drill prospecting, and carries 1.83% copper. William E. Malm is one of the chief stockholders and manager, with William E. Johnson as superintendent.

WYOMING

The State Geological Survey at Cheyenne, L. W. Trumbull in charge, has issued a new map of the State. It is 35 by 46 in., and shows contours and important centres. The map is for sale at \$1.

Production of coal in Wyoming in 1915 was 6,554,628 short tons, an increase of 78,735 tons, or more than 1% as compared with 1914, according to figures compiled by C. E. Lesher, of the U. S. Geological Survey. The total value decreased nearly 5% from \$10,933,747 in 1914 to \$9,555,861 in 1915. The number of men employed in the coal mines decreased from 8117 in 1914 to 7241 in 1915, but the average number of days worked increased from 192 to 201.

CANADA

BRITISH COLUMBIA

Some attention has been attracted to the Blue Bell peninsula on the east side of Kootenay lake, almost opposite Ainsworth, by the recent opening of a large surface showing of galena on the Comfort claim owned by A. D. Wheeler of Ainsworth. Hudson Bay trappers, 60 years ago, made bullets from this lead ore.

According to Ernest Levy, manager of the Le Roi No. 2 mine at Rossland (which is primarily a gold district), the cost of explosives and other supplies are high, a 30 to 50% advance, and wages are up 16%, the whole making conditions undesirable, as there are no benefits from high prices for the product.

ONTARIO

The Nipissing in May produced silver worth \$291,898, against \$124,452 in April. Bullion shipments, including custom ore, totaled \$420,822, equal to 558,148 oz. Vein 490 contributed largely. Shaft No. 81, to explore the Cobalt Lake vein, is down 550 feet.

The 150-ton flotation annex is working well at the McKinley-Darragh. It treats tailing from the tables.

The Dome in May produced 39,400 tons of ore averaging \$4.79 gold per ton. The cost was \$2.46 per ton. The grade is 55c. higher, and cost an increase of 15 cents.

MEXICO

On account of probable trouble between Mexico and the United States, American employees are leaving Cananea and Nacozari. Those at El Tigre are not coming out yet.

Mining in Warfare

A metallurgist, well known in San Francisco, and now an officer in the engineering corps of the Italian army, writes as follows to a friend in California:

"The job is done. On the 12th of January I started drifting toward the enemy's lines on top of the Col di Lana, at 2464 metres above sea-level. It was a long drive of over 300 ft. At the beginning of April we were under their lines; the enemy found us out and began to counter-mine. On the 7th the enemy shot its first counter-mine; an officer and five men were buried by a cave, but nobody was seriously hurt. Half an hour after we were again at work, blasting six rounds per day without stopping work day or night. The enemy went again after us, nicking three shafts, and driving right and left. On the 9th I stopped all work and the enemy kept working as hard as he could. One drift was right over our heads, and we could hear the Austrians walk and the rock tremble under the blows of the pick. We kept perfect silence, waiting until the infantry should be ready. On the night of the 15th the enemy was so close that I decided not to delay further. From 10 p.m. to 7 a.m. we loaded 10,040 pounds of gelatine and 92% nitro-glycerine. By noon of the 17th the mines were tamped.

"At 11:35 p.m. of April 17 everybody moved silently to his appointed place; the trenches were deserted. We officer-engineers sat on the floor of a gallery, our hands on the ropes of the little generator. At the very second appointed we pulled. The earth trembled as with an earthquake, but the explosion was not very loud. After two or three seconds came the shower, or rather, heavenly earth-slide; some 15,000 tons of rock and earth, burying everything under itself, even our own trenches, and almost our galleries.

"The moon was at full. The sky was clear. At the instant of the explosion, all the batteries on the mountain around us opened an infernal fire on the top of the mountain. It was an incredibly fantastic sight.

"The Italian 'tommies' poured out from the galleries and stormed the top 300 ft. distant. The famous Col di Lana was ours at last! I waved the flag on the very top, and all the soldiers with me shouted "Viva l'Italia." At my feet was the crater, some 90 by 150 ft. in oval, and about 35 ft. deep. Everything broken, scattered, mashed, and destroyed. The wire entanglement was buried under thousands of tons of rock. Some 80 Austrians were blown out of existence; we captured 170 prisoners, 9 officers, one gun, etc. The victory was ours."

The UNIVERSITY OF NEVADA at Reno has issued its catalogue for 1915-'16, with announcements for 1916-'17. The publication covers 254 pages, and disusses all phases of the college activities. Lectures for the new semester commence on August 30.

PERSONAL

Note: The Editor invites members of the profession to send particulars of their work and appointments. This information is interesting to our readers.

ROBERT T. HILL is at Washington.

PAUL W. AVEY is here from El Oro.

C. E. RHODES has left El Oro and is now at Los Angeles.

S. S. LANGLEY, of Los Angeles, was here during the week.

BENJAMIN GONZALEZ sailed on the *Colusa* on June 15 for Salvador.

VICTOR G. HILLS, of Denver, sailed from here to Honolulu on June 21.

ARTHUR W. STEVENS was recently at Idaho Springs, Colorado, and is now in Utah.

WILBUR H. GRANT has been examining copper mines in Humboldt county, California.

HENRY KRUMB, who has been inspecting the Braden mine in Chile, has returned to New York.

C. H. MACNUTT, manager for the Burma Mines Co., is at the Fairmont hotel. He has resigned.

W. G. MATTESON is doing geological work for the Empire Gas & Fuel Co. of Bartlesville, Oklahoma.

ROBERT E. CRANSTON is examining the Lucky Girl mine in the Edgemont district, near Elko, Nevada.

ROY A. SULLIGER has been appointed mill superintendent of the Minas del Tajo, Rosario, Sinaloa, Mexico.

EDMUND SHAW, until recently metallurgist at the La Leonesa mine in Nicaragua, has returned to El Paso, Texas.

C. T. SOKUP has left the Canadian Copper Co. to take a position with the American Smelting & Refining Co. at Kansas City.

RICHARD C. MCINTYRE has received an appointment on the staff of the Burma Mines, and sails from San Francisco to Rangoon early in July.

COREY C. BRAYTON and E. R. RICHARDS have opened offices in the Hobart building, San Francisco, to conduct the business of mining and metallurgical engineering.

F. W. TRAPHAGEN, professor of metallurgy in the Colorado School of Mines, has resigned to accept the presidency of the Colorado Metal Mining & Reduction Company.

J. A. FORCE, who has been in charge of operations for the Consolidated Mines & Reduction Co. at Cripple Creek, has resigned. He intends to devote his time to private practice.

THE EDITOR will be grateful for occasional good photographs of subjects relating to mining and metallurgical operations. They should be printed on glossy paper.

The 19th annual session of the American Mining Congress will be held at the LaSalle Hotel, Chicago, Illinois, during the week of November 13.

At the Commencement of the University of Illinois on June 14, 222 baccalaureate degrees were granted to students of the College of Engineering, of which 39 were civil, 43 electrical, 44 mechanical, and 3 mining engineers.

The U. S. Civil Service Commission announces an open competitive examination for coal-mining engineer, for the Bureau of Mines at a salary ranging from \$2400 to \$1000 per annum. Applications must be filed with the Commission at Washington, D. C., by July 18. There will also be an examination for assistant petroleum engineer for the Bureau of Mines, at a salary ranging from \$1800 to \$2500 per annum. Applications must be filed by July 18.

THE METAL MARKET

METAL PRICES

San Francisco, June 20

| | |
|---|-------------|
| Antimony, 50-lb. product, per unit (10 or 20 lb.) | 37.50 |
| Electrolytic copper, cents per pound | 31 |
| Raw lead, 48-lb. per pound | 7.25 - 8.25 |
| Platinum, soft metal, per ounce | 75 |
| Platinum, hard metal, 10% iridium, per ounce | \$72 |
| Quicksilver, per flask of 7 1/2 lb. | \$68 |
| Spelter, cents per pound | 21 |
| Tin, cents per pound | 15 |
| Zinc, cast, cents per pound | 30 |

ORE PRICES

San Francisco, June 20

| | |
|--|---------------|
| Antimony, 50-lb. product, per unit (10 or 20 lb.) | \$1.25 |
| Chromite, 40% and over, 100 lbs. California, per ton | 12.00 - 11.00 |
| Manganese, 50% product, 600 cars California, ton | 20.00 |
| Magnetite, grade, per ton | 7.00 - 10.00 |
| Tungsten, 60% WO ₃ , per unit | 30.00 - 40.00 |

The tungsten situation at Bonanza, Colorado, is unchanged. The output of the U. S. Geological Survey has been issued. The output last year was 1,024 tons worth \$5.58 per ton. Bauxite, aluminum ore, production of the United States in 1915 was 2,074,417 tons, average \$5.14 per ton.

New York, June 14

Antimony. Prompt delivery ore has sold at \$2.50 per unit, if the demand is light. Tungsten. A broker quotes \$12 to \$16 for material running all over, while a buyer says that as low as \$30 has been bid recently. The buyer does not look for much higher prices, his opinion being that production has been overdone. There is longer is seen. Granite buying of high-speed steel as existed a few months ago, and this has caused the demand for ferro-tungsten. It is noted that some foreign inquiry for tungsten with material, but in this connection it is to be remembered that England is forging ahead in the manufacture of ferro-tungsten as regards iron from Burma and Portugal. The material is being quoted lower in England than in the United States.

EASTERN METAL MARKET

(By wire from New York.)

Copper is dull and weak, lead is quiet though steady, spelter is stagnant.

SILVER

Below at given the average New York quotations, in cents per ounce of the silver.

| Date | Average week ending | | | | | |
|------------------|---------------------|--------|--------|--------|--------|---------|
| June 14 | May 9 | May 16 | May 23 | May 30 | June 6 | June 13 |
| 15 | 75.89 | 76.40 | 76.91 | 77.42 | 77.93 | 78.44 |
| 16 | 78.45 | 78.96 | 79.47 | 79.98 | 80.49 | 81.00 |
| 17 | 81.51 | 82.02 | 82.53 | 83.04 | 83.55 | 84.06 |
| 18 Sunday | 84.57 | 85.08 | 85.59 | 86.10 | 86.61 | 87.12 |
| 19 | 87.63 | 88.14 | 88.65 | 89.16 | 89.67 | 90.18 |
| 20 | 90.69 | 91.20 | 91.71 | 92.22 | 92.73 | 93.24 |
| Monthly averages | | | | | | |
| Jan. | 1914 | 1915 | 1916 | 1914 | 1915 | 1916 |
| Feb. | 35.58 | 48.85 | 56.56 | 51.00 | 47.52 | 45.00 |
| Mar. | 37.57 | 48.45 | 56.74 | 51.35 | 47.11 | 44.00 |
| Apr. | 38.00 | 50.61 | 57.80 | 52.75 | 48.77 | 45.00 |
| May | 38.52 | 50.25 | 61.37 | 51.12 | 49.10 | 45.00 |
| June | 38.00 | 49.87 | 74.27 | 49.12 | 51.88 | 45.00 |
| July | 36.43 | 49.03 | 61.11 | 49.25 | 53.34 | 45.00 |

The current week has witnessed a rise in silver, but nothing termed violent, the tendency upward. Samuel Montagu & Co. of London say that it is impossible to overlook the fact that the statistical position of the metal is extremely strong—the amount of the nominal stock of metal available for sale is but a small fraction of the total. There is no reason to believe that the selling of silver will be taken place in America at any rate to any important extent. The heavy expenses of freight and insurance tend to prevent, if not to deter, exports from India.

Silver reserves of the Tonopah Belmont, May 1 amounted to 1,150,000 oz. Recent sales were 100,000, 175,000 and 200,000 oz. at 76c. A 12 1/2% dividend has been declared.

COPPER

Prices of electrolytic in New York, in cents per pound.

| Date | Average week ending | | | | | |
|------------------|---------------------|--------|--------|--------|--------|---------|
| June 14 | May 9 | May 16 | May 23 | May 30 | June 6 | June 13 |
| 15 | 27.75 | 27.50 | 27.25 | 27.00 | 26.75 | 26.50 |
| 16 | 26.75 | 26.50 | 26.25 | 26.00 | 25.75 | 25.50 |
| 17 | 25.50 | 25.25 | 25.00 | 24.75 | 24.50 | 24.25 |
| 18 Sunday | 24.25 | 24.00 | 23.75 | 23.50 | 23.25 | 23.00 |
| 19 | 23.00 | 22.75 | 22.50 | 22.25 | 22.00 | 21.75 |
| 20 | 21.75 | 21.50 | 21.25 | 21.00 | 20.75 | 20.50 |
| Monthly averages | | | | | | |
| Jan. | 1914 | 1915 | 1916 | 1914 | 1915 | 1916 |
| Feb. | 11.21 | 13.60 | 21.30 | 13.26 | 19.09 | 27.00 |
| Mar. | 11.46 | 14.38 | 26.62 | 12.34 | 17.27 | 25.00 |
| Apr. | 14.11 | 14.80 | 26.65 | 12.02 | 17.69 | 25.00 |
| May | 14.19 | 16.64 | 28.92 | 11.10 | 17.90 | 25.00 |
| June | 13.97 | 18.71 | 29.02 | 11.75 | 18.88 | 25.00 |
| July | 13.60 | 19.75 | 29.00 | 12.75 | 20.67 | 25.00 |

Uchi Copper in May produced 15,901,000 lb., a record, and 1,400,000 lb. above April.

Kennecott, Alaska, has sold its possible output for this year at prices assuring well over \$6 per share in dividends.

LEAD

Lead is quoted in cents per pound, New York delivery.

| Date | Average week ending | | | | | |
|------------------|---------------------|--------|--------|--------|--------|---------|
| June 14 | May 9 | May 16 | May 23 | May 30 | June 6 | June 13 |
| 15 | 6.55 | 6.80 | 6.75 | 6.75 | 6.75 | 6.75 |
| 16 | 6.80 | 6.75 | 6.75 | 6.75 | 6.75 | 6.75 |
| 17 | 6.75 | 6.75 | 6.75 | 6.75 | 6.75 | 6.75 |
| 18 Sunday | 6.75 | 6.75 | 6.75 | 6.75 | 6.75 | 6.75 |
| 19 | 6.75 | 6.75 | 6.75 | 6.75 | 6.75 | 6.75 |
| 20 | 6.75 | 6.75 | 6.75 | 6.75 | 6.75 | 6.75 |
| Monthly averages | | | | | | |
| Jan. | 1914 | 1915 | 1916 | 1914 | 1915 | 1916 |
| Feb. | 4.11 | 3.73 | 5.95 | 3.80 | 5.59 | 6.00 |
| Mar. | 4.02 | 3.82 | 6.23 | 3.86 | 4.67 | 5.00 |
| Apr. | 3.94 | 4.04 | 7.26 | 3.82 | 4.62 | 5.00 |
| May | 3.86 | 4.21 | 7.10 | 3.66 | 4.62 | 5.00 |
| June | 3.90 | 4.21 | 7.38 | 3.68 | 5.15 | 5.00 |
| July | 3.90 | 5.75 | 6.00 | 3.80 | 5.34 | 5.00 |

QUICKSILVER

The primary market for quicksilver is San Francisco, California being the largest producer. The price is fixed in the open market, according to quantity. Prices, in dollars per flask of 7 1/2 pounds:

| Date | Week ending | | | | | |
|------------------|-------------|---------|---------|---------|--------|---------|
| June 14 | June 6 | June 13 | June 20 | June 27 | July 4 | July 11 |
| 72.50 | 68.00 | 68.00 | 68.00 | 68.00 | 68.00 | 68.00 |
| Monthly averages | | | | | | |
| Jan. | 1914 | 1915 | 1916 | 1914 | 1915 | 1916 |
| Feb. | 39.25 | 51.90 | 222.00 | 37.50 | 95.00 | 100.00 |
| Mar. | 39.00 | 60.00 | 295.00 | 38.00 | 93.75 | 100.00 |
| Apr. | 39.00 | 78.00 | 219.00 | 38.25 | 91.00 | 100.00 |
| May | 38.90 | 77.50 | 141.60 | 36.00 | 92.90 | 100.00 |
| June | 39.00 | 75.00 | 90.00 | 35.00 | 101.50 | 100.00 |
| July | 38.60 | 90.00 | 100.00 | 35.10 | 122.60 | 100.00 |

The quicksilver market is reported to be firmer.

ZINC

Zinc is quoted as spelter, standard Western brands, New York delivery, in cents per pound.

| Date | Average week ending | | | | | |
|------------------|---------------------|--------|--------|--------|--------|---------|
| June 14 | May 9 | May 16 | May 23 | May 30 | June 6 | June 13 |
| 15 | 13.50 | 13.25 | 13.25 | 13.00 | 12.75 | 12.50 |
| 16 | 13.25 | 13.00 | 12.75 | 12.50 | 12.25 | 12.00 |
| 17 | 12.75 | 12.50 | 12.25 | 12.00 | 11.75 | 11.50 |
| 18 Sunday | 11.50 | 11.25 | 11.00 | 10.75 | 10.50 | 10.25 |
| 19 | 10.25 | 10.00 | 9.75 | 9.50 | 9.25 | 9.00 |
| 20 | 9.00 | 8.75 | 8.50 | 8.25 | 8.00 | 7.75 |
| Monthly averages | | | | | | |
| Jan. | 1914 | 1915 | 1916 | 1914 | 1915 | 1916 |
| Feb. | 5.14 | 6.30 | 18.21 | 4.75 | 20.51 | 25.00 |
| Mar. | 5.22 | 6.05 | 19.00 | 4.75 | 14.17 | 20.00 |
| Apr. | 5.12 | 8.10 | 18.40 | 5.16 | 14.11 | 20.00 |
| May | 4.98 | 9.78 | 18.62 | 4.75 | 14.05 | 20.00 |
| June | 4.91 | 17.02 | 16.01 | 5.01 | 17.20 | 20.00 |
| July | 4.84 | 22.20 | 16.00 | 5.10 | 16.75 | 20.00 |

TIN

Prices in New York, in cents per pound.

| Date | Monthly averages | | | | | |
|------|------------------|-------|-------|-------|-------|-------|
| Jan. | 1914 | 1915 | 1916 | 1914 | 1915 | 1916 |
| Feb. | 37.85 | 34.40 | 41.75 | 31.60 | 37.38 | 40.00 |
| Mar. | 39.76 | 37.23 | 42.60 | 30.20 | 34.37 | 40.00 |
| Apr. | 38.10 | 48.75 | 59.50 | 33.10 | 33.12 | 40.00 |
| May | 36.10 | 48.25 | 51.40 | 30.40 | 33.00 | 40.00 |
| June | 32.20 | 39.28 | 49.10 | 33.51 | 39.50 | 40.00 |
| July | 30.72 | 40.26 | 40.00 | 32.60 | 38.71 | 40.00 |

Eastern Metal Market

New York, June 14.

What is the matter with the metal market? This is an inquiry heard on many sides. Briefly, there has been a reaction, in some cases, violent, in every metal with the exception of aluminum.

As bearing on the question, two or three points may be made. One is that the warring nations are buying more carefully and skillfully than they did a few months ago, when the cry was, give us the stuff, whatever the price. Today the suspicion exists that Great Britain is in various ways endeavoring to depress American prices in order to make her purchases more favorable to her interests. This seems to be true particularly of brass and copper-finished products, such as rods, sheets, and billets. Foreign buyers have spurned American bids in some cases, on the ground that they can buy cheaper at home.

Another point is that domestic consumers are not only cautious in their buying, but are being urged by at least one large mill to exercise still greater conservatism in buying for the future. They are told that orders cannot be cancelled; that the end of the War will bring lower prices, and that the mill in question prefers small orders sufficient to meet current demands. This attitude on the part of a mill may seem odd, but it actually exists.

Copper, zinc, lead, and tin are dull, and lower in price. Antimony is demoralized. It seems that a re-adjustment of prices is under way. But even if this is true, and lower prices are to prevail, they will unquestionably be above normal, and big profits will continue to be made.

COPPER

The market has continued dull, with scarcely enough doing to test prices. The producers are booking little or no business, and second-hands are having things their own way. That the producers are well sold-up has been repeatedly stated. For the forward positions (from September on) their quotations are understood to range from 29 to 29.75c. There is plenty of re-sale copper to be had, however, this side of September, in fact, near-by deliveries of electrolytic are procurable at 27.75 to 28c., cash, New York, and small quantities probably could be picked-up lower. The demand is so light that all quotations are nominal. Lake is nominally quoted at about 28c., but the demand for it is light also. Rumors that London was contemplating some good buying have been current, but they are unsubstantiated. The London market is quiet at £141. The feeling is widespread that the general dullness of the market can be attributed in part to Great Britain's desire to depress prices for her own benefit. A statement of this kind is difficult, if not impossible to prove, but some facts stand out strongly. It is admitted by members of the trade that the day is past when England will pay premium prices for copper or brass and copper products if she can avoid it. In several cases where quotations have been submitted on brass rods and billets, on copper sheets and other finished products, the answer has come that the intending buyers could do better at home. One house, on this ground sought to cancel an order for 15,000 tons of copper sheets; another said it could save 5c. per pound on brass billets by buying at home. It is conceded that before business in these products can reach larger proportions, the London prices must be met. The mills are so well filled with orders that so far they have declined to do this. The condition is not conducive to extending the export business. On the other hand, domestic manufacturers continue their policy to buy sparingly, or only to cover new contracts. In some cases where they have sought to buy ahead, certain mills have

emphatically stated that any orders they might take would not be subject to cancellation; they also pointed out that prices would collapse with the end of the War, and that consumers might well proceed cautiously in providing for their future needs. Exports of ingot copper, June 1 to 14, totaled 14,057 tons.

ZINC

Some doubt was expressed a week ago as to whether the improvement then noted would hold. Since then the bottom has dropped out of the market. Quotations are again on the down-grade and yesterday near-by metal could have been had easily at 14.50c., New York, or 11.25c., St. Louis. July is quoted at about 13c., St. Louis, September at 12c., and October at 11.50c. It is certain that, though the recent movement was a short one, a large amount of zinc was contracted for, not a little of it by galvanizers. The London market is weak, and yesterday it declined £2 to £68 for prompt. The drop abroad was a further depressing influence on this market, and made sellers all the more anxious to move their holdings. Not since last October has the London price been so low. Exports, June 1 to 14, totaled 2065 tons.

Sheet-zinc has been reduced to 20c., f.o.b. mill, carload lots.

LEAD

The common story applies to lead—a weak, sagging market, with outsiders making the low price. The A. S. & R. Co. continues to quote 7c., New York, and 6.92½c., St. Louis, as prices at which it will sell (not merely bases for averages), but the Independents are quoting down to 6.85c., New York, and there is little doubt about their willingness to accept 6.80c., New York. The London quotation is off a few points, and stood yesterday at £31 5s. Exports June 1 to 14 totaled 1152 tons. Features of interest are lacking.

TIN

No interest on the part of consumers, and lower prices, sums up the situation. Not only has there been no business worthy of note, but each concession designed to arouse the buyer has only made him more shy. It now develops that there was very little real need for the alarm felt over the question of obtaining British shipping licenses. For months the market has been supported by reports that Great Britain was likely to halt the issuance of licenses, thereby creating a shortage of tin in this country. Not only has such action not been taken, but Banca tin, acceptable for many purposes has been coming here freely. It is not subject to any license restrictions, and has been selling at ¼ to 1c. below the price of Straits tin. While its use is broader than formerly, the tin-plate manufacturers stick to the use of Straits. The A. S. & R. Co. is distributing moderate-sized lots of the tin it refines from Bolivian ores, and it is good-looking stuff. Spot Straits tin was quoted yesterday at 43.25c. at New York. Arrivals this month total 2510 tons, and there is afloat 3102 tons.

ANTIMONY

Whereas Chinese and Japanese grades were quoted a few months ago at 45c., they are now to be had at 20c., duty paid. One seller asserts that it would be wrong to say that there is any market at all, and others agree with him. One theory for the absence of demand is that antimony is no longer called for as a hardener in shrapnel bullets, the making of shrapnel having given way to the manufacture of high-explosive shells. There probably is some truth in this statement, but it does not entirely explain the situation.

Price of Scrap Metals

A wide range of prices is being quoted for all scrap metals at New York, the market being largely a matter of individual outlet, which is of a routine character, according to the *Daily Metal Reporter*. The divergence of views as to new copper prices that exist between producers and some of the second-hands, is reflected in the market for copper scrap, and there is a correspondingly wide latitude between ideas of scrap-metal specialists on copper. The downward revision in lead values is discernible in a marginal reduction in heavy scrap-lead. Uncertainty in the spelter situation makes for an easier tone in scrap and new zinc. Some prices are as follows in cents per pound:

| | |
|-------------------------------|-------------|
| Crucible copper | 22.50 |
| Heavy copper and wire | 22.00— |
| Light copper | 19.00— |
| Heavy yellow brass | 12.50—13.00 |
| Clean light brass | 10½— 11 |
| New brass clippings | 15 — 15½ |
| No. 1 composition turnings | 17 — |
| No. 1 composition turnings | 15 — 15½ |
| Yellow brass turnings | 12½— 13 |
| Red car boxes | 11½— 15½ |
| Cocks and faucets | 15 — |
| Heavy lead | 5½— |
| Tea-lead | 4½— 4¾ |
| Scrap-zinc | 9 — 9½ |
| New zinc-chips | 10 — 10½ |
| No. 1 pewter (nominal) | 30 — |
| Siphon tops (nominal) | 28 — 29 |
| Block tin pipe (nominal) | 38 — 40 |
| Tin-foil (nominal) | 26 — 27 |
| Solder joints (nominal) | 9 — |
| Cast aluminum | 35 — 36 |
| New aluminum clippings | 47 — 50 |
| Aluminum borings and turnings | 22 — 23 |
| Electrotype (nominal) | 5 — 5½ |
| Stereotype (nominal) | 7½— 8 |

Copper and the Decline in Metals

From its recent high price of 30½ cents per lb., electrolytic copper has receded 3c. to 27½c. for immediate delivery metal, or 10%. The copper shares with inexplicable timidity have failed to sell on a basis fully warranted by even 17-c. metal, and have fallen away a little over 6% from their best quotations, according to the *Boston News Bureau*.

The drop in all the major metals—pig-iron alone excepted—has greatly exceeded the reaction in copper, and yet their shares have in some instances responded not by a sympathetic decline, but by new high record figures.

The average selling price of electrolytic copper over the past 10 years has been 15c. per lb., a figure which has permitted a 50% manufacturing profit over the average cost (plus depreciation) of say 10c. per lb. In a great many cases, notably where there is a definitely determined tonnage of ore, the present stock-market valuations would be entirely justified with copper at only 13c. For instance it is calculated that on 13-c. metal Inspiration could mine its known ore-bodies for 20 years, and return the investor at \$45 per share all the money he had put into it, plus 6% interest, in the meanwhile. With copper averaged at 15c. the value of Inspiration jumps to \$63.

Just why 'coppers' have never responded to the sensations of a 30-c. metal market is a complete mystery, unless the market leaders themselves under-estimated the war demand for copper and sold out their stocks when the metal reached 20c. If they are trying to get them back they have met with indifferent success. The public won't buy and won't sell!

In the case of spelter, the price of prime Western has been cut in halves from the top notch of 26½c., made in June, 1915, but spelter shares represented by a composite average of Butte & Superior and American Zinc have receded only 10%. From the high of the year prime Western is off 36%.

It is clear therefore that the copper shares, measured by the past, present, and future of the industry are in wonderfully strong position, and values must ultimately count.

Herewith are some interesting figures showing to what extent leading metals are off from their best prices of this year, all reduced to a per pound basis:

| | High 1916 | Present price | Decline | Decline % |
|--------------------|--------------|------------------|----------|--------------|
| Gold | \$248.04 | \$248.04 | | ... |
| Pig-iron | 0.0092 | 0.0090 | \$0.0002 | 2.7 |
| Aluminum | 0.63 | 0.58 | 0.05 | 7.9 |
| Copper | 0.30½ | 0.27½ | 0.03 | 10.0 |
| Silver | 8.90 | 7.53 | 1.37 | 18.7 |
| Lead | 0.08½ | 0.067 | 1.75 | 20.0 |
| Tin | 0.57 | 0.44½ | 0.12½ | 21.5 |
| Spelter | 21.17 | 0.13½ | 7.67 | 36.3 |
| Quicksilver | 4.00 | 1.00 | 3.00 | 75.0 |
| Average of 20 cop- | | | | |
| per stocks | 60.96 | 56.96 | 4.00 | 6.5 |
| Zinc stocks* | 101.43 | 90.05 | 10.93 | 10.7 |

*Composite of Butte & Superior and American Zinc.

Copper Dividends

The following table of quarterly dividend payments pictures in a graphic way how the copper shareholders' income has been increasing during the past 12 months, according to the *Boston News Bureau*:

| | 1916 | | 1915 | |
|---------------------|----------------|----------------|----------------|----------------|
| | 2nd quarter | 1st quarter | 2nd quarter | 1st quarter |
| Almeek | \$3.00 | \$3.00 | \$2.50 | \$0.75 |
| Allouez | 2.00 | 1.50 | | |
| Anaconda | | 1.50 | 1.00 | 0.50 |
| Calumet & Arizona | 2.00 | 2.00 | 0.50 | 0.50 |
| Calumet & Hecla | 15.00 | 15.00 | 15.00 | 5.00 |
| Chino | 2.25 | 1.25 | 0.50 | 0.50 |
| Copper Range | 2.50 | 1.50 | | |
| Granby | | 1.50 | | |
| Greene-Cananea | 2.00 | 1.00 | | |
| Inspiration | | 1.25 | | |
| Kennecott | 1.50 | 1.00 | | |
| *Mohawk | | 7.00 | | 1.00 |
| Nevada Consolidated | 0.75 | 0.50 | 0.25 | 0.25 |
| North Butte | | 0.50 | 0.40 | |
| Old Dominion | 3.00 | 2.50 | 1.00 | 0.50 |
| Osceola | | 1.00 | 3.00 | 2.00 |
| Quincy | 4.00 | 3.00 | 2.00 | 1.00 |
| Ray | 0.50 | 0.50 | 0.37½ | |
| Shattuck-Arizona | | 1.25 | 0.50 | 0.50 |
| Tennessee | | 0.75 | 0.75 | 0.75 |
| U. S. Smelting | | 1.00 | | |
| Utah Copper | 3.60 | 2.50 | 1.00 | 0.75 |
| *Wolverine | | 6.00 | | 4.00 |

*Pays dividends semi-annually.

In spite of the fact that the metallic aluminum consumed in the United States in 1915 amounted to 99,806,000 lb., there was a great scarcity of the metal in this country, especially during the later part of the year, according to information gathered by W. C. Phalen, of the Geological Survey. A greatly increased demand, together with the curtailment of imports, were the chief causes of this scarcity. Applications of the metal have been many in the War in Europe.

COMPANY REPORTS

ALASKA MEXICAN GOLD MINING CO.
ALASKA TREADWELL GOLD MINING CO.
ALASKA UNITED GOLD MINING CO.

These three well-known companies, operating on Douglas island opposite Juneau in Alaska, are under the general superintendency of P. R. Bradley, and their reports for the year ended December 31, 1915, will be read with extra interest on account of the consolidation now under way. The best way to show the past year's results is by the following table:

| Items of operation | Mexican | Treadwell | United | |
|--|-----------|-------------|---------------|--------------|
| | | | Ready Bullion | 700-Ft. Mine |
| Men employed | 121 | 718 | 276 | 276 |
| Average wage per day.. | \$3.36 | \$3.61 | \$3.46 | |
| Development in own mine, feet | 2,153 | 7,284 | 1,865 | |
| Development in 700-Ft. Mine, feet | 354 | 14 | | 5,197 |
| Central development and shaft, feet | *3,054 | *3,054 | | *3,054 |
| Combination development and shaft, feet..... | *642 | *642 | | *642 |
| Diamond-drilling, feet.. | 158 | 171 | | |
| Work at No. 2 shaft, feet | | | 4,551 | |
| Underground cost, per ton | \$0.85 | \$0.7804 | \$0.8905 | \$0.9042 |
| Mine samples, number.. | 2,027 | 4,264 | 1,810 | 2,415 |
| Average value per ton.. | \$2.04 | \$2.21 | \$3.43 | \$2.48 |
| Reserves in place, tons. | 965,024 | 6,611,571 | 2,288,590 | 4,801,333 |
| Reserves broken in stopes, tons | 223,842 | 401,184 | 294,515 | 92,575 |
| Total reserves, tons.. | 1,188,866 | 7,012,755 | 2,583,105 | 4,893,908 |
| Average value per ton.. | \$1.87 | \$2.28 | \$2.86 | \$1.75 |
| Reserves in previous year, tons | 688,738 | 7,159,253 | 2,144,062 | 2,542,477 |
| Average value per ton.. | \$2.68 | \$2.48 | \$2.85 | \$2.22 |
| Stamps dropping | 120 | 540 | 150 | 150 |
| Duty per stamp-day, tons | 5.24 | 4.8 | 5.64 | 5.25 |
| Ore crushed, tons..... | 216,428 | 900,211 | 252,154 | 283,514 |
| Gold by amalgamation. | \$190,980 | \$936,092 | \$272,274 | \$263,319 |
| Concentrate cyanided, tons | 4,769 | 19,177 | 5,621 | 5,992 |
| Gold from concentrate.. | \$188,817 | \$892,361 | \$249,638 | \$256,943 |
| Total recovery | \$379,797 | \$1,828,744 | \$521,912 | \$520,263 |
| Yield per ton..... | \$1.7548 | \$2.0314 | \$2.0698 | \$1.8497 |
| Cost of milling..... | \$0.306 | \$0.3122 | \$0.2932 | \$0.2735 |
| Operating cost per ton.. | \$1.3000 | \$1.2333 | \$1.3054 | \$1.2973 |
| Construction, etc., charges | \$0.0966 | \$0.0407 | | \$0.0146 |
| Total costs | \$1.3966 | \$1.2740 | \$1.3054 | \$1.3119 |
| Profit | \$99,477 | \$859,187 | \$192,738 | \$151,254 |
| Balance from 1914..... | \$10,814 | \$48,680 | | \$15,160 |
| Total available | \$110,291 | \$907,467 | \$382,410 | |
| Dividends paid | \$90,000 | \$650,000 | \$252,280 | |
| Depreciation | \$10,101 | \$167,777 | \$94,115 | |
| Balance for 1916..... | \$10,190 | \$90,090 | \$36,015 | |

*Done jointly with the other companies.

Ore reserves are calculated to a depth of 2100 ft. in the Mexican and Treadwell, and 2200 and 2300 ft. in the Ready Bullion and 700-Ft. claim. The bottom levels in all show the greatest tonnages. As usual all companies contributed to the work at the Central shaft. This was sunk 117 ft. to a depth of 2471 ft. The main crank-shaft of the Central hoist broke in June, causing a tie-up of work here for 23 days. A new

piece of shafting was joined to the other by a flange-coupling, with complete satisfaction. The Mexican No. 2 shaft is being enlarged to five compartments, and is now known as the Combination. When down to 2100 ft. this shaft will give a second means of access from the surface to the lower levels of the group.

The cyanide-plant treated 35,502 tons of concentrate from the five mills at a cost of \$3.25 per ton of concentrate. The recovery was 97.03%.

The assay-office did 52,220 samples at a cost of 23.7c. each.

The Central power-plant (steam) has now a capacity of 4750

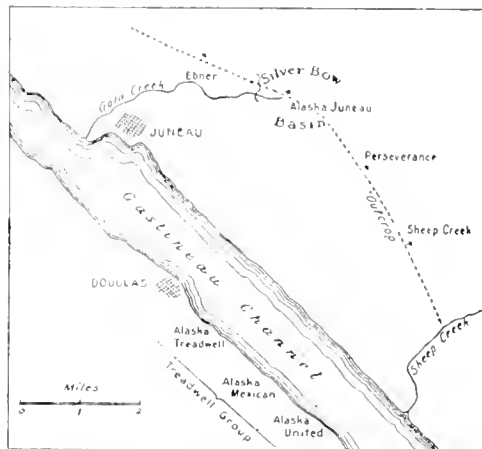

SKETCH OF THE JUNEAU DISTRICT, ALASKA.

kw. Various additions and improvements were made to the hydro-electric plant, including a machine to act either as a generator or motor at the Treadwell 240-stamp mill, depending on the supply of water for its change from one to another.

Work of the Treadwell Committee of Safety continued satisfactorily with a gradual broadening of its scope.

BROKEN HILL PROPRIETARY CO.

Iron and steel production is now one of the most important phases of this great Australian company's operations. The works are at Newcastle, New South Wales, and are now in full blast, producing in the half-year ended November 30, 1915, 37,311 tons of open-hearth steel. Additional furnaces are being erected. Large contracts for rails, billets, etc., have been secured for State governments and others. Shell steel for England has been made. Iron ore is shipped from Iron Knob in South Australia to the works, 99,289 tons being despatched during the period. Sales of iron and steel returned £241,403.

The general manager of the company, G. D. Delprat, reported briefly on the mine and works at Broken Hill. There was 114,579 tons of lead-silver-zinc ore extracted. The mill concentrated 98,798 tons, yielding 17,255 tons, averaging 60.61% lead and 28.39 oz. silver per ton. The re-grinding plant treated 82,401 tons of dump tailing for 2372 tons of concentrate with 52.62% lead. The flotation plant treated 141,104 tons of tailing, producing 36,667 tons of concentrate assaying 46.17% zinc, 13.07 oz. silver, and 6.56% lead. The sulphuric-acid plant produced 1969 tons of acid. The rainfall was 4 in. Owing to a labor dispute the whole district was at a standstill early in February of this year.

The net profit for the term was £242,970, from an income of £821,155. Two dividends absorbed £118,101. The surplus is £1,187,678, including £294,116 in cash. Dividends since 1885 total £12,618,302 (\$60,500,000).

The Kerr Lake Mining Co., at Cobalt, in its last financial year produced 2,036,963 oz. of silver from 23,935 tons of milling ore and 491 tons of high-grade ore. The cost was 21.45c. per oz. Dividends totaled \$620,000.

MINING DECISIONS

MINERAL LEASE—EFFECT OF ABANDONMENT

A lessee having abandoned a mineral lease, cannot thereafter claim or enforce any right thereunder without first securing the consent of the lessor or a renewal of the lease.

Harris v. Riggs (Indiana), 112 Northeastern, 36, April 6, 1916.

MILL SITE WITHIN FOREST RESERVE

The Act of June 4, 1897, making lands within forest reserves subject to entry under the existing mining laws of the United States confers the right to locate or purchase a mill-site in connection with a lode claim within a National Forest.

James W. Nicol (Land Department), 44 Land Decisions, 197, July 15, 1915.

VACATING PATENT—RESTORATION OF LAND TO ENTRY

Where as the result of a suit by the United States to vacate and annul a patent issued under coal-land laws, the lands in question are re-conveyed to the United States in accordance with a compromise agreement entered into by the parties to the suit, such lands do not become subject to filing or entry until the re-conveyance thereof has been duly noted upon the records of the local office.

Nathaniel J. Chapin (Land Department), 41 Land Decisions, 222, July 27, 1915.

PLACER LOCATION IN ALASKA—REQUISITES

The certificate of location of a placer mining claim which has not been verified and which describes the claim as the "No. 1 Bear Creek placer mining claim," being situated in the White River Mining district, territory of Alaska, and further describes "Bear Creek" as a tributary to "Big Eldorado" vests not title in the owner. The laws of Alaska require the certificate to describe the location of the claim with reference to some "natural object, permanent monument, or well known mining claim" such as will identify the claim in question, and the certificate must be verified before a valid recordation can be made. The location of a mining claim in Alaska under a power of attorney is valid, if the power of attorney is duly recorded at any time before adverse rights accrue, or location is attempted to be made of the same ground by another.

Clounger v. Finlaison (Alaska), 229 Federal, 98, February 7, 1916.

MINERAL TITLE TO LITORAL RIGHTS HELD VALID

The Alaska Juneau Gold Mining Co. acquired title to certain land on the literal line of Gostineau channel in the City of Juneau from three sources, namely: by mining lode locations, from purchase of mill-site locations, and by purchase of the possessory rights of certain Indians. The appellant which was a lumber company sought to build wharves over the property in question alleging that the Alaska Juneau company's title was defective because it was obtained under both mineral and non-mineral locations and that the construction of a roadway by the City of Juneau across the property had cut them off from litoral access. Held, that the Alaska Juneau title was good, there being no inconsistency in acquiring titles from all adverse sources. Nor was the mining company's right to the use of the shore extinguished by the construction of a city street without their express consent or grant of right or by exercise of the right of eminent domain.

Werthen Lumber Mills v. Alaska Juneau Gold Mining Co. (Alaska), 229 Federal, 969, March 6, 1916.

BOOK REVIEWS

RULES FOR CONDUCTING PERFORMANCE TESTS OF POWER PLANT APPARATUS. P. 209. Ill., index. The American Society of Mechanical Engineers, New York.

The Committee appointed in April 1909 by the American Society of Mechanical Engineers to revise the testing codes of the Society relative to powerplant apparatus has completed its work. The rules cover tests of boilers, reciprocating steam engines, steam-turbines, pumping machinery, compressors, blowers, and fans, complete steam-power plants, locomotives, gas-producers, gas and oil-engines, and water-wheels. Needless to state, the Committee has done its work in a thorough and careful manner, and the resulting volume will be indispensable to anyone having to do with power-plant testing.

COPPER. From the ore to the metal. By Hugh K. Picard. P. 139. Ill., plan, index. Isaac Pitman & Sons, London and New York. For sale by the MINING AND SCIENTIFIC PRESS. Price, 85 cents.

This little book is one of a series on common commodities of commerce published by Pitman's. The author is a distinguished metallurgist, well-known in cyanidation and flotation. Several excellent works have been written on the many phases of copper mining and metallurgy, mostly of a technical nature; the volume before us presents the subject in an elementary or popular style, suitable for shareholders interested in copper mines or untechnical readers who desire to get a general idea of the methods of extracting the metal. The latest concentrating tables are described and some space is devoted to flotation processes. Rectheratories receive a short chapter. Costs, marketing, and prices conclude an interesting essay on copper.

Recent Publications

U. S. Bureau of Mines, Washington, D. C., 1916.

MINERS' NYSLAGMUS. By Frederick L. Hoffman. Bulletin 93. P. 67. Index. This complaint results from a weakness of the eyes.

COAL-MINE FATALITIES IN THE UNITED STATES, 1870-1914. With statistics of coal production, labor, and mining methods, by States and calendar years. Compiled by Albert H. Fay. Bulletin 115. P. 379. Charts, map, index.

THE SAND TEST FOR DETERMINING THE STRENGTH OF DETONATORS. By C. G. Storm and W. C. Cope. Technical paper 125. P. 68. Illustrated. A publication of considerable practical value.

U. S. Geological Survey, Washington, D. C., 1916.

ASBESTOS IN 1915. By J. S. Diller. P. 6. Map.

FUEL BRIDGETTING IN 1915. By C. E. Leshner. P. 6. Chart.

FULLER'S EARTH IN 1915. By Jefferson Middleton. P. 1.

SLATE IN 1915. By G. F. Loughlin. P. 13.

MINERALOGIC NOTES. Series 3. By Waldemar T. Schaller. Bulletin 619. P. 164. Illustrated. Valuable to the mineralogist and student of new and rare rocks. A study of crystallography is involved.

GEOLOGY AND UNDERGROUND WATER OF LUNA COUNTY, NEW MEXICO. By N. H. Darton. Bulletin 618. P. 188. Ill., maps, charts, index. Some of the most important mining areas of this State and Arizona are north and west of this area.

GEOLOGY AND COAL RESOURCES OF CASTLE VALLEY, UTAH. By Charles T. Lupton. Bulletin 628. P. 88. Ill., map, charts, index.

NATURAL GAS RESOURCES OF PART OF NORTH TEXAS. By Eugene Wesley Shaw, George Charles Matson, and Carroll H. Wegemann. Bulletin 629. P. 129. Ill., maps, charts, index.

