

UC-NRLF

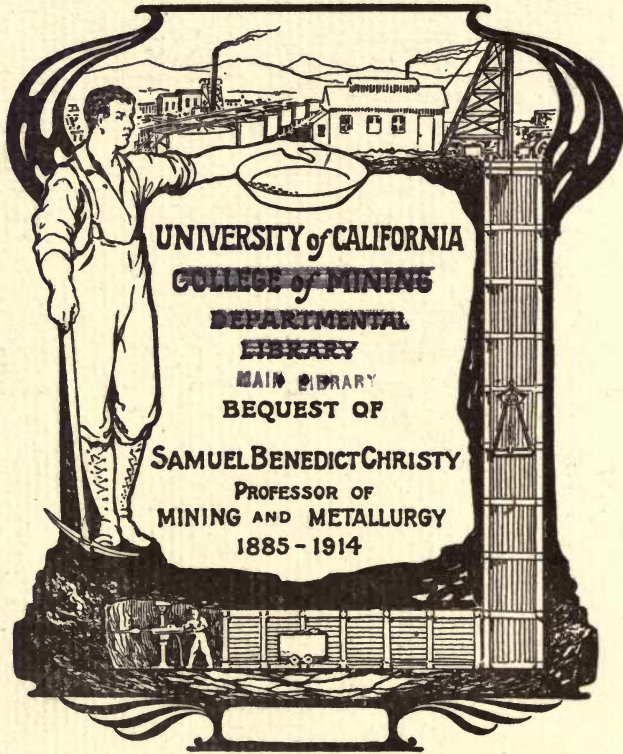

LB 79 836

MODERN
METHODS
of producing
COAL



UNIVERSITY of CALIFORNIA

COLLEGE of MINING

DEPARTMENTAL
LIBRARY

MAIN LIBRARY

BEQUEST OF

SAMUEL BENEDICT CHRISTY

PROFESSOR OF
MINING AND METALLURGY
1885 - 1914

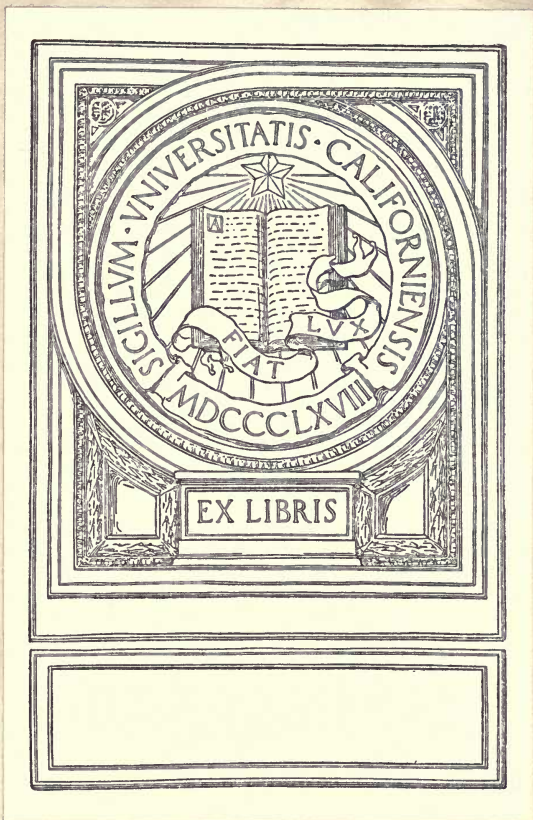

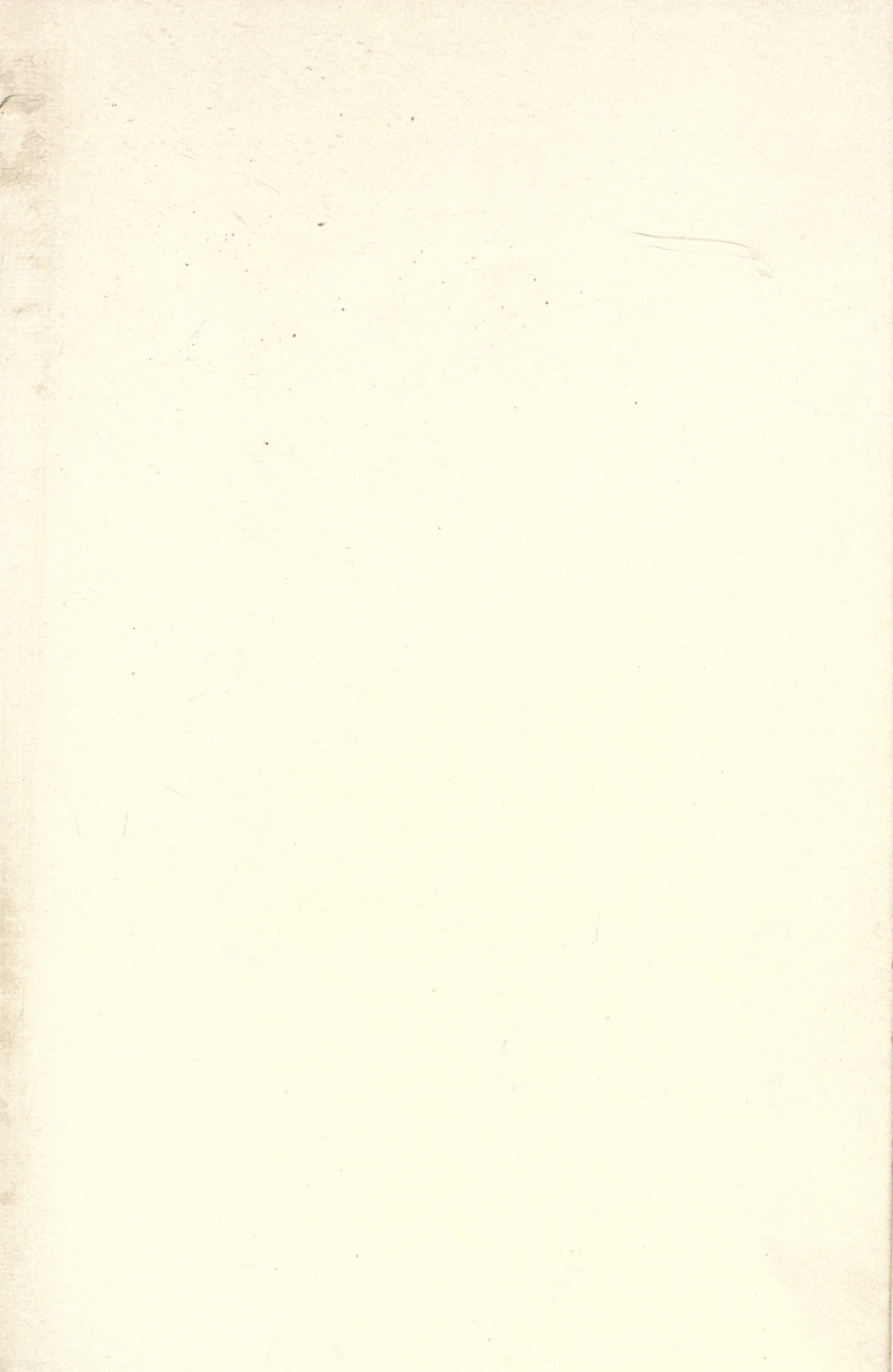

*MODERN METHODS
OF PRODUCING COAL*

Chasmar-Winchell New York and Pittsburgh

M O D E R N
M E T H O D S
O F P R O D U C I N G
C O A L

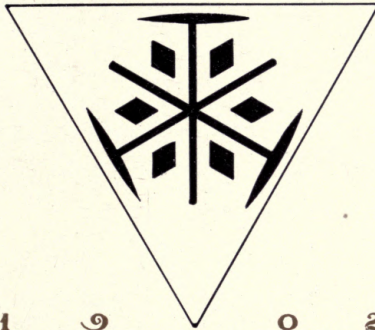

1 9 0 2
C A T A L O G U E
N U M B E R 4 8

*When referring to
this Catalogue by
Cable use Code word*
H A L I A D E R

C O A L M I N I N G
M A C H I N E R Y

M A N U F A C T U R E D B Y

S U L L I V A N
M A C H I N E R Y
C O M P A N Y

T 17814
S8

Copyrighted 1902
by the
SULLIVAN MACHINERY COMPANY

Sullivan Machinery Company

Works

Claremont, N. H. Chicago, Ill.

General Offices

135 Adams Street, Chicago, Ill., U. S. A.

Branch Offices

New York City, 71 Broadway

Pittsburg, Pa., 339 Fifth Avenue

Denver, Colo., 431 Seventeenth Street

Spokane, Wash., 5101 Howard Street

El Paso, Texas, 306 St. Louis Street

Cable Address, "DIAMOND CHICAGO"

Codes used — A1, A B C, Fraser & Chalmers, Liebers, Commercial
Directory, Western Union

A list of code words pertaining to coal mines is given on pages 67 to 69.

The
Sullivan Machinery Company

also manufactures

Diamond Core Drills

for the economical and rapid prospecting of
coal and mineral lands

Air Compressors

Channeling Machines

for quarrying dimension stone

Rock Drills

for the excavation of rock

Corliss Engines

Winding Engines

for hoisting and hauling

Fans

for ventilating mines

Automatic Cross-over Dumps

Special catalogues are issued illustrating and describing each of the above classes of machinery, copies of which may be obtained upon request.

Several interesting tables regarding the bituminous coal production of the United States are given on pages 73 to 76.

T a b l e o f C o n t e n t s

	Page
Introductory	11
Machines Used in and about Coal Mines	13
Pick Machines	21
Shearing Machines	35
Electric Chain Machines	43
Long Wall Machines	61
Air Compressors	81
Air Receivers	107
Diamond Prospecting Core Drills	111
Rock Drills	125
Automatic Dumps	135
Ventilating Fans	141
Winding Engines	147
Index	152

An index is given on page 152



INTRODUCTORY

IN presenting this illustrated catalogue descriptive of the Sullivan Coal Mining Machines, it is desired to show some of the fundamental features upon which superiority is claimed. In a book of this character it is impossible to go into every detail, but if it arouses interest in the machinery it serves its purpose. As the efficiency of nearly every machine is dependent upon local conditions, it is suggested that prospective purchasers permit examination of the properties, that the company may be in position to state definitely just what may be expected from the machines, aside from the fact that a personal interview is always preferable to correspondence.

In the Sullivan and Bullock machinery only the best materials obtainable are used, and modern methods govern their manufacture. No expense has been spared to make all products as simple, durable and efficient as possible; all parts being made to jigs and templates, are perfectly interchangeable.

As will be noticed, the line of coal mining machinery is considerably larger than that of any other manufacturer. The policy of the company is strictly one of advancement. Improvements are constantly being made and new machines developed as conditions change. The closest scrutiny is courted of the entire line of manufacture, and correspondence bearing on this subject will receive prompt and courteous attention.

SULLIVAN MACHINERY COMPANY

June 1, 1902

Official mining scales showing the differentials between pick and machine mining are given on pages 71 and 72.

Sullivan Machines Used in and about Coal Mines

A Few Facts Briefly Stated



SOME few years ago, after a careful examination and study of the conditions governing coal mines, the company became convinced that the coal of the

future would be generally mined by mechanical methods, not only on account of the saving in the cost of production, but for several other reasons enumerated later. Then began the designing and manufacturing of a machine which would successfully and economically meet the requirements. At that time there were several coal cutting machines on the market, but for one reason or another they had met with only partial success. In developing the Sullivan Coal Cutting Machine, the aim was not to produce a machine the utility of which would be more or less limited and which could only be used under favorable conditions, but one which would work successfully in any place accessible to a pick miner. With between thirty and forty years of experience in the successful manufacture of rock working machinery where the conditions were far more severe than in coal mines, the well-known and tested principles of these machines were brought to bear in designing the coal cutting machinery.

This was the beginning of the Sullivan Pick Machine, and its immediate acceptance alike by the operator and miner was most gratifying. It was only about five years

ago that this new and untried machine was placed on the market, and to-day it stands alone at the head of its class, with a reputation more extensive, and with greater sales to its credit, than machines which have been before the public for nearly a score of years.

The endeavor has been to make the line of manufacture so complete that, no matter how unusual or irregular the conditions, a machine could be procurable specially adapted to the requirements.

The company appreciates that the Electric Chain Machine possesses some advantages over the Pick Machine, though its use is more limited, and has therefore designed a radical departure from the existing machines, which is here presented for the first time.

The idea in manufacturing both types of these machines was, primarily, to be placed in a neutral position, in order to candidly advise a prospective purchaser which is preferable and the better suited to existing conditions. The statements made by manufacturers producing only one type of machinery are naturally biased and more or less prejudiced, while the Sullivan Machinery Company, manufacturer of both types, is enabled to give an unbiased and unprejudiced opinion which should be entitled to the most careful consideration. Generally, upon learning of the contemplated introduction of coal cutting machinery, an expert is sent to make a complete examination of the property. Practically confined to the making of such examinations, a great fund of

Machine
Mining



Pick
Mini

experience is at hand from which to draw conclusions, and hence this expert opinion is of value and should be a reliable guide to purchasers; but should extraordinary conditions be encountered, where machine mining of any sort would be considered impracticable, it will unhesitatingly be so stated.

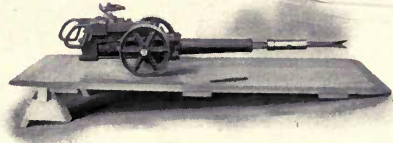

Pick Machine

Managers of pick or hand mines should bear in mind that coal cutting machines offer several more points of advantage than merely a reduction in the cost of the coal on the mine car. In pick mines nearly every employee is a skilled workman requiring several years of experience before being able to perform good work. The use of machines reduces the proportion of this skilled labor and at the same time increases the productive capacity per capita. This means that, for a given tonnage, fewer miners are necessary, resulting in less dissension between employer and employee, a smaller investment for houses, etcetera; in fact, the saving in the number and the cost of houses alone will usually pay for a coal cutting machine plant. Further, in machine worked mines the work is more concentrated, resulting in less area to support, drain and ventilate.

The SULLIVAN PICK MACHINE OR PUNCHER has even surpassed all expectations as regards sales, efficiency, durability, and ease of operation. The company is the pioneer in the introduction of compressed air cushions into this class of machinery, thus permitting a harder blow and accomplishing greater work with less jar and less fatigue to the runner. To one company alone has been sold over 450 machines, to

several others more than 100 each, and to many others from 10 to 25 machines each. Unless this machine actually possessed exceptional merit it could not continue to receive

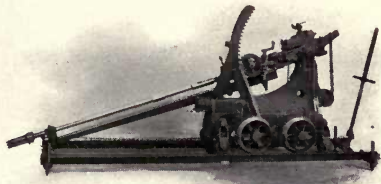

Bearing Machine

Electric Chain Machine

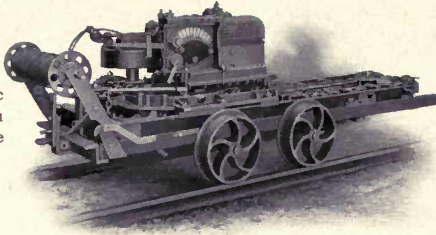

the patronage of the largest producers of coal in this country; in several cases the thirtieth repeat order for Sullivan Pick Machines has been received.

The SULLIVAN SHEARING MACHINE has also made a great name for itself, having proven especially valuable where the coal shoots freely from the solid or where the shearing of headings is an important factor. It is simply a pick machine with the valve motion adjusted to strike more rapidly, and is mounted on a truck so arranged that the machine never leaves the mine track, the cutting mechanism being moved in a vertical plane, at the same time fed forward by means of a chain.

The SULLIVAN ELECTRIC CHAIN MACHINE is practically a long wall machine adapted to the room and pillar system.

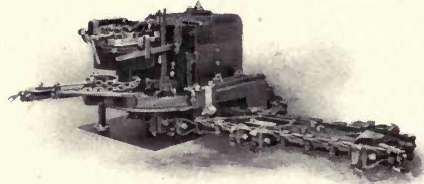

Long Wall Machine

It has long been recognized by students of this type of machine that the older makes consume too much time in being moved across the face of the room, and in the consequent necessary setting and re-setting of the jacks; in fact, over fifty per cent. of the time is lost in this way; these machines also require that a great area of top be sustained, making it both hazardous to men and machine to work under the usual roof conditions. In the Sullivan these serious drawbacks have been eliminated, as the machine propels itself across the face, there being no pause in the cutting until the room is finished, and in addition it requires that less than one-half the usual space be maintained between the face of the coal and the props.

This machine also possesses other points of unique merit which are discussed later in detail.

Automatic Cross-over Dump



The SULLIVAN LONG WALL MACHINE is a new departure designed to meet the growing demand for such a machine. Until recently long wall mining has been little followed in this country, but under especial requirements a number of mines have lately been opened on this system, and hence a machine has been built to meet these new conditions.

Herein will be found described the WILSON AND MITCHELL AUTOMATIC CROSS-OVER DUMPS for the

rapid and economical dumping of mine cars. These devices have been on the market for a long time and are used in nearly every coal producing district in this country, hence are too well and favorably known to require any further comment.

The SULLIVAN DIAMOND DRILL for prospecting coal and mineral lands, and the SULLIVAN ROCK DRILL for mechanically drilling holes through faults or for blasting up bottom and blasting down roof in coal mines, are also discussed briefly in this catalogue, though a special catalogue of these machines may be obtained upon request.

In the standard straight line SULLIVAN AIR COMPRESSOR the air is compressed in two stages, thus better distributing the strain upon the machine than if the entire compression was done in a single cylinder. Between the two air cylinders an intercooler is placed, by means of which the air during the process of compression is kept at a low temperature, with a consequent economy in the consumption of steam energy. The intake valves in the low pressure air cylinders are opened mechanically, and being of large area insure the cylinder filling quickly with cool air.

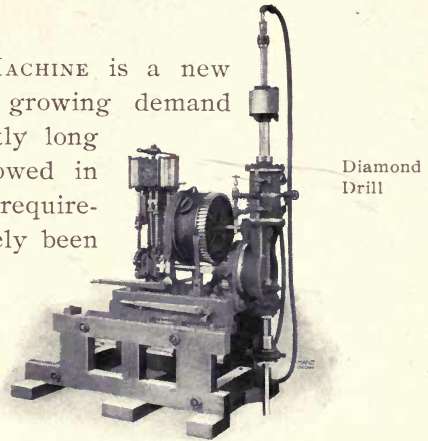

Diamond Drill

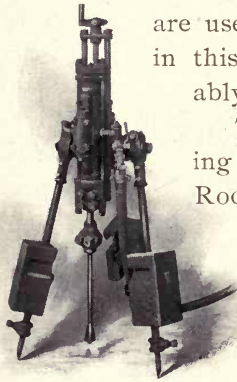

Rock Drill

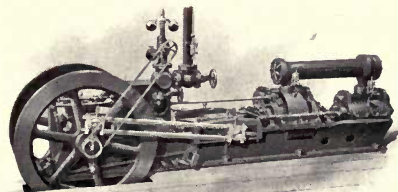

Air Compressor

About February 1, 1901, the company acquired the entire plant and business of the M. C. Bullock Manufacturing Company, of Chicago, Illinois, who enjoyed an enviable reputation as manufacturers of the Bullock Diamond Drills, Champion Mine Ventilators, and Hoisting and Hauling Engines. A special catalogue is issued descriptive of these machines, which may be obtained upon request.

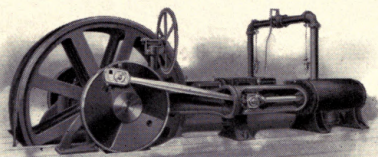

Hoisting
Engine

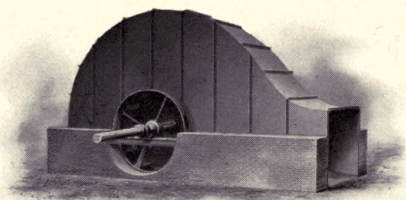

Champion Ventilator



COAL CUTTING
MACHINES
DRIVEN BY COMPRESSED AIR

SMC

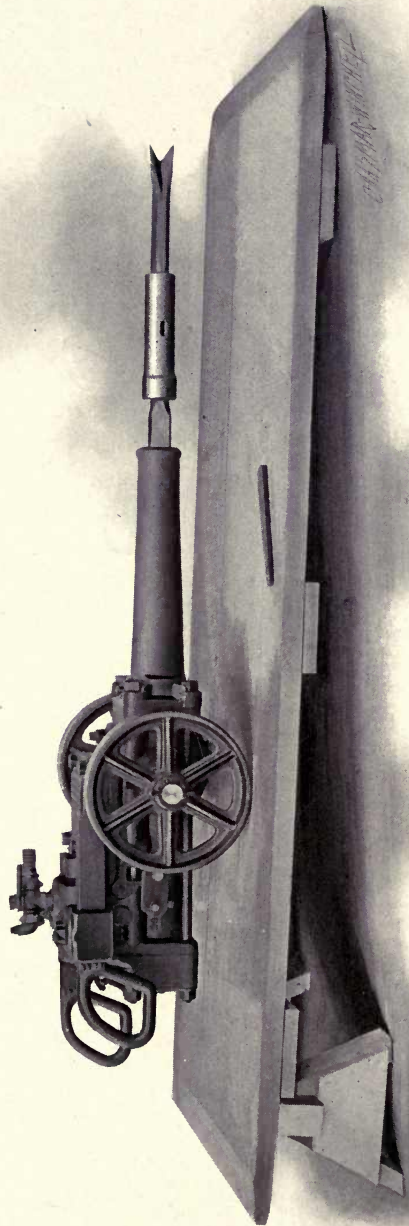

Sullivan Pick Machine on Mining Wheels

The Sullivan Pick Machine

For the Mining of Coal



THE principle of the striking machine or puncher is an old one. It is simply a reciprocating engine mounted on wheels and set upon a platform, elevated at the rear end to counteract the recoil of the machine when striking the coal. The runner sits on the platform and clogs the wheels with either foot, at the same time directing the blows of the machine to the proper place. This is the ideal type of coal cutting machine, as it will work successfully in any place accessible to a pick miner, and works equally well either on breast or rib, in cutting around props, or in dislodging such sulphur bands or balls as may occur in the mining. By substituting higher wheels for the low mining wheels, vertical cuts or shearings may be advantageously made, thus constituting it an all-round machine. If many shearings are to be made, the Sullivan Shearing Machine, described on page 35, and which has been especially constructed for this purpose, is highly recommended.

The Sullivan Pick Machine placed on the market some five years ago, while broadly following the old ideas, departed in nearly every detail from the then existing pick machines, so that practically a new principle in coal cutting was originated.

This company was first to recognize the advantages of using compressed air expansively, thus securing greater economy. By adjusting the index lever on the rear cylinder head, the air may be carried at will from one-half to five-sixths of the stroke and then cut off and the balance of the

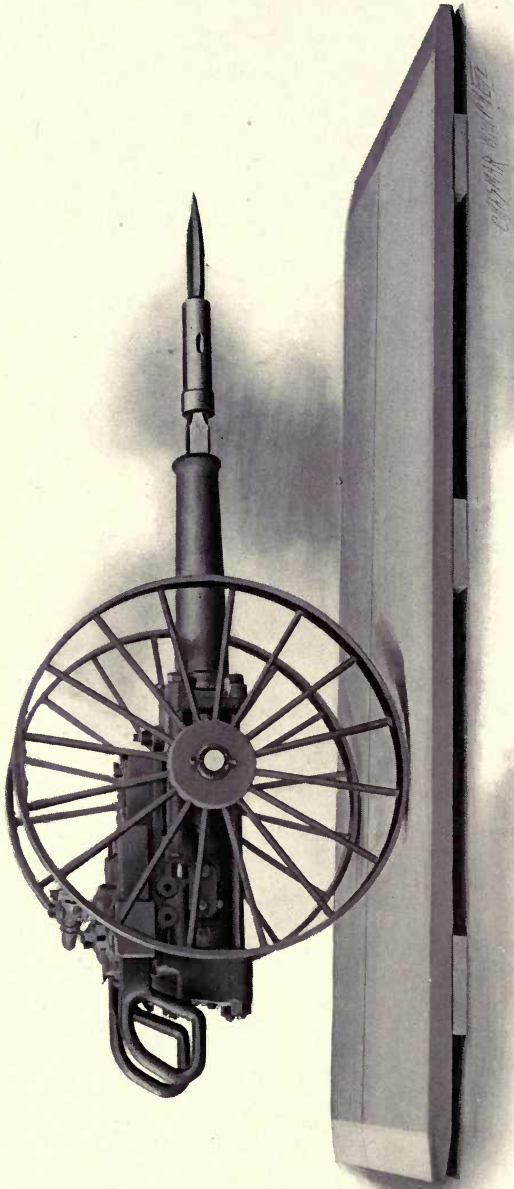

Sullivan Pick Machine on Shearing Wheels

stroke continued by the expansion of the air. This feature, besides the economy of power, permits of the operation of the machine on a very wide range of pressure, as it works equally well under high or low pressure and at the same time strikes a hard and effective blow. Until the introduction of the Sullivan, all other pick machines protected the cylinder heads from the blow of the piston by means of leather or rubber buffers, which, being imperfectly elastic, only partially served the purpose, and the machine itself had to stand a large portion of the shock. By reason of this fact, the force of the blow was of necessity limited, or else damage was sure to result to the machine, and in addition, the cost of replacing the buffers became a serious item of expense.

At the start the only logical principle of cutting coal with this type of machine was adopted, viz., *a slow but hard blow*, making each blow count. The hard blow, without damage to the machine, was made possible only through the introduction of air cushions. The first Sullivan possessed this unique feature, and the way in which it has been copied by competitors proves that it was and is of especial value. We have observed, in fast-running pick machines, where above 190 strokes per minute are delivered, that a large proportion of the blows are struck at random, causing pockets in the rear end of the cut, greatly punishing the runner in throwing him around the board, and retarding the smooth running of the machine, besides which each misdirected blow is a waste of physical and mechanical energy. The Sullivan, having a slow recovery

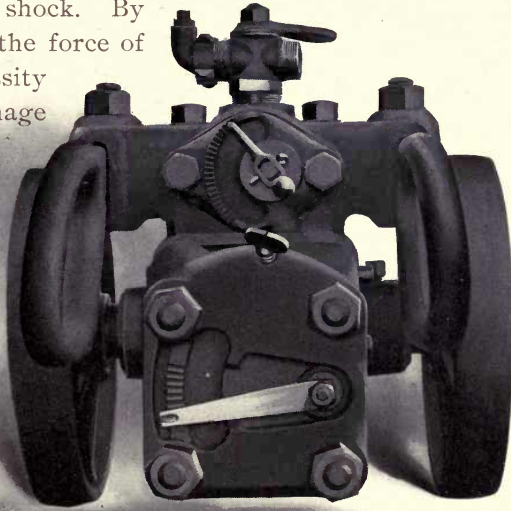

Rear view showing index levers for adjusting speed and stroke of machine



Sullivan Pick Machine at work in Eureka No. 85 mine of the Berwind White Coal Mining Co., Windber, Pa. This company has over 450 Sullivan Pick Machines in use or on order.

CHAMP

and a quick forward stroke, allows a pause between each blow, during which the machine may be directed to strike exactly where desired, and the blow being of great force, results in the maximum work being accomplished.

The governing is done upon the back or return stroke, which is so arranged that the machine delivers the same number of blows whether away from or against the coal. In the first machine, the governor was adjusted to reduce the speed of the machine whenever the coal was missed. This was first thought to be an economical arrangement, but it was quickly ascertained that a varying speed seriously affects the running balance of the machine.

The valve motion in the Sullivan is positive, being so constructed that a wide range in the speed may be obtained by moving a pointer on the back of the valve chest. A runner starting a new machine regulates the number of blows by means of this pointer until it suits his individual taste, after which no further adjustment is necessary until another man takes his place. In the Sullivan, the number of blows is absolutely independent of their force, and it is just as easy to secure easy blows as those more rapid or of greater force.

As previously mentioned, the Sullivan Pick Machine contains a valve motion actuated by the piston, which in the event of the pick sticking causes the cylinder to become the reciprocating part, which results in so-called "racing" and is somewhat criticised by inexperienced hands. Instead of this feature being detrimental to the machine or its operator, it is one of the factors that have made the Sullivan so eminently successful, as one or two strokes of the machine is all that is necessary to free the pick, no matter how tightly wedged into the coal, while with the others it is often necessary to loosen the machine with a hand pick. Further, the positive movement is taken advantage of by skilled cutters, as it saves a great many of the heavy lifts with the other machines, and after a miner once becomes accustomed to the Sullivan he is unwilling to use any other pick machine. Pick machines having independent valve motions are subject

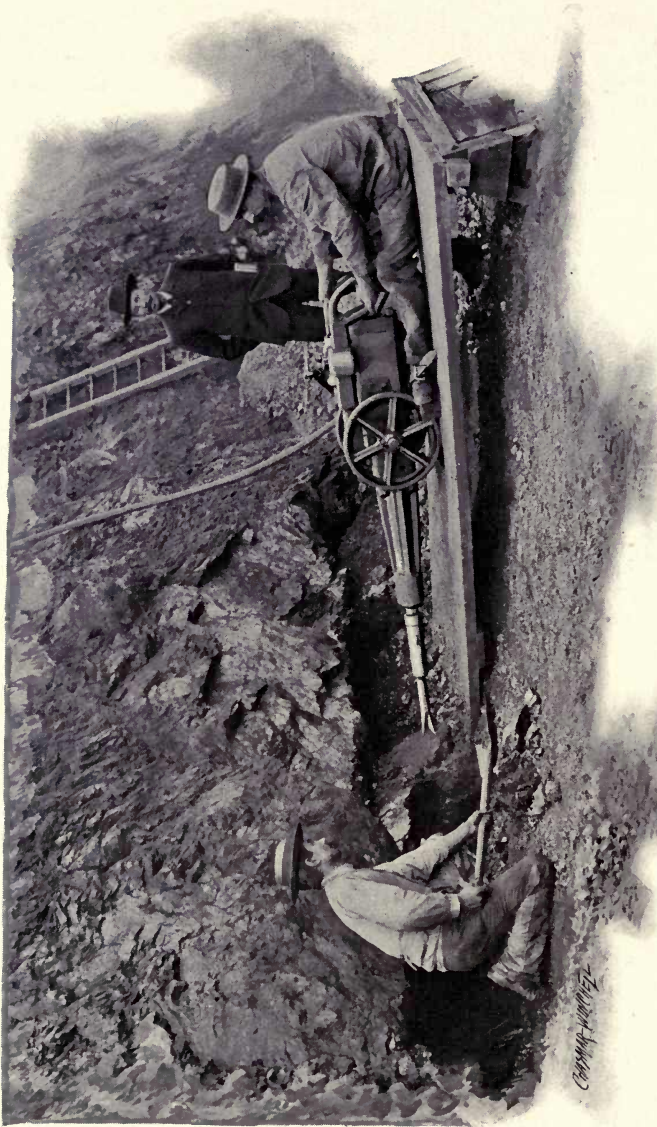

Sullivan Pick Machine at work in open pit at
Decazeville, France

Company - 1912

to heavy recoils or kicking in the event of the pick becoming stuck, however slightly, in the coal. Under these conditions, the valve motion continues at a uniform rate of speed, admitting air into the cylinder for the forward stroke before the return stroke has been completed, thus resulting in a weak blow accompanied by a heavy recoil.

The Sullivan machine is made so that it may exhaust on either or both sides at pleasure, thus permitting the slack shoveler or scraper to work either right or left handed without being annoyed by the vapor from the exhaust.

The machine contains no front bushing in the trunk or sleeve to guide the piston and to keep it from turning, but instead the trunk itself is babbitted and when worn out may be rebabbitted at a trifling expense. The number of moving parts in this machine is few, and they are made so as to present large wearing surfaces, provision being made for taking up all wear, thus reducing to a minimum the cost of repairs. All joints are scraped or ground so that no gaskets of any kind are required to make them tight.

A table is given on page 99 showing the compressed air requirements of from one to forty Sullivan Pick Machines.

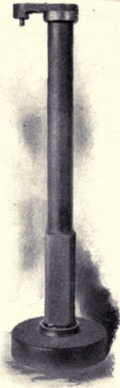

Rebabbiting
Mandrel

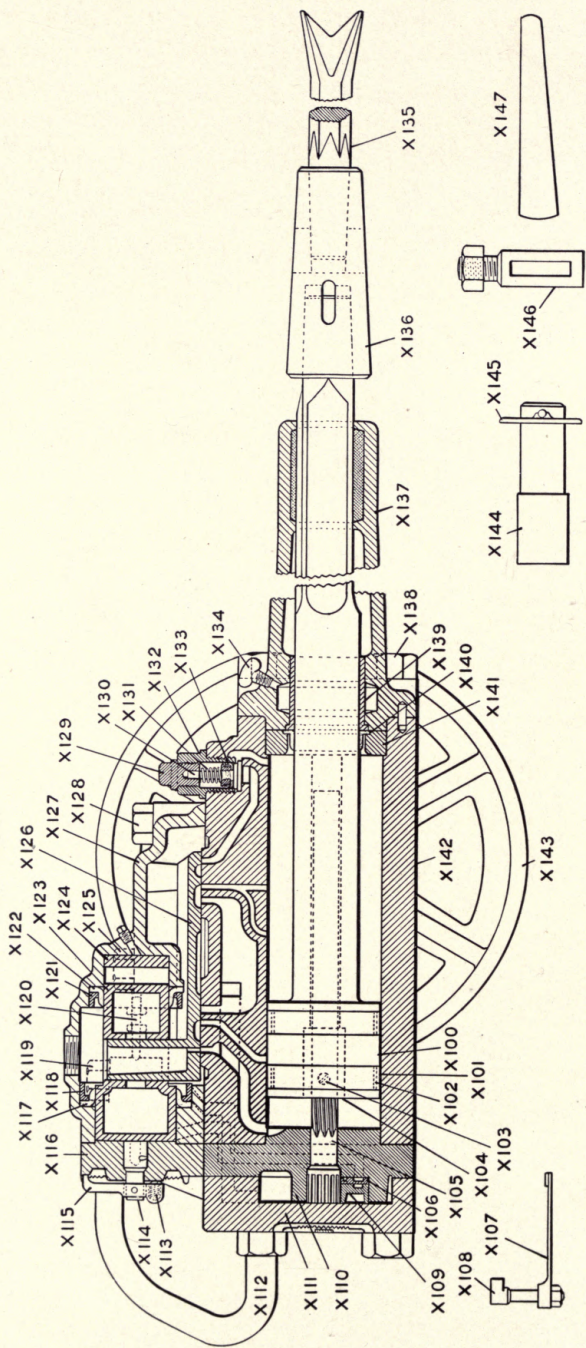

Sectional View, Sullivan Pick Machine

List of Parts of Sullivan Pick Machine as shown in Sectional View on opposite page

X100 Piston (bare)	X123 Valve (piston)
X101 Piston ring (4)	X124 Buffer for X123
X102 Piston ring spring (2)	X125 Cap screw $3\frac{7}{8}$ in. long (2)
X103 Set screw for X104	X126 Valve (flat)
X104 Rifle nut	X127 Steam chest (bare)
X105 Rifle bar with gear	X128 Cap screw $3\frac{7}{8}$ in. long (2)
X106 Seat for X109	X129 Plug in top of X132
X107 Spring pointer for X108	X130 Check valve with nut
X108 Stem for adjusting X106	X131 Spiral spring for X130
X109 Reverse valve	X132 Holder for X130
X110 Valve plate	X133 Packing leather for X130
X111 Cover over X110	X134 Plug for oil hole
X112 Handle (2)	X135 Pick
X113 Spiral spring for X115	X136 Chuck
X114 Regulating valve	X137 Head (front) for X142 (bare)
X115 Index lever for X114	X138 Bolt (4) for X137 and X111
X116 Head (bare) for X127	X139 Bushing in X137
X117 Packing leather (large) for X123	X140 Packing leather for X100
X118 Ring for X117	X141 Collar for X140
X119 Cap screw $5\frac{1}{4}$ in. long (2)	X142 Cylinder (bare)
X120 Binding screw for X118 and X122 (2)	X143 Wheel (2)
X121 Ring for X122	X144 Trunnion (2) for X143
X122 Packing leather (small) for X123	X145 Washer with pin (2) for X144
	X146 Clevis bolt (2) for X112
	X147 Drift key for backing out pick

The numbers of parts here shown are for identification only.

When ordering repair parts, the number stamped or cast on part should be given and the class number and letter of the machine should also accompany order.

List Sullivan Pick Machines

Class		Bore of Cylinder inches	Depth of Undercut feet	Weight pounds	Code Word with Regular Equipment
Number	Letter				
1	T T	4½	5½	800	<i>Halidion</i>
2	T T	4½	5½	700	<i>Halidito</i>
3	T S	4¾	4½	500	<i>Halidome</i>
4	T U	5⅛	5½	725	<i>Halidux</i>
5	T U	5⅛	5½	825	<i>Haligado</i>
6	T U	5⅛	6	850	<i>Haligan</i>

The following equipment is furnished with each machine:

Long
Handle
Shovel

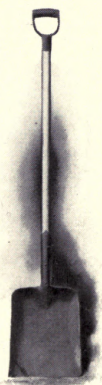

- One throttle
- One drift key for backing out pick
- One monkey wrench
- One hand oil can
- One hand hammer
- One foot clog
- One long handle scraper's shovel

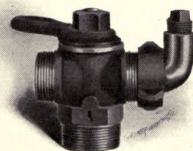

Throttle



Foot Clog

In addition each plant is furnished with a complete set of solid wrenches.

List Standard Mining Wheels

Diameter inches	Code Word for Pair
11½	<i>Halibutt</i>
13	<i>Halicaba</i>
15	<i>Halical</i>
17	<i>Halicare</i>

List Standard Shearing Wheels

Diameter inches	Code Word for Pair
29	<i>Haliban</i>
34	<i>Halibio</i>
40	<i>Halibore</i>

Sullivan
Air
Hose



The SULLIVAN AIR HOSE is thoroughly reliable, and unless specially ordered is furnished in 50-foot lengths ; for the sake of greater flexibility no wire or marline winding is used, though hose with either of these windings is supplied when desired.

Code word *Haligig*

Sullivan
Machine
Picks

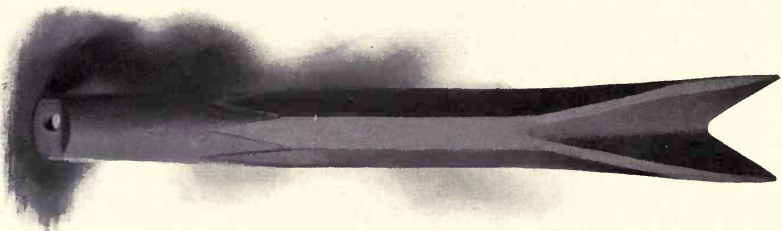

SULLIVAN PICKS are made of a high grade of domestic steel which has been found to give the best results in maintaining the cutting edge, and as they are drop forged in hardened dies, perfect uniformity results and the shank always accurately fits the chuck or extension. A dozen or more picks are usually required for each machine.

Code word *Haligush*

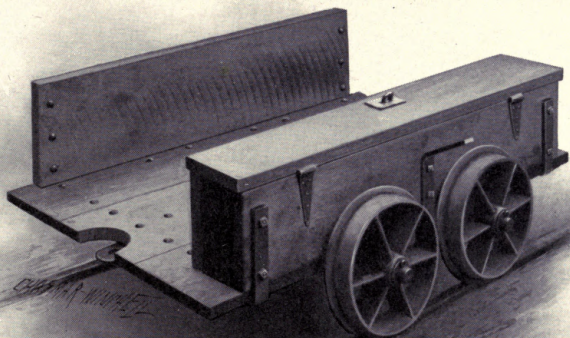

Truck for
Pick
Machine

To move pick machines from place to place within a mine a light truck is necessary, which is furnished at extra cost upon request.

In ordering, give gauge of track.

Code word

Halimato

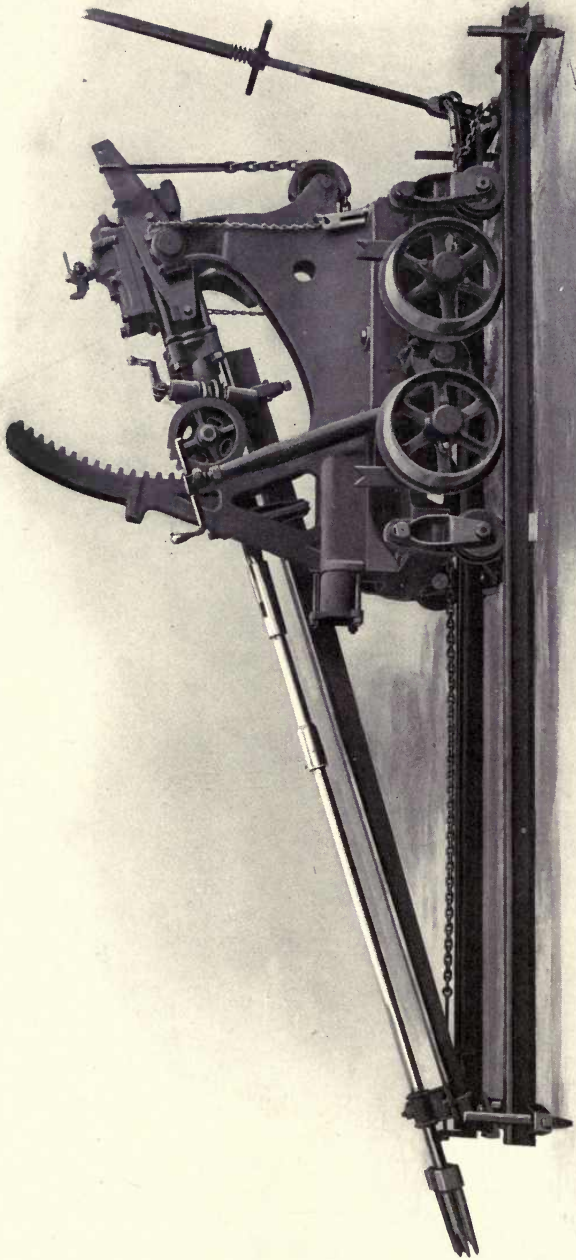

Sullivan Shearing Machine

The Sullivan Shearing Machine

For the Shearing of Coal



IT has been ascertained that in many mines where the coal shoots freely from the solid, a vertical cut or shearing in the center or near the rib is productive of as much coarse

coal as if the room or heading had been undercut. Under such conditions the Sullivan Shearing Machine is a decided success, as it will produce nearly double the tonnage of any undercutting machine. It is in effect a Sullivan Pick Machine adjusted to strike more rapidly, and is mounted on a truck conforming to the gauge of the mine track and so arranged that the cutting tool may be moved in a vertical plane. The machine is provided with two sets of wheels, one set fitted on a long base, to be used during the process of cutting, thus securing stability to the machine, the second set on a short base, so that in moving the machine sharp curves may readily be turned. Changes from one set of wheels to the other may be quickly made, the movement of two eccentrics being all that is necessary. To hold the machine in place when working, the first section of track, which is always carried with the machine and upon which it works, is fastened by means of a jack into the roof. Parallel to the rail and fastened to it at both ends is a chain which engages in a sprocket operated from above by a crank handle, and by this means the machine is kept up against the work. The runner stands on the platform of the machine and with the crank handle in his right

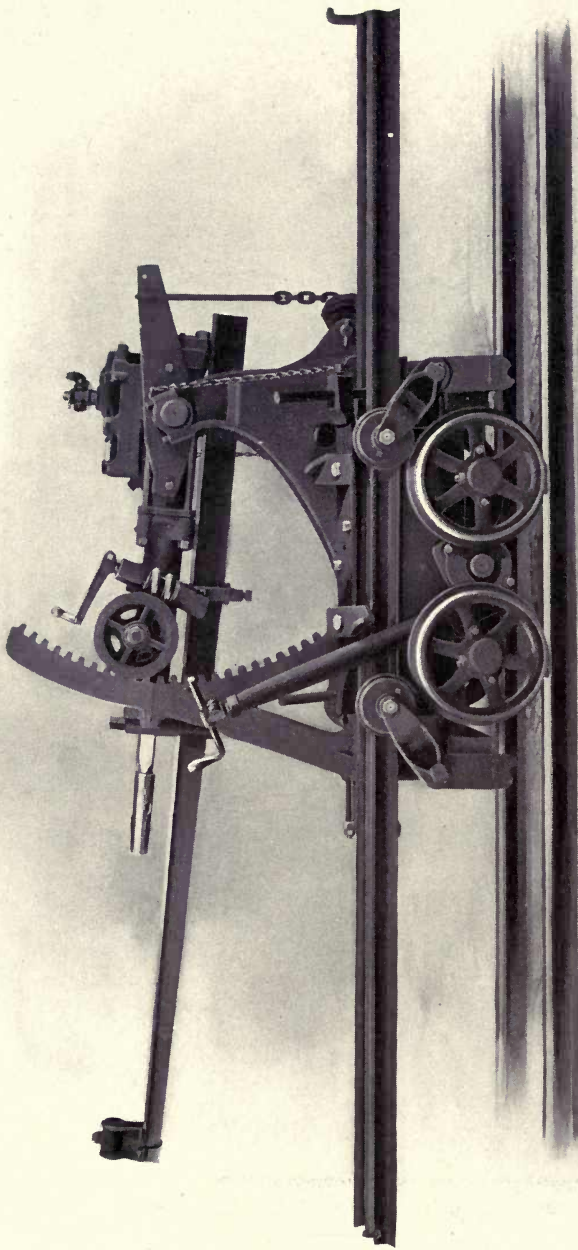

Sullivan Shearing Machine ready to move

hand moves the cutting tool upward or downward, and with another crank handle in his left hand feeds the machine forward as the cut advances.

As will be noticed, the Sullivan Shearing Machine absorbs within itself all the recoil and shock of the blow, and hence the runner is not punished nearly as much as with the pick machine mounted on shearing wheels. Cutting records of from seven to eight shearings seven feet deep, in coal six and one-half to seven feet in height, have been made in a shift. The machine is simple in construction and possesses all the valuable features of the pick machine, and there are no weak parts to cause trouble and expense. It is made to conform to the regular gauge of the mine track, and will produce cuts from five to eight feet in depth. The same equipment is furnished as with the Sullivan Pick Machine.

In ordering, or requesting information, please give the height of the coal and the gauge of mine track.

List Sullivan Shearing Machines

Depth of Cut feet	Code Word
5	<i>Halimeder</i>
5½	<i>Halimena</i>
6	<i>Halimessi</i>
6½	<i>Halimintu</i>
7	<i>Halimish</i>
7½	<i>Halimisco</i>
8	<i>Halimizen</i>

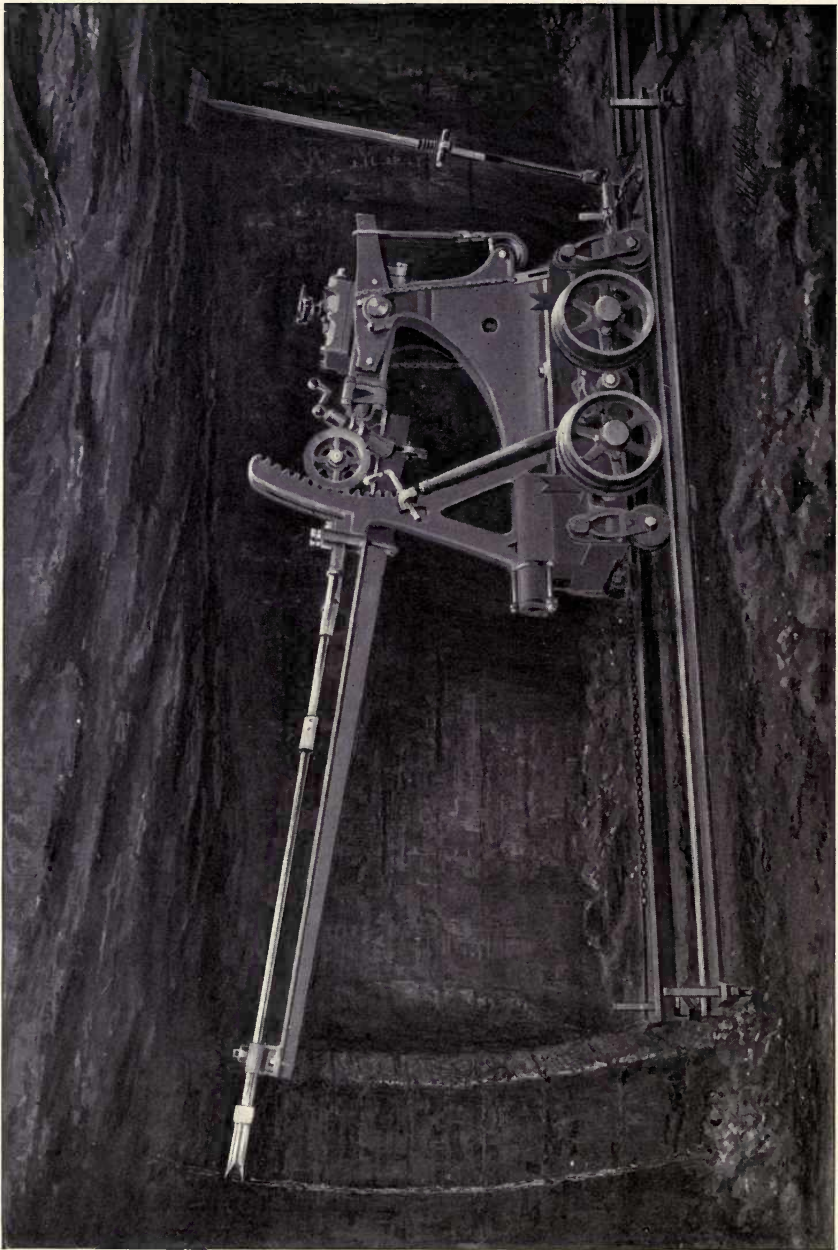

Sullivan Shearing Machine, side view. Cut partially made

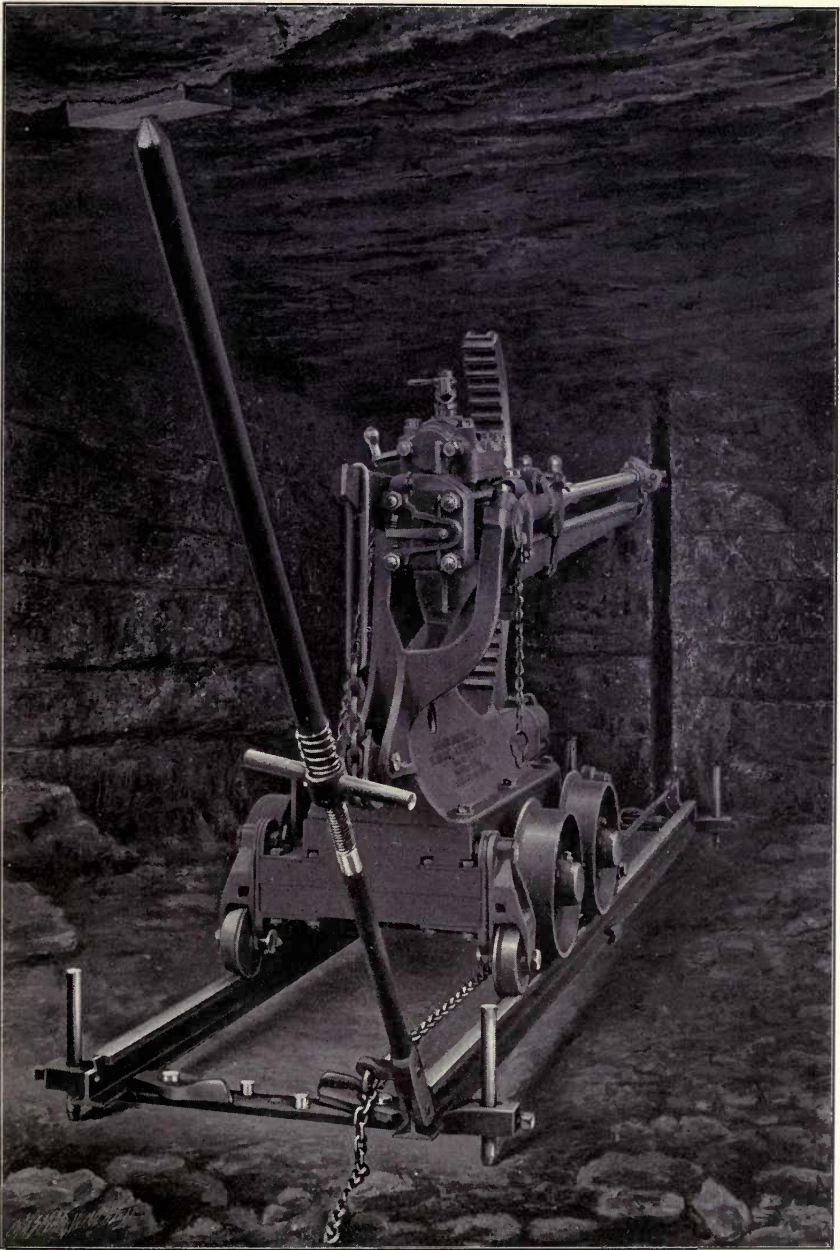

Sullivan Shearing Machine, rear view

HAULAGE has too frequently been made the governing issue in the selection of a power plant for coal cutting and haulage. Traction haulage is usually a satisfactory investment if the hauls are long and grades favorable, but it rarely shows the economies made possible by the use of coal cutting machines. Many cases may be cited where electric plants have been installed because electric traction haulage was desirable, when the conditions were adverse to electric chain machine mining and entirely favorable to compressed air pick machines. In almost every instance machine mining is more important than mechanical haulage. A number of large operators combine the two kinds of power, using electricity for hauling and compressed air for mining the coal.



A familiar scene about a coal mine

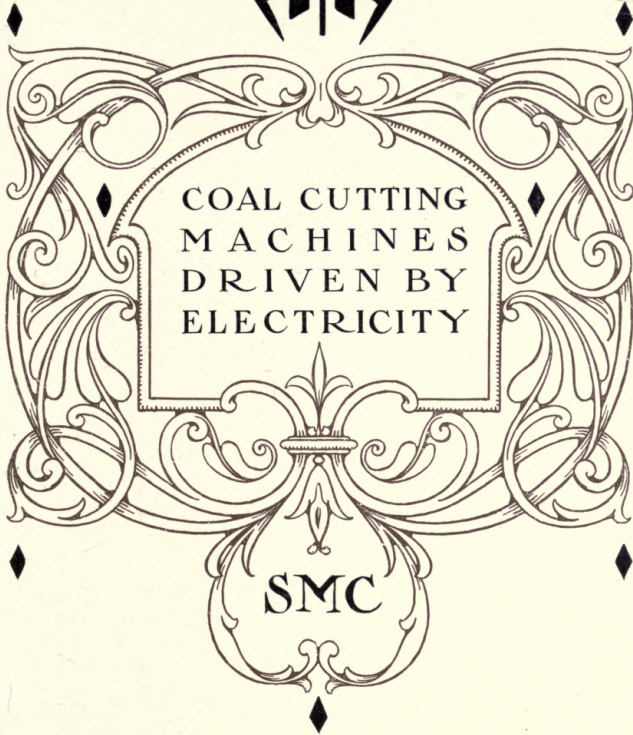

COAL CUTTING
MACHINES
DRIVEN BY
ELECTRICITY

SMC

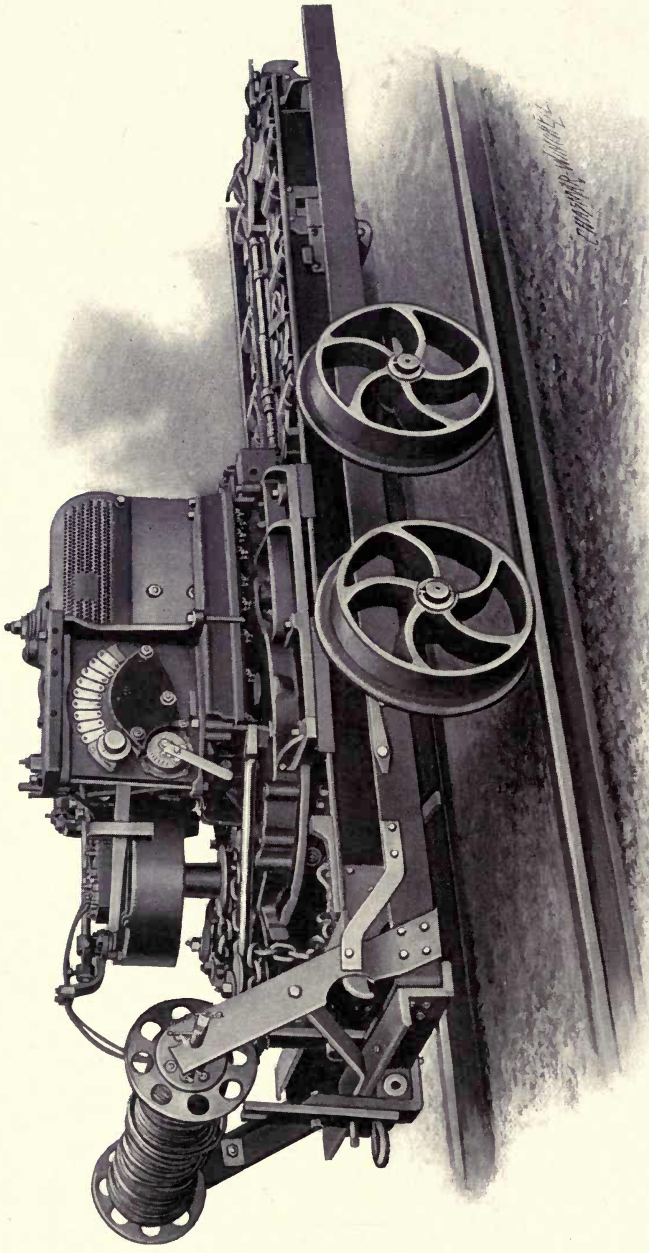

Sullivan Electric Chain Machine on
standard truck

The Sullivan Electric Chain Machine

F o r t h e M i n i n g o f C o a l



ALL persons who have made a thorough investigation of coal cutting machinery have ascertained that electric chain machines possess greater cutting efficiency than pick machines under especially favorable conditions, but on account of the

length and heavy construction of the older makes of chain machines the number of districts in which they could be used to advantage was found to be few, hence a great majority of the machine worked mines of this country have been equipped with pick machines, owing to their all-round character and general applicability. The older makes of chain machines are from ten to twelve feet in length, dependent upon the depth of the undercut, thus requiring a great area of roof to be kept up, which, in general, cannot be sustained without serious danger both to machines and operators. The loaders in following these machines have logically objected to the distance over which they have had to handle the debris or dirt from the coal, or the draw slate from the roof which frequently comes down with the coal as it is blasted. As the loaders constitute a majority of the workmen in machine mines, their contentment is of vital importance, and experience has proven that during shortages of labor the chain machine mine managers find difficulty in securing enough loaders, while the pick machine mines are abundantly supplied.

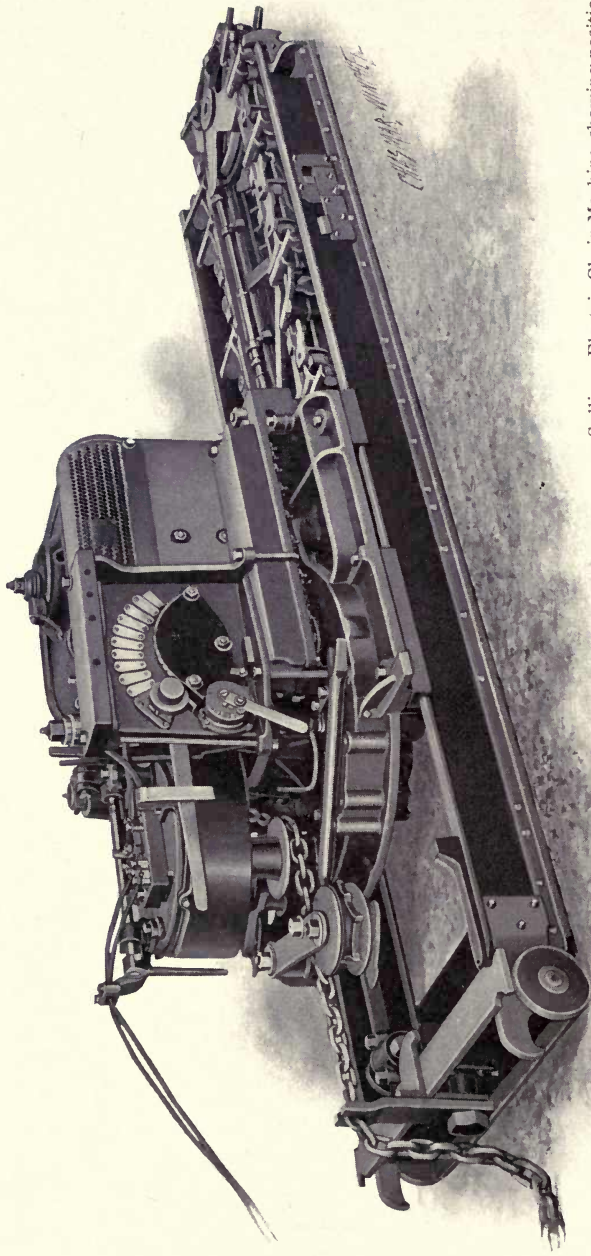

Sullivan Electric Chain Machine, showing position at starting of "tight" or corner cut

It has been noticed that in the old styles of chain machines only a small portion of the working time is actually consumed in cutting, the balance of the time being consumed in withdrawing the machine from the cut, setting and re-setting the jacks by which the machine is held in place, barring the machine across the face into its next position, etcetera. These conditions not only waste valuable time but contribute other adverse features as well, for unless great care is exercised the cuts will be put in at different heights, thus making an uneven floor and leaving bottom coal to be lifted; besides, frequently a rib is left between the "cuts," making the coal as difficult to excavate as if it had not been undermined. These machines being fixed rigidly in place, are unable to follow any irregularities in the bottom of the coal, and the rear jack piercing the roof at regular intervals is often a cause of serious accidents by bringing down the roof.

When starting to develop the Sullivan Electric Chain Machine it was evident that while it could not be expected to attain the all-round characteristics of the Sullivan Pick Machine, still it was believed that many of the serious drawbacks of the older chain machines could be remedied, and thus broaden the field for this particular class of machine. After the expenditure of a great deal of time and money in experimenting and in trying the machine under all sorts of conditions, it may be safely announced to the coal mining craft that the Sullivan Electric Chain Machine is certainly worthy of serious consideration, as it possesses many features of merit, exceptional and unique.

The machine itself makes the first or "tight" cut in practically the same manner as other chain machines, except that the feeding is done by means of a chain instead of a rack and pinion. After the first cut is finished the back end of the frame or pan is detached, the feed chain is anchored in the opposite corner of the room, and the machine then is started at cutting sideways across the room, not stopping until the breast is completely undermined. There being no pause in the cutting after the machine has once started across the breast, it is manifest that the machine has greater

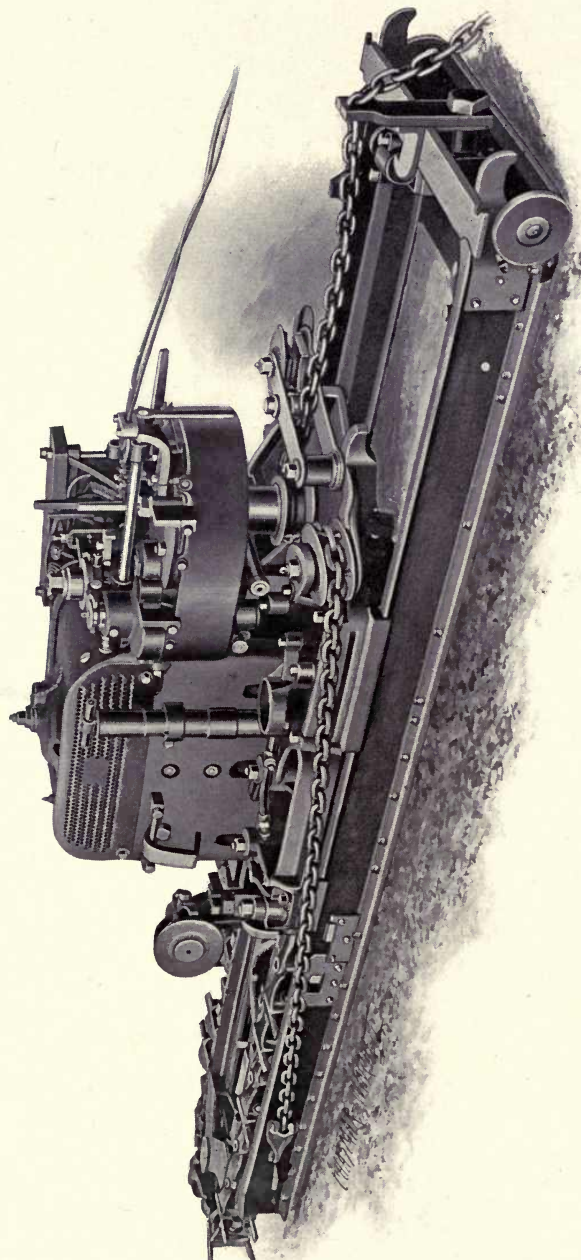

Sullivan Electric Chain Machine, showing position at middle of "tight" or corner cut

efficiency than any other room and pillar machine. As the rear end of the frame or pan is detached, the machine will work in about one-half the space required by the other chain machines between the face and the props, thus it can be used successfully in many

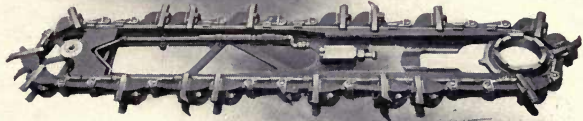

Cutter Bar
and Chain

cases where the roof is in such condition that the long machines cannot be used with safety.

Dispensing with the telescopic frame of the other chain machines makes the Sullivan lighter, and as it is loaded upon and unloaded from the truck by power, moves itself into place and across the face without the use of crow-bars, it is much easier on the men than any other machine of like principle.

Cutting sideways continuously across the face of the room or heading, no "ribs" can possibly be left in the mining, hence the coal is always in a satisfactory condition for blasting. It has been ascertained that the machine will closely follow the line or plane of the feed chain; thus by elevating or depressing the feed chain all irregularities in the bottom may be avoided and quite steep grades climbed. The machine cutting practically on the bottom leaves no bottom coal for the loaders to lift, and, avoiding the irregularities in the floor, reduces the strain upon the machine, at the same time lessening the liability of loading dirty coal, all of which are usually incident to the long chain machines operating in an irregular seam.

From the loader's standpoint the Sullivan Electric Chain Machine is a great improvement over the older makes of chain machines, as the floor is left smooth, the debris has only to be thrown back a short distance and there is no bottom coal to be lifted.

For this machine an entirely new cutter chain has been designed, in which the cutters are set opposite, in pairs, the core or center being broken out by rakers. This arrangement not only results in coarser coal from the cut, but also a

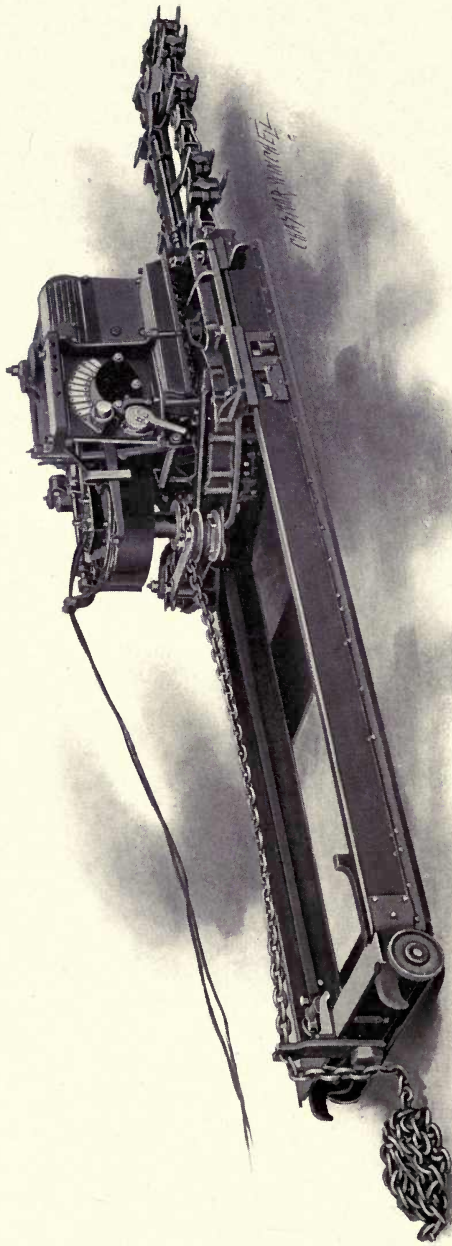

Sullivan Electric Chain Machine, showing position
at completion of "tight" or corner cut

greater economy in the consumption of power than if the bits or cutters were put in alternately or staggered. Furthermore, fewer cutters or bits are used, and as the adjustment of one set-screw fastens two bits, the operation of changing bits is of small moment.

In order to obviate breakage of the cutter chain when sulphur or other hard substances are encountered, a friction clutch is employed which slips when an unusual strain is brought upon the cutter chain. This does away with the safety washers of the old chain machines, which are usually ordered by the barrel.

The electric motor used is a four-pole shunt wound machine of consequent polar type with vertical armature. In the design of this motor special attention has been given to the proper lubrication of the bearings. The armature is of the "iron-clad" type, the coils being "form wound," grouped and embedded in the slots of the armature core. This construction enables the use of ample insulation of the best quality and insures freedom from the aggravating burn-outs so common with the motors of the older makes of chain machines. The commutator is of liberal dimensions, and carbon brushes are employed; the frame is of such shape that falling material cannot enter the motor, while access to the commutator and brushes, as well as ventilation, is afforded by large openings in the sides which are provided with removable perforated covers.

A convenient controller is provided, by means of which the motor may be started gradually and operated continuously at various speeds, and the reverse lever is so arranged that it can be operated only when the armature is at a standstill. The motors are built for 220, 250 and 500 volts direct current and the machine made to undercut 5, 6 or $6\frac{1}{2}$ feet.

In ordering, give height of coal, depth of undercut desired, voltage of current and gauge of mine track.

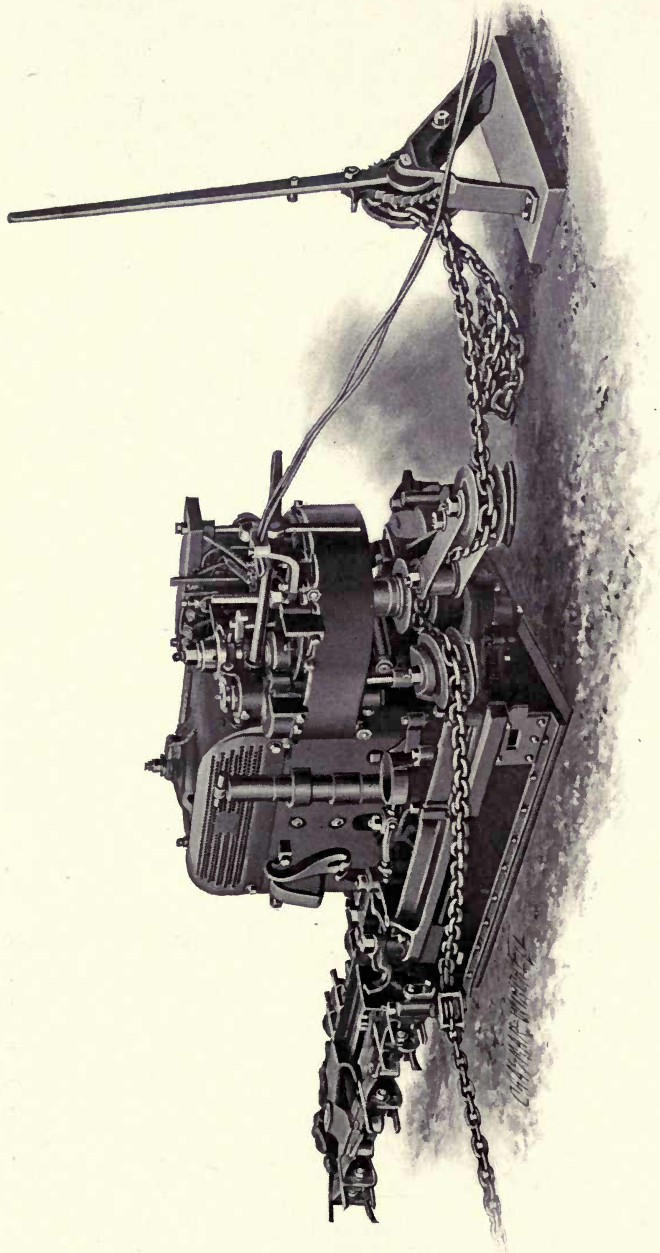

Sullivan Electric Chain Machine, showing "pan" detached and in position at starting of side cut across the face.

The following equipment is furnished with each Sullivan Electric Chain Machine :

1 standard truck for machine	9 extra chain pins
1 reel containing 300 feet duplex waterproof cable	1 pair cutter bit tongs
1 tool box with padlock and two keys	1 punch for driving pins
1 crank for motor	1 swivel hook
1 crank for reel	6 contact buttons
1 hand hammer	4 cable hooks
1 flat file	5 wire nipples
1 round nose chisel	5 feet fuse wire
1 screw driver	8 carbon brushes
1 hand oil can	1 hand tool box
1 12-inch monkey wrench	6 change gears
1 set solid wrenches	1 set gauges for setting bits
24 cutter bits	1 front anchor
4 guide bits	1 back pan anchor
8 raker bits	2 back anchors
3 extra inside chain links	1 take-up rig
3 extra blank chain links	1 slack hoe
3 extra outside chain links	1 scraper
2 extra raker chain links	2 crowbars
4 extra inside clamp bolts	1 jack
4 extra outside clamp bolts	1 skid.
	1 lot waste

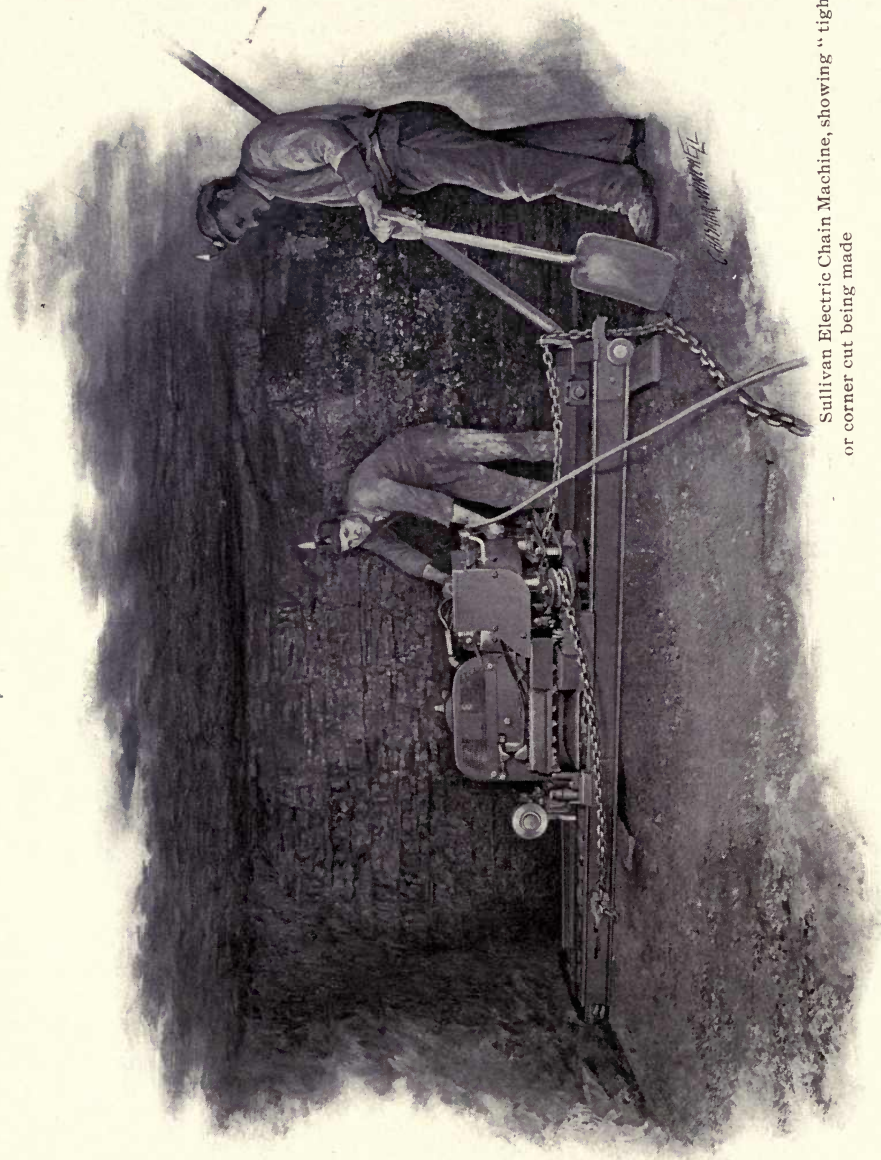

Sullivan Electric Chain Machine, showing "tight" or corner cut being made

List Sullivan Electric Chain Machines

Voltage of Motor	Depth of Undercut feet	Code Word
220	5	<i>Halobato</i>
250	5	<i>Halobessi</i>
500	5	<i>Halobix</i>
220	6	<i>Halobode</i>
250	6	<i>Halocarte</i>
500	6	<i>Halocesa</i>
220	6½	<i>Halocious</i>
250	6½	<i>Halocipp</i>
500	6½	<i>Halocomo</i>



Sullivan Electric Chain Machine cutting across
face of room

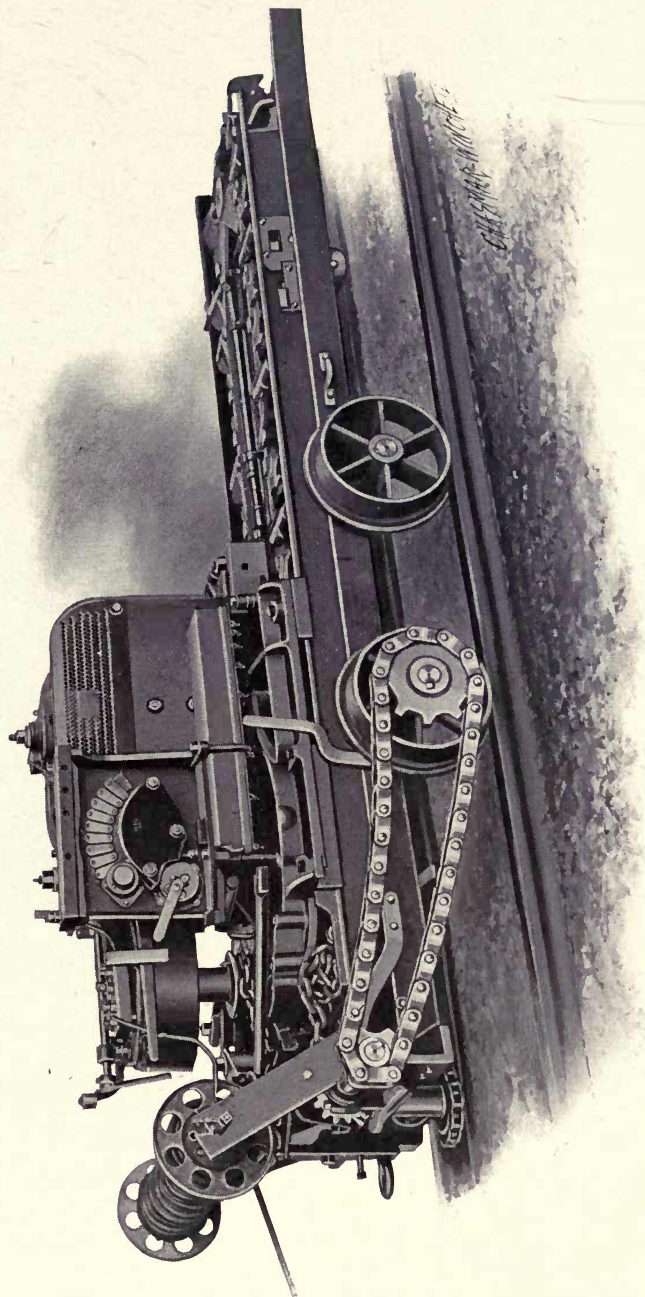

Sullivan Electric Chain Machine on power truck

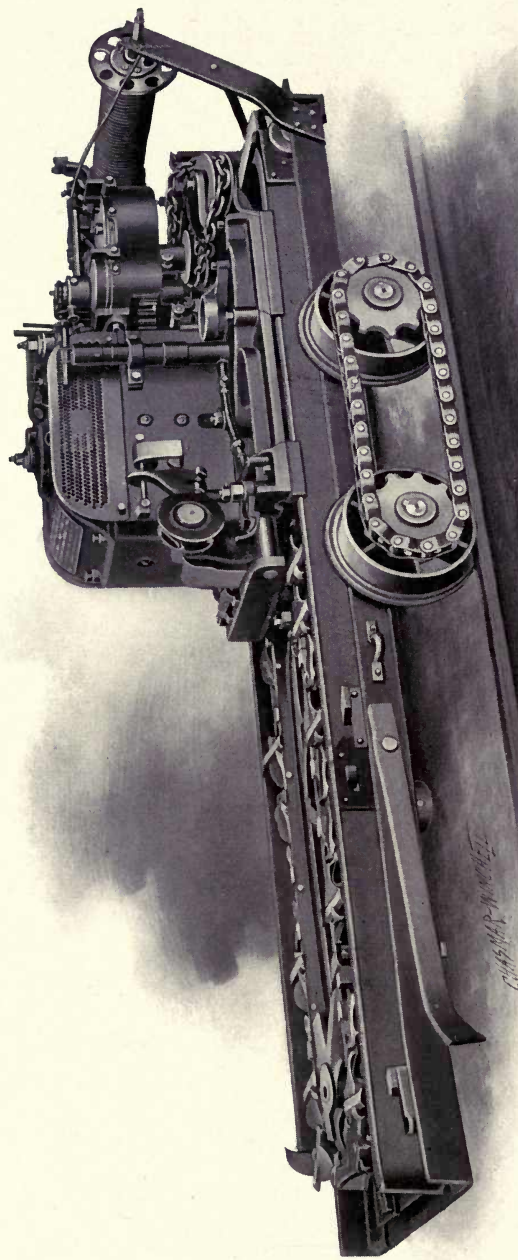

Sullivan Electric Chain Machine on power truck

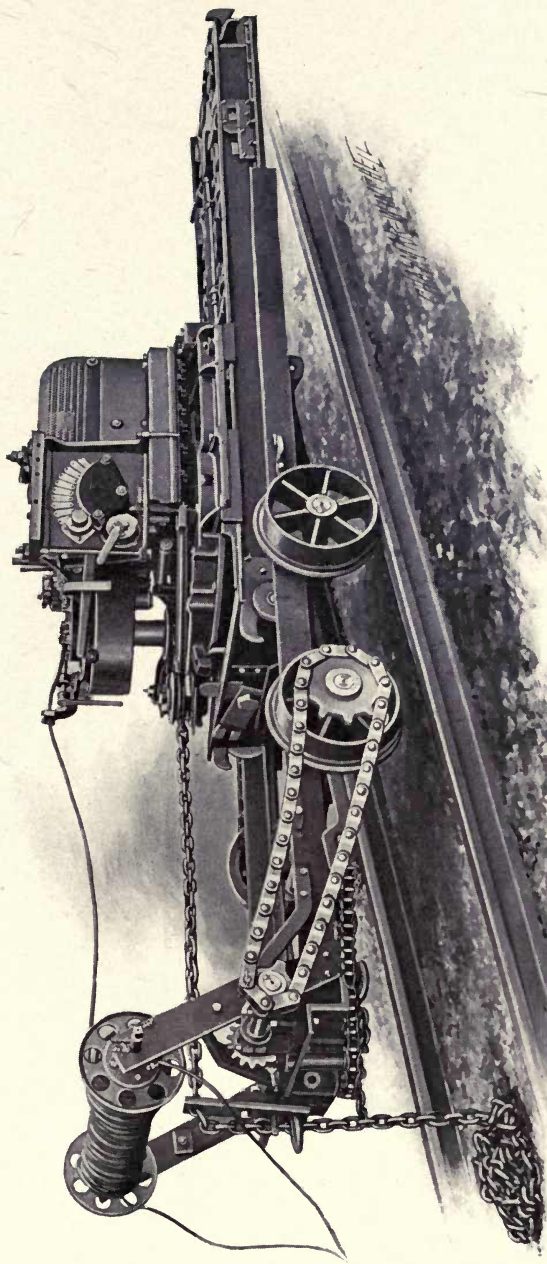

Sullivan Electric Chain Machine loading itself upon power truck, saving the heavy lifts and "bar-ring" necessary with other chain machines.

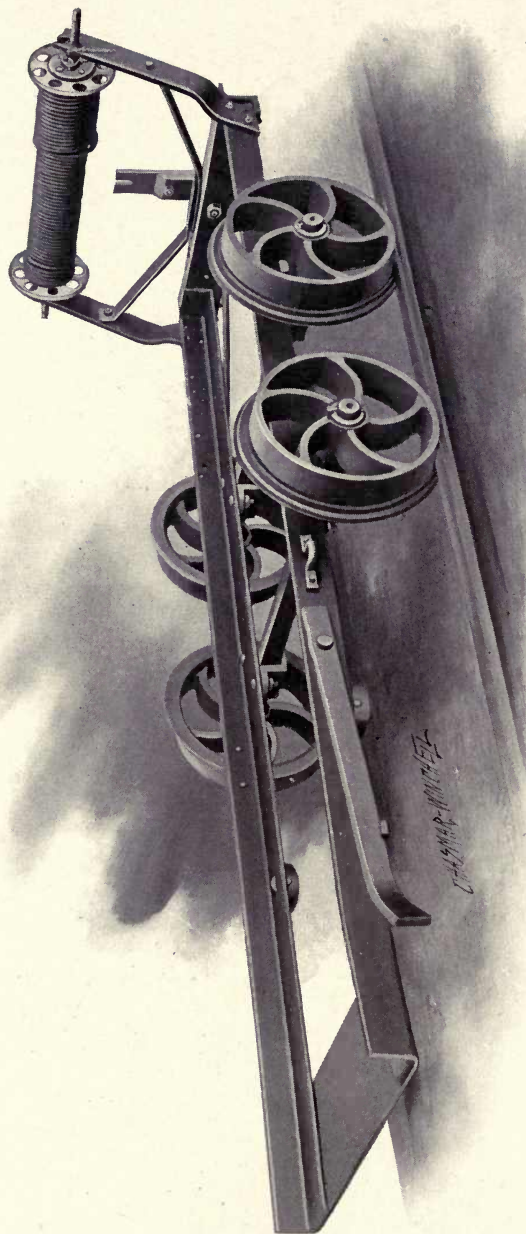

Standard truck for Sullivan Electric Chain Machine.
This truck is regularly furnished in the equipment with
each chain machine.
Code word, *Halocugi*.

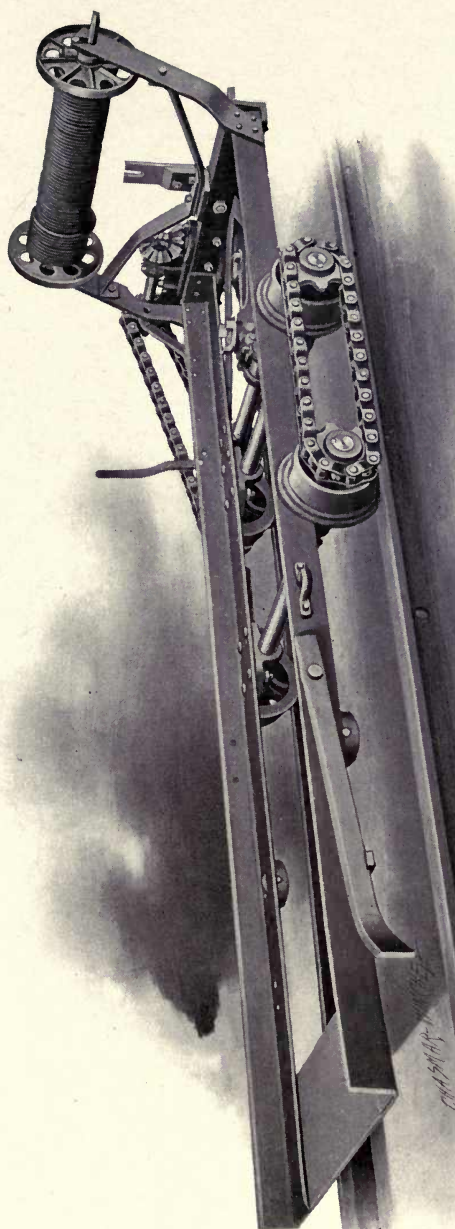

Power truck for Sullivan Electric Chain Machine.
This truck is furnished when desired at an additional cost
to the chain machine.
Code word, *Halocheer*.

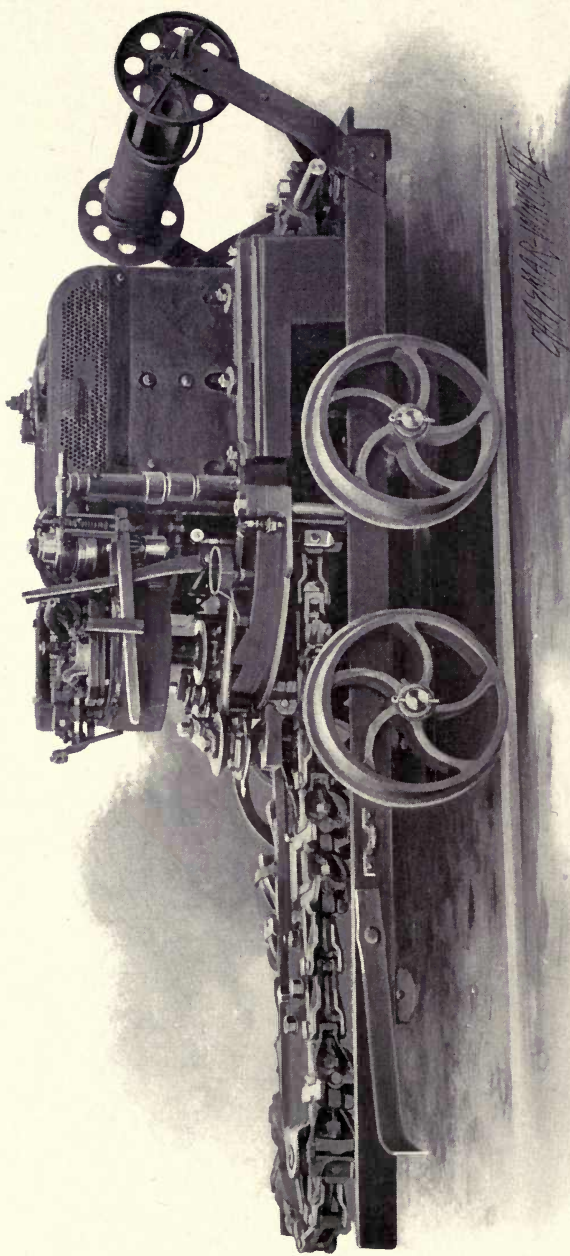

Sullivan Long Wall Machine on truck, with cutter bar in line with machine

The Sullivan Long Wall Machine

For the Mining of Coal

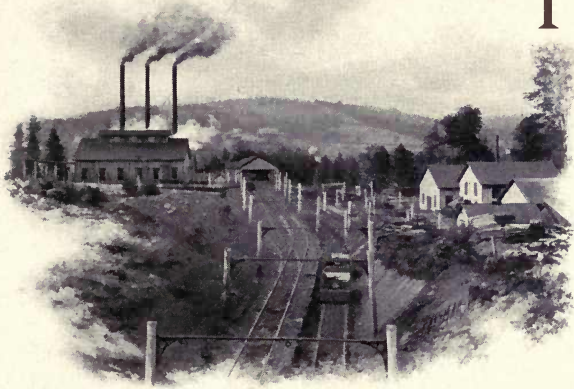

THE long wall system of mining is particularly well adapted to coal cutting machinery, as the machine may travel continuously along the face of the coal and is rarely moved to another portion of the mine; this greatly increases the cutting efficiency, as the time may be utilized

in the performance of work which would otherwise be consumed in moving the machine from place to place in a room and pillar mine.

The long wall system has reached its zenith in Great Britain and in Continental Europe, being, so it is said, more generally followed than the room and pillar system; long wall mining has, however, been little followed in this country, no doubt for especial reasons, but recently a number of new mines have been opened on this system.

To satisfy the growing demand for a long wall mining machine, the Electric Chain Machine illustrated and described in the preceding pages has been modified to successfully meet the new conditions. The machine itself differs slightly from the Electric Chain Machine, the principal difference being that the cutter bar is placed at right angles to the main portion of the machine, and is so arranged that it may be swung in line with the machine when it is desired to load the latter onto a truck in order to move it to some other portion of the mine. The swinging movement of the cutter

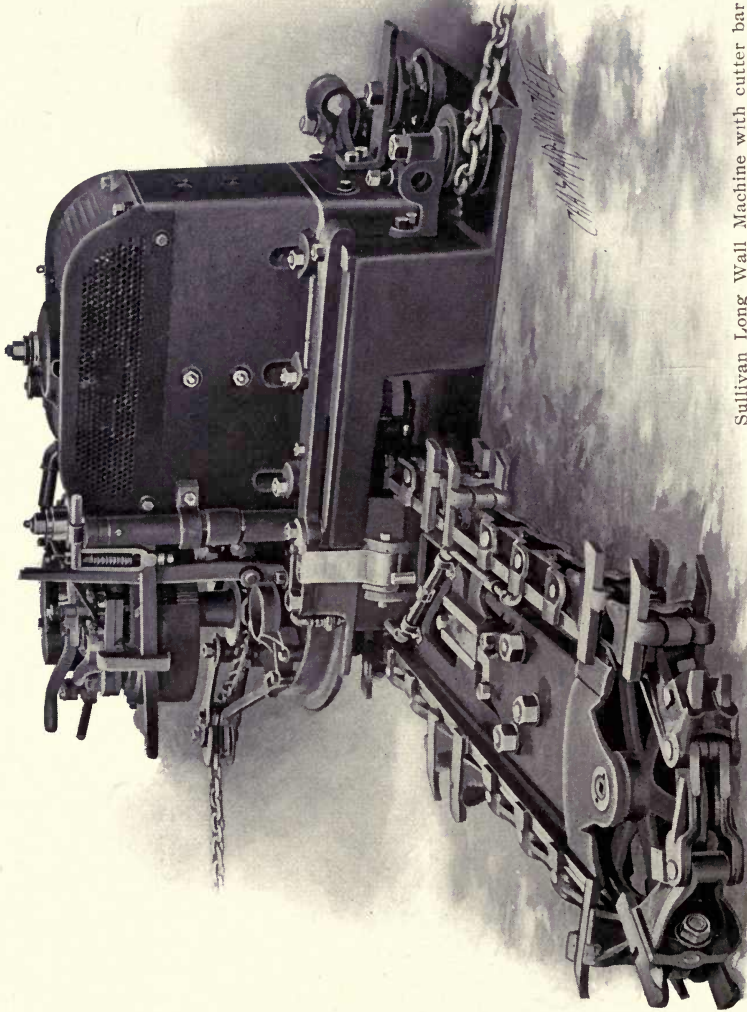

Sullivan Long Wall Machine with cutter bar at right angles to machine

bar may, if desired, also be taken advantage of during the process of changing bits.

As will be noticed from the illustrations, the machine slides along the floor of the mine on a sheet steel shoe, and requires no heavy and cumbersome rails, used with the other makes of long wall machines; it will work in little space both as regards height and distance between face and props. The advance or feed of the machine is effected by a driving sprocket engaging with a chain securely fastened some distance ahead of the machine, and stretched parallel to the face of the coal. As the machine advances, the slack in the chain is taken up by the back chain; in other words, the chain is in one continuous piece, and as the machine advances, the slack is fed out at the rear end, by means of which the machine is always kept up to its work and at the proper angle to the face of the coal. Should it be necessary to alter the angle of the machine with the face of the coal, the tension on the chain may be changed by the ratchet at the back end of the chain and the machine made to assume any desired angle with the face. This machine is driven by electricity, and, with the exception of changes mentioned, otherwise conforms to the Electric Chain Machine. The motors are wound for 220, 250 and 500 volts direct current and the machines are built to undercut up to five feet deep.

In ordering, give height of coal, depth of undercut desired, voltage of current and gauge of mine track.

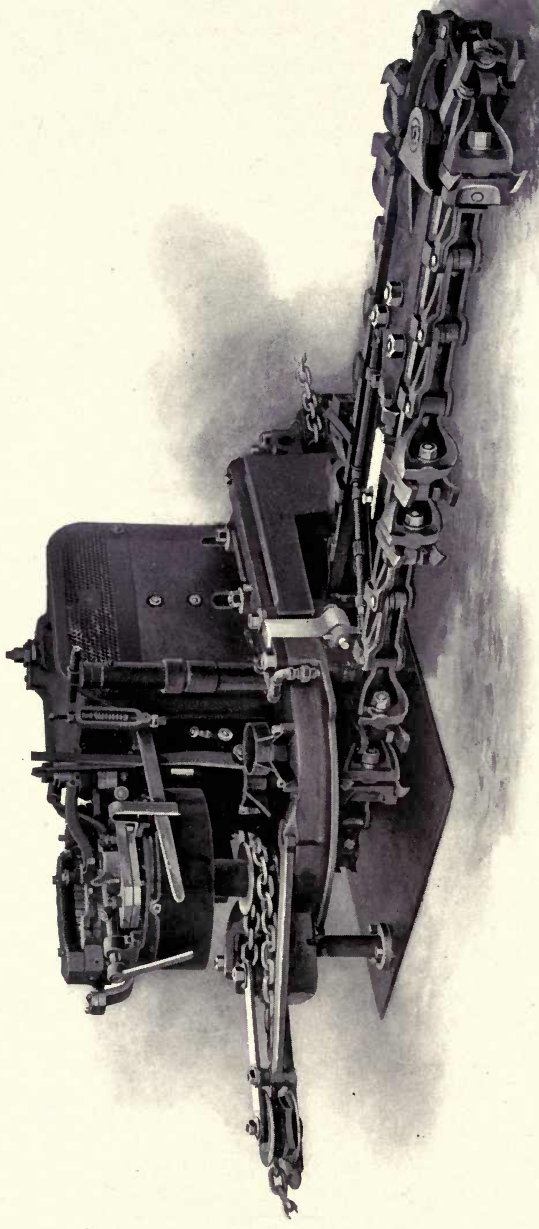

Sullivan Long Wall Machine

List Sullivan Long Wall Machines

Voltage of Motor	Depth of Undercut feet	Code Word
220	3	<i>Halofag</i>
250	3	<i>Halofette</i>
500	3	<i>Halofird</i>
220	3½	<i>Haloform</i>
250	3½	<i>Halofugel</i>
500	3½	<i>Halogada</i>
220	4	<i>Halogaff</i>
250	4	<i>Halogamos</i>
500	4	<i>Halogecon</i>
220	4½	<i>Halogeno</i>
250	4½	<i>Hologida</i>
500	4½	<i>Halogoss</i>
220	5	<i>Haloguter</i>
250	5	<i>Halojade</i>
500	5	<i>Halojepta</i>

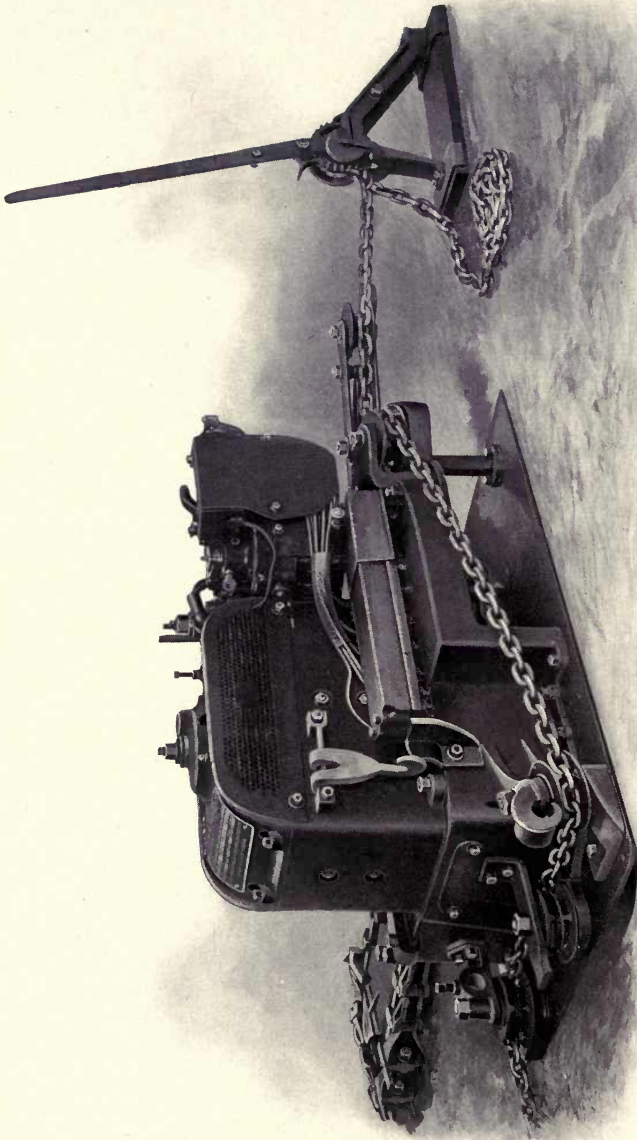

Sullivan Long Wall Machine, showing ratchet for changing tension on feed chain

Code Words Pertaining to Coal Mines

	<i>Code Word</i>
Coal 16 inches in height	<i>Halojion</i>
Coal 18 inches in height	<i>Halojote</i>
Coal 20 inches in height	<i>Halojuno</i>
Coal 22 inches in height	<i>Halokapo</i>
Coal 2 feet 0 inches in height	<i>Halokegan</i>
Coal 2 feet 3 inches in height	<i>Halokicht</i>
Coal 2 feet 6 inches in height	<i>Halokoger</i>
Coal 2 feet 9 inches in height	<i>Halokori</i>
Coal 3 feet 0 inches in height	<i>Halokuero</i>
Coal 3 feet 3 inches in height	<i>Halolatch</i>
Coal 3 feet 6 inches in height	<i>Haloleda</i>
Coal 3 feet 9 inches in height	<i>Haloleif</i>
Coal 4 feet 0 inches in height	<i>Halologic</i>
Coal 4 feet 6 inches in height	<i>Halolubi</i>
Coal 5 feet 0 inches in height	<i>Halomalo</i>
Coal 5 feet 6 inches in height	<i>Halomaras</i>
Coal 6 feet 0 inches in height	<i>Halomesm</i>
Coal 7 feet 0 inches in height	<i>Halometer</i>
Coal 8 feet 0 inches in height	<i>Halomizen</i>
Coal 9 feet 0 inches in height	<i>Halomoki</i>
Coal 10 feet 0 inches in height	<i>Halomug</i>
Coal 11 feet 0 inches in height	<i>Haloogan</i>
Coal 12 feet 0 inches in height	<i>Haloop</i>
Gauge of track 18 inches	<i>Halootax</i>
Gauge of track 19 inches	<i>Haloozero</i>
Gauge of track 20 inches	<i>Halopan</i>
Gauge of track 21 inches	<i>Halopeggi</i>
Gauge of track 22 inches	<i>Halopit</i>
Gauge of track 23 inches	<i>Haloporen</i>
Gauge of track 24 inches	<i>Halopuber</i>

	Code Word
Gauge of track 26 inches	<i>Haloquail</i>
Gauge of track 28 inches	<i>Halokuern</i>
Gauge of track 30 inches	<i>Haloquox</i>
Gauge of track 32 inches	<i>Halorapo</i>
Gauge of track 34 inches	<i>Halorefer</i>
Gauge of track 36 inches	<i>Halorious</i>
Gauge of track 38 inches	<i>Halorfio</i>
Gauge of track 40 inches	<i>Halorgan</i>
Gauge of track 42 inches	<i>Halorhein</i>
Gauge of track 44 inches	<i>Halorian</i>
Gauge of track 46 inches	<i>Halorilla</i>
Gauge of track 48 inches	<i>Halorjah</i>
Mining done in coal	<i>Halorodox</i>
Mining done in clay beneath coal	<i>Haloruato</i>
Mining done in	<i>Halosach</i>
Vein level	<i>Halosein</i>
Pitch of vein 1 degree	<i>Halosell</i>
Pitch of vein 2 degrees	<i>Halosetro</i>
Pitch of vein 3 degrees	<i>Halosisco</i>
Pitch of vein 4 degrees	<i>Halosolio</i>
Pitch of vein 5 degrees	<i>Halosugio</i>
Pitch of vein 6 degrees	<i>Halotage</i>
Pitch of vein 7 degrees	<i>Halotedar</i>
Pitch of vein 8 degrees	<i>Halotesen</i>
Pitch of vein 9 degrees	<i>Halothar</i>
Pitch of vein 10 degrees	<i>Halotilla</i>
Pitch of vein 12 degrees	<i>Halotjam</i>
Pitch of vein 15 degrees	<i>Halotmo</i>
Pitch in favor of load	<i>Halotness</i>
Pitch against load	<i>Halotoro</i>
Pitch irregular	<i>Halotpare</i>
Plant to produce 100 tons per day	<i>Halotque</i>

	Code Word
Plant to produce 150 tons per day	<i>Halosane</i>
Plant to produce 200 tons per day	<i>Halouser</i>
Plant to produce 250 tons per day	<i>Halorat</i>
Plant to produce 300 tons per day	<i>Haloramog</i>
Plant to produce 350 tons per day	<i>Halorester</i>
Plant to produce 400 tons per day	<i>Haloricat</i>
Plant to produce 500 tons per day	<i>Halorotro</i>
Plant to produce 600 tons per day	<i>Halowaca</i>
Plant to produce 800 tons per day	<i>Halowaggo</i>
Plant to produce 1000 tons per day	<i>Halowasi</i>
Plant to produce 1500 tons per day	<i>Haloween</i>
Plant to produce 2000 tons per day	<i>Halowelor</i>
Plant to produce 2500 tons per day	<i>Halowjord</i>
Plant to produce 3000 tons per day	<i>Halowoba</i>
Single shift	<i>Halowousa</i>
Double shift	<i>Halozaka</i>
Mine run coal	<i>Halozeil</i>
Coal over 1¼-inch screen	<i>Haloziera</i>
Coal over 1½-inch screen	<i>Halozolo</i>

Relative Cost of Machine and Hand or Pick Mining

For the purpose of showing the saving in machine mining over pick or hand mining, the following pages contain the official mining scales of the chief coal-producing States of this country. In West Virginia, with few exceptions, and in most of the Southern States, the wage settlement with the miners is based on bulk measurement instead of weight, and as the contents of the mine cars vary with nearly every mine, it is impossible to tabulate the different mining scales in these States.

Where no scale is shown it is customary to allow one-eighth of the pick rate for cutting and scraping with the chain machine, and one-fifth for the pick machine, sixty per cent. of which goes to the cutter and forty per cent. to the scraper, the loader following either of these machines being allowed one-half of the pick rate, with an additional allowance of about three cents per ton if the holes for blasting are drilled by hand.

Official Mining Scales for Coal Mined in Rooms

Showing the Differentials between Pick and Machine Mining for the Year ending March 31, 1903

Under the caption "size of coal" M. R. signifies mine run coal; 1½ in., coal over 1½-in. screen; 1½ in., coal over 1½-in. screen, the figures indicating the space between the bars of the screen.

State	District	Pounds per Ton	Size of Coal	Pick Rate	Machine Rates				Total	
					Cutting and Scraping	Loading	Total	Cutting and Scraping		Loading
Kentucky	Jellico—coal 3 ft. to 3 ft. 6 in. high.	2000	1½ in.	\$0.76	Division of earnings between cutter and loader set.	\$0.07	Division of earnings between cutter and loader set.	\$0.18½	26½	\$0.56
Kentucky	Jellico—coal 3 ft. 6 in. to 4 ft. high.	2000	1½ in.	.71						.51
Kentucky	North Jellico.	2000	1½ in.	.75						.69
Illinois	1st Streator.	2000	M. R.	.85						.74
Illinois	1st Third vein.	2000	M. R.	.76						.69
Illinois	1st Willington.	2000	M. R.	.81						.74
Illinois	1st Bloomington.	2000	M. R.	.71						.64
Illinois	1st Pontiac.	2000	M. R.	.81						.74
Illinois	1st Pontiac, top vein.	2000	M. R.	.85						.74
Illinois	1st Cardiff, long wall.	2000	M. R.	.81						.74
Illinois	2d Danville.	2000	M. R.	.49						.39
Illinois	3d Springfield.	2000	M. R.	.49						.39
Illinois	3d Lincoln and Niantic.	2000	M. R.	.53						.427
Illinois	3d Colfax.	2000	M. R.	.53						.46
Illinois	4th C. & A. R., south of Springfield.	2000	M. R.	.49						.46
Illinois	4th Assumption, long wall.	2000	M. R.	.65½						.42
Illinois	4th Moweaqua.	2000	M. R.	.58						.58½
Illinois	4th Mt. Pulaski.	2000	M. R.	.66						.46
Illinois	4th Decatur.	2000	M. R.	.64						.57
Illinois	5th Glen Carbon.	2000	M. R.	.49						.42
Illinois	5th, coal 5 ft. and under.	2000	M. R.	.54						.47
Illinois	6th Duquoin.	2000	M. R.	.45						.38
Illinois	6th Salem.	2000	M. R.	.50						.43
Illinois	6th Kinnmundy, long wall.	2000	M. R.	.65						.58

State	District	Pounds per Ton	Size of Coal	Pick Rate	Machine Rates						
					Chain Machine		Pick Machine				
					Cutting and Scraping	Loading	Total	Cutting and Scraping	Loading	Total	
Illinois	Mt. Vernon	2000	M. R.	\$0.50		\$0.43					
Illinois	7th Jackson County	2000	M. R.	.45		.38					.38
Illinois	7th Saline County	2000	M. R.	.45		.38					.38
Illinois	7th Williamson County	2000	M. R.	.42		.35					.35
Illinois	8th Fulton and Peoria Counties	2000	M. R.	.76		.69					.69
Illinois	8th Fulton and Peoria Counties, No. 5 vein	2000	M. R.	.56		.49					.49
Illinois	8th Astoria, No. 5 vein	2000	M. R.	.56		.53					.53
Illinois	8th Pekin	2000	M. R.	.60		.58					.58
Illinois	8th Gilchrist	2000	M. R.	.49		.42					.42
Illinois	9th Mt. Olive	2000	M. R.	.54		.47					.47
Illinois	9th, coal 5 ft. and under	2000	M. R.	.80		.58 1/2					.58 1/2
Indiana	Bituminous	2000	1 1/2 in.	.80		.58 1/2					.58 1/2
Indiana	Block	2000	1 1/2 in.	.90		.46					.46
Iowa	1st Mystic, field	2000	1 1/2 in.	.50		.22 1/2					.22 1/2
Iowa	1st Centerville, field	2000	1 1/2 in.	.95		.44					.44
Iowa	1st Shawville	2000	1 1/2 in.	.95		.47					.47
Iowa	2d	2000	1 1/2 in.	.85							
Iowa	3d Jasper County, thick vein	2000	1 1/2 in.	.90							
Iowa	3d Polk County	2000	1 1/2 in.	.63							
Iowa	4th Boone County	2000	1 1/2 in.	1.00							
Iowa	4th Coalville and Kalo	2000	1 1/2 in.	.95							
Maryland	Georges Creek	2240	M. R.	.55							
Michigan	Bay City and Saginaw	2000	1 1/2 in.	.86		.70 1/2					.70 1/2
Michigan	Hocking Valley	2000	1 1/2 in.	.80		.53					.53
Ohio	Belmont, Harrison and Jefferson Counties	2000	1 1/2 in.	.80		.55 1/2					.55 1/2
Ohio	Massillon	2000	1 1/2 in.	.80							
Ohio	Cambridge	2000	1 1/2 in.	.80		.63					.63
Ohio	Tuscarawas County, Lindentree and Magnolia mines	2000	1 1/2 in.	.80		.68					.68
Ohio	Tuscarawas County, Sherrodsville mine	2000	1 1/2 in.	.80		.59 1/2					.59 1/2
Ohio	Wellston	2000	1 1/2 in.	.80		.53					.53
Ohio	Coalton	2000	1 1/2 in.	.80		.58					.58
Pennsylvania	Pittsburg, thin vein	2000	1 1/2 in.	.80		.12 1/2					.12 1/2
Pennsylvania	Pittsburg, thick vein	2000	1 1/2 in.	.80		.45 1/2					.45 1/2
Pennsylvania	Central Pennsylvania	2000	1 1/2 in.	.80		.0657					.0657
Pennsylvania	West Virginia	2240	M. R.	.60		.4423					.4423
West Virginia	Mines on West Virginia Central Railway	2240	M. R.	.50		.30					.30
West Virginia	Drilling holes by hand and blasting same included in the loading rate.	2240	M. R.	.52 1/2		.10					.10
West Virginia	Drilling holes and blasting same, extra by day work.	2240	M. R.	.84		.84					.84

N. B.—Drilling holes by hand and blasting same included in the loading rate.

* Drilling holes and blasting same, extra by day work.

Bituminous Coal Production of the United States

In Net Tons

	1891	1896	1897	1898	1899	1900
Alabama	5,893,770	6,535,283	7,593,416	8,394,275
Alaska	15,232	17,920	Not reported
Arkansas	675,374	856,190	1,305,479	843,554	1,477,945
Colorado	3,512,632	3,112,400	3,361,703	4,076,347	4,776,224	5,344,364
Illinois	15,660,698	19,786,626	20,072,758	18,599,299	24,439,019	25,767,981
Indiana	2,973,474	3,905,779	4,151,169	4,920,743	6,006,523	6,484,086
Indian Territory	1,366,646	1,336,380	1,381,466	1,537,427	1,922,298
Iowa	3,825,495	3,954,028	4,611,865	4,618,842	5,177,479	5,202,939
Kansas	3,054,012	3,406,555	3,852,267	4,467,870
Kentucky	3,602,097	3,887,908	4,607,255	5,328,964
Maryland	4,807,396	4,024,688
Michigan	315,722	624,708	849,475
Missouri	2,331,542	2,665,626	2,688,321	3,025,814	3,540,103
Montana	1,543,445	1,647,882	1,479,803	1,496,451	1,661,775
New Mexico	992,288	1,050,714	1,299,299
North Dakota	78,050	77,246	83,895	98,809	129,883
Ohio	12,868,683	12,875,202	12,718,482	14,516,867	16,500,270	18,988,150
Pennsylvania	42,788,490	49,557,453	54,417,974	65,165,133	74,150,175	79,842,326
Tennessee	2,888,849	3,022,896	3,330,659	3,708,562
Texas	639,341	686,734
Utah	418,627	521,560
Virginia	1,528,302	1,815,274	2,105,791	2,398,754
Washington	1,195,504	2,029,881	2,474,093
West Virginia	9,220,665	12,876,296	14,248,159	16,700,999	19,252,995	22,647,207
Wyoming	2,327,841	2,229,624	2,597,886	2,863,812	3,837,392	4,014,602
Total	98,177,978	115,921,828	139,866,071	155,963,666	191,144,218	209,864,639

Bituminous Coal Mined by Machines in the United States In Net Tons

	1801	1806	1807	1808	1809	1900
Alabama.....	294,384	298,170	260,444	370,150
Alaska.....	15,232	17,920	Not reported
Arkansas.....	21,094	87,532	152,192	146,899	219,085
Colorado.....	284,646	318,172	352,400	225,646	527,115	756,025
Illinois.....	3,027,305	3,871,410	3,946,257	3,415,635	6,085,312	5,083,594
Indiana.....	212,830	964,378	1,023,861	1,414,342	1,713,125	1,774,045
Indian Territory.....	191,585	263,811	274,370	276,180	239,424
Iowa.....	41,540	84,556	181,209	218,852	124,721	132,757
Kansas.....	4,500	11,722	40,271	46,164
Kentucky.....	1,299,436	1,366,676	1,625,809	2,339,944
Maryland.....	16,545	138,014
Michigan.....	1,456	64,055	191,577
Missouri.....	47,827	59,692	52,864	55,154	110,036
Montana.....	579,414	720,345	681,613	843,710	1,045,115
New Mexico.....	163,849	260,773	112,000
North Dakota.....	15,000	20,000	65,030	38,066	33,965
Ohio.....	1,654,081	3,368,349	3,843,345	5,191,375	6,822,524	8,835,743
Pennsylvania.....	431,440	6,092,644	8,925,293	16,512,480	22,000,722	26,867,053
Tennessee.....	47,207	152,002	208,033	176,872
Texas.....	11,750	15,340
Utah.....	760
Virginia.....	323,649	244,170	265,000	231,269
Washington.....	3,920	14,640	10,000
West Virginia.....	205,784	430,944	673,523	1,323,929	1,881,125	3,418,377
Wyoming.....	354,106	419,647	555,526	631,431	693,712	653,314
Total.....	6,211,732	16,424,932	22,649,220	32,413,144	43,963,933	52,790,523

Bituminous Coal Mined by Machines in the United States

	NUMBER OF MACHINES IN USE					
	1891	1896	1897	1898	1899	1900
Alabama	45	37	53	54
Alaska	6	6	Not	16
Arkansas	14	15	21	reported
Colorado	20	34	37	43	63	90
Illinois	241	307	320	392	440	430
Indiana	47	186	174	233	247	254
Indian Territory	56	54	75	74	58
Iowa	9	45	49	56	41	40
Kansas	1	2	3	3
Kentucky	162	158	189	239
Maryland	8	10
Michigan	7	25	33
Missouri	4	3	4	9	15
Montana	62	61	62	75	81
New Mexico	29	14	21
North Dakota	2	7	5	7
Ohio	114	209	224	245	278	341
Pennsylvania	72	454	690	1,085	1,343	1,786
Tennessee	8	19	22	18
Texas	5	5
Utah	1
Virginia	8	8	9
Washington	3	2	2
West Virginia	8	25	47	86	154	327
Wyoming	34	39	45	48	56	69
Total.....	545	1,446	1,956	2,622	3,125	3,907

Bituminous Coal Production of the United States

Percentage of Total Product Mined by Machines

	1891	1896	1897	1898	1899	1900
Alabama	4.99	4.56	3.43	4.41
Alaska	100.00	100.00	Not reported	reported
Arkansas	3.12	10.22	12.63	17.41	14.82
Colorado	8.10	10.22	10.48	5.54	11.03	14.42
Illinois	19.83	19.57	19.66	18.86	24.90	19.73
Indiana	7.16	24.69	24.65	28.74	28.52	27.36
Indian Territory	14.02	19.74	19.86	17.96	12.46
Iowa	1.09	2.14	3.93	4.74	2.21	2.55
Kansas15	.84	1.04	1.03
Kentucky	36.07	35.15	35.29	43.91
Maryland84	3.43
Michigan46	10.20	22.55
Missouri	2.56	2.24	1.97	1.80	3.11
Montana	37.54	43.71	46.06	56.38	62.89
New Mexico	16.51	24.81	8.62
North Dakota	19.22	25.89	77.51	38.52	26.15
Ohio	12.85	26.16	31.51	35.76	41.35	46.53
Pennsylvania	1.01	12.29	16.40	25.34	29.67	33.65
Tennessee	1.63	5.03	6.04	4.77
Texas	1.84	2.23
Utah18
Virginia	21.18	13.45	23.06	9.66
Washington3372	.40
West Virginia	2.23	3.35	4.73	7.93	9.27	15.09
Wyoming	15.21	18.82	21.38	22.05	18.07	16.27
Average	6.66	14.17	16.19	20.39	23.00	25.15

Approximate Analyses and Heating Values of American Coals

From "The Coal and Metal Miners' Pocket Book"

Coal	Moisture	Volatile Matter	Fixed Carbon	Ash	Sulphur	Heating Value per lb. Coal	B. T. U.	Volatile Matter per cent. of Combustible	Fixed Carbon per cent. of Combustible	Heating Value per lb. Combustible	Theoretical Evaporation from and at 212° per lb.
Anthracite											
Northern Coal Field.....	3.42	4.38	83.27	8.30	.73	13,160	13,160	5.90	95.00	14,900	15.42
East Middle Coal Field.....	3.71	3.08	86.40	6.22	.58	13,420	13,420	8.44	96.56	14,900	15.42
West Middle Coal Field.....	3.16	2.72	81.59	10.65	.50	12,840	12,840	4.36	95.64	14,900	15.42
Southern Coal Field.....	3.09	4.28	83.81	8.18	.64	13,220	13,220	4.85	95.15	14,900	15.42
Semi-Anthracite											
Loyalsock Field.....	1.30	8.10	83.84	6.23	1.63	13,920	13,920	8.86	91.14	15,500	16.05
Bernice Basin.....	.65	9.40	83.69	5.34	.91	13,700	13,700	10.36	89.02	15,500	16.05
Semi-Bituminous											
Broad Top, Pa.....	.79	15.61	77.30	5.40	.90	14,820	14,820	17.60	82.40	15,800	16.36
Clearfield County, Pa.....	.76	22.52	71.82	3.99	.91	14,950	14,950	24.60	75.40	15,700	16.25
Cambridia County, Pa.....	.94	19.20	71.12	7.04	1.70	14,450	14,450	22.71	77.29	15,700	16.25
Somerset County, Pa.....	1.58	16.42	71.51	8.62	1.87	14,200	14,200	20.87	79.63	15,800	16.36
Cumberland, Md.....	1.09	17.30	73.12	7.75	1.74	14,400	14,400	19.79	80.21	15,800	16.36
Pocahontas, Va.....	1.00	21.00	74.39	3.03	.58	15,070	15,070	22.50	77.50	15,700	16.25
New River, W. Va.....	.85	17.88	77.64	3.36	.27	15,220	15,220	18.35	81.05	15,800	16.36
Bituminous											
Connellsville, Pa.....	1.26	30.12	59.61	8.23	.78	14,050	14,050	34.03	65.97	15,300	15.84
Youghiogheny, Pa.....	1.03	36.50	59.05	8.23	.81	14,450	14,450	38.73	61.27	15,300	15.84
Pittsburg, Pa.....	1.37	35.90	52.21	8.02	1.80	13,410	13,410	41.61	58.39	14,800	15.32
Jefferson County, Pa.....	1.21	32.53	60.99	4.27	1.00	14,370	14,370	35.47	64.53	15,200	15.74
Middle Kittanning Seam, Penna.....	1.81	35.33	53.70	7.18	1.98	13,200	13,200	40.27	59.73	14,500	15.02
Upper Freeport Seam, Penna. and Ohio.....	1.93	35.30	50.19	9.10	2.89	13,170	13,170	43.59	56.41	14,800	15.32
Thacker, W. Va.....	1.38	35.04	56.03	6.27	1.28	14,040	14,040	39.33	60.67	15,200	15.74
Jackson County, Ohio.....	3.83	32.07	57.60	6.50	13,090	13,090	33.76	64.24	14,600	15.11
Brier Hill, Ohio.....	4.80	34.60	56.30	4.30	1.56	13,010	13,010	38.20	61.80	14,800	14.80
Hocking Valley, Ohio.....	6.59	34.97	48.85	8.00	1.56	12,130	12,130	42.81	57.19	14,200	14.70
Vanderpool, Ky.....	4.00	34.10	54.60	7.30	1.35	12,770	12,770	38.50	61.50	14,400	14.91
Muhlenberg County, Ky.....	4.33	33.65	55.50	4.95	1.57	13,060	13,060	38.86	61.14	14,400	14.91
Scott County, Tenn.....	1.26	34.44	59.17	8.62	1.80	13,700	13,700	37.63	65.83	15,100	15.63
Jefferson County, Ala.....	1.55	34.44	59.77	2.62	1.42	13,770	13,770	37.07	62.37	14,400	14.91
Big Muddy, Ill.....	7.50	30.70	53.80	8.00	12,420	12,420	36.30	63.70	14,700	15.23
Mt. Olive, Ill.....	11.00	35.65	37.10	13.00	10,490	10,490	47.00	53.00	13,800	14.23
Streator, Ill.....	12.00	33.30	40.70	14.00	10,580	10,580	45.00	55.00	14,300	14.80
Missouri.....	6.44	37.57	47.94	8.05	12,230	12,230	43.94	56.06	14,300	14.80
Lignite and Lignite Coals											
Iowa.....	8.45	37.00	35.60	18.36	8,790	8,790	51.03	48.97	12,000	12.42
Wyoming.....	8.19	44.82	41.82	11.26	10,380	10,380	43.07	51.43	12,900	13.85
Utah.....	9.20	41.97	3.20	3.20	1.18	11,030	11,030	48.00	51.40	12,600	13.84
Oregon Lignite.....	15.25	42.98	33.32	7.11	1.66	8,540	8,540	54.35	45.05	11,000	11.30

Average Prices per Net Ton for Coal at the Mines since 1886

	1886	1887	1888	1889	1890	1891	1892	1893	1894	1895	1896	1897	1898	1899	1900
Alabama.....	\$1.43	\$1.30	\$1.15	\$1.11	\$1.08	\$1.07	\$1.05	\$0.99	\$0.98	\$0.90	\$0.90	\$0.88	\$0.75	\$1.17	\$1.09
Arkansas.....	1.60	1.42	1.20	1.20	1.20	1.19	1.24	1.34	1.32	1.25	1.11	1.06	1.03	1.17	1.14
California.....	3.00	3.00	4.00	2.85	2.56	2.20	2.46	2.31	2.31	2.33	2.35	2.55	2.53	2.68	3.05
Colorado.....	2.35	2.20	2.20	1.51	1.40	1.37	1.62	1.24	1.24	1.20	1.16	1.17	1.15	1.12	1.12
Georgia.....	1.50	1.50	1.50	1.50	1.04	1.50	.99	.98	.85	.83	.70	.81	.81	1.00	1.17
Idaho.....	1.11	1.00	1.12	.97	.98	.91	.91	.89	.89	.80	.80	3.33	2.57	5.00	5.00
Illinois.....	1.15	1.24	1.40	1.02	.98	1.03	1.08	1.07	1.06	.91	.84	.78	.85	1.04	1.04
Indiana.....	1.60	1.87	1.88	1.76	1.82	1.74	1.71	1.70	1.59	1.48	1.40	1.34	1.32	.88	1.05
Indian Territory.....	1.25	1.34	1.30	1.33	1.24	1.27	1.32	1.30	1.26	1.20	1.17	1.13	1.14	1.43	1.38
Iowa.....	1.20	1.40	1.50	1.48	1.30	1.31	1.31½	1.27	1.23	1.20	1.15	1.18	1.09	1.16	1.22
Kansas.....	1.15	1.15	1.20	.99	.92	.93	.93	.86	.88	.86	.78	.79	.79	.79	.92
Kentucky.....	.95	.95	.86	.86	.86	.81	.80	.88	.77	.81	.80	.76	.76	.76	.98
Maryland.....	1.50	1.50	1.62	1.71	1.90	1.66	1.56	1.79	1.47	1.60	1.62	1.46	1.47	1.39	1.48
Michigan.....	1.30	1.34	1.24	1.36	1.24	1.23	1.23	1.23	1.17	1.12	1.08	1.08	1.07	1.20	1.21
Missouri.....	3.50	3.50	2.42	2.42	2.42	2.27	2.36	1.90	2.04	1.80	1.47	1.76	1.57	1.57	1.63
Montana.....	3.00	3.00	3.00	1.79	1.34	1.68	1.62	1.47	3.15	1.49	1.49	1.38	1.35	1.39	1.37
Nevada.....	3.00	3.00	3.00	1.79	1.74	1.93	1.44	1.47	1.57	1.66	1.50	1.34	1.25	1.30	1.32
New Mexico.....	1.50	1.50	3.50	1.43	1.40	1.40	.96	1.13	1.12	1.07	1.09	1.08	1.11	1.19	1.22
North Carolina.....	.95	.98	.98	.98	.94	.94	.94	.92	.83	.83	.78	.83	.85	.87	1.02
Ohio.....	2.50	2.80	3.00	2.89	2.89	3.00	4.20	3.57	3.87	3.35	2.90	3.00	3.65	3.00	3.74
Oregon.....	1.80	1.80	1.05	.77	.84	.87	.84	.80	.74	.72	.71	.69	.67	.76	.97
Pennsylvania bituminous.....	1.15	1.30	1.05	1.21	1.10	1.11	1.13	1.08	.97	.93	.86	.81	.77	.88	1.14
Tennessee.....	1.85	2.00	2.03	2.66	2.53	2.40	2.32	2.28	2.32	1.88	1.65	1.52	1.66	1.51	1.63
Texas.....	2.00	2.00	2.00	1.50	1.74	1.80	1.48	1.48	1.40	1.31	1.20	1.19	1.27	1.37	1.25
Utah.....	2.00	2.00	2.00	.93	.75	.83	.86	.84	.76	.63	.68	.67	.59	.72	1.20
Virginia.....	2.25	2.00	3.00	2.82	2.71	2.31	2.28	2.31	2.33	2.16	2.00	1.94	1.78	1.78	1.90
Washington.....	.94	.85	1.10	.84	.84	.80	.77	.73	.73	.68	.65	.63	.61	.63	.81
West Virginia.....	3.00	3.00	3.00	1.26	1.70	1.53	1.27	1.35	1.31	1.33	1.31	1.21	1.28	1.24	1.36
Wyoming.....	3.00	3.00	3.00	1.00	.99	.99	.99	.96	.91	.86	.83	.81	.80	.87	1.04
Total bituminous.....	21.06	21.19	21.00	1.00	.99	.99	.99	.96	.91	.86	.83	.81	.80	.87	1.04
Pennsylvania anthracite.....	22.01	22.01	21.93	1.44	1.43	1.46	1.57	1.59	1.52	1.41	1.50	1.51	1.41	1.46	1.49
General average.....	21.30	21.45	21.42	1.13	1.12	1.13	1.16	1.14	1.09	1.02	1.02	.99	.95	1.01	1.14

a Exclusive of colliery consumption. *b* Includes Alaska. *c* Includes Nebraska.



AIR COMPRESSORS
DIAMOND CORE
DRILLS
ROCK DRILLS

SMC

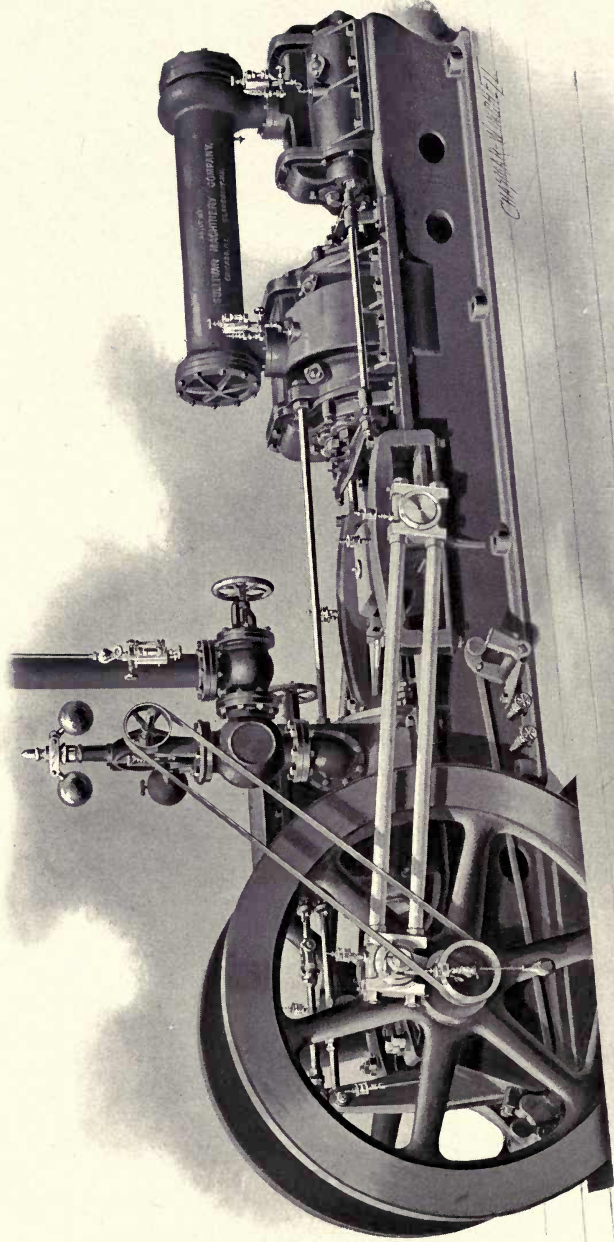

Sullivan Straight Line Air Compressor, Class WB.
Simple steam and compound air cylinders

The Sullivan Straight Line Air Compressor

This Type Designated as Class W B

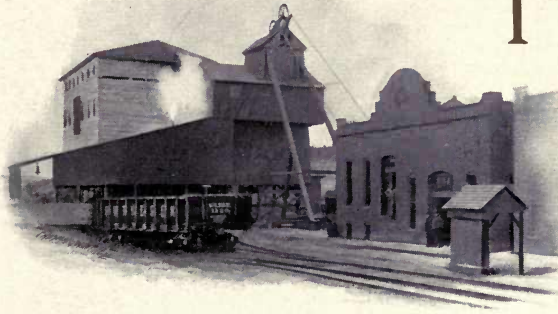

THIS compressor is of the familiar horizontal straight line type, and is equipped with a simple steam cylinder and compound air cylinders, all self-contained and on a strong cast iron bed plate.

The steam cylinder is fitted with the Meyer adjustable cut-off valve gear, which may be adjusted at will when the machine is running by turning an easily accessible hand wheel, the position of the cut-off being indicated by a pointer. To start the compressor slowly, it is usual to set the cut-off so that the pressure is carried nearly throughout the full stroke; the fly-wheels are then turned by the hand-starting device, and the throttle gradually opened until the machine is under full motion, when the cut-off is run back to the point desired. The steam cylinder is thoroughly covered with a suitable non-conductor of heat, which is enclosed in a neat sheet steel lagging, and little steam energy is lost by radiation.

The air is compressed in two stages, with an intercooler placed between the two air cylinders; the positions of the air cylinders being the reverse of those found in most machines of this type. The high pressure cylinder is placed on the extreme end of the frame, the low pressure cylinder between it and the steam cylinder. This arrangement offers several advantages; for instance, the large piston rod passes through the large cylinder and the small piston rod through the small cylinder. With the small rod passing through the high

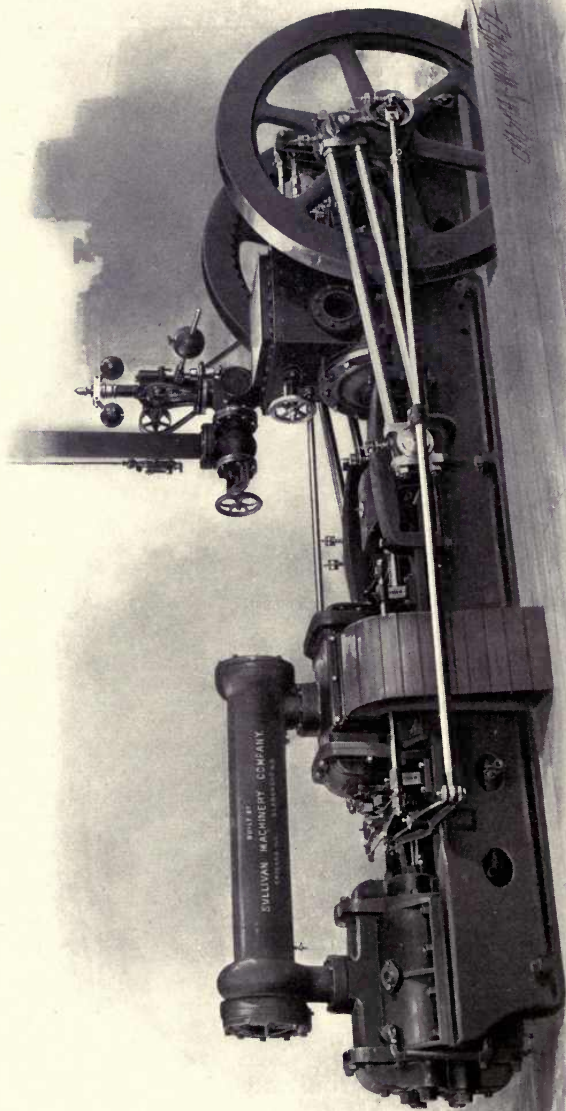

Sullivan Straight Line Air Compressor. Air inlet side. Class WB. Simple steam and compound air cylinders

pressure cylinder head, larger valves may be used in this head, as there is more space left between the rod and the bore of the cylinder. Further, there is but one stuffing box exposed to high pressure instead of two. It allows the air discharge pipe to be led away from the machine at the extreme end, doing away with the necessity of cutting out a passage through the foundation for the accommodation of this pipe, which would result in structural weakness at that point.

The fly-wheels are placed at the other extreme end of the frame, rendering all parts of the machine more accessible than if the fly-wheels were placed between the steam and high pressure air cylinders.

The inlet valves of the low pressure air cylinder are mechanically and noiselessly operated, and being of liberal area, insure the cylinder filling completely, even when the compressor is run at great speed.

Each compressor is provided with a combined speed and pressure regulator, perfectly governing all variations in speed and pressure. These machines are very carefully and intelligently designed, thus run in better balance than other compressors of similar type, and as they are constructed of the best materials obtainable, show a remarkable freedom from breakage and wear.

If interested in air compressors, send for the special catalogue on the subject.

General Dimensions and Weights

Steam Driven Straight Line Compressors, Class WB. Simple Steam and Compound Air Cylinders

Steam Cylinder	Low Pressure Air Cylinder	High Pressure Air Cylinder	Stroke	Capacity cubic feet of free air		Horse Power	Revolutions per Minute	Dimensions			Piping				Foundations Bolts	Fly Wheel		Weight of Frame	Total Weight	Code Word	
				Per Revolution	Per Minute			Length	Width		Height	Air Outlet	Steam	Exhaust		Jacket	Diameter Inches				Weight of Wheel and Shaft
									ft. in.	ft. in.											
12	12	7½	14	1.81	290	50	160	14	4	4	0	3	4	¾	¾	50	1900	2000	9100	Kajuror	
14	14	9	16	2.84	427	70	150	15	6	4	5	3½	4	1	1	56	2525	2400	13000	Kajutt	
14	16	10	16	3.72	558	75	150	16	2	5	5	4	4	1	1	60	3480	2850	15300	Kajep	
16	16	10	16	3.72	558	80	150	16	2	5	6	4	5	1	1	60	3480	2850	15600	Kajol	
18	20	12½	20	7.27	909	125	125	18	11	5	10	6	4	5	1½	70	6000	5300	24000	Kajemk	
20	20	12½	20	7.27	909	140	125	18	11	5	10	6	5	6	1½	70	6000	5300	25000	Kajarl	
20	22	14	24	10.54	1160	160	110	21	9	6	5	7	6	6	1½	78	7800	8400	33500	Kajess	
22	22	14	24	10.54	1160	180	110	21	9	6	5	6	6	6	1½	78	7800	8400	35000	Kajich	
22	24	14½	24	12.54	1380	220	110	21	9	6	6	6	6	6	1½	78	7800	8400	36500	Kajappa	
24	26	16½	30	18.43	1659	270	90	28	0	6	11	8	6	8	1½	96	13000	11000	43500	Kajero	

Detailed Description of the Sullivan Straight Line Air Compressor

This Type Designated as Class W B

THE frame is a heavy box-shaped casting, strongly ribbed and provided with a solid bottom under the steam end for collecting oil and drippings from the steam cylinder, crosshead, guides and steam valve gear; the bottom contains an opening for draining. The top of the frame is made level with the center line of the piston rods, which prevents the bending strains when the centers of the piston rods are above the top of the frame.

Frame

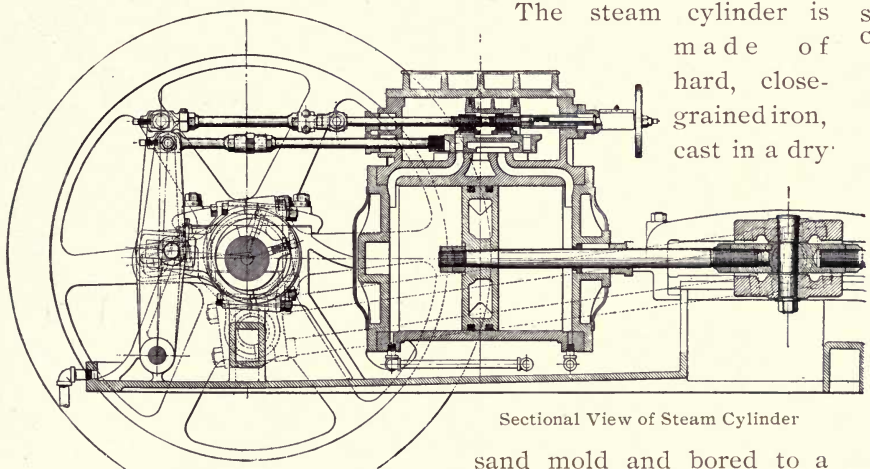

Steam
Cylinder

The steam cylinder is made of hard, close-grained iron, cast in a dry

Sectional View of Steam Cylinder

sand mold and bored to a true circle; all ports and passages for live and exhaust steam are of ample size to give a minimum frictional resistance. The steam distribution is regulated by a Meyer adjustable valve gear, having a wide range of action, the adjustment being easily and quickly made by a hand wheel, even when the machine is in motion. The cylinder drain cocks are of a special pattern and can be opened or closed like an ordinary globe valve, but which will automatically open under an excess of pressure due to water in the cylinder.

Sectional
View of Air
Cylinders and
Intercooler

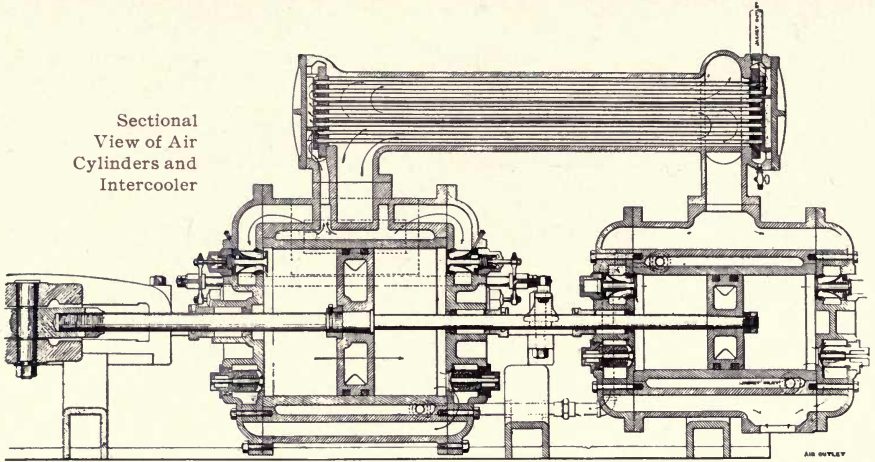

Air
Cylinders

The air cylinders are made of hard, close-grained iron, cast in a dry sand mold, the water jacket being formed by a separate lining forced into the main cylinder. Cylinders cast in one piece, with the water jacket space "cored" out, usually contain shrinkage strains, which are avoided by inserting the separate lining to form the jacket space. Openings are provided for draining the jackets and for washing them out.

Intercooler

The intercooler is a casting mounted upon the two air cylinders and is provided with a suitable number of copper tubes through which the cooling water circulates. The tube ends are made tight by suitable packing, held in place by brass ferules. The ferules are not screwed in, but are forced against the packing by means of brass binder plates held in place by the outside head. Instead of the air passing once through the intercooler, as is the usual practice, it is compelled, by means of suitable baffling plates, to traverse it three times before arriving at the high pressure cylinder.



Intercooler

Through this arrangement the air is brought into more intimate contact with the cooling surfaces, and is given a longer time in which to reduce its temperature. The jacket water first passes through the low pressure cylinder, and thence traverses three times the intercooler tubes, and leaves the machine at the top of the intercooler shell. By this system of circulation, all danger is avoided of the accumulation of air in the water spaces. As nearly all the heat due to compression is absorbed in the intercooler, the rise in temperature of the circulating water in passing through the cylinder jackets before its arrival at the intercooler is insignificant.

The inlet valves on the low pressure air cylinder are mechanically operated by means of a suitably formed cam, rigidly attached to the crank pin, and giving to cast steel yokes, to which the outer ends of the valve spindles are joined, an intermittent reciprocating motion. The action of this mechanism is to apply spring pressure to open the valve immediately at the beginning of the stroke, and to close the valve immediately at the end of the stroke, while in the intervening time between opening and closing, the valves remain stationary. All parts of this mechanism are made as light as possible consistent with proper strength, to reduce the effect of momentum and to minimize wear on the cam and roll; the yokes are easily removable by loosening two nuts on the yoke-rods and quick

Air Valve Gear

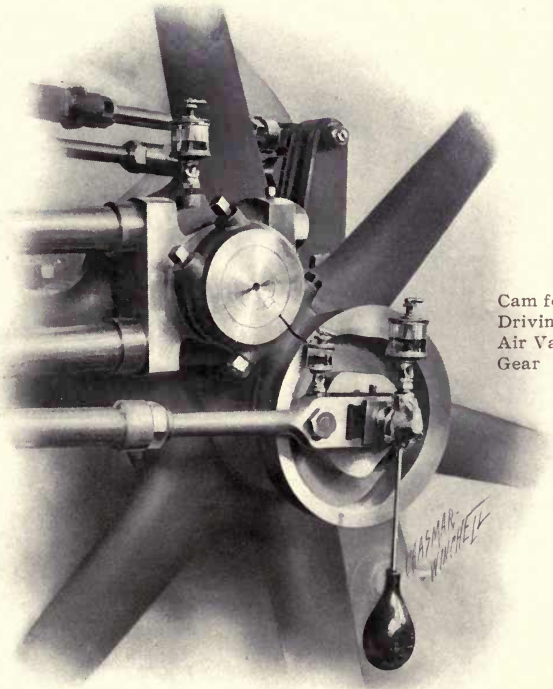

Cam for Driving Air Valve Gear

access to the valves is thus obtained.

Inlet Valves
on Low
Pressure Air
Cylinder

The inlet valves on the low pressure air cylinder are made of the best selected forged steel, with the stems drilled out to reduce weight, the cages for guiding the valves being made in halves and of a hard composition. The valves and seats are accurately

fitted and ground together, the seat being made of a ring of hard composition. The inner ends of the valves are made in such a form that the shock produced by sudden closing is widely distributed through the metal at the junction of the head and the stem. In poppet valves, as commonly constructed, breakage at this point is largely due to the heavy, solid stems, the momentum of which, at the instant of closing, produces strains which cause crystallization and eventually rupture occurs. To guard against the danger of the valve being drawn into the cylinder in the event of breakage, guard plates are often placed on the inner side of the cylinder head. This arrangement necessitates large pockets for the valves to work in, and these pockets add greatly to the clearance. By the peculiar construction of the valves in the Sullivan compressor, the guard plates and their accompanying evil of large clearance spaces are entirely done away with. The passages through the cages of the

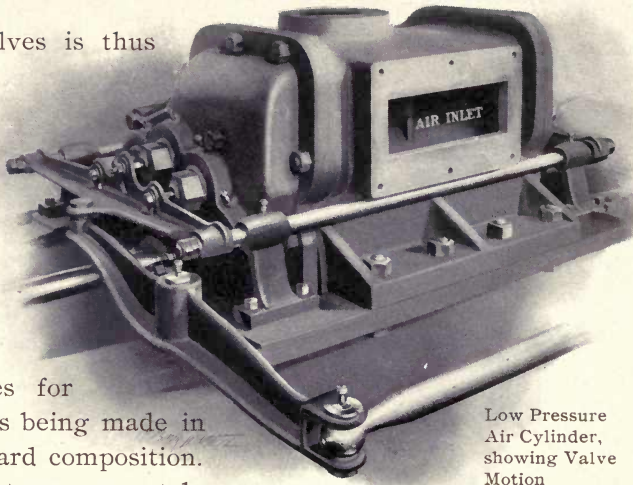

Low Pressure
Air Cylinder,
showing Valve
Motion

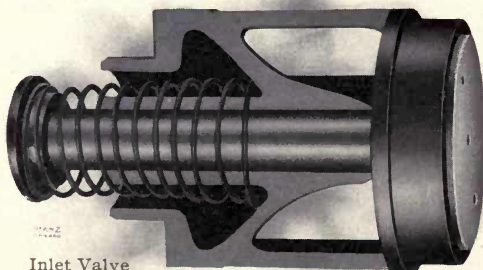

Inlet Valve
on High
Pressure Air
Cylinder

inlet valve are free from obstruction wings and ribs, giving a very free opening through which the incoming air may enter the cylinder.

The high pressure inlet

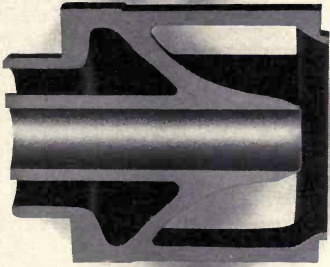

Cage for Inlet Valve on High Pressure Air Cylinder

air valves are similar in form and construction to the low pressure inlet air valves, but instead of obtaining their movement mechanically, are opened and closed by the pressure of the air.

Inlet Valves on High Pressure Air Cylinders

The discharge valves are made of the best selected steel, of cup-shaped form, and are internally guided on an extension of the valve plug with the springs inside,

Air Discharge Valves

thus being fully protected from dirt. In valves which are guided externally, the oil and dirt forms a hard crust on the outside and causes difficulty in removing the valve.

Air is drawn into the machine through a conduit connected with a box leading from a suitable point outside the building and passing beneath the engine room floor. This conduit, which is supplied with the compressor, is provided at its upper end with a rectangular flange which bolts to the low pressure cylinder. There are no inaccessible air passages through the foundation, with wooden pieces difficult to fit to the irregular shape of the cylinder and heads and liable from their location to permit dirt and warm air to be drawn in through carelessly fitted joints.

Air Conduit

Air and steam pistons are accurately fitted to the bore of the cylinder, and provided with spring-ring packing and secured to the rod by means of taper fits and lock nuts, the piston rods being made of the best forty-carbon hammered steel.

Air and Steam Pistons

The crosshead is an open hearth steel casting of ample size and strength to insure against breakage. It has a swivel pin connection to the piston rods, and is provided with a practical and satisfactory "take-up" for the wear on this pin. It is impossible for the crosshead to get out of order, as there is no complication

Crosshead

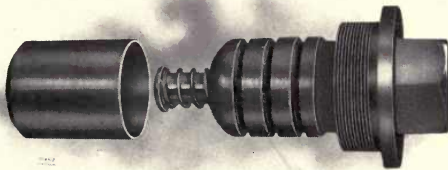

Air Discharge Valve

of split pins, wedges or other devices to stick and thus defeat the object of swiveling and cause unequal strains on the connecting rods. The surfaces of the crosshead in contact with the guides are provided with brass shoes.

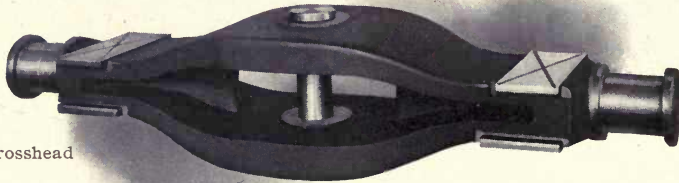

Crosshead

Fly-wheels

Two fly-wheels are used, one on each side of the machine, the rims being turned smooth and round.

Steam Valve Gear

The slide valves in the steam cylinder are balanced and are operated by two eccentrics on the crank shaft between the main bearings, the main and cut-off eccentrics and adjustable link boxes being made alike. The rocker arms to which the valve rods are connected are made of open hearth steel castings, the lower ends of which are bushed with hard brass liners.

Crank Pins and Shaft

Crank pins and shaft are made of the best forged steel procurable.

Crank Shaft Bearings

The crank shaft bearings are best bronze castings, recessed for babbitt and are made in three pieces. The side pieces or cheeks are adjustable for wear, taken up by means of a wedge moved by a nut on the top of the main bearing cap. The side pieces may be removed without disturbing the fly-wheels or shaft; the bottom pieces may be removed by raising the shaft and fly-wheels about one-half inch from their normal position. This arrangement permits of quick and easy access for examination of the main bearings in case of overheating.

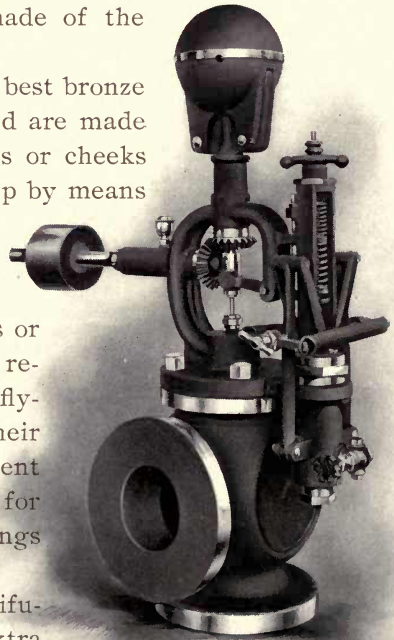

The governor is of the centrifugal ball throttling type, with an extra

Combined Speed and Pressure Regulator

cylinder which places the governor valve under the influence of the air receiver pressure. Ordinarily, the governor varies the speed of the compressor to suit the demand for air, the centrifugal balls preventing the compressor from exceeding a safe speed. The governor belt is run from a pulley to the outer end of the crank pin. When this pulley is located on the shaft between the fly-wheels, the belt becomes covered with oil from the main bearings, which, besides causing it to slip on the pulley, soon ruins the belt.

Combined
Speed and
Pressure
Regulator

On one side of the machine and within convenient reach of the throttle is placed a lever operating, through suitable connections, a pawl on one of the fly-wheels, for turning the machine by hand. The lever may be removed from its socket after the compressor has started, and the pawl automatically clears itself from the wheel.

Hand
Starting
Device

All of the cylinders are provided with suitable sight-feed lubricators; the crank pins are fitted with pendulum oilers with stationary cups. All important bearings are fitted with sight-feed oil cups.

Lubricators
and Oilers

With each compressor, in addition to a blue print showing foundation required, the following fittings are furnished:

Fittings

- One combined speed and pressure regulator.
- One yoke-throttle valve with flange connection.
- One complete set of foundation bolts, nuts and washers.
- One complete set solid wrenches.
- One complete set of piston and valve rod packing.
- One complete set of lubricators for steam and air cylinders.
- One complete set of cylinder drain cocks.
- Sight-feed oil cups for all bearings.

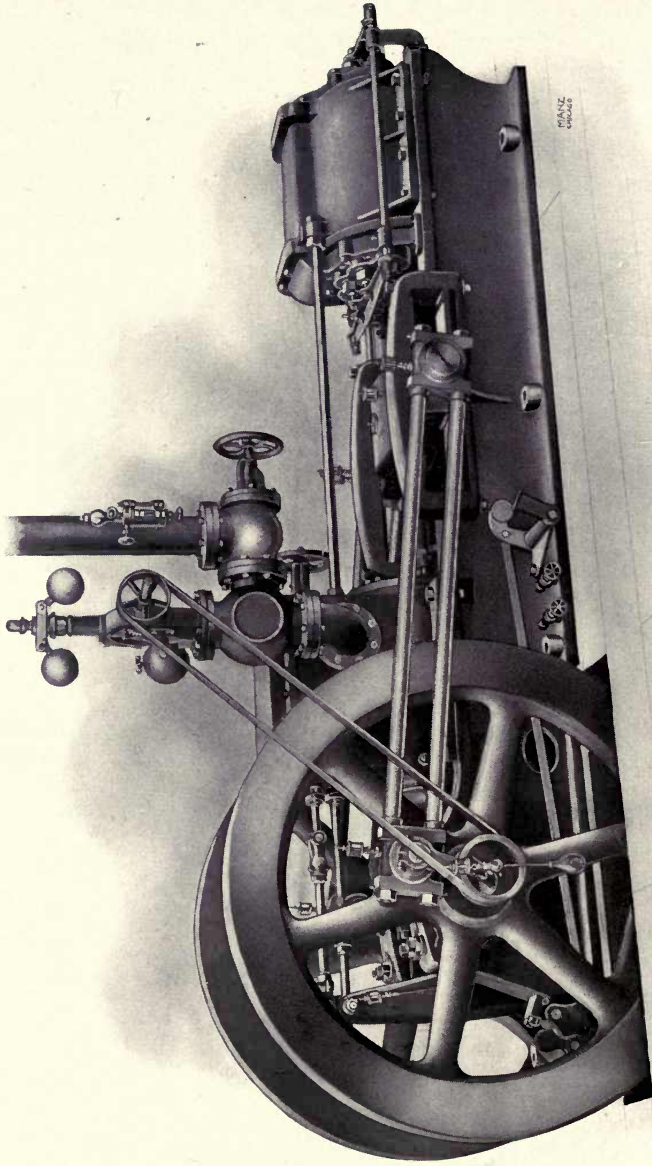

Sullivan Straight Line Air Compressor, Class W.A.
Simple steam and air cylinders

Sullivan Straight Line Air Compressor

This Type Designated as Class WA

THE Sullivan Straight Line Air Compressor, Class WA, with simple steam and air cylinders, has been designed to meet the conditions where low cost is considered more important than efficiency and economy of operation. This compressor is identical with the Class WB Compressor previously described in this catalogue, except that the frame is shorter and the high pressure air cylinder and intercooler are dispensed with, the air being compressed up to its final pressure in a single cylinder.

*General Dimensions and Weights
Steam Driven Straight Line Compressors, Class WA. Simple Steam and Air Cylinders*

Steam Cylinder	Low Pressure Air Cylinder	Stroke	Capacity cubic feet of free air		Horse Power	Revolutions per Minute	Dimensions			Piping				Fly Wheel		Weight of Frame	Total Weight	Code Word
			Per Revolution	Per Minute			Length	Width	Height	Air Outlet	Steam	Exhaust	Jacket	Foundation Bolts	Diameter Inches			
			ft. in.	ft. in.	ft. in.	ft. in.	ft. in.	ft. in.	ft. in.									
12	12	14	11	4	4	4	0	3	3	4	3/4	7/8	50	1900	1600	7800	<i>Kajaggar</i>	
14	14	16	12	6	4	6	5	3 1/2	3 1/2	4	1	1	56	2525	2000	10500	<i>Kajamon</i>	
14	16	16	13	0	5	0	5	4	3 1/2	4	1	1	60	3480	2300	12800	<i>Kajaraba</i>	
16	16	16	13	0	5	0	6	0	4	5	1	1	60	3480	2300	13200	<i>Kajecco</i>	
18	20	20	15	0	5	10	6	0	5	5	1 1/4	1 1/4	70	6000	4500	21500	<i>Kajedero</i>	
20	20	20	15	0	5	10	6	11	5	6	1 1/4	1 1/4	70	6000	4500	22000	<i>Kajesmas</i>	
20	22	24	17	5	6	5	7	1	6	6	1 1/4	1 1/4	78	7800	6500	27000	<i>Kajinep</i>	
22	22	24	17	5	6	5	6	10	6	6	1 1/4	1 1/4	78	7800	6500	29000	<i>Kajisera</i>	
22	24	24	17	5	6	5	6	10	6	6	1 1/4	1 1/4	78	7800	6500	29600	<i>Kajovom</i>	
24	26	30	24	0	6	11	8	0	6	8	1 1/2	1 1/2	96	13000	8500	37000	<i>Kajude</i>	

Data Required for Air Compressors

WHEN writing for prices or other information pertaining to air compressors, the following data should be furnished:

1. Volume of free air per minute required.
2. Working air pressure.
3. Number, size and kind of machines to be operated by the compressed air.
4. If for pumping, give make, size and speed of pump, and height to which water must be delivered.
5. Altitude, if over 1,000 feet above sea level.
6. If for steam-actuated compressor, give working steam pressure.
7. If for belt or gear driven compressor, give power available, diameter of driving pulley or gear, etcetera.
8. Any design of compressor preferred.

The more full the information regarding the special conditions under which the compressor is to be operated, the more closely can be determined the type of machine which will best meet the requirements of the case.

Other Types and Designs of Compressors Manufactured

IN addition to the Straight Line Steam Driven Air Compressor, the company constructs machines of this type driven by belt or gears, using whatever power may be available, electricity, gas or water power.

Also a full line of Duplex Air Compressors having all possible variations in design are made, viz.:

Simple steam with simple air cylinders.

Simple steam with cross-compound air cylinders.

Cross-compound steam with simple air cylinders.

Cross-compound steam with cross-compound air cylinders.

The steam cylinders are fitted with Meyer adjustable cut-off, balanced, or Corliss valve gear as desired, to be run condensing or non-condensing in case of compounding.

The special Air Compressor Catalogue fully illustrates and describes these different designs, and a copy will be furnished upon request.

Efficiency of Air Compressors

From Hiscox's "Compressed Air"

“**A**S the density of the atmosphere decreases with the altitude, a compressor located at a high altitude takes in less air at each revolution; that is to say, the air is taken in at a lower pressure; hence the early part of each stroke is occupied in compressing the air from the lower density up to the normal sea level pressure of 14.7 pounds, and the volumetric capacity of the air cylinder is correspondingly diminished. The power required to drive the same compressor is also less than at sea level, but the decrease in power required is not in as great a ratio as the reduction in capacity. Therefore, compressors to be used at high altitudes should have the steam and air cylinders properly proportioned to meet the varying conditions at different altitudes. The compressor friction and leakage losses are a constant quantity.

“It is apparent that the more dense the air when drawn into the compressor cylinder, the sooner the desired pressure is reached in terms of the cylinder stroke, and, on the contrary, the lighter or less dense the air is at the intake, the smaller will be the volume at the desired pressure, or, the pressure is reached at a later point in the stroke.

“The air temperature at high levels is on the average lower than at sea level throughout the year, which slightly increases the density due to the height alone; so that the volumetric efficiency may be somewhat higher than is due to barometric pressure alone.

“The decreased power required by a compressor due to elevation varies from 60 to 56 per cent. of the loss of capacity.”

*Efficiency of Compressors at Different Altitudes
From Hiscox's "Compressed Air"*

Altitude in Feet	Barometric Pressure		Volumetric Efficiency of Compressor Per Cent.	Loss of Capacity Per Cent.	Decreased Power Per Cent.
	Inches Mercury	Pounds per Square Inch			
0	30.00	14.75	100	0	0.
1,000	28.88	14.20	97	3	1.8
2,000	27.80	13.67	93	7	3.5
3,000	26.76	13.16	90	10	5.2
4,000	25.76	12.67	87	13	6.9
5,000	24.79	12.20	84	16	8.5
6,000	23.86	11.73	81	19	10.1
7,000	22.97	11.30	78	22	11.6
8,000	22.11	10.87	76	24	13.1
9,000	21.29	10.46	73	27	14.6
10,000	20.49	10.07	70	30	16.1
11,000	19.72	9.70	68	32	17.6
12,000	18.98	9.34	65	35	19.1
13,000	18.27	8.98	63	37	20.6
14,000	17.59	8.65	60	40	22.1
15,000	16.93	8.32	58	42	23.5

Horse Power Required to Compress 100 Cubic Feet of Free Air to Various Pressures

Gauge Pressures	Single Stage	Two Stages	Saving, Two Stage over Single Stage Compression	
			Horse Power	Per Cent.
40	10.25			
45	11.10			
50	11.87			
55	12.60			
60	13.30	11.71	1.59	11.95
65	13.97	12.29	1.68	12.03
70	14.61	12.83	1.78	12.18
75	15.22	13.33	1.89	12.42
80	15.81	13.80	2.01	12.71
85	16.38	14.24	2.14	13.06
90	16.93	14.64	2.29	13.53
95	17.46	15.00	2.46	14.09
100	17.99	15.34	2.65	14.73

*Table showing Cubic Feet of Free Air
Required to Run from One to Forty Machines*

AMOUNT FREE AIR PER MINUTE

No. of Machines	ROCK DRILLS									Pick Coal Machines	
	UA	US	UB	UC	UD	UE	UF	UH	UK	4½ in.	5½ in.
	2 in.	2¼ in.	2½ in.	2¾ in.	3 in.	3½ in.	3¾ in.	3⅝ in.	4¼ in.		
1	65	67	70	95	110	112	115	130	140	110	130
2	110	115	120	160	190	194	200	235	250	200	240
3	156	165	174	234	279	284	294	340	360	290	340
4	196	206	220	304	356	361	372	435	460	370	430
5	230	240	260	370	425	433	445	520	555	450	520
6	264	275	294	426	486	498	516	600	642	530	610
7	294	305	329	476	546	560	581	670	721	610	700
8	320	335	360	520	600	618	640	740	800	690	790
9	360	375	405	585	675	695	720	830	900	770	880
10	400	425	450	650	750	770	800	920	1000	850	970
12	480	500	540	780	900	925	960	1100	1200	1010	1150
15	675	975	1125	1155	1200	1380	1500	1250	1420
20	1300	1500	1545	1600	1850	2000	1650	1870
25	1625	1875	1930	2000	2300	2500	2000	2300
30	1950	2250	2320	2400	2770	3000	2400	2800
40	2600	3000	3100	3200	3700	4000	3200	3700

Transmission of Compressed Air

In order to determine the proper size of pipes to carry a certain flow of compressed air, there will be found in the following pages four tables showing the loss due to friction in pipes one hundred feet in length, with different diameters of pipes and volumes of air, the initial pressure being 60, 75, 90 and 100 pounds gauge pressure respectively. To ascertain what the terminal loss in pressure would amount to in a given case, turn to the table corresponding to the initial pressure, and determine what the loss would be in a pipe one hundred feet long; then multiply the loss in pressure found in the table, by the length of the pipe in units of one hundred feet, and the result will be the terminal loss in pressure. For example, suppose it is desired to find the loss in pressure due to friction in a 4-inch pipe 1200 feet long, carrying 1000 cubic feet free air compressed to an initial gauge pressure of 75 pounds per square inch. By referring to the table on page 103 the loss in 100 feet of pipe is .36 pounds; multiplying this factor by 12 gives a loss of 4.32 pounds for the entire length of the pipe, or a terminal gauge reading of 70.68 pounds.

To cause the air to flow through pipes there must be some reduction in the pressure at the discharging point, but how greatly to restrict this loss in pressure is a question of business economy, as almost any amount of mechanical efficiency may be obtained, but possibly with an extravagant expenditure for pipe. It is therefore necessary to understand the local conditions as to cost of fuel, labor, etcetera, on one hand, and the cost of pipe on the other hand, before a definite opinion can be given on this subject.

Loss of pressure should not be confounded with a loss of power, as there is nearly a corresponding increase in volume with a reduction in the pressure, and hence the loss in energy is much smaller than the tables seem to indicate. Richards, in "Compressed Air," on this subject has the following to say:

“With pipes of proper size, and in good condition, air may be transmitted, say, ten miles, with a loss of pressure of less than 1 pound per mile. If the air were at 80 pounds gauge, or 95 pounds absolute, upon entering the pipe, and 70 pounds gauge, or 85 pounds absolute, at the other end, there would be a loss of a little more than 10 per cent. in absolute pressure, but at the same time there would be an increase of volume of 11 per cent. to compensate for the loss of pressure, and the loss of available power would be less than 3 per cent. With higher pressures still more favorable results could be shown.”

Table Showing Loss in Pressure, in Pounds, due to Friction in Pipes 100 Feet in Length

Gauge Pressure at Entrance to Pipe, 60 Pounds

Pipe Diam.	CUBIC FEET FREE AIR DELIVERED PER MINUTE																																										
	25	50	75	100	125	150	200	250	300	350	400	500	600	700	800	900	1000	1200	1500	1800	2000	2500	3000	3500	4000	5000	6000	7000	8000	9000	10000												
1	.45	1.82	4.1	7.29																																							
1¼	.13	.5	1.11	2.01																																							
1½2	.44	.78	1.22	1.76	3.13																																				
204	.1	.17	.27	.38	.68	1.06	1.53	2.08	2.7																																
2½05	.08	.12	.21	.33	.47	.64	.88	1.3	1.87	2.54	3.32																												
304	.08	.12	.18	.24	.31	.49	.71	.96	1.25	1.59	1.96	2.82																									
3½08	.11	.14	.22	.32	.43	.56	.71	.88	1.26	1.97																								
407	.11	.16	.21	.28	.35	.44	.63	.98	1.41	1.74	2.72																						
4½06	.09	.12	.15	.19	.24	.35	.54	.78	.96	1.5	2.16																				
505	.07	.09	.11	.14	.2	.31	.45	.55	.86	1.24																				
608	.04	.05	.08	.12	.17	.22	.34	.48	.66	.86																		
702	.04	.06	.08	.1	.15	.22	.3	.39	.61	.88																
808	.04	.05	.08	.11	.15	.2	.31	.45	.61	.79														
1002	.03	.04	.05	.06	.1	.14	.19	.25	.32	.39												
1201	.02	.03	.04	.06	.08	.1	.13	.16											

Table Showing Loss in Pressure, in Pounds, due to Friction in Pipes 100 Feet in Length

Gauge Pressure at Entrance to Pipe, 90 Pounds

Diam. Pipe	CUBIC FEET FREE AIR DELIVERED PER MINUTE																																
	25	50	75	100	125	150	200	250	300	350	400	500	600	700	800	900	1000	1200	1500	1800	2000	2500	3000	3500	4000	5000	6000	7000	8000	9000	10000		
1	.38	1.3	2.92	5.19																													
1½	.09	.36	.81	1.44																													
1¾	.14	.31	.56	.87	1.25	2.23																											
2	.03	.07	.12	.19	.27	.48	.76	1.09	1.48	1.94																							
2½	.04	.06	.08	.15	.23	.33	.45	.56	.92	1.33	1.81	2.36																					
3	.03	.06	.09	.13	.17	.22	.35	.5	.68	.89	1.12	1.39	2.																				
3½	.06	.08	.1	.16	.23	.3	.4	.51	.63	.9	1.41																						
4	.05	.08	.11	.15	.2	.25	.31	.45	.7	1.	1.24	1.93																					
4½	.04	.06	.08	.11	.14	.17	.25	.39	.56	.69	1.07	1.54																					
5	.04	.05	.06	.08	.1	.14	.22	.32	.39	.61	.88																						
6	.02	.03	.04	.06	.09	.12	.15	.24	.35	.47	.61																						
7	.02	.03	.04	.06	.07	.11	.16	.21	.28	.44	.63																						
8	.02	.03	.04	.06	.08	.11	.14	.22	.32	.43	.57																						
10	.01	.02	.03	.04	.06	.08	.11	.14	.22	.32	.43	.57																					
12	.01	.02	.03	.04	.06	.08	.11	.14	.22	.32	.43	.57																					

Table Showing Loss in Pressure, in Pounds, due to Friction in Pipes 100 Feet in Length

Gauge Pressure at Entrance to Pipe, 100 Pounds

Plain Pipe	CUBIC FEET FREE AIR DELIVERED PER MINUTE																																	
	25	50	75	100	125	150	200	250	300	350	400	500	600	700	800	900	1000	1200	1500	1800	2000	2500	3000	3500	4000	5000	6000	7000	8000	9000	10000			
1	.3	1.18	2.06	4.75																														
1¼	.08	.83	.73	1.3																														
1½	.13	.29	.6	.8	1.15	2.04																												
2	.03	.07	.12	.18	.26	.47	.73	1.05	1.43	1.87																								
2½	.03	.05	.08	.14	.21	.31	.42	.54	.85	1.22	1.66	2.17																						
3	.03	.05	.08	.11	.15	.2	.31	.45	.61	.8	1.01	1.25	1.8																					
3½	.03	.05	.08	.11	.15	.2	.31	.45	.61	.8	1.01	1.25	1.8																					
4	.03	.05	.08	.11	.15	.2	.31	.45	.61	.8	1.01	1.25	1.8																					
4½	.03	.05	.08	.11	.15	.2	.31	.45	.61	.8	1.01	1.25	1.8																					
5	.03	.05	.08	.11	.15	.2	.31	.45	.61	.8	1.01	1.25	1.8																					
6	.03	.05	.08	.11	.15	.2	.31	.45	.61	.8	1.01	1.25	1.8																					
7	.03	.05	.08	.11	.15	.2	.31	.45	.61	.8	1.01	1.25	1.8																					
8	.03	.05	.08	.11	.15	.2	.31	.45	.61	.8	1.01	1.25	1.8																					
10	.03	.05	.08	.11	.15	.2	.31	.45	.61	.8	1.01	1.25	1.8																					
12	.03	.05	.08	.11	.15	.2	.31	.45	.61	.8	1.01	1.25	1.8																					

T a b l e o f B r a n c h P i p e s

RELATIVE CARRYING CAPACITY OF PIPES FOR AIR															
Diam. of Pipe	1	1 1/4	1 1/2	2	2 1/2	3	3 1/2	4	4 1/2	5	6	7	8	10	12
1	1.00	.52	.327	.15	.084	.05									
1 1/4	1.90	1.00	.614	.28	.16	.10	.066								
1 1/2	3.05	1.60	1.00	.46	.256	.16	.106	.075							
2	6.55	3.45	2.14	1.00	.56	.34	.23	.160	.12						
2 1/2	11.8	6.25	3.88	1.81	1.00	.614	.41	.29	.216	.163					
3	19.0	12.0	6.32	2.95	1.63	1.00	.67	.47	.35	.268	.165				
3 1/2	15.2	9.45	4.3	2.43	1.50	1.00	.71	.52	.400	.246	.166			
4	21.6	13.4	6.25	3.46	2.10	1.42	1.00	.75	.56	.352	.237	.169		
4 1/2	18.0	8.30	4.65	2.85	1.90	1.35	1.00	.76	.475	.32	.227	.128	
5	6.14	3.77	2.60	1.78	1.32	1.00	.625	.42	.30	.169	.10
6	6.05	4.00	2.85	2.15	1.60	1.00	.675	.48	.27	.17
7	6.00	4.20	3.16	2.37	1.48	1.00	.71	.40	.25
8	6.00	4.40	3.25	2.10	1.40	1.00	.56	.35
10	7.85	5.90	3.70	2.50	1.77	1.00	.63
12	9.40	5.90	3.95	2.80	1.60	1.00

A i r R e c e i v e r s



AN erroneous idea sometimes exists that an air receiver acts as a reservoir of power so that in case the compressor is temporarily called upon to deliver more air than it can produce, the storage of power within the receiver will supply the deficiency. A receiver for this purpose would be large and costly, and the money so invested could be more judiciously used in purchasing a compressor large enough to meet its greatest demands.

Receivers of ordinary size have several functions to perform, in equalizing the pulsations in the air coming from the compressor, in collecting the water and grease which the air carries in suspension, and in reducing the friction of the air within the pipe system. It is customary to place a receiver within a few feet of the compressor, which serves principally to equalize the pulsations of the air due to the action of the compressor, the air coming to the receiver intermittently and leaving it in a steady flow. A second receiver should be placed near where the air is to be used, the air is cooled in passing to it through the pipes, and the water carried in suspension precipitated and drained into this receiver, and emptied at intervals by opening a valve, or discharged automatically through a suitable trap. An arrangement of this sort insures dry air for the machines, and hence all danger of freezing is obviated.

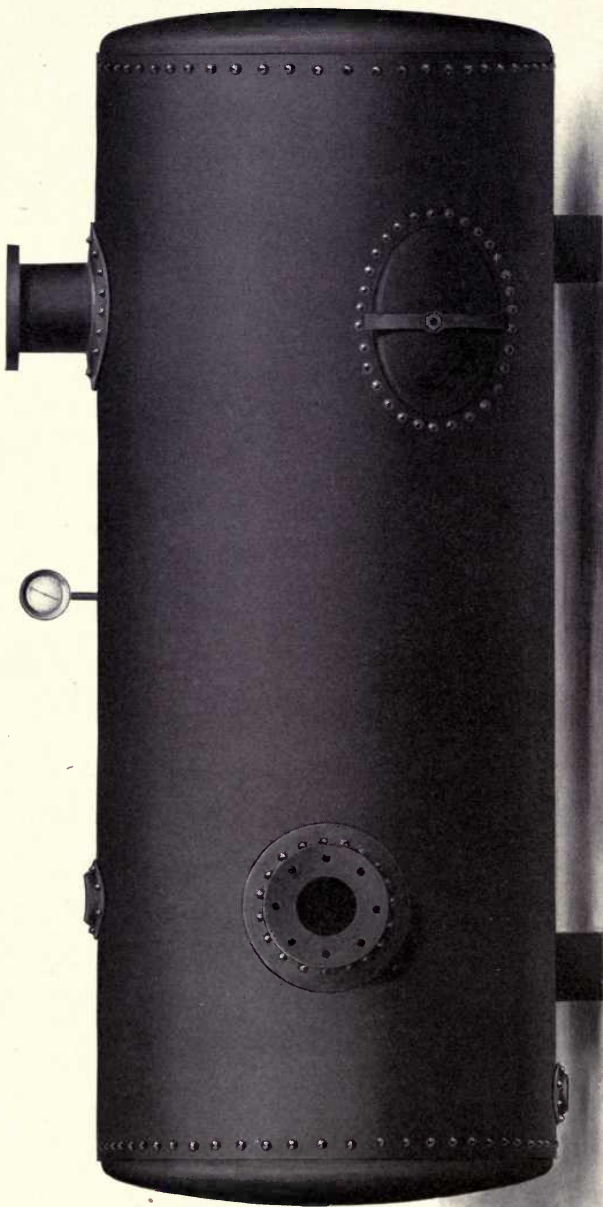

Sullivan Air Receiver

1746 1/2" dia. 100 lbs. pressure

The Sullivan Air Receivers

Sullivan Receivers are made of homogeneous steel of 60,000 pounds tensile strength, one sheet being used for the smaller sizes and two or more sheets for the larger sizes. The girth seams are single and the side seams double riveted, and the receiver is thoroughly tested and made tight under 150 pounds cold-water pressure. A man-hole is provided, and the inlet and discharge pipes are connected by flanges.

Diameter in inches	Length in feet	Thickness of Shell in inches	Thickness of Heads in inches	Code Word
30	6	$\frac{1}{4}$	$\frac{5}{16}$	<i>Kajxam</i>
36	6	$\frac{1}{4}$	$\frac{3}{8}$	<i>Kajxeck</i>
36	8	$\frac{1}{4}$	$\frac{3}{8}$	<i>Kajxelmo</i>
42	8	$\frac{1}{4}$	$\frac{3}{8}$	<i>Kajxezar</i>
42	10	$\frac{1}{4}$	$\frac{3}{8}$	<i>Kajxigon</i>
48	12	$\frac{9}{32}$	$\frac{7}{16}$	<i>Kajxoch</i>
54	12	$\frac{5}{16}$	$\frac{7}{16}$	<i>Kajxony</i>
66	16	$\frac{3}{8}$	$\frac{1}{2}$	<i>Kajxuso</i>

Unless otherwise specified there is supplied with each air receiver: One pressure gauge; one pop safety valve; one blow-off cock.

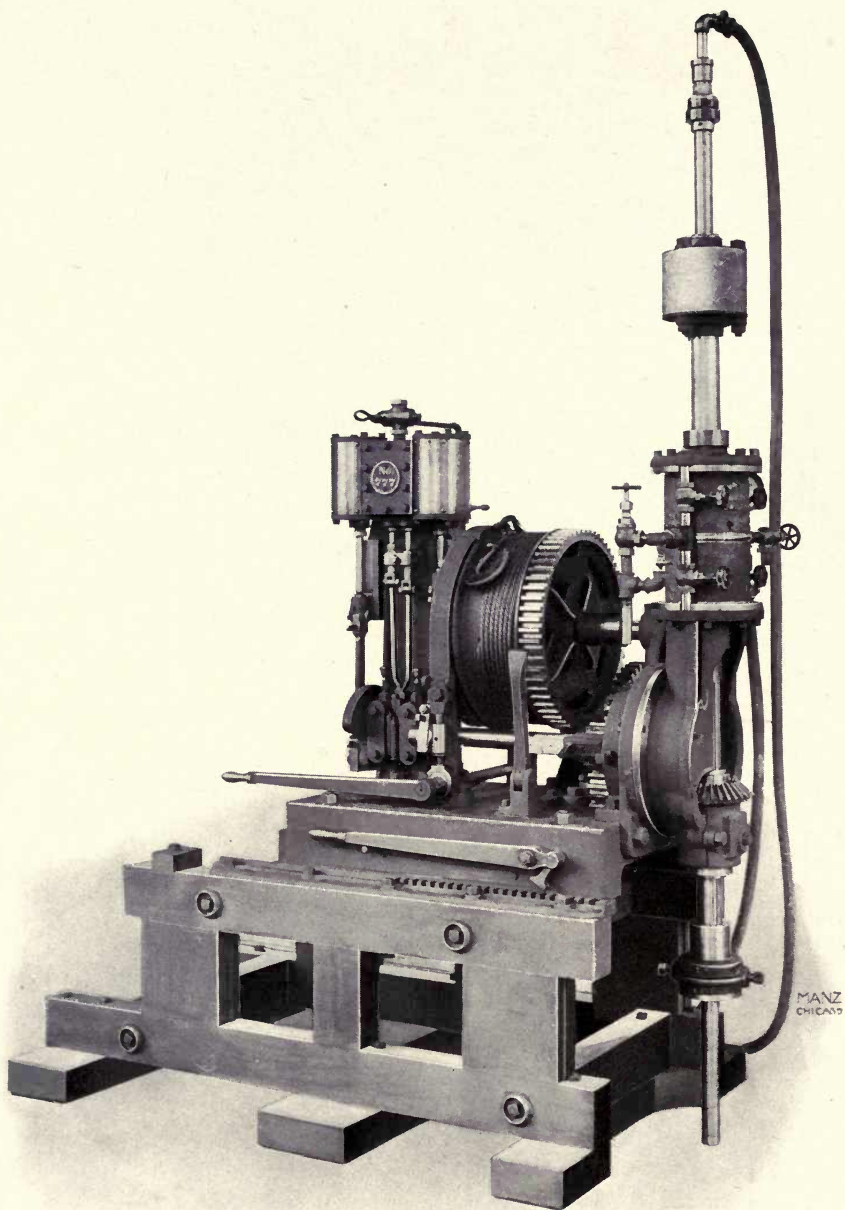

Sullivan Diamond Prospecting Core Drill. Single cylinder hydraulic feed

Sullivan and Bullock Diamond Prospecting Drills

*For Rapid and Economical Prospecting
of Coal and Mineral Lands*



IT is now a well established fact that the only reliable and satisfactory way of drilling prospect holes is by means of a diamond core drill. Other methods of prospecting, where the churn drill process

is used, are absolutely valueless so far as reliable results are concerned. Many instances might be cited where sums of from one thousand to twenty-five thousand dollars have been thrown away in sinking shafts for coal on records furnished by churn drills, the supposed vein of coal proving to be a black bituminous shale; it is impossible to accurately determine with the churn drill the difference between coal and black slate, or shale if highly carboniferous.

The diamond drill bores a perfectly straight smooth hole to any depth, or in any given direction from vertical to horizontal, bringing to the surface a solid section or "core" of all strata passed through and in order, showing exact depth, thickness and character of the rock. This core is large enough to permit of thorough examination, analysis and test; and, what is of almost equal value, if the coal or mineral sought for is absent, the fact is determined beyond a doubt. It also gives positive information of the material which would be met in sinking a shaft to work the coal or mineral indicated as present, making it possible to estimate closely the cost of the shaft.

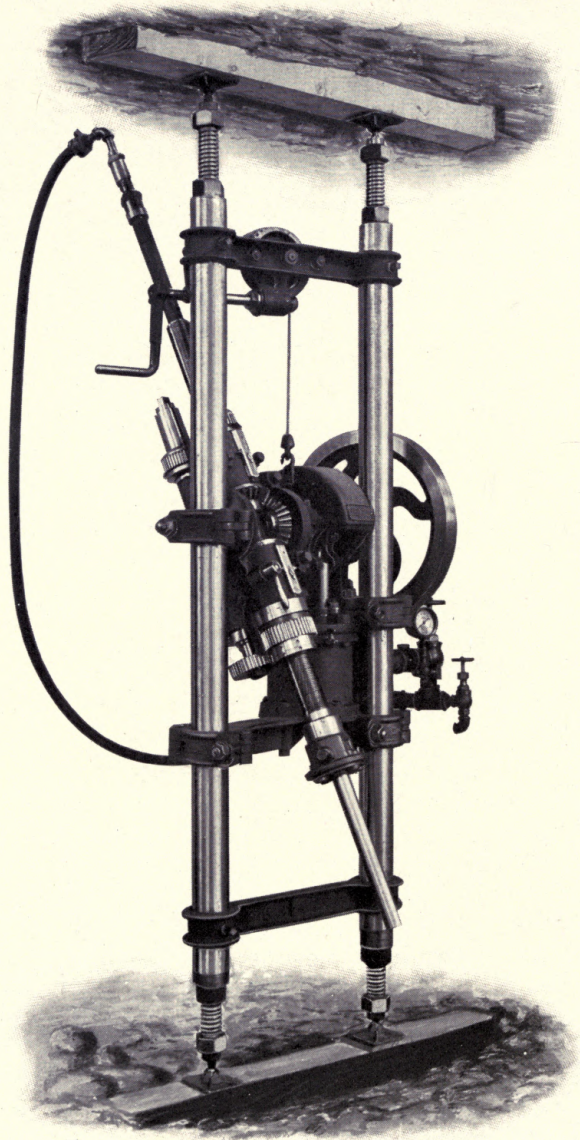

Sullivan Diamond Prospecting Core Drill. Friction feed. For underground use

The requirements of a machine for such work are many and exacting. It must be strong, simple and durable, economical in use of power and in the wear of the diamond points or "carbon," rapid in operation, and above all, its work must be accurate and reliable, so that the results derived from it will be known to be correct, as upon them depends the expensive process of sinking shafts and driving tunnels, as well as the investment of large sums of money in land.

Not only for prospecting from the surface, but for drilling in advance of levels underground, for sinking wells for gas, oil or water, especially where coal, salt or other minerals are looked for; in submarine work, for prospecting quarry lands, and for many other special purposes, the diamond drill is far superior to any other, consequently it is in general use, and is considered essential to the economical development of coal or mineral lands, as possessing great advantage in time, accuracy and economy over any other method of prospecting.

The Sullivan and Bullock Diamond Prospecting Core Drills embody all the latest improvements suggested by long experience in manufacturing, as well as in operating such machines. This varied experience has resulted in the manufacture of diamond drills having no equal for accuracy and reliability, and wherever advanced mining methods are in use the Sullivan and Bullock Diamond Drills are well known, and the large sale of them in the United States, as well as in most of the foreign countries, proves the extent of their reputation. One of the greatest difficulties in prospecting for coal has been the inability to obtain a complete core of the coal, but during the past few years the company has designed an *improved double tube core barrel* which has entirely overcome this difficulty, and made possible the saving of full coal core.

In order to make the line as complete as possible, new designs and improvements on the old are constantly being made. Machines are now built with capacities for drilling holes ranging from three hundred feet to over one mile

Table of Sizes, Capacities, Dimensions and Other Data of Sullivan Diamond Prospecting Core Drills

Size of Drill	Capacity		Diameter of Core, Inches	Steam Pipe, Inches	Exhaust Pipe, Inches	Pump Required	H. P. Boiler Required for Drill and Pump	Space Required Drive Rod in Lowest Position		Code Word
	Depth of Hole, Feet	Diameter of Hole, Inches						Floor Space	Height	
M	300	1 ⁹ / ₁₆	1 ⁵ / ₈	Hand	Hand or Belt	Power	Drill	<i>Abbiando</i>
E	400	1 ¹¹ / ₁₆	1 ¹¹ / ₁₆	1	1 ¹ / ₄	4 ¹ / ₂ x 2 ³ / ₄ x 4	8	2' 7" x 3' 6"	4' 3"	<i>Abbrivida</i>
S	500	1 ¹³ / ₁₆	1 ¹³ / ₁₆	1	1 ¹ / ₄	4 ¹ / ₂ x 2 ³ / ₄ x 4	8	3' 2" x 3' 3"	6' 6"	<i>Abbrachen</i>
H	1,000	1 ¹³ / ₁₆	1 ¹³ / ₁₆	1	1 ¹ / ₂	4 ¹ / ₂ x 2 ³ / ₄ x 4	10	3' 2" x 6' 3"	6' 6"	<i>Abbruniva</i>
HG	1,000	1 ¹³ / ₁₆	1 ¹³ / ₁₆	1	1 ¹ / ₂	4 ¹ / ₂ x 2 ³ / ₄ x 4	10	3' 2" x 6' 3"	6' 6"	<i>Abbrix</i>
C	1,500	1 ¹³ / ₁₆	1 ¹³ / ₁₆	1	1 ¹ / ₂	6 x 4 x 6	12	3' 6" x 6' 3"	6' 9"	<i>Abbriglio</i>
B	3,000	2 ¹ / ₁₆	1 ³ / ₈	1 ¹ / ₄	2	7 ¹ / ₂ x 4 ¹ / ₂ x 6	15	3' 9" x 7' 0"	7' 6"	<i>Abbranchi</i>
N	2,000	2 ¹ / ₁₆	2	1 ¹ / ₄	2	6 x 4 x 6	20	3' 9" x 7' 3"	7' 6"	<i>Abbiarono</i>
HN	500	2 ¹ / ₁₆	2	1 ¹ / ₄	2	6 x 4 x 6	10	3' 2" x 6' 3"	6' 6"	<i>Abbrion</i>
CN	800	2 ¹ / ₁₆	2	1 ¹ / ₄	2	6 x 4 x 6	10	3' 6" x 6' 3"	6' 9"	<i>Abbricious</i>
P	4,000	2 ¹ / ₁₆	2	1 ¹ / ₄	2	7 ¹ / ₂ x 4 ¹ / ₂ x 10	25	4' 1" x 7' 6"	10' 6"	<i>Abbrucci</i>
PK	5,000	2 ¹ / ₁₆	1 ³ / ₈	1 ¹ / ₄	2	8 x 4 x 12	30	<i>Abbrusc</i>
K	6,000	2 ¹ / ₁₆	2	1 ¹ / ₂	2 ¹ / ₂	{ 8 x 4 x 12 6 x 4 x 6	40	<i>Abbruscalo</i>
R	300	1 ⁹ / ₁₆	1 ⁵ / ₈	Electric Motor	Electric Motor	Attached	2' 6" x 3' 6"	4' 3"	<i>Abburatta</i>
RS	500	1 ⁹ / ₁₆	1 ⁵ / ₈	Electric Motor	Electric Motor	{ 3 x 8 Triplex Electric	2' 11" x 4' 0"	4' 0"	<i>Abcedasse</i>
RH	1,000	1 ¹¹ / ₁₆	1 ¹ / ₂	Electric Motor	Electric Motor	{ 3 x 3 Triplex Electric	3' 2" x 6' 3"	6' 6"	<i>Abburx</i>

It should be borne in mind that holes may be increased in diameter to any desired size by using a reaming bit. Also, by using a larger core-barrel, lifter and bit, a larger hole may be drilled and a larger core obtained than that given in column three.
For equipment furnished with drill, see pages 116 and 117.

in depth, operated by hand, steam, compressed air or electric power.

If interested in diamond drills, send for the special catalogue on this subject.

A large assortment of black diamonds or "carbon" and bortz is carried in stock, which has been selected by experts from original parcels direct from the mines. Customers are thus assured of superior quality.

Prices quoted upon application.

Equipment Tables for Sullivan Diamond Drills

The following equipment is furnished with the "R H," "H," "HG," "C," "B," "HN," "CN," "N," "P," "PK" and "K" drills:

<ul style="list-style-type: none"> 2 blank bits, ready to set 205 feet of drill rods with couplings (20 10-ft., 1 5-ft.) <ul style="list-style-type: none"> 1 10-ft. core barrel 2 core lifters 1 core shell 25 feet 4-ply water hose with connection, for drill rods 12 feet 4-ply water hose with connection, to connect drill and pump 10 feet 6-ply steam hose with connection, for drill (5-ply for "C" and "H") 5 feet 2-ply drip hose 1 swivel steam connection for engine 1 wire rope (wound on hoisting drum) with hook. With "C" and "H," 75 feet of $\frac{1}{2}$-in. rope; with "B" and "N," 100 feet of $\frac{3}{8}$-in. rope; with "P," 150 feet of $\frac{7}{8}$-in. rope; with "PK" and "K," 155 feet of $1\frac{1}{4}$-in. rope 1 drive chuck 1 safety clamp 2 sheaves for hoisting rods, with straps and hooks 1 lifting bail with clevis 1 bail and bolt for sheave 1 lifting swivel or hoisting plug, with coupling 1 water swivel with coupling and elbow 1 pressure gauge for feed cylinder 	<ul style="list-style-type: none"> 1 tool chest with lock and key 1 complete set of diamond-setting tools, consisting of: <ul style="list-style-type: none"> 1 $3\frac{1}{4}$-in. jaw vise, with swiveled base 1 breast drill with 5 bits from $\frac{1}{8}$ to $\frac{1}{4}$ in. diam. 1 set of 12 setting chisels and punches 1 light hammer for diamond setting 1 pair each, 6-in. dividers, inside and outside calipers 1 head for holding bits while setting 1 machinist's hammer 1 screw-driver 1 draw bolt for gears 1 copper strainer and union 1 6-in. adjustable level 2 pairs pipe tongs 1 14-inch pipe wrench 2 12-inch monkey wrenches 1 complete set of solid wrenches for engine, chuck, etc. 1 hand oiler 1 1-gallon oil can 1 engine oil cup with valve 2 recovering taps Rubber and hemp packing and waste All pipe and fittings necessary to connect drill, pump and boiler
--	---

E q u i p m e n t T a b l e s f o r S u l l i v a n D i a m o n d D r i l l s

The following equipment is furnished with sizes "E" and "S." This same equipment is also furnished with "R" and "RS" drills, with additions as per note below:

2 blank bits ready to set	1 light hammer for diamond setting
200 feet of drill rods with couplings (39 5-ft., 5 1-ft.)	1 pair each, 6-in. dividers, inside and outside calipers
1 5-ft. core barrel	1 head for holding bits
1 core shell, and 2 core lifters	1 machinist's hammer
17 feet of 1 in. 4-ply steam hose	1 6-in. adjustable level
17 feet of $\frac{3}{4}$ -in. 2-ply water hose	1 pair pipe tongs
1 water swivel with coupling	2 14-in. pipe wrenches
1 lifting swivel with coupling	2 10-in. monkey wrenches
1 drive chuck	1 complete set of solid wrenches for engine, etc.
1 safety clamp	1 13-in. sheave wheel with strap and hook
1 extra set of feed gears	1 hand oiler
1 extra friction spring	1 half-gallon oil can
1 pressure gauge	1 engine oil cup
1 tool chest with lock and key	2 recovering taps
1 complete set of diamond setting tools, consisting of:	Rubber and hemp packing, and waste
1 $3\frac{3}{4}$ -in. jaw vise with swiveled base	Valves and fittings ready to connect to supply of steam or compressed air
1 breast drill, with 5 bits from $\frac{1}{8}$ to $\frac{1}{4}$ in. diameter	
1 set of 12 setting chisels and punches	

Note.—The equipment furnished with the diamond prospecting drills "R," "RS" and "RH" includes also motor, carbon brushes, switch, and extra fuses, but does not include speed controllers, steam hose, or swivel connection. With the "R" drill a pump, attached to the drill frame, is included in the equipment.

The following equipment is furnished with the "M" (hand power) drill:

2 blank bits ready to set	1 lifting swivel
1 set of 12 chisels and punches for diamond setting	1 coupling, drive spindle to rods
1 head for holding bits while setting	1 safety clamp
100 feet of drill rods with couplings (9 10-ft., 1 5-ft., 3 20-in.)	1 complete set of feed gears (3 pairs)
1 lever hand pump	1 tool box with lock and key
1 10-foot core barrel	2 pairs pipe tongs
1 20-in. core barrel	1 14-in. pipe wrench
1 core shell and 2 lifters	1 10-in. monkey wrench
12 feet of 1-in. 4-ply suction hose with connection and strainer	1 complete set of solid wrenches
10 feet of $\frac{1}{2}$ -in. 2-ply water hose	1 hand oil can
1 water swivel	1 half-gallon oil can
	2 hand cranks
	1 13-in. sheave wheel with strap and hook

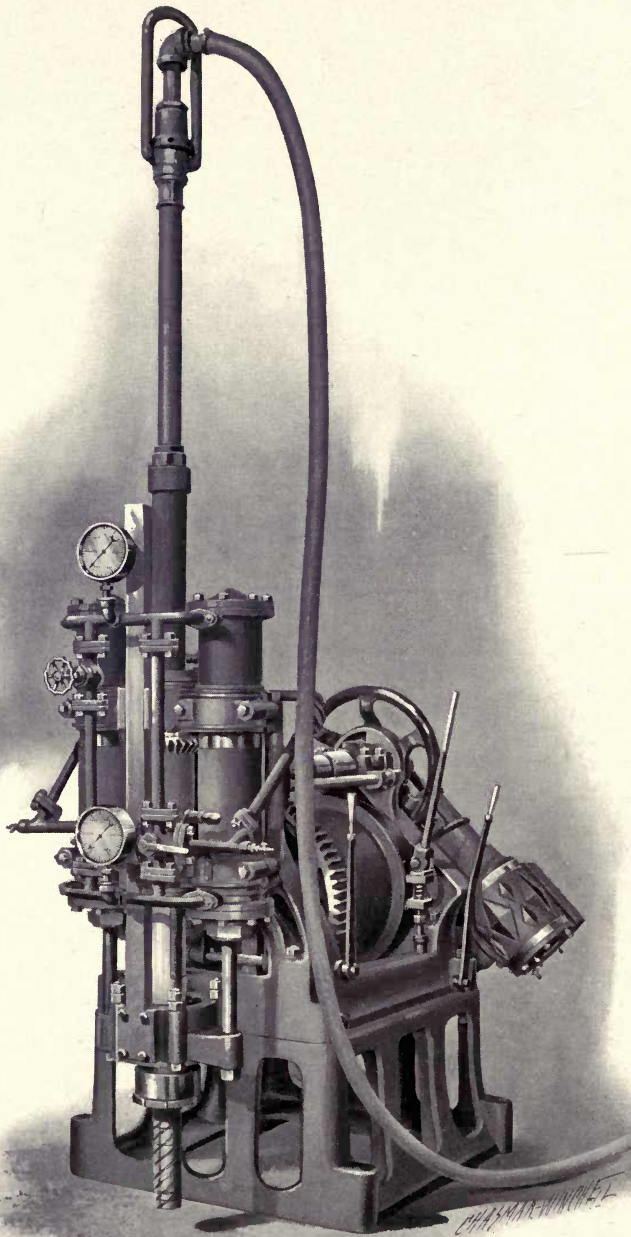

Bullock Diamond Prospecting Core Drill. Twin hydraulic cylinder feed

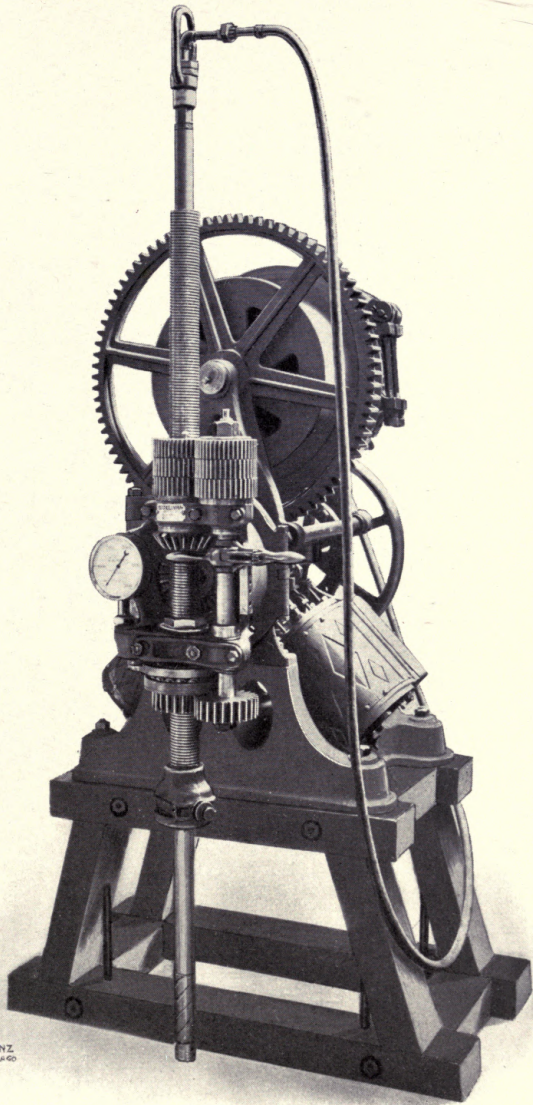

MANZ
CHICAGO

Bullock Diamond Prospecting Core Drill.
Screw feed

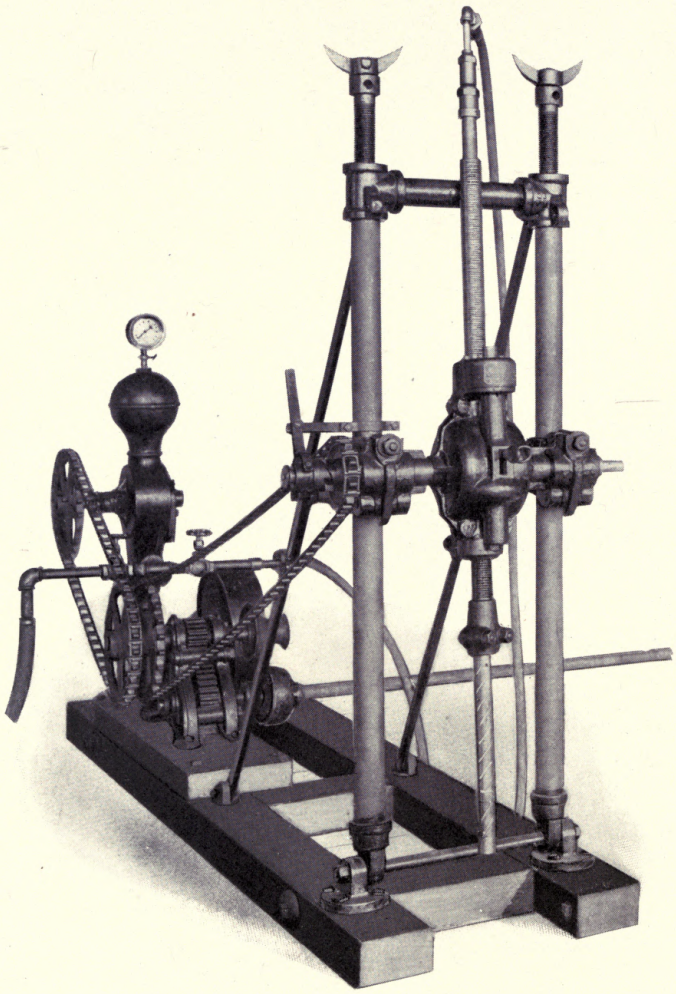

Horse
Power
Connection

Bullock Diamond Prospecting Core Drill. Hand,
horse or belt power, screw feed

Table of Sizes, Capacities, Dimensions and Other Data of the Bullock Diamond Prospecting Core Drills

Size of Drill	Capacity		Diam. of Core, Inches	Steam Pipe, Inches	Exhaust Pipe, Inches	Pump Required	H. P. Boiler Required for Drill and Pump	Space Required Drive Rod in Lowest Position		Code Word
	Depth of Hole, Feet	Diam. of Hole, Inches						Floor Space	Height	
Bravo (Hand Power).....	350	1 $\frac{1}{8}$	1 $\frac{1}{2}$	Hand Power						<i>Brahman</i>
Bravo (Horse Power).....	400	1 $\frac{3}{8}$	1 $\frac{1}{2}$	Horse Power						<i>Bravul</i>
Badger	500	1 $\frac{9}{16}$	1 $\frac{5}{8}$	1 $\frac{1}{2}$	2	3 x 2 x 3	6			<i>Baddish</i>
Beauty	800	1 $\frac{9}{16}$	1 $\frac{5}{8}$	1 $\frac{1}{4}$	1 $\frac{1}{2}$	3 x 2 x 3	8	2 ft. x 3 ft. 4 in.	4 ft. 5 in.	<i>Beauteous</i>
Champion	1500	1 $\frac{11}{16}$	1 $\frac{1}{2}$	1 $\frac{1}{2}$	2	4 $\frac{1}{2}$ x 2 $\frac{3}{4}$ x 4	10	3 ft. x 3 ft. 7 in.	6 ft. 4 in.	<i>Chamade</i>
Detector	2500	2 $\frac{1}{16}$	1 $\frac{3}{8}$	1 $\frac{1}{2}$	2 $\frac{1}{2}$	6 x 4 x 6	15	4 ft. x 4 ft. 6 in.	5 ft. 1 in.	<i>Detective</i>

It should be borne in mind that holes may be increased in diameter to any desired size by using a reaming bit. Also, by using a larger core-barrel, lifter and bit, a larger hole may be drilled and a larger core obtained than that given in column three.
For equipment furnished with drill, see page 122.

Equipment Tables for Bullock Diamond Drills

The following equipment is furnished with the "Beauty," "Champion" and "Detector" drills:

- | | |
|--|---|
| <ul style="list-style-type: none"> 2 blank bits, ready to set 205 feet of drill rods with couplings (20 10-ft., 1 5-ft.) 1 20-in. core barrel (only necessary with the "Beauty" drill) 1 10-ft. core barrel 1 core shell and 2 core lifters 20 feet 4-ply water hose, with connection to connect drill and pump 1 wire rope (wound on hoisting drum) with hook. With "Champion" and "Beauty," 75 feet of $\frac{1}{2}$-in. rope; with "Detector," 100 feet $\frac{5}{8}$-in. rope 1 safety clamp 1 sheave for hoisting rods, with strap and hook 1 lifting bail with clevis 1 bail and bolt for sheave 1 lifting swivel or hoisting plug, with coupling 1 water swivel, with coupling and elbow 1 tool chest with lock and key 1 pound No. 18 copper wire 1 machinist's hammer | <ul style="list-style-type: none"> 1 complete set of diamond-setting tools, consisting of: 1 $3\frac{1}{4}$-in. jaw vise, with swiveled base 1 breast drill, with 5 bits from $\frac{1}{8}$-in. to $\frac{1}{4}$-in. diameter 1 set of 12 setting chisels and punches 1 light hammer for diamond setting 1 pair each, 6-inch dividers, inside and outside calipers 1 head for holding bits while setting 1 6-in. adjustable level 2 pairs pipe tongs, adjustable 1 to 2 inches 1 14-in. pipe wrench 2 12-in. monkey wrenches 1 complete set of solid wrenches for engine, chuck, etc. 1 hand oiler 1 1-gallon oil can 1 engine oil cup, with valve 2 recovering taps Rubber and hemp packing; waste All pipe and fittings necessary to connect drill pump and boiler |
|--|---|

The following equipment is furnished with the "Badger" drill:

- | | |
|--|---|
| <ul style="list-style-type: none"> 2 blank bits ready to set 200 feet of drill rods, with couplings (39 5-ft., 5 1-ft.) 1 20-in. core barrel 1 5-ft. core barrel 1 core shell and 2 core lifters 20 feet of $\frac{1}{2}$-in. 3-ply water hose 1 water swivel, with coupling 1 lifting swivel, with coupling 1 safety clamp 1 extra set of feed gears 1 tool chest, with lock and key 1 complete set of diamond-setting tools, consisting of: 1 $3\frac{1}{4}$-in. jaw vise, with swiveled base 1 breast drill, with 5 bits from $\frac{1}{8}$-in. to $\frac{1}{4}$-in. diameter. 1 set of 12 setting chisels and punches 1 light hammer for diamond setting | <ul style="list-style-type: none"> 1 pair each, 6-in. dividers, inside and outside calipers 1 head for holding bits 1 machinist's hammer 1 6-in. adjustable level 1 pair pipe tongs 2 14-in. pipe wrenches 2 10-in. monkey wrenches 1 complete set of solid wrenches for engine, etc. 1 13-in. sheave wheel, with strap and hook 1 hand oiler 1 half-gallon oil can 1 engine oil cup 2 recovering taps Rubber and hemp packing and waste Valves and fittings ready to connect to supply of steam or compressed air |
|--|---|

Prospecting by Contract with the Diamond Drill

ATENTION is called to the fact that the company contracts for diamond prospecting core drilling of all kinds and in any part of the country. Making a specialty of this line of work for years, a wide and varied experience has been gained. The policy of keeping the drill men constantly employed, and with a number of outfits reserved for this purpose, enables prompt execution of contract drilling of any kind and in any locality.

Correspondence on this subject is solicited, and estimates of cost will gladly be furnished upon receipt of information as to the conditions of the work.

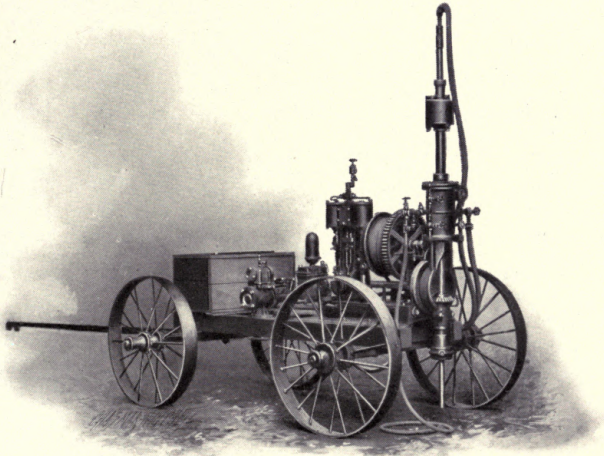

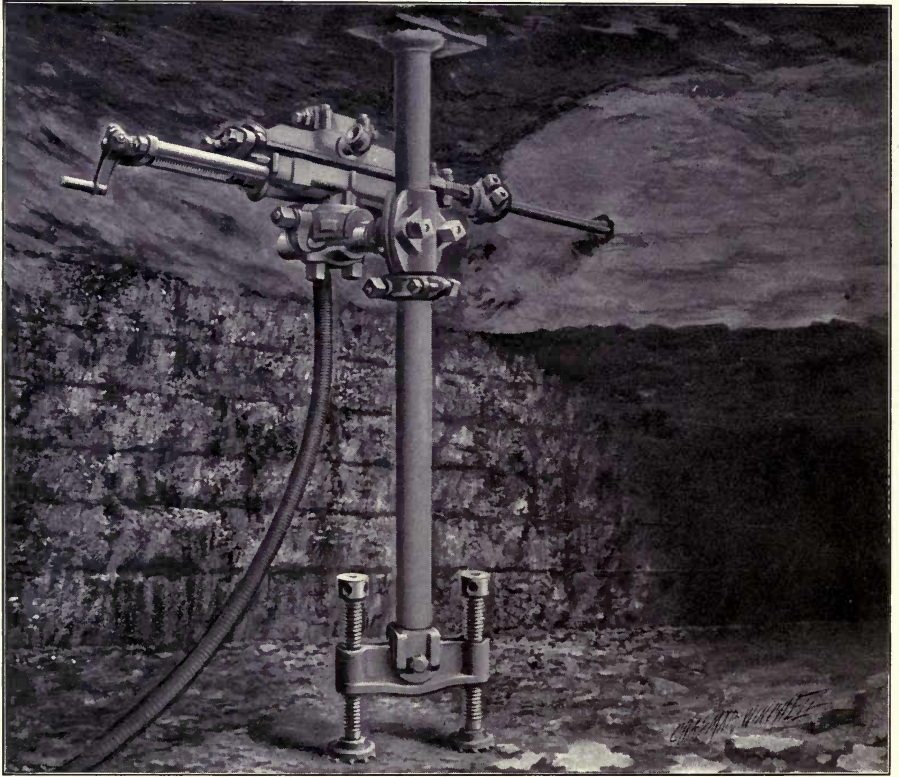

The Sullivan Rock Drill. Rock drill mounted on double screw column at work in coal mine taking down roof

The Sullivan Rock Drill

For Excavating Rock



A PERCUSSIVE rock drill is a very valuable and useful adjunct in and about coal mines, as it may be used successfully and economically in shaft sinking, in driving slopes or drifts through solid rock, in taking down roof or in lifting

bottom to obtain increased height, and in driving through "faults" or "horsebacks"; in fact, a Sullivan Rock Drill will save much time and expense over any other means of driving through rock. In general, about coal mines very little attention has been paid to the cost of rock excavation, and this in many cases is one of the serious leaks in expense.

The Sullivan Rock Drill is a reciprocating or striking machine driven by compressed air or steam, and is the result of years of careful study and experimenting. In its design, special attention has been given to the strengthening of parts found to cause continuous trouble in other makes, and also to the reduction of the number of working parts, the object being to exceed the drilling capacity of any other machine, and at the same time greatly reduce the cost for repairs.

For rapid work, special attention has been given to the design of the valve motion, to secure a hard, quick blow, which can be regulated as to length of stroke and force of blow to give the best results in starting the hole and working through seams in broken rock.

The valves are designed for either steam or air, and when air is used will not freeze up or stick. The valves

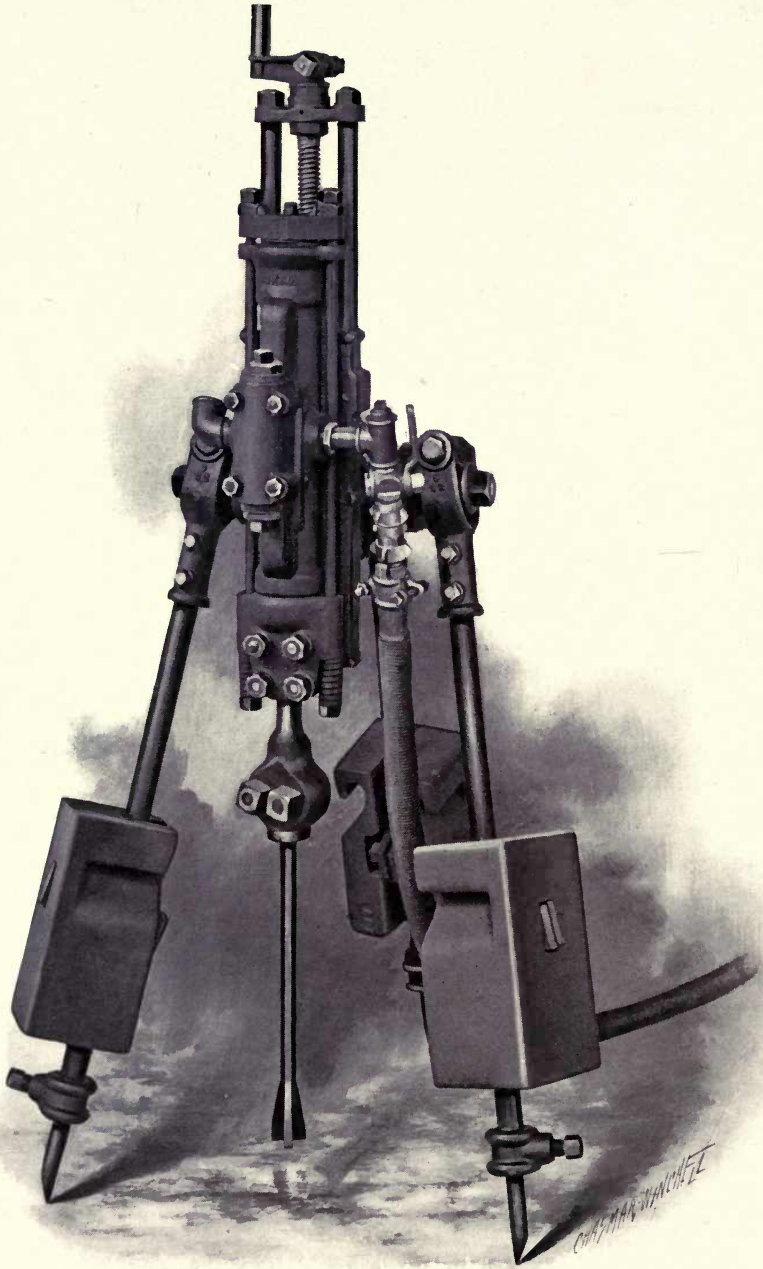

The Sullivan Rock Drill mounted on adjustable tripod

are balanced, making the wear but slight and allowing the whole power of the steam or air to be utilized for effective work instead of wasted in overcoming friction.

Another important requirement in a rock drill valve motion has been provided for in the Sullivan, viz., that the drill should have a powerful up stroke or lift. This is fully as important as a heavy down stroke or blow, and comes into play in the proper "mudding" of the drill-hole (keeping the mud well out from below the bit) and securing rapid work in caving or seamy ground, which tends to stick the drill steel. There are several drills on the market that are good in hard ground but inefficient in soft, or vice versa; but it is claimed for the Sullivan that it will give the best results obtainable in either—that it is an all-round machine.

To secure economy, the drill is so constructed as to do rapid work with the least possible consumption of steam or air, and simplicity and strength united with speed make the cost of work low. Cost of repairs will be found slight, as the drill is strong and durable. The working parts are simple, and are made perfectly interchangeable, so that parts worn out or broken by accident may be easily and rapidly replaced.

Further economy and convenience are secured by making the drills, tripods, columns and all attachments easy to adjust, compact, and as light as consistent with ample strength. The tripod may be set conveniently for all classes of work, and the weights quickly removed and easily handled.

The improved features of the drill, tripod, etc., are all covered by patents.

If interested in rock drills, send for the special catalogue on this subject.

Weights and Specifications of Sullivan Rock Drills (Unmounted)

LETTER INDICATING SIZE	UA	US	UB	UC	UD	UE	UF	UH	UK
Diameter of cylinder, inches.	2	2¼	2½	2¾	3	3½	3¾	3¾	4¼
Length of stroke, inches.	4½	5	5	6½	6½	6½	7	7½	8
Length of feed (depth drilled with- out changing steel), inches.	12	15	20	24	24	24	24	30	30
Depth of hole machine will drill easily. Feet, from 1 to.	4	5	6	10	12	14	16	20	28
Diameter of holes that may be drilled, inches.	¾ to 1¾	¾ to 2	1 to 2¾	1¼ to 2½	1¼ to 3	1¼ to 3	1¼ to 3	1½ to 4	2 to 5
Diameter of drill steel used, inches	¾ to ¾	¾ to 1	¾ to 1	1 to 1½	1¼ to 1¼	1¼ to 1¼	1¼ to 1¼	1¼ to 1¾	1½ to 1½
Number of pieces in set of steel to drill holes to depth above stated	4	4	4	5	6	7	8	8	10
Diameter of steam inlet, inches. ...	¾	¾	¾	1	1	1	1	1¼	1¼
Size of hose to connect to drill, inches.	¾	¾	¾	1	1	1	1	1¼	1¼
Size of steam pipe to carry steam 100 to 200 feet, inches.	¾	1	1	1	1¼	1¼	1¼	1½	1½
Size of boiler to supply steam for one drill, horse power.	5	6	8	8	8	10	10	12	15
Weight of drill unmounted, pounds	95	130	140	210	240	245	320	375	520
Shipping weight of drill boxed, pounds.	120	160	175	250	285	295	375	440	590
Size of tripod.	U2	U2	U3	U3	U3 & U6	U6	U6	U7	U7
Size of mining column or shaft bar	U31	U31	U24	U24	U27	U27	U27	U29	U29
Code word for drill unmounted, for steam.	<i>Bajado</i>	<i>Bajanos</i>	<i>Bajesid</i>	<i>Bajillo</i>	<i>Bajith</i>	<i>Bajonula</i>	<i>Bajoujo</i>	<i>Bajular</i>	<i>Bajury</i>
Code word for drill unmounted, for air.	<i>Bajac</i>	<i>Bajam</i>	<i>Bajel</i>	<i>Baji</i>	<i>Bajoa</i>	<i>Bajoun</i>	<i>Bajuz</i>	<i>Bajuco</i>	<i>Bajub</i>

For weights and specifications of mountings for attaching above drills, see pages 129 and 130.

A table is given on page 90 showing the compressed air requirements of from one to forty Sullivan rock drills.

The Sullivan Adjustable Tripod: Weights and Specifications

Size	Used with Drills Size	Weight in Pounds			Code Word
		Tripod Only	(3) Weights Only	Total Shipping	
U 2	UA, US	110	216	326	<i>Bamboozle</i>
U 3	UB, UC	200	306	506	<i>Bamburral</i>
U 6	UD, UE, UF	230	342	572	<i>Banalidade</i>
U 7	UH, UK	345	390	735	<i>Banality</i>

For weights and specifications of rock drills for attaching to the above tripods, see page 128.

NOTE.—The U D drill can be used on U 3 tripod if the work is light, but this mounting is not recommended for deep holes.

Weights and Specifications, Sullivan Mining Columns, Shaft and Stopping Bars

Size	Diameter of Column in Inches	Size of Drills used with the Different Columns	Single Screw Mining Column, Shaft or Stopping Bar with Saddle				Double Screw Mining Column with Adjustable Arm and Saddle			
			6 Feet in Length		8 Feet in Length		6 Feet in Length		8 Feet in Length	
			Weight in Pounds, Column with Saddle	Code Word	Weight in Pounds, Column with Saddle	Code Word	Weight in Pounds, Column with Adjustable Arm and Saddle	Code Word	Weight in Pounds, Column with Adjustable Arm and Saddle	Code Word
U 21	3	UA, US	100	<i>Bardatos</i>	120	<i>Bardenkoor</i>	165	<i>Bardisch</i>	180	<i>Bashemath</i>
U 24	4	UB, UC	185	<i>Bardatum</i>	215	<i>Bardenited</i>	320	<i>Bardismic</i>	350	<i>Basiabas</i>
U 27	4½	UD, UE, UF	215	<i>Bardajes</i>	245	<i>Bardennes</i>	380	<i>Bardling</i>	400	<i>Basiabo</i>
U 29	5½	UH, UK	240	<i>Bardandoli</i>	280	<i>Bardeorum</i>	430	<i>Bardolf</i>	470	<i>Basiabunt</i>

In ordering columns, state minimum length required, allowing for wood blocking at both ends. The jackscrews enable the columns to be lengthened several inches.

If longer or shorter column than 6 or 8 feet is required, use code word as above, and in addition state length. Any length columns are made.

For weights and specifications of rock drills (unmounted) for attaching to above mining columns, shaft and stopping bars, see page 128.

Weights and Specifications of Drill Steels for Sullivan Rock Drills

(Formed and Sharpened, but not Tempered)

For Drill "UA"—2 Inches—Feed 12 Inches				
Size of Shank, $\frac{3}{8}$ in. x $3\frac{3}{8}$ in.				
Regular Size of Gauge	Length Steel will Cut	Name of Each Length	Size of Steel	Weight in Pounds
$1\frac{1}{2}$	1 ft. 0 in.	Starter	$\frac{7}{8}$ in.	$3\frac{1}{2}$
$1\frac{3}{8}$	2 ft. 0 in.	2d length	$\frac{7}{8}$ in.	5
$1\frac{1}{4}$	3 ft. 0 in.	3d length	$\frac{3}{4}$ in.	6
$1\frac{1}{8}$	4 ft. 0 in.	4th length	$\frac{3}{4}$ in.	$7\frac{1}{2}$
1	5 ft. 0 in.	5th length	$\frac{3}{4}$ in.	9
Code word, set to 3 ft.				<i>Betaalde</i>
Code word, set to 4 ft.				<i>Betaculi</i>
Code word, set to 5 ft.				<i>Betaculus</i>
For Drill "US"—2 $\frac{1}{4}$ Inches—Feed 15 Inches				
Size of Shank, $\frac{7}{8}$ in. x 4 in.				
Regular Size of Gauge	Length Steel will Cut	Size of Steel		Weight in Pounds
$1\frac{3}{4}$ in.	1 ft. 3 in.	1 in.		5
$1\frac{5}{8}$ in.	2 ft. 6 in.	1 in.		9
$1\frac{1}{2}$ in.	3 ft. 9 in.	$\frac{7}{8}$ in.		10
$1\frac{3}{8}$ in.	5 ft. 0 in.	$\frac{7}{8}$ in.		13
$1\frac{1}{4}$ in.	6 ft. 3 in.	$\frac{7}{8}$ in.		16
Code word, set to 3 ft. 9 in.				<i>Betagt</i>
Code word, set to 5 ft. 0 in.				<i>Betakelen</i>
Code word, set to 6 ft. 3 in.				<i>Betalter</i>
For Drill "UB"—2 $\frac{1}{2}$ Inches—Feed 20 Inches				
Size of Shank, $\frac{7}{8}$ in. x 4 $\frac{1}{4}$ in.				
Regular Size of Gauge	Length Steel will Cut	Size of Steel		Weight in Pounds
$1\frac{3}{4}$ in.	1 ft. 8 in.	1 in.		7
$1\frac{5}{8}$ in.	3 ft. 4 in.	1 in.		11
$1\frac{1}{2}$ in.	5 ft. 0 in.	$\frac{7}{8}$ in.		13
$1\frac{3}{8}$ in.	6 ft. 8 in.	$\frac{7}{8}$ in.		17
$1\frac{1}{4}$ in.	8 ft. 4 in.	$\frac{7}{8}$ in.		21
Code word, set to 5 ft. 0 in.				<i>Beterschap</i>
Code word, set to 6 ft. 8 in.				<i>Biconge</i>
Code word, set to 8 ft. 4 in.				<i>Biconvexo</i>
For Drill "UC"—2 $\frac{3}{4}$ Inches—Feed 24 Inches				
Size of Shank, 1 in. x 4 $\frac{1}{2}$ in.				
Regular Size of Gauge	Length Steel will Cut	Size of Steel		Weight in Pounds
$2\frac{1}{4}$ in.	2 ft. 0 in.	$1\frac{1}{8}$ in.		10
2 in.	4 ft. 0 in.	$1\frac{1}{8}$ in.		18
$1\frac{7}{8}$ in.	6 ft. 0 in.	1 in.		20
$1\frac{1}{2}$ in.	8 ft. 0 in.	1 in.		25
$1\frac{3}{8}$ in.	10 ft. 0 in.	1 in.		30
$1\frac{1}{4}$ in.	12 ft. 0 in.	1 in.		35
Code word, set to 6 ft. 0 in.				<i>Bicorpor</i>
Code word, set to 8 ft. 0 in.				<i>Bicrural</i>
Code word, set to 10 ft. 0 in.				<i>Bicaculle</i>
Code word, set to 12 ft. 0 in.				<i>Bicuda</i>

Weights and Specifications of Drill Steels for Sullivan Rock Drills—Continued

For Drill "UD"—3 Inches } For Drill "UE"—3½ Inches } Feed 24 Inches For Drill "UF"—3¼ Inches }			
Size of Shank, 1½ in. x 4¾ in.			
Regular Size of Gauge	Length Steel will Cut	Size of Steel	Weight in Pounds
2½ in.	2 ft. 0 in.	1¼ in.	11
2¾ in.	4 ft. 0 in.	1½ in.	19
2¾ in.	6 ft. 0 in.	1¾ in.	23
2¾ in.	8 ft. 0 in.	1¾ in.	31
2 in.	10 ft. 0 in.	1¾ in.	39
1¾ in.	12 ft. 0 in.	1¾ in.	47
1¾ in.	14 ft. 0 in.	1¾ in.	55
1¾ in.	16 ft. 0 in.	1¾ in.	63
Code word, set to 10 ft. 0 in.			<i>Bidbank</i>
Code word, set to 12 ft. 0 in.			<i>Biddende</i>
Code word, set to 14 ft. 0 in.			<i>Bidelle</i>
Code word, set to 16 ft. 0 in.			<i>Bidelulf</i>
For Drill "UH"—3⅝ Inches—Feed 30 Inches			
Size of Shank, 1¼ in. x 5½ in.			
Regular Size of Gauge	Length Steel will Cut	Size of Steel	Weight in Pounds
3 in.	2 ft. 6 in.	1¾ in.	18
2¾ in.	5 ft. 0 in.	1¾ in.	32
2¾ in.	7 ft. 6 in.	1¾ in.	37
2¾ in.	10 ft. 0 in.	1¾ in.	48
2½ in.	12 ft. 6 in.	1¾ in.	59
2¾ in.	15 ft. 0 in.	1¾ in.	70
2¾ in.	17 ft. 6 in.	1¾ in.	81
2½ in.	20 ft. 0 in.	1¾ in.	92
Code word, set to 12 ft. 6 in.			<i>Bidplaats</i>
Code word, set to 15 ft. 0 in.			<i>Bidstond</i>
Code word, set to 17 ft. 6 in.			<i>Biquejar</i>
Code word, set to 20 ft. 0 in.			<i>Biquinho</i>
For Drill "UK"—4¼ Inches—Feed 30 Inches			
Size of Shank, 1½ in. x 6 in.			
Regular Size of Gauge	Length Steel will Cut	Size of Steel	Weight in Pounds
3½ in.	2 ft. 6 in.	1⅝ in.	27
3½ in.	5 ft. 0 in.	1⅝ in.	47
3½ in.	7 ft. 6 in.	1⅝ in.	66
3½ in.	10 ft. 0 in.	1⅝ in.	74
3½ in.	12 ft. 6 in.	1⅝ in.	90
3 in.	15 ft. 0 in.	1⅝ in.	107
2¾ in.	17 ft. 6 in.	1⅝ in.	123
2¾ in.	20 ft. 0 in.	1⅝ in.	140
2¾ in.	22 ft. 6 in.	1⅝ in.	156
2½ in.	25 ft. 0 in.	1⅝ in.	174
2½ in.	27 ft. 6 in.	1⅝ in.	190
Code word, set to 20 ft. 0 in.			<i>Birkens</i>
Code word, set to 22 ft. 6 in.			<i>Birkwein</i>
Code word, set to 25 ft. 0 in.			<i>Bialaba</i>
Code word, set to 27 ft. 6 in.			<i>Birlabais</i>

State whether + or × bits are wanted, and also give gauge or size hole required.

NOTE.—Regular gauge as above, with + bits, will be furnished unless otherwise directed.

As the temper of steel should vary according to the hardness of the rock, the drills are sent out untempered, thus allowing the local blacksmith to temper them to suit the special conditions.



AUTOMATIC
CROSS-OVER
DUMPS

SMC

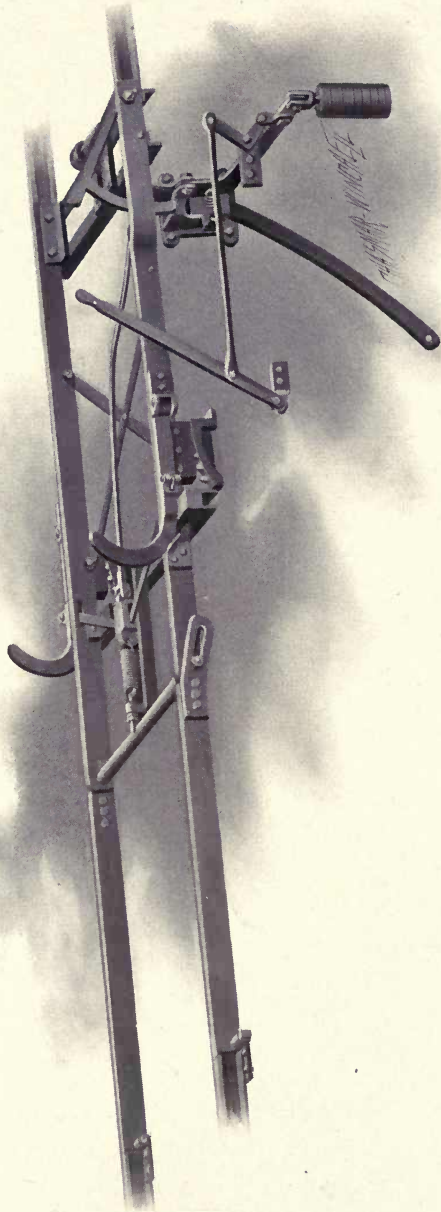

Wilson Automatic Cross-Over Dump

The Mitchell and Wilson Automatic Cross-Over Dumps

For Slope or Drift Mines



IN these days of large operations a great deal of attention has been given to the tippie, so that the coal may be dumped rapidly and economically, at the same time permitting

perfect screening with the least possible breakage of the coal. During past years a crude timber structure was usually erected at the mine opening, upon which an ordinary dump was placed. This dump was made so that the car had to be run upon it with considerable momentum, in order that the dump would tip at a sufficient angle to empty the car of its coal, and of course this resulted in the coal being thrown violently upon the chute or screen, thus breaking it and permitting of only imperfect screening. After the car had discharged its contents, the dump had to be pulled back to a horizontal position and the empty car backed off before the next loaded car could take its place on the dump. In order to reach a fair tonnage, five or six men were required upon the tippie to handle and re-handle the cars. It is now the customary practice to design a coal tippie so that every arrangement will be as convenient, economical and serviceable as possible for the production of a large tonnage. The crude tippie of bygone days has therefore given way to substantial wooden structures, and in many cases steel has been used for additional durability and safety.

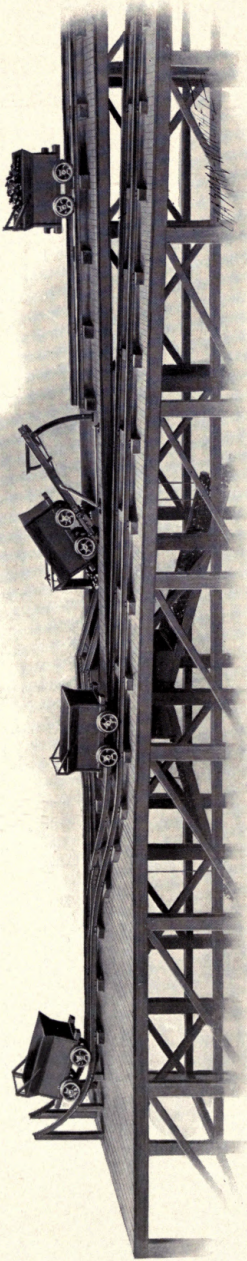

Tipple equipped with Wilson Automatic Cross-Over
Dump, showing movement of cars

To meet the conditions where greater tonnage and economies were desired, the Mitchell Automatic Cross-over Dump was designed and patented a number of years ago, its principal features being that the loaded car was run upon a tilting track section, was dumped, and, by reason of the difference in weight between the loaded and empty car, the tilting track section resumed a horizontal position automatically after the car had discharged its load. The next loaded car was then run forward, and the wheels striking a projecting arm on the track, threw the horns that held the first car in place, and running into the first car forced it across the dumping section. The first car being free from its load, continued forward and up a steep incline, returning by means of a spring switch upon the track for empty cars, the entire movement of the cars being regulated by gravity through specially constructed grades, which movement is shown by the engraving on the opposite page. By means of a friction brake the tilting of the car is completely under the control of the dumper, hence the coal is spread evenly over the screen and perfect screening is obtained with the least possible breakage of the coal.

Not having to back the empty car off the dump after being emptied permitted the Mitchell dump to vastly increase the tippable capacity of a mine with even fewer men than if the ordinary dump was in use. Actual runs of from 2,500 to 4,000 tons have been made over one of these automatic dumps in a shift.

Later were secured the rights and patents of the Wilson Automatic Cross-over Dump, which, embodying the same general features as the Mitchell, differed in some of the mechanical details. In the Mitchell dump the rails directly in front of the tilting section are spread as the car is being dumped, so that the coal in falling to the screen or chute below does not strike the rails; in the Wilson the front rails are dropped out of the way; otherwise these two dumps are practically identical. For narrow gauges of track, say thirty-six inches and less, the Mitchell is recommended, while for gauges of track in excess of thirty-six inches the Wilson dump is recommended.

Both of these dumps are strong and simple in construction, being built to withstand particularly hard use, and in the event of becoming damaged the mine blacksmith can usually make the necessary repairs.

But a small expense is necessary to arrange an old tippie for either of these dumps, simply requiring a new set of grades in approaching and leaving the dump and which any mine carpenter can construct, following blue prints furnished by the company. In the erection of a new tippie, the necessary grades may be built without any additional expense.

As each dump has to be especially made to conform to the mine car, the following car specifications are required in order to give a proper estimate on the cost, etcetera:

1. Length of mine car over all.
2. Distance between centers of axles.
3. Diameter of wheels.
4. Gauge of track.
5. Weight of empty car and loaded car.
6. Distance from center of axle to front end of draw-bar.



VENTILATING
FANS
WINDING
ENGINES

SMC

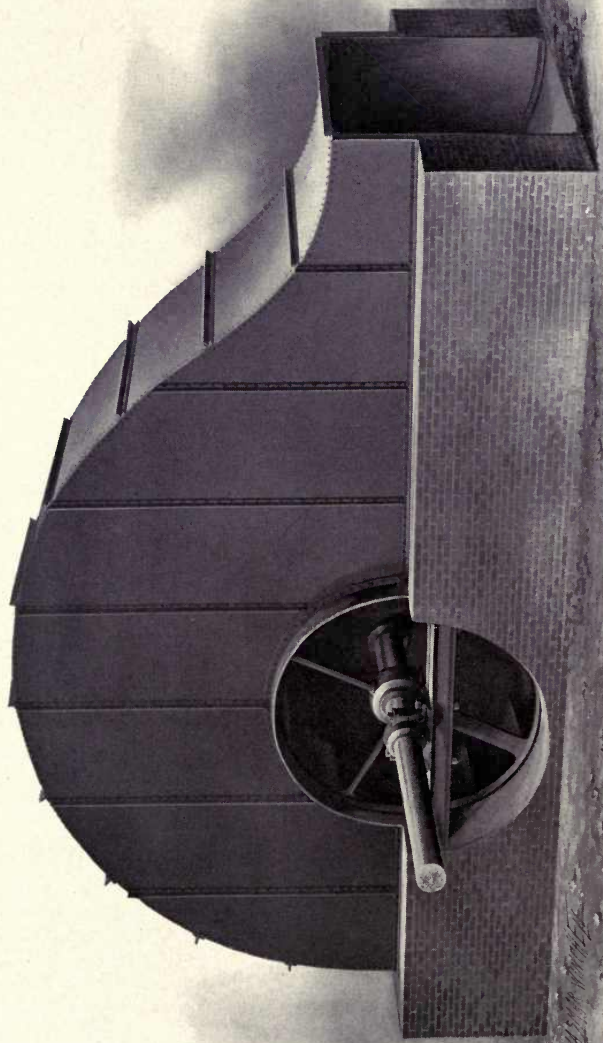

Champion Ventilator

The Champion Ventilator

A Fan for Ventilating Coal Mines



THERE is no question but that the tendency about most coal mines is to increase the pressure of the ventilating currents and the volume of air which enters the mine.

In times gone by, little attention was given to the problem of mine ventilation; in some cases no artificial means was provided, and in others a furnace was employed to move the air; but of course this was during the time of small operations. Along with the development of large mines with miles of air courses, the working of thin seams of coal, and particularly the operation of coal mines generating explosive or noxious gases, came a call for a fan of exceptional efficiency. The Champion Ventilator was designed to meet this growing demand, and, invented about thirty years ago, is the pioneer of all high pressure mine fans. Constant improvements since its first introduction have been made, fully keeping pace with the most advanced engineering practice.

The first fans were built of wood, but owing to the danger of fire and for sake of greater durability they are now built completely of sheet steel, thoroughly braced and stiffened. As it is a well-known fact that it is important to be able to reverse the air current within a mine, successful mine fans should be quickly convertible from blower to exhaust, or vice versa. This may be accomplished by two different devices. One consists of a reversible hood or inner casing which may be rotated around the axis by means of a

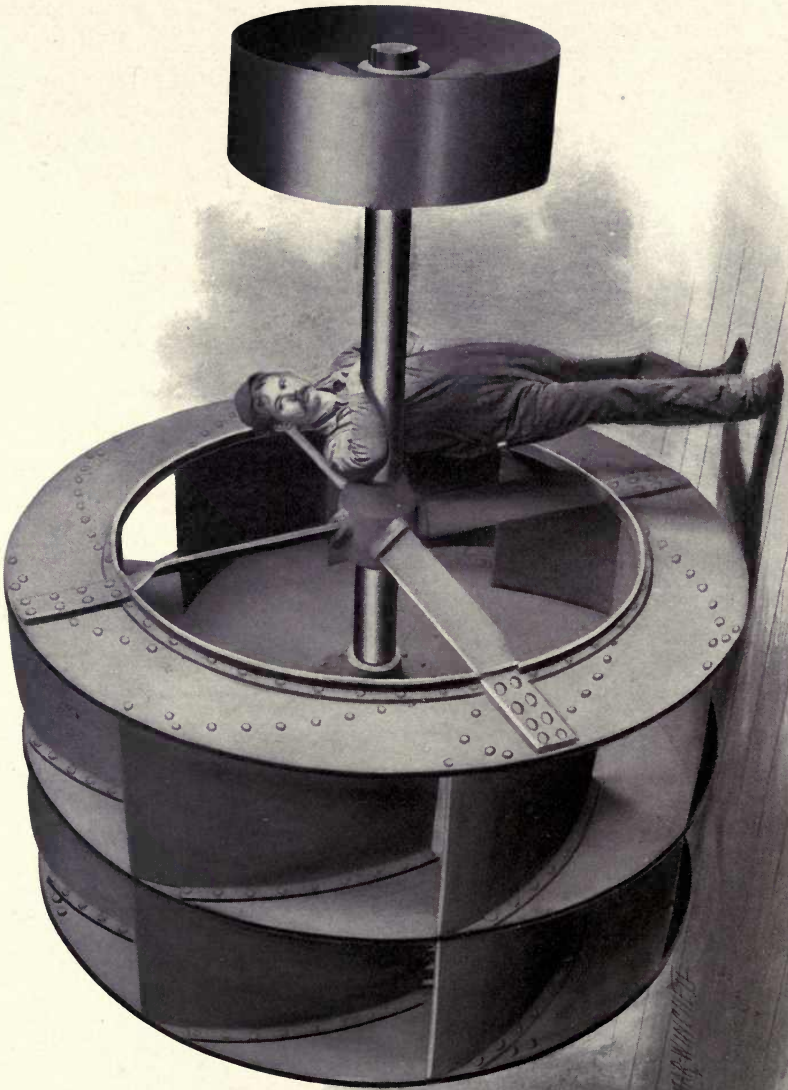

Champion Ventilator, Fan Wheel

hand wheel, thus causing the fan to become a blower or exhauster as desired. The other reverses the current by the opening or closing of doors located in the drift leading into the mine. The latter arrangement is generally preferred, as it is more simple and represents less initial cost. The fan wheel consists of practically two fans joined together by a common center ring, the openings in the sides being of ample size to admit the air freely to the interior and the blades. These are constructed with such a curvature as to propel or lift outward the maximum amount of air with the minimum resistance, and consequent minimum expenditure of power. As the water gauge or pressure of air is dependent upon the periphery speed of the fan wheel, it has been made very strong and stiff, to permit of fast rotation. The shaft is of large diameter and hence practically free from vibration; it is extended to one side of the fan for connection with the engine shaft if direct connected, or for attaching a pulley if belt driven.

If interested in mine fans, send for the special catalogue on this subject.

*Table of Improved Champion Ventilator
Steel Casing and Fan Wheel*

Fan Wheel				Discharge at Given Speed at 2 Inches Water Gauge Pressure, Cubic Feet per Minute	Actual Horse Power Engine Required	Code Word
Outside Diam. Feet	Width Over Vanes, Feet	Number of Revolu- tions per Minute	Speed at Tips of Vanes or Periphery Speed, Feet per Minute			
4	2	609	7,653	22,000	10.5	<i>Chasabor</i>
6	3	406	7,653	49,000	23.5	<i>Chasappa</i>
8	4	305	7,664	88,000	42.0	<i>Chasenon</i>
10	5	244	7,662	137,000	65.5	<i>Chaserio</i>
12	6	203	7,653	197,000	94.0	<i>Chasofic</i>
14	7	174	7,653	269,000	128	<i>Chasonat</i>
16	8	153	7,689	350,000	167	<i>Chasutos</i>

Table of Horse Powers

Theoretical and Actual Horse Power required to move a given quantity of air

Cubic Feet of Air	WATER GAUGE								
	½	¾	1	1¼	1½	1¾	2	2½	3
15,000	1.1	1.7	2.3	2.4	3.5	4.1	4.7	5.9	7.0
	1.6	2.5	3.5	4.1	5.2	6.5	7.1	8.9	11.0
20,000	1.5	2.3	3.1	3.9	4.7	5.5	6.2	7.8	9.5
	2.5	3.3	4.6	5.7	7.0	8.3	9.4	11.9	14.8
25,000	2.0	3.0	4.0	5.0	6.0	7.0	8.0	10.0	11.7
	2.8	4.3	5.8	7.3	8.8	10.6	12.1	15.1	18.3
30,000	2.2	3.4	4.6	4.8	7.0	8.2	9.4	11.8	14.0
	3.2	5.0	7.0	8.2	10.4	13.0	14.2	17.8	22.0
40,000	3.3	4.7	6.3	7.8	9.5	11.0	12.6	15.7	18.9
	4.7	6.7	9.0	11.5	14.0	16.6	19.5	23.7	29.5
50,000	3.9	5.9	7.9	9.8	11.8	13.8	15.7	19.6	23.5
	5.5	8.4	11.6	14.4	17.4	20.9	23.8	29.7	36.7
60,000	4.7	7.1	9.5	11.8	14.2	16.6	18.8	23.6	28.3
	6.7	10.1	14.0	16.4	20.8	25.2	28.5	35.7	44.3
70,000	5.5	8.2	11.0	13.7	16.5	21.2	22.0	27.5	33.0
	7.8	11.6	16.2	20.2	24.5	32.0	33.0	41.0	51.5
80,000	6.3	9.4	12.6	15.7	19.0	22.0	25.0	31.5	38.0
	9.0	13.4	18.5	23.1	28.0	33.3	37.9	47.7	59.5
85,000	6.6	9.9	13.3	16.5	20.0	23.2	27.0	33.5	40.0
	9.4	14.2	19.6	24.2	29.4	35.2	40.8	50.8	62.5
90,000	7.1	10.3	14.2	17.4	21.2	24.5	28.0	35.5	42.5
	10.1	15.2	20.5	25.6	31.2	37.2	42.5	53.0	66.5
100,000	8.0	12.0	16.0	20.0	24.0	28.0	32.0	40.0	47.0
	11.4	17.2	23.5	29.5	35.3	42.5	48.5	60.7	73.3
125,000	10.0	15.0	20.0	25.0	30.0	35.0	40.0	49.0	59.0
	14.3	21.4	29.4	36.8	44.1	53.0	60.7	74.2	92.0
150,000	12.0	18.0	24.0	30.0	36.0	42.0	47.0	59.0	71.0
	17.1	25.7	35.3	44.1	53.0	63.5	71.1	89.2	101.5
175,000	14.0	21.0	28.0	35.0	42.0	49.0	55.0	69.0	83.0
	20.0	30.0	41.2	51.2	61.8	74.0	83.2	102.3	123.0
200,000	16.0	24.0	32.0	40.0	47.0	56.0	63.0	79.0	94.0
	22.9	34.3	47.0	58.8	68.0	84.8	95.2	120.0	146.5
225,000	18.0	27.0	36.0	45.0	53.0	63.0	71.0	89.0	106.0
	25.7	38.6	53.0	66.0	78.0	95.2	107.6	132.5	166.0
250,000	19.5	29.3	39.0	48.8	59.0	68.3	79.0	98.0	118.0
	27.9	42.0	57.2	71.8	86.8	103.5	120.0	148.2	182.2
275,000	21.5	32.2	43.0	53.7	65.0	75.2	86.0	108.0	130.0
	30.7	45.7	63.2	78.8	95.5	114.0	130.1	162.0	203.0
300,000	23.5	35.2	47.0	58.7	71.0	82.2	94.0	118.0	141.0
	33.7	50.0	69.0	86.2	104.0	122.2	142.2	178.5	220.0
350,000	27.5	41.2	55.0	68.7	83.0	96.2	110.0	138.0	165.0
	39.3	59.0	80.8	100.5	120.0	140.8	167.0	209.0	257.8
400,000	31.5	47.3	63.0	78.8	95.0	110.3	126.0	157.0	189.0
	45.0	67.5	92.8	113.0	140.0	167.5	191.0	238.0	295.1
450,000	35.5	53.0	71.0	88.5	106.0	124.0	141.0	175.0	212.0
	50.9	75.1	104.0	130.0	156.0	188.0	214.0	265.0	330.0

Height of Water Column in Inches Corresponding to Pressures in Ounces or Pounds per Square Foot

Inches Water Gauge.....	½	¾	1	1¼	1½	1¾	2	2¼	2½	2¾	3	3¼	3½
Ounces.....	.29	.43	.58	.72	.87	1.01	1.16	1.30	1.44	1.59	1.74	1.88	2.08
Lbs. per Sq. Ft...	2.6	3.9	5.2	6.5	7.8	9.1	10.4	11.7	13.0	14.3	15.6	16.9	18.1

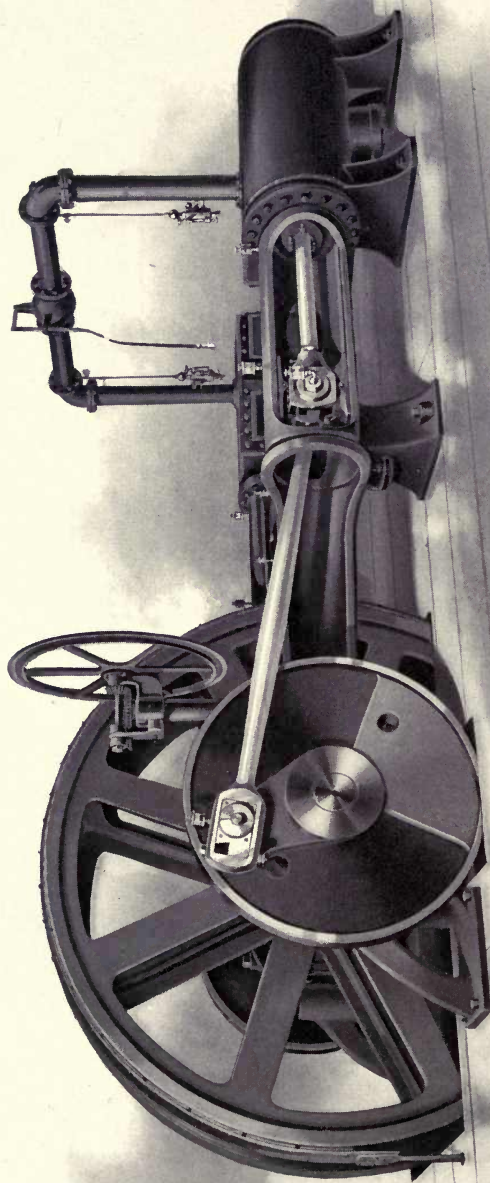

Sullivan First Motion Hoisting Engine. Balanced valves. Single drum

Sullivan Winding Engines

For Hoisting and Hauling



THIS company makes a specialty of large hoisting and hauling engines, which are constructed with especial reference to simplicity, compactness, efficiency and durability. Sullivan Winding Engines are fully up to modern requirements,

and before shipment is made the engines are tested under full steam pressure, thus insuring that every part is in perfect condition for immediate and continuous duty.

The Corliss frame with bored cross-head guides has been adopted as giving the greatest strength and stiffness. For large hoisting engines, the Corliss valve movement is recommended for the steam cylinders, but quotations will be furnished on steam cylinders fitted with "balanced" slide valves. Where it is practicable to hoist in balance, and where a large output is desired, the "first motion" hoist is advised. In this class of hoisting engine the drum or drums are keyed to a very heavy engine shaft, the wearing surfaces, especially the main bearings, are made of liberal area, and all through the engines are strongly proportioned to stand severe work. Automatic stops are provided, which, in case of overwinding, shut off the steam and apply the brakes to the drum. Suitable indicators show the position of the cages in the shaft. These engines are built with standard or conical drums and with brakes arranged for applying by hand or steam pressure or both. In many cases where flat rope is employed, the drums are substituted by reels. The

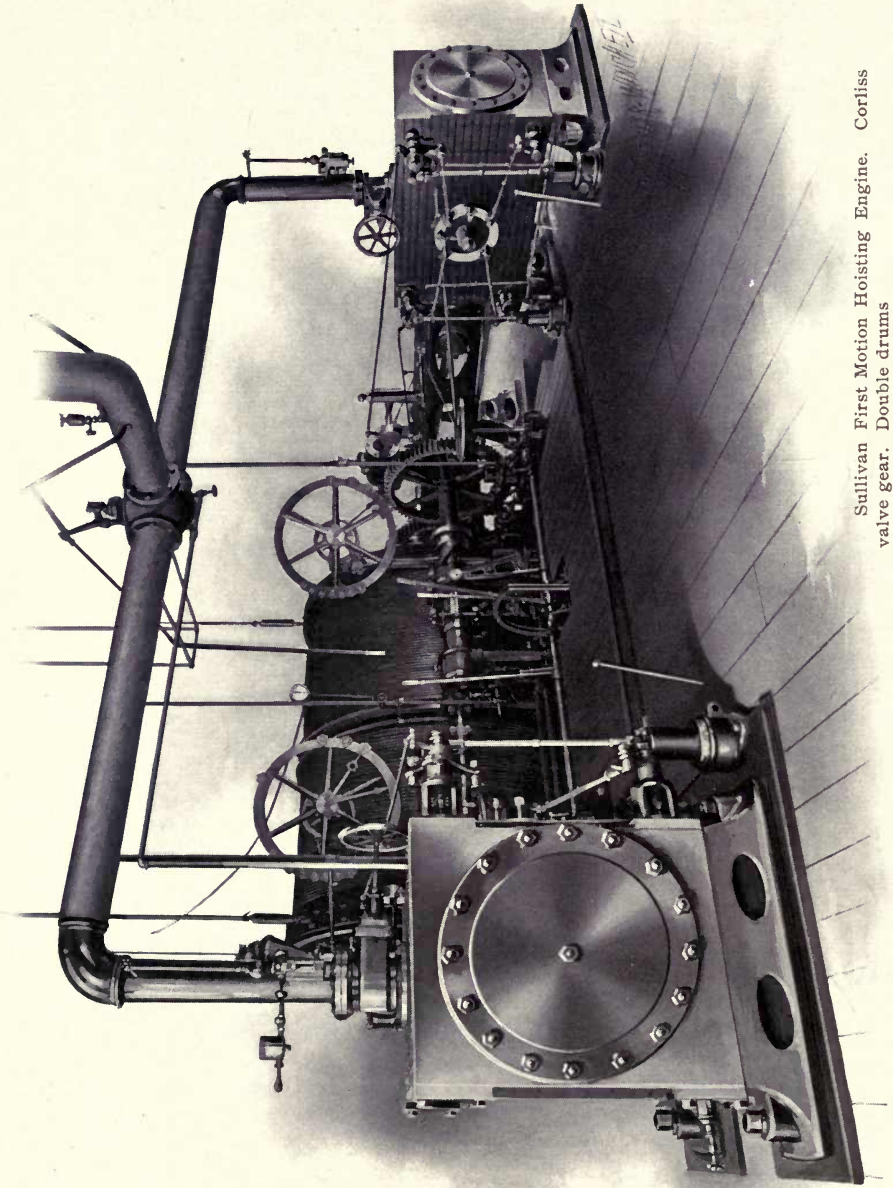

Sullivan First Motion Hoisting Engine. Corliss valve gear. Double drums

company also builds geared hoists where the drums are driven by carefully proportioned jaw or band friction clutches connected to the engine shaft.

Herein are illustrated only a few of the different styles of Sullivan Winding Engines, but specifications and estimates will be furnished for any proposition of hoisting or hauling about mines, and particularly hoisting from shafts or slopes, tail or endless rope haulage.

If interested in winding engines, send for the special catalogue on this subject.

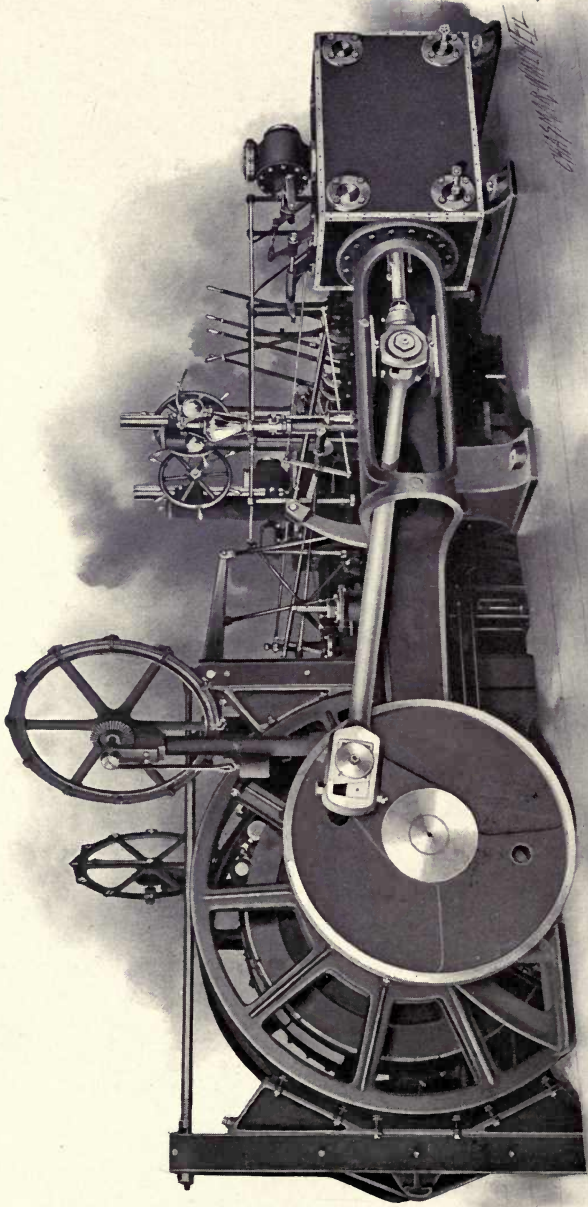

Sullivan First Motion Double Reel Hoist. Corliss
valve gear

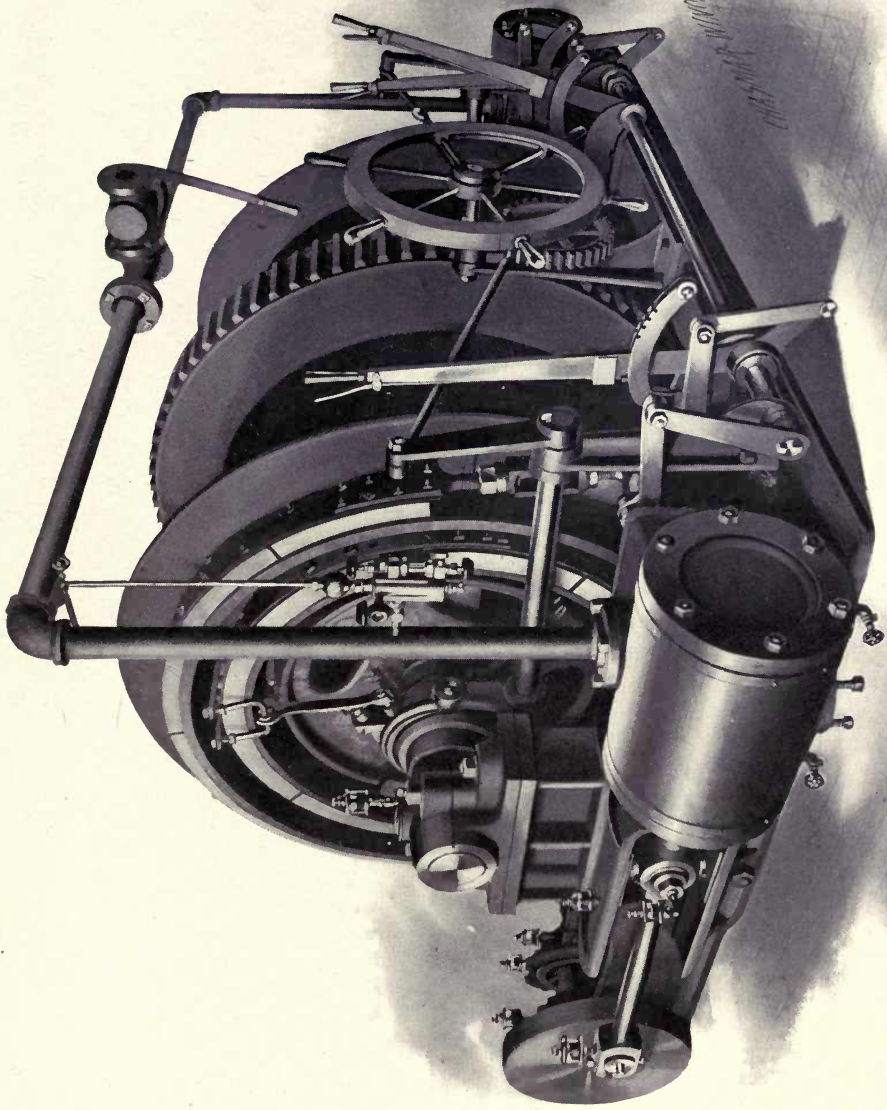

Sullivan Band-Friction Hauling Engine. Double cylinders and drums

A	Page
Air Compressors	81
Air Receivers	107

C	
Coal Machines	
Electric Chain	43
Long Wall	61
Pick	21
Shearing	35
Code Words for Coal Mines	67
Compressors, Air	81
Contract Diamond Drilling	123

D	
Drills	
Diamond	111
Rock	125
Dumps, Automatic	135

E	
Electric Chain Machines	43
Engines, Winding	147
Equipment	
With Diamond Drills	
.	116, 117, 122
With Electric Chain Machines	51
With Pick Machines	30

F	
Fans, Mine	141

H	
Hoisting Engines	147
Hose, Air	32

I	
Introductory	11

L	
Long Wall Machine	61

M	
Mining Machines	
Electric Chain	43
Long Wall	61
Pick	21
Shearing	35
Mining Wheels	31

P	Page
Picks	32
Pick Machines	21
Postlude	153

R	
Receivers, Air	107
Rock Drills	125

S	
Shearing Machines	35
Shearing Wheels	31

T	
Tables	
Air Requirement of Machines	99
Approximate Analyses of Coals	77
Average Price of Coal	78
Branch Pipes	106
Coal Mined by Machines in United States	74
Coal Mined by Machines in United States, number of Machines	75
Efficiency, Air Compressors	98
Friction, for Air	102
Mining Scales	71
Power to Compress Air	98
Production of Coal in United States, Total	73
Production of Coal in United States, Percentage Mined by Machines	76
Trucks	
For Pick Machine	33
Power, for Chain Machine	59
Standard, for Chain Machine	58

V	
Ventilator for Mines	141

W	
Winding Engines	147

P o s t l u d e

If this book has pleased or interested you, it has served its mission well, and acknowledgment of its receipt is respectfully requested. In a work of this size and character errors are liable to creep in and the company will appreciate having attention called to them.

Correspondence in reference to the machines herein illustrated and described is earnestly solicited, and patrons may be assured that it will receive prompt and courteous attention.

SULLIVAN MACHINERY COMPANY.



UNIVERSITY OF CALIFORNIA LIBRARY
BERKELEY

Return to desk from which borrowed.
This book is DUE on the last date stamped below.

22 May '50 AR

INTERLIBRARY LOAN

MAR 30 1981

UNIV. OF CALIF., BERK.

LD 21-100m-11,'49 (B7146s16)476

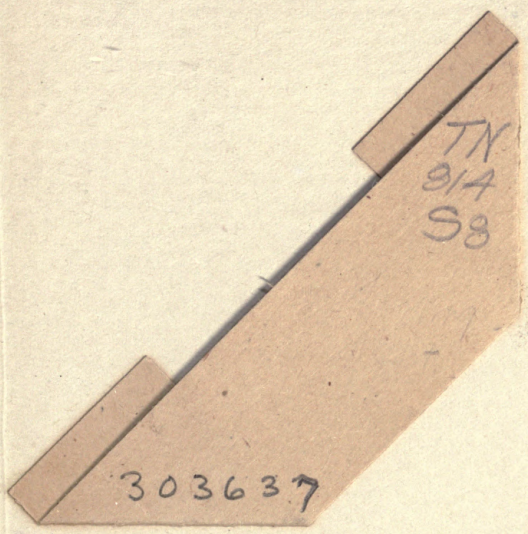

TX
9/4
S8

303637

