

SB
195
S53
1914

UC-NRLF

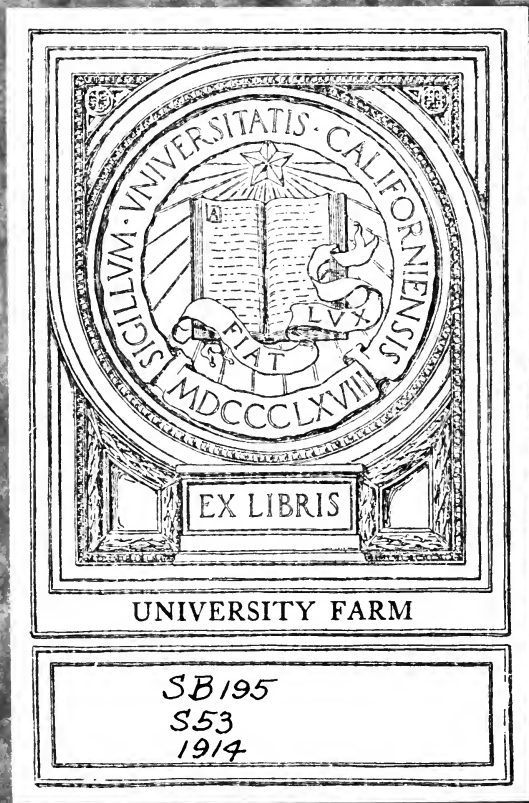

\$B 660 144



UNIVERSITY FARM

SB195
S53
1914

Modern SILAGE Methods

Tenth Edition

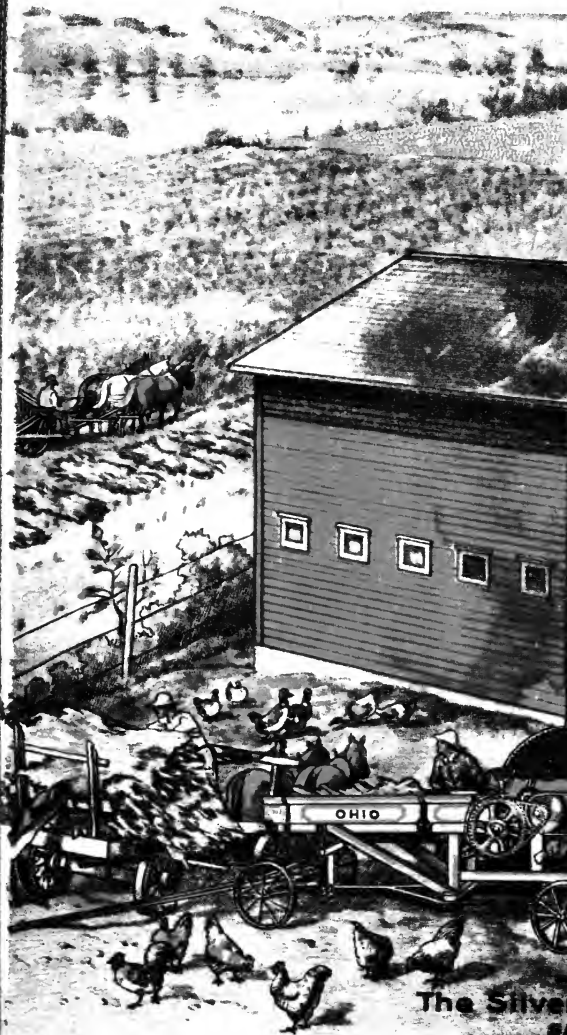

PUBLISHED BY
The Silver Manufacturing Co.
SALEM, OHIO, U.S.A.

PUBLISHERS' STATEMENT

We DO NOT manufacture or handle silos, and are not interested in silos in any way except from an educational standpoint. This attitude enables us to discuss the various types of silos in an entirely impartial manner.

We have been publishing educational literature on silos and silage for over thirty years, fully two decades before the farm papers of the country began to boost the subject. This pioneer work explains why "Modern Silage Methods" has become the standard text book now used in so many State Agricultural Colleges for class-room use.

We do however manufacture the famous line of Silver's "Ohio" Silo Fillers and Feed Cutters as illustrated and described in the back part of this volume, and if the reader will kindly investigate and consider the merits of this line of Silo Fillers when in the market, we will feel amply paid for the trouble and expense of publishing this valuable book.

Respectfully,

THE SILVER MANUFACTURING CO.

Salem, Ohio, Nov. 2, 1914.



MODERN SILAGE METHODS

LIBRARY
635.7
S58
LATEST REVISED EDITION
WITH ILLUSTRATIONS

An entirely new and practical work on Silos, their construction and the process of filling, to which is added complete and reliable information regarding Silage and its composition; feeding, and a treatise on rations, being a

FEEDERS' AND DAIRYMEN'S GUIDE

PUBLISHED
AND COPYRIGHTED BY

THE SILVER MANUFACTURING CO.
SALEM, OHIO, U. S. A.

Revised and Brought UP THE SILVER MFG. CO.
WILLIAM L. WRIGHT

3

11034

Copyrighted November 1914, by
THE SILVER MANUFACTURING CO.

PRINTED BY
THE BERING-WISCONSIN
PRINTING COMPANY
MILWAUKEE



CATALOGUE AND
BOOKLET PRINTERS



PREFACE.

This book has been written and published for the purpose of furnishing our patrons and others with accurate and full information on the subject of silo construction and the making of silage. It has been our aim to present the subject in a clear, matter-of-fact manner, without flourish or rhetoric, believing that the truth concerning the advantages of the siloing system is good enough. The testimony presented, which is purposely kept close to the experience of authorities on feeding subjects in and outside of experiment stations, will abundantly prove, we believe, that the equipment of a dairy or stock farm in almost any part of the world is no longer complete without one or more silos on it.

The new chapter on "Silage Crops for the Semi-Arid Regions and for the South" will be of widespread interest to thousands in the Great Southwest, and the chapters on "The Summer Silo," and "The Use of Silage in Beef Production," will be found especially timely. Chapter III. covers a great variety of silos made of material other than wood. In all other respects the book has been revised and brought up to date.

In order that a work of this kind be accurate and reliable, and bear the scrutiny of scientific readers, the use of a number of scientific terms and phrases is rendered necessary, and in order that these may be more readily comprehended by agriculturists, a comprehensive glossary of such terms is included, following the last chapter, which can be referred to from time to time, or can be studied previous to reading the book.

In the compilation of certain parts of the book and in the revision of the "Feeder's Guide" we have had the valuable assistance of Prof Woll, of California Experiment Station, formerly of Wisconsin, author of "A Book on Silage" and "A Handbook for Farmers and Dairymen." Free use of the former book has been made in the preparation of this volume, as well as of experiment station publications treating the subject of silage.

Hoping that this latest revision of "Modern Silage Methods" will prove helpful to our patrons, and incidentally suggest to them that the "OHIO" Silage Cutters and Blower Elevators are manufactured by us, we are,

Very truly,

THE SILVER MFG. CO.

TABLE OF CONTENTS.

PREFACE	3
INTRODUCTORY	7-10

CHAPTER I.

Advantages of the Silo—Preservation of a larger quantity of original food value enabled by the use of the Silo than any method known—Losses of nutritive value in dry curing—Small losses in the Siloing Process—The Silo furnishes a feed of uniform quality—Economy of making—Economy of storage—No danger of rain—No danger of late summer droughts—Food from thistles—Value in intensive farming—Other advantages	11-20
---	-------

CHAPTER II.

How to Build a Silo.

Silos—General requirements for silo structures—On the size of silo required—On the form of silos—Relations of horizontal feeding—Area and number of cows kept—Daily ration of silage for different kinds of stock—Location of the silo—Different types of silo structures—Round wooden silos—The silo roof—Ventilation of Silo—Painting the Lining—Modifications of the Wisconsin Silo—Plastered round wooden Silos—Brick-lined Silos—Stave Silos—Cheap Stave Silos—Silo Doors—A modification of a stave Silo—Connecting round silos with the barn—Other forms of round silos—Octagonal Silos—Cost and estimates for different kinds.	21-81
---	-------

CHAPTER III.

Silos Other Than Wood.

Monolithic concrete or cement silos—Horizontal and vertical reinforcement necessary—Continuous doorways—Method of tying roof—Hy-Rib concrete reinforced silos—Metal-lath plastered silos—Modifications, double and single wall—Cement Block silos, one- and two-piece—Patented sectional block silos—Cement Stave silos—Vitrified Tile silos—Brick silos, single and double wall—All-Metal silos—Underground or Pit silos—Foundations and Roofs for silos.	82-110
--	--------

CHAPTER IV.

Summer Silos.

Necessary in supplementing summer pastures and in tiding herd over period of drouth, heat and flies—Reduces pasture acreage required—Avoids labor of soiling crop system—Oregon results—Purdue Station Experiments—Solves summer drouth problem—Permits night pasturing—Storage of surplus crops—Comments by the agricultural press—Feeding of summer silage111-117

CHAPTER V.

Silage in Beef Production.

Value and Economy of Silage for fattening steers—Experiments made twenty-five years ago—Beef producing area vastly increased by use of silo—Stock-Yards are strong boosters for silage—Results by Nebraska, Pennsylvania, Missouri, South Carolina, North Carolina, Illinois, Indiana and South Dakota Stations—Results in Saskatchewan, Kansas, Iowa, and Texas—Results in the South118-129

CHAPTER VI.

Silage System and Soil Fertility.

Helps maintain soil fertility—Every crop grown robs soil of fertilizing elements—Value of Such Fertility Lost—Restoration has vital bearing on our crop yields—Stock, dairy and mixed farming vs. hay and grain farming—Value of barnyard manure—Every farm a manure factory with silage—Keeping fertility on the farm—Restoring Fertility in the South . . .130-138

CHAPTER VII.

Silage Crops.

Indian corn—Soils best adapted to corn culture and preparation of land—Varieties of corn for the silo—Time of cutting corn for the silo—Dry Matter in Corn at Different Stages—Methods of planting corn—All other silage crops139-159

CHAPTER VIII.

Silage Crops for the Arid and Semi-Arid Regions.

Importance of Sorghum. Kafir and Milo for silage—Mixtures of the sorghums and other crops—Cowpeas, field peas, soy beans. alfalfa, beet leaves and tops, Russian thistle, etc.—Conditions in the Great Southwest—Silage crops for the Southern States	160-172
---	---------

CHAPTER IX.

Filling the Silo—Indian Corn—Siloing corn "ears and all"—The filling process—Proper method of unloading—The proper distribution of cut material in the silo—Tramping—Size of cutter and power required—Length of chain elevator required—Directions for operating "Ohio" Blower Cutters—Danger from carbonic-acid poisoning in silos—Covering the siloed fodder—Use of water in filling silos—Clover for summer silage—Freezing of silage—Steamed silage	173-189
--	---------

CHAPTER X.

How to feed silage—Silage for milch cows—Silage in the production of certified milk—Silage for beef cattle—for Horses and Mules—for Sheep—for Swine—Silage for poultry—Additional testimony as to the advantage of silage—Corn silage as compared with root crops—Corn silage as compared with hay—Corn silage compared with fodder corn—Cost of Producing Succulent Crops—How to Estimate Cost of Silage	190-211
---	---------

CHAPTER XI.

A feeder's guide—Composition of the animal body—Composition of feeding stuffs—Digestibility of foods—Relative value of feeding stuffs—Feeding standards—How to figure out rations—Grain mixtures for dairy cows—Average composition of Silage crops of different kinds, in per cent—Analysis of feeding stuffs—Ready reference tables	212-240
GLOSSARY	241-245
CONCLUSION	246
INDEX	247-256

Modern Silage Methods.

INTRODUCTION.

Thirty years ago few farmers knew what a silo was, and fewer still had ever seen a silo or fed silage to their stock. Today silos are as common as barn buildings in many farming districts in this country, and thousands of farmers would want to quit farming if they could not have silage to feed to their stock during the larger portion of the year. Thirty years ago it would have been necessary to begin a book describing the siloing system with definitions, what is meant by silos and silage; now all farmers who read agricultural papers or attend agricultural or dairy conventions are at least familiar with these words, even if they have not had a chance to become familiar with the appearance and properties of silage. They know that a SILO is an air-tight structure used for the preservation of green, coarse fodder in a succulent condition, and that SILAGE is the feed taken out of a silo.

We shall later see which crops are adapted for silage making, but want to state here at the outset that Indian corn is pre-eminently the American crop suited to be preserved in silos, and that this crop is siloed far more than all other kinds of crops put together. When the word silage is mentioned we, therefore, instinctively think of corn silage. We shall also follow this plan in the discussions in this book; when only silage is spoken of we mean silage made from the corn plant; if made from other crops the name of the crop is always given, as clover silage, peavine silage, etc.

History of the Silo.—While the silo in one form or another dates back to antiquity, it was not until the latter part of the seventies that the building of silos intended for manufacture of silage began in this country. In 1882 the United States Department of Agriculture could find only ninety-one farmers in this country who used silos. During the last twenty-five years, however, silos have gradually become general in all sections of the country where dairying and stock-raising are important industries; it is likely, if a census were taken of the number of silos in this country today, that we would find between a half

and three-fourths of a million of them. Wisconsin alone, according to a report issued by the Orange Judd publications, had 41,555 silos on Jan. 1, 1914, and figuring the same ratio of increase for 1914 as for 1913, would have 52,334. The same report showed 130,303 silos in thirteen dairy states of the Mississippi valley and the 1914 increase figuring as above would indicate a total of 170,837. The most rapid strides in silo building, however, have been made in the Southwest. On Sept. 1st, 1914, there were 8,560 silos in Texas and 4800 more under construction. In Kansas there were 7,137 silos in March 1914 and taking the report as authentic that there were only 60 silos in the state in 1909, the increase in the five years amounts to 11,800 per cent. Oklahoma silos increased 50 per cent. in 1913 alone. Not only has the use of silos spread to every section of the United States, but the corn belt has been pushed steadily northward, with the result that the building of silos is making headway in Manitoba, Alberta, Saskatchewan, British Columbia and the Canadian Northwest generally. During the past two years there has been a wonderful increase in the interest taken in the subject, an interest fostered by the example set by the Canadian Government Experimental Farms and the literature available from them.

The silo stands today among the most important, practical and profitable adjuncts of the farm. It is a big dividend-paying investment—not an expense. It has long been considered a necessity on thousands of dairy farms and we find most of them in the states that rank first as dairy states, viz.: New York, Wisconsin, Iowa, Illinois, Pennsylvania, etc. The farmers that have had most experience with silage are the most enthusiastic advocates of the siloing system, and the testimony of intelligent dairymen all over the country is strongly in favor of the silo. Said a New York farmer recently in one of our main agricultural papers: "I would as soon try to farm without a barn as without a silo," and another wrote, "I wouldn't take a thousand dollars for my silo if I could not replace it." The well-known agricultural writer, Joseph E. Wing, says: "No stock feeder who grows corn can afford to ignore the silo." "Buff Jersey," an Illinois dairy farmer and writer on agricultural topics, declares his faith in silage as follows: "I am fully satisfied that silage is a better feed, and a cheaper one, than our pastures." Another writer says: "The silo to my mind presents so many advantages over the system of

soiling that it is bound to eventually do away with the use of soiling crops." Prof. Eckels, of the Missouri Agricultural College, says: "I would not attempt to produce milk in this state or any other state in the Corn Belt without being provided with a silo of sufficient capacity to supply silage through the winter, and preferably with sufficient capacity to contain enough for a supplement for a short pasture in the summer." Prof. Pew, of the Iowa Experiment Station, says: "By the liberal use of silage the cost of wintering the breeding herd of beef cows can be cut down nearly one-third; also the cows will come through the winter in better condition."

Our first effort in writing this book will be to present facts that will back up these statements, and show the reader the many advantages of the silo over other systems of growing and curing crops for the feeding of farm animals. We shall show that up-to-date dairy or stock farming is well nigh impossible without the aid of a silo. The silo enables us to feed live stock succulent feeds the year around, and preserves the fodder in a better condition and with less waste than any other system can. We shall see the why and wherefore of this in the following pages, and shall deal with the best way of making and feeding silage to farm animals. We wish to state at the outset that we do not propose to make any claims for the silo that will not stand the closest investigation. In the early days of the history of the silo movement it was thought necessary to make exaggerated claims, but this is no longer the case. Naked facts are sufficient to secure for the silo a permanent place among the necessary equipment of a modern dairy or stock farm. In discussing the silo we shall keep close to what has been found out at our experiment stations, and, we believe, shall be able to prove to any fair-minded reader that the silo is the greatest boon that has come to modern agriculture since the first reaper was manufactured, and that with competition and resulting low prices, it will be likely to become more of a necessity to our farmers in the future than it has been in the past. We aim to convince our readers that the most sensible thing they can do is to plan to build a silo at once if they do not now have one. It is unnecessary to argue with those who are already the happy possessors of a silo, for it is a general experience where a farmer has only provided for immediate wants in building his silo that he will build another as

soon as he has had some experience with silage and finds out how his stock likes it, and how well they do on it.

The life of the silo should always be carefully considered in connection with its initial cost. A silo might be built for \$150 which would last ten years, the cost exclusive of upkeep being \$15 a year. With the use of better materials or construction on the same size silo its life might be increased to twenty years at an additional outlay of perhaps \$50, which it will be readily seen is much cheaper per year. Quality usually goes hand in hand with price and the farmer who can afford it should not make the mistake of building anything but the best if he wishes to economize to greatest advantage.

Modern practice has proved that no man need say "I cannot afford a silo," because any farmer who is at all handy with hammer and saw can provide a silo large enough for moderate requirements with very little actual outlay of money, and this same built-at-home silo will earn for its owner money to build a better one and enlarge his herd. Directions for building several kinds of such silos are given in the following pages. It must not be expected that they will last as long or will prove as economical in the long run as more substantially-built factory-made silos, still they give excellent service until the farmer can afford to put up a structure of better quality. Experience in making and feeding silage will be gained at much less cost by using a good silo in the beginning.

We mention this fact here to show farmers who may be considering the matter of building a silo, or who may be inclined to think that the silo is an expensive luxury, only for rich farmers, that the cost of a silo need not debar them from the advantages of having one on their farm, and thus secure a uniform succulent feed for their stock through the whole winter. Farmers who have not as yet informed themselves in regard to the value of the silo and silage on dairy or stock farms, are respectfully asked to read carefully the following statements of the advantages of the silo system over other methods of preserving green forage for winter or summer feeding.

It has been said that "Whoever makes two blades of grass grow where but one grew before is a benefactor to mankind." A silo makes it possible to keep two cows where but one was kept before, and who would not gladly double his income? Does not this interest you?

CHAPTER I.

ADVANTAGES OF THE SILO.

The silo enables us to preserve a larger quantity of the food materials of the original fodder for the feeding of farm animals than is possible by any other system of preservation now known. Pasture grass is the ideal feed for live stock, but it is not available more than a few months in the year. The same holds true with all soiling crops or tame grasses as well. When made into hay the grasses and other green crops lose some of the food materials contained therein, both on account of unavoidable losses of leaves and other tender parts, and on account of fermentations which take place while the plants are drying out.

In cases of Indian corn the losses from the latter source are considerable, owing to the coarse stalks of the plant and the large numbers of air-cells in the pith of these. Under the best of conditions cured fodder corn will lose at least ten per cent. of its food value when cured in shocks; such a low loss can only be obtained when the shocks are cared for under cover, or out in the field under ideal weather conditions: In ordinary farm practice the loss in nutritive value will approach twenty-five per cent., and will even exceed this figure unless special precautions are taken in handling the fodder, and it is not left exposed to all kinds of weather in shocks in the field through the whole winter. These figures may seem surprisingly large to many farmers who have left fodder out all winter long, and find the corn inside the shock bright and green, almost as it was when put up. But appearances are deceitful; if the shocks had been weighed as they were put up, and again in the late winter, another story would be told, and it would be found that the shocks only weighed anywhere from a third to a half as much as when they were cured and ready to be put in the barn late in the fall; if chemical analysis of the corn in the shocks were made late in the fall, and when taken down, it would be seen that the decrease in weight was not caused by evaporation of water from the fodder, but by waste of food materials contained therein from fermentations, or action of enzymes. (See Glossary.)

The correctness of the figures given above has been abundantly proved by careful experiments conducted at a number of different experiment stations, notably the Wisconsin, New Jersey, Vermont, Pennsylvania, and Colorado experiment stations. A

summary of the main work in this line is given in Prof. Woll's Book on Silage. In the Wisconsin experiments there was an average loss of 23.8 per cent. in the dry matter (see Glossary) and 24.3 per cent. of protein, during four different years, when over 36 tons of green fodder had been put up in shocks and carefully weighed and sampled at the beginning and end of the experiment. These shocks had been left out for different lengths of time, under varying conditions of weather, and made from different kinds of corn, so as to present a variety of conditions. The Colorado experiments are perhaps the most convincing as to the losses which unavoidably take place in the curing of Indian corn in shocks. The following account is taken from Prof. Cook's report of the experiments. As the conditions described in the investigation will apply to most places on our continent where Indian corn is cured for fodder, it will be well for farmers to carefully look into the results of the experiment.

"It is believed by most farmers that, in the dry climate of Colorado, fodder corn, where cut and shocked in good shape, cures without loss of feeding value, and that the loss of weight that occurs is merely due to the drying out of the water. A test of this question was made in the fall of 1893, and the results obtained seemed to indicate that fully a third of the feeding value was lost in the curing. This result was so surprising that the figures were not published, fearing that some error had crept in, though we could not see where there was the possibility of a mistake.

"In the fall of 1894 the test was repeated on a larger scale. A lot of corn was carefully weighed and sampled. It was then divided into three portions; one was spread on the ground in a thin layer, the second part was set up in large shocks, containing about five hundred pounds of green fodder in each, while the rest was shocked in small bundles. After remaining thus for some months, until thoroughly cured, the portions were weighed, sampled and analyzed separately. The table gives the losses that occurred in the curing.

Table I. Losses in Curing.

	Large Shocks		Small Shocks		On the Ground	
	Total Weight	Dry Matter	Total Weight	Dry Matter	Total Weight	Dry Matter
	Lbs.	Lbs.	Lbs.	Lbs.	Lbs.	Lbs.
When Shocked	952	217	294	77	186	42
After Curing	258	150	64	44	33	19
Loss in Weight	694	67	230	33	153	23
Per Cent of Loss	73	31	78	43	82	55

"So far as could be told by the eye, there had been no loss. The fodder had cured in nice shape, and the stalks on the inside of the bundles retained their green color, with no sign of molding or heating. And yet the large shocks had lost 31 per cent. of their dry matter, or feeding value; the small shocks 43 per cent. and the corn spread on the ground 55 per cent.

"On breaking or cutting the stalks these losses were explained. The juice was acid, and there was a very strong acid odor, showing that an active fermentation was taking place in this seemingly dry fodder. We had noticed this strong odor the fall before and all through the winter. When the fodder corn for the steers is put through the feed cutter that same strong smell is present.

"It can be said, then, that the dryness of the climate in Colorado does not prevent fodder corn from losing a large part of its feeding value through fermentation. Indeed, the loss from this source is fully as great as in the damp climate in New England.

"As compared with the losses by fermentation in the silo, the cured fodder shows considerably the higher loss."

In experiments at the Wisconsin station eleven shocks cured under cover in the barn lost on an average over 8 per cent. of dry matter and toward 14 per cent. of protein. In an experiment at the Maine Station over 14 per cent. of dry matter was lost in the process of slow drying of a large sample of fodder corn under the most favorable circumstances. "It is interesting to note that this loss falls almost entirely on the nitrogen-free extract, or carbohydrates (see Glossary), more than two-thirds of it being actually accounted for by the diminished percentage of sugars."

Since such losses will occur in fodder cured under cover with all possible care, it is evident that the average losses of dry matter in field-curing fodder corn, given in the preceding, by no means can be considered exaggerated. Exposure to rain and storm, abrasion of dry leaves and thin stalks, and other factors tend to diminish the nutritive value of the fodder, aside from the losses from fermentations, so that very often only one-half of the food materials originally present in the fodder is left by the time it is fed out. The remaining portion of the fodder has, furthermore, a lower digestibility and a lower feeding value than the fodder corn when put up, for the reason that the fermentations occurring during the curing process destroy the most valuable and easily digestible part, i. e., the sugar and starch of the nitrogen-free extract, which are soluble, or readily rendered soluble, in the process of digestion.

2. **Losses in the Siloing Process.**—As compared with the large losses in food materials in field-curing of Indian corn there are but comparatively small losses in the silo, caused by fermentation processes or decomposition of the living plant cells as they are dying off. The losses in this case have been repeatedly determined by experiment stations, and, among others, by those mentioned in the preceding. The average losses of dry matter in the fodder corn during the siloing period, of four seasons (1887-'91) as determined by Prof. Woll at the Wisconsin Experiment Station was about 16 per cent. The silos used in these trials, as in case of nearly all the early experiments on this point, were small and shallow, however, only 14 feet deep, were rectangular in form, and not always perfectly air-tight, a most important point in silo construction, as we shall see, and a portion of the silage therefore came out spoilt, thus increasing the losses of food materials in the siloing process. The losses reported were, therefore, too great, and there is now an abundance of evidence at hand showing that the figures given are higher than those found in actual practice, and the necessary loss in the silo comes considerably below that found in the early experiments on this point. There are plenty of cases on record showing that ten per cent. represents the maximum loss of dry matter in modern deep, well-built silos. The losses found in siloing corn at a number of experiment stations during the last ten years have come at or below this figure. It is possible to reduce the loss still further by avoiding any spoilt silage on the surface, by beginning to feed immediately after the filling of the silo, and by feeding the silage out rather rapidly. Experiments conducted on a small scale by Prof. King in 1894 gave losses of only 2 and 3 per cent. of dry matter, on the strength of which results, amongst others, he believes that the necessary loss of dry matter in the Silo **need not exceed 5 per cent.**

Summarizing our considerations concerning the relative losses of food materials in the field-curing and siloing of Indian corn, we may, therefore, say that far from being less economical than the former, the silo is more so, under favorable conditions for both systems, and that therefore a larger quantity of food materials is obtained by filling the corn crop into a silo than by any other method of preserving it known at the present time.

What has been said in the foregoing in regard to fodder corn applies equally well to other crops put into the silo. A few words

will suffice in regard to two of these, clover and alfalfa. Only a few accurate siloing experiments have been conducted with clover, but enough has been done to show that the necessary losses in siloing this crop do not much, if any, exceed those of Indian corn. Lawes and Gilbert, of the Rothamsted Experiment Station, England, placed 264,318 pounds of first and second crop clover into one of these stone silos, and took out 194,470 pounds of good clover silage. Loss in weight, 24.9 per cent. This loss fell, however, largely on the water in the clover. The loss of dry matter amounted to only 5.1 per cent., very nearly the same amount of loss as that which the same experimenter found had taken place in a large rick of about forty tons of hay, after standing for two years. The loss of protein in the silo amounted to 8.2 per cent. In another silo 184,959 pounds of second-crop grass and second-crop clover were put in, and 170,941 pounds were taken out. Loss in gross weight, 7.6 per cent.; loss of dry matter, 9.7 per cent.; of crude protein, 7.8 per cent.

In a siloing experiment with clover, conducted at the Wisconsin Station, on a smaller scale, Mr. F. G. Short obtained the following results: Clover put into the silo, 12,279 pounds; silage taken out, 9,283 pounds; loss, 24.4 per cent.; loss of dry matter, 15.4 per cent.; of protein, 12.7 per cent.

There is nothing in any of these figures to argue against the siloing of green clover as an economical practice. On the other hand, we conclude that this method of preserving the clover crop is highly valuable, and, in most cases, to be preferred to making hay of the crop.

No extended investigation has been made as to the losses sustained in the siloing of alfalfa, but there can be little doubt but that they are considerably smaller than in making alfalfa hay, if proper precautions guarding against unnecessary losses in the silo are taken. According to the testimony of Professor Headden of the Colorado Experiment Station, the minimum loss from the falling off of leaves and stems in successful alfalfa hay making amounts to from 15 to 20 per cent., and in cases where the conditions have been unfavorable, to as much as 60 and even 66 per cent. of the hay crop. Aside from the losses sustained through abrasion, rain storms, when these occur, may reduce the value of the hay one-half. The losses from either of these sources are avoided in preserving the crop in the silo, and in their place a

small loss through fermentation occurs, under ordinary favorable conditions, amounting to about 10 per cent. or less.

There is this further advantage to be considered when the question of relative losses in the silo and in hay-making or field-curing green forage, that hay or corn fodder, whether in shocks or in the field or stored under shelter, gets poorer and poorer the longer it is kept, as the processes of decomposition are going on all the time; in the silo, on the other hand, the loss in food substances is not appreciably larger six months after the silo was filled than it is one month after, because the air is shut out, so that the farmer who puts up a lot of fodder corn for silage in the fall can have as much and as valuable feed for his stock in the spring, or in fact, the following summer or fall, as he would have if he proceeded to feed out all the silage at once.

"Generally speaking, 3 tons of silage are equal in feeding value to one ton of hay. On this basis a much larger amount of digestible food can be secured from an acre of silage corn than from an acre of hay. The food equivalent of 4 tons of hay per acre can easily be produced on an acre of land planted to corn."—(Plumb.)

3. Succulence. Succulent food is nature's food.—We all know the difference between a juicy, ripe apple and the green dried fruit. In the drying of fruit as well as of green fodder water is the main component taken away; with it, however, go certain flavoring matters that do not weigh much in the chemist's balance, but are of the greatest importance in rendering the food material palatable. It is these same flavoring substances which are washed out of the hay with heavy rains, and renders such hay of inferior value, often no better than so much straw, not because it does not contain nearly as much food substances, like protein, fat, starch, sugar, etc. (see Glossary), but because of the substances that render hay palatable having been largely removed by the rain.

The influence of well-preserved silage on the digestion and general health of animals is very beneficial, according to the unanimous testimony of good authorities. It is a mild laxative, and acts in this way very similarly to green fodders. The good accounts reported of the prevention of milk fever by the feeding of silage are explained by the laxative influence of the feed.

4. Uniformity. The silo furnishes a feed of uniform quality, and always near at hand, available at any time during the whole year or winter. No need of fighting the elements, or wading

through snow or mud to haul it from the field; once in the silo the hard work is over, and the farmer can rest easy as to the supply of succulent roughage for his stock during the winter. An ample supply of succulent feed is of advantage to all classes of animals, but perhaps particularly so in case of dairy cows and sheep, since these animals are especially sensitive to sudden changes in the feed. Also, stock raisers value silage highly on this account, for silage is of special value for feeding preparatory to turning cattle onto the watery pasture grass in the spring. The loss in the weight of cattle on being let out on pasture in spring is often so great that it takes them a couple of weeks to get back where they were when turned out. When let out in the spring, steers will be apt to lose weight, no matter whether silage or dry feed has been fed, unless they are fed some grain during the first week or two after they are turned out. For more detailed information regarding the feeding of silage for beef production, see chapter V.

5. Economy of Storage.—Less room is required for the storage in a silo of the product from an acre of land than in cured condition in a barn. A ton of hay stored in the mow will fill a space of at least 400 cubic feet; a ton of silage, a space of about 50 cubic feet. Considering the dry matter contained in both feeds we have found that 8,000 pounds of silage contains about as much dry matter as 2,325 pounds of hay, or 160 against 465 cubic feet, that is, it takes nearly three times as much room to store the same quantity of food materials in hay as in silage. In case of field-cured fodder corn, the comparison comes out still more in favor of the silo, on account of the greater difficulty in preserving the thick cornstalks from heating when placed under shelter. According to Professor Alvord, an acre of corn, field-cured, stored in the most compact manner possible, will occupy a space ten times as great as in the form of silage. While hay will contain about 86 per cent. of dry matter, cured fodder corn often does not contain more than 60 and sometimes only 50 per cent. of dry matter; the quantities of food material in fodder corn that can be stored in a given space are, therefore, greatly smaller than in case of hay, and consequently, still smaller than in case of silage.

Since smaller barns may be built when silage is fed, there is less danger of fire, thus decreasing the cost of insurance.

6. No Danger of Rain.—Rainy weather is a disadvantage in

filling silos as in most other farm operations, but when the silo is once filled, the fodder is safe, and the farmer is independent of the weather throughout the season.

If the corn has suffered from drought and heat during the fall months, it is quite essential to wet the corn either as it goes into the silo, or when this has all been filled, in order to secure a good quality of silage; and unless the corn is very green when it goes into the silo, the addition of water, or water on the corn from rain or dew, will do no harm. If the corn is too dry when put into the silo, the result will be dry mold, which is prevented by the addition of the water, which replaces that which has dried out previous to filling if this has been delayed.

A common practice among successful siloists is to fill the silo when the lower leaves of the standing corn have dried up about half way to the ears. Generally, the corn will be in about the proper condition at that time, and there will still be moisture enough left in the plants so that the silage will come out in first-class condition.

There must be moisture enough in the corn at time of filling the silo, so that the heating processes, which take place soon after, and which expel a considerable portion of the moisture, can take place, and still leave the corn moist after cooling, when the silage will remain in practically a uniform condition for several years if left undisturbed. But if, on account of over-ripeness, frosts, or excessive drought, the corn is drier than stated, it should be made quite wet as stated above, and there is little danger of getting it too wet. The writer has filled silo with husked corn fodder about Christmas, and as the fodder was thoroughly dried, a $\frac{3}{4}$ -inch pipe was connected with an overhead tank in the barn and arranged to discharge into the carrier of the cutter as the cutting took place, a No. 18 Ohio cutter being used for that purpose. Although a full stream was discharged, and with considerable force, on account of the elevation of the tank, and the cut fodder in the silo still further wet on top with a long hose attached to a wind force pump, it was found, on opening the silo a month later, that none too much water had been used; the fodder silage came out in good condition, was eaten greedily by the milch cows, and was much more valuable than if it had been fed dry from the field.

Where haymaking is precluded, as is sometimes the case with second-crop clover, rowen, etc., on account of rainy weather late

in the season the silo will furthermore preserve the crop, so that the farmer may derive full benefit from it in feeding it to his stock. Frosted corn can also be preserved in the silo, and will come out a very fair quality of silage if well watered as referred to above.

7. **No danger of Late Summer Droughts.**—By using the silo with clover or other green summer crops early in the season, a valuable succulent feed will be at hand at a time when pasture in most regions is apt to give out; then again, the silo may be filled with corn when this is in the roasting-ear stage, and the land thus entirely cleared earlier than when the corn is left to mature and the corn fodder shocked on the land, making it possible to finish fall plowing sooner and to seed the land down to grass or winter grain.

8. **Food from Thistles.**—Crops unfit for haymaking may be preserved in the silo and changed into a palatable food. This is not of the importance in this land of plenty of ours that it is, or occasionally has been, elsewhere. Under silage crops are included a number of crops which could not be used as cattle food in any other form than this, as ferns, thistles, all kinds of weeds, etc. In case of fodder famine the silo may thus help the farmer to carry his cattle through the winter.

9. **Value in Intensive Farming.**—More stock can be kept on a certain area of land when silage is fed, than is otherwise the case. The silo in this respect furnishes a similar advantage over field-curing fodders, as does the soiling system over that of pasturage; in both the siloing and soiling system there is no waste of feed, all food grown on the land being utilized for the feeding of farm animals, except a small unavoidable loss in case of the siloing system incurred by the fermentation processes taking place in the silo.

Pasturing stock is an expensive method of feeding, as far as the use of the land goes, and can only be practiced to advantage where this is cheap. As the land increases in value, more stock must be kept on the same area in order to correspondingly increase the profits from the land. The silo here comes in as a material aid, and by its adoption, either alone or in connection with the soiling system, it will be possible to keep at least twice the number of animals on the land that can be done under the more primitive system of pasturing and feeding dry feeds during the winter.

The experience of Goffart, "the Father of Modern Silage," on this point is characteristic. On his farm of less than eighty-six acres at Burtin, France, he kept a herd of sixty cattle, besides fattening a number of steers during the winter, and eye-witnesses assure us that he had ample feed on hand to keep one hundred head of cattle the year around.

10. Other Advantages.—Silage feeding does away with all aggravating corn-stalks in the manure, and prevents their waste as well. It excels dry feed for the cheap production of fat beef. It keeps young stock thrifty and growing all winter and enables the cows to produce milk and butter more economically. Its use lessens the labor required to care for a herd, if it is conveniently attached to the barn or feeding shed. It allows the spring pastures to be conserved until the opportune moment, and can be fed at any time of the year as occasion demands. It enables preservation of food which matures at a rainy time of the year, when drying would be almost impossible. It does away with the system of strictly grain farming where few of the elements are returned to the soil. It increases digestive capacity, that is: the chemical action that takes place is an aid to digestion that enables the cow to eat more than she otherwise could digest and assimilate, thus making more milk from the same food elements than she could make from any other dairy food product.

We might go on and enumerate many other points in which the siloing process has decidedly the advantage over the method of field-curing fodder or haymaking; but it is hardly necessary. The points given in the preceding will convince any person open to conviction, of the superiority of the silo on stock or dairy farms. As we proceed with our discussion we shall have occasion to refer to several points in favor of silage as compared with dry feed, which have not already been touched upon. We shall now, first of all, however, proceed to explain the method of building silos of all kinds, after which we will discuss the summer silo, the wonderful progress of silage in beef production, and of its help in maintaining soil fertility. The subject of silage crops and of the making and feeding of silage will then follow.

CHAPTER II.

HOW TO BUILD A SILO.

Before taking up for consideration the more important type of silo construction, it will be well to explain briefly a few fundamental principles in regard to the building of silos which are common to all types of silo structures. When the farmer understands these principles thoroughly, he will be able to avoid serious mistakes in building his silo and will be less bound by specific directions, that may not always exactly suit his conditions, than would otherwise be the case. What is stated in the following in a few words is in many cases the result of dearly-bought experiences of pioneers in siloing; many points may seem self-evident now, which were not understood or appreciated until mistakes had been made and a full knowledge had been accumulated as to the conditions under which perfect silage can be secured.

General Requirements for Silo Structures.

1. **The silo must be air-tight.**—We have seen that the process of silage making is largely a series of fermentation processes. Bacteria (small plants or germs, which are found practically everywhere) pass into the silo with the corn or the siloed fodder, and, after a short time, begin to grow and multiply in it, favored by the presence of air and an abundance of feed materials in the fodder. The more air at the disposal of the bacteria, the further the fermentation process will progress. If a supply of air is admitted to the silo from the outside, the bacteria will have a chance to continue to grow, and more fodder will therefore be wasted. If a large amount of air be admitted, as is usually the case with the top layer of silage, the fermentation process will be more far-reaching than is usually the case in the lower layers of the silo. Putrefactive bacteria will then continue the work of the acid bacteria, and the result will be rotten silage. If no further supply of air is at hand, except what remains in the interstices between the siloed fodder, the bacteria will gradually die out, or only such forms will survive as are able to grow in the absence of air.

Another view of the cause of the changes occurring in siloed

fodder has been put forward lately, viz., that these are due not to bacteria, but to "intramolecular respiration" in the plant tissue, that is due to a natural dying-off of the life substance of the plant cells. From a practical point of view it does not make any difference whether the one or the other explanation is correct. The facts are with us, that if much air is admitted into the silo, through cracks in the wall or through loose packing of the siloed mass, considerable losses of food substances will take place, **first**, because the processes of decomposition are then allowed to go beyond the point necessary to bring about the changes by which the silage differs from green fodder, and, **second**, because the decomposition will cause more or less of the fodder to spoil or mold.

2. **The silo must be deep.** Depth is essential in building a silo, so as to have the siloed fodder under considerable pressure, which will cause it to pack well and leave as little air as possible in the interstices between the cut fodder, thus reducing the losses of food materials to a minimum. The early silos built in this country or abroad were at fault in this respect; they were shallow structures, not over 12-15 ft. perhaps, and were longer than they were deep. Experience showed that it was necessary to weight heavily the siloed fodder placed in these silos, in order to avoid getting a large amount of moldy silage. In our modern silos no weighting is necessary, since the material placed in the silo is sufficiently heavy from the great depth of it to largely exclude the air in the siloed fodder and thus secure a good quality of silage. In case of deep silos the loss from spoiled silage on the top is smaller in proportion to the whole amount of silage stored; there is also less surface in proportion to the silage stored, hence a smaller loss occurs while the silage is being fed out, and since the silage is more closely packed, less air is admitted from the top. As the silage packs better in a deep silo than in a shallow one, the former kind of silos will hold more silage per cubic foot than the latter; this is plainly seen from the figures given in the table on page 25. Silos built during late years have generally been over thirty feet deep, and many are forty feet deep or more.

3. **The silo must have smooth, perpendicular walls,** which will allow the mass to settle without forming cavities along the walls. In a deep silo the fodder will settle several feet during the first few days after filling. Any unevenness in the wall will prevent

the mass from settling uniformly, and air spaces in the mass thus formed will cause the surrounding silage to spoil.

4. **The walls of the silo must be rigid and very strong** so as not to spring when the siloed fodder settles. The lateral (outward) pressure of cut fodder corn when settling at the time of filling is considerable, and increases with the depth of the silage at the rate of about eleven pounds per square foot for each foot of depth. At a depth of 20 feet there is, therefore, an outward pressure of 220 pounds; at 30 feet, 330 pounds, etc. In case of a 16-foot square silo where the sill is 30 feet below the top of the silage the side pressure on the lower foot of the wall would be about 16×330 , or 5,280 pounds.

It is because of this great pressure that it is so difficult to make large rectangular silos deep enough to be economical, and it is because the walls of rectangular silos always spring more or less under the pressure of the silage that this seldom keeps as well in them as it does in those whose walls cannot spring.

As the silage in the lower part of the silo continues to settle, the stronger outward pressure there spreads the walls more than higher up and the result is the wall may be actually forced away from the silage so that air may enter from above; and even if this does not occur the pressure against the sides will be so much lessened above by the greater spreading below that if the walls are at all open, air will more readily enter through them.

In the round wooden silos every board acts as a hoop and as the wood stretches but little lengthwise there can be but little spreading of such walls, and in the case of stave silos the iron hoops prevent any spreading, and it is on account of these facts that the round silo is rapidly replacing every other form.

After the silage has once settled, there is no lateral pressure in the silo; cases are on record where a filled silo has burned down to the ground with the silage remaining practically intact as a tall stack.

Other points of importance in silo building which do not apply to all kinds of silos, will be considered when we come to describe different kinds of silo structures. Several questions present themselves at this point for consideration, viz., how large a silo shall be built, where it is to be located, and what form of silo is preferable under different conditions?

On the Size of Silo Required.

In planning a silo the first point to be decided is how large it shall be made. We will suppose that a farmer has a herd of twenty-five cows, to which he wishes to feed silage during the winter season, say for 180 days. We note at this point that silage will not be likely to give best results with milch cows, or with any other class of farm animals, when it furnishes the entire portion of the dry matter of the feed ration. Variation in the size of the animals will determine whether each cow is to receive 20, 30 or 40 pounds per day. As a rule, it will not be well to feed over forty pounds of silage daily per head. If this quantity be fed daily, on an average for a season of 180 days, we have for the twenty-five cows 180,000 pounds, or ninety tons. On account of the fermentation processes taking place in the silo, we have seen that there is an unavoidable loss of food materials during the siloing period, amounting to, perhaps, 10 per cent; we must, therefore, put more than the quantity given into the silo. If ninety tons of silage is wanted, about one hundred tons of fodder corn must be placed in the silo; we figure, therefore, that we shall need about four tons of silage per head for the winter, but, perhaps five tons per head would be a safer calculation, and provide for some increase in the size of the herd.

Corn silage will weigh from thirty pounds, or less, to toward fifty pounds per cubic foot, according to the depth in the silo from which it is taken, and the amount of moisture which it contains. We may take forty pounds as an average weight of a cubic foot of corn silage. One ton of silage will, accordingly, take up fifty cubic feet; and 100 tons, 5,000 cubic feet. If a rectangular one-hundred-ton silo is to be built, say 12x14 feet, it must then have a height of 30 feet. If a circular silo is wanted the following dimensions will be about right: Diameter, 14 feet; height of silo, 30 feet, etc. In the same way, a silo holding 200 tons of corn or clover silage may be built of the dimensions 14x18x40 feet, 16x16x39 feet, or if round, diameter, 18 feet, height, 37 feet, etc.

Since the capacity of round silos is not as readily computed as in case of a rectangular silo, we give on following page a table which shows at a glance the approximate number of tons of silage that a round silo, of a diameter from 8 to 20 feet, and 20 feet to 50 feet deep, will hold.

Table III shows readily how much silage is required to keep

Table II.—Capacity of Round Silos.

Approximate Capacity of Cylindrical Silos, for Well-Matured Corn Silage, in Tons.

Height of Silo inside, Feet	Inside Diameter of Silo, Feet.											
	8	10	11	12	13	14	15	16	17	18	19	20
20.....	18	30	36	45	51	60	66					
21.....	19	31	39	48	54	63	71					
22.....	20	33	41	50	57	66	76	87				
23.....	22	34	43	52	60	70	80	91				
24.....	23	36	45	55	64	73	85	95	104		122	
25.....	24	38	48	57	68	77	90	99	110	125	129	145
26.....	25	40	50	60	71	80	94	103	116	130	137	155
27.....	27	42	52	63	75	85	98	107	121	136	145	161
28.....	28	44	54	66	79	90	102	111	126	140	152	170
29.....	30	46	56	70	83	95	106	116	132	145	160	177
30.....	31	48	58	75	86	100	110	120	136	150	168	185
31.....	33	50	62	79	90	105	114	125	141	156	176	193
32.....	35	53	66	84	94	110	118	131	148	162	184	200
33.....	36	55	69	89	98	115	123	137	155	169	192	208
34.....	37	58	73	94	102	120	131	143	162	175	200	217
35.....	39	61	77	100	106	125	136	149	169	183	209	226
36.....	40	64	82	105	110	130	139	155	176	190	218	235
37.....	41	67	86	109	115	135	144	161	183	200	227	245
38.....	43	70	89	114	119	140	151	167	190	212	236	256
39.....	45	73	95	118	124	145	157	173	197	220	245	267
40.....	47	75	98	121	129	150	165	180	204	228	255	279
41.....		77	101	125	134	155	170	187	211	236	262	290
42.....		80	104	128	139	160	176	193	218	244	270	300
43.....				132	144	166	181	201	225	252	280	310
44.....				135	150	171	188	207	233	261	289	320
45.....						176	195	215	240	269	298	330
46.....						182	200	222	247	277	307	340
47.....								229	254	285	316	350
48.....								236	261	293	325	361
49.....										301	334	371
50.....										310	344	382

eight to 136 cows for six months, feeding them an average of 40 pounds a day, and the dimensions of circular silos as well as the area of land required to furnish the different amounts of feed given, computed at 15 tons per acre. The amount of silage given in the table refers to the number of tons in the silo after all shrinkage has occurred; as the condition of the corn as placed in the silo differs considerably, these figures may vary in different years or with different crops of corn, and should not be interpreted too strictly; the manner of filling the silo will also determine how much corn the silo will hold; if the silo is filled with well-matured corn, and after this has settled for a couple of days, filled up again, it will hold at least 10 per cent. more silage than when it is filled rapidly and not refilled after settling. To the person about to fill a silo for the first time, it is suggested that

Table III.—Showing Required Acreage and Stock Feeding Capacity for Silos of Various Sizes.

Dimensions	Capacity in Tons	Acres to Fill 15 Tons to Acre	Cows it will keep 6 months, 40 lbs. feed per day
10 x 20	30	3.	8
10 x 24	36	3.	10
10 x 28	44	3.	11
10 x 32	53	3.4	14
10 x 40	75	4.6	19
12 x 20	45	3.	11
12 x 24	55	3.2	13
12 x 28	66	4.1	15
12 x 32	84	5.	20
12 x 40	121	7.3	27
14 x 20	60	4.2	15
14 x 22	66	4.5	17
14 x 24	73	4.7	19
14 x 28	90	5.6	22
14 x 32	110	6.7	27
14 x 40	150	9.2	37
16 x 24	95	6.2	24
16 x 28	111	7.2	29
16 x 32	130	8.7	35
16 x 40	180	12.	49
18 x 30	150	10.2	41
18 x 36	190	13.	50
18 x 40	229	15.3	62
18 x 46	277	18.8	77
20 x 30	185	12.5	50
20 x 40	279	18.8	77
20 x 50	382	25.5	104
20 x 60	500	32.	136

it requires a "good crop" to yield 15 tons per acre, and as a "little too much is about right," be sure to plant enough to fill the silo full, being guided by the condition of soil, etc., under his control.

On the Form of Silos.

The first kind of silos built, in this country or abroad, were simply holes or pits in the ground, into which the fodder was dumped, and the pit was then covered with a layer of dirt and, sometimes at least, weighted with planks and stones. Then, when it was found that a large proportion of the feed would spoil by this crude method, separate silo structures were built, first of stone, and later on, of wood, brick or cement. As previously

stated, the first separate silos built were rectangular, shallow structures, with a door opening at one end. The silos of the French pioneer siloist, August Goffart, were about 16 feet high and 40x16 feet at the bottom. Another French silo built about fifty years ago, was 206x21½ feet and 15 feet deep, holding nearly 1,500 tons of silage. Silos of a similar type, but of smaller dimensions, were built in this country in the early stages of silo building. Experience has taught siloists that it was necessary to weight the fodder heavily in these silos, in order to avoid the spoiling of large quantities of silage. In Goffart's silos, boards were thus placed on top of the siloed fodder, and the mass was weighted at the rate of 100 pounds per square foot.

It was found, however, after some time that this heavy weighting could be dispensed with by making the silos deep, and gradually the deep silos came more and more into use. These silos were first built in this country in the latter part of the eighties; at the present time none but silos at least twenty to twenty-four feet deep are built, no matter of what form or material they are made, and most silos built are at least twenty-four to thirty feet deep or more.

Since 1892 the cylindrical form of silos has become more and more general. These silos have the advantage over all other kinds in point of cost and convenience, as well as quality of the silage obtained. We shall, later on, have an occasion to refer to the relative cost of the various forms of silos, and shall here only mention a few points in favor of the round silos.

1. Round silos can be built cheaper than square ones, because it takes less lumber per cubic foot capacity, and because lighter material may be used in their construction. The sills and stud-dings here do no work except to support the roof, since the lining acts as a hoop to prevent spreading of the walls.

2. One of the essentials in silo building is that there shall be a minimum of surface and wall exposure of the silage, as both the cost and the danger from losses through spoiling are thereby reduced. The round silos are superior to all other forms in regard to this point, as will be readily seen from an example: A rectangular silo, 16x32x24 feet, has the same number of square feet of wall surface as a square silo, 24x24 feet, and of the same depth, or as a circular silo 30 feet in diameter and of the same depth; but these silos will hold about the following quantities of

silage: Rectangular silo, 246 tons; square silo, 276 tons; circular silo, 338 tons. Less lumber will, therefore, be needed to hold a certain quantity of silage in case of square silos than in case of rectangular ones, and less for cylindrical silos than for square ones, the cylindrical form being, therefore, the most economical of the three types.

3. Silage of all kinds will usually begin to spoil after a few days, if left exposed to the air; hence the necessity of considering the extent of surface exposure of silage in the silo while it is being fed out. In a deep silo there is less silage exposed to the surface layer in proportion to the contents than in a shallow one. Experience has taught us that if silage is fed down at a rate slower than 1.2 inches daily, molding is liable to set in. About two inches of the top layer of the silage should be fed out daily during cold weather in order to prevent the silage from spoiling; in warm weather about three inches must be taken off daily; if a deeper layer of silage can be fed off daily, there will be less waste of food materials; some farmers thus plan to feed off 5 or 6 inches of silage daily. The form of the silo must therefore be planned, according to the size of the herd, with special reference to this point. Professor King estimates that there should be a feeding surface in the silo of about five square feet per cow in the herd; a herd of thirty cows will then require 150 square feet of feeding surface, or the inside diameter of the silo should be 14 feet; for a herd of forty cows a silo with a diameter of 16 feet will be required; for fifty cows, a diameter of 18 feet; for one hundred cows, a diameter of 25¼ feet, etc.

In choosing diameters and depths for silos for particular herds, individual needs and conditions must decide which is best. It may be said, in general, that for the smaller sizes of silos the more shallow ones will be somewhat cheaper in construction and be more easily filled with small powers. For large herds the deeper types are best and cheapest.

One of the common mistakes made in silo construction is that of making it too large in diameter for the amount of stock to be fed silage. Whenever silage heats and molds badly on or below the feeding surface heavy loss in feeding value is being sustained, and in such cases the herd should be increased so that the losses may be prevented by more rapid feeding. (King.)

In this connection the following table furnished by the Animal

Husbandry Department of the Nebraska Station will be of interest. It will be noted that for summer feeding at least 15 dairy cows, or 21 beef cattle, for instance, will be necessary to consume the 525 pounds of silage that should be removed daily from a 10-foot diameter surface to keep it from spoiling. In winter, 6 or 7 cows would be sufficient.

Table IV.—Rate of Feeding from Silos of Different Diameters.

Diameter, in feet	Approximate minimum pounds to be fed daily		*Approximate number of the different kinds of stock to keep the silage from spoiling in summer					
	Summer	Winter	Horses	500-lb. calves	Stock cattle	Beef cattle	Dairy cows	Sheep
10	525	263	48	44	26	21	13	175
12	755	378	69	63	38	30	19	252
14	1,030	515	94	86	52	41	26	344
16	1,340	670	122	112	67	54	34	446
18	1,700	850	155	142	85	68	42	567
20	2,100	1,050	191	175	105	84	53	700

*If the silo is to be used for winter feeding only, it will require only one-half as many of each kind of stock to keep the silage in good condition as where it is used for summer feeding.

The Nebraska Station also gives the following daily ration of silage for various kinds and weights of stock. It should be remembered, however, that these amounts are only approximate and vary considerably in different sections or under special tests. At the end of a 90-day test at the Brookings, S. D., station in 1912, yearling steers were consuming 70 pounds of silage per head daily. (See page 124.)

Table V.—Approximate Daily Ration of Silage.

Kind of Stock	Weight	Fed per day
	Pounds	Pounds
Horses—		
Colts.....	500	5
Stock horses.....	1,200	12
Work horses.....	1,300	10
Cattle—		
Calves.....	500	12
Stock cattle.....	1,000	20
Beef cows.....	1,300	30
Dairy cows.....	1,000	40
Fattening cattle.....	1,200	25
Sheep—		
Stock sheep.....	3
Fattening sheep.....	3

Location of the Silo.

The location of the silo is a matter of great importance, which has to be decided upon at the start. The feeding of the silage is an every-day job during the whole winter and spring, and twice a day at that. Other things being equal, the nearest available place is therefore the best. The silo should be as handy to get at from the barn as possible. The condition of the ground must be considered. If the ground is dry outside the barn, the best plan to follow is to build the silo there, in connection with the barn, going four feet to six feet below the surface, and providing for door opening directly into the barn. The bottom of the silo should be on or below the level where the cattle stand, and, if practicable, the silage should be moved out and placed before the cows at a single handling. While it is important to have the silo near at hand, it should be so located, in case the silage is used for milk production, that silage odors do not penetrate the whole stable, at milking or other times. Milk is very sensitive to odors, and unless care is taken to feed silage after milking, and to have pure air, free from silage odor, in the stables at the time of milking, there will be a silage flavor to the milk. This will not be sufficiently pronounced to be noticed by most people, and some people cannot notice it at all; but when a person is suspicious, he can generally discover it. So far as is known this odor is not discernible in either butter or cheese made from silage-flavored milk, nor does it seem to affect the keeping qualities of the milk in any way.

Different Types of Silo Structures.

Silos may be built of wood, stone, brick, cement, tile or metal, or partly of one and partly of another of these materials. Wooden silos may be built of several layers of thin boards nailed to uprights, or of single planks (staves), or may be plastered inside. The material used will largely be determined by local conditions; where lumber is cheap, and stone high, wooden silos will generally be built; where the opposite is true, stone or brick silos will have the advantage in point of cheapness, while concrete and clay block silos are likely to be preferred where great permanency is desired or where cobble-stones are at hand in abundance, and lumber or stone are hard to get at a reasonable cost. So far as the quality of the silage made in any of these kinds of silos is con-

cerned, there is no difference when the silos are properly built. The longevity of concrete and tile silos is usually greater than that of wooden silos, since the latter are more easily attacked by the silage juices and are apt to decay in places after a number of years, unless special precautions are taken to preserve them. A well-built and well-cared-for wooden silo should, however, last almost indefinitely.

As regards the form of the silo, it may be built in rectangular form, square, octagon or round. We have already seen that the most economical of these is ordinarily the round form, both because in such silos there is less wall space per cubic unit of capacity, and in case of wooden round silos, lighter material can be used in their construction. The only place where silos of square or rectangular form are built now is inside of barns, where they fit in better than a round structure. We shall later on give directions for building silos inside of a barn, but shall now go over to a discussion of the various forms of round silos that are apt to be met with. More round wooden silos have been built during late years in this country than of all other kinds of silos combined, and this type of silo, either built of uprights lined inside and outside with two layers of half-inch boards, or of one thickness of staves, will doubtless be the main silo type of the future; hence we shall give full information as to their building, and shall then briefly speak of the other forms mentioned which may be considered preferable in exceptional cases.

Round Wooden Silos.

Round wooden silos were first described, and their use advocated, in Bulletin No. 28, issued by the Wisconsin Station in July, 1891, at a time when lumber of a good quality could be secured at much less cost than at present. This type has come to be known as the Wisconsin or King silo, named after the late Prof. King, the originator. The first detailed and illustrated description was published in the above bulletin; since that time it has been described in several bulletins and reports issued by the Station mentioned and in numerous publications from other Experiment Stations. This type, and the one to be described in the following, the stave silo, are practically the only kind of wooden silos that have been built in this country during late years except where unusual conditions have prevailed that would make some other kind of silo construction preferable.

The Kind of Woods for Silos.—Conclusions drawn from Bulletin No. 100, Iowa State College, place the merits of woods for silo use as follows: 1, Redwood; 2, Cypress; 3, Oregon Fir; 4, Tamarack; 5, White Pine; 6, Long-leaf Yellow Pine.

The following description of the King silo is taken from Bulletins Nos. 83 and 125 of the Wisconsin Station:

The Foundation.—There should be a good, substantial cement foundation for all forms of wood silos, and the woodwork should everywhere be at least 12 inches above the earth, to prevent decay from dampness. There are few conditions where it will not be desirable to have the bottom of the silo 3 feet or more below the feeding floor of the stable, and this will require not less than 4 to 6 feet of stone, brick, or concrete wall. For a silo 30 feet deep the foundation wall of stone should be 1.5 to 2 feet thick.

Bottom of the Silo.—After the silo has been completed the ground forming the bottom should be thoroughly tamped so as to be solid, and then covered with two or three inches of good concrete made of 1 of cement to 3 or 4 of sand or gravel. The amount of silage which will spoil on a hard clay floor will not be large, but enough to pay a good interest on the money invested in the cement floor. If the bottom of the silo is in dry sand or gravel the cement bottom is imperative to shut out the soil air.

The Superstructure.—The wood superstructure of the King silo has a wall 5 or 6 inches thick, whereas the foundation wall is 18 to 24 inches thick; it is evident, therefore, that there must be a shoulder of the wall 12 to 19 inches wide that must project either into the silo pit or outward beyond the sill.

How to Place the Frame on the Foundation.—Figure 1 illustrates two methods of placing the frame on the foundation. A is the right way. B is the wrong way. In B Fig. 1 the shoulder of the foundation wall projects into the silo pit. This method is permissible when the silo floor is not more than 1 foot below the top of the wall. If the floor of the silo is three feet or more below the top of the wall as in B Fig. 1, then this shoulder interferes with the proper settling of the silage and the silage moulds or rots just above the shoulder next to the silo and usually below the shoulder also. This rotting is commonly ascribed to the loosening of the sill or the foundation allowing air to enter. In most cases, however, it is plainly not due to this cause, but is due to the projecting shoulder which interferes with the settling of the

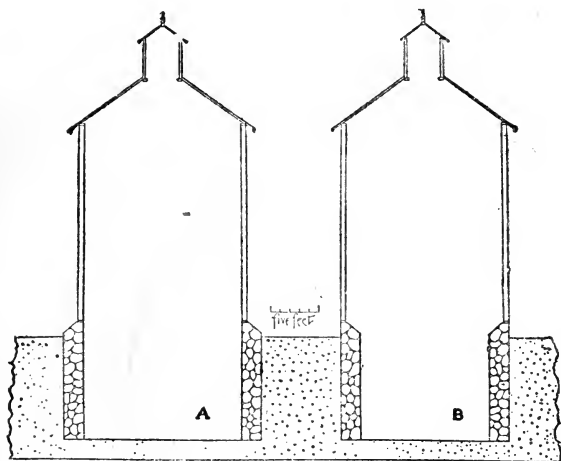

Fig. 1.—Showing two methods of placing the wood, brick lined or lathed and plastered silo on a stone foundation. A shows the silo set with upper portion flush with the inside of the stone wall, and B shows the upper portion flush with the outside of the stone wall. A is the right way; B is the wrong way.

silage. Many silos have been abandoned on this account, so serious has been the loss from rotting. This shoulder should never project into the silo pit.

Forming the Sill.—The sill may be made of a single 2x4 cut into two foot lengths with the ends beveled so that they may be toe-nailed together to form a circle. Two other methods are also illustrated in Fig. 2, one being a double thickness with broken joints and the other using pieces cut to the curvature of the silo. It will be noted that the latter construction eliminates the air-spaces between the silo and the outer sheeting which are evident in the first two mentioned. These spaces admit air so that the space between the studding is not a dead air space.

Setting the Studding.—The studding of the all-wood round silo need not be greater than 2x4, but they should be set as close together as one foot from center to center, as represented in Fig. 6. This number of studs is not required for strength but they are needed in order to bring the two layers of lining very

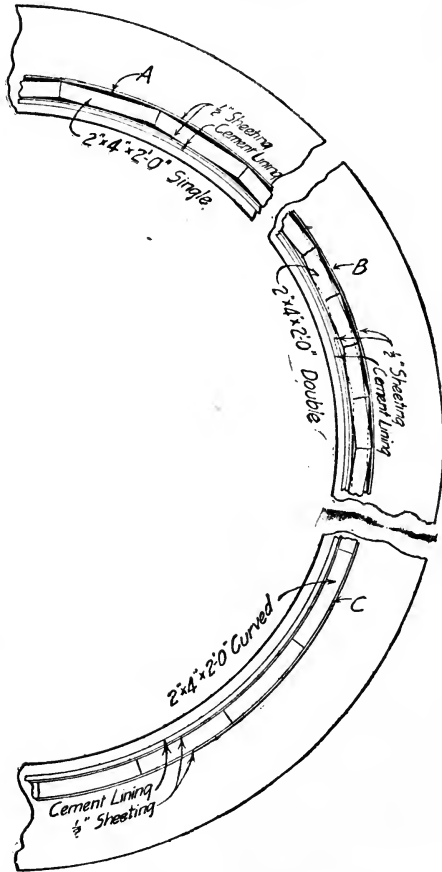

Fig. 2.—Showing three methods of making a sill or plate for Gurler or King Silo. A shows sill made of a single thickness of 2x4's cut in two-foot lengths; B shows sill made of two thicknesses of 2x4's laid to break joints; C shows 2x4 sawed out of 2x6 plank. C is the best method, since the sheathing then fits the sill making a tight joint, whereas in A and B a tight joint between sheathing and sill or plate cannot be secured. Observe that the sill is placed near the inner edge of the foundation.

close together, so as to press the paper closely and prevent air from entering where the paper laps.

Where studding longer than 20 feet are needed, short lengths may be lapped one foot and simply spiked together before they are set in place on the wall. This will be cheaper than to pay the higher price for long lengths. All studding should be given the exact length desired before putting them in place.

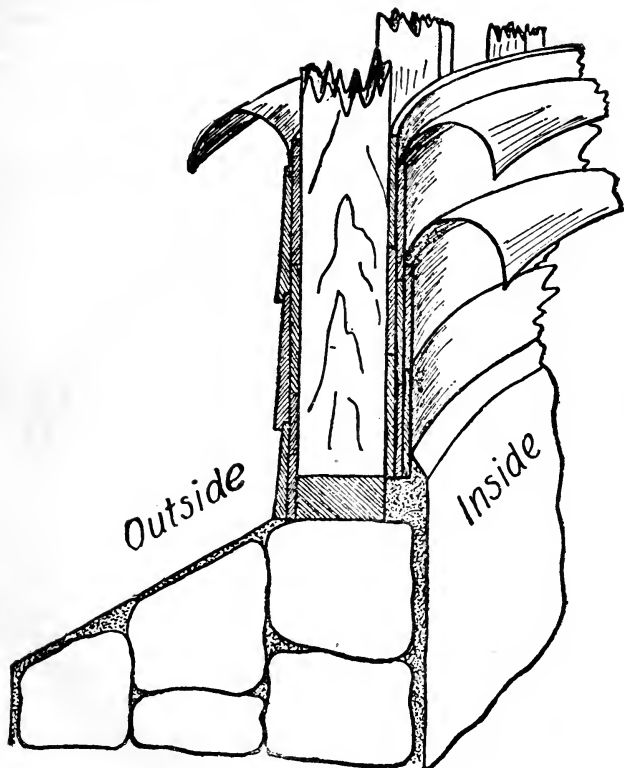

Fig. 3.—Detail of construction of wall of King silo. Three thicknesses of $\frac{3}{8}$ " sheeting inside with 2 thicknesses of acid-proof paper, and on the outside one thickness of sheeting, 1 of tar felt, and 1 of clap boards. Observe that the shoulder of the foundation is outside.

To stay the studding a post should be set in the ground in the center of the silo long enough to reach about five feet above the sill, and to this stays may be nailed to hold in place the alternate studs until the lower five feet of outside sheeting has been put on. The studs should be set first at the angles formed in the sill and carefully stayed and plumbed on the side toward the center. When a number of these have been set they should be tied together by bending a strip of half-inch sheeting around the outside as high up as a man can reach, taking care to plumb each stud on the side before nailing. When the alternate studs have been set in this way the balance may be placed and toe-nailed to the sill and stayed to the rib, first plumbing them sideways and toward the center.

Setting Studding for Doors.—On the side of the silo where the doors are to be placed the studding should be set double and the

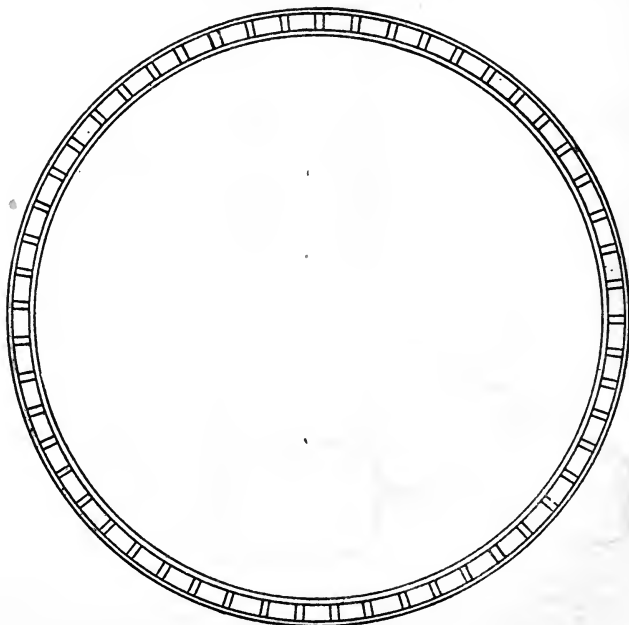

Fig. 6.—Showing the plan of studding for the all-wood, brick-lined or lathed-and-plastered silo.

distance apart to give the desired width. A stud should be set between the two door studs as though no door were to be there, and the doors cut out at the places desired afterwards. The construction of the door is represented in Fig. 7.

The doors are usually made about 2 feet wide and from 2½ to 3 feet high, and placed one above the other at suitable distances apart. It has been suggested that to insure security a strip of tar paper should be placed the entire length of the silo on the inside over the doors.

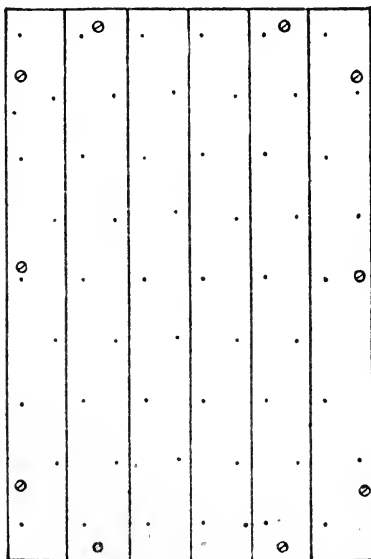
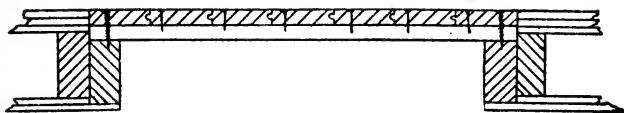

Fig. 7.—Showing the construction of the door for the all-wood silo.

Silo Sheeting and Siding.—The character of the siding and sheeting will vary considerably according to conditions and the size of the silo.

Where the diameter of the silo is less than 18 feet inside and not much attention need be paid to frost, a single layer of beveled siding, rabbetted on the inside of the thick edge, deep enough to receive the thin edge of the board below, will be all that is absolutely necessary on the outside for strength and protection against weather.

If basswood is used for siding, care should be taken to paint it at once, otherwise it will warp badly if it gets wet before painting.

In applying the sheeting begin at the bottom, carrying the work upward until staging is needed, following this at once with the siding. Two 8-penny nails should be used in each board in every stud, and to prevent the walls from getting "out of round" the succeeding course of boards should begin on the next stud, thus making the ends of the boards break joints.

When the stagings are put up, new stays should be tacked to the studs above, taking care to plumb each one from side to side; the siding itself will bring them into place and keep them plumb the other way, if care is taken to start new courses as described above.

Forming the Plate.—When the last staging is up the plate should be formed by spiking 2x4's cut in two-foot lengths, in the manner of the sill, and as represented in Fig. 8, down upon the tops of the studs, using two courses, making the second break joints with the first. A still better method is to use 2x6 plank, cut to the circle as shown in C, Fig. 2.

The Lining of the Wooden Silo.—There are several ways of making a good lining for the all-wood round silo, but whichever method is adopted it must be kept in mind that there are two very important ends to be secured with a certainty. These are (1) a lining which shall be and remain strictly air-tight, (2) a lining which will be reasonably permanent.

Lining of Half-inch Boards and Paper.—Where paper is used to make the joints between boards air-tight, as represented in Fig. 3, it is extremely important that a quality which will not decay, and which is both acid and water-proof be used. A paper

which is not acid and water-proof will disintegrate at the joints in a very short time, and thus leave the lining very defective.

The best paper for silo purposes with which we are acquainted is a 3-ply Giant P. and B. brand manufactured by the Standard Paint Co., of Chicago and New York. It is thick, strong, and acid and water-proof. A silo lining with two thicknesses of good fencing having only small knots, and these thoroughly sound and not black, will make an excellent lining. Great care should be taken to have the two layers of boards break joints at their centers, and the paper should lap not less than 8 to 12 inches.

The great danger with this type of lining will be that the boards may not press the two layers of paper together close

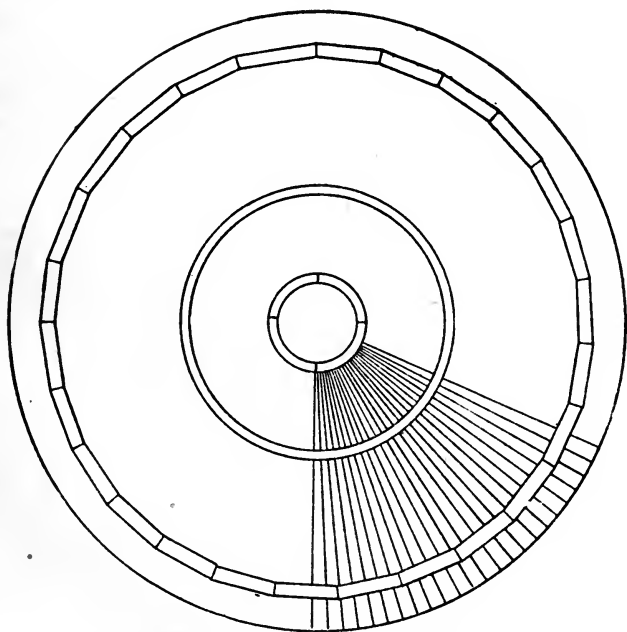

Fig. 8.—Showing construction of conical roof of round silo, where rafters are not used. The outer circle is the lower edge of the roof, the second is the plate, the third and fourth circles are hoops to which the roof boards are nailed. The view is a plan looking up from the under side.

enough but that some air may arise between the two sheets where they overlap, and thus gain access to the silage. It would be an excellent precaution to take to tack down closely with small carpet tacks the edges of the paper where they overlap, and if this is done a lap of 4 inches will be sufficient.

The first layer of lining should be put on with 8-penny nails, two in each board and stud, and the second or inner layer with 10-penny nails, the fundamental object being to draw the two layers of boards as closely together as possible.

Such a lining as this will be very durable because the paper will keep all the lumber dry except the inner layer of half-inch boards, and this will be kept wet by the paper and silage until empty, and then the small thickness of wood will dry too quickly to permit rotting to set in.

A still more substantial lining of the same type may be secured by using two layers of paper between three layers of boards, as represented in Fig. 3, and if the climate is not extremely severe, or if the silo is only to be fed from in the summer, it would be better to do away with the layer of sheeting and paper outside, putting on the inside, thus securing two layers of paper and three layers of boards for the lining with the equivalent of only 2 inches of lumber.

The Silo Roof.—Roofs on silos make big savings in keeping the silage from drying out and blowing around. They keep

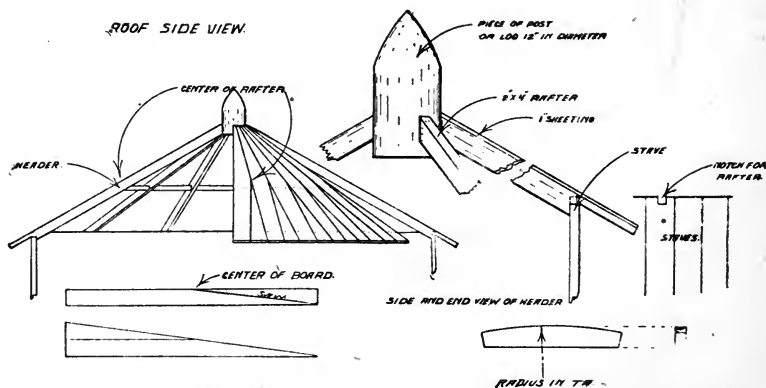

Fig. 9.—Showing construction and details of one style of roof. (From Nebr. Bul. No. 138.)

the wind out and make the silo warm in winter, free from snow and freezing, and the silage in good shape for feeding.

The roof of cylindrical silos may be made in several ways, but the simplest type of construction and the one requiring the least amount of material is that represented in Fig. 8, which is the cone.

If the silo is not larger than 15 feet inside diameter no rafters need be used, and only a single circle like that in the center of Fig. 8, this is made of 2-inch stuff cut in sections in the form of a circle and two layers spiked together, breaking joints.

The roof boards are put on by nailing them to the inner circle and to the plate, as shown in the drawing, the boards having been sawed diagonally, making the wide and narrow ends the same relative widths as the circumference of the outer edge of the roof and of the inner circle. Thus a 10-foot board 8 inches wide would be sawed so as to make two 10-foot lengths, each being $6\frac{3}{4}$ inches wide at one end and $1\frac{1}{4}$ inches wide at the other.

If the silo has an inside diameter exceeding 15 feet it will be necessary to use two or three hoops according to diameter.

The conical roof may be covered with ordinary shingles, splitting those wider than 8 inches. By laying the butts of the shingles $\frac{1}{8}$ to $\frac{1}{4}$ of an inch apart it is not necessary to taper any of the shingles except a few courses near the peak of the roof.

The prepared roofings, such as "Ruberoid" or "Paroid" or prepared gravel roofing are preferred to shingles for a silo roof, since they make a tighter roof which retains the heat in winter.

In laying the shingles to a true circle, and with the right exposure to the weather, a good method is to use a strip of wood as a radius which works on a center set at the peak of the roof and provided with a nail or pencil to make a mark on the shingle where the butts of the next course are to come. The radius may be bored with a series of holes the right distance apart to slip over the center pivot, or the nail may be drawn and reset as desired. Some carpenters file a notch in the shingling hatchet, and use this to bring the shingle to place.

Ventilation of the Silo.

Every silo which has a roof should be provided with ample ventilation to keep the under side of the roof dry, and in the case of wood silos, to prevent the walls and lining from rotting. One

of the most serious mistakes in the early construction of wood silos was the making of the walls with dead-air spaces, which, on account of dampness from the silage, led to rapid "dry-rot" of the lining.

In the wood silo and in the brick lined silo it is important to provide ample ventilation for the spaces between the studs, as well as for the roof and the inside of the silo, and a good method of doing this is represented in Fig. 4, where the lower portion represents the sill and the upper the plate of the silo. Between each pair of studs where needed a $1\frac{1}{4}$ -inch auger hole to admit air is bored through the siding and sheeting and covered with a piece of wire netting to keep out mice and rats. At the top of the silo on the inside, the lining is only covered to within two inches of the plate and this space is covered with wire netting to prevent silage from being thrown over when filling. This arrangement permits dry air from outside to enter at the bottom between each pair of studs and to pass up and into the silo, thus keeping the lining and studding dry and at the same time drying the under side of the roof and the inside of the lining as fast as exposed. In those cases where the sill is made of 2x4's cut in 2-foot lengths there will be space enough left between the curved edge of the siding and sheeting and the sill for air to enter so that no holes need be bored as described above and represented in Fig. 4. The openings at the plate should always be provided and the silo should have some sort of ventilator in the roof. This ventilator may take the form of a cupola to serve for an ornament as well, or it may be a simple galvanized iron pipe 12 to 24 inches in diameter, rising a foot or two through the peak of the roof.

A word of caution is sounded in the Wisconsin Bulletin No. 125 regarding the above method of ventilation:

"It will be readily understood that if these ventilators between the studs are left open in winter they will act as chimneys; they will maintain a constant draft between the studding, which will cool off and freeze the silage more severely than it would if there were no sheeting at all outside the studding. If the silage is for winter feeding, and 99 per cent of the silage is so fed, then more care should be exercised than at present in Wisconsin to prevent this severe freezing. In order to do this, provision must be made for closing these ventilators both at the top and at the bottom,

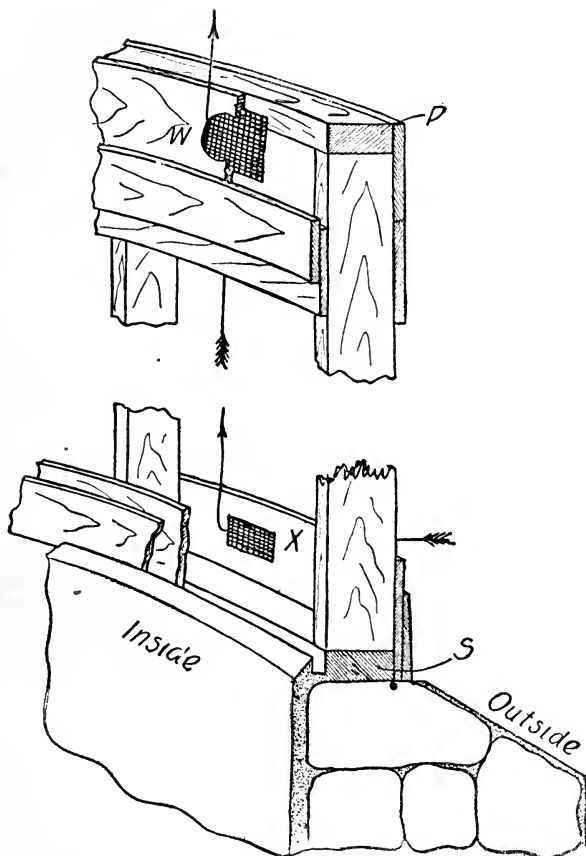

Fig. 4.—Showing the method of ventilating between studding. An auger hole is bored through the outer siding just above sill, between each pair of studding as at X, and a screen nailed over hole inside to keep out mice. A similar hole is bored through the inner sheeting between each pair of studs at the top of the silo just under the plates, as at W. Auger holes are used at X and W, so that the holes may be closed in cold weather with corks.

so as to convert the hollow wall into a real dead-air space. There is no need of building the wall air-tight outside, as shown in Fig. 3, with two thickness of sheeting with paper between, unless there is provision for closing the ventilators in winter.

"The writer has seen a number of these silos in which the silage froze severely. In most instances no attempt was made to close the ventilators, and the few instances when it was attempted only the lower ventilators on the outside were closed. This is not enough for if the upper ventilators at W, Fig. 4, are left open the hollow wall will cool off rapidly and the air space serve no purpose as protection against frost.

"The invention of the King silo came in response to an urgent demand for a type of construction that would avoid the corners and other serious and aggravating defects of silos, as previously constructed. It marked an epoch in silo building. Hundreds of silos of this type have been constructed. They have not been confined to Wisconsin, but have been widely distributed. They have been in use the past ten years, and have demonstrated their success. They are no longer an experiment. However, the very wide and general use of this type of silo under a great variety of conditions of climate and local environment has brought out some of the demerits of this type of construction which at the outset could not have been foreseen. For instance, the wood lining has been found less satisfactory than cement, and hence it is recommended that these silos be cement lined. Many of the King silos are lathed and plastered and have proven very satisfactory, having done service for ten years.

"Clap boards have been found unsatisfactory for the outer siding and it is recommended that steel siding or some of the roofing paper, ruberoid, or lath and plaster be used in their stead as will be described later."

Painting the Silo Lining.

It is impossible to so paint a wood lining that it will not become wholly or partly saturated with the silage juices. This being true, when the lining is again exposed when feeding the silage out, the paint greatly retards the drying of the wood work and the result is decay sets in, favored by prolonged dampness. For this reason it is best to leave a wood lining naked or to use some anti-septic which does not form a water-proof coat.

The cost of such a silo as that described in the foregoing pages, is estimated by Prof. King at about 12 cents per square foot of outside surface, when the lining consists of two layers of half-inch split fencing, with a 3-ply Giant P. and B. paper between, and with one layer of split fencing outside, covered with rabbetted house siding. If built inside of the barn, without a roof and not painted, the cost would be reduced 3 cents per square foot, or more. Silos of this type, 30 feet deep, built outside, provided with a roof and including 6 feet of foundations are stated to cost as follows: 13 feet inside diameter (80 tons capacity), \$183.00; 15 feet diameter (105 tons capacity), \$211.00; 21 feet diameter (206 tons capacity), \$298.00; and 25 feet diameter (300 tons capacity), \$358.00.

Complete specifications and building plans for a 300-ton silo, of the kind described in the preceding pages, are given in Prof. Woll's Book on Silage. The dimensions of this silo are: Diameter, 26 feet; height, 30 feet.

According to our present knowledge this form of silo is most likely the best that can be built; it is a somewhat complicated structure, calls for more time and skill for its construction, and costs more than other kinds of wooden circular silos, especially more than the stave silo soon to be described; but once built needs but little attention and it is durable and economical; being practically air-tight, the losses of food materials in the siloed fodder are reduced to a minimum.

Modifications of the Wisconsin Silo.

Several modifications of the Wisconsin Silo have been proposed and have given good satisfaction; one is described by Prof. Plumb in Purdue Experiment Station Bulletin No. 91, as follows:

The studs are 18 inches apart, and for about half way up there are three layers of sheeting against the studs with tarred paper between. The upper half of the studs has but two layers of sheeting. The sheeting was made by taking 2x6-inch white pine planks and sawing to make four boards. The silo rests on a stone wall 18 inches deep and 16 inches wide. It is 30 feet high, 18 feet 4 inches inside diameter, and holds about 150 tons. An inexpensive but durable roof was placed upon it. The cost of this structure, is as follows: As the work was all done by the

regular farm help at odd hours, the item of labor is given at estimated cost: Studding, \$13.05; sheeting, \$63.00; 5 rolls of paper, \$6.25; nails, \$2.40; cement for wall, \$2.40; labor, \$20.00; total, \$107.08. The owner of the silo was so pleased with the service this one had rendered since its construction, that he built another like it during the summer of 1902. This silo is connected by a covered passage and chute with the feeding floor of the cattle barn.

The construction of this type of silo calls for as much care in putting on sheeting, making doors and keeping out the air at these places and at the foundation, as is required with the more expensive forms previously described. The need for outer siding will depend in a large measure on circumstances. The farmer building the silo (living in Central Indiana) has had no trouble with his silage freezing. In Northern Indiana the siding would naturally be more necessary than in the southern part of this state, but generally speaking, siding is not necessary, although it does materially add to the attractiveness of the silo.

Plastered Round Wooden Silos.

Plastered round wooden silos have met with favor among farmers who have tried them, and are preferred by many for either the original or the modified Wisconsin silo, on account of their ease of construction and their durability. In the experience of H. B. Gurler, a well known Illinois dairyman, who has built several silos on his farm in the course of the last dozen years, the walls of plastered silos keep perfectly and there is no waste from moldy silage along the wall; neither is there any difficulty about cracking of the plaster, if this is put on properly and a good quality of cement is used. Gurler described the construction of his plastered silo in Breeder's Gazette, accompanying his description with building plans of his silo. We have reproduced the latter changed and improved in some points of minor importance, and give below a brief description of the method of building silos of this type. (See Figs. 10 and 11.)

The foundation may be made of stone, brick or cement, and is carried to the proper distance above ground. Sills composed of pieces of 2x4, two feet long, beveled at the ends so as to be toe-nailed together to form a circle of the same diameter as the

interior diameter of the silo, are placed on the foundation bedded in asphalt or cemented mortar, and on this the studding is erected, using two by fours, placed 15 or 16 inches apart. Inside sheeting was secured by having 6-inch fencing re-sawed, making the material a little less than $\frac{1}{2}$ -inch thick. On this was nailed laths made from the same material, the laths being made with beveled edges so that when nailed onto the sheeting horizontally, the same way as the sheeting is put on, there are dove-tailed joints between the laths to receive the cement, preventing its loosening until it is broken. The patent grooved lath might be used, but they cannot be sprung to a twenty-foot circle. Better than either kind of wooden laths, however, is wire netting or metal lath of one form or another, such as is now generally used in outside plastering of houses, nailed on strips of 1x2's which are placed 15 inches apart, and nailed onto the studding through the sheeting. Metal lath will not take up moisture from the silage juices, and thus expand and possibly cause the plaster to crack,

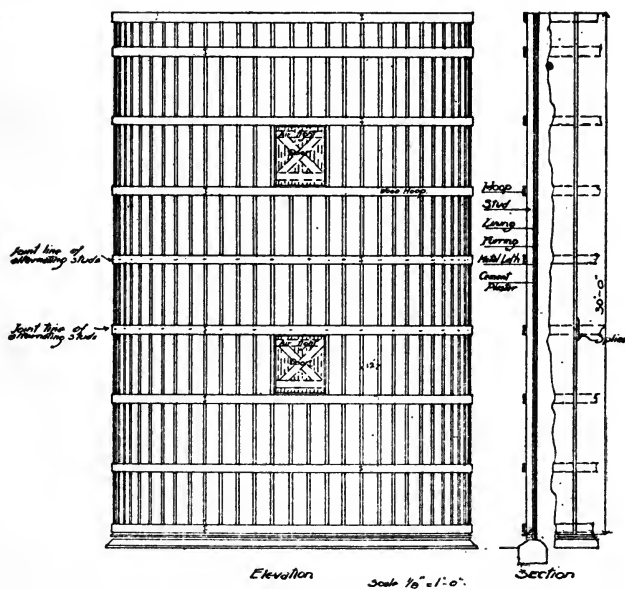

Fig. 10.—Elevation and section of plastered round wooden silo.

as would be likely to occur in case of wooden laths. For outside sheathing similar material to that used for inside sheathing may be used. If built inside of a barn or in a sheltered place, no outside sheathing would be required, although it would add greatly to the looks of the silo. Not being certain that the inside sheathing, laths and cement offered sufficient resistance to the outward pressure in the silo, Mr. Gurler put on wooden hoops outside of the studding, of the same material as for the inside sheathing, putting it on double thickness and breaking joints. The silo described, which would hold 250-300 tons, cost \$500, without a roof. Mr. Gurler considers this silo the best that can be built, and estimates that it will last for at least fifty years, if given a wash of cement every three years and if any cracks that may start be filled before the silo is filled again.

The Gurler silo uses much less lumber than the Wisconsin or King silo, one thickness of sheathing instead of four or five thicknesses being sufficient. The Gurler **must** be cement lined, how-

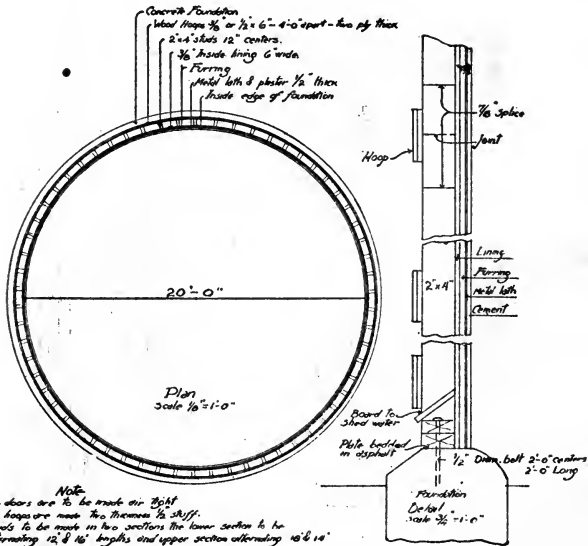

Fig. 11.—Foundation plan and section of plastered round wooden silo.

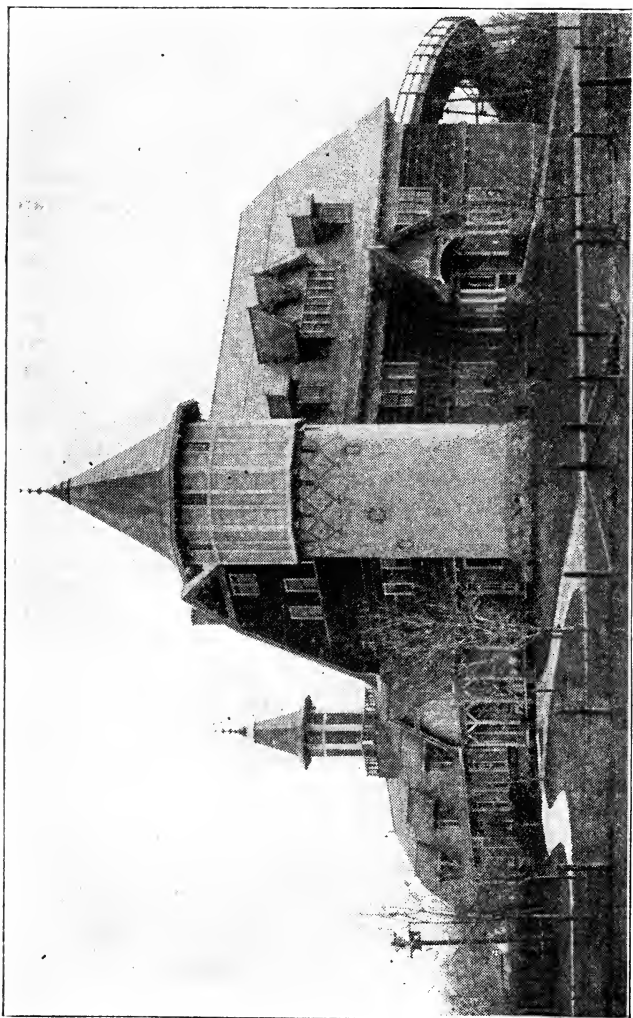

Fig. 12.—Dairy Barn, Wisconsin Experiment Station. Brick lined silo in foreground.

ever, but it is cheaper as to first cost and is the more durable. It was designed primarily for use inside some other building, whereas the Wisconsin silo is intended to stand outside.

Brick Lined Silos.

As an illustration of silos of this type we give below a description of the silo built in connection with the Dairy Barn of the Wisconsin Experimental Station; the accompanying figures, 12 and 13, will show the exterior appearance of the barn and silo, and a plan of the eastern half of the first floor of this barn.

The silo is circular in form, 18 feet inside diameter and 53 feet deep. It is a framed structure lined inside and outside with brick. On 2x6-inch uprights, two wrappings of $\frac{3}{8}$ -inch stuff, 6 inches wide, are put, breaking joints, with no paper between. Brick is laid tight against this lining, and on the brick surface is a heavy coating of Portland cement (1 part cement, 1 part sand). On the outside brick is laid up against the lining with a small open space between (about $\frac{1}{2}$ inch). The silo is filled from the third floor of the barn, the loads of corn being hauled directly onto this floor over the trestle shown to the right in Fig. 12, and there run through the feed cutter. When the silage is taken out for feeding, it falls through a box chute to the main floor where it is received into a truck (Fig. 54) in which it is conveyed to the mangers of the animals.

An illustration and description of the original round silo, with a capacity of 90 tons, built at the same Station in 1891, are given in Prof. Woll's Book on Silage, where descriptions and illustrations of a number of other first-class round wooden silos will also be found, like those constructed at the Experiment Stations in New Jersey, Missouri, and South Dakota.

Stave Silos.

The stave silo is the simplest type of separate silo buildings, and partly for this reason, partly on account of its cheapness of construction, more silos of this kind have been built during the past few years than any other silo type.

Since their first introduction Stave Silos have been favorably mentioned by most writers on agricultural topics, as well as by experiment station men. In the recent bulletin from Cornell Ex-

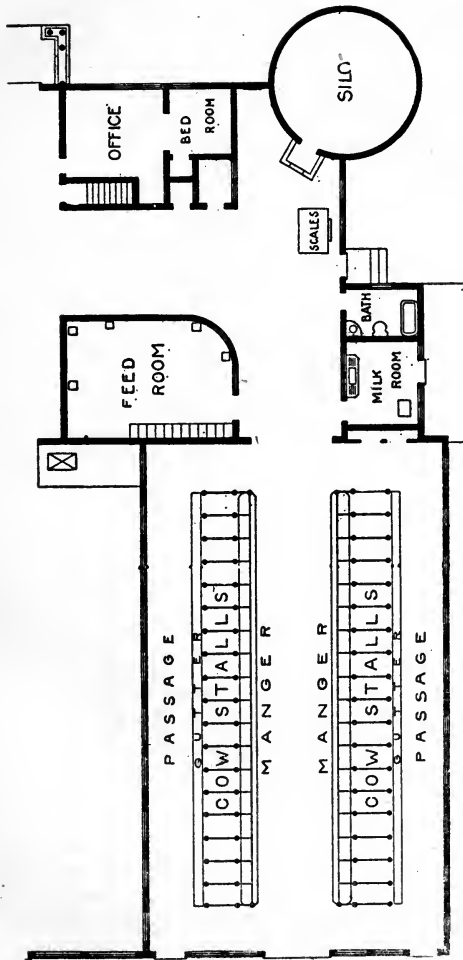

Fig. 13.—First floor of barn, showing stables and silo, etc., Wisconsin Experiment Station.

HOW TO BUILD A SILO.

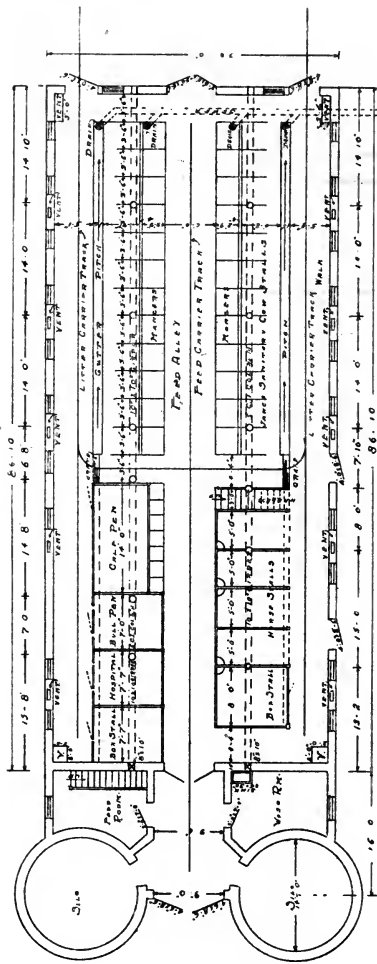

Fig. 14.—First floor plan of model barn, Wisconsin State Fair Grounds, showing relation of silos to feeding, etc.—Courtesy James Mfg. Co., Ft. Atkinson, Wis.

periment Station, we find the stave silo spoken of as "the most practical and successful silo which can be constructed," and the Ottawa Experiment Station is on record for the following statement in regard to the stave silo: "From extensive observation and study of silos and silo construction, and from experience here with a number of different silos, it would appear that the stave silo is the form of cheap silos that for various reasons is most worthy of recommendation. It combines simplicity and cheapness of construction with the requisite conditions to preserve the silage in the very best condition for feeding."

Stave silos are, generally speaking, similar to large railroad or fermentation tanks, and to make satisfactory silos should be built as well as a No. 1 water tank. The first stave silos were built in this country in the beginning of the nineties; they soon found some enthusiastic friends, while most people, including nearly all writers and lecturers on silo construction, were inclined to be skeptical as to their practicability. It was objected that the staves would expand so as to burst the hoops when the silo was filled with green fodder; that they would shrink after having been left empty during the summer months, so that the silo would fall to pieces, or at least so that it could not again be made air-tight; and finally, that the silage would freeze in such silos, and its feeding value thereby be greatly lowered. In addition to this, it was claimed that a substantial stave silo would cost as much as a first class ordinary all-wood silo of the same capacity, which would not have the objectionable features of the former.

In spite of these objections the stave silo has, however, gradually gained ground, until of late years it has quite generally been adopted in preference to other kinds of silos, particularly in the Eastern and Central states. This being a fact, it follows that the objections previously made to the stave silos cannot be valid, that the staves do not swell so as to burst the hoops, or shrink so as to cause the silo to fall to pieces, or become leaky. As regards the danger from freezing of the silage, the criticisms of the stave silo are in order, as silage in outdoor stave silos will be likely to freeze in cold weather, in any of the northern states or Canada; but, according to the testimony of farmers who have had experience with frozen silage, this is more an inconvenience than a loss. The freezing does not injure the feeding value of

the silage, or its palatability. When the silage is thawed out it is as good as ever, and eaten by cattle with a relish.

Why Stave Silos Have Become Numerous.

The main reason why stave silos have been preferred by the majority of farmers during late years are that they can be put up easily, quickly and cheaply, and the expense for a small silo of this kind is comparatively small. Many a farmer has built a stave silo who could not afford to build a high-priced silo, and others have preferred to build two small silos for one large one, or a small one in addition to an old, larger one that they may already have. Manufacturing firms have, furthermore, made a specialty of stave silo construction, and pushed the sale of such silos through advertisements and neat circulars. Having made a special business of the building of stave silos, and having had several years' experience as to the requirements and precautions to be observed in building such silos, these firms furnish silos complete with all necessary fixtures, that are greatly superior to any which a farmer would be apt to build according to more or less incomplete directions.

It follows that the stave silos sent out by manufacturing firms will generally be more expensive than such a farmer can build himself, because they are built better. It does not pay to build a poor silo, however, except to bridge over an emergency. Poor, cheap silos are a constant source of annoyance, expense and trouble, whether built square, rectangular or round. The cheap silos described in other places of this book have not been given for the purpose of encouraging the building of such silos, but rather to show that if a farmer cannot afford to build a permanent **good** silo, he is not necessarily barred from the advantages of having silage for his stock, since a temporary silo may be built at a small cash outlay.

We can therefore consistently recommend that parties intending to build stave silos patronize the manufacturers who have made silo construction a special business. These firms furnish all necessary silo fittings, with complete directions for putting up the silos, and, if desired, also skilled help to superintend their building. Perhaps a large majority of the farmers of the country cannot, however, patronize manufacturers of stave silos because the expense of shipping the lumber and fixtures would be pro-

hibitory. For the convenience of such parties and others who may prefer to build their own stave silos, directions for their construction are given in the following: The specifications for a 100-ton stave silo, printed below, which are taken from Woll's Book on Silage, were furnished by Claude & Starck, Architects, Madison, Wisconsin.

Specifications for 100-ton Stave Silo.

MASONRY.

Excavate the entire area to be occupied by the silo to a depth of 6 inches; excavate for foundation wall to a depth of 16 inches; in this trench build a wall 18 inches wide and 20 inches high, of field stone laid in rich lime mortar. Level off top and plaster inside, outside and on top with cement mortar, 1 part cement to 1 part sand. Fill inside area with four inches of good gravel, thoroughly tamped down; after the wood work is in place coat this with one inch of cement mortar, 1 part cement to 1 part clean sand. Cement shall be smoothly finished, dished well to the center and brought up at least 2 inches all around inside and outside walls.

CARPENTRY.

All staves shall be 26 feet long in two pieces, breaking joints, and made from clear, straight-grained cypress, 2x6 inches, beveled on edges to an outside radius of 8 feet, mill-sized to the exact dimensions and dressed on all sides. There shall be three doors in the fifth, eighth and tenth spaces between the hoops, made by cutting out from staves 28 inches long cut to a 45-degree bevel sloping to the inside. (See Fig. 15.) The staves shall then be fastened together with two 2x4 inch battens cut on inside to an 8-ft. radius and bolted to each stave with two $\frac{1}{4}$ -inch diameter carriage bolts with round head sunk on inside and nut on outside. The staves between the doors shall be fastened together top and bottom, with $\frac{3}{4}$ -inch diameter hardwood dowel pins, and abutting ends of staves shall be squared and toe-nailed together.

Bottom Plates.—Bottom plates shall be made of 2x4-inch pieces about 2 feet long, cut to a curve of 7 feet 10 inches radius outside. They shall be bedded in cement mortar and the staves shall then be set on the foundation and well spiked to these plates.

Hoops.—Hoops shall be made from two pieces of $\frac{5}{8}$ -inch diameter round iron with upset ends, threaded 8 inches, with nut and washer at each end; as a support for the hoops a piece of 4x6 shall be substituted for a stave on opposite sides and holes bored in it and the ends of hoops passed through these holes and tightened against the sides of the 4x6-inch. The hoops shall be twelve in number starting at the bottom 6 inches apart and increasing in distance 6 inches between each hoop until a space of 3 feet 6 inches is reached; from this point up this distance shall be preserved as near as possible to the top.

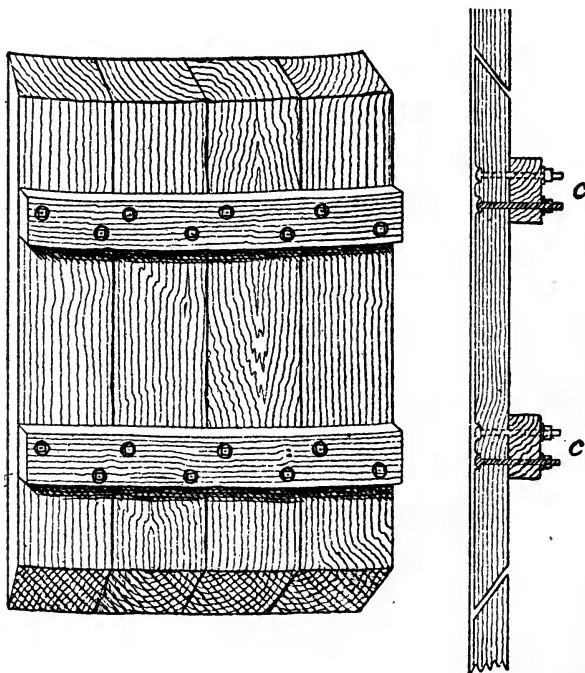

Fig. 15.—Appearance of door in stave silo after being sawed out, and side view in place. The opening is largest on the inside of silo. (Clinton.)

Roof.—Roof shall be made to a half-pitch of 6-inch clear siding lapping joints, nailed to 2x4-inch rafters, 2-feet centers 1-foot by 4-inch ridge, and 2x4-inch plates. These plates to be supported on two 4x4-inch pieces resting on top of hoops. Three

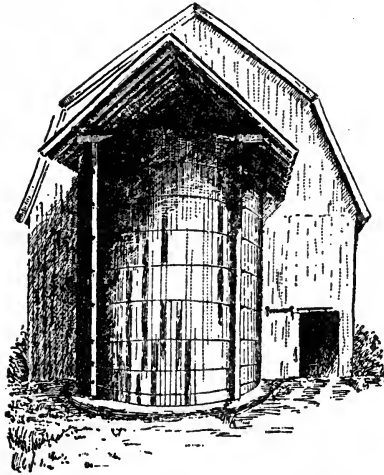

Fig. 16.—A cheap roof of a stave silo. (Clinton.)

1x4-inch collar beams shall be spiked to end and middle rafters to tie side of roof together. (See Fig. 12.) Fig. 16 shows another simple construction of roof on a stave silo.

PAINTING.

The entire outside of the silo, including roof, shall be painted two coats of good mineral paint; the entire inside surface of the staves and doors shall be thoroughly coated with hot coal tar.

Note.—Before filling silo, tar paper should be tacked tightly over doors and the entire inside of silo examined and cracks tightly caulked.

The method of construction specified in the preceding may of course be modified in many particulars, according to the conditions present in each case, cost of different kinds of lumber, maximum amount of money to be expended on silo, etc.

The following directions for the construction of stave silos

are taken from two bulletins on this subject, published by the Cornell and Ottawa Experiment Stations. For a silo 20 feet in diameter, a circular trench 18 inches to two feet wide and with an outer diameter of 22 feet is dug about 2 feet deep, or below the frost line. The surface soil over the whole included area, and for 2 feet outside, is removed to a depth of 10 or 12 inches at the same time. The trench is then filled to the level of the interior with stone, well pounded down, the surface stone being broken quite small, and thin cement (1 part of cement to 4 of sand thoroughly mixed) poured over, well worked in and left for a few days. This is followed by a coat of good cement (1 part cement to 3 sand), care being taken when finished to have the surface level and smooth.

The silo is set up as shown in Fig. 17, which shows a cross-section of one method of construction.

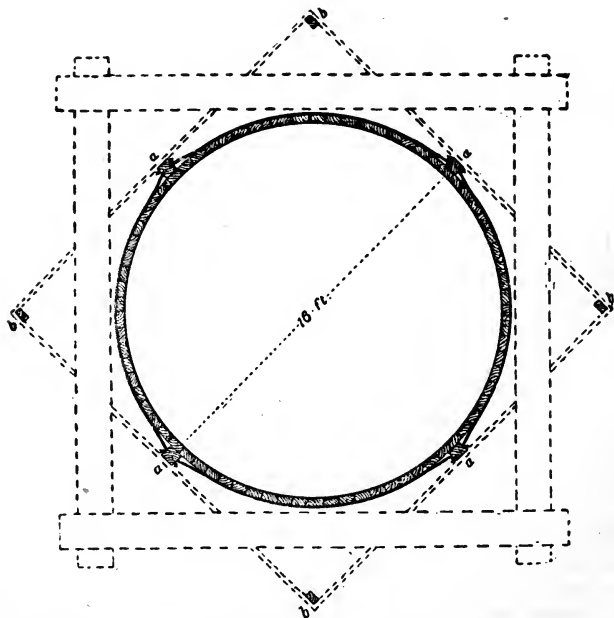

Fig. 17.—Cross section of stave silo. The dotted lines show how scaffolding may be put up.

The posts (a, a, a, a) should be of 6x6 material and run the entire length of the silo. These should be first set up vertically and stayed securely in place.

The scaffolding may be constructed by setting up 2x4 scantling in the positions shown in Fig. 17, as b, b, b, b. Boards nailed from these 2x4 scantling and to the 6x6 posts will form a rigid framework, across which the planks for the scaffold platform may be laid. Before the scaffolding is all in place the staves should be stood up within the inclosure; otherwise difficulty will be experienced in getting them into position.

It is probable that no better material can be obtained for the staves than Southern cypress. This, however, is so expensive in the North, as to preclude its use in most cases. Of the cheaper materials hemlock, white pine, and yellow pine, are usually the most available. At the present time hemlock is one of the cheapest satisfactory materials which can be purchased, and it is probably as good as any of the cheaper materials. It should be sound and free from loose knots.

If the silo is to have a diameter of 12 feet or less, the staves should be made of either 2x4 material, unbeveled on the edges and neither tongued nor grooved, or of 2x6 material beveled slightly on the edges to make the staves conform to the circular shape of the silo. If the silo is to have a diameter of more than 12 feet, the staves should be of 2x6 material, and neither beveled nor tongued and grooved on the edges. The staves should be surfaced on the inside so that a smooth face may be presented which will facilitate the settling of the silage. The first stave set up should be made plumb, and should be toe-nailed at the top to one of the posts originally set. Immediately a stave is set in place it should be toe-nailed at the top to the preceding stave set. It has been found that the work of setting up and preserving the circular outline may be materially aided by the use of old barrel staves (see Fig. 18). For a silo 12 feet in diameter the curve in the stave of the sugar barrel is best adapted; for a 16-foot silo the flour barrel stave is best, and for a silo 20 feet or more in diameter the stave of the cement barrel is best. If when the silo staves are put in place they are toe-nailed securely to the ones previously set if they are fastened firmly to the permanent upright post (Fig. 17, a, a, a, a); if the barrel staves are used as directed above, the silo will have sufficient rigidity to stand until

the hoops are put in place. However, if it becomes necessary for any reason to delay for any considerable time the putting on of the hoops, boards should be nailed across the top of the silo.

When it is found impossible to secure staves of the full length desired, a joint or splice must be made.

For a silo 30 feet deep, staves 20 feet in length may be used. A part of these should be used their full length and part should be sawed through the middle, thus making staves of 20 and 10 feet length. In setting them up the ends which meet at the splice should be squared and toe-nailed securely together. They should alternate so that first a long stave is at the bottom then a short one, thus breaking joints at 10 feet and 20 feet from the base.

For the hoops, $\frac{5}{8}$ -inch round iron or steel rods are recommended, although cheaper substitutes have been found satisfactory. Each hoop should be in three sections for a silo 12 feet in diameter, in four sections for a silo 16 feet in diameter. If the method of construction shown in Fig. 17 is followed, the hoops

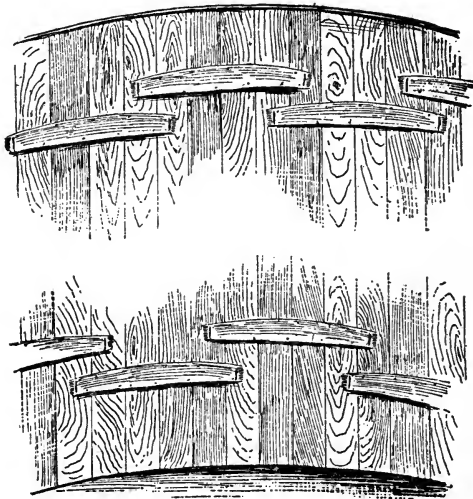

Fig. 18.—Shows how barrel staves may be used in setting up a silo. They should be removed before the silo is filled.

will need to be in four sections each, the ends being passed through the upright 6x6 posts, and secured by heavy washers and nuts. The bottom hoop should be about six inches from the base of the silo; the second hoop should be not more than two feet from the first; the third hoop two and one-half feet from the second, the distance between hoops being increased by one-half foot until they are three and one-half feet apart, which distance should be maintained except for the hoops at the top of the silo which may be four feet apart. The hoops should be drawn fairly tight before the silo is filled, but not perfectly tight. They must be tight enough to close up the space between the staves, thus preventing any foreign matter from getting into the cracks which would prevent the staves from closing up as they swell, and allow air to enter. To hold hoops and staves in place during the summer when the silo is empty, staples should be driven over the hoops into the staves. If a sufficient number of staples are used they will prevent the sagging or dropping down of the hoops, and they will hold the staves securely in place.

The hoops should be watched very closely for a few days after the silo is filled. If the strain becomes quite intense the nuts should be slightly loosened. If during the summer when the silo is empty and the staves thoroughly dry the hoops are tightened so that the staves are drawn closely together when the silo is filled and the wood absorbs moisture and begins to swell, the hoops must be eased somewhat to allow for the expansion.

The doors, 2 feet wide by 2½ feet high, should be located where convenience in feeding dictates. The lower door should be between the second and third hoops at the bottom, and other doors will usually be needed in every second space between there and the top, except that no door will be needed in the top space, as the silage when settled will be sufficiently low to enable it to be taken out at the door in the space below. Plans should be made for the doors at the time the staves are set. When the place is reached where it is desired to have the doors, a saw should be started in the edge of the stave at the points where the top and bottom of the doors are to come. The saw should be inserted so that the door can be sawed out on a bevel, making the opening larger on the inside of the silo. (See Fig. 15.) This will enable the door to be removed and put in

place only from the inside, and when set in place and pressed down with silage the harder the pressure the tighter will the door fit. After the silo is set up and the hoops have been put on and tightened the cutting out of the doors may be completed. Before doing this, cleats 2 inches by 3 inches and in length equal to the width of the door, should be made which will conform to the circular shape of the silo. One of these cleats should be securely bolted to the top and one to the bottom of where the door is to be cut. (See Fig. 15.) After the bolting, the door may be sawed out, and it is then ready for use. When set in place at time of filling the silo a piece of tarred paper inserted at the top and bottom will fill the opening made by the saw and prevent the entrance of any air around the door.

Another Door for Stave Silo.

Silage being heavy to handle and pitch up, has made continuous doors a popular feature of a few factory-built silos, as it is much easier to get the silage out of the silo for feeding. The illustration, Fig. 19, shows a method of making a door in home-made silos which is continuous with the exception of a narrow brace piece extending across the opening, under each hoop, to give rigidity to the structure. These pieces should be securely toe-nailed at each end to the staves. The jamb pieces, e, e, should be 2 inches thick, beveled off on the side away from the door, securely spiked to the inside of the stave, as shown, so as to leave a rabbet 2x2 inches. Great care should be taken to have these pieces exactly the same distance apart throughout their entire length, so that the door boards, being sawed the exact length, will fit alike and properly all the way up, and if care be taken in this regard it will not be necessary to replace them in the same order at each successive filling of the silo. The door boards should be matched, two inches thick the same as the staves, and if surfaced and well seasoned there need be no fear of the silage spoiling around such a door. A strip of acid and water-proof paper may be placed in the rabbet, between the ends of the door boards and the stave, as an extra precaution, but if the carpenter work is well done it is not absolutely necessary.

Such a door can be adapted to any form of stave silo, and, if not more than two feet wide, the fact that the door section is straight instead of curved will make no difference.

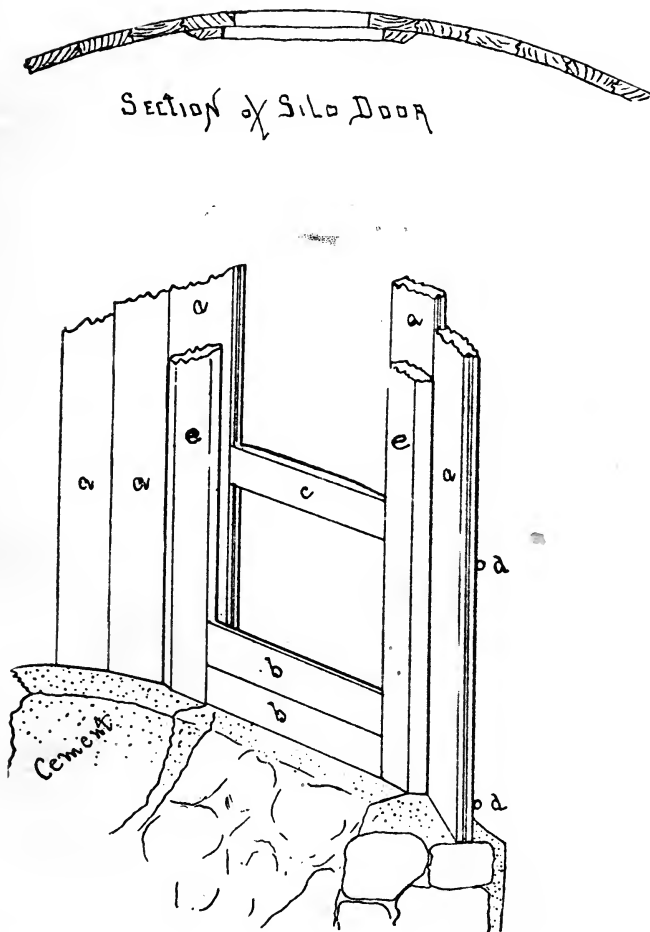

Fig. 19.—a, a, Staves. b, b, Door Boards. c, Brace $2\frac{1}{2}$ by 6, set in. d, d, Hoops. e, e, Jamb Pieces.

If the silo is built outside of the barn some sort of a roof is desirable. This should be sufficiently wide to protect the walls of the silo as thoroughly as possible. A very satisfactory roof is shown in Fig. 16. Two other constructions of a cheap roof for a stave silo are shown in Figs. 20 and 21. The latter was built at the Indiana Experiment Station at a total cost of \$10.50, viz., lumber, \$4.00; tin put on and painted, \$6.00, and hardware, 50 cents. Two 2x6 pieces (AA) were placed on edge and toe-nailed to the top of the staves they rested on; the projection is for supporting the carrier at filling time. They are tied together by the short pieces E. The roof is in three sections, G, H, and I. G and H are hinged to the frame A, A, and may be tipped up when the silo is nearly full, to allow filling to the top. The narrow middle section is light enough to lift off on either side, and leaves the opening for the carrier to deliver into.

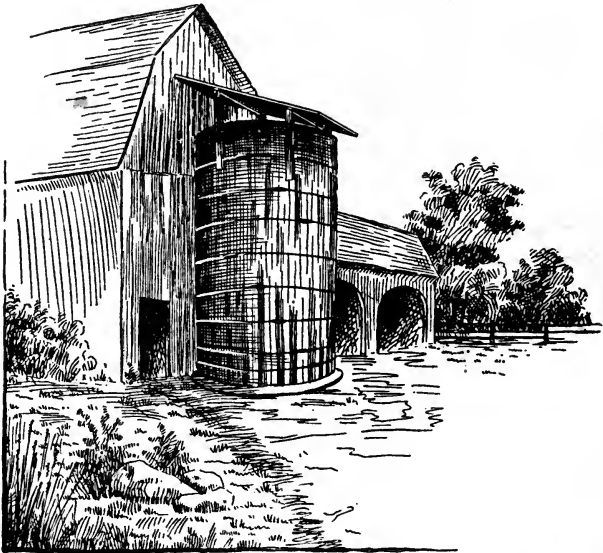

Fig. 20.—A cheap roof for stave silos.

On the framework B, B, and C, C, cheap sheeting boards are nailed. This is then covered with tin, soldered joints and painted. The sections should be fastened down by means of staples and hooks, or other device; the hooks are used on this one. On the inner edge of G and H, 2x2-inch strips, K, are nailed. Close to these are placed similar strips, J, to which the cross-boards are nailed, forming the section I of the roof. The tin

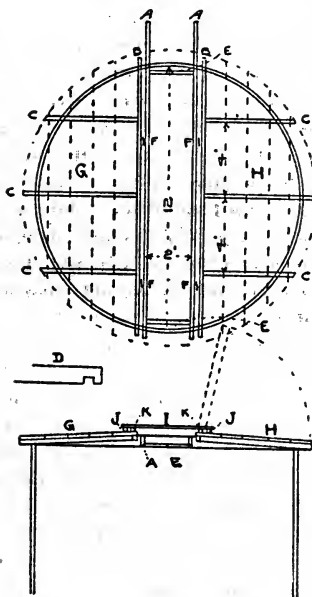

Fig. 21.—A CHEAP ROOF OF STAVE SILO.

A, B, and E, 2x6 in.; C, 2x4 in.; D, E, Enlarged Outside End; F, Hinges; G, H, I, Sections of Roof; J, K, 2x2 in. (Van Norman.)

on the section I should come over to the side of J. On the other sections it should run up on the side of K, making a water-tight joint.

The sections G and H have slope of nearly 3 inches, being the difference in height of A and C. C is notched one inch at the outer end. (Van Norman.)

A Modification of the Stave Silo.

Stave silos are admittedly cheap and readily put up, but unless hoops are tightened as they dry out, they may be easily blown into a shapeless mass in case of a heavy gale. The modification of the stave silo described in the following has the advantage of being more rigid and substantial; it has been put up in a number of places in the East, and has apparently given good satisfaction for several years at least. In building this silo some good tough oak plank two inches thick and of any convenient length are procured. Rock elm will do, although not as good as oak. The planks are sawed into strips half an inch thick. The foundation of the silo is made of concrete, and a little larger than the outside diameter of the silo. A stake is set in the center and on this a piece is nailed, just long enough to act as a guide in setting scantling when erecting sides. For sides $1\frac{1}{2}$ x4-inch hemlock of any desired length is used. These are set up on the circumference of the silo, perpendicular to the bottom, 3 feet and 7 feet up nail on the outside one of the half-inch strips mentioned before, being sure to keep the circle regular. This will keep upright pieces in place until the circle is completed. On each hoop so started other half-inch pieces are nailed, lapping them in different places until each hoop is three inches thick. Other hoops are now put on in the same manner, placing them one foot apart at bottom up to the three-foot hoop, 16 inches apart from three to the 7-foot hoop, then increasing the distance between each hoop two inches, until they are 30 inches apart, at which distance they should be kept. If staves are to be spliced it should be done on the hoop. When this is done, a silo will be made of $1\frac{1}{2}$ x4-inch, thoroughly hooped with wooden hoops 2x3 inches.

The inside may be covered with the best quality of felt, well tacked to the staves, on which a thick coat of thick coal tar is spread; over this another thickness of felt is put while the tar coating is still green. The silo is lined with $\frac{3}{8}$ -inch Georgia pine ceiling, nailing thoroughly and the lining coated with two coats of coal tar, putting on the first one quite thin, but using all the wood will take in, and for a second coat tar as thick as can be spread. Give plenty of time to dry before filling.

The outside of the silo may be boarded up with vertical

boarding, or it may have strips nailed on hoops and be boarded with novelty siding. The latter method will make a stronger and better looking silo. If the hoops are well nailed to the staves when being made, we shall have a silo in which it is impossible for the staves to shrink or get loose. (Woodward.)

Protection against freezing.—If the silo is built out-doors in any of the Northern states, it is necessary to provide some special means to keep the silage from freezing in case this is considered a very objectionable feature. The silo may be inclosed by a wide jacket of rough boards nailed to four uprights, leaving the section of the silo where the doors are easy of access; the space between the silo and outside jacket is filled with straw in the fall; this may be taken out and used for bedding in the spring, thus allowing the staves to be thoroughly dried out during the summer, and preventing the silo from rotting.

Number of staves required for stave silos.—The following table (Table VI) will be found useful in calculating the number of staves required for silos of different diameters, and feeding areas which these will give:

Table VI.—Circumferences and Areas of Circles.

Diameter, Feet	Circumfer- ence, Feet	Area, Square Feet	Diameter, Feet	Circumfer- ence, Feet	Area, Square Feet
8	25.1	50.3	21	66.0	346.4
9	28.3	63.6	22	69.1	380.1
10	31.4	78.5	23	72.3	415.5
11	34.6	95.0	24	75.4	452.4
12	37.7	113.1	25	78.5	490.9
13	40.8	132.7	26	81.7	530.9
14	44.0	153.9	27	84.8	572.6
15	47.1	179.7	28	88.0	615.8
16	50.3	201.1	29	91.1	660.5
17	53.4	227.0	30	94.2	706.9
18	56.5	254.5	31	97.4	754.8
19	59.7	283.5	32	100.5	804.2
20	62.8	314.2			

To find the circumference of a circle, multiply the diameter by 3.1416.

To find the area of a circle, multiply the square of the diameter by 0.7854.

To find the cubical contents of a cylinder, multiply the area of the base (floor) by the height.

Example.—A silo 16 feet in diameter and 26 feet high is wanted; how many staves 2x6 inches will be needed, and what will be the feeding area in the silo and its capacity

The circumference of a circle 16 feet in diameter is 50.3 feet; there will therefore be required $50.3 \div \frac{1}{2} = 101$ staves, 2x6 inches, 26 feet high, or if staves of this height cannot be obtained, 135 staves 20 feet long, or 50 each of 12 and 14 feet long staves. The feeding area will be $16 \times 16 \times 0.7854 = 201.1$ square feet, and the cubical content of the silo, $201.1 \times 26 = 5228.6$ cubic feet. Estimating the weight of a cubic foot of corn silage at 40 pounds, 5228.6 cubic feet of silage would weigh 209,164 pounds, or about

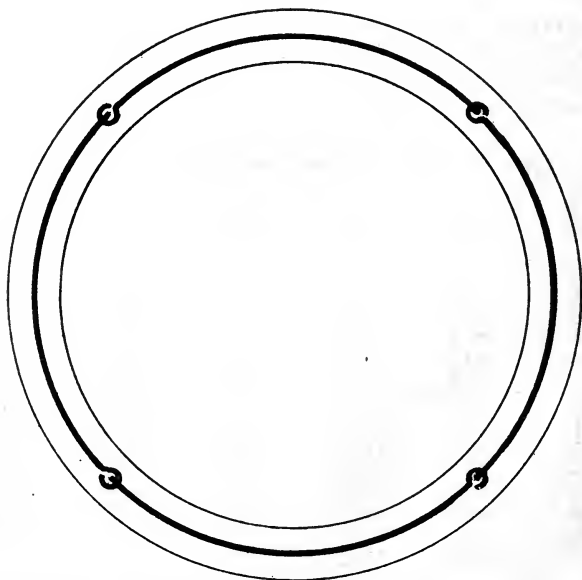

Fig. 23.—Showing method of bedding iron rods in stone, brick, or concrete walls, to increase the strength. The ends of rods should be firmly linked together as shown.

100 tons, which is the approximate capacity of a round silo of the dimensions given.

Connecting Round Silos with Barn.—The location of the silo with reference to other farm buildings has already been discussed. The silo must be easy to get at from the stable, and the silage, if possible, handled only once in being placed before the stock. A round silo is most conveniently built just outside of the barn and connected with this by means of covered passageway. The method of joining silos to barns is illustrated in numerous pictures of silos given in this book.

Details concerning the construction of stone, brick, and cement silos are given in Prof. Woll's "Book on Silage," and in Bulletin No. 83 of Wisconsin Experiment Station by Prof. King, as well as in numerous other pamphlets, and we shall not take up further space here with the discussion thereof. The same holds true with all other forms of silo construction than those already explained. We wish to briefly mention, however, the octagonal type of silo.

Octagonal Silos.

A number of octagonal silos have been built in recent years, and find favor with their owners in most instances. If properly put up and care taken to fasten the girts securely at the corners with plenty of spikes, the octagonal silo is greatly superior to the square type, and has nearly every advantage of the round silo, and can readily be constructed by anyone handy with tools with the assistance of the ordinary farm help.

The foundation should be of stone or brick as described for various other forms of silos, and should be laid out with proper dimensions for the size decided upon. Brief details are here given for an octagonal silo of about the same capacity as a round silo, 20 feet in diameter and of equal height.

If the foundation is laid out so that the corners are in the circumference of a circle 21 feet in diameter the horizontal girts will be about 8 feet long, and will be much stronger and better able to withstand the lateral pressure than the sides of a square silo of equal capacity. Details of construction are shown in the drawings, Figs. 25 and 26. The girts should be 3x8 inches and spiked at the corners with 6-inch spikes, up to

nearly one-half of the height of the silo, and 2x8 in. the rest of the way, fastened with 20 penny spikes. The girts should be 16 inches apart at the bottom for one-third of the height of the silo. They may be 18 inches apart the second third of the distance, and above that the distance between them can be increased till they are 2 feet or more at the very top. A double row may be used for a plate. Sound timber only should be used. Care should be taken to have the girts **securely** spiked at the corners, so that the joints will not give. The horizontal girt sections take the place of hoops in the round silo and must be strong. **Not less** than six or eight spikes should be used at each splice. One of the causes of failure in home-made silos of every kind is that the ordinary carpenter, who has probably never built a silo before, has but a limited idea of the pressure on the sides of a silo 30 or more feet deep, and does not realize the disappointment and loss occasioned by a poorly built silo.

A simple method of getting the walls perpendicular is to first lay the sill, which should be fastened to the wall securely,

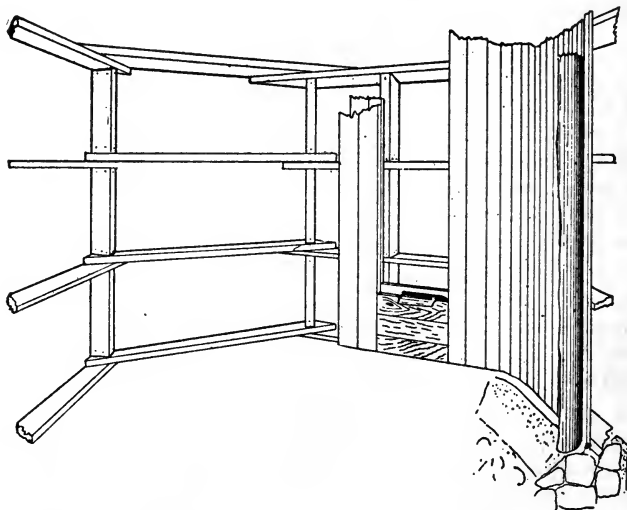

Fig. 25.—Perspective, showing construction of frame, and double lining with paper between. The door is made of two thicknesses with paper between, as shown.

by means of bolts set in the wall, and then erect at each corner and on the inside a temporary post or scantling to serve as a guide, braced in position so that it is perpendicular both ways, and the girts then laid and spiked in position, one above the other.

The lining is, of course, put on up and down and should be matched and of good thickness, say $1\frac{1}{4}$ or $1\frac{1}{2}$ if but one layer is used. If two layers, it need not be so thick, $\frac{7}{8}$ -inch flooring, and the outer layer not necessarily matched. The corners should be fitted as nicely as possible, and it is a good plan to block out the corners, as shown at Fig. 26, **a, a, a**, so that the tongues and grooves can be properly adjusted to each other.

John Gould, a prominent dairy writer and lecturer, recommends, where one thickness of matched lumber is used in the above manner, that the lining be thoroughly coated on the outside with heavy application of coal tar, or other similar substance, so as to prevent the air penetrating the pores of the lumber, and causing the silage to dry-onto the inner surface.

Any style of door can be used, but an effective continuous door is shown in the illustration. If any of the girts be cut

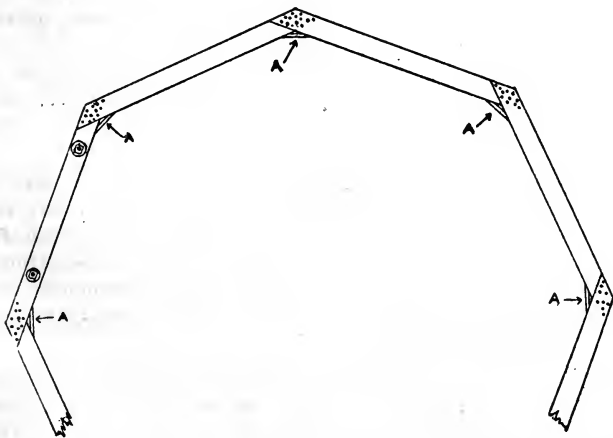

Fig. 26.—Showing method of laying sill and bolting same to foundation for an octagonal silo.

out to make the door space larger, the remaining ones should be correspondingly reinforced.

The making of a roof for such a silo is a simple matter, and a dormer window will assist in filling, although a trap door may be used in case the filling be done with a blower. Any style of siding may be used.

Such a silo if well built will be durable, satisfactory, have nearly all the advantages of a round silo, and in addition will be a much more stable structure, requiring no tightening of the hoops from time to time.

Bills of material for a silo built to 21-foot circle and 30 feet high are given below. The cost will, of course, vary with the locality.

Bills of materials for Octagonal Silo 20x30 feet outside measurement:

Foundation.....	10 perches
Grts	110 feet 3x8 } 8 or 16 foot
	900 feet 2x8 } lengths.
Rafters.....	230 feet 2x4x14 feet
Siding.....	2500 feet
Lining.....	2800 feet 1¼ inch thick, matched
Dormer Window	
Nails and spikes.....	300 lbs.
Shingles.....	.4 M
Paint.....	6 gallons

The "Ballard" silo is a lumber silo of the octagonal type, designed to be built of material that can be found in any retail lumber yard. It is one of the contributions of the Plan Book Department of the Western Retail Lumbermen's Association, of Spokane, Washington, for the benefit of the customers of its members; and its success has brought about its introduction into a very extended territory.

Its features are its low cost, both in material and labor; its strength and rigidity; and the simple method of adapting its construction to meet the varying climatic conditions of widely separated localities. No skilled labor is required, no patented materials are used, and the shape and details of construction

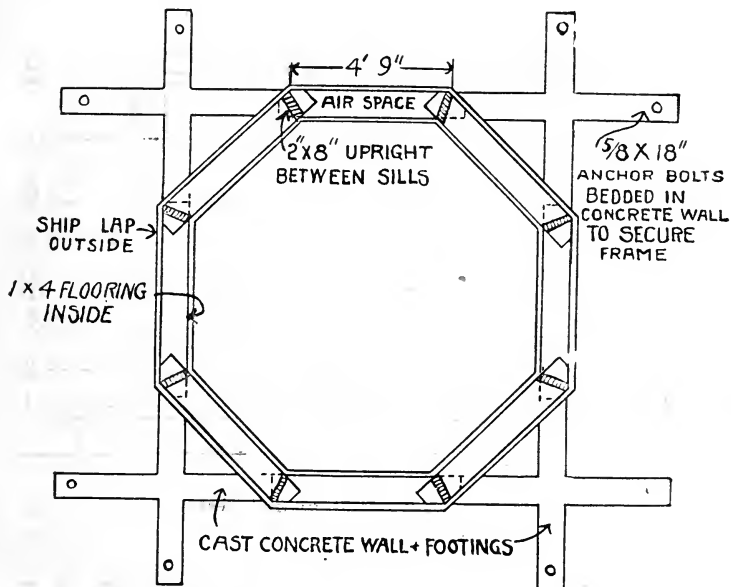

Fig. 5.—Showing foundation plan, also method of placing sill, etc.

are especially adapted for the "battery" system in which several small silos are built in succession as the demand for silage increases. There is a desirable saving of cost and an increase in solidity and rigidity in the "battery" system that is of interest. It is the "sectional book case" idea applied to the farm.

The illustrations shown by Figures 5, 22, 24 and 32 were prepared from blue prints furnished by the above company and apply to the 10x30 foot size holding 45 tons.

The anchor bolts shown in Fig. 5 are for attaching 4x8 bracing. Similar bolts are placed in the concrete wall to which sill is firmly bolted. In Fig. 22, ribs No. 1 to 6 are spaced 12 inches apart. Ribs No. 6 to 12 are 18 inches apart; No. 12 to

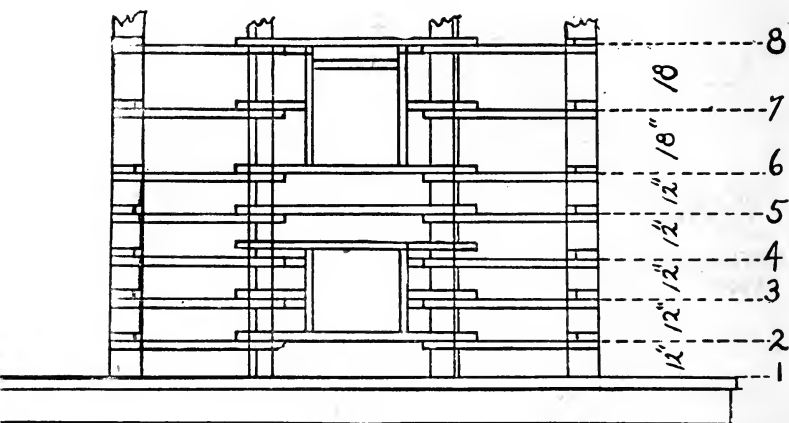

Fig. 22.—Skeleton showing method of framing.

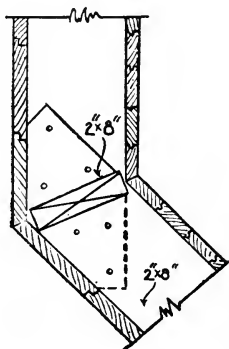

Fig. 24.—Showing plan of joints.

16, 24 inches apart, and No. 16 to 19, 32 inches apart. Fig. 24 shows the method of jointing and spiking the ends of chords, also the 2x8-inch upright support between the ribs. The shiplap outside and the 1x4-inch flooring inside are also shown.

The regular chord in ribs No. 2 to No. 18 and part of rib No. 19 is shown in the larger drawing, Fig. 32. The smaller drawing represents the chord for ribs No. 1 and No. 19. The $\frac{3}{4}$ -inch bolt holes shown are for bolting sill or rib No. 1 to the foundation.

Another type of octagonal silo that has found favor in some sections of the corn belt because of the fact that the material

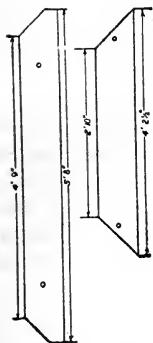

Fig. 32.— Pattern for chords or ribs. The small size is used only for sill and plate ribs.

is easily obtainable from any lumber yard, is built by simply placing one 2x4 on top of another interlocking the corners and nailing together. The 2x4's are sawed at the proper angle to fit silos from 10 to 20 feet in diameter. The lining consists merely in placing prepared roofing on the inside to make it air-tight. It is said that this silo may be built with but 15 to 20 tons capacity and at any later time may be increased in capacity by building it higher.

Cost of Different Kinds of Silos.

The cost of a silo will depend on local conditions as to price of labor and materials; how much labor has to be paid for; the size of the silo, etc. The comparative data for the cost of two round silos, 13 and 25 feet in diameter, and 30 feet deep, is given by Prof. King, as shown in the following table:

Table VII.

Kinds of Silo	13 Feet Inside Diameter		25 Feet Inside Diameter	
	Without Roof	With Roof	Without Roof	With Roof
Stone Silo	\$151	\$175	\$264	\$328
Brick Silo	243	273	437	494
Brick-lined Silo, 4 inches thick	142	230	310	442
Brick-lined, 2 inches thick.	131	190	239	369
Lathed and plastered Silo	133	185	244	363
Wood Silo with galvanized iron	168	185	308	432
Wood Silo with paper.....	128	222	235	358
Stave Silo	127	183	136	289
Cheapest wood Silo.....	101	144	195	240

During the spring of 1895 Prof. Woll made inquiries in regard to the cost of silos of different kinds (not only circular ones) built by farmers in different states in the Union. The results of this inquiry are summarized briefly below.

The cheapest silos were those built in bays of barns, as would be expected, since roof and outside lining are here already at hand. Number of silos included, fourteen; average capacity, 140 tons; average cost of silos, \$92, or 65 cents per ton capacity.

Next comes the square or rectangular wooden silos. Number of silos included, twenty-five; average capacity, 194 tons; average cost of silos, \$285, or \$1.46 per ton capacity.

The round silos follow closely the square wooden ones in point of cost. Only seven silos were included, all but one of which were made of wood. Average capacity, 237 tons; average cost, \$368, or \$1.54 per ton capacity. The data for the six round wooden silos are as follows: Average capacity, 228 tons; average cost, \$340, or \$1.52 per ton capacity. The one round cement silo cost \$500, and had a capacity of 300 tons (dimensions: diameter, 30 feet; depth, 21 feet); cost, per ton capacity, \$1.67.

The stone or cement silos are the most expensive in first cost, as is shown by the data obtained. Number of silos included, nine; average capacity, 288 tons; average cost, \$577, or \$1.95 per ton capacity.

The great difference in the cost of different silos of the same kind is apparent without much reflection. The range in cost per ton capacity in the 25 square wooden silos included in the preceding summary was from 70 cents to \$3.60. The former figures were obtained with a 144-ton silo, 20x18x20 feet; and the latter with a 140-ton silo, built as follows: Dimensions, 14x28x18 feet; 2x12x18 feet studdings, set 12 inches apart; two thicknesses of dimension boards inside, with paper between, sheeting outside with paper nailed on studding; cement floor. Particulars are lacking as regards the construction of the first silo beyond its dimensions.

It may be in order to state, in comparing the average data for the cost of the different silo types, that the round silos were uniformly built better than the rectangular wooden silos included, and according to modern requirements, while many of the latter were old and of comparatively cheap construction, so that the

figures cannot be taken to represent the relative value of rectangular and round silos built equally well.

A good many figures entering into the preceding summaries are doubtless somewhat too low, if all labor put on the silo is to be paid for, for in some cases the cost of work done by the farmers themselves was not figured in with other expenses. As most farmers would do some of the work themselves, the figures given may, however, be taken to represent the cash outlay in building silos. In a general way, it may be said that a silo can be built in the bay of a barn for less than 75 cents per ton capacity; a round or a good square or rectangular wooden silo for about \$1.50, and a stone or cement silo for about \$2 per ton capacity, all figures being subject to variations according to local prices for labor and materials.

Rennie, a Canadian writer, gives the following comparative figures as to cost of silos: Round stave silos, 75 cents per ton capacity; round wooden silos, \$1.25, and cement silos, \$1.25 to \$1.50 per ton capacity.

The cost of stave silos will of course vary with the kind of lumber used, cost of labor, and other expenses, as in case of other types of silos. It is evident that stave silos can as a rule be built cheaper than other kinds of silos, both from the fact that less material is used in their construction, and because the labor bill is smaller. One of the first stave silos described, built in Ontario, Canada, cost \$75.00; capacity, 140 tons. Other and better built stave silos have been put up for \$100 for a 100-ton silo, and this may be considered an average price for such a silo, made of white pine, hemlock or any lumber that is cheapest in the particular locality where the silo is to be built. If built of Southern cypress, and complete with conical roof and doors, the price of stave silos will in the North come to about \$1.50 per ton capacity, small silos being a little dearer, and larger ones a little cheaper than this average figure.

Estimating Material and Cost of Silos.

Several writers on silo construction have published bills of materials used in the construction of silos of moderate sizes of the following three types: Wisconsin Improved Silo, Modified Wisconsin Silo, and Stave Silo. Farmers contemplating building

a silo, can use these estimates for figuring out the approximate cost of silos of the three kinds under his conditions as to cost of materials and labor. The estimates are made for silos built in the open, on level land. On hillsides deeper walls may be made to advantage, and where the silo is located within a building no roof will be needed. Consequently various factors may alter the applications of these estimates, which are only offered as suggestive with the hope they may prove helpful. The first three estimates of materials are published by Prof. Plumb, while the others have been furnished by Professors King and Withycombe.

Estimate of Materials for Wisconsin Improved Silos.

Size, 30 feet deep, 14 feet diameter. Capacity 90 tons.

Brick—3375 for foundation, 1 foot thick, 3 feet deep.

Studs—50 pieces 2x4, 16 feet long.

Studs—50 pieces 2x4, 14 feet long.

Flooring for doors—32 feet, 4 matched.

Sheeting—3000 feet, $\frac{1}{2}$ inch, resawed from 2x6—16 foot plank sawed three times, dressed one side to uniform thickness for inside lining of two layers.

Lining—1500 feet of same for outside.

Tar building paper—200 yards, water and acid-proof.

Nails—200 lbs. 8-penny; 200 lbs. 10-penny.

Spikes—20 lbs.

Rafters—22, 2x4, 10 feet long, for usual ridge roof.

Sheeting for roof—350 feet of 16 foot boards.

Shingles—3000.

Shingle nails—12 lbs.

Dormer window for filling through.

Paint—7 gallons, providing two coats.

Cement—2 barrels, for cementing bottom.

Estimate of Materials for a Modified Wisconsin Silo.

Same capacity as preceding.

Brick—350 for foundation, 8 in. wide, 5 in. thick.

Studs—50 pieces 2x4, 16 feet long.

Studs—50 pieces 2x4, 14 feet long.

Sheeting—3000 ft. $\frac{1}{2}$ in. resawed from 2x6, 16 ft. plank sawed three times, dressed to uniform thickness for inside lining of two layers.

Tar building paper—200 yards water and acid-proof.

Nails—150 lbs. 8-penny.

Spikes—12 lbs.

No outer siding, roof or floor is figured on or provided for in this construction.

Estimate of Materials for a Stave Silo.

Size 12x28 ft., capacity 60 tons.

Bricks—1800 for foundation, 1 foot thick, 2 ft. deep.

Staves—77 2x6, 16 ft. dressed 4 sides.

Staves—77 2x6, 12 ft. dressed 4 sides.

Rods—10, 19½ ft. long ½ in. iron, with ⅝ threaded ends and nuts.

Staples—2 gross, ½x2 in.

Iron tighteners—20 holding ends of hoops.

Rafters—2 2x6 pieces, 14 ft. long for roof center.

Rafters—2 2x6 pieces, 13 ft. long, for roof next center.

Side rafters—48 ft. 2x4 pieces.

Roof sheeting—170 ft. common.

Tin sheeting—196 ft.

Cement for floor—2 bbls.

Estimate of Materials for a Wisconsin Improved Silo.

Size 30 ft. deep, 20 ft. inside diameter, capacity 200 tons.

Stone foundation—7.5 perch.

Studs—2x4, 14 and 16 ft., 1491 ft.

Rafters—2x4. 12 ft., 208 ft.

Roof boards—Fencing, 500 feet.

Shingles—6 M.

Siding—Rabbeted, 2660 ft.

Lining—Fencing, ripped, 2800 ft.

Tarred paper—740 lbs.

Coal tar—1 bbl.

Hardware—\$6.00.

Painting (60 cents per square)—\$13.20.

Cementing bottom—\$5.00.

Carpenter labor (at \$3 per M and board)—\$33.17.

The estimated cost of the last silo is \$246.39; it is an outside, wholly independent structure, except connected with the barn in the manner shown in Fig. 20, with entrance and feeding chute toward the barn.

Estimate of Materials for Stave Silo.

12 ft. in diameter, 24 ft. deep, capacity 49 tons.

1 2-3 yards of rock gravel.

4 barrels of sand.

1 barrel of cement.

2260 ft. tongued and grooved staves.

72 ft. 3x6, 24 ft. door frames.

358 ft. ⅝ in. round iron for hoops and bolts, weight 465 lbs.

9 lugs.

54 nuts.

Preservative (\$1.50).

If the silo is constructed outside, materials for roof and painting are to be added to the preceding list.

Although most of the foregoing descriptions of stave silos do not mention tongued and grooved staves, the latest practice indicates that, if properly done, it is a decided advantage to have the staves matched, also slightly beveled. The silo made in this manner will not be so liable to go to pieces when empty. This is the chief objection to the stave silo, and numerous cases are on record where stave silos standing in exposed places have blown over when empty. It is recommended, therefore, that stave silos be attached to the barn by means of a feeding chute, and in the case of high or exposed silos it is well to make use of guy rods or wires in addition. Indeed, some manufacturers of stave silos now recommend these on some of their silos, and make provisions for them.

Preservation of Silo.

A silo building will not remain sound for many years unless special precautions are taken to preserve it. This holds good of all kinds of silos, but more especially of wooden ones, since cement coating in a stone silo, even if only fairly well made, will better resist the action of the silage juices than the wood-work will be able to keep sound in the presence of moisture, high temperature, and an abundance of bacterial life.

In case of wooden silos it is necessary to apply some material which will render the wood impervious to water, and preserve it from decay. A great variety of preparations have been recommended and used for this purpose. Coal tar has been applied by a large number of farmers, and has been found effective and durable. It may be put on either hot, alone or mixed with resin, or dissolved in gasoline. If it is to be applied hot, some of the oil contained in the tar must previously be burnt off. The tar is poured into an iron kettle, a handful of straw is ignited and then thrown into the kettle, which will cause the oil to flash and burn off. The tar is sufficiently burnt when it will string out in fine threads, a foot or more in length, from a stick which has been thrust into the blazing kettle, and afterward plunged into cold water. The fire is then put out by placing a tight cover over the kettle. The kettle must be kept over the fire until the silo lining has been gone over. A

mop or small whisk broom cut short, so it is stiff, may serve for putting on the tar.

Coal tar and gasoline have also been used by many with good success. About half a gallon of coal tar and two-thirds of a gallon of gasoline are mixed at a time, stirring it while it is being put on. Since gasoline is highly inflammable, care must be taken not to have any fire around when this mixture is applied. Asbestos paint has also been recommended for the preservation of silo walls, and would seem to be well adapted for this purpose.

Many silos are preserved by application of a mixture of equal parts of boiled linseed oil and black oil, or one part of the former to two of the latter. This mixture, applied every other year, before filling time, seems to preserve the lining perfectly. In building round silos, it is recommended to paint the boards with hot coal tar, and placing the painted sides face to face.

Manufacturers of stave silos and fixtures put up special preparations for preserving the silos, which they send out with the staves. These are generally simple compounds similar to those given in the proceeding, and are sold to customers at practically cost price.

Walls of wooden silos that have been preserved by one or the other of these methods will only keep sound and free from decay if the silos are built so as to insure good ventilation. Preservatives will not save a non-ventilated silo structure from decay.

Plastered wooden silos are preserved, as we have seen, by applying a whitewash of pure cement as often as found necessary, which may be every two or three years. The same applies to stone and cement silos. The degree of moisture and acidity in the silage corn will doubtless determine how often the silo walls have to be gone over with a cement wash; a very acid silage, made from immature corn, will be likely to soften the cement coating sooner than so-called sweet silage made from nearly mature corn.

A considerable number of wood silos are in use that were not treated on the inside with any preservative or paint and have stood very well. Indeed, some writers maintain that if the silo is well protected on the outside, a stave silo receives little if any benefit from inside coatings.

CHAPTER III.

MONOLITHIC CONCRETE SILOS—METAL-LATH AND STEEL-RIB PLASTERED SILOS—CEMENT BLOCK AND CEMENT STAVE SILOS—VITRIFIED TILE SILOS—BRICK SILOS—ALL-METAL SILOS. UNDERGROUND SILOS.

Several types of silos in which cement plays an important part are now in successful use in all parts of the country. Among them are the monolithic reinforced concrete silos, both single wall and double or hollow wall; metal-lath and steel-rib plastered silos; cement block and cement stave silos of various types; hollow brick or vitrified tile silos and brick silos. All of these types, as well as the all-metal silos and pit or underground silos will be discussed in this chapter.

When properly constructed so as to make the walls strong, smooth and impervious, practically all of the types of silos mentioned above have been used with success. There maybe a difference, of course, from the standpoint of permanence or durability just as there is a difference in the life of various woods used. Aside from the really essential features, there are a number of desirable features attached to the various types outlined herein; and when these are all carefully considered and balanced by the prospective silo builder, the cost, fixed largely by local conditions will probably be the deciding factor.

In the past, the high first cost of all forms of concrete construction has been the chief influence against their more extensive use, but this has been due to our insufficient knowledge as to the best and most economical methods in handling material. The price of lumber has been steadily rising, while that of good Portland cement has been decreasing, and good qualities can now be obtained at a fair price, so that this factor is largely removed.

Monolithic Concrete or Cement Silos.

The monolithic silo has reference to the one continuous solid mass or "as one stone" silo where the concrete is poured in forms. Wherever the old forms of silo construction are well established it is but natural that opposition to newer types should arise. The concrete silo, therefore, in common with some of the other types described in this chapter, had to gain headway in the face of much adverse criticism.

Among the arguments against concrete were that the walls were not air or moisture-proof; that they failed as heat retainers and allowed the contents to freeze very easily; and that the silage acids affected the concrete causing soft, crumbly walls that were easily cracked. In fairness to all concerned it may be said that these arguments were greatly overworked. If properly built and painted inside with a wash of pure cement, concrete can be made both air-proof and moisture-proof; where the wood silo gains as a non-conductor of heat, it loses in having much thinner walls, and the double wall concrete silo largely overcomes freezing. As to acidity, the experience of thousands proves this to be practically a negligible quantity where a pure cement or coal tar wash is applied every two or three years, the acids having less effect on cement than on either metal or wood. Among other claimed advantages of the concrete silo are these: they neither shrink in hot, dry weather nor swell up in damp weather; they maintain a more even temperature; they are vermin proof; they will last practically forever and need no repairs, and they are fire-proof.

Concrete grows stronger and tougher with age, outlasting almost every other known material. Reinforced concrete, selected for great engineering projects such as long bridges, massive dams and lofty skyscrapers, is considered the strongest and most enduring construction known.

"Reinforced concrete or concrete steel is very much stronger than ordinary concrete," say Bulletin No. 125 of the University of Wisconsin. "Reinforced concrete is concrete in which steel rods or wires are imbedded in such a way as to take the strain. By placing wire rods in the concrete it is possible to make the walls or beams much thinner or lighter than would otherwise be possible and obtain the required strength. By reinforcing the concrete with steel much cement is saved.

"If it were possible to have the work skillfully done a cement silo 16 feet in diameter and 35 feet high could be built of reinforced concrete with walls only 2 or 3 inches thick and be abundantly strong. But labor sufficiently skilled to do this would cost too much, so that it would be cheaper to use twice as much cement; make wall 6 or 8 inches thick and use less skilled labor. If the work is carefully done using ordinary labor it is practical to build silos 16 feet in diameter and 35 feet high with 6 or 8 inch walls if the steel rod is laid in the wall every 2 or 3 feet."

Reinforced concrete offers great possibilities for silo building. The lateral pressure on the walls when the silo is filled is very great, but the circular shape renders it very easy to reinforce. The single or solid wall is most generally used. Good four-inch wall silos have been built, but the six-inch wall offers greater convenience in placing reinforcement and justifies the use of more material. The saving of material by making the wall lighter at the top would hardly offset the trouble of varying the size of the forms.

The double wall or hollow wall concrete silos were designed partly to overcome the freezing of the silage which has been the one disadvantage of solid walls especially in cold climates. Machines are now on the market that easily and successfully build reinforced and continuous hollow walls. Iowa Bulletin No. 141, referring doubtless to conditions in that section, states that "the double wall concrete silo at present is made only with patented forms. The inner wall is $5\frac{1}{2}$ inches thick, the outer wall $3\frac{1}{2}$ inches thick, and the two tied together with steel ties with a three-inch air space between. Circulation is prevented by inserting horizontal tar paper partitions every $3\frac{1}{2}$ feet. This construction, besides being as satisfactory as the single wall method,



Fig. 27.— Cement Silo and No. 17 Ohio Cutter at Experiment Station, Sao Paulo, Brazil.

places it entirely above any criticism in regard to freezing. The patent forms being made of steel plate enable a very smooth job to be secured. In general it would seem that the expense of a double wall is not justified except in cold climates."

The foundation, as in all other concrete structures, is very important. Not only must it serve as an anchor to protect the structure against wind pressure, but it must also be very strong and firm or the great weight upon it will cause it to settle unevenly, in which event the walls are liable to crack and so admit air; consequently, spoiled silage will be the result. Where there is a good clay floor, a concrete floor in the silo is not necessary.

"The concrete silo when built as a monolith is practically a unit. Its walls and roof are bound together by a net-work of steel, laid in the concrete so as to withstand pressure from the inside," says Wisconsin Bulletin No. 214. "A silo built this way usually has walls six inches thick, which are reinforced in proportion to their size and capacity. The greater the height of a silo, the greater the pressure on the wall at the bottom."

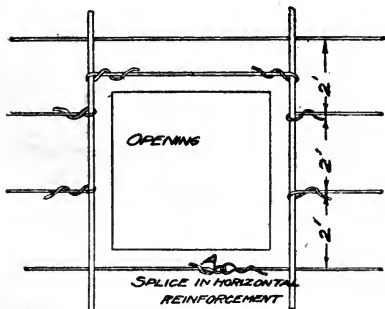

Fig. 28.—Horizontal Reinforcing around silo door.

Any silo bonded by cement is subject to contraction and expansion due to changes of moisture and temperature and should, therefore, be reinforced both horizontally and vertically. Perhaps the best reinforcement is secured by twisting No. 9 telephone wire together and forming a cable. This offers a rougher surface than the steel rods and forms a continuous band,

which is very effective. The reinforcement should be laid in the wall about one or two inches from the outside surface. Vertical reinforcement should be used in silos 25 feet high or more and is also convenient for binding the circular cables in place. Short three-foot lengths of $\frac{3}{8}$ -inch steel rods are most satisfactory for this purpose as they can be hooked together as the silo rises and not

be in the way in raising the forms. The size and spacing of horizontal reinforcing needed for silos is shown in tables reproduced herewith from Wisconsin Bulletin No. 214.

Table VIII.—Amount of Reinforcement Needed for Silos.

Size and Spacing of Horizontal Reinforcement Around Silo.

Distance in Feet Measured from Top of Silo	For Silos 14 ft. to 18 ft. in Diameter, Using No. 9 Wire.		For Silos 14 ft. to 18 ft. in Diameter, Using $\frac{3}{8}$ inch Mild Steel Rods.	
	No. of Wires in Cable	Distance Apart of Cables	No. of Rods	Distance Apart of Rods
		Inches.		Inches.
0—5	2	12	1	18
5—10	2	10	1	18
10—15	2	8	1	14
15—20	4	8	1	12
20—25	4	6	1	10
25—30	4	6	1	8
30—35	5	6	1	6
35—40	5	4	1	4

Vertical Reinforcement.

Height of Silo in ft.	For Silos 14 ft. to 18 ft. Diameter			
	No. of Wires in Each Cable	Distance Apart of Cables	No. of Rods	Distance Apart of Rods
		Inches.		Inches.
25—30	4	24	1	30
30—35	6	24	1	20
35—40	8	24	1	14

Figure 29 illustrates how a very satisfactory continuous doorway can be made by forming concrete jambs on both sides of the opening, with a recess on inner side for the 2-inch plank doors to fit against. The forms for these jambs should be erected between the inner and outer forms of the silo wall, and it will be seen that the 1-inch ladder rounds form the binder or horizontal reinforcing across the door opening and should be in position and twisted around the vertical reinforcing rod. Spacers consisting of 2x4's at intervals of two feet, will hold the jamb forms apart rigidly and prevent them from bulging from the pressure of the concrete.

The vertical jamb forms may be made in sections of any convenient length, preferably from six to twelve feet.

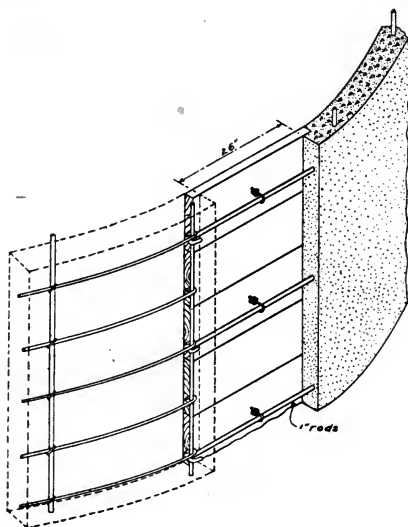

Fig. 29.—Continuous Doorway, with concrete jambs, showing manner of anchoring to the vertical reinforcing, and position of plank doors.

—Courtesy Universal Portland Cement Co., Chicago.

Care should be taken to have the wooden forms absolutely vertical. All surfaces of wood which will come into contact with the concrete should be planed and oiled, which will insure a smooth surface and prevent the wood from adhering to the concrete. Full illustrated details regarding constructions of this kind will be found in catalogs issued by several cement manufacturers.

Local conditions largely govern the cost of concrete silos. The ruling factors are the price of gravel and cement and the cost of labor. An investigation was made during the spring of 1911 by a large concrete manufacturing company to ascertain the actual cost of 78 monolithic silos scattered through Minnesota,

Wisconsin, Illinois, and Michigan. The total cost included material, labor, superintendence and all miscellaneous expenses incurred in preparing the silos, ready to receive the crops. Where sand and gravel were obtained on the farm the expense of hauling plus a fair price for materials was included. The average cost of the 78 silos was \$2.50 per ton capacity. The 20 silos having capacity 100 tons or less cost \$2.89 per ton. 32 silos with capacity from 100 to 200 tons cost \$2.38 per ton. The remaining 26 silos having capacity of more than 200 tons each, cost \$2.13 per ton capacity.

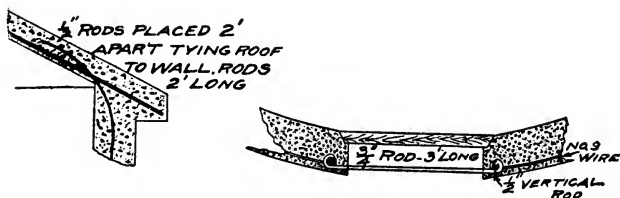

Fig. 30.—Showing method of tying roof to wall, and of reinforcing across door opening.

—Courtesy Wisconsin Bulletin No. 214.

We quote from Bulletin No. 125 of the Wisconsin station.

"A common type of form used in making a continuous wall or monolithic structure is illustrated in Fig. 31. A is the outside form and B the inside form. These forms are made as segments of the circle 6 or 10 feet in length and 1½ to 3 feet deep. A form is made by taking two pieces of plank 2x12 or 2x14, LL and UU, Fig. 31 A, sawing them out to the curvature of the circle. These are placed horizontally as girts and the short planks P are set vertically nailing them to the girts, LU. The form 31 B is made in the reverse of 31 A.

"In building the wall, form B is set inside of form A and 6 to 12 inches from it depending on the thickness desired for the wall, and the concrete is filled in between the forms."

The building of a concrete silo involves careful attention to the construction and proper bracing of the forms or moulds, and to the reinforcing and the bonding of the various courses. It is therefore suggested that unless a farmer has had some experience

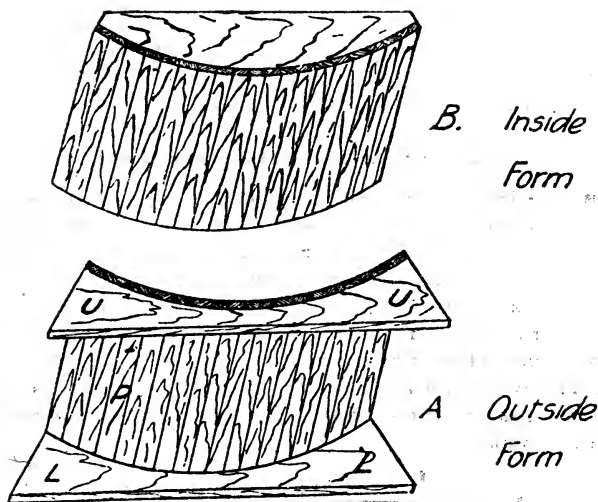

Fig. 31.—Illustrates method of making form for constructing concrete walls. The forms are made of plank and are made in sections 4 to 10 feet long, requiring 5 to 8 sections to complete the circle.

—Courtesy Wisconsin Experiment Station.

with other concrete work about the farm, he should not attempt to build the silo himself but should turn the job over to a concrete contractor under a guarantee for only a first-class silo.

The difficulty and expense connected with the preparation of proper forms has led to the adoption of co-operative effort in many sections. Some of the corn belt Agricultural Colleges make a practice of loaning to farmers at a nominal cost a set of forms together with the services of an expert. Manufacturers of mould and mixing equipment are also attempting to supply farmers with monolithic reinforced silos at minimum cost. One of these, known as the MONSCO, has a standardized outfit, consisting of scaffold-hoist with derrick, steel moulds for walls and chute, and power mixer. The moulds are made in two circles each 3 feet in height, divided into easily handled segments. Six feet of wall per day is poured, reinforcement and ladder irons being installed

at the same time and chute also being poured. The walls are 6 inches thick from top to bottom. The reinforcement used is American Steel and Wire Company cold-drawn triangular mesh, woven in various weights. This mesh provides sufficient vertical reinforcement to prevent temperature cracks.

Hy-Rib Concrete and Metal Lath Reinforced Silos.

The **Hy-Rib Concrete Silo**, so-called because of its steel-rib basis, has recently met with considerable success. It applies to silo building the principles of monolithic reinforced construction so successfully used in other buildings. In this type of silo no forms or framework for the walls are required. Sheets of stiff, firm steel sheathing are used, having a rough open surface, and one inch projecting ribs every four inches of height. These sheets are about two feet wide by 10 or 12 feet long. The first round of sheathing is, of course, properly imbedded and anchored in the foundation wall.

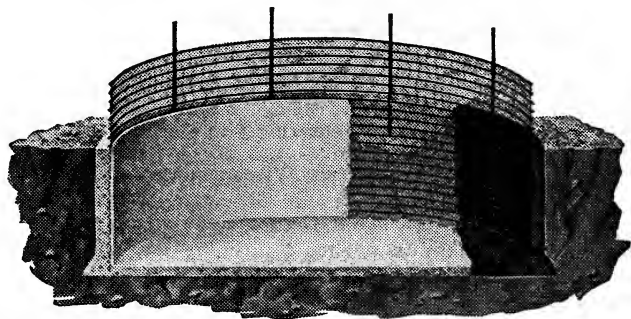

Fig. 33.—Cross Section of Foundation of Hy-Rib Silo.—Courtesy Trussed Concrete Steel Co., Youngstown.

The following printed matter has come to our attention and gives more complete information on reinforced cement and concrete silo construction.

Bulletin No. 255, "Cement Silos in Michigan," published by Experiment Station, East Lansing, Mich. "Silo Construction in Nebraska," by Agricultural Experiment Station, Lincoln, Nebr. Bulletin No. 100, "Modern Silo Construction," and No. 107, "The Iowa Silo," published by Experiment Station, Ames, Iowa. Farmers' Bulletin No. 405, "Cement Silos," and No. 589, "Home Made Silos," by the United States Department of Agriculture, Washington, D. C., and booklets on "Concrete Silos," published by the Universal Portland Cement Co., Chicago, Ills., The Trussed Concrete Steel Co., Youngstown, Ohio, and Monolithic Silo and Construction Co., Chicago, Ills.

The Hy-Rib Concrete Silo differs from the metal-lath silo in that the latter requires a temporary framework of 2x4 studding on which to tack the lath, whereas in the steel-rib silo, the sheets of steel are thoroughly locked together at both sides and ends, forming a firm, self-sustained framework or foundation of itself. To this the concrete is applied in the form of a 1:2½ waterproof cement plaster to a total thickness of from 3 to 3½ inches, as shown in the illustration, Fig. 33. Indeed, the manufacturers claim that they have silos of this construction in use 20x58 feet in size with the walls at the thickest point not more than 2¾ inches.

The Metal Lath Plastered Cement Silo also stands well to the front, from the standpoint of strength, economy and practicability. It is put up without forms except for the door posts and studding, the cement being applied in the form of plaster to both the inside and outside of the metal lath. This is accomplished by tacking the lath to the inside of the temporary frame work of 2x4 studding and applying several coats of cement or plaster, the studding then being removed and the outside plastered. Where materials used in construction are excessively high in price, it will prove cheaper to erect than the monolithic structure because the walls are only about three inches thick. Skilled labor is required for this type of silo. Care must be taken to prevent the various coats of cement from drying out rapidly, otherwise the next coat will not form a perfect union and the strength of the wall will be reduced. When properly constructed this silo will be found amply strong for the work required.

After the good solid concrete foundation is finished, a four-or-five-platform scaffold must be erected inside, before any other work is done. The form for the continuous door frame should then be built on the ground, complete with all reinforcing, and raised to position. 2x4 studding, with plates on top, are then placed in position and fastened. The 24-gauge expanded metal or metal-lath is then tacked to the inside with double-pointed tacks, beginning at the top and at the door post. Each strip of lath should be tacked first in the middle and should conform to the circular shape of the silo before the ends are tacked. After the several layers of cement or plaster have been applied and are dry, the studding may be removed and additional horizontal reinforcement in the form of strands of heavy wire should be placed around the silo, care being

taken to anchor same to vertical reinforcement in the door posts before any mortar is placed. A silo 16 by 30 feet will require 150 pounds of additional wire reinforcement. The silo should be plastered on the outside at least one inch in thickness. A metal-lath silo of the above dimensions, of about 120 tons capacity, can be built for from \$225 to \$275. The cost of these silos has not exceeded three dollars a ton capacity in any case, the average being considerably less than this amount.

Mr. George C. Wheeler of the Kansas Agricultural College Extension Service says: "The first round of the metal-lath which forms the chief reinforcement of this silo, must have its edge embedded 5 or 6 inches in the top of the foundation in order to insure a perfect union between the foundation and the wall proper. When the trench has been filled to within about 6 inches of the top and the concrete brought to an approximate level, the lath, which comes in strips 8 feet long and 18 inches wide, should be stood on edge and concrete poured on both sides of it. Its position should be on a circle having a radius 2 inches greater than the inside radius of the finished silo. As the strips of lath are stood up and the mortar poured in, they should be carefully curved and their exact position determined. The strips of lath should be lapped about three inches at the ends, and when the circle is completed the wall outside of the lath should be leveled. The wall, while still green, should be smoothed up as much as possible."

Modifications — Double and Single Wall.—A modification of this type of metal lath construction is shown in the illustration of Fig. 34. In this it will be seen that the lath or ribbed-steel is tacked to both the inside and the outside of the studding and plastered or cemented, forming a double or hollow wall construction. This would doubtless require less skilled labor than where the studding is removed, and the double wall would better adapt it for cold climates. A single wall silo of

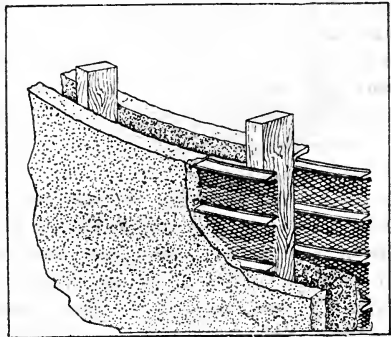

Fig. 34.—Showing double wall metal-lath silo.—Courtesy General Fireproofing Co., Youngstown.

A single wall silo of

this same type is built by replacing the studding with $\frac{3}{8}$ inch vertical rods to which every rib of the metal is firmly wired. In this way only one wall of the ribbed-steel is used and it is plastered on both sides to a total thickness of about $2\frac{1}{2}$ inches.

Cement Block Silos.

The cement block silo is sometimes preferable to other types. It will be found cheaper and easier to erect than the monolithic concrete silo and although perhaps not so strong as the solid wall, it is probably as good as any silo when properly constructed. The architectural effect is very pleasing, especially where the rough exterior is used. The blocks should be well made and plenty of reinforcement used. The reinforcement consists of steel bands or rods laid in the wall between the courses as in brick or stone construction. They should be entirely covered by mortar to protect them from rust.

Cement blocks are easily made at home or may be secured at numerous factories. In many cases the manufacturers will move out their forms, mixers and other utensils and make the blocks at the building site at less expense than for the monolith. This is because the work can be done with greater facility on the ground level than up in the air on scaffolding. With a little practice any mason can learn how to lay the blocks and follow specifications.

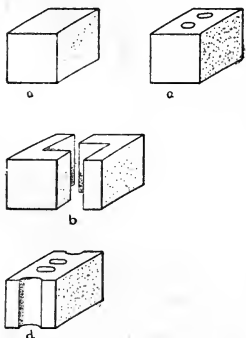

Fig. 35.—Type of concrete block which can be used in silo construction.

The Nebraska Agricultural Experiment Station Bulletin, No. 138, has the following regarding cement block silos: "There are three general types of blocks which can be used for silo construction, the solid block, the hollow block and the two-piece block. These blocks may have rough or smooth outsides and may be either curved or straight. The straight blocks, of course, will need to be plastered on the inside to produce a smooth surface to the silo.

"When cement blocks are made very fast, it is essential that the mixture of which the body of the block is made be quite dry. Concrete when used in this way is quite porous. If the face of the blocks can either be of a much richer mixture than the body of the block or be made of very wet concrete and troweled, a much better block for silo construction can be made. It is

preferable that the face of the block be both richer and wetter than the body of the block; also, if the face of the block be troweled it makes a block which will not absorb moisture. Whenever it is not possible to make or obtain blocks of this nature the inside of the silo should be plastered after the walls are laid. If the expense of plastering is too great, the walls can be washed or painted with a mixture of one part cement and one part fine screened sand. This will take the place of plastering as far as sealing the pores in the blocks is concerned, but does not leave the wall as smooth as plaster.

"The solid block, such as is shown by 'a,' Figure 35, is advisable only when a machine has to be made and one cannot be constructed which will make the hollow blocks. This solid block is more quickly made than the others, but requires more material, is heavier and harder to handle, and conducts heat and cold more readily."

The two-piece blocks such as shown by "b," Figure 35, are made to lay up in the silo wall so that the leg of one in the inside wall will overlap the leg of one in the outside wall but in the

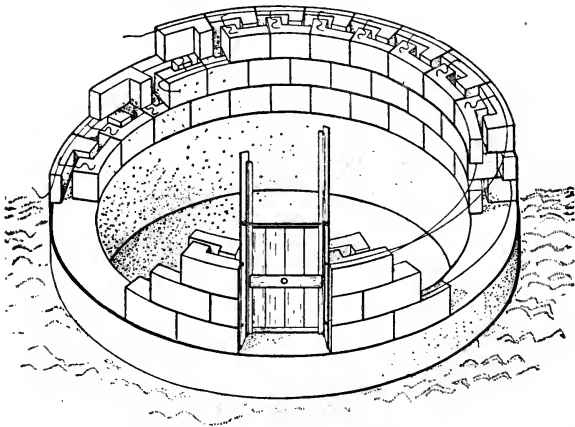

Fig. 36.—Showing how the two-piece cement block is laid in the wall and the door frame.

course above it. Figure 36 shows that these blocks make nearly a perfect dead-air space so that the silage is less apt to freeze, as heat will not be transferred back and forth through the walls as readily. Blocks made in the above manner can have a wetter and richer mixture in the face than in the back and the face can also be troweled.

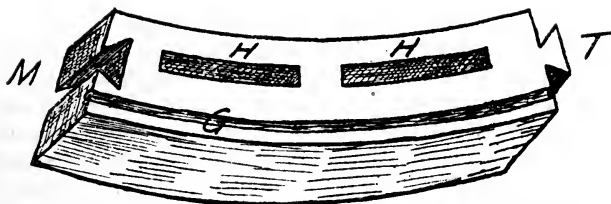

Fig. 37.—Illustrates a type of concrete block used in silo construction. H H are holes left in blocks. T and M are dove-tailed tenon and mortise so made that blocks interlock when laid on the wall. G is a groove made in block to imbed iron rod for reinforcing the wall.

—Courtesy Wisconsin Experiment Station.

The Nebraska Station has designed a special machine for making these two-piece blocks and also a machine which will make the single piece hollow block as shown in "c," Figure 35. This block cannot be made as fast as the two-piece block but is much easier to lay. It gives the troweled surface inside but not outside nor does it give as perfect a dead-air space.

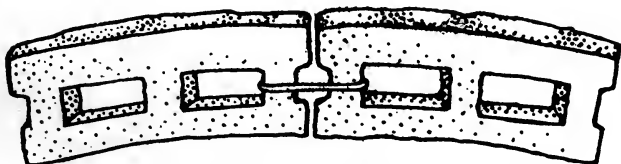

Fig. 38.—This form of block requires less material and does not freeze so readily as the solid block. Note manner of reinforcing by $\frac{3}{8}$ -in. iron binders.

Commercial blocks like "d" Figure 35 are very common. They may be either straight or curved to fit the curvature of the silo. Being generally very porous they should be plastered on the inside after being put into the wall. Curved blocks require less plaster but plaster must be used anyway and a straight block not exceeding 16 inches in length will make a good silo. The usual dimensions of curved blocks are 8x8x16 or 24 inches.

Cement blocks are usually made of finer materials than are the solid monolithic walls. The blocks are made of sand and cement; or if any gravel is used it is very fine gravel whereas, in the continuous wall monolithic construction, coarser gravel or

crushed stone is more commonly used. This is one of the reasons why the monolithic wall is stronger than the block wall.

Good block silos can be put up with home-made blocks and by home labor, but an experienced contractor is recommended, if convenient. No blocks that are cracked, broken or crumbly, should be used, and all blocks should have good water-resisting qualities. A small amount of water placed on the surface, if readily absorbed, indicates a poor block for silo purposes.

The Iowa Bulletin No. 141 says that "the practice of using wooden studs for the door frame in mortar at the ends of the blocks and at each side of the doorway and bolted to the steel frame cannot be criticised too severely. This stud is placed under conditions best adapted to cause rapid decay. Often it is so constructed that it cannot be replaced without much difficulty and thus the durability of the entire structure is impaired by the use of a single part." Fig. 39 illustrates a poured concrete door frame that avoids this difficulty.

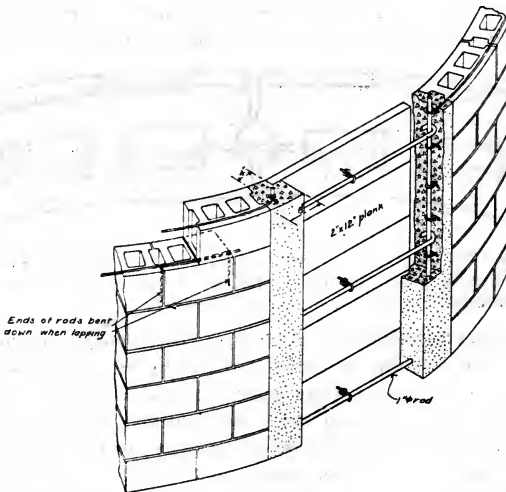

Fig. 39.—Continuous door opening for concrete block silo. View shows the manner of fastening reinforcing rods to the door frames, also of anchoring rods around a block instead of lapping.

—Courtesy Universal Portland Cement Co., Chicago.

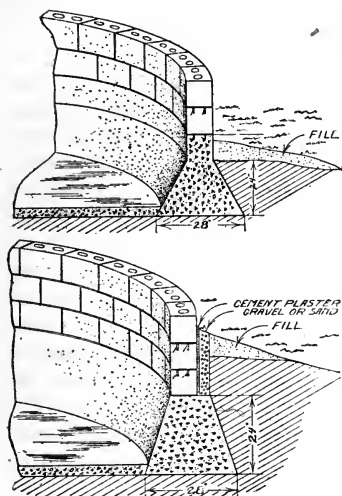

Fig. 40.—Two types of foundation for cement block silos.—Courtesy Nebraska Station.

The Roof.—Figure 41 illustrates the cornice work and forms for a concrete roof to correspond in permanence and fire-proof qualities with the remainder of the silo. A one-third pitch is recommended.

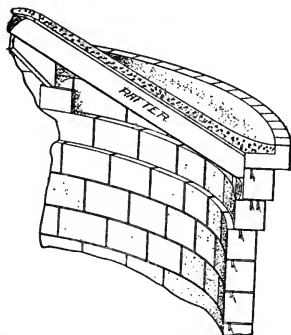

Fig. 41.—Illustrating how to build cornice for concrete roof on a concrete block silo.—Courtesy Nebraska Station.

Patented Reinforcements.—The weak point in any sectional block construction is in the joints between the blocks and the attempts to overcome this are demonstrated in many forms of patented reinforced cement blocks now being used for silo building. Where the blocks are made of a poured or gravity mixture, using the best quality of cement, sand and gravel obtainable, they are extremely dense and strong. One of these, known as the Hurst System, uses blocks 24x12x4 inches thick. Running laterally through each block are two $\frac{3}{8}$ inch round

Foundations. — Concrete block silos require heavier foundation footings than do clay block or wooden silos. They should not be less than 28 inches wide at the bottom and 2 feet deep. A mixture of one part cement, three parts sand, and six parts broken stone or coarse gravel will make a mixture for the footings and foundation walls.

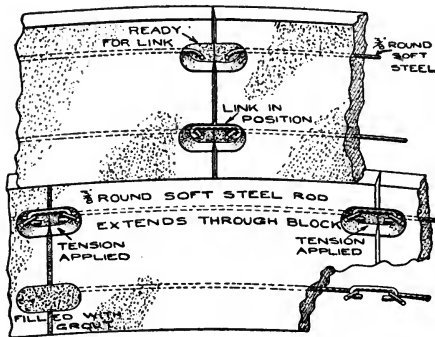

Fig. 42.—Showing one method of sectional block reinforcement.—Courtesy Hurst Silo Co., Chicago.

steel rods, the ends of which are turned up two inches in small recesses in each end of the block. When the blocks are laid into the silo wall, these turned ends and recesses match corresponding ones in the adjoining block, as shown in Fig. 42. A $\frac{3}{8}$ inch round steel link is then slipped over the two turned ends

which are afterwards bent back and drawn tight and the recess filled in with cement. This method of construction is said to be very powerful and to give excellent results.

Another method similar to the above, known as the Harvey system, uses reinforcing rods which are turned at right angles, one turned vertically hooking over the other turned laterally. Upright rods are imbedded in each block and fit between blocks of the course above. This permits the building of a double wall if desired, the two walls being tied together with steel strips running diagonally between the upright rods.

Cement Stave Silo.

The cement stave silo is built of concrete slabs or staves 30 inches long, about 10 inches wide and $2\frac{1}{2}$ inches thick. They have a curved interlocking edge and are built into a wall, forming a wall of thickness of the block and bound together with hoops on the outside. With good quality blocks, properly treated with a water-proof wash so as to be impervious, this type of silo is a success. It is claimed for them that all danger of cracking due to contraction and expansion is eliminated. For this reason although the steel hoops are not protected they need no adjustment when once set.

Vitrified Tile Silos.

Vitrified clay blocks have during the past few years commanded considerable attention for building purposes. The durability of this material is indicated in a quotation from Sir Charles Lyell's *Antiquity of Man*.

"Granite disintegrates and crumbles into particles of mica, quartz, and feldspar; marble soon moulders into dust or carbonate of lime, but hard, well burnt clay endures forever in the ancient landmarks of mankind."

It is not surprising therefore that vitrified tile or blocks are being used extensively for silo building. They have a hard, glass-like crockery surface, impervious alike to gas, moisture, acid or air; they withstand temperature fluctuations without contraction or expansion; they give the advantages of a double or triple wall with dead-air spaces; they are easily handled; and when properly reinforced against the bursting pressure of the silage they have no superior on the market.

Iowa Bulletin No. 141 states that "in clay blocks there are many grades of quality ranging from almost worthlessness to one of the highest quality of building material known. These variations in quality are due mainly to three causes, quality of raw material, method of burning, and defects in forming.

"Brick clays are made up principally of two classes of material, one that melts at temperatures usually secured in the hottest portions of the brick kilns, and one that remains firm at these same temperatures. Proper portions of each of these classes of material are essential. The former, called the fluxing material melts and binds together particles of the latter, while the latter preserves the desired form of the brick or block throughout the burning process. It will be readily seen that as the fluxing material fuses it will fill all of the space between the other particles, and upon extreme heating it flows out over the surface giving it a glassy appearance. This process is known as vitrification.

"In all kilns the blocks nearest the fire become burned harder than the other blocks and in any kiln only a portion of the blocks will be fit for silo construction. For this reason silo builders should not expect to secure such blocks at less than standard prices plus a reasonable price for sorting."

A variety of patented clay blocks and different methods of reinforcement are now in use. Many of these have special merits in the details. In general, the same methods of wire or steel bands are used as with cement block silos. A study of some of the patented blocks illustrated in Fig. 43 will bring

out many of the details of construction. A represents a block with curved recess at top and bottom for reinforcing rods and

a flange on each side of the block so that the bulk of the mortar is confined in the wide groove and only a very narrow strip exposed. B calls attention to the mitred groove at top and bottom for reinforcing rods to form a lock joint. The narrow apertures on each side of block form a tongue-and-groove mortar joint when laid in the wall. C and D illustrate the door jamb and regular blocks of another type. It will be noticed that D gives plenty of room on top for mortar and reinforcement. Still another type of silo is indicated by the blocks E, F, G, H and I. E and F are door jamb blocks. G is a glazed floor or paving block. H and I show two views of the regular wall block. J illustrates the cast iron door sill and K indicates the

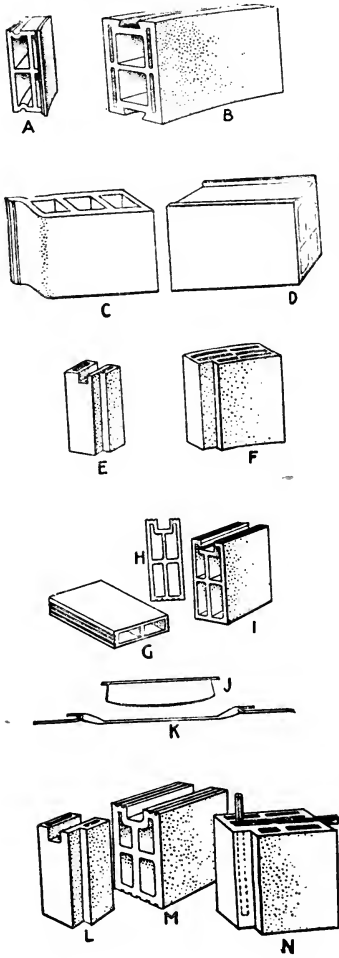

Fig. 43.—Group of Patented Clay Blocks of various manufacturers.

reinforcement across door opening. L, M, N and O, P, Q show two types of door jambs and regular blocks put out by another manufacturer. N indicates the vertical reinforcement next to the door around which the wall reinforcing steel is placed. The galvanized iron tie R for the door opening is shown in position on top of the block O.

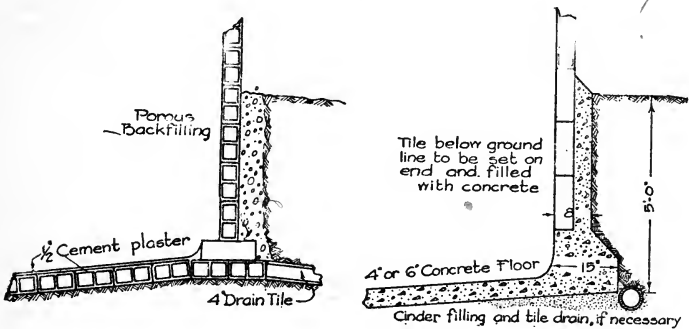

Fig. 44.—Showing two methods of preparing the foundation for clay block silos. (Courtesy Iowa Experiment Station.)

The Iowa silo is a hollow clay tile silo that was designed by the Agricultural Engineering section of the Iowa Station. It is very popular as it does not require special blocks. The Iowa Silo is simple in construction, durable, efficient and reasonably cheap where the tile can be obtained. It is built of regular clay hollow building blocks similar to those shown in the illustration of Figure 47. The tile are laid in cement mortar which contains just enough lime to make the mortar stick well (one part cement, one-third part lime, two to three parts sand). Number three

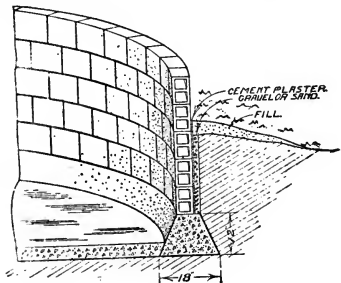

Fig. 46.—Clay block silo foundation. — (Nebraska Bulletin No. 138.)

wire is laid in for reinforcement, the amount of wire used being adjusted to meet the demands of the lateral pressure. The inside of the tile may be plastered or simply washed with a cement wash.

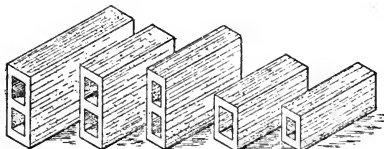

Fig. 47.—Five types of clay blocks which can be used for silo construction. "A" is 5"x8"x24"; "B" is 5"x8"x16"; "C" is 4"x8"x16"; "D" is 5"x5"x16"; and "E" is 4"x5"x16". (Cuts from Nebraska Bulletin No. 138.)

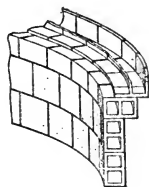

Fig. 48.—Silo cornice for clay block silo.

Figures 44, 46 and 48 illustrate methods of constructing the foundation and cornice for clay block silos.

Brick Silos.

In constructing a brick silo it will be well to guard the following points: Make the foundation of concrete and let the first course of brick come flush on the inside with the cement work. Bed a five-eighths inch iron hoop in the cement wall in the upper part before laying the brick, in order to keep the pressure of brick from spreading the wall before it becomes set and hard. Make a two-inch air space in the walls up to within one-third of the top. This will make a 14-inch wall of three courses of brick. The air space should be in the outer part of the wall. Iron tie rods should also be laid around in the wall between the doors, as recommended in the foundation. It is also important that the brick should be wet when laid, otherwise the mortar in which they are laid will be dried out too rapidly. The walls should be plastered over very smoothly with a coat of rich cement, one-fourth to one-half inch thick, and then every two or three years this should be well white-washed with thin cement, to keep the wall protected from the effects of acid in the silos. King recommends that the door

jambes be made of 3x6's or 3x8's, rabbetted two inches deep to receive the door on the inside. The center of the jambes outside should be grooved and a tongue inserted projecting three-fourths of an inch outward to set back into the mortar, and thus secure a thoroughly air-tight joint between wall and jamb. The doors may be made of two layers of matched flooring with tarred paper between, and lag screw bolted to the jamb, so as to give a perfect smooth face next to the silage.

Single Wall Brick Silo.—A 100 ton reinforced brick silo was built in 1909 by the West Virginia Experiment Station at Morgantown, and described in their Bulletin 129. The wall was laid up the width of a brick or 4 inches thick with 20d annealed wire nails imbedded in the cement mortar so that the ends projected from the wall about 2 inches into the silo. When the cement mortar had hardened, woven wire fencing was cut into pieces of proper length and fastened close to the inside of brick wall with the clinched nails. Two thicknesses of wire were used for lower half of silo and one thickness for upper half. Each strip lapped 2 inches over the one beneath. This wire was thoroughly covered with cement mortar of one part cement and three parts sand. Prof. Atwood writes (Aug., 1914) that the silo has given excellent satisfaction. He recommends, however, that the wire fencing should have perfectly straight horizontal wires, no coils, as the coils stand out from the brick work and necessitate more plastering. Many silos of this type have been constructed during the past two years, especially in the South.

All-Metal Silos.

The canned fruits and vegetables for our tables remain good indefinitely so long as air is absolutely excluded. The admission of air, in however slight degree, produces mold and rot, and destroys a very considerable part of the food value.

Where tests have been made, silos made of metal or lined with metal, have been found to most nearly approach the air-tight containers in which we buy our canned vegetables, and if these metal cans are good for our dainty table delicacies why are they not good for our "canned corn" known as silage?

The fact that over 2,000 metal silos are now in use in this

country and that their sales are rapidly increasing, is the best evidence of the entire satisfaction they have given.

Metal silos are not new. They have been in use in Australia for nearly 20 years. It is claimed for them that they are "wind-proof, fire-proof, crack-proof, shrinkage-proof, vermin-proof, expansion and contraction-proof, collapse-proof, repair-proof; there are no hoops to tighten, no anchors or guy wires to install; they are highly rust-resistant; they are absolutely non-porous, hence are moisture-tight and above all positively air-tight."

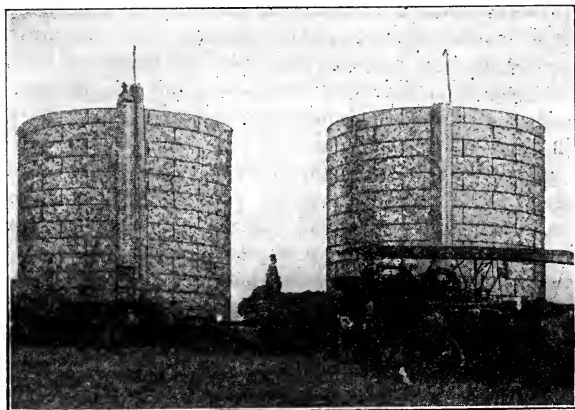

Fig. 45.—Two large Metal Silos and Ohio Cutter at Wagner Bros., Groom, Texas.—Courtesy Perfection Metal Silo Co., Topeka, Kansas.

The first commercial metal silo, erected in Iowa in 1907, is still giving very satisfactory service. "It was built of interchangeable sections, which were bolted together by means of flanges extending outwardly all around each section. This method of con-

struction forms a rigid reinforcement of the silo wall, and provides an easy and practical means of increasing the capacity of the silo at any time, by bolting on additional sections to the top. It also makes it practical to move the silo by taking the sections apart and re-erecting them in another location."

Mr. Charles P. Buck, writing for the Kansas State Board of Agriculture in 1914, says: "The metal silos are made air-tight by sealing the joints between the sections with a cement of an elastic nature, unaffected by moisture, cold or heat. The silo also is provided with a means by which the doors, through which the ensilage is thrown down into the feed boxes, are sealed absolutely air-tight, thus avoiding one serious cause of spoilage and loss.

"The two questions which usually arise regarding silos constructed of metal are regarding the action of the silage juices on the metal and the radiation of the heat of fermentation through the metal wall.

"Silage juice, after the fermentation, is slightly acid, containing minute quantities of acetic and lactic acids. It is customary to protect metal silos against the mild acids of this juice by painting the interior with an asphaltum paint, which forms a cheap, durable and reliable protection.

"The question of the effect of radiated heat loss during fermentation is best answered by the results obtained in the 2,000 or more metal silos now in use. In these it has been found that the silage next to the wall is as thoroughly fermented and as well preserved and palatable as that in the center of the silo. There probably is some heat lost by radiation, but there is apparently sufficient heat produced during the fermentation to supply all that is necessary despite the radiated loss.

"Practical use in the field has demonstrated that the metal silo has every good quality which has been desired in a silo. Once erected it is permanently air-tight and moisture-proof. The form of construction so reinforces it that it is secure against high winds, it requires practically no care or expense to maintain, and produces ensilage without mold or rot and consequent loss.

"Properly constructed metal silos need no guy wires, cables nor anchors. They are secured in a foundation of concrete in much the same way as are modern structural steel smokestacks of immense height.

"The leading manufacturers, have by careful experiments

found that it is possible to produce a metal that is fully resistant to the chemical action of the silage juices, which thus obviates the probability of any rust or corrosion of any kind.

"Properly constructed metal silos are so strong and rigid as to be readily insured against cyclones and wind storms. One leading manufacturer, in fact, provides purchasers with such insurance without cost. Metal silos are fireproof and are proof against lightning without the necessity of lightning rods.

"The original manufacturer has silos in use in nine different states, from Mexico to Minnesota, in all extremes of climatic conditions, and over a considerable period of years. As a result of the satisfactory experience, a great many types of metal silos have been devised, from those riveted up like a railroad water tank, various types of partly riveted and partly bolted sections, to those of interchangeable sections with various types of flanges. The type apparently most in favor, however, is that first brought out. Numbers of metal silos are in use as irrigation water tanks during the summer when empty of silage.

"Any question of the durability of metal silos has long since been completely answered by their continued use without apparent defects, rust or corrosion of any kind. Their use is rapidly growing in all sections of the country, East and West, and results are everywhere perfectly satisfactory."

Manufacturers furnish metal silos in uniform sized sheets or sections, finished complete ready to bolt into the silo. The sheets are interchangeably matching and are about two feet wide by $7\frac{1}{2}$ feet long. Different gauges of metal are used, some having a strength of 45,000 pounds to the square inch. Lighter material is used toward the top in proportion to the diminishing pressure exerted by the silage. Appurtenances such as doors, roofing sections, bar-iron, bolts, joint-cement, paint, etc., are usually boxed or crated.

Painting.—Metal silos should be painted once a year, long enough before filling to set well. The reason for this is given by one manufacturer as follows:

"In the production of silage certain mild acids are formed by fermentation, which, if no protection was offered would have a tendency to cause the metal to corrode. To provide against this, it is advisable to keep the inside of the silo painted with some elastic, acid-resisting paint. Such paints are put up by practically all of the best paint manufacturers. Any good paint, with an asphaltum or gilsonite base, that is prepared so that it will not dry too quickly, can be depended upon. We suggest asphaltum or gilsonite, because such paints are thoroughly satisfactory, and the cost is considerably less than that of some other kinds."

The Metal Silo Roof.—The roof adds greatly to the appearance of the metal silo and protects it against undue wind strain or vibration. In northern climates it acts as a protection against snow and freezing, and in warmer zones against the extreme heat of the sun which would cause considerable loss between feedings. It is an added expense, of course, and as rain is not injurious to silage the roof is considered superfluous in some sections of the Southwest. The permanent roof also prevents tramping or filling to the top of the silo, causing both spoilage and loss of capacity. Despite these objections, however, the majority of purchasers seem to prefer the roof.

Foundation.—Too much care cannot be taken in building the foundation of a metal silo. Solid ground is the first essential because the silo with its contents is very heavy. The foundation wall and floor should be of concrete of ordinary 1:2:4 proportions. The wall should be at least 12 inches thick and extend 6 inches below freezing point or about 3 feet in the ground—deep enough to prevent the frost from heaving the silo out of level and to prevent rats from digging under. The first row of metal sheets should be imbedded in the center of the wall at least 12 inches deep.

Freezing in Metal Silos.—In extremely cold climates silage

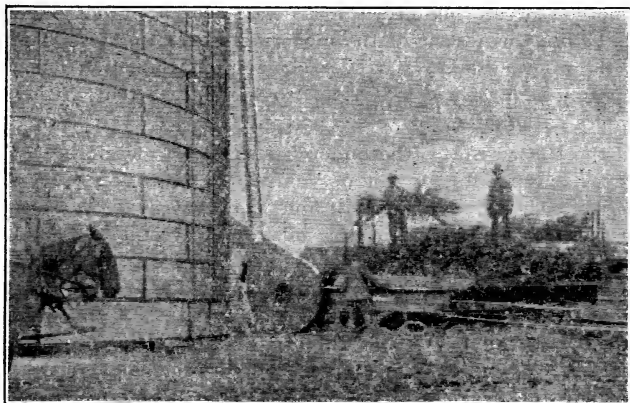

Fig. 49.—Large Metal Silo on Sunny Slope Farm, Emporia, Kas., being filled with Silver's Ohio No. 22 Cutter.

will sometimes freeze in any kind of silo, but it must be very severe and protracted cold weather to freeze silage very deeply because of its own generated heat. Metal silo manufacturers contend that while the so-called double—or hollow—wall silos are slower to freeze than some other types, they are also much slower to thaw; that unlike other silos, freezing and thawing has no injurious effects on the metal silo, or on its contents; that silage freezing to the sides of ordinary silos requires to be chipped away with danger of injury to the walls; whereas the sun beating against the metal walls for a few hours on the coldest winter day melts the silage loose; and that metal silos are giving satisfaction in northern territories where the thermometer hovers around 20 degrees below zero for weeks at a time.

Detailed directions regarding the building of foundations and the erecting of metal silos will be found in the catalogs of metal silo manufacturers, which should be secured by anyone interested in this type of silo.

Pit or Underground Silos.

Pit or underground silos date back to antiquity. For over fifty years they have been demonstrating their value in Europe, not only in preserving silage but in economy of construction. The pit method of storing green feeds had been followed for many years before the advent of the modern silo or silo filler. The fact that the above-ground silo ever since its introduction has made such rapid strides in comparison, would indicate that this type is far more satisfactory in actual use.

In the United States the underground silo is distinctly a Western type, having its highest degree of adaptability in those sections visited by sparse rain fall and where the water table is not near the earth's surface. These silos are therefore numerous in Texas, New Mexico, Oklahoma, Colorado and the Western parts of Kansas and Nebraska. Norton County alone in Kansas has over 100 pit silos. Some are in use in the semi-arid parts of South Dakota as well as in Illinois, Michigan and other states. They are NOT adapted to humid sections or to localities subject to regular and heavy rain fall.

The underground silo is generally considered a temporary expedient or makeshift and it seems to show up to best advantage

where but very few cattle are fed. That it is a makeshift, however, should not deter farmers from building such silos in case they can not see their way clear to erect a better silo. Even a cheap silo properly built serves a good purpose in demonstrating the value of the silo and in helping its owner to come into possession of better equipment and a silo more to his liking.

Analysis of comments in the farm press for the past two years reveals a number of advantages claimed for this type of silo. Among these advantages may be mentioned the following:

1. Little cash expenditure is required. Labor is the chief item. Where labor is exchanged there remains only the cost of cement and sand for plastering the walls and making the concrete collar around top.
2. It is easily constructed, requiring very little skilled or outside help.
3. The silage keeps perfectly if well packed. The temperature remains even winter and summer—no freezing or thawing.
4. It will resist tornado and fire. It cannot blow over or rot down.
5. Because inexpensive, two small deep silos may be built, keeping one for summer feeding or for use should crops fail entirely.
6. No expensive forms are required for building.
7. No trouble with ill-fitting doors, or with loose hoops, or cracks.
8. Anyone can make it who can dig a cistern.
9. A more inexpensive silage cutting equipment may be used, enabling each farmer to own his own machine so that it can stay on the job and refill as silage settles, thus securing utmost capacity at minimum cost.
10. The top surface is handy, where it can be tramped regularly the first few days.
11. When built in the right soil it will last just in proportion to how well it is constructed and cared for, bearing in mind the necessity of guarding against caving in, seepage, etc.

The most common objection to the pit silo is the inconvenience in getting the silage out of the hole, which would have to be deep enough to secure pressure for proper packing and keeping qualities, and should therefore be at least twice as deep as the diameter of the silo. Some kind of hoisting apparatus would be necessary. This would be too laborious and inconvenient unless operated by a gasoline engine or other power which would, of course, increase the expense.

The claim has been made that the extra cost of getting the silage out of an underground silo would be more than offset by the

saving effected in filling, but this hardly holds true, as with modern machinery it is little more expensive to fill a silo above ground than one below the surface.

The failure of the silage to thoroughly pack by its own weight is one of the principle draw-backs to the pit silo. This is on account of the lack of depth so much in evidence in structures of this kind.

Another objection to the silo is that poisonous gases are likely to accumulate in the bottom and render the silo dangerous to enter. Lowering a light would soon discover the presence of such carbon dioxide gas which if present would immediately put the light out. These gases are heavier than air and the air would have to be agitated to dispel them since there is no air drainage in an underground silo.

Again, unless the soil is dry and very hard or has excellent drainage there would be the danger of water seeping into the hole and thus spoiling the silage. The likelihood of caving in either while building or after the first silage crop was taken out would also have to be overcome.

Some of the essentials in building underground silos aside from firm dry soil are that they should have a curb or collar extending from below frost line to a few inches above ground; that they should be plastered from $\frac{3}{4}$ to 2 or 3 inches thick and washed with a cement coat to make them water- and air-tight, the walls being sprinkled lightly before plastering, if dry; that the walls should be smooth and perpendicular for even, solid settling; that a cover should be provided as a protection against children, animals or foreign matter and to insure free air circulation.

CHAPTER IV.

THE SUMMER SILO.

The summer silo is fast becoming popular and even necessary because of its splendid aid in supplementing summer pastures and tiding the herd over the period of drouth, heat and flies. Experiment stations that have studied the subject, strongly advocate its use and some of the leading agricultural papers have been speaking in no uncertain voice as to its advantages.

"The summer silo is as certain to assert its value as American agriculture is certain to go forward rather than backward," says Breeder's Gazette of Chicago. "Pasture as at present used—or abused—is a broken reed. An over-grazed acre is the costliest acre that the farmer supports. Even in normal seasons grass rests in the summer time, and unless a fall and winter pasture is laid by, little good is derived from grass lands after the flush of spring. The silo supplements pastures, and carries the burden of the winter's feeding."

Among dairymen who have used summer silage for many years, permanent pastures have been greatly reduced or even entirely dispensed with. A prominent Indiana dairyman recently remarked, "My dairy last year returned me approximately \$5,000 and yet I would go out of business if I had to give up the silo. I would have to reduce the herd 50 per cent. if the summer silo was not used." That statement is merely based on the fact that enough silage to keep a cow or steer during its pasture season can be grown on from one-fourth to one-third the area required to keep the same animal on pasture. Beef cattlemen are rapidly finding out about this "greater efficiency per acre of corn silage as compared with grass, and the similarity of the two feeds in their effect on cattle," and it leaves little room for doubt that "the silo will greatly reduce the pasture acreage required and will have a marked effect on beef production on high-priced land."

Following the same line of thought Purdue Experiment Station Bulletin No. 13 says:

Too much dependence is usually placed upon pasture for summer feeding. Pasturing high-priced land is unprofitable in these times. Few stop to consider the destructive effects of trampling,

that, while a cow is taking one bite of grass, she is perhaps soiling or trampling the life out of four others. If sufficient silage is put up each year part can well be used for summer feeding, which will be found less laborious than the daily hauling of green crops for the herd. The herd must not be allowed to shrink in flow unduly, as it is practically impossible to bring them back during the same lactation. The young stock, destined for future producers, must not be neglected on short pasture, for the labor and expense of supplying their needs as above indicated for the herd, is insignificant compared with the importance of their unimpaired growth."

The Indiana Station states that "The most rapid and most economical gains ever made by two-year-old cattle fed experimentally at this station were made by a load of 800-pound cattle fed from March 17 to July 15, 1910, on a ration of shelled corn, cottonseed meal, corn silage and clover hay. During this period the cattle ate an average daily feed of 14.61 pounds of corn, 2.24 pounds of cottonseed meal, 53.81 pounds of silage and 2.38 pounds of clover hay. They relished the silage as well in summer as in winter."

There are many intelligent farmers who are providing a succession of fresh soiling crops and using them to great advantage in helping out short pastures. "But," says Professor Frazer of the Illinois Station, "there is necessarily much labor attached to preparing the ground, planting, raising, and harvesting the common crops used for this purpose. There is usually much loss in being obliged to feed these crops before they are mature and after they are overripe. And for the farmer who can make the larger investment, the most practical way of all to provide green feed for summer drouth is to fill a small silo with corn silage. It not only saves the labor and inconvenience in the putting in and cultivation of small patches of different kinds of crops, but also in harvesting from day to day in a busy season of the year.

"These soiling crops can be dispensed with and all the feed raised from one planting in one field in the shape of corn. The whole field of corn for the silo may be cut at just the right stage of maturity when the most nutriment can be secured in the best possible condition of feeding. It also avoids the possibility of the soiling crops failing to ripen at the exact period when the drouth happens to strike the pasture. For the silo may be opened whenever the pasture fails, regardless of the date, and the silage will remain in the best condition as long as needed. When the pasture supplies enough feed again, what is left in the silo may be covered

over and thus preserved without waste, and added to when refilling the silo for winter use."

Oregon Bulletin No. 136 says that "the summer silo is growing in favor, and in many ways has advantages over the soiling system. As soiling is now practiced, a carefully planned rotation is necessary in order to have green feed always on hand. The acreage of each crop must necessarily be small, and frequent planting at intervals of from ten days to two weeks must be made. If a large field were planted and soiling started at the proper time to get the maximum yield of food constituents and the greatest palatability, the greater part of the crop would soon be beyond this stage, as only a small part would be cut each day. By putting the crop into the silo all could be cut at the proper stage of maturity, and all at the same time. This would do away with the daily chore of cutting small amounts."

The dry pastures and burned-up hillsides following the drouth of 1910 made a very strong impression as to the importance of having good summer feeding. It was an eloquent though severe plea for the summer silo and led to some splendid testimony in its favor. The drouth "cut down the milk flow in most of the herds nearly 50 per cent. Not one farmer in a hundred had provided for this emergency by a good supply of succulent food that would make milk. It is the same old story over again. It seems to take a tremendous lot of pounding on the part of Providence, to get it into farmers' heads that a summer silo is a grand thing," says Hoard's Dairyman. "Our herd of cows had 50 tons or more of nice corn silage to turn to when feed grew short and they have rolled out the milk nicely right along. Besides, they will keep at it. There is nothing like a supply of silage for summer use. It is close by and handy to the stable for use when you want it. And furthermore it will produce more milk than any other kind of soiling feed."

This is the experience of Wisconsin investigators, who find that silage holds milk-flow during drouth even better than soiling. It is rational that it should:

During the summers of 1910, 1911 and 1912 the comparative value of soiling crops and silage were thoroughly tested out at the Wisconsin Experiment Station. In these tests corn silage competed with such soiling crops as green corn, peas, oats and red

clover. The two systems were practically on an equal footing so far as influence on milk production was concerned, but the cost of producing and feeding soiling crops was higher than that for silage, due to the cost of seed and the great amount of labor involved. The silage yielded more and better food from the same area, was more uniformly palatable and there was less waste due to uncontrollable weather conditions. The experiment indicated that in case of scant pastures, dairymen would find it a matter of great convenience, saving and profit to feed corn silage in preference to soiling crops. The results of the above experiments were published in Wisconsin Bulletin No. 235.

The summer drouth is with us to stay, and we might as well prepare to meet the situation most intelligently. As a matter of fact, we have never known a single season in our practical experience to go through from end to end without a drouth, and even that in the best of what we might term our normal seasons. Major E. E. Critchfield, of Chicago, an agricultural expert, says that a good deal of effort has been made in various localities to carry over this particular season by soiling, but, he adds, we must remember that the man who does this is not in any sense prepared for soiling practice and it comes at a period when he is almost inordinately busy with other things and is, therefore, likely to fail of best results.

If, however, he has a summer silo, or a good "heel" left in his winter silo, he has in it a place of greatest convenience for feeding and it is most likely to produce the best possible results.

Night pasturing has been found to be a very valuable practice in connection with the summer silo. By running the cows into pasture at night they are absolutely undisturbed by flies and other insects, and by keeping them in a darkened yet well ventilated barn during the day and feeding them from the silo, every advantage of the pasture and absolute freedom from its annoyances is secured.

Another very valuable attribute of the summer silo is that it permits of saving crops in years of great plenty for other seasons of less plenitude. The desirability of this practice becomes evident when we recall how our mothers in years when fruit was very plentiful and cheap, used to put up a sufficient quantity to last for several years and we can hark back in our memories and tes-

tify as to the quality of the fruit and, therefore, the success of the practice. Now, since the siloing of green stock food is nothing more or less than a process of canning, it may be carried over several years without any deterring influences.

The renovation of the bluegrass pastures of Middle Tennessee and other Southern bluegrass communities is another wide field of usefulness to which the summer silo in the South may profitably be put. That the native bluegrass areas of this section have been abused is plainly evident, says a bulletin recently issued by the N. C. & St. Louis Railway. "Much of the pasture lands of Middle Tennessee which once lay in vast stretches of perfect bluegrass sod has been brought by continuous grazing to a comparatively low state of yielding capacity. Like all other plants, and animals, bluegrass has the disposition to lose vitality in the process of reproduction, and if grazed, even lightly, during the period of propagation, serious injury is the result. Instead of reproducing itself through the agency of its own seed, as is popularly supposed, bluegrass propagates its kind chiefly at the root. With the appearance of the first warm sun rays of early spring, long lateral jointed rootlets are sent out from the parent root, from which spring little shoots which appear on the surface of the soil as new grass. If grazed during this process, the act of reproduction is arrested and the old plant itself permanently injured. In order to renew and maintain a perfect sod on the bluegrass lands of the South, the process of reproduction must be allowed to operate undisturbed by removing all stock from the pastures for six weeks or two months early in the spring. This period of rest should extend from February 1 to 15 to April 1. One ton of silage per head of either dairy or beef stock reserved from the winter supply, or a small silo filled and retained for that purpose, would enable the Southern bluegrass pasture owner to transform his meager producing lands into a perfect sod with but little extra expense."

The substance of a strong editorial in Wallace's Farmer, while referring particularly to the lesson of the 1910 drouth, applies with equal force wherever pasture is used or cattle are fed. It is worth quoting here:

"The question we are constantly asked is: 'Will silage keep through the summer?' We are glad to be able to give a direct answer to this, not theoretically, but from personal experience. We built a silo on one of the Wallace farms and filled it in 1908,

and made the mistake of building it too large. During the winter of 1908-9 the silage was not all used. Last fall we put in new silage on top of the old, and during the winter used out of the new silage, leaving the unused remainder in the bottom. We are now feeding that silage, and the man in charge, an experienced dairyman, tells us that after the waste on top was removed, this two-year-old silage is as good as any he ever used; that the cattle eat it as readily as anything and eat more of it than they did during the winter.

"This is in entire harmony with every farmer we ever heard of who uses summer silage. If silage will keep two years without any waste except on the exposed portion of the surface, then it will certainly keep one.

"Some people say: 'We may not have another summer like this.' To this we reply that a period of short pastures during July and August is the rule in all the corn belt states, and lush grass at this season of the year is a rare exception. Remember that seasons come in cycles of unknown duration, and the time of their coming is uncertain; that it always has been so, and it is safe to assume that they always will until the Creator sees fit to change his method of watering the earth. Therefore, well-made silage in a good silo is just as staple as old wheat in the mill. There will be a waste of several inches on the surface, just as there is waste of several inches on the surface of the hay stack or shock of corn fodder; but a man can afford that waste, if he has the assurance that his cows will not fail in their milk or his cattle lose flesh, even if there should be little or no rain for thirty or sixty days. When you put up a silo for summer use, you are going into a perfectly safe proposition, provided, of course, you build it right, and fill it properly."

This editorial is in line with further evidence which comes from the Purdue Station. Prof. Skinner writes:

"Many successful farmers with limited areas of pasture make a practice of filling a small silo for summer use. It has been well established that silage properly stored in a good silo when the corn or other crop is in the most desirable condition, will keep in good condition for several years. Many foresighted men taking advantage of this fact plan to have silage on hand the year round. They are thus prepared for any unusual conditions such as drouth, scant pasture, excessively long winters, and it is altogether practical and profitable. It is desirable to have a silo of relatively small diameter for summer feeding as it is necessary to feed considerable amount from off the top of the silage each day in order to keep it from moulding during the hot, damp weather.

"There are three silos on the university farm and it is our aim to avoid having all these empty at the same time. A limited farm, greatly overstocked, makes it necessary to supplement the pastures every year, and while soiling crops are grown in abundance they cannot be relied upon because of the gravelly nature of the

sub-soil underlying the farm, which means longer or shorter periods of drouth annually.

"It would be absolutely impossible to maintain the number of animals on the college farm that we are successfully carrying without the silage to supplement our pastures and soiling crops. Many Indiana men have come to look on the silo as quite as important in supplementing the pastures as it is in furnishing succulence during the winter season."

It is well to remember that less silage will naturally be fed in summer than in winter and that on the exposed surface molding is liable to set in more quickly. In order to keep the surface in fairly good condition, at least three inches of silage should be taken off daily, where two inches suffice in the winter. Where the size of herd permits, some farmers plan to feed off as much as five or six inches daily in summer. Feeding at the rate of 30 pounds per head daily and removing silage to a depth of two inches from the surface means only about four square feet of surface needed for each head per day. A silo for 20 cows should therefore not exceed ten feet in diameter. It will be found advisable in building the summer silo to keep the diameter as small as is practicable. The higher the silo the more firmly the corn is packed and the better it will keep.

Silage soon dries out or spoils in hot weather when exposed, but not so soon where it is finely cut and well packed, because this more nearly excludes the air, thus reducing the amount necessary to be removed daily. By having the cutting knives sharp and set to cut $\frac{1}{2}$ -inch lengths the exclusion of air is so nearly complete that very little more silage needs to be removed in summer than in winter. If possible silage in summer should be fed in the shade because the hot sun acts very quickly and dries out and sometimes spoils the silage before the cattle eat it.

CHAPTER V.

THE USE OF SILAGE IN BEEF PRODUCTION.

The day has passed to question the usefulness of the silo to the cattle feeder. Further experiments will simply emphasize its necessity. Millions of dollars could be added to the profits of the land-owners and beef-raisers of this country by heeding the teachings of the numerous experiments already made.

Experiments at several stations during the past four or five years have proved beyond question the value and economy of corn silage in the ration for fattening steers. Silage-fed steers have repeatedly made the heaviest and cheapest gains, have attained the highest finish during the feeding period, and have brought more money on the market. Numerous extensive trials have shown that the very best and cheapest dry rations have failed to equal a good silage ration, properly balanced, either in amount or cheapness of gains.

Until recent years the dairy industry apparently held the monopoly on the profitable use of this succulent feed. It is refreshing to note the awakening among cattle feeders to its wonderful advantages in beef production. The "discovery" of the use and value of silage for beef making is, however, not new as many suppose. It was tested out by Prof. Thomas Shaw at the Ontario Agricultural College fully 25 years ago and the experience of many Canadian beef growers has for 20 years backed up the facts that good beef could be made from corn silage alone and meal, that it could be made more cheaply than on other feeds, and that corn stover was intended to be first a food and then a fertilizer, rather than merely a fertilizer.

The beef producing area of the United States will be vastly increased by the use of the silo. Now that the Kansas Agricultural College has shown that kafir and sorghum are fully equal to corn for silage, even the dry land sections of the southwest are put on a beef-fattening basis. This means that over one hundred and fifty million acres are added to the area that can profitably produce finished beef cattle. This is a significant fact when it is considered that the growing scarcity and the consequent high prices of beef in late years has been such as to admit of foreign

competition. "There was a time," says Breeder's Gazette, "when meats were produced as cheaply in the United States as anywhere. That condition no longer exists. To produce meats in the United States costs more money now than to produce them in South America, New Zealand, or Australia. Probably meat production even in Great Britain is less costly than with us."

The situation is clearly stated by H. M. Cottrell, Agricultural Commissioner of the Rock Island Lines, as follows:

"An adequate supply of beef for the United States can be secured only by the stockmen throughout the country adopting silage as the basis of their feed rations both while growing cattle and while fattening them. The cost of making beef with grain and dry forage is greater than the majority of the consumers can pay for it and farmers find it more profitable to sell grain than to feed it. A careful feeding test showed that taking a steer from birth to three years of age when he was marketed fat, it required 38 pounds of feed for each pound of gain. An average of a large number of feeding tests in many states showed that with dry feeds 10 pounds of grain and 5 pounds of hay were required for each pound of gain made while fattening beef animals. Grain is worth at least one cent a pound and hay is worth half a cent. Figure for yourself the cost of making beef with dry feeds.

"Silage saves a large proportion of grain needed in fattening animals. It saves the need for any grain while cattle are growing. Silage fed cattle gain faster than those on dry feed. They finish quicker and the meat is better marbled. Cattle fed silage while fattening require 30 per cent less grain to make each 100 pounds of increase in weight than do cattle fed under the best methods of dry feeding. Silage makes 50 per cent saving of grain over ordinary methods of feeding. On high priced land, silage is of special advantage, as it nearly doubles the carrying capacity of the land.

"Forty per cent of the feed value of a corn plant is in the stalk and 60 per cent in the ear. The stalks that grow on nearly ninety-five million acres of land are wasted annually in this country and the feed value of the stalks on nearly eight million acres are but partially utilized each year. This annual waste amounts to practically a billion dollars, the greatest economic waste in any one line of business in the world. Silos could convert all this wasted material into one of the best beef producing feeds.

"Under the ordinary way of roughing beef cattle through the winter a herd averages 200 pounds less in weight per head in the spring than it did in the fall. It costs considerable even with these methods to carry stock cattle through the winter and every one loses in value. Stock cattle fed silage and a little dry forage will gain 100 pounds a head through the winter and increase in value. There are about 37,000,000 beef cattle in the United States. More

than half of them are roughed through. Silage-feeding would make a difference of 300 pounds of edible beef every winter on each of these."

Men at the various stock yards are now strong boosters for the silo and claim that it is a big factor in replenishing the cattle supply. During the past two or three years, the use of silage has become general throughout almost the entire Southwest. The results have been that the cattle now go through the winter in excellent condition and develop good flesh with a limited supply of grain, cotton seed meal and cake. Cattlemen of the Southwest say that the silo has solved the problem of winter feed and put the old range country in a position to get both the breeders' and the feeders' profit from cattle. During the past few years silage-fed cattle have topped the market repeatedly with record prices and it is no longer necessary to conceal their identity at the market to evade discrimination. Indeed the discrimination, if any, now leans the other way. This weighty kind of "fact-evidence" which affects the pocket-book, has served as a strong weapon to dispel the prejudice that formerly existed against silage in feeding circles.

Before proceeding to mention a number of important feeding trials that have helped to bring about this condition, we wish to quote a short article from Farmers' Bulletin 556 of the United States Department of Agriculture as follows:

"Silage stands first in rank of all the roughages for finishing cattle. Formerly, during the era of cheap corn and other concentrates little attention was given to the roughage, as it was usually considered merely a 'filler' and of very little economic value in feeding. No especial care was taken in selecting any particular kind, nor was the quality of it seriously considered. As the prices of the concentrated feedstuffs advanced, the feeder looked about for methods of cheapening the cost of producing beef and soon found this could be accomplished by using judgment in selecting his roughage with respect to the grain fed. This has continued until at the present time the roughage receives as much attention as the concentrated feed, and has been made to take the place of a large amount of the latter. The feeding of silage came into general use with the advent of expensive grain and is becoming more popular each year. With the present prices of feedstuffs there is hardly a ration used for feeding cattle which cannot be cheapened by the use of this succulent feed. By combining it with other feeds the efficiency of the ration is increased to such an extent that the amount of the daily gains is invariably greater and the

cost of producing a pound of gain is lessened. The heaviest daily gains are usually made during the first stage of the feeding period, and silage can then be used to advantage in large quantities with a small amount of grain, but as the feeding progresses the amount of silage should be lessened and the grain increased. In some places the price of hay and stover is so high that the greater the proportion of silage used in the ration the more profitable is the feeding.

"Silage is a quick finishing roughage in that it produces large daily gains and produces a glossy coat and a soft, pliable skin. Moreover, it can be used to advantage at times for carrying cattle for a longer time so as to pass over a period of depression in the market, or to carry the cattle along in thrifty condition so they can be finished at a later period."

When we consider the varied conditions under which the experiments of the Agricultural Stations and others have been made, it is surprising to find the results so similar and all pointing to the one conclusion.

The **Nebraska Station** finds in Bulletin 132 that corn silage made larger and more profitable gains with steers than did corn stover, used one-third less grain, and produced better finished steers, which were worth more per hundred.

A summary of results at the **Pennsylvania Station**—Bulletin 124—shows that net profits during the 1912-13 cattle feeding tests, not including pork, ranged from \$11.22 per head for steers fed silage and hay, to \$14.09 per head for steers fed corn silage as a sole roughage. Corn silage at \$3.50 a ton proved much cheaper as a sole roughage than when fed with hay valued at \$12.00 a ton. This Station realized a value of \$6.20 a ton for silage when used for steer feeding.

The **Missouri Station** found in a steer feeding experiment, where corn silage was compared with hay that they could make a saving of \$1.07 per hundred pounds of beef by using silage.

Bulletin 169 of the **South Carolina Experiment Station** gives results that are of much value to cattle feeders, not only in the South, but in practically all parts of the country. In this test comparing silage, corn stover and cotton seed hulls, the corn silage gave by far the best returns, not only in feeding profits, but in the quality of the beef and the shape in which it reached the market. The silage fed group produced gains even on a poor market that would warrant an earning on the silage of \$6.86 per ton.

Results at the **North Carolina Station** given in Bulletin 222 show that "Beef cattle fed on corn silage as the roughage portion of the feed in conjunction with cotton seed meal will not only use the meal more economically during a continuous feeding period, but they will finish in better condition and command a higher price than cattle fed on dry roughage. In all of the lots where corn silage was fed as a whole or a part of the roughage, the daily gains were more uniform throughout the feeding period than the gains made by the lot fed cotton-seed hulls."

Prof. H. P. Rusk of the **Illinois Experiment Station**, says that "one of the most common mistakes in the use of silage is attempting to make it take the place of part or all of the concentrates in the ration.

"Corn silage is a roughage and not a concentrate. Its profitable utilization in the finishing ration depends not so much upon its nutritive value as on its cheapness, its palatability and succulent nature, the steer's ability to consume large quantities of it, and the possibility of utilizing the entire corn plant, a large portion of which would otherwise be wasted.

"Used in its proper combination with other feeds, corn silage is one of the most economical roughages available in the corn belt. However, it should be remembered that corn silage, like corn itself, is low in protein and must be fed in combination with some highly nitrogenous feed in order to offset this deficiency. This fact was demonstrated in the early studies made on silage at the Purdue experiment station when a ration of shelled corn, clover hay and corn silage was fed in comparison with a similar ration to which cotton seed meal was added in sufficient quantities to balance the nutrients. The lot receiving cotton-seed meal made an average daily gain of 2.7 pounds during the 150-day feeding period while the lot that did not receive cottonseed meal made an average daily gain of only 1.8 pounds. The cost of gains was \$9.11 per cwt., where cottonseed meal was fed as compared to \$11.07 per cwt. in the lot to which it was not fed. A noteworthy fact shown in the results of this experiment is that the addition of 2.6 pounds of cottonseed meal to the daily ration did not decrease the steer's capacity for other feeds. In fact, the steers receiving the balanced ration consumed a little over four pounds of feed more per head daily than those not receiving cottonseed meal. This effect is one that is commonly noted when rations lacking in protein are balanced with some highly nitrogenous concentrate, or even when the common non-leguminous roughages in such rations are replaced by clover or alfalfa hay.

"Where liberal allowances of corn silage are used, a leguminous roughage such as clover hay or alfalfa hay cannot be relied upon to furnish sufficient protein. The only way to properly balance such a ration is to add some nitrogenous concentrate such as cot-

tionsed meal or linseed oil meal. This fact is demonstrated by the results of a feeding trial conducted at the Illinois experiment station during the winter of 1910-1911. In this experiment each of three lots of two-year-old steers received a full feed of broken ear corn and corn silage; in addition one lot was fed all the alfalfa hay it would clean up, another lot clover hay, and third lot was fed enough cottonseed meal to balance the ration. The lot receiving corn, alfalfa hay and silage made an average daily gain of 2.35 pounds; the lot fed corn, clover hay and silage made an average daily gain of 2.09 pounds; while the lot receiving cottonseed meal in the place of a leguminous roughage made a gain of 2.59 pounds per head daily and returned a larger profit than either of the other lots.

"Aside from failure to properly balance the ration, probably the most common mistake in feeding silage to fattening cattle is the practice of beginning with a small amount of silage and gradually increasing as the feeding period advances. This is just the reverse of the method that should be followed."

At the Indiana Station, the 175 day feeding trials conducted from Nov. 20, 1913 to May 14, 1914, rendered strong evidence in favor of feeding corn silage and cheap roughage. Seven lots of 10 grade Shorthorns each, were fed various combinations of shelled corn, soybean meal, cottonseed meal, oat straw, clover and alfalfa hay—with and without silage. The test showed little difference in the feeding value of soybean meal and cottonseed meal, either in finish or profits.

The most profitable lot of steers received shelled corn, cottonseed meal, silage and oat straw. Including pork, the profit per steer was \$12.94; without pork, \$4.94. This lot not only made the most profit, but also made the fastest gains, the average daily gain per steer being 2.54 pounds for the six months.

Excluding pork, three lots lost money. Two of these, Lots 2 and 3, did not receive silage. The other lot received silage, but the cost of gains was greatly increased by the consumption of about \$54.00 worth of alfalfa hay.

This experiment confirmed previous findings at both the Indiana and Illinois Stations regarding the economy of silage, and the profitable use of oat straw or other cheap roughage, when fed in connection with corn, cottonseed meal and silage, instead of such costly roughages as alfalfa or clover hay. The oat straw was found to give as good results as clover hay.

For several years the silage-fed cattle at the Indiana Station

have finished out better than those not receiving silage. This again held true in this test. The only difference in the rations of Lots 2 and 4 was the addition of silage to the latter. Lot 4 not only finished better and sold for 10 cents per cwt. more, but including pork, made \$4.22 more profit per head than the steers that had no silage. Not including pork, the profit per head was \$7.58 in favor of silage.

Two experiments in feeding corn silage to steers were conducted at the **South Dakota Experiment Station** at Brookings in 1912, running three and four months respectively. The results showed that neither corn fodder from the field, nor fodder silage, nor a one-half ration of silage and hay proved as valuable for wintering steers as first class corn silage (fodders cut from same field, at same time as corn for silage), as it required more pounds of dry matter for a pound of gain with these than with silage lot.

Hay with silage proved to be better than hay or silage alone as a roughage. No bad results were received by feeding steers all the corn silage they would eat without other grain or roughage. At the end of the experiment they were consuming an average of 70 pounds per head daily.

Further tests were conducted at the same station for 146 days in 1912-13 to determine the relative feeding value of oil meal, cottonseed meal and dried distilled grains when fed with corn silage as the sole roughage. The largest and most uniform gains were made with oil meal and silage. The cost of producing 100 pounds of gain in these tests was as follows: With corn silage and oil meal, \$5.86; with corn silage and cottonseed meal, \$6.64; with corn silage and dried distilled grains, \$5.50; with corn silage and oats, \$6.68; with corn silage and shelled corn, \$8.22. It will be seen that the distilled grains ration made a cheaper gain than the oil meal ration, but the cheap gain is not always the best gain as the steers receiving oil meal were in better condition than the other lot. The average gains per head daily for the 146 days were 2.45 for oil meal and 2.17 for distilled grains. Silage was valued at \$4.00 a ton; oil meal and cottonseed meal at \$32.00 a ton, dried distilled grains at \$24.00 a ton, oats and shelled corn at 1 cent a pound. Prof. Wilson, who conducted the test, says that the experiment calls attention "to the value of corn silage when properly supplemented with high protein feed. I believe when we feed our corn crop in the form of silage, we will be able to make beef at a profit under almost any conditions likely to present themselves. The old custom of stocking cattle through the winter will soon be a practice of the past."

Supt. T. J. Harrison, of the **Experimental Farm, Indian Head, Saskatchewan**, writes: "Last season (1913) we conducted feeding experiments in which ensilage was fed in comparison with

mixed hay. The steers fed on the ensilage made a gain of 2.5 pounds a day, while the lot fed mixed hay gained about 1.9. The silage-fed steers when sold also brought about 15 cents per cwt. more than the hay-fed steers, because of the fact that they were better finished."

The Kansas Experiment Station in May, 1913, concluded the most important feeding demonstrations that have been made for some years, in order to determine the comparative feeding value of silage made from corn, kafir and cane or sweet sorghum. The trials were made with both beef and dairy cattle and showed with both that, pound for pound, the silage from all three crops had practically the same feeding value. These demonstrations not only benefit Kansas, but indicate that feeders may make kafir and cane silage the foundation feeds for fattening beef cattle throughout the entire Southwest.

The test with beef cattle was made with Hereford calves, ten in each lot. Below is the record:

Ration—	Corn	Kafir	Sorghum
	Silage. Lot 1	Silage. Lot 2	Silage. Lot 3
Original value.....	\$ 7.80	\$ 7.80	\$ 7.80
Value of the lot.....	325.40	321.65	333.90
Original weight.....	4,172 lbs.	4,124 lbs.	4,281 lbs.
Feed Consumed:			
Corn silage.....	27,431 lbs.
Kafir silage	30,865 lbs.
Sweet sorghum silage....	30,855 lbs.
Cottonseed meal.....	927 lbs.	927 lbs.	927 lbs.
Details:			
Final weight.....	5,700 lbs.	5,751 lbs.	5,865 lbs.
Total gain.....	1,528 lbs.	1,627 lbs.	1,584 lbs.
Average daily gain.....	1½ lbs.	1.62 lbs.	1.58 lbs.
Cost of feed.....	\$ 55.05	\$ 54.96	\$ 54.94
Daily cost by head.....	0.055	0.0549	0.0549
Cost of gain.....	3.60	3.37	3.46
Value, hundredweight....	7.50	7.60	7.50
Final value by lot.....	427.50	437.07	439.87
Profit by the lot.....	47.05	60.46	51.03

It will be seen that kafir silage made 28 per cent more profit than corn silage, and sweet sorghum silage made 8 per cent more than corn silage. Corn silage has usually produced better gains than either kafir or sorghum silage, due to the acidity and lack of

feeding value heretofore connected with the latter. The Kansas tests showed plainly that these drawbacks have been due to the cutting of the kafir and sorghum when too immature. These crops for the above feeding tests were cut three weeks later than corn. The seeds were practically mature, but the stalks were green and filled with sap. Professors Reed and Fitch report that at all times during the test, the silage from cane contained less acid than the silage from corn.

In the dairy test, which also covered two years, it was found that corn silage as a milk producer was only slightly superior to kafir silage with cane silage a close third. Cows gave daily per head one-sixth of a pound more milk on corn silage than on kafir silage and gained slightly more in weight on the kafir silage. Corn silage produced an average daily yield of one-half pound per cow more than cane silage. These differences are so small that they show the feeds to be practically equal. The choice of crop to plant depends upon the probable yield per acre. Kafir and cane being drouth-resistant crops can be grown over a wider territory than corn and they produce from one-third to one-half more tonnage to the acre, so that each acre of kafir or cane would yield considerably more milk than an acre of corn silage. The cane silage was found superior to either kafir or corn silage for gain in live weight, due to more carbo-hydrates and sugar, or fattening nutrients. All the silage was of good quality and the cows ate it with relish. The cane silage seemed most palatable. Cement and stave silos were used with no difference in results as to quality.

Prof. O. E. Reed, who made the dairy tests, says that "the time of cutting cane and kafir for silage is all-important in making good silage from these crops. The crops should be practically mature; that is the seed should be mature. At this time the stalk is still filled with sap and will make good silage. If put up too green, it will make sour silage. The crops should be put up before frost if possible, but it is better to let the crop stand until after frost than to put it up too green. After a heavy frost, the crop should be cut and siloed immediately. If it dries out too much, sufficient water should be added to cause it to pack well."

The Iowa Experiment Station in Circular No. 6 gives the following results of feeding corn silage for fattening cattle. The experiments were in charge of Prof. Eppard.

"Corn silage should be put into the feeding program of every Iowa beef producer if he wants to fatten cattle economically and efficiently. That corn silage is our most profitable cattle roughage

has been clearly demonstrated at the Experiment Station as well as upon hundreds of Iowa farms.

The addition of corn silage to the ration not only decreases very materially the cost of gains, but usually makes them more rapidly. The steers are finished more quickly and ordinarily sell for a higher price than where clover is used as the roughage.

Fattening cattle of all ages utilize silage as their roughage ration. It is as good for the calf and yearling as for the two and three year old. All profit from its use.

Silage is practically one-third to two-fifths as valuable as clover hay for beef production. Silage at \$3.20 a ton and clover hay at \$7.66 a ton were equally efficient in fattening two-year-old steers in 1911-12 in our station tests. Ordinarily when clover is selling from \$10 to \$15 per ton, silage is worth from \$3.50 to \$6.00.

That the corn grain which is put into the silo is not wasted our feeding records clearly show. Cattle receiving silage do not eat as much grain as hay fed cattle, the decrease being approximately equal to the amount of corn found in the silage.

For a short feed, silage is pre-eminently our most abundant and efficient roughage. The gains are not only more rapid than where clover or alfalfa is fed, but are made more cheaply. Furthermore, the selling price is markedly enhanced. Actual experiment has shown that as compared to clover in a ninety-day feed, silage cattle, rightly fed, will sell from ten to seventy-five cents higher per hundred weight.

For a long feed silage is quite efficient, producing, as compared to clover, both cheaper gains and a higher quality of finish.

Protein supplements must be fed with silage in order to make it an efficient fattening food. Cattle cannot be fattened economically on corn and corn silage. It is imperative and absolutely essential that protein concentrates such as cottonseed meal, cold pressed cottonseed cake, linseed oil meal or similar feeds be fed.

The average daily silage, hay and grain consumption of a two-year-old steer weighing 1,000 pounds at the start, during a five-month full feeding period will approximate:

- Shelled corn, 13 to 16 pounds;
- Cottonseed meal or linseed meal, 2.7 to 3.6 pounds;
- Clover or alfalfa hay, 3 to 5 pounds;
- Corn silage, 22 to 35 pounds.

With silage as lone roughage the consumption will be about 28 to 35 pounds. It requires practically one and three-quarters to two and three quarters tons of corn silage for a five months' feed for a two year old.

In the absence of any dry roughage such as clover, alfalfa or oat straw, corn silage may be used as the lone roughage. Some dry corn stover should be utilized if possible. In case of lone silage feeding, however, one had best increase the protein concentrates slightly.

In what quantities throughout the feeding period shall we feed silage? Our experience clearly shows that silage should be fed very heavily in the early part of the feeding period to insure most efficient results. The grain at this time may be somewhat limited. We put our steers upon a full feed of good quality silage the very first day and have never had any difficulty. Silage is a roughage and may be so handled without danger. To insure quick and economical finishing, the silage is best decreased somewhat at the close of the feeding period and the grain increased accordingly. Cattle, when nearly finished, tend to eat too much of the bulky, watery, palatable silage, thus leaving too little room for concentrated grains, a consumption of which is highly imperative at this time.

The shrinkage of silage fed cattle is not heavy as is ordinarily supposed. Silage fed cattle do not shrink any more than dry hay fed ones. Our results clearly indicate that cattle receiving both silage and dry roughage during the feeding period, shrink less than those fed on either dry feed or silage alone."

The Texas Station has conducted two experiments recently in which the value of cotton seed meal and silage was tested for fattening cattle. The results of these experiments, and those obtained by other Stations and commercial feeders along the same lines, indicate this combination to be one of the most profitable rations that can be used for feeding cattle in Texas.

The first experiment covered a period of 119 days during the winter of 1911-12. 40 head of range-bred three- and four-year old, grade Shorthorn and Hereford steers were used. The silage fed was about 75 per cent. Milo Maize, 15 per cent. Indian corn, and 10 per cent. sorghum. During the last 20 days of the test the percentage of Indian corn was increased. The test showed that a ration of cotton seed meal and silage may be used far more profitably than a ration of cotton seed meal and cotton seed hulls for fattening cattle. Silage was a much cheaper feed than cotton seed hulls and yielded slightly larger gains. The silage fed steers showed considerably better finish and brought 20c a hundred-weight more on the market than the hulls-fed steers. The net profit on the silage-fed steers was \$10.40 a head and the net profit on the hulls-fed steers was 67c a head.

The second experiment, during the winter of 1912-13 lasted 159 days. 28 head of well graded steers were used, divided into four lots. A summary of results showed that the ration of cotton seed meal and silage was considerably more profitable than either the ration of cotton seed meal and hulls or the one of cotton seed meal, hulls and silage. It was found that 1 2-3 tons of silage was equivalent to one ton of cotton seed hulls in feeding value. Silage realized a value of \$8.16 a ton. Cotton seed meal at \$27.00 per ton was more profitable than cotton seed at \$17.00 a ton in supplementing the silage to form a fattening ration. The shrinkage in shipment to market was much greater in the hulls-fed lots than in the lots fed silage as roughage. During the first 107 days of

the test the silage was about 90 per cent. sorghum and 10 per cent. cow-peas. During the remaining 32 days, it was composed of Indian corn. This test was based on the following values per ton: Cotton seed meal, \$27.00; cotton seed hulls, \$7.00; cotton seed, \$17.00; silage, \$2.50.

At the Amarillo Sub-Station in Texas a test was made to compare cotton seed meal and grass with cotton seed meal and silage. The silage steers made 400% better gains.

Mr. Henry H. Johnson uses 15 silos of 200 to 250 tons each for fattening annually about 4,000 steers on his 25,000 acre ranch in Oklahoma. Mr. Johnson says, "No farmer, large or small, can afford to be without a silo. It is the only way to feed cattle at a minimum cost. Any other way will cost a man from eight to ten dollars a head more. Silage increases the flow of milk at least half and young cattle will make faster growth on silage than on any other kind of feed."

A battery of four monolithic silos—the largest in the West—was built in 1912, on the 14,000 acre beef ranch of Horace Adams, Maple Hill, Kan. Each was 20x60 feet. They hold 500 tons each and cost \$3,300, and are to store feed for producing fine beef cattle.

The South abounds in just the protein feeds that are needed to properly supplement silage. Cowpeas, soybeans, peas, vetch, red clover, lespedeza, oil meal, cotton seed meal, gluten feed, clover, alfalfa, wheat, bran or oats are all good. The South has splendid natural conditions for stock raising. Regarding the value of silage, Prof. Andrew M. Soule of the **Georgia Agricultural College** says:

"For more than fifteen years I have either conducted personally or supervised experiments on the wintering of beef cattle with silage as the principal form of roughness. In that time it has proved to be cheapest and most efficient coarse feed available for use in the south. Cattle fed on silage for a period of 134 days made an average gain in the stable of 1.06 pounds, those fed hay and grain a gain of .27 pounds, those fed stover and grain .08 pounds, those fed silage and grain made a gain of 1.22 pounds. These cattle were allowed to run on grass for 81 days. The average daily gain for the silage and grain cattle for both the stable and the grass period was 1.36 pounds, the stover and grain cattle 1.19 pounds, the hay and grain cattle 1.13 pounds. The most economic gains from stable feeding were made by the silage and grain fed cattle.

Under good management a grain ration as low as 2 pounds per day will make substantial gains in the winter and maintain good gains on grass. Three pounds of grain combined in the proportion of two pounds of corn and one of cottonseed meal will make an excellent grain ration."

CHAPTER VI.

THE SILAGE SYSTEM HELPS MAINTAIN SOIL FERTILITY.

When the cattle feeders of this country once thoroughly realize that they can profitably feed and raise stock by means of the silage system the great problem of maintaining and increasing soil fertility will very largely solve itself and exhausted soils will recuperate of their own accord.

This statement is based on certain fundamental facts, which Farmer's Bulletin No. 180 covers briefly as follows:

"When subjected to proper chemical tests or processes every substance found on our globe no matter whether it belongs to the mineral, vegetable or animal kingdom may be reduced to single elements, of which we now know over seventy. Many of these elements occur but rarely, and others are present everywhere in abundance. United mostly in comparatively simple combinations of less than half a dozen each, these elements make up rocks, soils, crops, animals, the atmosphere, water, etc. The crops in their growth take some of the elements from the soil in which they grow and others from the air. Many elements are of no value to crops; a few, viz., 13 or 14, are, on the other hand, absolutely necessary to the growth of plants; if one or more of these essential elements are lacking or present in insufficient quantities in the soil, the plant cannot make a normal growth, no matter in what quantities the others may occur, and the yields obtained will be decreased as a result."

The problem of the conservation of soil fertility is therefore largely one of maintaining a readily available supply of the essential plant elements in the soil. Most of these elements occur in abundance in all soils, and there are really only about three of them that the farmer need seriously consider—nitrogen, phosphoric acid and potash. Of these, the latter two are mineral compounds which are very often lacking in the soil in sufficient quantity to give profitable crops and they must therefore be supplied in the form of manures or fertilizers. The nitrogen is partly obtained from the air by leguminous crops, but the supply from this source is limited and the proper enrichment of the soil often demands the addition of this compound.

Every time that a crop is grown it robs the soil of a valuable portion of these fertilizing elements. A ton of clover hay, for instance, contains 41.4 pounds of nitrogen, 7.6 pounds of phosphorus and 44 pounds of potash. These elements form the basis of the market value of commercial fertilizers and because of the enormous quantity of fertilizer now used they each have a definite and fairly stable market value. For our purposes in this discussion we place these values as follows: 18 cents a pound for nitrogen, 5 cents a pound for phosphoric acid and 5 cents a pound for potash. It should be remembered that these values are likely to differ to some extent in various localities according as they are affected by the item of transportation. At the present time, because of the European War, it is hard to estimate the value that should be placed on these elements, as the sources of most of our nitrogen and potash are very largely controlled by the warring nations, and for this reason our values will be found very conservative and even very low. But taking one year with another and reaching over a period of years it is fair to assume that the prices of 18, 5 and 5 cents a pound respectively will be found approximately correct. Now, figured on this basis, it will be found that each ton of clover hay takes from the soil \$10.23 worth of fertility. A 100-bushel corn crop contains 148 pounds of nitrogen, 23 pounds of phosphoric acid and 71 pounds of potash valued at \$51.34. In other words, that much fertility is removed from the soil with every 100-bushel corn crop. In the same manner, the fertility in a ton of wheat has a value of \$9.79; a ton of wheat bran, \$14.06; a ton of alfalfa hay, \$10.07; a ton of timothy \$5.97 and a ton of oats, \$8.85. Other crops vary in proportion.

The above figures may be startling to some who have been growing and selling these crops. The question may come up, do these figures actually mean that we can get returns of \$14.06 by the application of one ton of wheat bran to our land as a fertilizer? Such is not their meaning, however. They do mean that if a farmer seeks to restore to the soil the same amount of fertility as was extracted by his 100-bushel corn crop, such fertilizer would cost him on the market not less than the amount stated above, viz.: \$51.34. The same relative values obtain with the other crops mentioned.

It is clear, therefore, that unless these elements are put back into the soil in some way, it will produce steadily declining crops

and eventually will become exhausted or mined out. How to put them back at the least expense is the problem confronting many sections of this country today, and it is not alone for the benefit of future generations; it has a vital bearing on our own crop yields.

The soil is the farmer's bank and the fertility of that soil is his capital. Many a farmer finding it impossible to "break na-

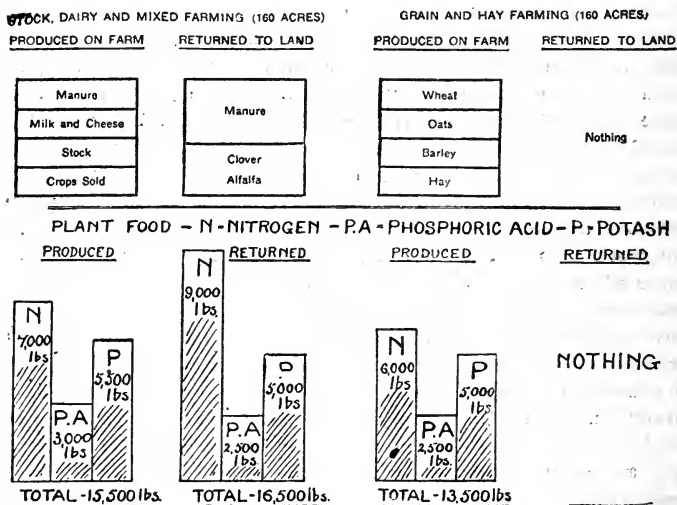

Fig. 50.—Comparison of years' results of grain and hay farming vs. stock, dairy and mixed farming.—Courtesy Family Herald and Weekly Star, Montreal.

ture's bank" has practiced farming methods that have meant a continual draining, year after year, of his capital—fertility—failing the while to understand the constantly smaller yields of the particular crops grown. This is the usual result of exclusive grain and hay farming and is graphically shown in the accompanying chart, Fig. 50. The chart also illustrates the results of stock, dairy and mixed farming, where most of the crops are grown for stock and manufactured into finished products such as milk, cheese and beef, and where the fertility is returned to the

land by means of manure and the legumes. It will be observed that where this latter system is practiced the nitrogen in the soil is actually increased, whereas the phosphoric acid and potash are reduced to a very small extent.

The startling effect of continuous crop farming is shown by an experiment covering 30 years at the Illinois Experiment Station:

"At this station the yield on a typical prairie soil has decreased under continuous corn raising from 70 bushels to the acre to 27 bushels to the acre during this period, while under a system of crop rotation and proper fertilization the yield on a portion of the same field has been increased during the same period to 96 bushels per acre. These yields are not of a certain year, but averages of three-year periods. The 96 bushels was obtained in a three-year rotation in which corn was followed by oats in which clover was sown. The next year clover alone, followed by corn again. Stable manure with commercial fertilizers was applied to the clover ground to be plowed under for corn. The difference in the yields obtained between the rotation system where fertility was applied and the straight corn cropping without fertility was 69 bushels per acre, or over two-and-a-half times that of the system of continuous corn raising. A large proportion of this difference in yield is clear profit, as the actual expense of producing the 96 bushels to the acre was but little more than in growing the 27. If the results of these two yields were figured down to a nicety, and the value of the land determined by the net income, it would be found that the well farmed acres would be worth an enormous price as compared with a gift of the land that produced the smaller yield."

Henry says that "with sharp competition confronting every one who cultivates the soil, the careful saving of farm manures and their judicious application are vital factors in farming operations, and as essential to continued success as plowing the land or planting the crop. * * * When one must choose between commercial fertilizers and barn-yard manures, it is reasonable to estimate that the latter have a value of at least two-thirds the former, based on their nitrogen, phosphoric acid and potash contents." These manures benefit the soil because the vegetable matter they contain acts as a mulch and forms humus, but so far

as feeding the plants is concerned their worth rests upon the elements of fertility they contain.

It will, therefore, be seen that barn-yard manure has a high value as a fertilizer. It is perhaps the most important for soil improvement. The reason for this is that it supplies nitrogen, phosphorus and potash and the decaying organic matter needed. In feeding oats, corn, wheat or other crops to animals, it is well to know that about three-quarters of the phosphorus and nitrogen and practically all of the potash go through the body and are returned in the solid and liquid manure. It is evident that the value of richness of the manure depends largely on the crops or part of the crops fed to the animals. That which originates from the use of concentrated feeding stuffs usually has a high value. That which comes from the use of straw or other coarse forage has a lower value. Leguminous crops are rich in nitrogen and phosphorus. Three tons of white clover will contain 8 pounds more phosphoric acid and 17 pounds more nitrogen than a 100 bushel corn crop, i. e., 31 pounds phosphoric acid and 165 pounds nitrogen. Any system of farming where grain is sold and only stalks and straw retained for feed produces manure weak in both nitrogen and phosphorus. These elements are divided in the corn plant on the 100-bushel basis, about as follows:

100 lbs. nitrogen in grain and 48 lbs. in the stalk.

17 lbs. phosphorus in grain and 6 lbs. in the stalk.

19 lbs. potassium in grain and 52 lbs. in the stalk.

In other words, two-thirds of the nitrogen, three-fourths of the phosphorus and one-fourth of the potassium are in the grain or seed and one-third of the nitrogen, one-fourth of the phosphorus and three-fourths of the potassium are in the stalk or straw. In siloing the corn plant the full value of the fertilizer, in both stalk and grain, is obtained in the manure.

The value of manure depends very largely on the way in which it is handled. Over half the value is in the liquid portion.

Experiments were conducted at the Ohio Experiment Station with two lots of steers for six months to ascertain the loss through seepage. An earth floor was used for one lot and a cement floor for the other lot. Manure was weighed and analyzed at the beginning and end of the experiments and it was found that that produced on the earth floor had lost enough fertilizer through

seepage during the experiments to have paid half the cost of cementing the floor.

Losses through weathering and leaching are also common and should be avoided. Experiments at the same station, during 12 years show that fresh manure produced increase in crop yields over yard manure amounting to about one-fourth of the total value of the manure.

Roberts, compiling data from various sources, gives the value of manure produced under average conditions by a horse as \$24.06 a year and that of a cow as \$32.25 a year, or \$2.49 and \$2.43 a ton respectively. This value is surely high enough to justify reasonable protection and care.

Nitrogen is manure's most valuable element measured by the cost of replacing it in commercial fertilizer. It heats when lying in heaps and the strong ammonia odor, due to the combination of the nitrogen in the manure and the hydrogen of the moisture of the heap, indicates that in time all the nitrogen will escape in the form of ammonia gas. It is said that a ton of manure contains about 10 pounds of nitrogen, worth \$1.50 or \$2.00, so that this loss of nitrogen is a serious one.

An average dairy cow of 1,000 pounds weight, properly fed, will throw off \$13.00 worth of nitrogen and potash a year in her urine. A horse will throw off \$18.00 worth. Urine has a greater fertilizing value than manure, and together they become ideal.

Every farmer can have his own manure factory by keeping live stock. Naturally, the more live stock the farm can keep, the more manure he will have for returning to the soil.

The silo here comes in as a material aid, and with its adoption it is possible to keep at least twice as much live stock on a given area of land. Pasturing cattle is becoming too expensive a method. High priced lands can be used to better advantage by growing the feeding crop and siloing it, without any waste, to be preserved and fed fresh and green the year around. This method, as we have said, will insure the maximum supply of splendid fertilizing material.

But the silo does more—it converts the farm into a factory as it were—i. e., it will become a creator of a finished or more nearly finished product instead of being the producer of a mere

raw material. The effect will be to raise proportionately the price of every commodity offered for sale.

"On the ordinary farm which markets cereal crops only a part is ever sufficiently fertile to return a profit. The other acres must be put by to regain fertility and are so much dead capital while they are made ready for a further effort. Not so with a farm devoted to beef as the market crop. Every acre of it may be seen producing year after year in an increasing ratio, and occasional crops such as potatoes—which while they need a rich soil for their development yet draw but lightly on fertility and are very useful as cleaning crops—will yield bumper profits in cash."

This statement applies with full force to what is another very desirable attribute of the silo and the silage system—that it will so increase the live stock of the farm that many of the products heretofore sold in a raw state, and which contain, and therefore carry away most of the fertility of the farm, may now be fed at home.

A few examples will best serve to illustrate this statement:

The fertilizing constituents in a ton of clover hay, as above stated, amount nominally to \$10.23. This would mean then that every time the farmer sells a ton of clover hay, he sells \$10.23 worth of fertility. So much fertility has gone from the farm forever. It would most certainly be wise to feed the clover at home as a balance to the silage ration, thereby keeping the fertility on the farm, and making at the same time some finished product, as cream, milk, butter, cheese or beef, the sale of which will not carry away from the farm any great amount of fertility.

The sale of a ton of butter, which is perhaps the best example of a finished or manufactured product from the farm, contains but 27 cents' worth of fertility. Why then is it not the part of wisdom to feed the clover hay, which contains as above noted, \$10.23 in fertility; alfalfa hay, \$10.07; timothy hay, \$5.97; corn, \$31.34; and oats \$8.85 and convert the whole into a finished product—as butter, which when sold takes away with it but 27 cents in fertility for each ton? Or if more desirable, why not convert these crops into beef, every 100 pounds of which when shipped from the farm carries away fertility to the extent of only 51 cents?

Restoring Fertility in the South.

In the Southern states the productive capacity of the farm lands has been materially reduced because of the continued drain upon their native fertility without adequate replacement. This loss is recognized by practically all agricultural observers. A parallel fact is that up to 1900 the production of live stock in the south also showed a steady decrease. Statistics from the Federal census show that with the opening up of the great cattle ranges of the West and the consequent cheap beef, the southern producer could not compete on his relatively high priced land. During the 50 years preceding 1900, Texas cattle for instance increased from 330,114 to 7,279,935 while Tennessee cattle decreased in the same period from 750,762 to 676,183. Since 1900, the great Texas ranges have been largely broken up and occupied by a farming population with the result that in 1910 the Texas cattle supply showed a 15% decrease since 1900, whereas the Tennessee cattle showed a 23% increase. This condition obtained generally in the South as compared with the West.

Now because the Southern producer could not compete with the Western ranges, he was forced into the growing of cotton, grain, hay and such other crops as he could readily dispose of on the market at the greatest profit—a system that naturally resulted in taking from the soil a great deal of fertility and putting little or nothing back into the soil in return. The fact that the future beef supply of this nation must come from the general farm, introduces “the most potent reasons why the Southern farmer should make immediate preparation to engage more extensively in the production of beef to meet the strong demand that is now being made and that will continue to be made upon the farms of the country. The silo is the logical source of cheap food supply on the high priced lands of the South, and is qualified as well to meet the crippled feeding situation, occasioned in many communities by careless methods of cultivation, and on such lands of poorer quality as will not justify the application of sufficient fertilizers to produce paying crops. The silo increases the stock carrying capacity of the pasture, and with its common adoption and use by the farmers of the South will come more live stock on the Southern farm, and in that respect no modern farm institution promises to become a more important and help-

ful factor in building up the soils of the agricultural communities of this vast region."

In summing up the foregoing chapter therefore, it will be generally conceded that the cheapest and most effective method of building up the soil and maintaining it in a good state of fertility is to follow a good rotation, grow plenty of legumes and apply the barnyard manure to the land. Their value in building up the soil is one of the strongest reasons for keeping live stock. The grain and roughage is fed on the farm and the stock give it back to the land in fertilizer. The farmer who hauls his grain and hay to market must obtain fertilizer from some other source and this is often costly. Now, if the keeping of live stock is a good thing for the farm, any system that permits double or triple the number of live stock to be kept on the same acreage is naturally much better. **THE SILAGE SYSTEM DOES JUST THAT.**

CHAPTER VII.

SILAGE CROPS.

Indian Corn.—Indian Corn is, as has already been stated, the main silage crop in this country, and is likely to always remain so. Before explaining the filling of the silo and the making of silage, it will be well, therefore, to state briefly the main conditions which govern the production of a large crop of corn for the silo, and to examine which varieties of corn are best adapted for silage making.

Soils best adapted to corn culture and preparation of land.—The soils best adapted to the culture of Indian corn are well-drained medium soils, loams or sandy loams, in a good state of fertility. Corn will give best results coming after clover. The preparation of the land for growing corn is the same whether ear corn or forage is the object. Fall plowing is practiced by many successful corn growers. The seed is planted on carefully prepared ground at such a time as convenient and advisable. Other things being equal, the earlier the planting the better, after the danger of frost is ordinarily over. "The early crop may fail, but the late crop is almost sure to fail." After planting, the soil should be kept pulverized and thoroughly cultivated. Shallow cultivation will ordinarily give better results than deep cultivation, as the former method suffices to destroy the weeds and to preserve the soil moisture, which are the essential points sought in cultivating crops. The cultivation should be no more frequent than is necessary for the complete eradication of weeds. It has been found that the yield of corn may be decreased by too frequent, as well as by insufficient cultivation. The general rule may be given to cultivate as often, but no oftener, than is necessary to kill the weeds, or keep the soil pulverized.

The cultivator may be started to advantage as soon as the young plants break through the surface, and the soil kept stirred and weeds destroyed, until cultivation is no longer practicable.

Varieties of corn for the silo.—The best corn for the silo, in any locality, is that variety which will be reasonably sure to mature before frost, and which produces a large amount of foliage and

ears. The best varieties for the New England States are the Leaming, Sanford, and Flint corn; for the Middle States, Leaming, White and Yellow Dent; in the Central and Western States, the Leaming, Sanford, Flint and White Dent will be apt to give the best results, while in the South, the Southern Horse Tooth, Mosby Prolific and other large dent corns are preferred.

For Canada, Rennie gives, as the varieties best adapted for the silo: for Northern Ontario, North Dakota and Compton's Early Flint; for Central Ontario, larger and heavier yielding varieties may be grown, viz., Mammoth Cuban and Wisconsin Earliest White Dent. It is useless to grow a variety for silage which will not be in a firm dough state by the time the first frosts are likely to appear.

Conditions from coast to coast are so varied that it is impossible to assign particular varieties as best adapted to certain localities. Specific information on this point can be obtained from the Agricultural Experiment Station of practically every state or province in the United States and Canada.

In the early stages of siloing corn in this country, the effort was to obtain an immense yield of fodder per acre, no matter whether the corn ripened or not. Large yields were doubtless often obtained with these big varieties, although it is uncertain that the actual yields ever came up to the claims made. Bailey's Mammoth Ensilage Corn, "if planted upon good corn land, in good condition, well matured, with proper cultivation," was guaranteed to produce from forty to seventy-five tons of green fodder to the acre, "just right for ensilage." We now know that the immense Southern varieties of corn, when grown to an immature stage, as must necessarily be the case in Northern States, may contain less than ten per cent. of dry matter, the rest (more than nine-tenths of the total weight) being made up of water. This is certainly a remarkable fact, when we remember that skim milk, even when obtained by the separator process will contain nearly ten per cent. of solid matter.

In speaking of corn intended to be cut for forage at an immature stage, Prof. Robertson, of Canada, said at a Wisconsin Farmers' Institute, "Fodder corn sowed broadcast, does not meet the needs of milking cows. Such a fodder is mainly a device of a thoughtless farmer to fool his cows into believing that they have

been fed, when they have only been filled up." The same applies with equal strength to the use of large, immature Southern varieties of fodder, or for the silo, in Northern States.

In comparative variety tests with corn in the North, Southern varieties have usually been found to furnish larger quantities per acre of both green fodder and total dry matter in the fodder than the smaller Northern varieties. As an average of seven culture trials, Professor Jordan thus obtained the following results at the Maine Station.

Table IX.—Comparative Yields of Southern Corn and Maine Field Corn Grown in Maine, 1888-1893.

	SOUTHERN CORN.					MAINE FIELD CORN.				
	Green Fodder.	Dry Substance.		Digestible Matter.		Green Fodder.	Dry Substance.		Digestible Matter.	
		Per Cent.	Lbs.	Per Cent.	Lbs.		Per Cent.	Lbs.	Per Cent.	Lbs.
Maximum..	46,340	16.58	6,237	69	3,923	29,400	25.43	7,064	78	4,945
Minimum..	26,295	12.30	3,234	61	2,102	14,212	13.55	2,415	70	1,715
Average....	34,761	14.50	5,036	65	3,251	22,269	18.75	4,224	72	3,076

The average percentage digestibility of the dry substance is 65 per cent. for the Southern corn, and 72 per cent. for the Maine field corn, all the results obtained for the former varieties being lower than those obtained for the latter. While the general result for the five years, so far as the yield of digestible matter is concerned, is slightly in favor of the Southern varieties, the fact should not be lost sight of that an average of 6¼ tons more of material has annually to be handled over several times, in case of these varieties of corn, in order to gain 175 pounds more of digestible matter per acre; we therefore conclude that the smaller, less watery, variety of corn really proved the more profitable.

At other Northern stations similar results, or results more favorable to the Northern varieties, have been obtained, showing that the modern practice of growing only such corn for the silo as will mature in the particular locality of each farmer, is borne out by the results of careful culture tests.

Time of cutting corn for the silo.—In order to determine at what stage of growth corn had better be cut when intended for the silo, it is necessary to ascertain the amount of food materials which the corn plant contains at the different stages, and the proportion of different ingredients at each stage. From careful and exhaustive studies of the changes occurring in the composition of the corn plant, which have been conducted both in this country and abroad, we know that as corn approaches maturity the nitrogenous or flesh-forming substances decrease in **proportion** to the other components, while the non-nitrogenous components, especially starch (see Glossary), increase very markedly; this increase continues until the crop is nearly mature, so long as the leaves are still green. Several experiment stations have made investigations in regard to this point. As an illustration we give in Table X data obtained by Prof. Ladd, in an investigation in which fodder corn was cut and analyzed at five different stages of growth, from full tasseling to maturity.

Table X.—Chemical Changes in the Corn Crop.

YIELD PER ACRE	Tas- seled, July 30	Silked, Aug. 9	Milk, Aug. 21	Glazed, Sept. 7	Ripe, Sept. 23
	Pounds.	Pounds.	Pounds.	Pounds.	Pounds.
Gross Weight.....	18045	25745	32600	32295	28460
Water in the Crop.....	16426	22666	27957	25093	20542
Dry Matter.....	2619	3078	4643	7202	7918
Ash	138.9	201.3	232.2	302.5	364.2
Crude Protein.....	239.8	436.8	478.7	643.9	677.8
Fiber	514.2	872.9	1262.0	2755.9	1734.0
Nitrogen-free Extract (starch, sugar, etc.).....	653.9	1399.3	2441.3	3239.8	4827.6
Crude Fat	72.2	167.8	228.9	260.0	314.3

The data given above show how rapidly the yield of food materials increases with the advancing age of the corn, and also that increase during the later stages of growth comes largely on the nitrogen-fed extract (starch, sugar, etc.).

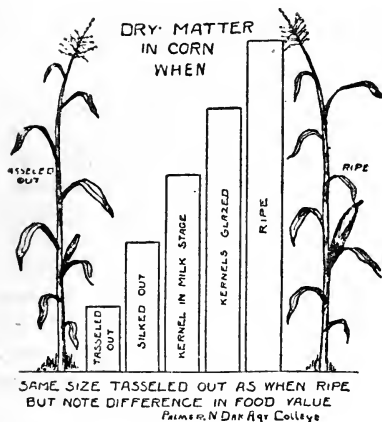

This difference in food value from the time the corn is tasseled out until it is ripe is illustrated in the accompanying chart, Fig. 51, by Prof. Palmer of the North Dakota Agricultural College.

The results as to this point obtained at several experiment stations have been summarized and are given in the Table XI, showing the increase in food ingredients during the stages previous to maturity.

Fig. 51.

Table XI.—Increase in Food Ingredients from Tasseling to Maturity.

EXPERIMENT STATION	Variety	Stage of Maturity		Gain in per cent. between first and last cutting			
		First Cutting	Last Cutting	Dry Matter	Crude Protein	Crude Fat	Carbo-Hydr's
Cornell, N. Y.	Pride of the North	Bloom	Mature	150	90	129	169
Cornell, N. Y.	Pride of the North	Bloom	Nearly mature	217	134	374	300
Geneva, N. Y.	King Philip.....	Tasseled.....	Mature	389	183	335	462
New Hampshire....	Av. of 4 varieties.	Tasseled.....	Glazed.....	112	50	84	130
Pennsylvania.....	Av. of 10 varieties.	Tasseled.....	Mature	155
Vermont.....	Av. of 2 varieties.	Tasseled.....	Glazed.....	122	50
Vermont.....	Av. of 2 varieties.	Bloom	Glazed.....	204	81
Average of all trials				193	98	230	265

We thus find that the largest amount of food materials in the corn crop is not obtained until the corn is well ripened. When a corn plant has reached its total growth in height it has, as shown by results given in the last table, attained only one-third to one-half of the weight of dry matter it will gain if left to maturity; hence we see the wisdom of postponing cutting the corn for the silo, as in general for forage purposes until rather late in the season, when it can be done without danger of frost.

The table given in the preceding, and our discussion so far, have taken into account only the total, and not the digestible components of the corn.

It has been found through careful digestion trials that older plants are somewhat less digestible than young plants. There is, however, no such difference in the digestibility of the total dry matter or its components as is found in the total quantities obtained from plants at the different stages of growth, and the total yields of digestible matter in the corn will therefore be greater at maturity, or directly before this time, than at any earlier stage of growth. Hence we find that the general practice of cutting corn for the silo at the time when the corn is in the roasting-ear stage, when the kernels have become rather firm, and are dented or beginning to glaze, is good science and in accord with our best knowledge on the subject.

Other reasons why cutting at a late period of growth is preferable in siloing corn are found in the fact that the quality of the silage made from such corn is much better than that obtained from green immature corn, and in the fact that the sugar is most abundant in the corn plant in the early stages of ear development, but the loss of non-nitrogenous components in the silo falls first of all on the sugar, hence it is the best policy to postpone cutting until the grain is full-sized and the sugar has largely been changed to starch.

It does not do, however, as related under Uniformity in the first chapter to delay the cutting so long that the corn plant becomes too dry, for the reason stated. Silage does not spoil when too wet, but will mold if too dry. Experience will be the best guide, but the foregoing pages should enable the reader to form the right idea as to time for filling, which to secure the best results is nearly as important as to have material with which to fill the silo.

Methods of Planting Corn.—When the corn crop is intended for the silo, it should be planted somewhat closer than is ordinarily the case when the production of a large crop of ear corn is the primary object sought. Thin seeding favors the development of well-developed, strong plants, but not the production of a large amount of green forage. The number of plants which can be brought to perfect development on a certain piece of land depends

upon the state of fertility of the land, the character of the season, especially whether it is a wet or dry season, as well as other factors, hence no absolute rule can be given as to the best thickness of planting corn for the silo. Numerous experiments conducted in different parts of the country have shown, however, that the largest quantities of green fodder per acre can ordinarily be obtained by planting the corn in hills three or even two feet apart, or in drills three or four feet apart, with plants six or eight inches apart in the row.

It makes little if any difference, so far as the yield obtained is concerned, whether the corn is planted in hills or in drills, when the land is kept free from weeds in both cases, but it facilitates the cutting considerably to plant the corn in drills if this is done by means of a corn harvester or sled cutter, as is now generally the case. The yield seems more dependent on the number of plants grown on a certain area of land than on the arrangement of planting the corn. Hills four feet each way, with four stalks to the hill, will thus usually give about the same yield as hills two feet apart, with stalks two stalks to the hill or drills four feet apart with stalks one foot apart in the row, etc. The question of planting corn in hills or in drills is therefore largely one of greater or less labor in keeping the land free from weeds by the two methods. This will depend on the character of the land; where the land is uneven, and check-rowing of the corn difficult, or when the land is free from weeds, drill planting is preferable, while, conversely, on fields where this can be done, the corn may more easily and cheaply be kept free from weeds if planted in hills and check-rowed. Since one of the advantages of the silo is economical production and preservation of a good quality of feed, the economy and certainty in caring for the growing crop is of considerable importance, and generally planting in hills not too far apart will be found to facilitate this, especially during wet season.

Corn is planted in hills or in drills, and not broadcast, whether intended for the silo, or for production of ear corn; when sown broadcast, the corn cannot be kept free from weeds, except by hand labor. More seed is moreover required, the plants shade each other and will therefore not reach full development, from lack of sufficient sunshine and moisture, and a less amount of available food constituents per acre will be produced.

Other Silage Crops.

Clover. We are but beginning to appreciate the value of clover in modern agriculture. It has been shown that the legumes, the family to which clover belongs, are the only common forage plants able to convert the free nitrogen of the air into compounds that may be utilized for the nutrition of animals. Clover and other legumes, therefore, draw largely on the air for the most expensive and valuable fertilizing ingredient, nitrogen, and for this reason, as well as on account of their deep roots, which bring fertilizing elements up near the surface, they enrich the land upon which they grow. Being a more **nitrogenous** food than corn or the grasses, clover supplies a good deal of the protein compounds required by farm animals for the maintenance of their bodies and for the production of milk, wool or meat. By feeding clover, a smaller purchase of high-priced concentrated feed stuffs, like flour-mill or oil-mill refuse products, is therefore rendered necessary than when corn is fed; on account of its high fertilizing value it furthermore enables the farmer feeding it to maintain the fertility of his land.

When properly made, clover silage is an ideal feed for nearly all kinds of stock. Aside from its higher protein contents it has an advantage over corn silage in point of lower cost of production. A Wisconsin dairy farmer who has siloed large quantities of clover estimates the cost of one ton of clover silage at 70 cents to \$1, against \$1 to \$1.25 per ton of corn silage. His average yield per acre of green clover is about twelve tons.

Clover silage is superior to clover hay on account of its succulence and greater palatability, as well as its higher feeding value. The last-mentioned point is mainly due to the fact that all the parts of the clover plant are preserved in the silo, with a small unavoidable loss in fermentation, while in hay-making, leaves and tender parts, which contain about two-thirds of the protein compounds, are often largely lost by abrasion.

Contrasting results in the use of clover for silage seem to indicate that it keeps better in a cool climate than under warm or temperate conditions. At the Agassiz Experiment Station in British Columbia three cuttings of red clover yielded 32 tons of green forage to the acre and made cheaper silage than the corn plant. In practically every instance in this region where clover has been used in the silo the results have been satisfactory. Prof. Harry

Hayward of the Pennsylvania Experiment Station states that as a result of experiments carried on there he believes a small amount of clover will go much farther in the silo than it will if pastured. Attempts at the Wisconsin Experiment Station to make silage out of the whole clover plant without chopping were not satisfactory. By running the green clover through cutter, however, and tramping it thoroughly, fairly good results were obtained.

The latest experiments on the question of using clover as silage have been conducted at the Montana Experiment Station by Prof. R. W. Clark. His results showed that second crop clover made into silage during September and October after being frozen, kept well until May and June the following year. After the weather became warm, however, it grew dark in color, strong in odor and was not relished by the cows. During the winter months the cattle uniformly had a keen appetite for it.

In milk production 2.35 pounds of clover silage was required to equal one pound of good clover hay, this difference being due largely to the difference in moisture content. In calculating the results, timothy hay was placed at a value of \$10 a ton, clover hay at \$6, clover silage at \$2.50 a ton, and grain at \$20 a ton.

An average of the three experiments, which were conducted with precautions to make up for the varying individually of the cows, showed the cost of producing 100 pounds milk was 73.9 cents on clover hay and 73.4 cents on clover silage. The cost of a pound of fat on the hay was 17.9 cents, while on the silage it was 17.8. The daily production of milk on clover hay was 22.8 pounds and 0.93 pound of fat, compared to 24.8 pounds and 0.97 pound of fat on the clover silage.

The general indications seem to be that clover silage has a value of about \$2.55 a ton under Montana conditions and when it is necessary to save the crop in this way or else have it lose value on account of weather conditions, it may very well be preserved in the silo.

Under corn belt conditions where corn has already become established as the favorite silage crop, probably little clover will be used. Very frequently, however, the clover crop is threatened with damage by rain or too intense sunshine, and it may be easily and cheaply placed in a silo regardless of the weather and preserved in a perfect condition. The failures reported in the early

stages of silo filling were largely due to the faulty construction of the silo. Clover does not pack as well as the heavy green corn, and, therefore, requires to be cut and weighted, or calls for greater depth in the silo, in order that the air may be sufficiently excluded.

The clover should not be left to wilt between cutting and siloing, and the silo should be filled rapidly, so as to cause no unnecessary losses by fermentation.

The different species of clover will prove satisfactory silo crops; ordinary red or medium clover is most used in Northwestern States, along with mammoth clover; the latter matures later than medium or red clover, and may therefore be siloed later than these.

When to Cut Clover for the Silo.—The yield of food materials obtained from clover at different stages of growth has been studied by a number of scientists. The following table giving the results of an investigation conducted by Professor Atwater will show the total quantities of food materials secured at four different stages of growth of red clover:

Table XII.—Yield Per Acre of Red Clover—in Pounds.

STAGE OF CUTTING	Green Weight	Dry Matter	Crude Protein	Crude Fibre	N-free Extract	Crude Fat	Ash
Just before bloom....	3,570	1,385	198	384	664	24	115
Full bloom.....	2,650	1,401	189	390	682	33	107
Nearly out of bloom..	4,960	1,750	230	523	837	31	129
Nearly ripe.....	3,910	1,523	158	484	746	36	99

Professor Hunt obtained 3,600 pounds of hay per acre from clover cut in full bloom, and 3,260 pounds when three-fourths of the heads were dead. The yields of dry matter in the two cases were 2,526 pounds, and 2,427 pounds respectively. All components, except fiber (see Glossary), yielded less per acre in the second cutting. Jordan found the same result, comparing the yields and composition of clover cut when in bloom, some heads dead, and heads all dead, the earliest cutting giving the maximum yield of dry matter, and of all components except crude fibre.

The common practice of farmers is to cut clover for the silo when in full bloom, or when the first single heads are beginning to wilt, that is, when right for hay-making, and we notice that the

teachings of the investigations made are in conformity with this practice.

Many farmers are increasing the value of their corn silage by the addition of clover. A load of clover to a load or two loads of well-matured corn is a good mixture.

Clover for Summer Silage.—By filling the clover into the silo at midsummer, or before, space is utilized that would otherwise be empty; the silage will, furthermore, be available for feeding in the latter part of the summer and during the fall, when the pastures are apt to run short. This makes it possible to keep a larger number of stock on the farm than can be the case if pastures alone are to be relied upon, and thus greatly facilitates intensive farming. Now that stave silos of any size may be easily and cheaply put up, it will be found very convenient at least on dairy farms, to keep a small separate silo for making clover silage that may be fed out during the summer, or at any time simultaneously with the feeding of corn silage. This extra silo may also be used for the siloing of odd lots of forage that may happen to be available (see page 159). It is a good plan in siloing clover or other comparatively light crops in rather small silos, to put a layer of corn on top that will weight down the mass below, and secure a more thorough packing and thereby also a better quality of silage.

In several instances where there has still been a supply of clover silage in the silo, green corn has been filled in on top of the clover, and the latter has been sealed and thus preserved for a number of years. Corn silage once settled and "sealed," will also keep perhaps indefinitely when left undisturbed in the silo, without deteriorating appreciably in feeding value or palatability.

Says a Canadian dairy farmer: "If we were asked for our opinion as to what will most help the average dairy farmer, I think we would reply: Knowledge of a balanced ration, the Babcock test, and a summer silo; then varying the feed of individual animals according to capacity; as shown by scales and close observation." Prof. Neale and others recommended the use of scarlet clover for summer silage, for Delaware and States under similar climatic conditions.

Prof. Cottrell writing for Kansas farmers, says: "Silage will keep as long as the silo is not opened, and has been kept in good condition for seven years. This is a special advantage for Kansas

dairymen, as in years of heavy crops the surplus can be stored in silos for years of drouth, making all years good crop years for silo dairymen."

Alfalfa (lucerne) is the great, coarse forage plant of the West, and during late years it has been grown considerably in the Northern and Central States. In irrigated districts it will yield more food materials per acre of land than perhaps any other crop. Four to five cuttings, each yielding a ton to a ton and a half of hay, are common in these regions, and the yields obtained are often much higher. In humid regions three cuttings may ordinarily be obtained, each of one to one and a half tons of hay.

Much has been written regarding the mixture of alfalfa with other crops in the silo to secure a balanced ration. It is true that there is perhaps no crop better than alfalfa for balancing corn silage. But the best practice among Western feeders and colleges is to supply this ration in the dry form. In this way it furnishes the necessary roughage to neutralize the succulence of the silage, and enables the feeder to balance his feed to suit the needs of different animals or different classes of stock.

Alfalfa finds its greatest friend in the silo in seasons when for any reason it cannot be properly cured. It may then be siloed and preserved to great advantage.

While the large bulk of the crop is cured as hay, alfalfa is nevertheless of considerable importance as a silage crop in dairy and beef sections of the Western States. As with red clover, reports of failure in siloing alfalfa are on record, but first-class alfalfa silage can be readily made in deep, modern silos, when the crop is cut when in full bloom, and the plants are not allowed to wilt much before being run through a cutter and siloed. In the opinion of the dairymen who have had large experience in siloing alfalfa, sweet alfalfa silage is more easily made than good alfalfa hay.

A general summary of alfalfa silage experiments at the Colorado experiment station states that under the best of ordinary conditions, for every hundred pounds of feeding value in green alfalfa at the time it is cut, 77 pounds will be saved if the hay is well cured and put in a stack under good conditions. If it is put into the barn, 86 pounds will be saved and 90 pounds if it is made into first-class silage. The extra cost of putting it up as silage is

believed to be somewhat balanced up by the fact that alfalfa can be put into a silo even under bad weather conditions. In general the results from the use of alfalfa as a silage crop have indicated that it makes first-class feed and keeps well for the first few months, but that after this time there is a tendency to decompose, take on a bad odor and lose considerable of its feeding value.

What has been said in regard to the siloing of clover refers to alfalfa as well. Alfalfa silage compares favorably with clover silage, both in chemical composition and in feeding value. It is richer in flesh-forming substances (protein) than clover silage, or any other kind of silage, and makes a most valuable feed for farm animals, especially young stock and dairy cows.

Additional information regarding the use of alfalfa as a silage crop will be found in chapter eight of this book, entitled "Silage Crops for the Semi-Arid Regions and for the South."

Cow Peas are to the South what alfalfa is to the West, and when properly handled make excellent and most valuable silage. The cow peas are sown early in the season, either broadcast, about $1\frac{1}{2}$ bushels to the acre and turned under with a one-horse turning plow, or drilled in rows about two feet apart. They are cut with a mower when one-half or more of the peas on the vines are fully ripe, and are immediately raked in windrows and hauled to the silo, where they are run through a feed cutter and cut into inch or half inch lengths.

Cow pea silage is greatly relished by farm animals after they once become accustomed to its peculiar flavor; farmers who have had considerable practical experience in feeding this silage are of the opinion that cow-pea silage has no equal for cows and sheep. It is also a good hog food, and for all these animals is considered greatly superior to pea-vine hay. In feeding experiments at a Delaware experiment station six pounds of pea-vine silage fully took the place of one pound of wheat bran, and the product of one acre was found equivalent to two tons of bran.

Instead of placing only cow peas in the silo, alternate loads of cow peas and corn may be cut and filled into the silo, which will make a very satisfactory mixed silage, much richer in muscle building material than pure corn silage. A modification of this practice is known as **Getty's method**, in which corn and cow peas are grown in alternate rows, and harvested together with a corn

harvester. Corn for this combination crop is preferably a large Southern variety, drilled in rows $4\frac{1}{2}$ feet apart, with stalks 9 to 16 inches apart in the row. Whippoorwill peas are planted in drills close to the rows of corn when this is about six inches high, and has been cultivated once. The crop is cut when the corn is beginning to glaze, and when three-fourths of the pea pods are ripe.

The corn and peas are tied into bundles and these run through the silage cutter. The cut corn and peas are carefully leveled off and trampled down in the silo, and about a foot cover of green corn, straw or cottonseed hulls placed on top of the siloed mass. As in case of all legumes, it is safest to wet the cover thoroughly with at least two gallons of water per square foot of surface. This will seal the siloed mass thoroughly and will prevent the air from working in from the surface and spoiling considerable of the silage on top.

Robertson Silage Mixture.—A similar effort of combining several feeds for the silo is found in the so-called Robertson Silage Mixture for the silo, named after Prof. Robertson in Canada. This is made up of cut Indian corn, sunflower seed heads, and horse beans in the proportion of 1 acre corn, $\frac{1}{2}$ acre horse beans, and $\frac{1}{4}$ acre sunflowers. The principle back of the practice is to furnish a feed richer in protein substance than corn, and thus avoid the purchase of large quantities of expensive protein foods like bran, oil meal, etc. Feeding experiments conducted with the Robertson Silage Mixture for cows at several experiment stations have given very satisfactory results, and have shown that this silage mixture can be partly substituted for the grain ration of milch cows without causing loss of flesh or lessening the production of milk or fat. Fifteen pounds of this silage may be considered equivalent to three or four pounds of grain feeds. The practice has not, however, been adopted to any great extent, so far as is known, owing to the difficulty of securing a good quality of silage from the mixture and of growing the horse beans successfully.

Soy beans are another valuable silage crop. According to the U. S. Department of Agriculture the soy bean is highly nutritive, gives a heavy yield, and is easily cultivated. The vigorous late varieties are well adapted for silage. On account of their highly nitrogenous character, soy beans are most economical when

mixed with corn, and like other legumes they improve the silage by tending to counteract the acid reaction of the corn. The mixture also produces a more nearly balanced ration than either crop alone, and avoids the necessity of using purchased concentrates such as grain, bran, cottonseed, etc. Some have found that the soy beans save at least half the grain bill. The crops may be mixed to best advantage for both cutting and feeding, by placing the soy beans on top of the corn as it enters the silage cutter, in the proportion of two, three, four or five parts of corn, as desired, to one part of soy beans. The latter should be siloed when the pods are well formed and the seeds are nearly grown. Of other southern crops that are used for silage may be mentioned chicken corn and teosinte.

Sorghums.—Sorghum crops, both saccharine and non-saccharine (sweet and non-sweet), can be used for silage with good results. The saccharine sorghums include the Amber, Orange, Sumac and Gooseneck groups. The non-saccharine varieties embrace the Kafir and White Milo groups, and the Dhoura group. Their drouth-resistant qualities have done much to make sorghum the leading crop in the drier parts of the South and West—they remain fresh and green through drouths that would ruin corn. They are also less liable to be damaged by insects than corn. The yield per acre of green sorghum will often reach 20 tons, or one-half again as much as a good crop of corn. The Ottawa (Can.) Station states that sorghum, where it can be grown, makes an excellent crop for silage. It needs to be cut, the best length, as in the case of corn, being about one-half inch.

While the sorghums are adapted for growing on almost any kind of soil they produce best on fairly heavy, well drained loams, rich in humus; but when grown on gumbo, hard-pan, sandy or other poor soils, they are more successful than most other crops.

Sorghums usually yield well with little care. They are excellent to plant on prairie sod or alfalfa sod. For silage, sorghum should be planted in rows like corn and cultivated; in fact, the crop is handled throughout like corn.

In experiments at the Tennessee Station, A. M. Soule found that "as fine a quality of silage can be made from sorghum as from any other crop and there seems to be little choice between the feeding values of sorghum and corn silage for beef production."

He states that "farmers who experience difficulty in making good silage either cut the crops too green or else have improperly constructed silos."

Sorghum, like corn, contains an excess of carbohydrates and is somewhat deficient in protein. Its value is increased therefore by the addition of some leguminous crop such as cow peas.

Reports in the agricultural press indicate that many feeders make a practice of combining their kafir, milo or sorghum in the silo with corn, or with cow peas, field peas or other legume, and with success.

Further information regarding the sorghum crops for silage, including the latest experiments along that line, will be found in Chapter VIII., where silage crops for the Semi-Arid Regions are discussed.

Sorghum bagasse is the name given to the crushed stalk of sorghum cane, and has been used with some success as silage. In Prof. Henry's "Feeds and Feeding," he says: "The bagasse, or waste, of the sorghum syrup factories, which has considerable feeding value, should not be wasted, but may be satisfactorily ensiled." Naturally, bagasse is a little dryer than most crops as they are put into the silo, and the addition of water would greatly assist in packing it tight enough together to keep out the air and thus prevent spoiling. Corn may be mixed with the bagasse if desired. As a safeguard against spoilage, the bagasse should be siloed as soon as it comes from the mill and in considerable quantity each day.

Feterita is a comparatively new semi-arid crop that has absolutely proved itself as an early maturing drouth-resistant feed. Its superiority over any similar crop was conspicuous under the severe conditions of 1914 throughout Oklahoma. It is generally conceded to be almost exactly the equal of kafir corn and milo maize in food value and in its proportion of various elements, and since both of these crops make excellent silage it will doubtless follow in the same class. A large number of silo owners in Oklahoma and Texas are trying out this crop at the time this book goes to press.

Teosinte.—This forage plant in tassel and appearance closely resembles corn with no ear formed. Stock relish it and its food value is high. It is very juicy and succulent and has been suc-

cessfully siloed, but is not so good for this purpose as corn. Burkett says that if allowed to mature and used as dry fodder it makes a very heavy yield, running several tons of dry matter to the acre. It demands a rich soil with a good deal of moisture, and is partial to hot climates, but unlike sorghum and kafir, it cannot resist drouth.

Kale.—The Oregon Experiment Station at Corvallis reports very palatable silage from a mixture of eight tons of Kale and two tons of mixed hay, cut short and well packed. Kale is not well adapted for a silage crop, however, on account of its high water content, and should only be put in the silo to avoid a loss in the spring.

Sudan Grass, a wonderful drouth-resister, supposed to be the parent stock of the cultivated sorghums, is making rapid strides as a hay and fodder crop throughout Colorado, Oklahoma, Southern California and the Southwest generally. The seed is hard to distinguish from Johnson grass. For large yields it should be planted in rows from 30 to 36 inches apart, using from 2 to 4 pounds of seed to the acre, and cultivated. On account of its newness and the heavy demand for seed, data is not available as to its feeding value. It is the general opinion of feeders, however, that it will make an excellent silage crop, if allowed to mature properly before being placed in the silo.

Devil Grass or Broncho Grass and **Fox Tail** have sometimes proved a problem to alfalfa growers in California. Some feeders have found that the beards of the Devil Grass and Fox Tail are rendered harmless by cutting and siloing them along with the oat hay, barley or wheat hay and second cutting of alfalfa and that it makes a silage superior to alfalfa and grain hay silage alone, leaving the ground available for a crop of corn.

Vetches are relished by livestock of all kinds. They are excellent for milk production and have splendid fattening properties. Being of the legume family, they are best adapted for hay, but when conditions are unfavorable they may be cut into short lengths and well packed in the silo and will make a very agreeable feed. They should be cut the same time as for hay.

Peanuts are especially valuable if mixed with kafir corn in the silo, as they make a much better balanced feed than kafir corn alone.

Broom Corn.—Excellent results have been obtained in Northwest Oklahoma and Southwest Kansas by cutting the broom corn stalks after the tops have been removed and preserving them in the silo. Such silage contains no grain, and is, of course, greatly inferior to other crops that contain grain, but it is a practical way of saving this feed, that otherwise would be, to a large extent, lost.

Johnson Grass is a tall vigorous grass, closely related to the sorghums. As a silage crop it has not been used except to a limited extent, but it has possibilities worth investigating. One of the southern Agricultural Colleges partially filled a silo with Johnson grass in 1913 and claim good results, so that further tests will be made with it.

Miscellaneous Silage Crops.—In Northern Europe, especially in England, and the Scandinavian countries, meadow grass and aftermath (*rowen*) are usually siloed; in England, at the present time, largely in stacks.

In districts near sugar beet factories, where **sugar-beet pulp** can be obtained in large quantities and at a low cost, stock raisers and dairymen have a most valuable aid in preserving the pulp in the silo. As the pulp is taken from the factory it contains about 90 per cent. of water; it packs well in the silo, being heavy, finely divided and homogeneous, and a more shallow silo can therefore be safely used in making pulp silage than is required in siloing corn, and especially clover and other crops of similar character. If pulp is siloed with other fodder crops, it is preferably placed uppermost, for the reason stated. Beet tops and pulp are often siloed in alternate layers in pits 3 to 4 feet deep, and covered with boards and a layer of dirt. Beet pulp can also be successfully placed in any modern deep silo, and is preferably siloed in such silos as there will then be much smaller losses of food materials than in case of shallow silos or trenches in the field.

Beet pulp silage is relatively rich in protein and low in ash and carbohydrates (nutr. ratio 1:5.7; see Glossary). Its feeding value is equal to about half that of corn silage.

The Colorado Station has found that two tons of pulp are the equivalent of one ton of beets, which confirms the Nebraska test showing the feeding value of sugar beets to be practically equiv-

alent to corn silage, pound for pound, for dairy cows. The use of beet tops for silage is discussed on page 166 of this book.

Wheat, rye and oats have been siloed for summer feeding with some success. They should be cut in $\frac{1}{4}$ inch lengths and well tramped around the edges. A recent correspondent in Hoard's Dairyman tells of sowing some 23 acres of rye and 9 acres of wheat in the fall and filling one silo with the rye the following May and the other with wheat early in June, just when they were headed out but before the grain was actually formed. Several acres of oats and peas were put into a third silo the first week in July. In cutting the rye and wheat it was necessary to take the precaution of cutting into short lengths and of carefully treading and packing it in the silo, in order to insure its keeping qualities. "It has kept very well until entirely consumed by the cattle, and we have no reason to suppose that it would not have kept if we had not used it up when we did. But our experience has been that neither the rye nor the wheat is equal to corn silage for feed. In fact the cows did not eat the rye as clean as they should have done and fell off somewhat in milk. When we began on the wheat, however, they did better, and we believe the wheat to be better material for silage than rye."

Oats and peas may be put into the silo and they make a very satisfactory silage. As a rule, those plants which have a hollow stem, like oats, do not keep well in the silo unless great care is taken to have them very well tramped, as the hollow stems carry too much air. If the late summer and fall are not too dry it will be possible to produce a crop of cow peas for ensilage, planted after oats harvest.

Oats have been put in the silo to kill mustard seed before the latter plants were matured, but after maturity the seeds are so well protected that it is doubtful if the heating and fermentation would destroy them.

When **legumes** such as alfalfa, clover, vetch and peas are put into the silo, they should be ensiled with some such crop as corn, rye or oats. The legumes alone do not contain enough sugar to afford the production of sufficient acid to prevent the high protein content of the legume from decaying. The corn, rye or oats, mixed with the legumes, would provide sugar for the production of sufficient acid to preserve both plants. The rye should be mixed

with the legume in the proportion of two-thirds legume and one-third rye. In this way, rye may be sown for fall and spring pasture, cut for silage and the ground plowed and used for some other crop.

Occasional mention has furthermore been made in the agricultural literature of the siloing of a large number of plants, or products, like vetches, small grains (cut green), buckwheat, artichoke tops, cabbage leaves, sugar beets, potatoes, potato leaves, turnips, brewers' grains, apple pomace, refuse from corn and pea canning factories; twigs, and leaves, and hop vines; even fern (brake), thistles, and ordinary weeds have been made into silage, and used with more or less success as foods for farm animals.

The value of **fern**, or common brake, for silage is very doubtful. It grows on the wild pasture lands throughout Western Oregon and has practically no feeding value. The Corvallis, (Ore.) Station says that it is very dangerous when fed to horses because of a stringent quality which causes a serious nervous disorder. Where farmers are troubled with a large quantity of fern in their hay crop they should use a crop rotation, including a cultivated crop, which will soon get rid of the fern and permit the raising of profitable crops.

A Wisconsin farmer has been using **Canada thistles** as silage for several seasons. He claims that after they have been cut up and placed in the silo for a week or two, they become very soft and palatable and says that the cattle eat this food ravenously to the last scrap and never seem to get enough of it.

Russian Thistles have been used for silage to a considerable extent in the Dakotas west of the river, and in Colorado, Wyoming and other semi-arid sections, with good results. They have strong drouth-resistant qualities and are very nutritious. Analysis shows them to closely resemble alfalfa in food value with about 18% protein. The plant is eaten with relish by all kinds of live stock. The Russian thistle has usually been considered a detriment and a pest. Farmers are advised against raising them either for silage or forage, or allowing them to take possession of their places. But the very fact that they thrive most abundantly in dry years, just when silage crops are most likely to be scarce, is the soundest reason why the pest should be turned to good account in the silo and this is just what hundreds of farmers are doing.

As to the use of **weeds** it is a known fact that live stock of all kinds will eat nearly any kind of weeds in certain seasons and under certain conditions, and thrive on them. At a recent convention of the California Dairy Association the president, Mr. A. P. Martin, stated that the best silage he ever made, besides corn, was made of weeds. A piece of wheat which was sowed early, was drowned out, and the field came up with tar weed and sorrel. This was made into silage, and when fed to milch cows, produced most satisfactory results.

Alvord says that a silo may be found a handy and profitable thing to have on a farm even if silage crops are not regularly raised to fill it. There are always **waste products**, green or half-dry, with coarse materials like swale hay, that are generally used for compost or bedding, which may be made into palatable silage. A mixture, in equal parts, of rag-weed, swamp grass or swale hay, old corn stalks or straw, and second-crop green clover, nearly three-fourths of which would otherwise be almost useless, will make a superior silage, surprising to those who have never tried it.

The following description of the contents filled into a New York silo, which was used as a sort of catch-all, is given by the same writer: 18 in. deep of green oats; 6 in. of red clover; 6 in. of Canada field peas; 3 in. of brewers' grains; 2 feet of whole corn plants, sowed broadcast, and more rag-weed than corn; 5 in. of second-crop grass; 12 in. of sorghum; and a lot immature corn cut in short lengths. The silage came out pretty acid, but made good forage, and was all eaten up clean. Damaged crops like frosted beets, potatoes, cabbages, etc.; rutabagas which showed signs of decay, and clover that could not be made into hay because of rain, may all be placed in a silo and thus made to contribute to the food supply on the farm.

A peculiar use of the silo is reported from California, viz., for rendering **foxtail** in alfalfa fields harmless in feeding cattle. The foxtail which almost takes the first crop of alfalfa in many parts of California is a nutritious grass, but on account of its beards, is dangerous to feed, if cut when nearly ripe or later. By siloing the crop the foxtail will be rendered harmless; the alfalfa-foxtail silage thus obtained is eaten by stock with great relish and without any injurious effects. (Woll.)

CHAPTER VIII.

SILAGE CROPS FOR THE SEMI-ARID REGIONS AND FOR THE SOUTH.

In those parts of the Southwest including the Great Plains region, where limited precipitation, evaporation and temperature conditions combine to make moisture conservation the vital problem, the silo is finding one of its greatest fields of usefulness.

It is generally conceded that when it can be grown successfully, corn is pre-eminently the silage crop. In many sections, however, corn does not mature or make sufficient yield, either in fodder or grain, to justify its use as compared with other crops well adapted to the siloing system, which do not require nearly so much moisture, and it is of these crops that we wish to speak in this chapter. Stockmen are beginning to realize that they must have a permanent feed supply, one that will produce a good yield even under drouth conditions, or the live stock industry itself cannot be permanent, and the haphazard method of depending entirely on Nature's offerings for the present need is fast becoming obsolete. With the ability of Western Kansas, for instance, to produce crops such as kafir, milo, saccharine sorghum and the broom corns, there is no reason why there should ever be a shortage of feed such as the farmers of that section experienced in the winter of 1911-12.

The sorghums are the crops of first importance as silage in the regions where moisture is the controlling factor in crop production. The sweet sorghums have usually been considered a poor substitute for corn in the silo, but the conditions under which they are grown in regions of light rainfall, to a large extent, overcome the difficulty which is found in other sections of the country. If they are allowed to mature quite fully before they are cut for the silo, they do not form an abnormal amount of acid as they do when cut too green, or when grown under heavy rainfall conditions.

For convenient reference the matter that follows has been classified under various states, although it should be remembered that the discussion relative to one state is very often applicable to

other sections where similar moisture and temperature conditions prevail.

Kansas.—The conditions covered by Prof. Reed of the Kansas Experiment Station are, therefore, representative of many other regions:

“There is a prevailing opinion among many farmers and users of silos that the sweet sorghum is unfit for silage, that on account of the high sugar content there will be a large amount of acid formed, and the silage will be too sour to feed. It is true that this plant does contain a large amount of sugar, and the silage will become very sour if the crop is put up too green. In most cases where unsatisfactory results have been obtained by ensiling sweet sorghum, it has been due to the fact that the crop was put in too green. Last year the Kansas Experiment Station obtained twelve and one-half tons of sowed cane per acre as against five tons of corn that was listed. These crops were put into the silo at the proper time, and they both made good feed. Quite contrary to the general opinion and experience it was found that the acid content of the sweet sorghum silage was less than that of the corn silage at all times. This silage was fed to dairy cows and they did not show any preference between the two kinds of silage. The excellent quality of the sweet sorghum silage was accounted for from the fact that it was put up at the right time.

“Sorghum crops should be almost mature when they are cut for silage. If cut too early the stalk will contain entirely too much juice. At the time the seed hardens, the stalk of the sweet sorghum and kafir plant will be well filled with sap, yet will not contain an excess so as to cause the silage to sour in the silo.”

Even the most stunted kafir can be saved with the silo. At the Kansas Station, kafir that was so stunted in its growth by reason of drought that it yielded only a ton to the acre, with no grain whatever, was made into silage and was eaten readily by the stock. It served to furnish a succulent feed, where otherwise all of their feed would have been of a dry nature.

Oklahoma.—James A. Wilson, director of the Oklahoma Station, writes that, “for ensilage purposes we have used sorghum cane considerably during the past few years. The nonsaccharine sorghums, such as kafir and milo, make very excellent silage. We

have also had good success with the sugar cane or Amber cane.

"There is this difference, however, that should be observed in filling the silo with the above crops, namely, that the kafir corn and milo maize should be allowed to fully mature, that is, allowing the sap to carry the sugar up into the stalk which is usually done just before the plant is fully matured. While in the case of sugar cane, we have found it best to cut this on the green side before the maximum amount of sugar has been deposited in the plant, otherwise, we find that sugar cane ensilage sours."

Bulletin No. 181 of the Oklahoma Station says: "Silos are not luxuries but necessities in Oklahoma. The silo does not only preserve fodder in its best form for feeding, but provides the cheapest of feeds for cattle and sheep. The whole corn or sorghum crop be stored up—butt, stalks and all—so that hardly any is lost.

"Silage is much relished by stock, especially by cattle and sheep. It is palatable, cheap and succulent, thins and cools the blood, improves the handling qualities of skin and hair, tones up the digestive system, and improves the health generally. Breeding females are put in good condition for producing healthy offspring, and after parturition are better able to give plenty of milk than when on a dry ration. To a large extent it is a preventive of digestive troubles, and with dairy cows it lessens considerably the chances of milk fever and garget. The legumes, such as alfalfa, cow peas, clover, soy beans, while they can be made into silage, are not satisfactory when mixed alone, as they will not pack sufficiently, but when mixed with a good proportion of corn or kafir fodder make a first-class, well balanced silage."

Texas.—Sorghum is a sure crop in Texas and will produce a fine quality of ensilage. Texas Bulletin No. 11 says that the heavy growing varieties such as the Orange and African cane are preferred. It is planted in drills three feet six inches apart and cultivated. If it is planted early, two good crops can be secured in one season on the same ground if the stubble is cultivated after the first crop is cut off. This crop should also be allowed to mature until the seed are hard.

An authority on silage conditions in Texas, connected with the Frisco Railroad System, writes that "Sorghum is the most

valuable plant that we have for silage. For this purpose it is, of course, grown in drills or rows, in the same way that corn is grown. It does not make quite as good grade of silage as corn, but it makes so much more to the acre that it is preferable. We frequently get two cuttings to the season, but if we get only one, the yield is so much more than the corn that any difference in nutritive value is overcome. Some farmers practice mixing sorghum and corn, but I do not think this is desirable in the South. Cow pea vines and sorghum would make a most excellent mixture for silage purposes, except the pea vines have a disadvantage of being difficult to handle; but the sorghum being rich in carbohydrates and the pea vines rich in protein matter, the mixture, as you will readily see, is an exceedingly good one.

"I receive letters sometimes from parties who seem to have a doubt as to whether silage can be made successfully in this climate, but there is no part of Texas in which it is not an entire success, and silos ought to be constructed and used much more widely than they are in this State. Sorghum silage is eaten readily by horses and mules of the farm, as well as by cattle, and it can be made to form an important part of the ration of the farm work stock, as well as the stock intended for the butcher, including hogs."

Texas Station Bulletin No. 11 says that the crops most desirable for the silo in Texas are corn, sorghum, cow peas, alfalfa and ribbon cane tops. Indian corn is the crop most generally used for the silo in that state. Sorghum, kafir and milo are also used extensively. Prof. Burns says that these four crops are sometimes planted in rows together, the result being a mixed silage of high quality. Kafir and milo are chiefly used in the semi-arid sections of the state where Indian corn does not thrive well. "All crops planted especially for the silo should be grown a little more thickly than when planted to harvest in the ordinary way, and they should become very well matured before being cut. Experience indicates that the best results are secured from corn and sorghum just as the grain begins to harden. The other crops will make a good ensilage at the same time they would be cut for hay. Combinations of corn and cow peas or sorghum and cow peas planted at the same time and in the same row make splendid ensilage and supply a nearly balanced ration with which very little grain is needed."

New Mexico.—Prof. Simpson of the New Mexico Station writes regarding silage crops in that state as follows: “Just as corn is used for the leading crop in the Corn Belt states, nonsaccharine sorghums, as kafir corn and milo, are used in this country. They are much more successfully grown here than corn, as they withstand the drought better and are not bothered by the worms. Kafir corn and milo silage has been proven to be very good in feeding value; and especially is this true in New Mexico, as the larger part of the feeds which must be used with silage are of a nitrogenous character. Alfalfa is our leading hay crop, and bran, cottonseed meal, wheat, oats, kafir and milo are the principal grains used in feeding. Of course, we have practically two conditions in New Mexico that are absolutely opposite; the irrigated sections and the dry-farming sections. In the irrigated valleys kafir corn and milo grown for silage make a very heavy yield and will undoubtedly stand first for silage crops. In the dry-farming sections the same two crops prevail, as more success comes from them than any other crops. I have been over a great deal of the dry-farming country in the last two weeks (October, 1912), and in most sections they have a very good crop of kafir and milo this year. The tonnage will be heavy wherever it is used for silage. However, I am afraid that there is going to be a great deal wasted feed in those sections, because of the fact that they have few silos. Some of the people are putting their crops in silos, but others are simply growing it as fodder. If we could get a large percentage of the crops raised in the dry-farming sections this year into silos and fed to stock, especially dairy cattle, I conscientiously believe that it would mean a great advantage in the settling up and improving of the country. Most of the silos in the dry-farming country are nothing more than underground types, but they serve the purpose very well where the person has no money to put up another kind.

“We have a great variety of crops, both in the irrigated and the dry-farming section, which make fairly good silage, and by utilizing them a great saving will be accomplished. Of course, there is no advantage in putting alfalfa into the silo, if it can be made into first-class hay. However, oftentimes when it is time for the second or third cut, our rains are so persistent that it is impossible to get it into first-class hay. This can still be made into good feed by making into silage, and the farmers will

be able to utilize the full value of it. Some report that they have had very good success by putting barley, wheat, or rye crops into the silo and cutting them a little green. However, as the stalks contain so much air, they must be carefully tramped and wet down to keep, and do not make first-class silage, although they are good.

"In sections where sugar beets are grown, the tops are put into the silo with good success, with not only a large saving made on the crop, but they make excellent silage.

"Cow peas and soy beans are grown in some localities very successfully, and they make first-class silage. Sorghum is another crop which makes very good silage, if allowed to mature fairly well. It grows abundantly, both in the irrigated and the dry-farming sections and yields heavily.

"While there are a few other crops which undoubtedly will prove to be good for silage, they have not yet been tried out. We have a great many grasses which, some of them, may prove valuable for silage."

Arizona, Colorado, etc.—A. E. Vinson of the Arizona Station says that: "In certain sections of the semi-arid countries where dry-farming can be practiced or flood-water utilized in growing corn and sorghum, the silo will probably be found to enable the feeder to use more advantageously the natural pastures, which during part of the year produce more than enough forage for the herds and flocks that can be permanently maintained upon them.

"The advantages to be anticipated from silos in Arizona are several. A supply of succulent feed could be kept available for the short winter period of poor pasture and again for the long period of summer drouth. This is especially important where dairying is practiced, and when there is a scant supply of irrigating water for the pastures in late spring and early summer. In some localities it might be possible to grow fodder corn or sorghum with the summer rains. This forage could be siloed and fed to range stock during the drouth of the next year or used to fatten them for the market. It has been found that as much as three and one-quarter tons per acre of sorghum can be produced by dry-farming methods in some parts of Arizona. This could be preserved as ensilage in succulent condition until needed."

Beet leaves and tops may be utilized to good advantage in Colorado, Arizona and other sections by means of the silo. They should be washed free of dirt and sand, well drained and somewhat dry. The writer quoted above says that "this material sometimes contains as much as $3\frac{1}{2}$ per cent of oxalic acid in the dry substance, of which one-half or more may be soluble in water. Oxalic acid has the property of withdrawing lime from other substances, with which it forms an insoluble oxalate. For that reason it is best not to feed beet leaves or beet leaf ensilage to growing stock since it is apt to produce unduly soft bones by rendering insoluble the lime necessary for their nutrition. Even for mature animals the oxalic acid should be rendered harmless by adding one or two pounds of slaked lime per ton of leaves and tops when they are siloed. Since beet leaf ensilage has marked laxative properties, it must be combined with a liberal amount of straw or other dry forage. It is best adapted for feeding steers, but may also be given to sheep. Dairy cows are said to prosper on it, provided it does not exceed one-third of the total ration."

At the Colorado Station, nine feet of beet tops were placed in a 12x30 foot silo, after being run through a silage cutter. The tops had been frozen and were not in good condition, but they came out in the same condition as when put in. "Twenty-five pounds of the beet top silage was offered each cow of the dairy herd in place of the twenty-five pounds of sugar beet previously fed, the balance of the ration remaining constant. They ate the tops rather reluctantly, some of them finally consuming their entire allowance, others never doing so. That the tops had a greater laxative effect than corn silage was apparent when a change to the latter was made." Beet pulp is siloed to some extent. A high silo used for this purpose "should be provided with special drainage for carrying away the large quantity of water given off by the pulp. (See also page 156.)

"There are a great many Russian thistles all over the dry-farming sections, and these are becoming a great pest," says Prof. Simpson. "There have been a few endeavors to make silage from them, and with a fair degree of success. * * * Of course, we do not advocate planting thistles for silage, but it makes a good maintenance ration when made into silage, and this is one of the

best methods of eradicating the pest, because the plants are not allowed to go to seed."

The Russian thistle when young and tender is relished by cattle, but "as it reaches maturity and its feeding value becomes greater its hardening needles cause it to be avoided by stock. In the process of siloing, the needles are softened and the plant is again rendered palatable. The plants are very bulky in proportion to the substance which they contain, and apparently large quantities of them will be reduced to small bulk in the silo. The entire plant should be pulled to avoid waste in harvest. Unless finely cut, the thistles cannot be packed in the silo sufficiently to exclude air and prevent spoilage."* M. B. Hassig, Cope, Colorado, who siloed several tons of Russian thistles, states: "I had twelve feet of silage made of Russian thistles on top of corn silage. I covered this with dirt, but not as much as I shall after this, as the air penetrated the earth and spoiled about two feet of the silage. The balance was well preserved and relished by the cattle."

He adds that after the thistle silage was exhausted the cattle consumed the corn silage with greater relish.

Corn is the preferable silage crop for all sections of Colorado in which it will equal other fodders in yield. Colorado Bulletin No. 8 recommends for the irrigated sections the following varieties: Iowa Silver Mine, Iowa Gold Mine, Improved Leaming, Pride of the North, Colorado Yellow Dent, and Ratekin's Yellow Dent, and for the unirrigated districts, the White Australian. Squaw corn, Parson's High Altitude corn, Colorado Yellow Dent and Colorado White Dent.

Owing to the good quality of alfalfa hay, the abundance of root crops and the difficulty of getting good yields of corn, the silo is not used to any great extent in Utah, although some experimental work along this line is planned by the Station at Logan in the near future.

Alfalfa and cow peas, already discussed in Chapter VII, are not usually made into silage, except as they are mixed with corn or sorghum. If siloed alone, they should be very well matured and thoroughly packed. Mixed in proportion of one part cow peas

*Colorado Bulletin No. 8.

and three or four parts of corn or sorghum, they keep better and make a more balanced feed than the corn or sorghum alone. The cow peas may be planted in the same row with these crops and gathered with a harvester or they may be planted alone and mowed. In the latter case they should be mixed by placing the cow peas or alfalfa on top of the corn while entering the silage cutter. The cow peas may be forked from an extra wagon, in any desired proportion, usually one part to two, three or four parts of corn or sorghum. Prof. Reed says that "it is very desirable to put in the first crop of alfalfa in case it get rained on, but if alfalfa can be put up for hay it will be worth more in that form than in silage. Alfalfa hay has a market value and there is a growing demand for same, and since the crops such as kafir, sweet sorghum, and corn fodder have no market value, they should best be made into silage instead. Alfalfa hay when put in the silo alone will not keep for a great length of time. The exact reason for this has not been determined. Alfalfa silage that was in the silo for two years at the Kansas State Agricultural College, became very dark, and when it came in contact with the air had a very offensive odor. Cattle would eat a little of it, but not enough to count it as a good feed. If it becomes necessary to put the first crop of alfalfa in the silo, arrangements should be made to feed it out within a few months after it is put up."

The Canada field pea, so extensively grown in the San Luis Valley of Colorado and in other sections of the southwest, shows an analysis only slightly less than the cow pea, and it exceeds corn silage in richness. The field pea, like alfalfa, should be siloed when mature enough for hay, and should be finely cut and thoroughly packed in the silo.

The Spineless Cactus in the warm arid regions of the Southwest is capable of very large yields. It is claimed that the leaves or slabs as a fodder make superior beef and they are a good food for milch cows; the cactus is very rich in sodium, potash and magnesia, the principal salts found in milk. It is a green, fresh and delicious stock food throughout the entire year. For best results, it should be run through a feed cutter. Mr. Luther Burbank used an "Ohio" cutter in demonstrating this cactus at the California State Fair recently.

The prickly pear, both spiny and thornless, are grown along the coast and interior valleys of California and in the warmer parts of Arizona and southern Texas. As with cactus, best feeding results are produced by running through a feed cutter and fed in combination with dry roughage.

Mr. David Griffiths, Government Agriculturist at Washington, says: "A number of attempts have been made to make silage of prickly pear, but so far as I am aware none of them have been entirely successful. The material is very succulent and can be fed in the green, succulent state any day of the year, and the necessity of making it into silage is not the same as that for ordinary crops which perish at the close of the season. It is a warm country crop and can be fed at any time of the year without making it into silage."

In Washington, says Prof. Nystrom of the Pullman Station, "while corn is the best crop, we have been getting good success by using peas and oats, vetch and oats, barley and peas and clover. In some localities also alfalfa has been put in whole, and good silage has resulted. We advocate the use of the corn wherever it will grow; a large part of this state is not fitted for the growing of corn, but will grow Canada field peas and oats. In such localities we advocate this crop for the silo. Most of the crops that are used in a silo have been cut up, that is, run through an ensilage cutter, and good silage has resulted." Alfalfa, kale, corn and clover, barley and vetch, and clover and rye grass are other crops mentioned in Bulletin No. 46 from the Pullman Station, as being used in that state.

Silage Crops in the South.

Japanese cane has been found best adapted for growing throughout Florida, Louisiana and the southern parts of Georgia, Alabama, Mississippi and Texas, or in any sections in which the velvet bean will mature seed. This will be up to 200 or 250 miles north of the Gulf of Mexico.

Japanese cane makes a good silage. It keeps well and is relished by cattle. It has been used in feeding experiments with the dairy herd at the Florida station with quite satisfactory results. The cost of silage from this crop should not exceed

\$1.75 or \$2.00 per ton. It is rich in carbohydrates, but poor in protein, and care should, therefore, be taken to balance the ration when feeding.

Prof. Scott of the Florida Station at Gainesville, says: "Perhaps the best silage crop that we grow here in Florida is the Japanese cane. This produces a heavier tonnage per acre than any other crop that we can grow and at the same time is practically double that which can be secured from sorghum or corn. Then, too, Japanese cane is a much cheaper crop to produce than sorghum or corn, due to the fact that one planting of cane will last for fifteen or twenty years, while sorghum or corn must be planted every year. * * * The Japanese cane stalks should be well matured before being harvested, and this is not likely to occur until early in November. If Japanese cane is cut and put in the silo during September, very unsatisfactory results are likely to occur, and what silage may be saved will be of very poor quality, due to the fact that at this time of the year there is very little feeding value in the Japanese cane, since the formation of sugar does not take place until the crop begins to mature, and the nearer we can let it stand in the field until frost, the higher the percentage of sugar in the stalks.

"A great many have been disappointed in using sorghum for silage. However, I believe that 95 per cent of the failures with sorghum silage has been due to the fact that the sorghum was put in the silo before it was fully matured. To make good silage the sorghum must be fully matured, that is, the seed should be in the hard dough stage.

"Without question sorghum makes good silage. I have no doubt that it is as good as corn, ton for ton. Whether one should grow sorghum or corn for silage will depend somewhat on local conditions. Our soil conditions vary in all sections of the state. Some of our soils are not the best for the growing of heavy crops of corn. On this class of land sorghum produces a much heavier tonnage per acre. Therefore it is advisable to grow sorghum. On the better corn lands it is just possible that as heavy crops of corn can be produced. Where it is possible to grow a heavier tonnage of corn per acre it will no doubt be the better crop to grow."

Prof. Milton P. Jarnagin of the Georgia Agricultural College

writes us as follows: "For a number of reasons the production of silage is one of the most important phases of stock husbandry in the South. There has been an ill-founded opinion that since there is such a long growing season in the cotton section, silage is not of so much importance as in some of the northern sections. From experimental work we believe that it is impossible to produce 100 pounds of beef or a gallon of milk as economically without silage as can be done with it.

"Alternate rows of sorghum and corn will give us from three to five tons of silage per acre depending on the quality of the land, more than can be secured from corn alone. We believe that sorghum and corn silage is equal to corn silage alone, though it is vastly superior to all sorghum silage. Aside from the increased tonnage, sorghum is much more drought resistant than corn. Even in extremely dry weather, we have never failed to get a fairly satisfactory yield of silage where sorghum constituted one-half of the crop. In addition to this, the sorghum carries considerable juice so that we are able to allow the corn to stand until it has developed the maximum amount of nutrients before harvesting. The sorghum then gathers sufficient moisture and weight to insure good packing and keeping.

"We have gotten better results from the use of Red Head sorghum than any of the other varieties. It has a thick, heavy stalk, with heavy foliage, and at the same time it has the ability to stand up better than most other varieties. Any heavy stalk and vigorous growing variety of corn is satisfactory. During the past two years we have gotten better results from Coker's Prolific than from Virginia ensilage corn on the College Farm."

For Alabama, Mr. S. I. Bechdel, dairyman at the Experiment Station at Auburn, recommends the use of a good prolific corn in connection with pea-vines or soy beans, although sorghum is now used to a considerable extent throughout the state. Some of the farmers in the southern part of the state are enthusiastic over the use of sorghum as a silage crop because it enables them to get some other crop off earlier in the spring and get sorghum in in time to make silage before frost.

Corn and sorghum in about equal parts are recommended in Louisiana for good silage. Planting corn or sorghum during the latter half of June on land from which oats or other crops have

already been taken will produce from 5 to 15 tons an acre for the silo.

Sugar cane tops and green leaves made excellent silage at the Baton Rouge Station according to Bulletin No. 143. Analysis showed that a ton of cane top silage carries the equivalent of more feed units (protein, fat and carbohydrate) than $5\frac{1}{2}$ bushels of corn. Out of an 18 ton yield from an acre, hauled to the mill, about six tons would be tops and leaves. Four tons of this would be suitable for silage, with feed units equal to 22 bushels of corn. The gain in making silage of this is very evident. Furthermore, this four tons of tops and leaves, if burned, would destroy \$3.75 worth of nitrogen, whereas if siloed and fed to live stock a large part of it would go back to the soil.

Prof. Staples, of the Experiment Station at Baton Rouge, writes regarding Louisiana conditions as follows: "The best and most profitable crops that we can grow in this state for silage are corn, soy beans, peas and sorghum. The corn and soy beans make the best combination, as the corn is rather dry at some seasons and the soy beans being rather too moist supply the necessary amount of moisture to make the corn and beans together a most excellent combination of feed-stuffs for filling the silo.

"The peas are also very good for combination with the corn, but are somewhat troublesome to handle on account of the vines entangling around the corn stalk and making it very hard to handle, both by the binder when cutting and by the man hauling and feeding the silage cutter. Sorghum is very good feed when used as silage, but does not contain as large a per cent of feeding nutrients as the above mentioned crops."

CHAPTER IX.

HOW TO MAKE SILAGE.

Filling the Silo.

A. Indian Corn.—As previously stated, corn should be left in the field before cutting until it has passed through the dough stage, i. e., when the kernels are well dented or glazed, in case of flint varieties. Where very large silos are filled and in cases of extreme dry weather when the corn is fast drying up, it will be well to begin filling the silo a little before it has reached this stage, as the greater portion of the corn would otherwise be apt to be too dry. There is, however, less danger in this respect now than formerly, on account of our modern deep silos, and because we have found that water applied directly to the fodder in the silo acts in the same way as water in the fodder, and keeps the fermentations in the silo in check and in the right track.

Cutting the Corn in the Field.—The cutting of corn for the silo is usually on small farms done by hand by means of a corn knife. Many farmers have been using self-raking and binding corn harvesters for this purpose, while others report good success with a sled or platform cutter. If the corn stands up well, and is not of a very large variety, the end sought may be reached in a satisfactory manner by either of these methods. If, on the other hand, much of the corn is down, hand cutting is to be preferred. A number of different makes of corn harvesters and corn cutters are now on the market; and it is very likely that hand-cutting of fodder corn will be largely done away with in years to come, at least on large farms, indeed, it looks as if the day of the corn knife was passing away, and as if this implement will soon be relegated to obscurity with the sickle of our fathers' time.

If a corn harvester is used, it will be found to be a great advantage to have the bundles made what seems rather small. It will take a little more twine, but the loaders, the haulers, the unloaders, and even the Silage Cutter itself will handle much more corn in a day if the bundles are small and light, and it will be found to be economy to see that this is done.

Corn cutters have been made by various manufacturers of late years and have proved quite satisfactory, although they require more hand labor than the corn harvesters and do not leave the corn tied up and in as convenient shape for loading on the wagons as these do. It is also necessary to use care with the sledge type of corn cutter, as numerous cases are on record where both men and horses have been injured by getting in front of the knives, which project from the sides.

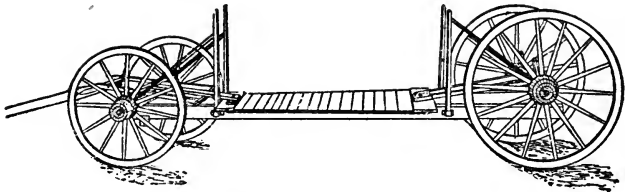

Fig. 52.—Low-down rack for hauling fodder corn.

A low down rack for hauling corn from the field is shown in the accompanying illustration (Fig. 52). It has been used for some years past at the Wisconsin Station, and is a great convenience in handling corn, saving both labor and time. These racks not only dispense with a man upon the wagon when loading, but they materially lessen the labor of the man who takes the corn from the ground, for it is only the top of the load which needs to be raised shoulder-high; again, when it comes to unloading, the man can stand on the floor or ground and simply draw the corn toward him and lay it upon the table of the cutter, without stooping over and without raising the corn up to again throw it down. A plank that can easily be hitched on behind the truck will prove convenient for loading, so that the loader can pick up his armful and, walking up the plank, can drop it without much exertion.

If wilted fodder corn is to be siloed it should be shocked in the field to protect it as much as possible from rain before hauling it to the cutter.

Siloing Corn, "Ears and All."

The best practice in putting corn into the silo is to silo the corn plant, "ears and all," without previously husking it. If the ear corn is not needed for hogs and horses or for seed purposes, this practice is in the line of economy, as it saves the expense of husking, cribbing, shelling and grinding the ear corn. The possible loss of food materials sustained in siloing the ear corn speaks against the practice, but this is very small, and more than counterbalanced by the advantages gained by this method of procedure. In proof of this statement we will refer to an extended feeding trial with milch cows, conducted by Professor Woll at the Wisconsin Station in 1891.

Corresponding rows of a large corn field were siloed, "ears and all," and without ears, the ears belonging to the latter lot being carefully saved and air-dried. The total yield of silage with ears in it (whole-corn silage) was 59,495 pounds; of silage without ears (stover silage) 34,496 pounds, and of ear corn, 10,511 pounds. The dry matter content of the lots obtained by the two methods of treatment was, in whole-corn silage, 19,950 pounds; in stover silage, 9,484 pounds, and in ear corn, 9,122 pounds, or 18,606 pounds of dry matter in the stover silage and ear corn combined. This shows a loss of 1,344 pounds of dry matter, or nearly 7 per cent, sustained by handling the fodder and ear corn separately instead of siloing the corn "ears and all."

In feeding the two kinds of silage against each other, adding the dry ear corn to the stover silage, it was found that seventeen tons of whole-corn silage fed to sixteen cows produced somewhat better results than fourteen tons of stover silage, and more than two tons of dry ear corn, both kinds of silage having been supplemented by the same quantities of hay and grain feed. The yield of milk from the cows was 4 per cent higher on the whole corn silage ration than on the stover silage ration, and the yield of fat was 6.9 per cent higher on the same ration. It would seem then that the cheapest and best way of preserving the corn crop for feeding purposes, at least in case of milch cows, is to fill it directly into the silo; the greater portion of the corn may be cut and siloed when the corn is in the roasting-ear stage, and the corn plat which is to furnish ear corn may be left in the field

until the corn is fully matured, when it may be husked, and the stalks and leaves may be filled into the silo on top of the corn siloed "ears and all." This will then need some heavy weighting or one or two applications of water on top of the corn, to insure a good quality of silage from the dry stalks. (See pages 175 and 185.)

An experiment similar to the preceding one, conducted at the Vermont Station, in which the product from six acres of land was fed to dairy cows, gave similar results. We are justified in concluding, therefore, that husking, shelling, and grinding the corn (processes that may cost more than a quarter of the market value of the meal) are labor and expense more than wasted, since the cows do better on the corn siloed "ears and all" than on that siloed after the ears were picked off and fed ground with it.

Table XIII.—Yield of Digestible Matter in Corn.

CONSTITUENT	YIELD PER ACRE		
	Ears	Stover	Total Crop
	Pounds.	Pounds.	Pounds.
Protein	244	83	327
Carbohydrates	2,301	1,473	3,774
Fat	125	22	147
Total	2,670	1,578	4,248

The difference in the feeding value of the corn plant when siloed with and without ears is well illustrated in Table XIII. presented by the Pennsylvania State College, which shows that 63 per cent. of the digestible food materials present in the corn plant are found in the ears and 37 per cent. in the stover.

The Filling Process.

The corn, having been hauled from the field to the silo, has still to be reduced to a fine, homogeneous mass, so that it will pack well in the silo and will be convenient for feeding.

In order to do this, the whole of the corn, ears and all, may be run through a Silver's "Ohio" Silage Cutter.

The corn is unloaded on the self-feed table of the cutter and run through the machine, after which the carrier or blower elevates it and delivers it into the silo.

By far the easiest method of unloading is to drive across the end of the traveling feed table as shown in the illustration Fig. 55. This brings the bundles into proper position for the feeder to simply slide them endwise onto the feed table requiring little or no lifting. By starting at the front of load and moving up as the unloading proceeds one man can handle the work very much quicker in this way and with far less labor, and two men can also work to advantage if desired. This method of feeding should be practiced wherever the setting of cutter or engine permits driving the machine from the opposite or front end. Its labor-saving advantages will be readily seen when contrasted with the plan of feeding from the side of cutter as shown in Fig. 49, page 107, where the entire weight of each load, perhaps one to two tons, is lifted waist-high and thrown forward.

To secure best results from the standpoint of both men and equipment, regular steady feeding should be practiced at all times. A little judgment used at this point in properly lapping the bundles so as to keep up a constant and uniform supply will not only produce larger capacity but will relieve the heavy uneven strain to which a silage cutter is usually subjected.



Fig. 55.—Showing one of easiest methods of unloading corn at cutter.

The length of cutting practiced differs somewhat with different farmers and with the variety of corn to be siloed. Care should be taken in this respect, however, for the length of cut has much to do with the quality of the silage. Experience has demonstrated that the half inch cut, or even shorter, gives most satisfactory results. The corn will pack and settle better in the silo, the finer it is cut, thus better excluding the air and at the same time increasing the capacity of the silo, some say 20 to 25 per cent. Cattle will also eat the larger varieties cleaner if cut fine, and the majority of farmers filling silos now practice such cutting.

The cut ensilage should be directed to the outer edge of the silo at all times, thus keeping it high and packing it there, letting the center take care of itself. The weight of the silage packs it in the center.

If the corn is siloed "ears and all," it is necessary to keep a man or boy in the silo while it is being filled, to level the surface and tramp down the sides and corners; if left to itself, the heavier pieces of ears will be thrown farthest away and the light leaves and tops will all come nearest the discharge; as a result the corn will not settle evenly, and the different layers of silage will have a different feeding value. Several simple devices, such as funnel-shaped hoppers, adjustable board suspended from roof, etc., will suggest themselves for receiving the silage from the carrier and directing it where desired in the silo. With the blower machines, the new flexible silo tube, shown in the back of this book, is a most happy solution of an otherwise disagreeable job. At the same time it insures perfectly equal distribution of the cut feed; the leaves, moisture and heavier parts being always uniformly mixed as cut.

The Proper Distribution of the Cut Material in the Silo.

The proper distribution of the cut corn after it has been elevated or blown into the silo is a matter which should have proper attention at the time of filling. If the cut material is allowed to drop all in one place and then have no further attention the constant falling of the material in one place will tend to make that portion solid while the outside will not be so and besides the pieces of ears and heavier portions will continually roll to the outside. As a result the silage cannot settle evenly, and good

results will not follow. As the filling progresses, the cut material should be leveled off and the common and most successful practice is to keep the material higher at the sides than at the center and do all the tramping at and close to the sides, where the friction of the walls tends to prevent as rapid settling as takes place at the center. In modern deep silos, the weight of the silage accomplishes more than would any amount of tramping, and all that is necessary, is to see that the cut material is rather evenly distributed, for better results in feeding, and to assist the settling by some tramping at the sides. With the new silo tube, this distribution is really reduced to the mere guiding of the mouth of the tube by hand.

Tramping.

Always bear in mind that the more thoroughly the air is excluded, the better will be the silage. This is accomplished by adding water if the crop is over ripe and by a thorough tramping as the silo is being filled. Pay especial attention to the edges. If you have spoiled silage around the edges of a good silo it is because it was not tramped sufficiently at this point. Keep one or two men tramping continually at the extreme edges close to the walls of the silo. A little more trouble and expense in proper tramping will save much spoiled silage. Tramp the edges.

Size of Cutter and Power Required.

The cutter used in filling the silo should have ample capacity to give satisfaction and do the work rapidly; a rather large cutter is therefore better than a cutter that is barely large enough. The size required depends on the rapidity with which it is desired to fill the silo and on the power at hand. Where a steam engine is available it is the cheapest power for filling large silos, as the work can then be finished very rapidly. For small farms and silos, the gasoline engine has rapidly replaced the two or three horse tread powers formerly popular for carrier machines, and the gasoline tractors of 12 to 25 horse are now used to a considerable extent for blower machines. Ordinary steam threshing engines will still be found most dependable, however. The filling may be done as rapidly as possible, or may be done slowly, and

no harm will result, if for any reason the work be interrupted for some time. More silage can be put into a silo with slow, than with rapid filling. If the farmer owns his own machine, he can, of course, fill his silo and then refill after the silage has settled, so that the silo will be nearly full after all settling has taken place.

If, however, the farmer must depend on hiring an outfit, he will wish to do the filling as rapidly as possible, as a matter of economy, and will, therefore, seek the largest possible capacity.

It is important to be able to get an outfit when it is needed. An early frost or a spell of hot, dry weather may so affect the crop that it is necessary to fill the silo several days before the usual time. For this reason a man should own his own cutter and engine, especially if he cuts enough silage each year to warrant the expenditure. Usually it is easier to hire an engine than a cutter. Many find it wise, therefore, to buy the latter and depend on being able to rent the former when it is needed. Where individual ownership is not possible, the next best move is for two or three neighbors to purchase the necessary machinery in partnership.

The size of the cutter to purchase depends also on how it is to be used. For private use, when the silo is not large, a small silo filler will suffice; for a neighborhood machine where two or three farmers combine, a larger size will be desirable; in either case if the silos are of large size or the cutter is to be used for jobbing work at other farms the larger sizes will certainly prove more profitable. In some sections, community cutters have become popular where from eight to fifteen farmers purchase complete equipment for their own use. With fifteen or twenty men and several teams on the job there is always friendly rivalry as to the size of loads, speed in unloading, etc., and periodic efforts to choke or stall the cutter are sure to result. It's a special feature of the game that should be considered and only the largest capacity cutter should be selected in such cases if supreme satisfaction is desired.

These conditions have created a demand for various sizes of cutters, and to meet this demand Silver's "Ohio" Silage Cutters are made in six sizes, Nos. 11, 12, 15, 17, 19 and 22 (the number of the machine indicates the length of knives and width

of throat), and equipped with metal bucket elevators or blower elevators as desired, adaptable to any height of silo. The blower machines require more power to operate successfully than do the carrier machines, although the largest sizes can be run by an ordinary threshing engine. The traveling feed table and the bull dog grip feed rolls are valuable features and practically do away with the labor of feeding the heavy green corn, besides increasing the capacity of the machines about one-third, on account of its being so much easier to get a large amount of material past the feed rolls. These machines have been on the market for upwards of twenty-five years, and have been brought to a wonderful state of perfection. For durability, ease and reliability of operation, capacity and general utility, they are doubtless the most practical means of filling the silo.

The Metal Bucket Elevator is the older style of elevator. It delivers the cut silage corn into the silo through a window or opening at the top and must be longer than the silo is high as it is necessary to run the carrier at somewhat of an angle. The length of the carrier required may be obtained by adding about 40 per cent. to the perpendicular height from the ground to the window; thus for a 20 ft. silo a 28 ft. carrier is required, and for a 30 ft. silo, about 42 ft. of carrier will be necessary.

The Metal Bucket Elevators for Silver's "Ohio" Silage Cutters are made both straight away and with swivel base, which enables the operator to set the cutter in the desired position, and as the swivel base gives the carrier a range of adjustment extending over nearly a half circle, the carrier can be run directly to the window, or in the case of two silos setting side by side, both can be filled with one setting of the cutter.

The Nos. 15, 17 and 19 Silver's "Ohio" Silage Cutters are the sizes most in use by farmers, stockmen and dairymen. The traveling feed table, first adopted by the "Ohio," which is long enough to receive a bundle of corn is a most valuable feature and has become almost universal on the "Ohio" machines used for silo filling. It decreases the labor of feeding and makes any size of machine about equal in capacity to the next size larger without it.

The newer and more modern method of elevating fodder in filling silos, is the use of the Blower Elevator which blows the

cut fodder into the silo through a continuous pipe. Blower Elevators (see illustration of Silver's "Ohio" Blower Cutter, Fig. 53) have been in use to an increasing extent for several years, and today there is absolutely no doubt as to their superiority for elevating the material. Where sufficient power is available there is no difficulty in elevating the cut fodder into the highest silos.

Although the Blower Machines require somewhat more power than the old style Carrier, they have numerous advantages over the latter, and the majority of machines now being sold are equipped with Blowers. We mention below some of the features that have served to bring Silver's "Ohio" Monarch Blowers to the notice and favor of farmers and dairymen so rapidly.

The Blower Machine is quickly set up, taken down or moved, as all that is necessary is to remove the pipe, (which is in sec-



Fig. 53.—Shows Silver's No. 19 "Ohio" Monarch Self Feeder Blower Silage Cutter filling a group of five silos, owned by S. M. Shoemaker, Burnside, P. O., Eccleston, Md. The machine had just completed storing 1700 tons of silage.

tions of various lengths from four to ten feet as desired), which requires but a few moments. This operation requires but little time as compared with that occupied in setting up or taking apart the chain elevator.

The Blower Machine is clean in operation, placing all of the corn in the silo and there is no litter around the machine when the filling is finished.

The action of the fan paddles is such that the corn is made much finer and it therefore packs closer in the silo, thus enabling more fodder to be stored in the silo; the corn is all knocked off of the pieces of cobs and distributed through the cut fodder better, and the pieces of the heavy butts and joints are also split and knocked to pieces, all of which reduces the silage to a fine condition so that it is eaten up cleaner by the stock.

The fan or blower device is also likely to be more durable than the chain elevator.

The "Ohio" direct drive construction with pulley, knife cylinder and fan all on main shaft, is unique among silage cutters and is thoroughly covered by patents. Its large fan permits full capacity at low speed so that it never explodes or blows up. The feeding mechanism can be started, stopped or reversed with a single lever. The reverse is entirely by wood friction. There is not the slightest strain on the machine; not a gear tooth changes mesh. The machine cuts all kinds of fodder from $\frac{1}{4}$ to 4 inch lengths as desired, with a perfectly adjusted shear cut.

Many have been skeptical as to the ability of the Blower to elevate the material as rapidly as the "Ohio" Machines cut it. This proposition, however, has been proven entirely feasible and successful, and there positively need be no fear on this point if the following points are kept in mind.

The machine must be run at the proper speed as recommended by the manufacturers. A fan can only create a sufficient blast by running fast enough to force the air through the pipe at the rate of nine or ten thousand feet per minute. Green corn is heavy stuff and requires a strong current of air to carry it through 50 or 40 feet of pipe at the rate of 10 to 50 tons per hour. It will be seen, therefore, that unless proper speed be maintained there will be no elevation of the material whatever. If the power at hand is not sufficient to maintain full speed when

the cutters are fed to full capacity, all that is necessary is to feed the machine accordingly, in other words, to cut down the capacity to the point where full speed can be maintained, as is necessary with other kinds of machinery, such as threshing machines, grinding mills, etc.

In setting a Blower Machine it is necessary to have the pipe as nearly perpendicular as possible, so that the current of air within the pipe will lift the material. This is especially true where the pipe is long, say 20 feet or more, because the green fodder being heavy will settle down on to the lower side of the pipe, if this has much slant, and the wind blast will pass over the fodder, thus allowing it to lodge, whereas if the pipe be perpendicular, or nearly so, no stoppage will occur. It is also necessary to see that full speed is attained before beginning to feed the machine, and also to stop the feeding while the machine is in full motion so that the Blower will have an opportunity to clear itself before shutting off the power.

There must be ample vent in the silo to prevent back pressure, as the tremendous volume of air forced into the silo with the cut fodder must have some means of escape.

If these few points are kept in mind, there can be no possible doubt as to the successful operation of the Blower Elevator; and, as previously stated, there is absolutely no doubt as to their superiority for elevating silage. Scores of Silver's "Ohio" Blower Machines are in successful use in all parts of the country.

(N. B. At the end of this volume will be found illustrations and descriptions of several sizes and styles of Silver's "Ohio" Silage Cutters, which the reader can refer to, in addition to the illustration given here.)

Danger from Carbonic-Acid Poisoning in Silos.—As soon as the corn in the silo begins to heat, carbonic-acid gas is evolved, and if the silo is shut up tight the gas will gradually accumulate directly above the fodder, since it is heavier than air and does not mix with it under the conditions given. If a man or an animal goes down into this atmosphere, there is great danger of asphyxiation, as is the case under similar conditions in a deep cistern or well. Poisoning cases from this cause have occurred in filling silos where the filling has been interrupted for one or more days, and men have then gone into the silo to tramp

down the cut corn. If the doors above the siloed mass are left open when the filling is stopped, and the silo thus ventilated, carbonic acid poisoning cannot take place, since the gas will then slowly diffuse into the air. Carbonic acid being without odor or color, to all appearances like ordinary air, it cannot be directly observed, but may be readily detected by means of a lighted lantern or candle. If the light goes out when lowered into the silo there is an accumulation of carbonic acid in it, and a person should open feed doors and fan the air in the silo before going down into it.

After the silage is made and the temperature in the silo has gone down considerably, there is no further evolution of carbonic acid, and therefore no danger in entering the silo even if this has been shut up tight. The maximum evolution of carbonic acid, and consequently the danger of carbonic-acid poisoning comes during or directly after the filling of the silo.

Covering the Siloed Fodder.

Many devices for covering the siloed fodder have been recommended and tried, with varying success. The original method was to put boards on top of the fodder, and to weight them heavily by means of a foot layer of dirt or sand, or with stone. The weighting having later on been done away with, lighter material, as straw, hay, sawdust, etc., was substituted for the stone or sand. Building paper was often placed over the fodder, and boards on top of the paper. There is no special advantage derived from the use of building-paper, and it is now never used. Many farmers run some corn stalks, or green husked fodder, through the cutter after the fodder is all in. In the South, cotton-seed hulls are easily obtained, and form a cheap and most efficient cover.

None of these materials or any other recommended for the purpose can perfectly preserve the uppermost layer of silage, some four to six inches of the top layer being usually spoiled. Occasionally this spoiled silage may not be so bad but that cattle or hogs will eat it up nearly clean, but it is at best very poor food and should not be used by any farmer who cares for the quality of his products. The wet or green materials are better

for cover than dry substances, since they prevent evaporation of water from the top layer; when this is dry air will be admitted to the fodder below, thus making it possible for putrefactive bacteria and molds to continue the destructive work begun by the fermentation bacteria, and causing more of the silage to spoil.

Silage will settle several feet in an ordinary silo. If possible, after filling the silo full, let it settle for three or four days, and then fill again to the top, wetting the top on each occasion with about one and one-half gallons of water to every square foot of surface. After your silo has been filled and the top thoroughly wet, leave it alone. Do not get on top of it, and do not dig down through the top to examine it. The more this is done, the more silage you will lose.

Use of Water in Filling Silos.—During late years the practice of applying water to the fodder in the silo has been followed in a large number of cases. The surface is tramped thoroughly and a considerable amount of water added. In applying the method at the Wisconsin Station, Prof. King, a few days after the completion of the filling of the silo, added water to the fodder corn at the rate of about ten pounds per square foot of surface, repeating the same process about ten days afterwards. By this method a sticky, almost impervious layer of rotten silage, a couple of inches thick, will form on the top, which will prevent evaporation of water from the corn below, and will preserve all but a few inches at the top. The method can be recommended in cases where the corn or clover goes into the silo in a rather dry condition, on account of drouth or extreme hot weather, so as not to pack sufficiently by its own weight. While weighting of the siloed fodder has long since been done away with, it may still prove advantageous to resort to it where very dry fodder is siloed, or in case of shallow silos. Under ordinary conditions neither weighting nor application of water should be necessary, but where the corn has become too mature and dried up, on account of drouth, or delay in building the silo, it is a great relief to know that good silage can be made from such corn by an application of considerable water. Water is now generally added by running a stream into the blower as the cut corn is elevated into the silo or in the silo itself after each

load or half day's run. Frosted corn can also be made into a good quality of silage if a liberal amount of water is added as directed.

There is only one way in which all of the silage can be preserved intact, viz., by beginning to feed it within a few days after the silo has been filled. This method is now practiced by many farmers, especially dairymen, who in this manner supplement scant fall pastures.

By beginning to feed at once from the silo, the siloing system is brought to perfection, provided the silo structure is air-tight, and constructed so as to admit of no unnecessary losses of nutrients. Under these conditions there is a very considerable saving of food materials over silage made in poorly constructed silos, or over field-cured shocked fodder corn, as we have already seen.

Freezing of Silage.

Freezing of silage has sometimes been a source of annoyance and loss to farmers in Northern states, and in the future, with the progress of the stave silo, we shall most likely hear more about frozen silage than we have in the past. As stated in the discussion of the stave silo, however, the freezing of silage must be considered an inconvenience rather than a positive detriment; when the silage is thawed out it is eaten with the same relish by stock as is silage that has never been frozen, and apparently with equally good results. If frozen silage is not fed out directly after thawed it will spoil and soon become unfit to be used for cattle food; thawed silage will spoil much sooner than ordinary silage that has not been frozen and thawed out. There is no evidence that silage which has been frozen and slowly thawed out is less palatable or nutritious than silage of the same kind which has been kept free from frost.

Frozen silage should be avoided, not because it is unwholesome, but because it is too cold. The warmer the silage can be kept the more palatable it will be and the less energy will be required to raise it to the body temperature of the animals. Frozen silage also has a tendency to make the cows laxative, but not overmuch. It does not seem to bring down the milk flow as might be supposed. Sheep seem to be affected more read-

ily than cattle by eating it and they are also more susceptible to the effects of moldy or spoiled silage.

"Freezing of silage," says Iowa State College Bulletin No. 100, "is due to loss of heat; first, through the silo wall; and second, to the air in contact with the feeding surface.

"It may be impartially said that, as far as the prevention of freezing is concerned, the stave, stone, single wall brick and concrete silos are of about equal merit.

"The second cause of freezing mentioned, that is, the loss of heat from the silage surface, is too often the cause of unnecessary freezing. If air above the silage is confined, no serious loss of heat can possibly take place. When the top of the silo is open and a free circulation of air permitted, it is almost impossible to prevent the surface from freezing in severe weather. A personal investigation of silos in cold weather proved conclusively that those provided with a tight roof did not contain nearly as much frozen silage as those left open."

The difficulty of the freezing of the silage may be avoided by checking the ventilation in the silo and by leaving the door to the silo carefully closed in severe weather. If the top layer of silage freezes some of the warm silage may be mixed with the frozen silage an hour or two before feeding time, and all the silage will then be found in good condition when fed out. A layer of straw may be kept as a cover over the silage; this will prevent it from freezing, and is easily cleared off when silage is to be taken out.

Covering over the exposed surface of the silage with old blankets or hanging a lantern in the silo are other methods of keeping out the frost.

Silage from Frosted Corn.

Experiments were conducted at the Vermont Station in October, 1906, with immature corn, mature corn not frosted, and mature corn frosted hard or frozen and the leaves whitened. No ill results were noticeable in the butter product. It was found that "the effect of frosting corn, and still more of freezing it, appears very slightly to have been to depress its feeding value

when made into silage." The testimony seemed in favor of running frost risks in order to gain a greater maturity, rather than to silo the immature product.

Steamed Silage.

While fermentation in silage causes a small unavoidable loss, it develops flavors and softens the plant tissue. Excessive fermentation causes high acid. Steam has been used with much success to check it in such cases, says Farmer's Bulletin No. 316. It is piped at the bottom and middle of the silo until the whole mass is hot.

Steaming seems beneficial and silage so treated is considered much better than that which is not steamed. Stall fed animals have eaten from 50 to 75 lbs. of silage per day, but the safer method is to feed less than 50 lbs. per day.

CHAPTER X.

HOW TO FEED SILAGE.

Silage is eaten with a relish by all kinds of farm animals, dairy and beef cattle, horses, mules, sheep, goats, swine, and even poultry. It should never be fed as sole roughage to any one of these classes of stock, however, but always in connection with some dry roughage. The nearer maturity the corn is when cut for the silo the more silage may safely be fed at a time, but it is always well to avoid feeding it excessively.

The silo should always be emptied from the top in horizontal layers, and the surface kept level, so as to expose as little silage as possible to the air. It should be fed out sufficiently rapidly to avoid spoiling of the silage; in ordinary northern winter weather a layer a couple of inches deep should be fed off daily.

Silage for Milch Cows.

Silage is **par excellence** a cow feed, says Prof. Woll in his Book on Silage. Since the introduction of the silo in this country, the dairymen, more than any other class of farmers, have been among the most enthusiastic siloists, and up to the present time a larger number of silos are found in dairy districts than in any other regions where animal husbandry is a prominent industry. As with other farm animals, cows fed silage should receive other roughage in the shape of corn stalks, hay, etc. The quantities of silage fed should not exceed forty, or at outside, fifty pounds per day per head. It is possible that a maximum allowance of only 25 or 30 pounds per head daily is to be preferred where the keeping quality of the milk is an important consideration, especially if the silage was made from somewhat immature corn. The silage may be given in one or two feeds daily, and, in case of milch cows **always after** milking, and not before or during same, as the peculiar silage odor may, in the latter case, reappear in the milk. (See below.)

Silage exerts a very beneficial influence on the secretion of milk. Where winter dairying is practiced, cows will usually

drop considerably in milk toward spring, if fed on dry feed, causing a loss of milk through the whole remaining portion of the lactation period. If silage is fed there will be no such marked decrease in the flow of milk before turning out to grass, and the cows will be able to keep up well in milk until late in summer,



Fig. 54.—Silage Truck Designed for carting silage from the silo to the feeding alley. Smooth rounded corners inside. Saves time, labor and silage.

The overhead carrier is also used to some extent for the same purpose.

or early in the fall, when they are dried up prior to calving. Silage has a similar effect on the milk secretion as green fodder or pasture, and if made from well-matured corn, is more like these feeds than any other feed the farmer can produce.

The feeding of silage to milch cows has sometimes been objected to when the milk was intended for the manufacture of certain kinds of cheese, or of condensed milk, and there are instances where such factories have enjoined their patrons from feeding silage to their cows. When the latter is properly prepared and properly fed, there can be no foundation whatever for this injunction; it has been repeatedly demonstrated that Swiss cheese of superior quality can be made from the milk of silage-fed cows, and condensing factories whose patrons are feeding silage have been able to manufacture a superior product. The quality of the silage made during the first dozen years of silo

experience in this country was very poor, being sour and often spoilt in large quantities, and, what may have been still more important, it was sometimes fed in an injudicious manner, cattle being made to subsist on this feed as sole roughage. Under these conditions it is only natural that the quality of the milk should be impaired, and that manufacturers preferred to entirely prohibit the use of it rather than to teach their patrons to follow proper methods in the making and feeding of silage. There is an abundance of evidence at hand showing that good silage fed in moderate quantities will produce an excellent quality of both butter and cheese. According to the testimony of butter experts, silage not only does not injure the flavor of butter, but better-flavored butter is produced by judicious silage feeding than can be made from dry feed.

Silage in the production of "certified milk."—In answer to the question whether there is any objection made to the milk when the cows are fed silage, Mr. H. B. Gurler, the well-known Illinois dairyman, whose certified milk sent to the Paris Exposition in 1900, kept sweet for one month without having any preservatives added to it, and was awarded a gold medal, gave the following information: "No, there is not. I have had persons who knew I was feeding silage imagine they could taste it. I caught one of the leading Chicago doctors a while ago. He imagined that he could taste silage in the milk, and I was not feeding it at all. When I first went into the business I did not feed any silage to the cows from which the certified milk was produced. I knew it was all right for butter making, as I had made butter from the milk of the cows fed with silage, and sent it to New York in competition with butter made from dry food, and it proved to be the finer butter of the two. The first winter I had samples sent down to my family in DeKalb from the stable where we fed silage and from the stable where we were making the certified milk for Chicago, and in which we fed no silage. I presume I made one hundred comparative tests that winter of the milk from these two stables. My wife and daughter could not tell the difference between the two samples. In the large majority of cases they would select the milk from the cows fed silage as the sweeter milk."

It will serve as an illustration of the general use of silage among progressive dairymen in our country, to state that of

one hundred farmers furnishing the feed rations fed to their dairy cows, in an investigation of this subject conducted by Prof. Woll in 1894, sixty-four were feeding silage to their stock, this feed being used a larger number of times than any other single cattle food, wheat bran only excepted.

An interesting experiment as to the effect of silage on milk was conducted by the Illinois Station, where a herd of 40 cows was divided, one lot being fed 40 lbs. of silage a day, the other clover hay and grain. Samples of milk were submitted to 372 persons for an opinion. Sixty per cent preferred the silage-fed milk, 29 per cent non-silage-fed milk, while 11 per cent had no choice. They were able to distinguish between the two kinds, but found nothing objectionable about either. The summary of the test was that when silage imparts a bad or disagreeable flavor to milk produced from it, almost invariably the cause is that the silage has not been fed properly, or that spoiled silage has been used.

It has been contended that the acetic acid in silage has a tendency to make milk sour more quickly. A user of silage for 14 years took a gallon of milk from a cow fed silage for 42 days and a gallon from another that had received no silage and set them side by side in a room having a temperature of 40 degrees. Both gallons of milk began to sour at the same time.

The combination in which corn silage will be used in feeding milch cows will depend a good deal on local conditions; it may be said in general that it should be supplemented by a fair proportion of nitrogenous feeds like clover hay, wheat bran, ground oats, linseed meal, gluten feed, cotton-seed meal, etc. As it may be of some help to our readers a number of balanced rations or such as are near enough balanced to produce good results at the pail, are presented below.

Silage Rations for Milch Cows.

No. 1. Corn silage, 35 lbs.; hay, 8 lbs.; wheat bran, 4 lbs.; ground oats, 3 lbs.; oil meal, 2 lbs.

No. 2. Corn silage, 50 lbs.; corn stalks, 10 lbs.; corn meal, 2 lbs.; wheat bran, 4 lbs.; malt sprouts, 3 lbs.; oil meal, 1 lb.

- No. 3. Corn silage, 40 lbs.; clover and timothy mixed, 10 lbs.; wheat shorts, 3 lbs.; gluten feed, 3 lbs.; corn and cob meal, 3 lbs.
- No. 4. Corn silage, 20 lbs.; corn stalks, 10 lbs.; hay, 4 lbs.; wheat bran, 4 lbs.; gluten meal, 3 lbs.; ground oats, 3 lbs.
- No. 5. Corn silage, 40 lbs.; clover hay, 10 lbs.; oat feed, 4 lbs.; corn meal, 3 lbs.; gluten feed, 3 lbs.
- No. 6. Corn silage, 45 lbs.; corn stalks, 5 lbs.; oat straw, 5 lbs.; dried brewers' grains, 4 lbs.; wheat shorts, 4 lbs.
- No. 7. Corn silage, 35 lbs.; hay, 10 lbs.; corn meal, 3 lbs.; wheat bran, 4 lbs.; oats, 3 lbs.
- No. 8. Corn silage, 40 lbs.; corn stover, 8 lbs.; wheat bran, 4 lbs.; gluten meal, 2 lbs.; oil meal, 2 lbs.
- No. 9. Corn silage, 20 lbs.; clover and timothy hay, 15 lbs.; corn meal, 3 lbs.; ground oats, 3 lbs.; oil meal, 2 lbs.; cotton seed meal, 1 lb.
- No. 10. Clover silage, 25 lbs.; corn stover, 10 lbs.; hay, 5 lbs.; wheat shorts, 2 lbs.; oat feed, 4 lbs.; corn meal, 2 lbs.
- No. 11. Clover silage, 30 lbs.; dry fodder corn, 10 lbs.; oat straw, 4 lbs.; wheat bran, 4 lbs.; malt sprouts, 2 lbs.; oil meal, 2 lbs.
- No. 12. Clover silage, 40 lbs.; hay, 10 lbs.; roots, 20 lbs.; corn meal, 4 lbs.; ground oats, 4 lbs.

The preceding rations are only intended as approximate guides in feeding dairy cows. Every dairy farmer knows that there are hardly two cows that will act in exactly the same manner and will need exactly the same amount of feed. It is important, therefore, to adapt the quantities and kinds of feed given to the special needs of the different cows; one cow will fatten on corn meal, where another will be able to eat and make good use of two or three quarts of it. In the same way some cows will eat more roughage than others and do equally well as those that get more of the food in the form of more concentrated and highly digestible feeding stuffs. The only safe rule to go by is to feed according to the needs of the different cows; to study each cow and find out how much food she can take care of without laying on flesh, and how she responds to the feeding of foods of different character, like wheat bran and corn meal, for instance.

The specimen rations given in the preceding can, therefore, only be used to show the average amount of common feeds which a good dairy cow can take in and give proper returns for.

The popularity of the silo with owners of dairy cattle has increased very greatly, says Prof. Plumb. Few owners of stock of this class, who have properly-built silos, and well preserved silage, would discard silage as an adjunct to feeding. Silage certainly promotes milk flow. One great argument in favor of its use lies in the cheapness of production per ton, and the ability to store and secure a palatable, nutritious food in weather conditions that would seriously injure hay or dry fodder.

There is one important point that dairy farmers should bear in mind, viz., when the silo is first opened only a small feed should be given at first. In changing from grass or dry feed to silage, if a regular full ration is given, the silage will perhaps slightly affect the taste of the milk for a few milkings, and if the change is from dry feed it may cause too great activity of the bowels.

Silage for Beef Cattle.

Prof. Henry says in regard to the value of silage for fattening steers: "As with roots, silage makes the carcass watery and soft to the touch. Some have considered this a disadvantage, but is it not a desirable condition in the fattening steer? Corn and roughage produce a hard dry carcass, and corn burns out the digestive tract in the shortest possible time. With silage and roots, digestion certainly must be more nearly normal, and its profitable action longer continued. The tissues of the body are juicy, and the whole system must be in just that condition which permits rapid fattening."

Young stock may be fed half as much silage as full grown ones, with the same restrictions and precautions as given for steers. Experience obtained at the Kansas Station suggests that corn silage is not a fit food for breeding bulls, unless fed a few pounds only as a relish; fed heavily on silage, bulls are said to lose virility and become slow and uncertain breeders.

Fuller information on this subject is given in Chapter V of this book, entitled, "The Use of Silage in Beef Production."

Silage for Horses.

Silage has been fed to horses and colts for a number of years with excellent results. These points should be kept in mind however: Never feed moldy silage; it is poisonous to horses. Avoid sour silage made from immature corn. Feed regularly, once or twice a day, starting in with a light feed and gradually increasing as the animals become accustomed to the food.

The succulence of silage produces as good an effect on horses in the winter months as do the fresh spring pastures. Some farmers feed it mixed with cut straw, two thirds of straw and one-third of silage, and feed all the horses will eat of this mixed feed. Some horses object to silage at first on account of its peculiar odor, but by sprinkling some oats or bran on top of the silage and feeding only very small amounts to begin with, they soon learn to eat and relish it. Other horses take it willingly from the beginning. Horses not working may be fed larger quantities than work horses, but in neither case should the silage form more than a portion of the coarse feed given the horses. Silage-fed horses will look well and come out in the spring in better condition than when fed almost any other food.

Professor Cook says in regard to silage as a horse food: "It has been suggested by even men of high scientific attainments that silage is pre-eminently the food for cattle and not for other farm stock. This is certainly a mistake. If we raise fall colts, which I find very profitable, then silage is just what we need, and will enable us to produce colts as excellent as though dropped in the spring. This gives us our brood mares in first-class trim for the hard summer's work. I find silage just as good for young colts and other horses."

An extensive Michigan farmer and horse breeder gives his experience in regard to silage for horses as follows:

"Last year we had nearly two hundred horses, including Clydesdales, standard-bred trotters, and Shetland ponies. They were wintered entirely upon straw and corn silage, and this in face of the fact that I had read a long article in a prominent horse journal cautioning farmers from the use of silage, and citing instances where many animals had died, and brood mares had aborted from the liberal use of corn silage.

"Desiring to test the matter to the fullest extent, our stallions and brood mares, as well as all the young stock, we fed two full rations of silage daily, and one liberal ration of wheat or oat straw. The result with our brood mares was most phenomenal, for we now have to represent every mare that was in foal on the farm a weanling, strong and vigorous, and apparently right in every way, with only one exception, where the colt was lost by accident. Of course there may have been something in the season more favorable than usual, but this was the first year in my experience when every colt dropped on the farm was saved."

The following experience as to the value of silage as a food for horses and other farm animals comes from the Ohio Station: "Our silo was planned and filled with special reference to our dairy stock, but after opening the silo we decided to try feeding the silage to our horses, calves and hogs. The result was eminently satisfactory. We did not find a cow, calf, horse, colt, or hog that refused to eat, or that did not eat it with apparent relish, not only for a few days, but for full two months. The horses were given one feed of twenty pounds each per day in place of the usual amount of hay, for the period above named, and it was certainly a benefit. Their appetites were sharpened, and the healthfulness of the food was further manifest in the new coat of hair which came with the usual spring shedding. The coat was glossy, the skin loose, and the general appearance was that of horses running upon pasture."

Many letters have appeared in Breeders' Gazette on this subject. An Iowa writer, A. L. Mason, states that he has fed silage to horses for seven winters with no injurious effects. He fed once a day, from 20 to 40 pounds according to size of horse and 10 pounds to suckling colts. Another Iowa writer, F. A. Huddlestun, after five years' feeding, to stallions, mares in foal and colts, reports excellent results. He says: "I am now wintering 20 draft brood mares outdoors and their ration is 20 pounds silage once a day, five ears corn twice a day, and some tame hay in the rack. I have never seen any that looked better." Geo. McLeod, of Iowa, writes: "We keep about 50 horses and all are fed silage. The work horses are each fed a bushel basketful and so is the Shire stallion. No bad effects. The boys are careful that no moldy silage goes to the horses." Another writer, B. D. R., says: "I am feeding 9 head, including a registered

stallion, five colts of various ages and three work horses. I give each horse and colt a peck of silage a day." These writers without exception warn against the use of moldy silage.

Mr. P. W. Moir, a well known Iowa breeder of pure bred horses, erected a large silo in 1911 for feeding horses exclusively. As to results he stated that "It has been very satisfactory, as I had the very choicest of silage. We fed it to the brood mares, as well as the colts, and they did fine with it and came out in the spring looking good. Other neighbors around here feed it and I have heard of no bad results. I have broken up one of my pastures, as I can get along without the grass and I expect to have enough corn from this pasture to fill both silos."

Silage for Mules.—What has been said about silage as a food for horses will most likely apply equally well to mules, although only very limited experience has so far been gained with silage for this class of farm animals.

Results of a test made at the N. C. Experiment Station, Raleigh, N. C., showed "that work mules will eat 20 to 30 pounds of corn silage per day and when the ration is properly balanced by the use of other feed-stuffs that 2½ to 3 lbs. of silage could be substituted for 1 lb. of clover hay or cow pea hay. Results show that silage and ear corn or silage or corn and cobmeal is not so satisfactory as silage and a grain ration higher in protein value such as bran, cottonseed meal or oilmeal."

Silage for Sheep.

Despite the popular conception that silage is more or less dangerous to feed to sheep, especially breeding ewes, its great value and entire safety has been demonstrated as a fact by long and careful tests at the experiment stations, notably at the Purdue Station. The evidence is conclusive that from the standpoints of palatability, succulence and economy no other feed can compare with good silage. Succulence, probably the most important element in the winter ration of the breeding ewe, is necessary to secure or maintain the freshness, vigor and health so desirable in the flock.

Though good silage may be a safe and desirable feed, it does not follow that silage which is very acid, spoiled or decomposed,

is not dangerous or even deadly in its effects when fed to lambs. Some time after the close of one of the early experiments at Purdue, four lambs died from the effects, supposedly of eating spoiled silage. The cause was assigned to poisonous products resulting from decomposition of the silage, which was favored by the exposure of the silage to the air in warm weather and the low condition of the silo.

Feeding an abnormal amount of silage, close confinement, lack of exercise and lack of an experienced shepherd to handle the ewes at lambing time often prevent maximum results, and silage feeding has for this reason been unjustly condemned at times.

The Indiana Station has been conducting experiments with feeding silage to pregnant ewes since 1907. A three year experiment was commenced that year with two lots of ewes, one lot being fed silage along with hay and grain and the other lot hay and more grain, but no silage. The silage ration was limited the first year, increased to 4 pounds the second year, and the third year the ewes were given all they could clean up, which was practically 4.6 pounds. Even with this amount no harmful results were observed either in the ewes or the lambs.

The experiment showed that the general thrift and appetite of the silage ewes was superior to that of the lots fed hay and grain alone. The former made each year a larger gain over winter than did those on dry feed. The latter averaged for the three years a gain of 6 pounds, while the silage ewes gained 13.75 pounds, or more than twice as much. Yet the Station Bulletin states definitely that this gain was not mere fat like corn feeding will produce, but that the ewes were in good condition to produce strong, vigorous lambs. It was a noticeable fact, that "right straight through the whole three years, the lambs from the ewes having the succulent feed, i. e., silage, averaged nearly ten per cent. larger at birth. As to the cost of feed, the ration including silage proved the more economical, while more satisfactory results were obtained. The lambs from these two lots of ewes were all fed out for an early market, and those from each lot did equally well, gaining nearly half a pound per day until they were sold."

Prof. King says that the same station has also "tested the value of corn silage for fattening lambs and found that the lambs were very easily kept on feed, made as rapid gains and finished as well

as lambs fed rations not containing silage. The average of three trials at that station showed that there was an average reduction in cost of gain of 61 cents per hundred pounds."

William Foy, of Foy & Townsend, Sycamore, Ill., probably the most extensive silage feeders in the world, feeds 20,000 sheep and lambs a year on his 1400 acre farm. He makes silage his principal feed and uses thousands of tons. Even during the winter of 1910-11, so disastrous in mutton feeding operations, his stock actually paid out. Foy said: "The use of silage last winter averted a loss of approximately \$1 per head on the entire output of our plant; in other words, it earned us that much money. * * * You cannot feed hay to sheep or cattle at \$15 to \$17 a ton. Even if it were possible, that policy would be questionable when a ton of silage produces as many pounds of gain as a ton of hay and costs \$3 to \$4. Weight for weight, I prefer silage, as it is more palatable. With hay at current abnormal prices we would have been forced out of business had silage not been available."

Speaking of the advantages of silage, Mr. Foy says: "It saves one-third of the corn that would be needed if only hay was used as roughage, and obviates the use of hay entirely. The stock is maintained in healthy condition; in fact, I never had a sick sheep or even a lamb while feeding silage. When starting them on it, care is necessary, but once accustomed to the feed, they thrive. I figure at a 10-ton yield the product of an acre of silage to be worth \$50, and allowing \$15 for cost of production we get approximately \$35 out of an acre of corn. What the resultant manure pile is worth, is open to conjecture. I will say, however, that none of mine is for sale, and I could dispose of every pound at \$1 per ton. The principal disadvantage is the lack of finishing quality and extra time needed to get the stock in marketable condition. This can be remedied by using corn or corn meal to put on a hard finish and it is our present practice. Saving one-third the corn is an item not to be sneezed at in these days of big feed bills and narrow margins."

Anthony Gardner of Hutchinson, Kans., one of the largest sheep feeders in the state, says silos are indispensable. He has two concrete silos aggregating 1500 tons capacity and uses silage for sheep exclusively. It not only increases his profits per lamb, but enables him to more than double his operations. During the

winter of 1911-12, Mr. Gardner fattened 10,000 lambs on silage. Without this feed, he states that 4,000 would have been his limit. Aside from this feature the silo saved his corn crop from the hot winds of 1911 and allowed him to make the best use of the kafir he grew that season. Mr. Gardner's feeding operations are on \$100 land—too high-priced for pasturage or range purposes. In the fall of 1910 his silos were filled with corn, and 7,500 lambs were fattened with ensilage and grain. Corn was also the principal crop in 1911, but to test out kafir, he topped off one of the silos with 100 tons of it, and it proved so successful that in 1912 he planted 80 acres to kafir and cow peas sowed together, which on account of the increased bulk is about a third of what it took in acreage to fill with last year's corn crop. Mr. Gardner's silos cost about \$1,000 each, and their owner figures that they cut nearly a third off the cost of his yearly feeding operations. He feeds ordinarily two pounds of silage and 1¼ pounds of grain a day (corn, bran and cottonseed meal) with kafir fodder for roughage.

After marketing his 10,000 lambs early in 1912, he was offered \$6.50 a ton for silage remaining on hand, but instead of selling, he picked up a bunch of 1,800 poorly wintered lambs at low figures which by means of silage he estimated later in the season would bring him a profit of about \$1.50 per head.

Silage is looked upon with great favor among sheep men, says Prof. Woll in his *Book on Silage*; sheep do well on it, and silage-fed ewes drop their lambs in the spring without trouble, the lambs being strong and vigorous. Silage containing a good deal of corn is not well adapted for breeding stock, as it is too fattening; for fattening stock, on the other hand, much corn in the silage is an advantage. Sheep may be fed a couple of pounds of silage a day and not to exceed five or six pounds per head. Prof. Cook reports as follows in regard to the value of silage for sheep: "Formerly I was much troubled to raise lambs from grade Merino ewes. Of late this trouble has almost ceased. Last spring I hardly lost a lamb. While ensilage may not be the entire cause of the change, I believe it is the main cause. It is positively proved that ensilage is a most valuable food material, when properly fed, for all our domestic animals."

Mr. J. M. Turner of Michigan says concerning silage for sheep: "Of late years we have annually put up 3,200 tons of corn ensilage,

and this has been the principal ration of all the live stock at Springdale Farm, our Shropshire sheep having been maintained on a ration of ensilage night and morning, coupled with a small ration of clover hay in the middle of the day. This we found to fully meet the requirements of our flock until after lambing, from which time forward we of course added liberal rations of wheat bran, oats, and old-process linseed meal to the ewes, with a view of increasing their flow of milk and bringing forward the lambs in the most vigorous possible condition. Our flock-master was somewhat anxious until after the lambs dropped, but now that he saved 196 lambs from 122 ewes, his face is wreathed in smiles, and he gives the ensilage system the strongest endorsement."

O. C. Gregg, superintendent of Farmers' Institutes for Minnesota, has been conducting some experiments on feeding silage to sheep. He gives the result in one of our American exchanges as follows:

"The ewes are beautiful to look at, square on the back, bright of eye, active in appearance, and when the time comes for the feeding of silage they are anxious for their feed, and in case there is any lapse in time, they soon make their wants known by bleating about the troughs. The flock has been fed silage and good hay in the morning, with oat hay in reasonable abundance in the afternoon and evening. We have about ninety head of breeding ewes, including the lambs referred to, and they have been fed two grain sacks full of silage each day. This is not by any means heavy feeding, and it might be increased in quantity. This is a matter which we must learn from experience. We have fed the silage with care, not knowing what the results would be if fed heavily."

Silage for Swine.

The testimony concerning the value of silage as a food for swine is conflicting, both favorable and unfavorable reports being at hand. Many farmers have tried feeding it to their hogs, but without success. On the other hand, a number of hog-raisers have had good success with silage, and feed it regularly to their swine. It is possible that the difference in the quality of the silage and of the methods of feeding practiced explain the diversity of opinions formed concerning silage as hog food. Col. F. D. Curtiss, the great

American authority on the swine industry, states that silage is valuable to add to the winter rations of our swine. Mr. J. W. Pierce of Indiana writes in regard to silage for hogs: "We have fed our sows, about twenty-five in number, for four winters, equal parts of ensilage and corn meal put into a cooker, and brought up to a steaming state. It has proved to be very beneficial to them. It keeps up the flow of milk of the sows that are nursing the young, equal to when they are running on clover. We find, too, when the pigs are farrowed, they become more robust, and take to nursing much sooner and better than they did in winters when fed on an exclusively dry diet. We also feed it to our sheep. To sixty head we put out about six bushels of ensilage." Young pigs are exceedingly fond of silage. Feeding experiments conducted at Virginia Experiment Station show that silage is an economical maintenance feed for hogs, when fed in connection with a little corn, but not when fed alone.

In feeding silage to hogs, care should be taken to feed only very little, a pound or so, at the start, mixing it with corn meal, shorts, or other concentrated feeds. The diet of the hog should be largely made up of easily digested grain food; bulky, coarse feeds like silage can only be fed to advantage in small quantities, not to exceed three or four pounds per head per day. As in case of breeding ewes, silage will give good results when fed with care to brood sows, keeping the system in order, and producing a good flow of milk.

Silage for Poultry.

But little experience is at hand as to the use of silage as a poultry food; some farmers, however, are feeding a little silage to their poultry with good success. Only small quantities should, of course, be fed, and it is beneficial as a stimulant and a regulator, as much as food. A poultry raiser writes as follows in *Orange Judd Farmer*, concerning his experience in making and feeding silage to fowls. Devices similar to that here described have repeatedly been explained in the agricultural press: "Clover and corn silage is one of the best winter foods for poultry raisers. Let me tell you how to build four silos for \$1. Buy four coal-oil barrels at the drug store, burn them out on the inside, and take the heads out. Go to the clover field when the second crop of the small June clover is

in bloom, and cut one-half to three-eighths of an inch in length, also one-half ton of sweet corn, and run this through the feed cutter. Put into the barrel a layer of clover, then a layer of corn. Having done this, take a common building jack-screw and press the silage down as firmly as possible. Then put on this a very light sprinkling of pulverized charcoal, and keep on putting in clover and corn until you get the barrel as full as will admit of the cover being put back. After your four barrel silos are filled, roll them out beside the barn, and cover them with horse manure, allowing them to remain there thirty days. Then put them away, covering with cut straw or hay. When the cold, chilling winds of December come, open one of these 'poultrymen's silos,' take about twenty pounds for one hundred hens, add equal parts of potatoes, ground oats, and winter rye, place same in a kettle and bring to a boiling state. Feed warm in the morning and the result will be that you will be enabled to market seven or eight dozen eggs per day from one hundred hens through the winter, when eggs bring good returns."

Additional Testimony as to the Value of Silage.

Corn silage compared with root crops.—Root crops are not grown to any large extent in this country, but occasionally an old-country farmer will grow roots for his stock, because his father did so, and his grandfather and great-grandfather before him. This is what a well-known English writer, H. Henry Rew, says as to the comparative value of roots and silage, from the standpoint of an English farmer:

"The root crop has, for about a century and a half, formed the keystone of arable farming; yet it is the root crop whose position is most boldly challenged by silage. No doubt roots are expensive—say £10 per acre as the cost of producing an ordinary crop of turnips—and precarious, as the experience of the winter of 1887-8 has once more been notably exemplified in many parts of the country. In a suggestive article in the *Farming World Almanac* for 1888, Mr. Primrose McConnell discusses the question: 'Are Turnips a Necessary Crop?' and sums up his answer in the following definite conclusion:

"Everything, in short, is against the use of roots, either as a

cheap and desirable food for any kind of live stock, as a crop suited for the fallow break, which cleans the land at little outlay, or as one which preserves or increases the fertility of the soil.'

"If the growth of turnips is abandoned or restricted, ensilage comes in usually to assist the farmer in supplying their place. * * * When one comes to compare the cultivation of silage crops with that of roots, there are two essential points in favor of the former. One is their smaller expense, and the other is their practical certainty. The farmer who makes silage can make certain of his winter store of food, whereas he who has only his root crop may find himself left in the lurch at a time when there is little chance of making other provision."

We have accurate information as to the yields and cost of production of roots and corn silage in this country from a number of American experiment stations. This shows that the tonnage of green or succulent feed per acre is not materially different in case of the two crops, generally speaking. But when the quantities of dry matter harvested in the crop are considered, the corn has been found to yield about twice as much as the ordinary root crops. According to data published by the Pennsylvania Station, the cost of an acre of beets in the pit amounts to about \$56, and of an acre of corn in the silo about \$21, only half the quantities of food materials obtained, and at more than double the cost.

When the feeding value of these two crops has been compared, as has been the case in numerous trials at experiment stations, it has been found that the dry matter of beets certainly has no higher, and in many cases has been found to have a lower, value than that of corn silage; the general conclusion to be drawn, therefore, is that "beets cost more to grow, harvest and store, yield less per acre, and produce at best no more and no better milk or other farm product than corn silage."

Corn silage compared with hay.—A ton and a half of hay per acre is generally considered a good average crop in humid regions. Since hay contains about 86 per cent. dry matter, a crop of $1\frac{1}{2}$ tons means 2,580 pounds of dry matter. Against this yield we have yields of 5,000 to 9,000 pounds of dry matter, or twice to three and a half times as much, in case of fodder corn. An average crop of green fodder will weigh twelve tons of Northern varie-

ties and eighteen tons of Southern varieties. Estimating the percentage of dry matter in the former at 30 per cent., and in the latter at 20 per cent., we shall have in either case a yield of 7,200 pounds of dry matter. If we allow for 10 per cent. of loss of dry matter in the silo there is still 6,500 pounds of dry matter to be credited to the corn. The expense of growing the corn crop is, of course, higher than that of growing hay, but by no means sufficiently so to offset the larger yields. It is a fact generally conceded by all who have given the subject any study, that the hay crop is the most expensive crop used for the feeding of our farm animals.

The late Sir John B. Lawes, of Rothamsted Experiment Station (England) said, respecting the relative value of hay and (grass) silage: "It is probable that when both (i. e., hay and silage) are of the very best quality that can be made, if part of the grass is cut and placed in the silo, and another part is secured in the stack without rain, one might prove as good food as the other. But it must be borne in mind that while the production of good hay is a matter of uncertainty—from the elements of success being beyond the control of the farmer—good silage, by taking proper precautions, can be made with certainty."

A few feeding experiments with corn silage vs. hay will be mentioned in the following:

In an experiment with milch cows conducted at the New Hampshire Station, the silage ration, containing 16.45 pounds of digestible matter, produced 21.0 pounds of milk, and the hay ration, containing 16.83 pounds digestible matter, produced 18.4 pounds milk; calculating the quantities of milk produced by 100 pounds of digestible matter in either case, we find on the silage ration, 127.7 pounds of milk, on the hay ration, 109.3 pounds, or 17 per cent. in favor of the silage ration.

In a feeding experiment with milch cows at the Maine Station, in which silage likewise was compared with hay, the addition of silage to the ration resulted in a somewhat increased production of milk solids, which was not caused by an increase in the digestible food materials eaten, but which must have been due either to the superior value of the nutrients of the silage over those of the hay or to the general psychological effect of feeding a great variety of foods. 8.8 pounds of silage proved to be somewhat superior

to 1.98 pounds of hay (mostly timothy), the quantity of digestible material being the same in the two cases.

In another experiment, conducted at the same station, where silage was compared with hay for steers, a pound of digestible matter from the corn silage produced somewhat more growth than a pound of digestible matter from timothy hay. The difference was small, however, amounting in the case of the last two periods, where the more accurate comparison is possible, to an increased growth of only 15 pounds of live weight for each ton of silage fed.

Corn silage compared with fodder corn.—The cost of production is the same for the green fodder up to the time of siloing, in case of both systems; as against the expense of siloing the crop comes that of shocking, and later on, placing the fodder under shelter in the field-curing process; further husking, cribbing, and grinding the corn, and cutting the corn stalks, since this is the most economical way of handling the crop, and the only way in which it can be fully utilized so as to be of as great value as possible for dry fodder. Professor King found the cost of placing corn in the silo to be 58.6 cents per ton, on the average for five Wisconsin farms, or, adding to this amount, interest and taxes on the silo investment, and insurance and maintenance of silo per ton, 73.2 cents. The expense of shocking and sheltering the cured fodder, and later cutting the same, will greatly exceed that of siloing the crop; to obtain the full value in feeding the ear corn, it must, furthermore, in most cases, be ground, costing ten cents or more a bushel of 70 lbs. The advantage is, therefore, decidedly with the siloed fodder in economy of handling, as well as in the cost of production.

The comparative feeding value of corn silage and fodder corn has been determined in a large number of trials at different experiment stations. The earlier ones of these experiments were made with only a couple of animals each, and no reliance can, therefore, be placed on the results obtained in any single experiment. In the later experiments a large number of cows have been included, and these have been continued for sufficiently long time to show what the animals could do on each feed.

Comparative Cost of Producing Silage.—The Oregon Agricultural College Bulletin No. 136, comparing the total digestible nutrients of silage with other succulent feeds based largely on figures

from Henry's "Feeds and Feeding" shows that one ton of corn silage is equal to 1.0 ton of artichokes, 1.4 tons of parsnips, 1.5 tons of sugar beets, 1.8 tons of rutabagas, 1.8 tons of carrots, 2.2 tons of turnips, 2.4 tons of mangels, or 2.3 tons of kale. These figures do not take into consideration the palatability or the stimulation on milk secretion that any of these feeds might exert.

Table XIV., compiled by the same station, may be of interest:

Table XIV.—Cost of Production of One Acre of Succulent Crops in Western Oregon.

	Kale.	Roots.	Corn Silage.
Value of manure, at \$1.00 per load.....	\$12.00	\$12.00	\$ 6.00
Applying manure, at 30c per load.....	3.60	3.60	1.80
Double disking75	.75	.75
Plowing	2.00	2.00	2.00
Preparation of Seed Bed.....	1.40	1.40	1.00
Seed25	1.20	.50
Planting	5.00	.50	.50
Cultivation	2.00	7.00	2.00
Harvest—(corn in silo).....	17.50	15.00	10.00
Depreciation and interest on machinery and storage60	.60	3.75
	<u>\$45.10</u>	<u>\$44.05</u>	<u>\$28.30</u>
Average yield per acre (tons).....	25	20	10
Cost per ton.....	\$ 1.80	\$ 2.20	\$ 2.83
Average yield per acre digestible nutrients (pounds)	3480	3440	3260
Cost per 100 pounds digestible nutrients. \$	1.30	1.28	0.86

The above table shows the cost of preparing the seed bed, seeding, harvesting, and interest and depreciation on machinery, and storage to be as follows: For one acre of kale, \$45.10; for one acre of roots, \$44.05; and for one acre of corn, \$28.30. The cost per ton of the kale is least, and that of the corn silage is greatest, but the cost per hundred pounds of digestible nutrients in the kale is 51 per cent. more, and in the roots, 47 per cent. more, than in the corn silage.

Table XV. gives an outline for arriving at the cost of producing silage from start to finish. The table was prepared by the Texas Agricultural Experiment Station. Many farmers in figuring the cost of producing crops fail to consider the value of their own labor, the rent of the land, the depreciation of fences surrounding

the crop, etc. For example, the depreciation of a fence estimated to last ten years should be figured at 10 per cent. of its value.

Table XV.—Outline for Arriving at the Cost of Producing Silage.

..... Acres.	Dr.	Cr.
Plowing (breaking) at \$..... per acre.....		
Discing at \$..... per acre.....		
Harrowing at \$..... per acre.....		
Commercial fertilizer lbs. at \$.... per acre..		
Other fertilizer lbs. at \$..... per acre...		
Planting at \$..... per acre.....		
Seed at \$..... per acre.....		
First cultivation at \$..... per acre.....		
Second cultivation at \$..... per acre.....		
Third cultivation at \$..... per acre.....		
Fourth cultivation at \$..... per acre.....		
Fifth cultivation at \$..... per acre.....		
Harrowing at \$..... per acre.....		
Harvesting (row binder) at \$..... per acre.....		
Hauling to silo \$..... per ton, \$..... per acre.		
Cutting and filling silo at \$.... per ton, \$.... per acre.		
Interest on investment in silo, engine and cutter at per cent.....		
Depreciation on silo, engine and cutter at 10 per cent.		
Rent of land at \$..... per acre.....		
Taxes on land, implements, silo, engine and cutter.		
Depreciation of fences, at per cent.....		
Total cost of producing tons silage from acres at \$..... per ton.....		
Total feeding value of tons silage from acres at \$..... per ton.....		
Total profit or loss, per ton \$...., per acre \$....		

A few experiments illustrating the value of silage as a stock food may be quoted. Prof. Henry fed two lots of steers on a silage experiment. One lot of four steers was fed on corn silage exclusively, and another similar lot corn silage with shelled corn. The former lot gained 222 pounds in thirty-six days, and the latter lot 535 pounds, or a gain of 1.5 pounds per day per head for the silage-fed steers, and 3.7 pounds per day for the silage and shelled-corn-fed steers. Prof. Emery fed corn silage and cottonseed meal, in the proportion of eight to one, to two three-year-old steers, at the North Carolina Experiment Station. The gain made during thirty-two days was, for one steer, 78 pounds, and for the other, 85.5 pounds, or 2.56 pounds per head per day.

The late well-known Wisconsin dairyman, Hon. Hiram Smith, in 1888 gave the following testimony concerning the value of silage for milch cows: "My silo was opened December 1st, and thirty pounds of ensilage was fed to each of the ninety cows for the night's feed, or 2,700 pounds per day, until March 10, one hundred days, or a total of 135 tons, leaving sufficient ensilage to last until May 10th. The thirty pounds took and well filled the place of ten pounds of good hay. Had hay been fed for the night's feed in place of the ensilage, it would have required 900 pounds per day for the ninety cows, or a total for the one hundred days of forty-five tons.

"It would have required, in the year 1887, forty-five acres of meadow to have produced the hay, which, if bought or sold, would have amounted to \$14.00 per acre. The 135 tons of ensilage were produced on 8½ acres of land, and had a feeding value, as compared with hay, of \$74.11 per acre." As the conclusion of the whole matter, Mr. Smith stated that "three cows can be wintered seven months on one acre producing 16 tons of ensilage, while it required two acres of meadow in the same year of 1887 to winter one cow, with the same amount of ground feed in both cases."

Professor Shelton, formerly of Kansas Agricultural College, gives a powerful plea for silage in the following simple statement: "The single fact that the product of about two acres of ground kept our herd of fifty cattle five weeks with no other feed of the fodder kind, except a small ration of corn fodder given at noon, speaks whole cyclopedias for the possibilities of Kansas fields when the silo is called in as an adjunct."

In conclusion.—We will bring our discussion of the silo and its importance in American agriculture, to a close by quoting the opinions of a few recognized leaders on agricultural matters as to the value of silos and silage.

Says **Ex-Gov. Hoard**, the editor of *Hoard's Dairyman*, and a noted dairy lecturer: "For dairying of all the year around the silo is almost indispensable."

Prof. Hill, the director of Vermont Experiment Station: "It was long ago clearly shown that the most economical farm-grown carbohydrates raised in New England are derived from the corn plant,

and that they are more economically preserved for cattle feeding in the silo than in any other way."

H. C. Wallace, formerly editor Creamery Gazette, now business manager Wallace's Farmer: "While not an absolute necessity, the silo is a great convenience in the winter, and in times of protracted dryness almost a necessity in summer."

Prof. Carlyle, formerly of Wisconsin Agricultural College, now director Experiment Station, Moscow, Idaho: "A silo is a great labor-saving device for preserving the cheapest green fodder in the best form."

C. P. Goodrich, conductor of Farmers' Institutes in Wisconsin, and a well-know lecturer and authority on dairy topics: "A farmer can keep cows profitably without a silo, but he can make more profit with one, because he can keep his cows with less expense and they will produce more."

Prof. Deane, of Ontario Agricultural College: "The silo is becoming a greater necessity every year in Ontario."

Thus it will be seen that from all parts of the world wherever the silo is in use, the evidence points in favor of silage, there no longer being an argument against it, in connection with the dairy, and especially in latitudes where corn can be grown.

Economy in production of feed materials means increased profits. Competition establishes the price at which the farmer and dairyman must market his products; but by the study of approved and modern methods the farmer can regulate his profits.

CHAPTER XI.

A FEEDERS' GUIDE.

It has been thought best, in order to increase the usefulness of this little book to practical farmers, to add to the specific information given in the preceding pages as to the making and feeding of silage, a brief general outline of the main principles that should govern the feeding of farm animals. This will include a statement of the character of the various components of the feeding stuffs used for the nutrition of farm stock, with tables of composition, and a glossary of scientific or technical terms often met with in agricultural papers, experiment station reports, and similar publications. Many of these terms are used constantly in discussions of agricultural topics, and unless the farmer has a fairly clear idea of their meaning, the discussions will often be of no value to him. The information given in the following is put in as plain and simple language as possible, and only such facts are given as are considered of fundamental importance to the feeder of farm stock.

Composition of the Animal Body.

The most important components of the animal body are: Water, ash, protein, and fat. We shall briefly describe these components.

Water is found in larger quantities in the animal body than any other substance. It makes up about a third to nearly two-thirds of the live weight of farm animals. The fatter the animal is, the less water is found in its body. We may consider 50 per cent, of the body weight a general average for the water content of the body of farm animals. When it comes to animal products used for food purposes, there are wide variations in the water content; from between 80 and 90 per cent., in case of milk, to between 40 and 60 per cent. in meat of various kinds, about 12 per cent. in butter, and less than 10 per cent. in fat salt pork.

Ash or mineral matter is that portion of the animal body which

remains behind when the body is burned. The bones of animals contain large quantities of mineral matter, while the muscles and other parts of the body contain only small amounts; it must not be concluded, however, that the ash materials are of minor importance for this reason; both young and full-grown animals require a constant supply of ash materials in their food; if the food should not contain a certain minimum amount of ash materials, and of various compounds contained therein which are essential to life, the animal will very soon turn sick, and if the deficiency is not made up will die, no matter how much of other food components may be supplied. As both ash and water are either present in sufficient quantities in feeding stuffs, or can be easily supplied, the feeder does not ordinarily need to give much thought to these components in the selection of foods for his stock except in the case of young animals fed corn (which is lacking in ash materials), and in feeding milch cows and steers which require an addition of salt in order to do well.

Protein is the name of a large group of very complex substances that have certain characteristics in common, the more important of which is that they all contain the element **nitrogen**. The most important protein substances found in the animal body are: lean meat, fibrin, all kinds of tendons, ligaments, nerves, skin, brain, in fact the entire working machinery of the animal body. The casein of milk and the white of the egg are, furthermore, protein substances. It is evident from the enumeration made that protein is to the animal body what the word implies, **the most important, the first**.

Fat is a familiar component of the animal body; it is distributed throughout the body in ordinary cases, but is found deposited on certain organs, or under the skin, in thick layers, in the case of very fat animals.

The animal cannot, as is well known, live on air; it must manufacture its body substances and products from the food it eats, hence the next subject for consideration should be:

Composition of Feeding Stuff.

The feeding stuffs used for the nutrition of our farm animals are, generally speaking, composed of similar compounds as those

which are found in the body of the animal itself, although the components in the two cases are rarely identical, but can be distinguished from each other in most cases by certain chemical reactions. The animal body through its vital functions has the faculty of changing the various food substances which it finds in the food in such a way that they are in many instances different from any substances found in the vegetable world.

The components of feeding stuffs which are generally enumerated and taken into account in ordinary chemical fodder analysis, or in discussions of feeding problems are: **Water** (or **moisture**, as it is often called), **ash materials**, **fat** (or **ether-extract**), **protein**, **fiber**, and **nitrogen-free extract**; the two components last given are sometimes grouped together under the name **carbohydrates**. These components are in nearly all cases mixtures of substances that possess certain properties in common; and as the mixtures are often made up of different components, or of the same components in varying proportions, it follows that even if a substance is given in a table of composition of feeding stuffs, in the same quantities in case of two different feeds, these feeds do not necessarily have the same food value as far as this component alone is concerned.

Water or moisture is found in all feeding stuffs, whether succulent or apparently dry. Green fodders contain from 60 to 90 per cent. of water, according to the stage of maturity of the fodder; root crops contain between 80 and 90 per cent., while hay of different kinds, straw, and concentrated feeds ordinarily have water contents ranging between 20 and 5 per cent.

Ash or mineral matter is found in all plant tissues and feeding stuffs. We find most ash in leafy plants, or in refuse feeds made up from the outer covering of grains or other seeds, viz., from 4 to 8 per cent.; less in the cereals and green fodder, and least of all in roots. A fair amount of ash materials is a necessity in feeding young stock and pregnant animals, and only limited amount of foods low in ash should be fed to such animals; refuse feed from starch and glucose factories which have been treated with large quantities of water should, therefore, be fed with care in such cases.

Fat or ether-extract is the portion of the feeding stuff which is dissolved by ether or benzine. It is found in large quantities in

the oil-bearing seeds, about one third of these being composed of oil or fat; the oil-mill refuse feeds are also rich in fat, especially cottonseed meal and old-process linseed meal; other feeds rich in fat are gluten meal and feed, dried distillers' grains, and rice meal. The ether-extract of the coarse fodders contains considerable wax, resins, and other substances which have a low feeding value, while that of the seeds and by-products from these are essentially pure fat or oil.

Protein or flesh-forming substances are considered of the highest importance in feeding animals, because they supply the material required for building up the tissues of the body, and for maintaining these under the wear caused by the vital functions. Ordinarily the feed rations of most farmers are deficient in protein since most of the farm-grown foods (aside from clover, alfalfa, peas and similar crops) contain only small amounts of these substances. The feeding stuffs richest in protein are, among the coarse foods, those already mentioned; among the concentrated foods; cottonseed meal, linseed meal, gluten meal, gluten feed, buckwheat middlings, and the flour-mill, brewery, and distillery refuse feeds. The protein substances are also called **nitrogenous** bodies for the reasons given above, and the other **organic** (combustible) components in the feeding stuffs are spoken of as **non-nitrogenous** substances. The non-nitrogenous components of feeding stuffs, therefore, include fat and the two following groups, fiber and nitrogen-free extract.

Crude fiber (or simply **fiber**) is the framework of the plants, forming the walls of the cells. It is usually the least digestible portion of plants and vegetable foods, and the larger proportion present thereof the less valuable the food is. We find, accordingly, that the fodders containing most fiber are the cheapest foods and least prized by feeders, as, e. g., straw of the various cereal and seed-producing crops, corncobs, oat and rice hulls, cottonseed hulls, buckwheat hulls, and the like. These feeding stuffs, in so far as they can be considered as such, contain as a rule between 35 and 50 per cent. of fibre. Concentrated feeding stuffs, on the other hand, generally contain less than 10 per cent. of fibre and in all cereals but oats only a few per cent. of fibre are found.

Nitrogen-free extract is a general name for all that is left of the organic matter of plants and fodders after deducting the pre-

ceding groups of compounds. It includes some of the most valuable constituents of feeding stuffs, which make up the largest bulk of the food materials; first in importance among these constituents are starch and sugar, and, in addition, a number of less well-known substances of similar composition, like pentosans, gums, organic acids, etc. Together with fiber the nitrogen-free extracts forms the group of substances known as **carbohydrates**. A general name for carbohydrates is heat-producing substances, since this is one important function which they fill; they are not as valuable for this purpose, pound for pound, as fat, which also is often used for the purpose by the animal organism, but on account of the large quantities in which the carbohydrates are found in most feeding stuffs they form a group of food materials second to none in importance. Since it has been found that fat will produce on combustion about $2\frac{1}{4}$ times as much heat as carbohydrates, the two components are often considered together in tables of composition of feeding stuffs and in discussions of the feeding value of different foods, the per cent. of fat being multiplied by $2\frac{1}{4}$ in such cases, and added to the per cent. of carbohydrates (i. e., fiber plus nitrogen-free extract) in the foods. As this renders comparisons much easier, and simplifies calculations for the beginner, we shall adopt this plan in the tables and discussions given in this Guide.

Carbohydrates and fat not only supply heat on being oxidized or burned in the body, but also furnish materials for energy used in muscular action, whether this be voluntary or involuntary. They also in all probability are largely used for the purpose of storing fatty tissue in the body of fattening animals, or of other animals that are fed an excess of nutrients above what is required for the production of the necessary body heat and muscular force.

To summarize briefly the use of the various food elements: Protein is required for building up muscular tissue, and to supply the breaking-down and waste of nitrogenous components constantly taking place in the living body. If fed in excess of this requirement it is used for production of heat and energy. The non-nitrogenous organic components, i. e., carbohydrates and fat, furnish material for supply of heat and muscular exertion, as well as for the production of fat in the body or in the milk, in case of milk-producing animals.

Digestibility of foods.—Only a certain portion of a feeding stuff is of actual value to the animal, viz., the portion which the digestive juices of the animal can render soluble, and thus bring into a condition in which the system can make the use of it called for; this digestible portion ranges from one-half or less to more than 96 per cent. in case of highly digestible foods. The rest is simply ballast, and the more ballast, i. e., the less of digestible matter a food contains, the more the value of the digestible portion is reduced. Straw, e. g., is found, by means of digestion experiments, to contain between 30 and 40 per cent. of digestible matter in all, but it is very doubtful whether an animal can be kept alive for any length of time when fed straw alone. It very likely costs him more effort to extract the digestible matter therefrom than the energy this can supply. An animal lives on and produces not from what he eats but from what he digests and assimilates.

Relative value of feeding stuffs. Since the prices of different feeding stuffs vary greatly with the locality and season, it is impossible to give definite statements as to the relative economy which will always hold good; it may be said, in general, that the feeding stuffs richest in protein are our most costly and at the same time our most valuable foods. Experience has shown to a certainty that a liberal supply of protein is an advantage in feeding most classes of farm animals, so that if such feeding stuffs can be obtained at fair prices, it will pay to feed them quite extensively, and they must enter into all food rations in fair quantities in order that the animals may produce as much milk, meat, or other farm products, as is necessary to render them profitable to their owner. The following statement shows a classification of feeding stuffs which may prove helpful in deciding upon kinds and amounts of feeds to be purchased or fed:

Table XVI.—Classification of Cattle Foods.—A. Coarse Feeds.

Low in protein. High in carbo- hydrates. 50 to 65 per cent. digestible.	Medium in protein. Medium in carbo- hydrates. 55 to 65 per cent. digestible.	Low in protein. High in carbo- hydrates. 85 to 95 per cent. digestible.
Hays, straws, corn fodder, corn stover, silage, cereal fodders.	Clovers, alfalfa, pasture grass, vetches, pea and bean fod- der.	Carrots, potatoes, sugar beets, mangolds, turnips.

B. Concentrates.

Very high in protein (above 40 per cent.)	High in pro- tein (25-40 per cent.)	Fairly high in protein (12-25 per cent.)	Low in protein (below 12 per cent.)
Dried blood. Meat scraps. Cottonseed meal.	Gluten meal. Atlas meal. Linseed meal. Buckwheat middlings. Buckwheat shorts. Soy bean. Dried distillers' and brewers' grains.	Malt sprouts. Gluten feed. Cow pea. Pea meal. Wheat shorts. Rye shorts. Oat shorts. Wheat middlings. Wheat bran. Low-grade flour.	Wheat. Barley. Oats. Rye. Corn. Rice polish. Rice. Hominy chops or feed. Germ meal. Oat feeds.

The Feed Unit System.

This system furnishes a convenient and accurate method of comparing the feed consumption of different farm animals and of determining the relative economy of their production. It has been found, for example in the case of dairy cows, that some cows produce a certain amount of milk and butter-fat much more cheaply than others, so far as their feed consumption is con-

cerned; they are economical producers and should preferably be used for dairy production and as foundation stock for the dairy. Heifer cows from such cows will be likely to be large and profitable producers. By the feed unit system a simple, definite figure is obtain for the total feed eaten by farm animals, including that eaten on pasture.

An example will readily illustrate the application of the system. For instance, it has been found that 1.1 pounds of wheat

Table XVII.—Table of Feed Units.

Feeding Stuffs.	Pounds of Feed required to equal 1 unit.	
	Average.	Range.
Concentrates—		
Corn, wheat, rye, barley, hominy feed, dried brewers' grains, wheat middlings, oat shorts, Peas, Unicorn Dairy Ration, molasses beet pulp	1.0
Cotton seed meal.....	0.8
Oil meal, Ajax Flakes (dried distillers' grains), gluten feed, soy beans.....	0.9
Wheat bran, oats, dried beet pulp, barley feed, malt sprouts, International Sugar Feed, Quaker or Sugarota Molasses or Dairy Feed, Surene Dairy Feed, Badger Dairy Feed, Schumacher Stock Feed, molasses grains....	1.1
Alfalfa meal, Victor feed, June Pasture, alfalfa molasses feeds	1.2
Hay and Straw—		
Alfalfa hay, clover hay.....	2.0	1.5—3.0
Mixed hay, oat hay, oat and pea hay, barley and pea hay, red top hay.....	2.5	2.0—3.0
Timothy hay, prairie hay, sorghum hay.....	3.0	2.5—3.5
Corn stover, stalks or fodder, marsh hay, cut straw	4.0	3.5—6.0
Soiling crops, silage and other succulent feeds—		
Green alfalfa	7.0	6.0—8.0
Green corn, sorghum, clover, peas and oats, cannery refuse	8.0	7.0—10.0
Alfalfa silage	5.0
Corn silage, pea vine silage.....	6.0	5.0—7.0
Wet brewers' grains.....	4.0
Potatoes, skim milk, butter milk.....	6.0
Sugar beets	7.0
Carrots	8.0
Rutabagas	9.0	8.0—10.0
Field beets, green rape.....	10.0
Sugar beet leaves and tops, whey.....	12.0
Turnips, mangels, fresh beet pulp.....	12.5	10.0—15.0
Pasture, 8 to 12 units per day, on the average varying with kind and condition.		

bran, or 2.5 pounds of hay of average quality, can be substituted to a limited extent for a pound of grain in ordinary dairy rations, without changing appreciably the yield or the composition of the milk produced by the cows, or influencing their live weights or general condition. These quantities of the different feeds are, therefore, considered of similar value and equivalent to **one feed unit**. If a cow ate 750 pounds of hay, 150 pounds of bran, and 90 pounds of ground corn during a certain month, she received 750 divided by 2.5, or 300 feed units, in the hay eaten, 150 divided by 1.1 or 136 in the bran, and 90 in the ground corn, making a total of 526 feed units eaten.

If she yielded one pound of butter-fat a day in her milk on this feed, or 30 pounds for the month, she produced 30 divided by 5.26, or 5.70 pounds of butter-fat per 100 feed units consumed in her feed. There are great differences among cows in the returns made per unit of feed, and data obtained as given above show in a striking manner whether a cow is an economical producer or whether she required an excessive amount of feed to make her production.

Through this information, along with that as to the capacity of the cow for dairy production furnished by a milk scale and a Babcock tester, a farmer can find out definitely the rank of the different cows in the herd as dairy producers and may thus know which ones, if any, are not profitable animals and should be sent to the butcher.

Feeding Standards.

Investigations by scientists have brought to light the fact that the different classes of farm animals require certain amounts of food materials for keeping the body functions in a regular healthy activity; this is known as the maintenance ration of the animal, an allowance of feed which will cause him to maintain his live weight without either gaining or losing, or producing animal products like milk, wool, meat, eggs, etc. If the animal is expected to manufacture these products in addition, it is necessary to supply enough extra food to furnish materials for this manufacture. The food requirements for different purposes have been carefully studied, and we know now with a fair amount of accuracy how much food it takes in the different cases to reach the objects

sought. Since there is a great variety of different foods, and almost infinite possible combinations of these, it would not do to express these requirements in so and so many pounds of corn, or oats, or wheat bran, but they are in all cases expressed in amounts of digestible protein, carbohydrates and fat. This enables the feeder to supply these food materials in such feeding stuffs as he has on hand or can procure. The feeding standards commonly adopted as basis for calculations of this kind are those of the German scientists, Wolff and Lehmann. Those standards give, then, the approximate amount of dry matter, digestible protein, carbohydrates, and fat, which the different classes of farm animals should receive in their daily food in order to produce maximum returns. We have seen that a fair amount of digestible protein in the food is essential in order to obtain good results. The proportion of digestible nitrogenous to digestible non-nitrogenous food substances therefore becomes important. This proportion is technically known as **nutritive ratio**, and we speak of **wide** nutritive ratio, when there are six or more times as much digestible carbohydrates and fat in a ration as there is digestible protein, and of a **narrow** ratio, when the proportion of the two kinds of food materials is as 1 to 6, or less.

The feeding standards given in the following tables may serve as a fairly accurate guide in determining the food requirements of farm animals; and it will be noticed that the amounts are per 1,000 pounds live weight, and not per head, except as noted in the case of growing animals. The standards should not be looked upon as infallible guides, which they are not, for the simple reason that different animals differ greatly both in the amounts of food that they consume and in the uses which they are able to make of the food they eat. The feeding standard for milch cows has probably been subjected to the closest study by American experiment station workers, and it has been found, in general, that the Wolff-Lehmann standard calls for more digestible protein (i. e., a narrower nutritive ratio) than can be fed with economy in most of the dairy sections of our country, at least in the central and northwestern states. On basis of investigations along this line conducted in the early part of the nineties, Prof. Woll, of Wisconsin, proposed a so-called **American practical feeding ration**, which calls for the following amount of digestible food

materials in the daily ration of a dairy cow of an average weight of 1,000 pounds.

Digestible protein	2.2 lbs.
Digestible carbohydrates	13.3 lbs.
Digestible fat7 lbs.
Total digestible matter	17.1 lbs.

(protein + carbohydrates + fat \times 2 $\frac{1}{4}$)

Nutritive ratio	1:6.9
---------------------------	-------

Feeding Standards for Farm Animals.
(Wolff-Lehmann.)

Per day and per 1000 lbs. live weight.

	Total Dry Substance	Nutritive (Digestible) Substances			Total Nutritive Substances	Nutritive Ratio
		Crude Protein	Carbo-hydrates	Ether Extract		
	lbs.	lbs.	lbs.	lbs.	lbs.	
1. Steers at rest in stall.....	18	0.7	8.0	0.1	8.9	1:11.8
" slightly worked.....	22	1.4	10.0	0.3	12.1	1: 7.7
" moderately worked.....	25	2.0	11.5	0.5	14.7	1: 6.5
" heavily worked.....	28	2.8	13.0	0.8	17.7	1: 5.3
2. Fattening steers, 1st period.....	30	2.5	15.0	0.5	18.7	1: 6.5
" " 2nd "	30	3.0	14.5	0.7	19.2	1: 5.4
" " 3d "	26	2.7	15.0	0.7	19.4	1: 6.2
3. Milch cows, daily milk yield, 11 lbs.	25	1.6	10.0	0.3	12.3	1: 6.7
" " " " " 16.5 "	27	2.0	11.0	0.4	14.0	1: 6.0
" " " " " 22 "	29	2.5	13.0	0.5	16.7	1: 5.7
" " " " " 27.6 "	32	3.3	13.0	0.8	18.2	1: 4.5
4. Wool sheep, coarser breeds.....	20	1.2	10.5	0.2	12.2	1: 9.1
" " finer "	23	1.5	12.5	0.3	14.2	1: 8.5
5. Breeding ewes, with lambs.....	25	2.9	15.0	0.5	19.1	1: 5.6
6. Fattening sheep, 1st period.....	30	3.0	18.0	0.5	19.2	1: 5.4
" " 2nd "	26	3.5	14.0	0.6	19.4	1: 4.5
7. Horses lightly worked.....	20	1.5	9.5	0.4	12.0	1: 7.0
" moderately worked.....	24	2.0	11.0	0.6	14.5	1: 6.2
" heavily worked.....	26	2.5	13.3	0.8	17.7	1: 6.0
8. Brood sows, with pigs.....	22	2.5	15.5	0.4	19.0	1: 6.6
9. Fattening swine, 1st period.....	36	4.5	25.0	0.7	31.2	1: 5.9
" " 2nd "	32	4.0	24.0	0.5	29.2	1: 6.3
" " 3d "	25	2.7	18.0	0.4	22.0	1: 7.0
10. Growing cattle:						
Dairy Breeds.						
Age, Months.	Av. Live Weight Per Head.					
2- 3	154 lbs.....	23	4.0	13.0	2.0	21.8 1: 4.5
3- 6	309 "	24	3.0	12.3	1.0	18.2 1: 5.1
6-12	507 "	27	2.0	12.5	0.5	15.7 1: 6.8
12-18	705 "	26	1.8	12.5	0.4	15.3 1: 7.5
18-24	882 "	26	1.5	12.0	0.3	14.2 1: 8.5

Feeding Standards for Farm Animals—Continued.

		Total Dry Substance	Nutritive (Digestible) Substances			Total Nutritive Substances	Nutritive Ratio
			Crude Protein	Carbo-hydrates	Ether Extract		
11. Growing cattle:		lbs.	lbs.	lbs.	lbs.	lbs.	
Beef Breeds.							
Age, Months.	Av. Live Weight Per Head.						
2-3	165 lbs.	23	4.2	13.0	2.0	20.0	1:4.2
3-6	331 "	24	3.5	12.8	1.5	19.9	1:4.7
6-12	551 "	25	2.5	13.2	0.7	14.4	1:6.0
12-18	750 "	24	2.0	12.5	0.5	15.7	1:6.8
18-24	937 "	24	1.8	12.0	0.4	14.8	1:7.2
12. Growing sheep:							
Wool Breeds.							
4-6	60 lbs.	25	3.4	15.4	0.7	20.5	1:5.0
6-8	75 "	25	2.8	13.8	0.6	18.0	1:5.4
7-11	84 "	23	2.1	11.5	0.5	14.8	1:6.0
11-15	90 "	22	1.8	11.2	0.4	14.0	1:7.0
15-20	99 "	22	1.5	10.8	0.3	13.0	1:7.7
13. Growing sheep:							
Mutton Breeds.							
4-6	66 lbs.	26	4.4	15.5	0.9	22.1	1:4.0
6-8	84 "	26	3.5	15.0	0.7	20.2	1:4.8
8-11	101 "	24	3.0	14.3	0.5	18.5	1:5.2
11-15	121 "	23	2.2	12.6	0.5	16.0	1:6.3
15-20	154 "	22	2.0	12.0	0.4	15.0	1:6.5
14. Growing swine:							
Breeding Animals.							
2-3	44 lbs.	44	7.6	28.0	1.0	38.0	1:4.0
3-5	99 "	35	5.0	23.1	0.8	30.0	1:5.0
5-6	121 "	32	3.7	21.3	0.4	26.0	1:6.0
6-8	176 "	28	2.8	18.7	0.3	22.2	1:4.0
8-12	265 "	25	2.1	15.3	0.2	17.9	1:7.5
15. Growing fat pigs:							
2-3	44 lbs.	44	7.6	28.0	1.0	38.0	1:4.0
3-5	110 "	35	5.0	23.1	0.8	30.0	1:5.0
5-6	143 "	33	4.3	22.3	0.6	28.0	1:5.5
6-8	198 "	30	3.6	20.5	0.4	25.1	1:6.0
8-12	287 "	26	3.0	18.3	0.3	22.0	1:6.4

How to Figure Out Rations.

We shall use the practical American feeding ration as a basis for figuring out the food materials which should be supplied a dairy cow weighing 1,000 pounds, in order to insure a maximum and economical production of milk and butter-fat. We shall suppose that a farmer has the following foods at his disposal: Corn silage, mixed timothy and clover hay, and wheat bran; and that he has to feed about forty pounds of silage per head daily, in order to have it last through the winter and spring. We will suppose that he gives his cows, in addition, five pounds of hay and about six pounds of bran daily. If we now look up in the tables given on pages 237 to 241, the amounts of digestible food components contained in the quantities given of these feeds, we shall have:

	Total Dry Mtr.	Digestible Pro.	Carb. & Fat	Nutr. Ratió.
40 lbs. corn silage.....	10.5 lbs.	.48 lbs.	7.1 lbs.	
5 lbs. mixed hay.....	4.2	.22	2.2	
6 lbs. wheat bran.....	5.3	.72	2.8	
	<hr/>	<hr/>	<hr/>	<hr/>
	20.0	1.42	12.1	1:8.5

We notice that the ration as now given contains too little total digestible matter, there being a deficit of both digestible protein, carbohydrates and fat; it will evidently be necessary to supply at least a couple of pounds more of some concentrated feed, and preferably of a feed rich in protein, since the deficit of this component is proportionately greater than that of the other components. In selecting a certain food to be added and deciding on the quantities to be fed, the cost of different available foods must be considered. We will suppose that linseed meal can be bought at a reasonable price in this case, and will add two pounds thereof to the ration. We then have the following amounts of digestible matter in the ration:

	Total	Digestible		Nutr.
	Dry Mtr.	Pro.	Carb. & Fat	Ratio.
Ration as above.....	20.0 lbs.	1.42 lbs.	12.1 lbs.	1:6.4
2 lbs. oil meal (O.P.).....	1.8	.62	1.0	
	—	—	—	—
Total	21.8	2.04	13.1	1:6.4
Amer. prac. feeding				
ration		2.2	14.9	1:6.9
Wolff-Lehmann				
standard	29.0	2.5	14.1	1:5.7

The new ration is still rather light, both in total and digestible food materials; for many cows it might prove effective as it is, while for others it would doubtless be improved by a further addition of some concentrated food medium rich in protein, or if grain feeds are high, of more hay or silage. The feeding rations are not intended to be used as infallible standards that must be followed blindly, nor could they be used as such. They are only meant to be approximate gauges by which the farmer may know whether the ration which he is feeding is of about such a composition and furnishes such amounts of important food materials as are most likely to produce best results, cost of feed and returns in products as well as condition of animals being all considered.

In constructing rations according to the above feeding standard, several points must be considered besides the chemical composition and the digestibility of the feeding stuffs; the standard cannot be followed directly without regard to bulk and other properties of the fodder; the ration must not be too bulky, and still must contain a sufficient quantity of roughage to keep up the rumination of the animals, in case of cows and sheep, and to secure a healthy condition of the animals generally. The local market prices of cattle foods are of the greatest importance in determining which foods to buy; the conditions in the different sections of our great continent differ so greatly in this respect that no generalizations can be made. Generally speaking, nitrogenous concentrated feeds are the cheapest feeds in the South and in the East, and flour-mill, brewery, distillery, and starch-factory refuse feeds the cheapest in the Northwest.

The tables given on pages 236 to 240 will be found of great assistance in figuring out the nutrients in feed rations; the tables have been reproduced from a bulletin published by the Vermont Experiment Station, and are based upon the latest compilations of analysis of feeding stuffs. A few rations are given in the following as samples of combinations of different kinds of feed with corn silage that will produce good results with dairy cows. The rations given on page 193 may also be studied to advantage in making up feed rations with silage for dairy cows. The experiment stations or other authorities publishing the rations are given in all cases.

SAMPLE RATIONS FOR DAIRY COWS.

Massachusetts Experiment Station.—Mixtures of grain mixtures to be fed with one bushel of silage and hay, or with corn stover or hay.

1	2
100 lbs. bran. 100 lbs. flour and middlings. 150 lbs. gluten feed. Mix and feed 7 quarts daily.	100 lbs. bran or mixed feed. 150 lbs. gluten feed. Mix and feed 9 quarts daily.
3	4
100 lbs. bran. 100 lbs. flour middlings. 100 lbs. gluten or cottonseed meal. Mix and feed 7 to 8 quarts daily.	200 lbs. malt sprouts. 100 lbs. bran. 100 lbs. gluten feed. Mix and feed 10 to 12 qts. daily.
5	6
100 lbs. cottonseed or gluten meal. 150 lbs. corn and cob meal. 100 lbs. bran. Mix and feed 7 to 8 quarts daily.	125 lbs. gluten feed. 100 lbs. corn and cob meal. Mix and feed 5 to 6 quarts daily.

New Jersey Experiment Station.—(1) 40 lbs. corn silage, 5 lbs. gluten feed, 5 lbs. dried brewers' grains, 2 lbs. wheat bran.

(2) 35 lbs. corn silage, 5 lbs. mixed hay, 5 lbs. wheat bran, 2 lbs. each of oil meal, gluten meal and hominy meal.

(3) 40 lbs. corn silage, 5 lbs. clover hay, 3 lbs. wheat bran, 2 lbs. malt sprouts, 1 lb. each of cottonseed meal and hominy meal.

(4) 40 lbs. corn silage, 4 lbs. dried brewers' grain, 4 lbs. wheat bran, 2 lbs. oil meal.

Maryland Experiment Station.—(1) 40 lbs. silage, 5 lbs. clover hay, 9 lbs. wheat middlings and 1 lb. gluten meal.

(2) 50 lbs. silage, 8 lbs. corn fodder, 6 lbs. cow pea hay, 3 lbs. bran, 2 lbs. gluten meal.

Michigan Experiment Station.—(1) 40 lbs. silage, 8 lbs. mixed hay, 8 lbs. bran, 3 lbs. cottonseed meal.

(2) 50 lbs. silage, 5 lbs. mixed hay, 4 lbs. corn meal, 4 lbs. bran, 2 lbs. cottonseed meal, 2 lbs. oil meal.

(3) 50 lbs. silage, 10 lbs. clover hay, 4 lbs. bran, 4 lbs. corn meal, 3 lbs. oil meal.

(4) 50 lbs. silage, 4 lbs. clover hay, 10 lbs. bran.

Kansas Experiment Station.—(1) Corn silage 40 lbs., 10 lbs. prairie hay or millet, 4½ lbs. bran, 3 lbs. cottonseed meal.

(2) 40 lbs. corn silage, 10 lbs. corn fodder, 4 lbs. bran, 2 lbs. Chicago gluten meal, 2 lbs. cottonseed meal.

(3) 40 lbs. corn silage 5 lbs. sorghum hay, 3 lbs. corn, 1½ lbs. bran, 3 lbs. gluten meal, 1½ lbs. cottonseed meal.

(4) 50 lbs. corn silage, 10 lbs. millet, 4 lbs. corn, 1 lb. gluten meal, 3 lbs. cottonseed meal.

(5) 50 lbs. corn silage, 15 lbs. fodder corn, 2½ lbs. bran, 3 lbs. gluten meal, 1½ lbs. cottonseed meal.

(6) 50 lbs. corn silage, 15 lbs. fodder corn, 2½ lbs. bran, 3 lbs. gluten meal, 1½ lbs. cottonseed meal.

(6½) 50 lbs. corn silage, 10 lbs. oat straw, 2 lbs. oats, 4 lbs. bran, 2 lbs. gluten meal, 2 lbs. cottonseed meal.

(7) 20 lbs. corn silage, 20 lbs. alfalfa, 3 lbs. corn.

(8) 15 lbs. corn silage, 20 lbs. alfalfa, 5 lbs. kafir corn.

(9) 20 lbs. corn silage, 15 lbs. alfalfa, 4 lbs. corn, 3 lbs. bran.

(10) 40 lbs. corn silage, 5 lbs. alfalfa, 3 lbs. corn, 3 lbs. oats, 2 lbs. O. P. linseed meal, 1 lb. cottonseed meal.

Tennessee Experiment Station.—50 lbs. silage, 10 lbs. clover or

cow pea hay, 5 lbs. wheat bran, 3 lbs. of corn, 2 lbs. cottonseed meal.

North Carolina Experiment Station.—(1) 40 lbs. corn silage, 10 lbs. cottonseed hulls, 5 lbs. cottonseed meal.

(2) 50 lbs. corn silage, 5 lbs. orchard grass hay, 4½ lbs. cottonseed meal.

(3) 30 lbs. corn silage, 10 lbs. alfalfa, 6 lbs. wheat bran, 5 lbs. cottonseed hulls.

(4) 40 lbs. corn silage, 15 lbs. cow pea vine hay.

(5) 40 lbs. corn silage, 6 lbs. wheat bran, 6 lbs. field peas ground.

(6) 40 lbs. corn silage, 4 lbs. cut corn fodder, 3 lbs. ground corn, 4 lbs. bran, 1 lb. cottonseed meal (ration fed at Biltmore Estate to dairy cows). Silage is fed to steers and cows, and corn, peas, teosinte, cow peas, millet and crimson clover are used as silage crops. These crops are put into the silo in alternate layers. "Will never stop using the silo and silage."

South Carolina.—30 lbs. corn silage, 6 lbs. bran, 3 lbs. cottonseed meal, 12 lbs. cottonseed hulls.

Georgia Experiment Station.—40 lbs. corn silage, 15 lbs. cow pea hay, 5 lbs. bran.

Ontario Agr. College.—45 lbs. corn silage, 6 lbs. clover hay, 8 lbs. bran, 2 lbs. barley.

Nappan Experiment Station (Canada).—30 lbs. corn silage, 20 lbs. hay, 8 lbs. bran and meal.

The criticism may properly be made with a large number of the rations given in the preceding, that it is only in case of low prices of grain or concentrated feeds in general, and with good dairy cows, that it is possible to feed such large quantities of grain profitably as those often given. In the central and north-western states it will not pay to feed grain heavily with corn at fifty cents a bushel and oats at thirty cents a bushel or more. In times of high prices of feeds, it is only in exceptional cases that more than six or eight pounds of concentrated feeds can be fed with economy per head daily. Some few cows can give proper returns for more than this quantity of grain even when this is high, but more cows will not do so.

The following rule for feeding good dairy cows is a safe one to be guided by: Feed as much roughage (succulent feeds like silage or roots, and hay) as the cows will eat up clean, and in addition, 1 pounds of grain feed (**concentrates**) a day per head for every pound of butter fat they produce in a week (or one-third to one-fourth as many pounds as they give milk daily).

The farmer should aim to grow protein foods like clover, alfalfa, peas, etc., to as large extent as practicable, and thus reduce his feed bills.

Average Composition of Silage Crops of Different Kinds, in Per Cent.

	Water	Ash	Crude Protein	Fiber	Nitrogen Free Extract	Ether Extract
Corn Silage—						
Mature corn	75.6	2.1	2.7	7.8	12.9	.9
Immature corn	79.1	1.4	1.7	6.0	11.0	.8
Ears removed	80.7	1.8	1.8	5.6	9.5	.6
Clover silage	72.0	2.6	4.2	8.4	11.6	1.2
Alfalfa silage	76.9	2.7	2.9	8.5	8.8	.4
Soy bean silage.....	74.2	2.8	4.1	9.7	6.9	2.2
Cow pea vine silage.....	79.3	2.9	2.7	6.0	7.6	1.5
Field-pea vine silage.....	50.0	3.6	5.9	13.0	26.0	1.6
Corn cannery refuse husks.	85.8	.6	1.4	5.2	7.9	1.1
Corn cannery refuse cobs..	74.1	.5	1.5	7.9	14.3	1.7
Pea cannery refuse.....	76.8	1.3	2.8	6.5	11.3	1.3
Sorghum silage	76.1	1.1	.8	6.4	15.3	.3
Kafir corn silage	67.2	2.9	2.1	11.2	15.2	1.4
Milo silage	74.6	1.8	2.2	7.9	12.7	.7
Corn-soy bean silage.....	76.0	2.4	2.5	7.2	11.1	.8
Millet-soy bean silage.....	79.0	2.8	2.8	7.2	7.2	1.0
Rye silage	80.8	1.6	2.4	5.8	9.2	.3
Oat silage	71.4	2.0	2.3	16.1	7.1	1.1
Apple pomace silage.....	85.0	.6	1.2	3.3	8.8	1.1
Cow-pea and soy bean mixed	69.8	4.5	3.8	9.5	11.1	1.3
Brewers' grain silage.....	69.8	1.2	6.6	4.7	15.6	2.1
Beet Pulp silage	90.9	.3	1.3	3.3	3.8	.4

The table shown above gives actual chemical analysis of the products mentioned and includes the entire contents of the various feeds. The following table, showing the average amount

of digestible nutrients in the more common American fodders, grains and by-products, is the table that should be used in formulating rations. The table gives the number of pounds of digestible nutrients contained in 100 lbs. of the feeds, and these figures can, therefore, be used in figuring out the amount of digestible nutrients in any given amount of a food material; it is by such methods that the tables given on pages 236 to 240 are obtained.

Analysis of Feeding Stuffs.

Table Showing Average Amounts of Digestible Nutrients in the More Common American Fodders, Grains and By-products.

(Compiled by the Editors of Hoard's Dairyman, Fort Atkinson, Wis).

NAME OF FEED	Dry Matter in 100 Pounds	Digestible Nutrients in 100 Pounds		
		Protein	Carbo- hydrates	Ether Extract (Crude Fat)
Green Fodders.	Lbs.	Lbs.	Lbs.	Lbs.
Pasture Grasses, mixed.....	20.0	2.5	10.2	0.5
Fodder Corn	20.7	1.0	11.6	0.4
Sorghum	20.6	0.6	12.2	0.4
Red Clover	29.2	2.9	14.8	0.7
Alfalfa	28.2	3.9	12.7	0.5
Cow Pea	16.4	1.8	8.7	0.2
Soy Bean	24.9	3.2	11.0	0.5
Oat Fodder	37.8	2.6	18.9	1.0
Rye Fodder	23.4	2.1	14.1	0.4
Rape	14.0	1.5	8.1	0.2
Peas and Oats	16.0	1.8	7.1	0.2
Beet Pulp	10.2	0.6	7.3	...
Silage.				
Corn	20.9	0.9	11.3	0.7
Corn, Wisconsin analysis.....	26.4	1.3	14.0	0.7
Sorghum	23.9	0.6	14.9	0.2
Red Clover	28.0	2.0	13.5	1.0
Alfalfa	27.5	3.0	8.5	1.9
Cow Pea	20.7	1.5	8.6	0.9
Soy Bean	25.8	2.7	8.7	1.3

NAME OF FEED	Dry Matter in 100 Pounds	Digestible Nutrients in 100 Pounds		
		Protein	Carbo- hydrates	Ether Extract (Crude Fat)
Dry Fodders and Hay.	Lbs.	Lbs.	Lbs.	Lbs.
Corn Fodder	57.8	2.5	34.6	1.2
Corn Fodder, Wis. anal.....	71.0	3.7	40.4	1.2
Corn Stover	59.5	1.7	32.4	0.7
Sorghum Fodder	59.7	1.5	37.3	0.4
Red Clover	84.7	6.8	35.8	1.7
Alfalfa	91.6	11.0	39.6	1.2
Barley	85.2	6.2	46.6	1.5
Blue Grass	78.8	4.8	37.3	2.0
Cow Pea	89.3	10.8	38.6	1.1
Crab Grass	82.4	5.7	39.7	1.4
Johnson Grass	87.7	2.4	47.8	0.7
Marsh Grass	88.4	2.4	29.9	0.9
Millet	92.3	4.5	51.7	1.3
Oat Hay	91.1	4.3	46.4	1.5
Oat and Pea Hay	85.4	9.2	36.8	1.2
Orchard Grass	90.1	4.9	42.3	1.4
Prairie Grass	87.5	3.5	41.8	1.4
Rep Top	91.1	4.8	46.9	1.0
Timothy	86.8	2.8	43.4	1.4
Timothy and Clover.....	85.3	4.8	39.6	1.6
Vetch	88.7	12.9	47.5	1.4
White Daisy	85.0	3.8	40.7	1.2
Straw.				
Barley	85.8	0.7	41.2	0.6
Oat	90.8	1.2	38.6	0.8
Rye	92.9	0.6	40.6	0.4
Wheat	90.4	0.4	36.3	0.4
Roots and Tubers.				
Artichokes	20.0	2.0	16.8	0.2
Beets, common	13.0	1.2	8.8	0.1
Beets, sugar	13.5	1.1	10.2	0.1
Carrots	11.4	0.8	7.8	0.2
Mangels	9.1	1.1	5.4	0.1
Parsnips	11.7	1.6	11.2	0.2
Potatoes	21.1	0.9	16.3	0.1
Rutabagas	11.4	1.0	8.1	0.2
Turnips	9.5	1.0	7.2	0.2
Sweet Potatoes	29.0	0.9	22.2	0.3

NAME OF FEED	Dry Matter in 100 Pounds	Digestible Nutrients in 100 Pounds		
		Protein	Carbo- hydrates	Ether Extract (Crude Fat)
Grain and By-Products.	Lbs.	Lbs.	Lbs.	Lbs.
Barley	89.1	8.7	65.6	1.6
Brewers' Grains, dry	91.8	15.7	36.3	5.1
Brewers' Grains, wet	24.3	3.9	9.3	1.4
Malt Sprouts	89.8	18.6	37.1	1.7
Buckwheat	87.4	7.7	49.2	1.8
Buckwheat Bran	89.5	7.4	30.4	1.9
Buckwheat Middlings	87.3	22.0	33.4	5.4
Corn	89.1	7.9	66.7	4.3
Corn and Cob Meal	89.0	6.4	63.0	3.5
Corn Cob	89.3	0.4	52.5	0.3
Corn Bran	90.9	7.4	59.8	4.6
Atlas Gluten Meal	92.0	24.6	38.8	11.5
Gluten Meal	88.0	32.1	41.2	2.5
Germ Oil Meal	90.0	20.2	44.5	8.8
Gluten Feed	90.0	23.3	50.7	2.7
Hominy Chop	88.9	7.5	55.2	6.8
Starch Feed, wet	34.6	5.5	21.7	2.3
Cotton Seed	89.7	12.5	30.0	17.3
Cotton Seed Meal	91.8	37.2	16.9	8.4
Cotton Seed Hulls	88.9	0.3	33.1	1.7
Cocoanut Meal	89.7	15.6	38.3	10.5
Cow Peas	85.2	18.3	54.2	1.1
Flax Seed	90.8	20.6	17.1	29.0
Oil Meal, old process	90.8	29.3	32.7	7.0
Oil Meal, new process	89.9	28.2	40.1	2.8
Cleveland Oil Meal	89.6	32.1	25.1	2.6
Kafir Corn	84.8	7.8	57.1	2.7
Millet	86.0	8.9	45.0	3.2
Oats	89.0	9.2	47.3	4.2
Oat Feed or Shorts	92.3	12.5	46.9	2.8
Oat Dust	93.5	8.9	38.4	5.1
Peas	89.5	16.8	51.8	0.7
Quaker Dairy Feed	92.5	9.4	50.1	3.0
Rye	88.4	9.9	67.6	1.1
Rye Bran	88.4	11.5	50.3	2.0
Wheat	89.5	10.2	69.2	1.7
Wheat Bran	88.1	12.6	38.6	3.0
Wheat Middlings	87.9	12.8	53.0	3.4
Wheat Shorts	88.2	12.2	50.0	3.8

Average Weight of Concentrated Feeds.

KIND OF FEED	One Quart Equals	One Pound Equals
Barley Meal	1.1 pounds.	0.9 quarts.
Beet Pulp, dried.....	0.6 "	1.7 "
Brewers' Grains, dried.....	0.6 "	1.7 "
Corn and Cob Meal	1.4 "	0.7 "
Corn Bran	0.5 "	2.0 "
Corn Meal	1.5 "	0.7 "
Corn, whole	1.7 "	0.6 "
Cotton Seed Meal	1.4 "	0.7 "
Distillers' Grains, dried.....	0.6 "	1.7 "
Germ Oil Meal	1.4 "	0.7 "
Gluten Feed	1.3 "	0.7 "
Gluten Meal	1.8 "	0.6 "
Hominy Feed	1.1 "	0.9 "
H-O Dairy Feed	0.7 "	1.4 "
Linseed Meal, old process....	1.1 "	0.9 "
Malt Sprouts	0.6 "	1.7 "
Oat Feed	0.8 "	1.3 "
Oats, ground	0.7 "	1.4 "
Oats, whole	1.1 "	0.9 "
Quaker Dairy Feed	1.0 "	1.0 "
Victor Corn and Oat Feed....	0.7 "	1.4 "
Wheat Bran	0.5 "	2.0 "
Wheat Middlings, standard...	0.8 "	1.3 "
Wheat Middlings, flour.....	1.2 "	0.8 "
Wheat, whole	1.9 "	0.5 "

Soiling Crops Adapted to Northern New England States.

(Lindsey.)

(For 10 cows' entire soiling.)

Kind.	Seeds per Acre.	Time of Seeding.	Area.	Time of Cutting.
Rye	2 bu.	Sept. 10-15	½ acre	May 20-May 30
Wheat	2 bu.	" 10-15	½ "	June 1-June 15
Red clover	20 lbs.	Jul. 15-Au. 1	½ "	June 15-June 25
Grass and clover	½ bu. red top. 1 pk. timothy.	Sept.	¾ "	June 15-June 30
	10 lbs. red clo.			
Vetch and oats	3 bu. oats.... 50 lbs. vetch..	April 20	½ "	June 25-July 10
	50 " " "	" 30	½ "	July 10-July 20
Peas and oats	1½ bu. Can'd'.	April 20	½ "	June 25-July 10
	1½ bu. oats...			
	1½ " " "	" 30	½ "	July 10-July 20
Barnyard millet	1 peck	May 10	⅓ "	July 25-Aug. 10
	1 "	25	⅓ "	Aug. 10-Aug. 20
Soy bean (medium green).	18 quarts	" 20	⅓ "	Aug. 25-Sept. 15
	18 "	" 20	⅓ "	Aug. 25-Sept. 10
Corn	18 "	" 30	⅓ "	Sept. 10-Sept. 20
Hungarian	1 bu.	July 15	½ "	Sept. 20-Sept. 30
Barley and peas	1½ bu. peas..	Aug. 5	1 "	Oct. 1-Oct. 20
	1½ bu. barley.			

Time of Planting and Feeding Siloing Crops.

(Phelps.)

Kind of Fodder.	Amount of Seed per Acre.	Approximate Time of Seeding.	Approximate Time of Feeding.
1. Rye fodder.....	2½ to 3 bu.	Sept. 1	May 10-20
2. Wheat fodder.....	2½ to 3 bu.	Sept. 5-10	May 20-June 5
3. Clover	20 lbs.	July 20-30	June 5-15
4. Grass (from grass lands)	June 15-25
5. } Cats and peas....	2 bu. each.	April 10	June 25-July 10
6. }		" 20	July 10-20
7. }		" 30	July 20-Aug. 1
8. Hungarian	1½ bu.	June 1	Aug. 1-10
9. Clover rowen (from 3)	Aug. 10-20
10. Soy beans (from 3)..	1 bushel.	May 25	Aug. 20-Sept. 5
11. Cow peas	1 "	June 5-10	Sept. 5-20
12. Rowen grass (from grass lands).....	Sept. 20-30
13. Barley and peas.....	2 bu. each.	Aug. 5-10	Oct. 1-30

The dates given in the table apply to Central Connecticut and regions under approximately similar conditions.

In Varying Weights of Feed, in Pounds.

Note.—These tables save calculations of percentages, since the weights and contents being given in pounds, it is only necessary to find the kind and desired amount of a certain feed, and the table gives the exact food contents in pounds, as in the first table, 15 lbs. of Green Oat Fodder contains 5.7 lbs. of dry matter, 0.36 lbs. of protein and 3.1 lbs. of carbohydrates.

POUNDS OF FODDER.	Pasture Grass, 1:4.8			Timothy Grass, 1:14.3			Ky. Blue Grass, 1:9.2		
	Total Dry Matter.	Protein.	Carbohy- drates, etc.	Total Dry Matter.	Protein.	Carbohy- drates, etc.	Total Dry Matter.	Protein.	Carbohy- drates, etc.
Grasses.	Pasture Grass, 1:4.8			Timothy Grass, 1:14.3			Ky. Blue Grass, 1:9.2		
2½	0.5	0.06	0.3	1.0	0.04	0.5	0.9	0.05	0.5
5	1.0	0.12	0.6	1.9	0.08	1.1	1.8	0.10	0.9
10	2.0	0.23	1.1	3.8	0.15	2.1	3.5	0.20	1.8
15	3.0	0.35	1.7	5.8	0.23	3.2	5.2	0.30	2.7
20	4.0	0.46	2.2	7.7	0.30	4.3	7.0	0.40	3.7
25	5.0	0.58	2.8	9.6	0.38	5.4	8.7	0.50	4.7
30	6.0	0.69	3.3	11.5	0.45	6.4	10.5	0.60	5.5
35	7.0	0.82	3.9	13.4	0.53	7.5	12.2	0.70	6.4
40	8.0	0.92	4.4	15.4	0.60	14.0	14.0	0.80	7.3
Green Fodders.	Green Fodder Corn, 1:11.2			Green Oat Fodder, 1:8.7			Green Rye Fodder, 1:7.2.		
2½	0.5	0.03	0.3	0.9	0.06	0.5	0.6	0.05	0.4
5	1.0	0.06	0.6	1.9	0.12	1.0	1.2	0.11	0.7
10	2.1	0.11	1.3	3.8	0.24	2.1	2.3	0.21	1.5
15	3.1	0.17	1.9	5.7	0.36	3.1	3.5	0.32	2.3
20	4.1	0.22	2.6	7.6	0.48	4.2	4.7	0.42	3.0
25	5.2	0.28	3.2	9.5	0.60	5.2	5.9	0.52	3.8
30	6.2	0.33	3.9	11.3	0.72	6.2	7.0	0.63	4.5
35	7.2	0.39	4.5	13.2	0.84	7.3	8.2	0.74	5.3
40	8.3	0.44	5.2	15.1	0.96	8.3	9.4	0.84	6.0
Green Fodders.	Oats and Peas, 1:4.2			Barley and Peas, 1:3.2			Red Clover (green), 1:5.7		
2½	0.5	0.07	0.3	0.5	0.07	0.2	0.7	0.07	0.4
5	1.1	0.14	0.5	1.0	0.14	0.4	1.5	0.15	0.8
10	2.1	0.27	1.1	2.1	0.28	0.9	2.9	0.29	1.6
15	3.2	0.41	1.7	3.1	0.42	1.4	4.4	0.44	2.5
20	4.3	0.54	2.3	4.1	0.56	1.8	5.9	0.58	3.3
25	5.3	0.68	2.9	5.2	0.70	2.3	7.3	0.73	4.1
30	6.4	0.81	3.4	6.2	0.84	2.7	8.8	0.87	4.9
35	7.5	0.95	4.0	7.2	0.96	3.2	10.2	1.02	5.7
40	8.5	1.08	4.6	8.2	1.12	3.6	11.7	1.16	6.6
Green Fodders.	Corn Silage, 1:14.3			Corn Stover Silage, 1:16.6			Clover Silage, 1:4.7		
2½	0.7	0.03	0.4	0.5	0.02	0.3	0.7	0.07	0.3
5	1.3	0.06	0.8	1.0	0.03	0.5	1.4	0.14	0.6
10	2.6	0.13	1.6	1.9	0.06	1.0	2.8	0.27	1.3
15	4.0	0.20	2.3	2.9	0.09	1.5	4.2	0.41	1.9
20	5.3	0.26	3.1	3.9	0.12	2.0	5.6	0.54	2.6
25	6.6	0.33	3.9	4.8	0.15	2.5	7.0	0.68	3.2
30	7.9	0.39	4.7	5.8	0.18	3.0	8.4	0.81	3.9
35	9.2	0.46	5.5	6.8	0.21	3.5	9.8	0.95	4.5
40	10.6	0.52	6.2	7.7	0.24	4.0	11.2	1.08	5.1

Varying Weights of Feed in Pounds.—Continued.

POUNDS OF FODDER.	Total Dry Matter.	Protein.	Carbohy- drates, etc.	Total Dry Matter.	Protein.	Carbohy- drates, etc.	Total Dry Matter.	Protein.	Carbohy- drates, etc.
	Roots.	Potatoes, 1:7.3			Sugar Beets, 1:6.8			Carrots, 1:9.6	
2½	0.5	0.02	0.4	0.3	0.04	0.3	0.3	0.03	0.2
5	1.1	0.05	0.8	0.7	0.08	0.5	0.5	0.05	0.5
10	2.1	0.09	1.6	1.4	0.16	1.1	1.1	0.10	1.0
15	3.2	0.14	2.3	2.0	0.24	1.7	1.6	0.15	1.4
20	4.2	0.18	3.1	2.7	0.32	2.2	2.3	0.20	1.9
25	5.3	0.23	3.9	3.4	0.40	2.7	2.9	0.25	2.4
30	6.3	0.27	4.7	4.1	0.48	3.3	3.4	0.30	2.9
35	7.4	0.32	5.4	4.7	0.56	3.8	4.0	0.35	3.4
40	8.4	0.36	6.2	5.4	0.64	4.4	4.6	0.40	3.8
Roots.	Mangel Wurtzels, 1:4.9			Rutabagas, 1:8.6			Turnips, 1:7.7		
2½	0.2	0.03	0.1	0.3	0.03	0.2	0.2	0.03	0.2
5	0.4	0.06	0.3	0.5	0.05	0.4	0.5	0.05	0.4
10	0.9	0.11	0.5	1.1	0.10	0.9	1.0	0.10	0.8
15	1.4	0.17	0.8	1.6	0.15	1.3	1.4	0.15	1.2
20	1.8	0.22	1.1	2.3	0.20	1.7	1.9	0.20	1.5
25	2.3	0.28	1.4	2.9	0.25	2.2	2.4	0.25	1.9
30	2.7	0.33	1.6	3.4	0.30	2.6	2.9	0.30	2.3
35	3.2	0.39	1.9	4.0	0.35	3.0	3.3	0.35	2.7
40	3.6	0.44	2.2	4.6	0.40	3.4	3.8	0.40	3.1
Milk.	Skim Milk, 1:2.0			Buttermilk, 1:1.7			Whey, 1:8.7		
2½	0.2	0.07	0.1	0.2	0.10	0.2	0.2	0.02	0.1
5	0.5	0.15	0.3	0.5	0.19	0.3	0.3	0.03	0.3
10	0.9	0.29	0.6	1.0	0.33	0.6	0.6	0.06	0.5
15	1.4	0.44	0.9	1.5	0.57	1.0	0.9	0.09	0.8
20	1.9	0.58	1.2	2.0	0.76	1.3	1.2	0.12	1.0
25	2.4	0.73	1.6	2.5	0.95	1.6	1.5	0.15	1.3
30	2.8	0.87	1.8	3.0	1.14	1.9	1.9	0.18	1.6
35	3.2	1.02	2.1	3.5	1.33	2.2	2.2	0.21	1.8
40	3.7	1.16	2.4	4.0	1.52	2.6	2.5	0.24	2.1
Hays.	Mixed Hay, 1:10.0			Timothy Hay, 1:16.5			Ky. Blue Grass Hay, 1:10.6		
2½	2.1	0.11	1.1	.22	0.07	1.2	1.9	0.09	1.0
5	4.2	0.22	2.2	.43	0.15	2.3	3.7	0.19	2.0
7½	6.4	0.33	3.3	.65	0.21	3.5	5.6	0.28	3.0
10	8.5	0.44	4.4	.87	0.28	4.6	7.4	0.37	3.9
12½	10.6	0.55	5.5	1.09	0.35	5.8	9.2	0.46	4.9
15	12.7	0.66	6.6	1.30	0.42	6.9	11.1	0.56	5.9
17½	14.8	0.77	7.7	1.52	0.49	8.1	13.0	0.65	6.9
20	16.9	0.88	8.8	1.74	0.56	9.2	14.8	0.74	7.9
25	21.2	1.10	11.0	2.17	0.70	11.6	18.5	0.93	9.9

Varying Weights of Feed in Pounds.—Continued.

POUNDS OF FODDER.	Total Dry Matter.			Protein.			Carbohy- drates, etc.		
	Total Dry Matter.	Protein.	Carbohy- drates, etc.	Total Dry Matter.	Protein.	Carbohy- drates, etc.	Total Dry Matter.	Protein.	Carbohy- drates, etc.
Hays.	Oat Hay, 1:9.9			Oat and Pea Hay, 1:4.1			Hungarian, 1:10.0		
2½	2.3	0.10	1.0	2.2	0.28	1.2	2.1	0.12	1.2
5	4.6	0.21	2.0	4.4	0.56	2.3	4.2	0.25	2.4
7½	6.8	0.31	3.0	6.6	0.84	3.5	6.3	0.37	3.5
10	9.1	0.41	4.0	8.9	1.12	4.6	8.4	0.49	4.9
12½	11.4	0.51	5.1	11.1	1.40	5.8	10.4	0.62	6.2
15	13.7	0.62	6.1	13.3	1.68	6.9	12.5	0.74	7.4
17½	16.0	0.72	7.1	15.5	1.96	8.1	14.6	0.86	8.6
20	18.2	0.82	8.1	17.7	2.24	9.2	16.7	0.98	9.8
25	22.8	1.03	10.2	22.1	2.80	11.6	20.8	1.23	12.3
Hays, etc.	Red Clover Hay, 1:5.9			Alsike Clover Hay, 1:5.0			Oat Straw, 1:38.3		
2½	2.1	0.18	1.0	2.3	0.21	1.1	2.3	0.03	1.2
5	4.2	0.36	2.1	4.5	0.42	2.1	4.6	0.06	2.3
7½	6.4	0.53	3.2	6.8	0.63	3.2	6.8	0.09	3.5
10	8.5	0.71	4.2	9.0	0.84	4.2	9.1	0.12	4.6
12½	10.6	0.89	5.2	11.3	1.05	5.3	11.4	0.15	5.8
15	12.7	1.07	6.3	13.5	1.26	6.3	13.9	0.18	6.9
17½	14.8	1.24	7.3	15.8	1.47	7.4	16.0	0.21	8.1
20	16.9	1.42	8.3	18.1	1.68	8.4	18.2	0.24	9.2
25	21.2	1.78	10.5	22.6	2.10	10.6	22.7	0.30	11.5
Dry Fodder.	Corn Fodder, 1:14.3			Corn Stover, 1:23.6			Wheat Straw, 1:95.0		
2½	1.4	0.06	0.9	1.5	0.04	0.8	2.3	0.01	0.9
5	2.9	0.13	1.8	3.0	0.07	1.7	4.5	0.02	1.9
7½	4.3	0.19	2.7	4.5	0.11	2.5	6.8	0.03	2.8
10	5.8	0.25	3.6	6.0	0.14	3.3	9.0	0.04	3.7
12½	7.2	0.32	4.5	7.5	0.18	4.1	11.3	0.05	4.6
15	8.7	0.38	5.4	9.0	0.21	5.0	13.5	0.06	5.6
17½	10.1	0.44	6.2	10.5	0.25	5.8	15.8	0.07	6.5
20	11.6	0.50	7.1	12.0	0.28	6.6	18.1	0.08	7.4
25	14.5	0.63	8.9	15.0	0.35	8.3	22.6	0.10	9.3
Grains.	Corn Meal, 1:11.3			Corn and Cob Meal, 1:13.9			Oats, 1:6.2		
¼	0.2	0.02	0.2	0.2	0.01	0.2	0.2	0.02	0.1
½	0.4	0.04	0.4	0.4	0.02	0.3	0.4	0.05	0.3
1	0.9	0.08	0.8	0.9	0.05	0.7	0.9	0.09	0.6
2	1.7	0.13	1.4	1.7	0.10	1.3	1.8	0.18	1.1
3	2.6	0.19	2.1	2.6	0.14	2.0	2.7	0.28	1.7
4	3.4	0.25	2.9	3.4	0.19	2.7	3.6	0.37	2.3
5	4.3	0.32	3.6	4.3	0.24	3.4	4.5	0.46	2.8
7½	6.4	0.48	5.4	6.4	0.36	5.1	6.7	0.69	4.3
10	8.5	0.63	7.1	8.5	0.48	6.7	8.9	0.92	5.7

Varying Weights of Feed in Pounds.—Continued.

POUNDS OF FODDER.	Barley, 1:8.9			Barley Screenings, 1:7.7			Wheat Bran, 1:3.8		
	Total Dry Matter.	Protein.	Carbohy- drates, etc.	Total Dry Matter.	Protein.	Carbohy- drates, etc.	Total Dry Matter.	Protein.	Carbohy- drates, etc.
1/4.....	0.2	0.02	0.2	0.2	0.02	0.2	0.2	0.03	0.1
1/2.....	0.4	0.04	0.3	0.4	0.04	0.3	0.4	0.06	0.2
1.....	0.9	0.09	0.7	0.9	0.09	0.7	0.9	0.12	0.5
2.....	1.8	0.17	1.4	1.8	0.17	1.3	1.8	0.24	1.0
3.....	2.7	0.26	2.1	2.6	0.26	2.0	2.6	0.36	1.4
4.....	3.6	0.35	2.8	3.5	0.34	2.7	3.5	0.48	1.8
5.....	4.5	0.44	3.5	4.4	0.43	3.3	4.4	0.60	2.3
7 1/2.....	6.7	0.65	5.2	6.6	0.65	5.0	6.6	0.90	3.4
10.....	8.9	0.87	6.9	8.8	0.86	6.6	8.8	1.20	4.6
By Products.	Wheat Middlings, 1:4.6			Wheat Screenings, 1:5.2			Red-dog Flour, 1:3.3		
1/4.....	0.2	0.03	0.1	0.2	0.02	0.1	0.2	0.04	0.1
1/2.....	0.4	0.06	0.3	0.4	0.05	0.2	0.5	0.09	0.3
1.....	0.9	0.13	0.6	0.9	0.10	0.5	0.9	0.18	0.6
2.....	1.8	0.25	1.2	1.8	0.20	1.0	1.8	0.36	1.2
3.....	2.6	0.38	1.7	2.7	0.29	1.5	2.7	0.53	1.7
4.....	3.5	0.50	2.3	3.5	0.39	2.0	3.6	0.71	2.3
5.....	4.4	0.63	2.9	4.4	0.49	2.5	4.6	0.89	2.9
7 1/2.....	6.6	0.94	4.4	6.6	0.74	3.8	6.8	1.34	4.4
10.....	8.8	1.25	5.8	8.8	0.98	5.1	9.1	1.78	5.8
By Products.	Rye, 1:7.8			Rye Bran, 1:5.1			Cottonseed Meal, 1:1.0		
1/4.....	0.2	0.02	0.2	0.2	0.03	0.2	0.2	0.10	0.1
1/2.....	0.4	0.04	0.3	0.4	0.06	0.3	0.5	0.20	0.2
1.....	0.9	0.09	0.7	0.9	0.12	0.6	0.9	0.40	0.4
2.....	1.8	0.18	1.4	1.8	0.25	1.3	1.8	0.80	0.8
3.....	2.7	0.27	2.1	2.7	0.37	1.9	2.9	1.20	1.2
4.....	3.5	0.36	2.8	3.5	0.49	2.5	3.7	1.60	1.6
5.....	4.4	0.46	3.5	4.4	0.62	3.1	4.6	2.00	2.0
7 1/2.....	6.6	0.67	5.2	6.6	0.92	4.6	6.9	3.00	3.0
10.....	8.8	0.89	6.9	8.8	1.23	6.3	9.2	4.00	4.0
By Products.	Cottonseed Hulls, —			Linseed Meal o. p., 1:1.5			Linseed Meal n. p., 1:1.3		
1/4.....	0.2	0.1	0.2	0.08	0.1	0.2	0.08	0.1
1/2.....	0.4	0.2	0.5	0.15	0.2	0.4	0.16	0.2
1.....	0.9	0.4	0.9	0.31	0.5	0.9	0.32	0.4
2.....	1.8	0.7	1.8	0.62	1.0	1.8	0.65	0.8
3.....	2.7	1.1	2.7	0.92	1.4	2.7	0.97	1.3
4.....	3.6	1.5	3.6	1.23	1.8	3.6	1.30	1.7
5.....	4.5	0.01	1.8	4.9	1.54	2.3	4.5	1.62	2.1
7 1/2.....	6.7	0.02	2.7	6.8	2.31	3.4	6.7	2.43	3.2
10.....	8.9	0.03	3.7	9.0	3.08	4.6	8.9	3.24	4.2

Varying Weights of Feed in Pounds.—Continued.

POUNDS OF FODDER.	Total Dry Matter.	Protein.	Carbohy- drates, etc.	Total Dry Matter.	Protein.	Carbohy- drates, etc.	Total Dry Matter.	Protein.	Carbohy- drates, etc.
	By Products.	Flax Meal, 1:1.4			Gluten Meal (Chl.), 1:1.5			Gluten Meal (Cr'm.), 1:1.7	
1/4.....	0.2	0.08	0.1	0.2	0.08	0.1	0.2	0.07	0.1
1/2.....	0.4	0.16	0.2	0.4	0.16	0.2	0.4	0.15	0.2
1.....	0.9	0.32	0.4	0.9	0.32	0.5	0.9	0.30	0.5
2.....	1.9	0.64	0.9	1.8	0.64	0.9	1.8	0.59	1.0
3.....	2.7	0.96	1.3	2.6	0.96	1.4	2.7	0.89	1.5
4.....	3.6	1.28	1.7	3.5	1.28	1.9	3.6	1.19	2.1
5.....	4.5	1.60	2.2	4.4	1.60	2.3	4.5	1.49	2.6
7 1/2.....	6.7	2.40	3.3	6.6	2.40	3.5	6.7	2.23	3.9
10.....	8.9	3.21	4.3	8.8	3.21	4.7	9.0	2.97	5.1
By Products.	Gluten Feed (Buffalo), 1:2.4			Hominy Chop, 1:9.2			Dried Brewer's Grains, 1:3.0		
1/4.....	0.2	0.06	0.1	0.2	0.02	0.2	0.2	0.04	0.1
1/2.....	0.4	0.12	0.3	0.5	0.04	0.4	0.5	0.08	0.3
1.....	0.9	0.23	0.6	0.9	0.09	0.8	0.9	0.16	0.5
2.....	1.8	0.47	1.1	1.8	0.17	1.6	1.8	0.31	0.9
3.....	2.7	0.70	1.7	2.8	0.26	2.4	2.8	0.47	1.4
4.....	3.6	0.93	2.3	3.7	0.35	3.2	3.7	0.63	1.9
5.....	4.7	1.17	2.8	4.6	0.44	4.0	4.6	0.79	2.4
7 1/2.....	6.8	1.74	4.3	6.9	0.65	6.0	6.9	1.18	3.5
10.....	9.0	2.33	5.9	9.2	0.87	8.0	9.2	1.57	4.7
By Products.	Atlas Gluten Meal, 1:2.6			Malt Sprouts, 1:2.2			Pea Meal, 1:3.2		
1/4.....	0.2	0.06	0.2	0.2	0.05	0.1	0.2	0.04	0.1
1/2.....	0.5	0.12	0.3	0.4	0.09	0.2	0.4	0.08	0.3
1.....	0.9	0.25	0.6	0.9	0.19	0.4	0.9	0.17	0.5
2.....	1.8	0.49	1.3	1.8	0.37	0.8	1.8	0.33	1.1
3.....	2.8	0.74	1.9	2.7	0.56	1.2	2.7	0.50	1.6
4.....	3.7	0.98	2.6	3.6	0.74	1.6	3.6	0.67	2.1
5.....	4.6	1.23	3.2	4.5	0.93	2.0	4.5	0.86	2.7
7 1/2.....	6.9	1.85	4.9	6.7	1.40	3.0	6.7	1.26	4.0
10.....	9.2	2.46	6.5	9.0	1.86	4.0	9.0	1.68	5.3

GLOSSARY.

Ad libitum. At pleasure; in case of feeding farm animals all they will eat of a particular feeding stuff.

Albuminoids. A group of substances of the highest importance in feeding farm animals, as they furnish the material from which flesh, blood, skin, wool, casein of milk, and other animal products are manufactured. Another name for albuminoids is **flesh-forming substances** or **protein**.

Ash. The portion of a feeding stuff which remains when it is burned, the incombustible part of feeds. The ash of feeding stuffs goes to make the skeleton of animals, and in the case of milch cows a portion thereof goes into the milk as milk ash.

The Babcock test. This test, by which the per cent. of butter fat in milk and other dairy products can be accurately and quickly determined, was invented in 1890 by Dr. S. M. Babcock of Wisconsin Agricultural College.

Bacteria. Microscopic vegetable organisms. They are widely diffused in nature, and multiply with marvelous rapidity. Certain species are active agents in fermentation, while others appear to be the cause of certain infectious diseases.

Balanced ration. A combination of feeding stuffs, containing the various nutrients in such proportions and amounts as will nourish the animals for twenty-four hours, with the least waste of nutrients.

By-products. A secondary product of an industry; cottonseed meal is a by-product of the cotton oil industry; skim milk and butter milk are by-products of butter making.

Carbohydrates (or carbydrates). A group of nutrients rich in carbon and containing oxygen and hydrogen in the proportion in which they form water. The most important carbohydrates found in feeding stuffs are starch, sugar, gums and fiber (cellulose.)

Carbon. A chemical element, which with the elements of water, makes up the larger part of the dry matter of plants and animals.

Carbonic acid. A poisonous gas arising from the combustion of coal or wood. It is formed in all kinds of fermentations and therefore occurs in deep silos in the siloing of fodders.

Casein. The protein substance of milk which is coagulated by rennet or acids.

Cellulose. See fiber.

Concentrates. The more nutritious portion of the rations of farm animals embracing such feeding stuffs as wheat bran, corn, oil meal, etc.; synonymous with grain feeds, or concentrated feeds.

Corn fodder or fodder corn. Stalks of corn which are grown for forage and from which the ears or nubbins have not been removed.

Corn stover or stalks. The dry stalks of corn from which the ears have been removed.

Crude fiber. See Fiber.

Digestible matter. The portion of feeding stuffs which is digested by animals, i. e., brought in solution or semi-solution by the digestive fluids, so that it may serve as nourishment for the animal and furnish material for the production of meat, milk, wool, eggs, etc.

Dry matter. The portion of a feeding stuff remaining after the water contained therein has been removed.

Ensilage. An obsolete word for silage. Used as a verb, likewise obsolete, for to silo; to ensile also sometimes incorrectly used for the practice of placing green fodders into a silo.

Enzyme. An unorganized or chemical compound of vegetable or animal origin, that causes fermentation, as, pepsin or rennet.

Ether extract. The portion of a feeding stuff dissolved by ether; mainly fat or oil in case of concentrated feeding stuffs; in coarse fodders, fat, mixed with a number of substances of uncertain feeding value, like wax, chlorophyll (the green coloring matter of plants), etc.

Fat. See ether extract.

Feed unit. A quantity of different feeding stuffs that has been found to produce similar results in feeding farm animals as one

pound of grain (corn, barley, wheat or rye). For list of feed units, see page 219.

Feeding standard. A numerical expression of the amount of various digestible substances in a combination of feeding stuffs best adapted to give good results as regards production of animal products, like beef, pork, milk, etc.

Fiber. The frame work forming the walls of cells of plants. It is composed of cellulose and lignin, the latter being the woody portion of plants and wholly indigestible.

Glucose or fruit sugar. The form of sugar found in fruits, honey, etc., also in the alimentary canal.

Indian corn. Zea mays, the great American cereal and fodder-producing plant.

Hydrogen. A chemical element, a gas. Combined with oxygen it forms water, with oxygen and carbon it forms carbohydrates and fat; with oxygen, carbon and nitrogen (with small amounts of sulphur and phosphorus) it forms the complex organic nitrogenous substances known as **protein** or **albuminoid** substances.

Legumes. Plants bearing seeds in pods and indirectly capable of fixing the free nitrogen of the air, so that it becomes of value to the farmer and will supply nitrogenous food substances to farm animals. Examples, the different kinds of clover, alfalfa, peas, beans, vetches, etc. Of the highest importance agriculturally as soil renovators, and in supplying farm-grown protein foods.

Maintenance ration. An allowance of feed sufficient to maintain a resting animal in body weight so that it will neither gain nor lose weight.

Nitrogen. A chemical element, making up four-fifths of the air. The central element of protein. See under **hydrogen**.

Nitrogen-free extract. The portion of a feeding stuff remaining when water, fat, protein, fiber, and ash are deducted. It includes starch, sugar, pentosans, and other substances. It is so called because it does not contain any nitrogen.

Nitrogenous substances. Substances containing nitrogen (which see).

Nutrient. A food constituent or group of food constituents capable of nourishing animals.

Net nutrients. The portion of the digested part of the food that remains after the amounts required for mastication, digestion and assimilation have been used up. It is this portion only that is of real value to animals and furnish material for building up of tissue or elaboration of animal products.

Nutritive ratio. The proportion of digestible protein to the sum of digestible carbohydrates and fat in a ration, the per cent. of fat being multiplied by $2\frac{1}{4}$, and added to the per cent. of carbohydrates (fiber plus nitrogen-free extract).

Organic matter. The portion of the dry matter which is destroyed on combustion (dry matter minus ash).

Oxygen. A chemical element found in a free state in the air, of which it makes up about one-fifth, and in combination of hydrogen in water; oxygen is also a rarely-lacking component of organic substances. See **carbohydrates** and **hydrogen**.

Protein. A general name for complex organic compounds mainly made up from the elements carbon, hydrogen, oxygen, and nitrogen. Crude protein includes all organic nitrogen compounds, while true protein or **albumenoids** (which see) only includes such nitrogenous substances in feeding stuffs as are capable of forming muscle and other tissue in the animal body.

Ration. The amount of feed that an animal eats during twenty-four hours.

Roughage. The coarse portion of a ration, including such feeding stuffs as hay, silage, straw, corn fodder, roots, etc. Concentrated feeding stuffs are sometimes called **grain-feeds** or **concentrates**, in contradistinction to roughage.

Silage. The succulent feed taken out of a silo. Formerly called ensilage.

Silo. An airtight structure used for the preservation of green, coarse fodders in a succulent condition. As a verb, to place green fodders in a silo.

Soiling. The system of feeding farm animals in a stable or enclosure, with fresh grass or green fodders, as corn, oats, rye, Hungarian grass, etc.

Starch. One of the most common carbohydrates in feeding

stuffs, insoluble in water, but readily digested and changed to sugar in the process of digestion.

Succulent feeds. Feeding stuffs containing considerable water, like green fodder, silage, roots and pasture.

Summer silage. Silage intended to be fed out during the summer and early fall to help out short pastures.

Summer silo. A silo used for the making of summer silage.

CONCLUSION.

In conclusion we desire to state that the object of this book is to place before the farmer, dairyman and stockman such information as will be valuable and practical, in as concise and plain a manner as possible, and to make a plea in behalf of the silo as an improver of the financial condition of the farmer. That the silo is a prime factor in modern agriculture is no longer a matter of doubt. The silo is not the sum total in itself, but as an adjunct, and, in the case of dairying, a **necessary** adjunct to successful and profitable methods, its value is difficult to overestimate.

One of the greatest values of the silo is that as an innovation it becomes a stepping-stone to better methods in general; it stimulates its owner and spurs him on to see just how good and far-reaching results he can obtain from his revised system of management. It invites a little honest effort, and coupled with this it never fails. It enables its owner not only to do what he has been unable to do before, but things he has done without its help the silo enables him to do at less cost than before. The solution of the problem of cost of manufacture is necessary to every successful producer, and as the proposition is constantly changing, the solutions of our forefathers, or even of a generation ago, no longer avail. The silo is not an enticing speculation by means of which something can be gotten out of nothing, but a sound business proposition, and has come to stay. The voices of thousands of our best farmers and dairymen sing its praises, because it has brought dollars into their pockets, and increased enjoyment to them in their occupations and their homes.

Have you cows? Do you feed stock? Do you not need a silo? Is it not worthy of your best thought and consideration? You owe it to yourself to make the most you can out of the opportunities before you. **DO IT NOW!**

INDEX

	PAGE.
Acreage required for filling silos.....	26
Advantages of the silo	11, 203
Alfalfa silage	150
All-metal silos	103-108
Analyses of feeding stuffs.....	231
Animal body, composition of the.....	212
• Approximate daily ration of silage.....	29
Ash	214
Average composition of silage crops.....	230
Bagasse, sorghum, for silage.....	154
Ballard octagonal silo.....	72-75
Beef cattle, silage for	118-194
Beef supply for United States.....	119
Beets, cost of, per acre.....	208
Beet-pulp silage	156-166
Blower elevators	183
Bluegrass pastures of the South.....	115
Bottom of the silo	32
Brick lined silos	50
Brick silos	102-103
Building up fertility in the South.....	137
Broom corn for silage.....	156
Cactus, spineless, for silage.....	168
Canada thistles for silage.....	158
Cane, Japanese, for silage.....	169
Capacity of round silos.....	28
Carbonic acid poisoning in silos, danger from.....	110, 185
Cattle, daily silage ration for.....	29
Cement block silos.....	93-98

	PAGE.
Cement block silos, how made, reinforcing, etc., of.....	95-98
Cement lining, how to maintain.....	94, 102
Cement stave silos	98
Certified milk, silage in production of.....	192
Chart showing fertility removed from soil.....	132
Chemical composition of silage.....	230
Circles, circumferences, and areas of.....	67-68
Clover silage	146, 149
Clover silage, cost of.....	147
Clover, time of cutting for the silo.....	148
Clover, yield per acre.....	148
Comparative cost of producing silage.....	207-209
Comparative feeding value of corn, kafir and cane.....	125
Comparative losses in dry curing.....	15
Composition of the animal body.....	212
Composition of silage crops.....	230
Composition of feeding stuffs.....	214
Conclusion	246
Concrete monolithic silos.....	82-89
Concrete silos	82-89
Concrete silos, forms used for making.....	87-89
Connecting round silos with barn.....	69
Conserving soil fertility with silage system.....	130-138
Corn, cutting of, in the field.....	173
Corn land, preparation of	139
Corn, methods of planting.....	144
Corn silage vs. fodder corn.....	207
Corn silage vs. hay.....	205
Corn silage vs. roots.....	204
Corn, siloing of, "ears and all".....	176
Corn, see also Indian corn and Fodder corn.	
Corn, time of cutting for silo.....	142
Cost of beets per acre.....	208
Cost of corn silage.....	207-210
Cost of silos	75-77
Covering silage	186
Cow-pea silage	151
Crops for the silo	139-159
Crude fiber	215
Cutter and power, size of.....	180-182

INDEX.

249

PAGE.

Definition of terms used.....	212, 241
Description of "Ohio" silage cutters.....	180, 257-264
Devil grass for silage.....	155
Different types of silo structures.....	30
Digestibility of foods.....	217
Digestible dry matter in different feeding stuffs.....	256-240
Doors for silos	62-63
Doorways, continuous, for block silos.....	96
Doorways, continuous, for cement silos.....	87
Drouth, silo in times of.....	113, 114
Dry matter in corn at different stages.....	145
Ears and all, siloing of corn.....	176
Economy of storage	17
Elevators, pneumatic	181-184
Ensilage, see Silage .	
Estimating of materials for silos.....	78-80
Feeders' guide, etc.....	212
Feeding of silage.....	190
Feeding standards	220-222
Feeding stuffs, composition of.....	213
Feeding value of corn, kafir and cane.....	125
Fern brake for silage.....	158
Fertility chart	132
Fertility in 100 lbs. of beef.....	136
Fertility in one ton of butter.....	136
Fertility in the South.....	137
Feterita for silage.....	154
Field-curing of fodder corn, losses in.....	12-15
Filling of silo	173
Floor plan of silos and model barn.....	51
Food from thistles	19, 158
Food ingredients, increase in.....	143
Forming the plate	38
Forming the sill	33
Forms for building silos.....	89
Foundation for silos	32
Fox tail for silage.....	155
Freezing of silage.....	67, 107, 188

	PAGE.
Georgia Station results.....	129
Grain mixtures for dairy cows.....	225
Guide, a feeders'	212
Gurler silo	46-48
Harvey system of reinforcement.....	98
Hauling corn from field, rack or sled for.....	174
Hills or drills, planting of corn in.....	144
History of the silo.....	11
Home-made silos, Ballard.....	72
Horizontal girts, silos with.....	73
Horizontal reinforcement for concrete silos.....	86
Horses, daily silage ration for.....	29
Horses, silage for.....	196
How to build a silo.....	21
How to feed silage.....	190
How to figure out rations.....	225
How to place frame on the foundation.....	52
Hurst system of reinforcement.....	97
Hy-Rib and Metal-Lath reinforced silos.....	90
Illinois Station results	122
Increase in number of silos.....	8
Indian corn	139
Indian corn, chemical changes in.....	142
Indian corn, increase in food ingredients from tasseling to ripeness	143
Indian corn, methods of planting.....	144
Indian corn, see also Corn and Fodder Corn.	
Indian corn, soil adapted for.....	139
Indian corn, varieties of, to be planted for the silo.....	140
Indiana Station results.....	123
Introduction	7
Iowa silo, the.....	101
Iowa Station results.....	126
Japanese cane for silage.....	169
Johnson grass for silage.....	156

INDEX.

	251
	PAGE.
Kafir for silage.....	153, 160
Kale for silage	155
Kansas Station results.....	125
King or Wisconsin silo.....	31
Late summer drouths	19
Lining for silos	38-40
Location of the silo.....	30
Losses in dry curing.....	12-13
Losses in siloing process.....	14
Losses in siloing alfalfa	15
Low wagons for hauling corn.....	174
Lucerne, see Alfalfa .	
Materials for the silo.....	55
Metal bucket, chain elevators.....	180
Metal-lath silos	90-92
Milch cows, silage for	190
Milch cows, silage rations for.....	193
Milo for silage	153, 160
Mineral matter	212
Miscellaneous silage crops.....	156-159
Missouri Station results.....	121
Modification of "Wisconsin" silo	45
Monolithic concrete or cement silos.....	83
Mules, silage for	198
Nebraska Station results.....	121
Night pasturing and summer silo.....	114
Nitrogen-free extract	215
No danger from late summer drouths.....	19
No danger of rain	17
North Carolina Station results.....	122
Number of silos.....	8
Number of staves required for stave silos.....	67
Nutritive ratio	218
Oats and peas for silage.....	157
Oats, wheat and rye for silage.....	157

	PAGE.
Octagonal silos	69-75
"Ohio" silage cutters, description of.....	180, 257-264
Opinions of recognized leaders	209
Painting the silo lining	44-45
Patented cement blocks.....	97-98
Patented forms for silos.....	89
Peanuts for silage.....	155
Peas and oats for silage.....	157
Pennsylvania Station results.....	121
Pit or underground silos.....	108-110
Plastered round wooden silos.....	46-47
Planting corn, methods of.....	144
Planting corn, thickness of.....	144
Pneumatic elevators	181
"Poultrymen's silos"	203
Poultry, silage for	203
Preparation of corn land.....	139
Preservation of silos	80
Protection against freezing, stave silo.....	67
Protein	214
Rack, low-down, for hauling corn.....	174
Rate of feeding from silos of different diameters.....	29
Rate of feeding silage from surface.....	28, 29
Ration of silage, daily.....	29
Rations, how to figure out.....	225
Rations, silage, for dairy cows.....	193
Ready reference tables	236-240
Reinforced concrete silo construction.....	84-90
Reinforcement for concrete silos.....	86
Reinforcing for stone, brick or cement silos.....	84, 86
Relative value of feeding stuffs.....	217
Restoring fertility in the South.....	137
Robertson's silage mixture.....	152
Renovation of Tennessee blue grass pastures.....	115
Roof for the silo	39, 40, 57, 64, 97, 107
Round silos	31-69
Russian thistles for silage.....	158-166
Rye, wheat and oats for silage.....	157

INDEX.

253
PAGE.

Saskatchewan Station results.....	124
Setting studding for doors.....	36
Setting the studding	33
Sheep, daily silage ration for.....	29
Sheep, silage for.....	198-202
Shoemaker farm silos	174
Silage, alfalfa	150
Silage and soil fertility.....	150-138
Silage, approximate daily ration of.....	29
Silage cart	191
Silage, chemical composition of.....	230
Silage, clover	146
Silage, cost of	125, 147, 207-210
Silage, Cow Pea	151
Silage crops	139
Silage crops for semi-arid regions and for South.....	160
Silage crops for the South.....	169
Silage, depth to feed, daily.....	28, 29
Silage-fed beef cattle in the South.....	129
Silage, feeding of	190
Silage for beef cattle	118, 194
Silage for horses	195
Silage for milch cows.....	189, 193
Silage for mules.....	198
Silage for poultry	202
Silage for sheep	197
Silage for swine	201
Silage, freezing of	67, 107, 188
Silage from frosted corn.....	188
Silage, how to feed.....	190
Silage, how to make.....	173
Silage, quantities of, required for different herds.....	26, 29
Silage, rations for milch cows.....	193
Silage—Robertson's Silage Mixture.....	152
Silage, sorghum, milo and kafir.....	153, 160
Silage spoils quickly in summer.....	117
Silage truck	191
Silage, use of, in beef production.....	118, 194
Silage, steamed	188
Silo helps reclaim blue grass pastures.....	115

	PAGE.
Silo must be air-tight	21
Silo must be deep.....	22
Silo must have smooth perpendicular walls.....	22
Silo sheeting and siding.....	38
Silo walls must be rigid and strong.....	25
Silo, summer	111
Silo, surplus crops stored in.....	114
Silo, the Ballard octagonal.....	72-75
Silo, the Iowa	101
Silos, acreage to fill.....	26
Silos, all-metal	105-108
Silos, brick	102-103
Silos, brick lined	50
Silos, cement block	95-98
Silos, cement stave	98
Silos, concrete	82-89
Silos, cost of	45, 46, 48, 64, 75-79, 87-92
Silos, form of	26
Silos, foundation of	32, 33, 35, 43, 48, 90, 97, 101
Silos, general requirements for	21
Silos, home-made, Ballard.....	72
Silos, how to build.....	21
Silos, how to place frame on foundation of.....	33
Silos, Hy-Rib or Metal-lath reinforced.....	90
Silos, kinds of wood for.....	32
Silos, lining of wooden.....	38
Silos, location of	30
Silos, metal-lath	90-92
Silos, monolithic concrete.....	82-89
Silos, number of.....	8
Silos, octagonal	69
Silos, on the form of.....	26
Silos, proper diameter of.....	28, 29
Silos, roof for	39, 40, 57, 64, 97, 107
Silos, round, capacity	25
Silos, round wooden	31
Silos, size required	24
Silos, specifications for	31, 45, 50, 55, 72, 78, 79
Silos, steel ribbed plastered.....	90-92
Silos, superstructure	32

INDEX.

255
PAGE.

Silos, the filling process	173
Silos, the time of filling.....	18, 143, 174
Silos, three methods of making sill for.....	54
Silos, underground	108
Silos, underground or pit.....	108-110
Silos, value in intensive farming.....	19
Silos, ventilation of	41-44
Silos, vitrified tile.....	99-102
Silos with horizontal girts.....	73
Size of cutter and power required.....	178
Size of silo required.....	24
Soiling crops, table of.....	235
Soiling crops, time of planting and feeding.....	235
Soil fertility maintained with silage.....	150
Soy beans	152
Sorghum bagasse	154
Sorghum silage	153, 160
South Carolina Station results.....	121
South Dakota Station results.....	124
Southern and Northern varieties of corn, comparative yield of.	141
Specifications for a stave silo.....	55
Stave silos	50-69
Stave silos, calculation of staves required for.....	67
Stave silos, roof of.....	57
Stave silos, specifications for.....	55
Steamed silage	188
Steel ribbed plastered silos.....	90-92
Steers, silage for	118, 194
Stock-yards, boosters for silage.....	120
Succulence	16
Sudan grass for silage.....	155
Summer drouth	114
Summer silo, advantages of.....	111
Surplus crops stored in silo	114
Swine, silage for	201
Teosinte for silage.....	154
Texas Station results.....	128
Thickness of planting corn.....	144
Time of cutting corn for the silo.....	142

	PAGE.
Time of filling the silo... ..	18, 143, 174
Thistles for silage.....	158
Truck for silage	191
Underground or pit silos.....	108-110
Underground silos	108
Uniform quality of feed.....	16
Use of silage in beef production.....	118
Value in intensive farming.....	19
Varieties of corn to be planted for the silo.....	139
Ventilation of the silo.....	41-44
Vertical reinforcement for concrete silos.....	86
Vetches for silage.....	155
Vitrified tile silos.....	99-102
Waste products for silage.....	159
Water, use of, in filling silos.....	186
Weeds for silage	159
Weight of concentrated feeds.....	234
Wheat, rye and oats for silage.....	157
Wisconsin Experiment Station silos, description of.....	48-51
Yields of clover per acre.....	148

Silver's Pony Blower Silo Filler

Operates with six horse gasoline engine.
Capacity three to five tons silage an hour.
Self Feed with new Friction Reverse
Cylinder Cutting Mechanism with direct
suction to blower.

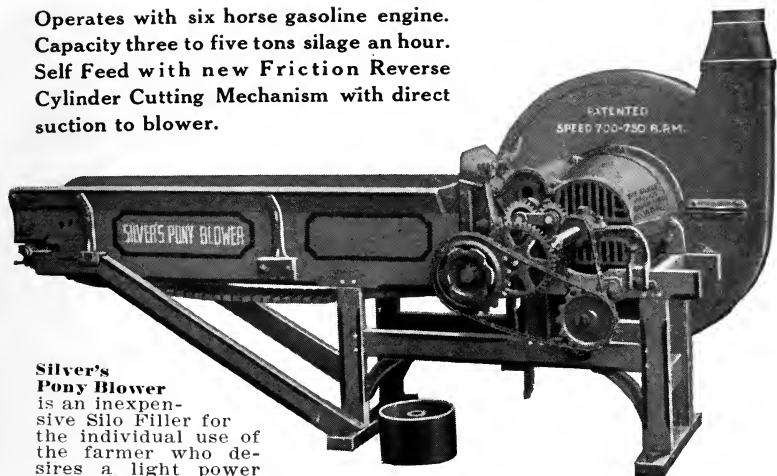

Silver's

Pony Blower

is an inexpensive Silo Filler for the individual use of the farmer who desires a light power Blower without any of the disadvantages common to the fly wheel type of Cutter.

The size and design of this Cutter makes it especially adapted for general farm use in cutting all kinds of crops. It is very compact and light; at the same time it is of ample strength and capacity for filling silos and will satisfactorily operate with a six or eight horse gasoline engine.

Direct Suction Into Blower—The construction of this machine is a departure from former types of Blower Silo Fillers. The material is drawn directly from the knives into the fan case by suction without the use of any conveying mechanism whatever. This feature has been thoroughly tested out through two silage cutting seasons to the complete satisfaction of users.

Capacity is ample for silos up to fifty and seventy-five tons. It will cut and elevate three to five tons silage an hour. Where speed, or liability of frosts, or a large force of men and teams are factors in the case, we recommend a larger machine.

Feeding Mechanism with Friction Reverse—The machine is equipped with the well-known "Ohio" Self Feed Apron and bulldog grip feed rollers all controlled by a single lever which stops, starts or reverses the feed rolls and table at a touch. The reverse consists of a wood friction mechanism and operates without the slightest strain.

The Drive Pulley, Cutting Cylinder, Fly Wheel and Blower Fan are all on the 1 9/16 in. main shaft, utilizing every ounce of power applied. Knives have cutting edges of high carbon tool steel, carefully tempered. Suitable guards cover the knives and other moving parts. Fan Case is heavy sheet steel, electrically welded. 7 in. galvanized pipe is used. The machine has two knives and four lengths of cut. "Ohio" Shredder blades for dry fodder are interchangeable with knives.

The machine can be furnished with or without special truck for mounting. Send for printed matter on Silver's Pony Blower.

See Silver's "OHIO" Silo Fillers. Pages 260 to 264.

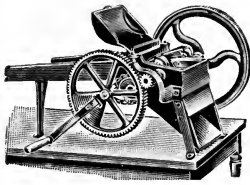

No. 770 Clover Cutter.
Cuts $\frac{1}{8}$ " lengths, for
Poultry.



**No. 778 Lever, 11"
Knife. Wt. 50 lbs.**

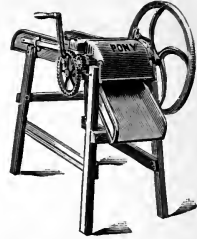

**No. 783 Cuts $\frac{1}{2}$ to
2". Hand or Power.**

Send for SPECIAL Printed LINE of SILVER'S "OHIO"



**No. 830 Root and
Vegetable Cutter.**
Cuts and Splits.

In addition to Silver's "Ohio" Silo Fillers, as described in the following pages, we manufacture a complete line of Feed Cutters and Fodder Shredders in various sizes and styles. A few representative machines are shown on this page.

Whether you cut 40 tons of silage each season or 4,000 tons you can make a selection from Silver's famous "Ohio" line that will just suit your requirements.

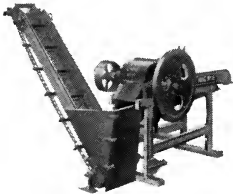

**Metal Bucket Carrier
for No. 11 Cutter. De-
livers to Right, Left or
Front.**

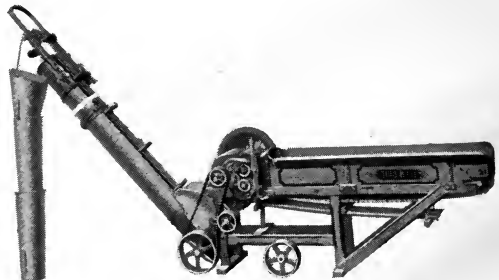

**Silver's Round Inclosed Steel Carrier
Straight Delivery for No. 11 Ohio Cutter.**

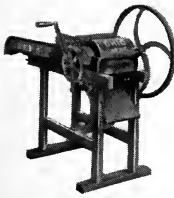

No. 8½ and 10½.
For Hand or
Power. 4 lengths
Cut. Strong and
Durable.

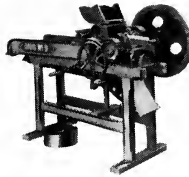

No. 9S Cuts ¼ to 2".
1 to 2 H. P.
Gasoline. Wt. 410
lbs.

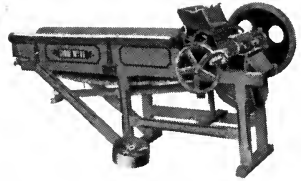

**No. 11SS with Self Feed
Table. Cuts ¼ to 2".**
3 to 4 Tons Silage an
Hour. 2 to 3 H. P. Gas.
With or without Carrier.

Matter on the FAMOUS CUTTERS and SHREDDERS

Whether you feed one animal or 1,500 you will find that the "Ohio" offers just the size and style that will fit your needs and your purse.

"Quality First" is the motto that has made these machines popular the world over.

If you are interested in fodder cutting or shredding machinery, do not fail to secure our special printed matter on "The Famous OHIO Cutters and Shredders."

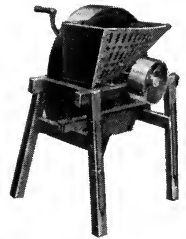

**No. 832 Root Cut-
ter and Pulper.**
Slits and Pulps.

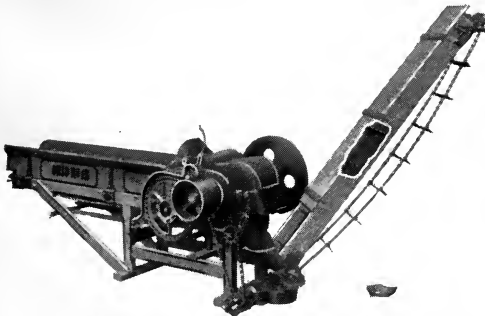

**Metal Bucket Carrier, Straight or Swivel
Delivery, for "Ohio" Monarch Silo
Fillers Nos. 12, 15 and 17.**

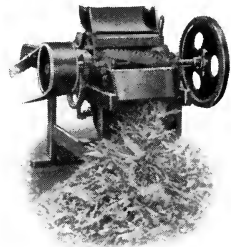

**"Ohio" Shredder Blades
Replace Knives on
Cutters from No. 9 Up.
We also make other
styles of Shredders.**

THE 1914 MODEL

"OHIO" MONARCH SILO FILLER

With Self-Feed Table and Blower Elevator.
Eclipses Anything Ever Before Produced by Any Feed Cutter
Manufacturer.

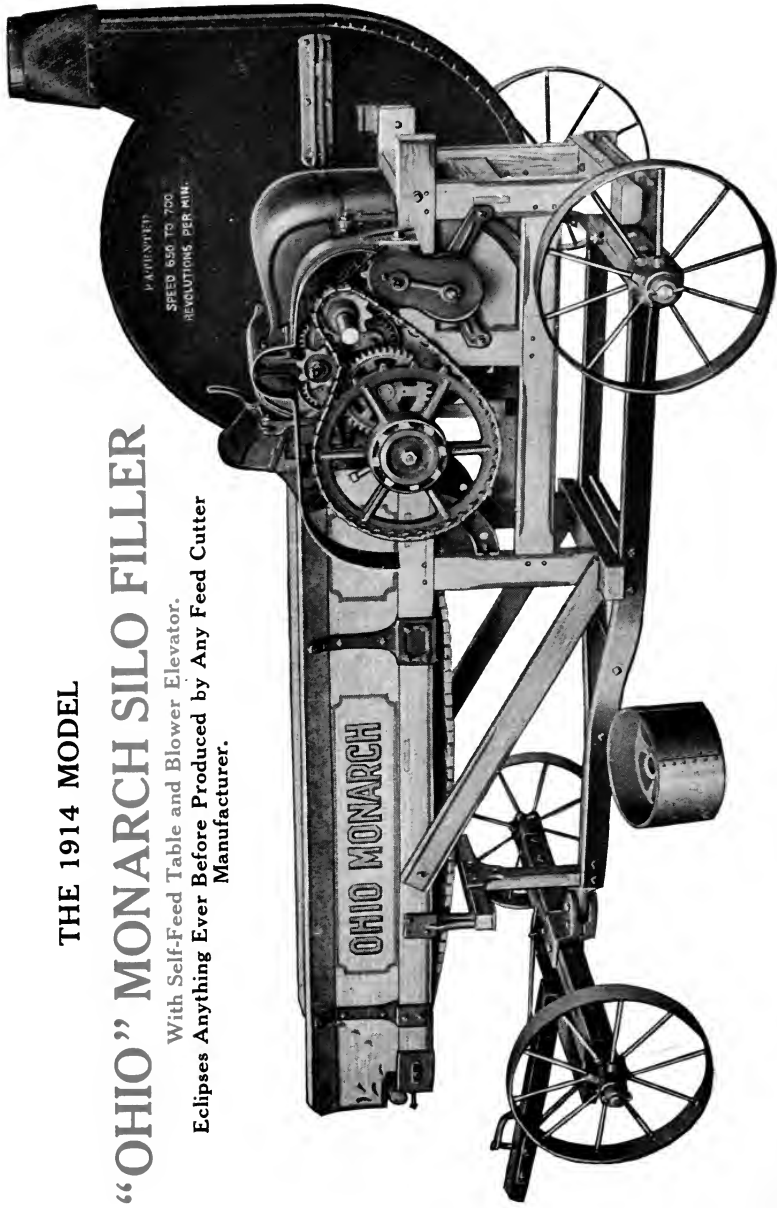

SPECIFICATIONS.

Five Sizes—with 12, 15, 17, 19 and 22-inch throat.

Speed—650 to 700 revolutions per minute.

Pulley—Regular, 12-inch diameter by 8-inch face, leather covered. Choice of other diameters (8, 10, 14 or 16-inch) when wanted.

Number of Knives—Four, full width of throat.

Length of Cut— $\frac{1}{4}$, $\frac{1}{2}$, $\frac{3}{4}$ and 1-inch with four knives; $\frac{1}{2}$, 1, 1 $\frac{1}{2}$ and 2 inches when only two knives are used.

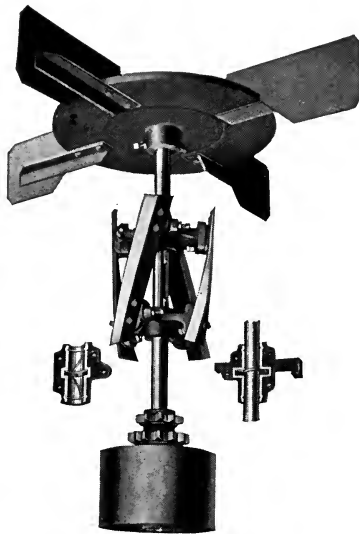

The Direct Drive has been a wonderful factor of "Ohio" supremacy. The drive pulley, cutting cylinder and blower fan are all on the main shaft. Gives "safety" speed, 650—700 R. P. M. without losing an ounce of power.

SIZES, CAPACITIES, POWERS, WEIGHTS, AND CODE.

All capacities based on $\frac{1}{2}$ -inch cut and on green corn silage. Curved elbow for top of pipe furnished with each Blower Machine.

- No. 12BPT**—Blower Cutter, complete with 30 feet pipe and Trucks; capacity 8 to 10 tons an hour; power 6 to 8-horse steam; weight, 2,265 lbs. **Omkey**
- No. 15BPT**—Blower Cutter, complete with 30 feet pipe and Trucks; capacity 12 to 15 tons an hour; power 8 to 10-horse steam; weight, 2,320 lbs. **Omhuh**
- No. 17BPT**—Blower Cutter, complete with 30 feet pipe and Trucks; capacity 15 to 20 tons an hour; power 10 to 12-horse steam; weight, 2,370 lbs. **Omites**
- No. 19BPT**—Blower Cutter, complete with 30 feet pipe and Trucks; capacity 20 to 25 tons an hour; power 12 to 14-horse steam; weight, 2,410 lbs. **Omiot**
- No. 22BPT**—Blower Cutter, complete with 30 feet pipe and Trucks; capacity 25 to 30 tons an hour; power 14 to 16-horse steam; weight, 2,500 lbs. **Omjan**
- 10-inch Galvanized pipe in 4, 5 and 6-foot lengths, for any of above sizes (weight, 4 $\frac{1}{2}$ lbs. to foot) **Olzac**
- Silo Tube, top section with flaring top; weight, 6 lbs. **Olzfu**
- Silo Tube, regular section, 3 feet long, complete; weight, 5 lbs. **Olzic**
- For cutting four inches long when two knives are used, a clutch gear, also combined sprocket and pinion are furnished at extra cost **Omfum**
- No. 815B**—Steel Truck, without neckyoke or doubletrees, suitable for mounting any of above machines; weight, 525 lbs. **Olzex**

See Description on Next Pages.

Silver's "Ohio" Silo Fillers

Points of Merit in a Nut Shell

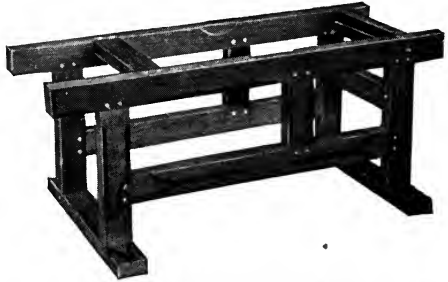

The solid foundation upon which "Ohio" superstructures are reared.

Strength and Durability — Solid hardwood frames, mortised, tenoned, double pinned, with iron rod and nut reinforcement. They cannot warp. All castings and steel on machine are very heavy. "Ohio" Cutters made twenty years ago are still in regular service.

"Ohio" Capacities—Have no equal on the market. They are all based on half-inch cut. The throat opening is very large and high. The fan surface is two to four times as great as on other machines. "Ohio" capacity ratings are based on work by the day or season—not by ten-minute tests.

Self-Feed—The "bull-dog grip" of upper and lower rollers has made "Ohio" capacity and easy feeding qualities famous. A stationary comb prevents the material from winding around the lower roller. The traveling table was first adopted by the "Ohio" and has since been copied by all others. Its entire surface is

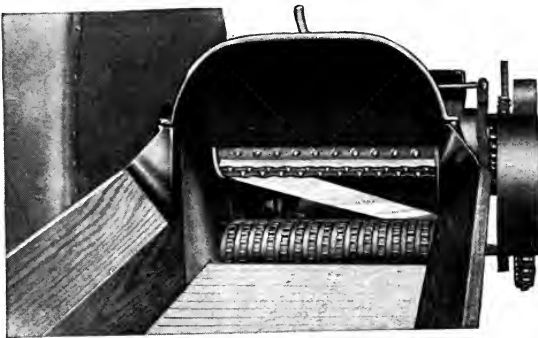

The sure, positive "bull-dog grip" of "Ohio" Feed Rollers is famous. The Single lever gives absolute control of rolls and table, stopping, starting or reversing the feed at a touch.

movable, avoiding all friction due to **dragging** the fodder by means of hooks, etc.

Direct Drive—With drive pulley, knife cylinder and blower fan all on one shaft. One compact set of gears does the work. The direct drive avoids trouble and big repair bills. The powerful lift of fan is done at low speed—no danger of blow-ups or explosions—no make-shift transmission mechanism.

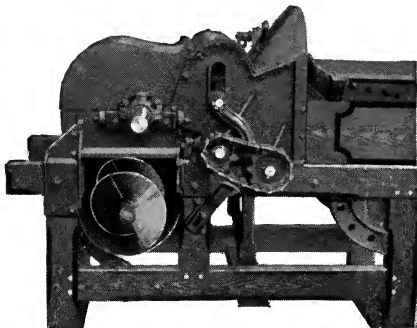

Auger side of machine with fan case removed. The auger prevents feed from entering blower in bulky, irregular quantities.

Cutting Cylinder—The solid wall of corn steadily forced against the cutting knives cannot spring them away from Cutter Bar on the "Ohio," because of bearings at **each end** of knives. This is impossible on the fly wheel type where springing results in uneven cutting, with long pieces of leaves to form air pockets in the silo. Investigate the new bearings and ring oiling-device, exact adjustments, etc.

Simplicity and Protection—Only six gears and six sprockets on the entire machine—the gears are perfectly housed—iron or steel guards cover all moving machinery—there is a uniform movement of feed table and rolls on any length of cut.

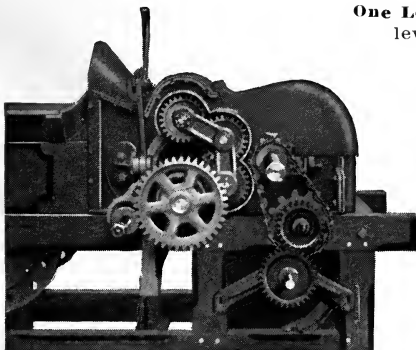

The friction gear wheel and outside guards are removed to show compact simplicity of "Ohio" gearing. In changing from full speed ahead to reverse not a gear tooth changes mesh. The peer of all reverses on the market.

One Lever Controls All—A single lever, almost human, controls the entire feeding mechanism—stopping, starting or reversing at will. It is easily accessible. A six-year-old boy can operate it.

Reverses by Friction—No strain—no breakages—it took three years to perfect, but it is worth it. Our new special wood friction clutch device instantly reverses without the slightest strain—not a gear tooth changes mesh. Friction is composed of small beveled wood segments easily replaced by the user.

Simplicity of Fan Case Side—The auger carries feed evenly to blower instead of in bulky irregular quantities. The main shaft bearings are conveniently adjusted. All drive chain on the machine is No. 72½, and is interchangeable.

Safety—The "Ohio" never explodes—it has an enormous powerful blast at low speed—650 to 700 R. P. M.

Guards for Protection of Operator cover all Moving parts.

Other Features—Blows to highest silos. Cuts all crops. Is very easy running. Makes highest quality of silage. Is ready to move anywhere by taking down pipe. Suitable for pit silos by simply removing the blower. Made in five popular sizes. Quality class of users everywhere. Converted into first class Shredder by replacing knives with "Ohio" shredder blades.



New "Ohio" Elbow—This large circle curved elbow is furnished free with each "Ohio" Monarch Blower Machine. It is seven feet long, of steel, and open on under side to prevent back pressure.

The Silo Tube delivers the leaves, moisture and heavier parts at any desired point in silo, uniformly mixed as cut and with a strong, self-packing force. The tube is of heavy galvanized steel. The three-foot sections telescope together, and have chain connections, readily detachable.

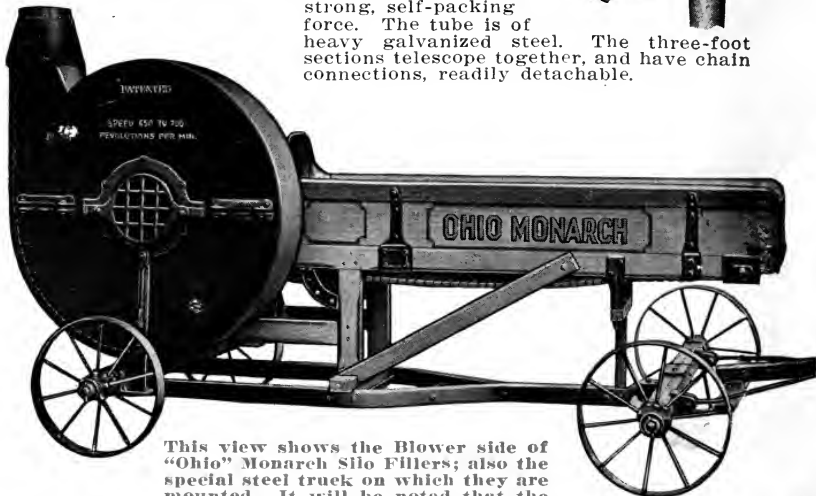

This view shows the Blower side of "Ohio" Monarch Silo Fillers; also the special steel truck on which they are mounted. It will be noted that the opening in fan case now has a sliding guard.

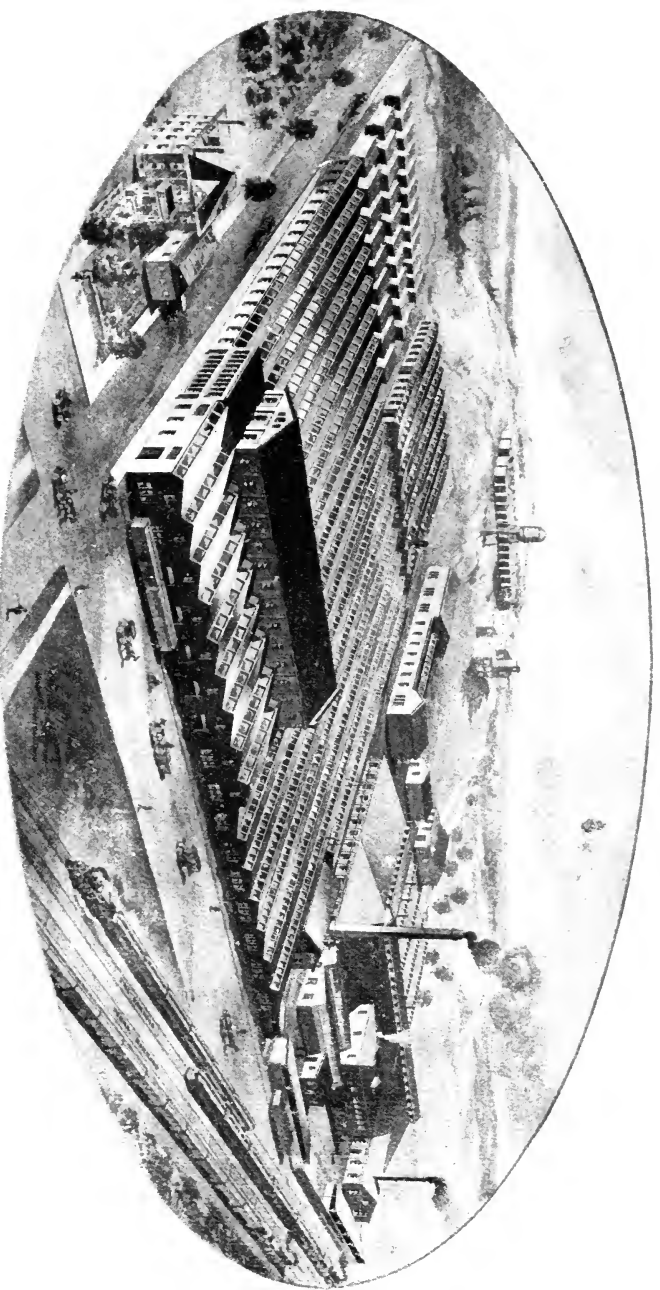

View of Head Office and Works of The Silver Manufacturing Co.

Located in Salem, Ohio, U. S. A., showing switch connections with the Pennsylvania and Erie Railroads. This is the home of Silver's "Ohio" Silo Fillers and Feed Cutters. The plant is new and modern in every particular, having been thoroughly remodeled and greatly enlarged during the past year. The machine shop and erecting room alone have a ground floor space of approximately one and one-half acres.

UNIVERSITY OF CALIFORNIA
BRANCH OF THE COLLEGE OF AGRICULTURE

THIS BOOK IS DUE ON THE LAST DATE
STAMPED BELOW

FEB 14 1937

JAN 18 '51

ret JAN 22 51 FT

NO 6 ^ '54

AUG 28 1967

SEP 8 REC'D

5m-8,'26

Pressboard
Pamphlet
Binder
Gaylord Bros.
Makers
Stockton, Calif.
PAT. JAN. 21, 1908

311034

SB195

S53

1914

Silver manufacturing co.,

Salem, O.

Modern silage methods.

JAN 18 '51

NO 6 "54

SB195

S53

1914

311034

LIBRARY, BRANCH OF THE COLLEGE OF AGRICULTURE

